

Professional Audio

T I L L 8P/10P/12P/15P
T I L L 15P/18P-SUB





| USER MANUAL

CONTENTS











USING THE UNIT SAFELY	3
PRODUCTS AND ACCESSORIES	6
DESCRIPTION OF JUNCTION BOX	7
TECHNICAL SPECIFICATIONS.....	8
INSTALLATION.....	9
SUPPORT AND TROUBLESHOOTING.....	10

USING THE UNIT SAFELY

















INSTRUCTIONS FOR THE PREVENTION OF FIRE, ELECTRIC SHOCK, OR INJURY TO PERSONS

About WARNING and CAUTION Notices		About the Symbols	
 WARNING	Used for instructions intended to alert the user to the risk of death or severe injury should the unit be used improperly.		This symbol alerts the user to important instructions or warnings.
 CAUTION	Used for instructions intended to alert the user to the risk of injury or material damage should the unit be used improperly.		This symbol alerts the user to items that must never be carried out (are forbidden).

ALWAYS OBSERVE THE FOLLOWING

WARNING		WARNING	
	Before using this unit, make sure to read the instructions below, and the Owner's Manual.		Use only the attached power-supply cord. Also, the supplied power cord must not be used with any other device.
	Do not open (or modify in any way) the unit or its AC adaptor.		Do not excessively twist or bend the power cord, nor place heavy objects on it. Doing so can damage the cord, producing severed elements and short circuits. Damaged cords are fire and shock hazards.
	Do not attempt to repair the unit, or replace parts within it(except when this manual provides specific instructions directing you to do so). Refer all servicing to your retailer or the nearest authorized Service Center.		This unit, either alone or in combination with an amplifier and headphones or speakers, may be capable of producing sound levels that could cause permanent hearing loss. Do not operate for a long period of time at a high volume level, or at a level that is uncomfortable. If you experience any hearing loss or ringing in the ears, you should immediately stop using the unit, and consult an audiologist.
	Never use or store the unit in places that are: <ul style="list-style-type: none"> ●Subject to temperature extremes(e.g., direct sunlight in an enclosed vehicle, near a heating duct, on top of heat-generating equipment); or are ●Damp and humid(e.g., baths, washrooms, on wet floors); or are ●Exposed to rain; or are ●Dusty; or are ●Subject to high levels of vibration. 		Do not allow any objects (e.g., flammable material, coins, pins); or liquids of any kind (water, soft drinks, etc.) to penetrate the unit.
	Make sure you always have the unit placed so it is level and sure to remain stable. Never place it on stands that could wobble, or on inclined surfaces.		Immediately turn the power off, remove the AC adaptor from the outlet, and request servicing by your retailer or the nearest authorized Service Center when:
	Be sure to use only the AC adaptor supplied with the unit. Also, make sure the line voltage at the installation matches the input voltage specified on the AC adaptor's body.		<ul style="list-style-type: none"> The AC adaptor, the power-supply cord, or the plug has been damaged; or If smoke or unusual odor occurs Objects have fallen into, or liquid has been spilled onto the unit; or The unit has been exposed to rain (or otherwise has become wet); or The unit does not appear to operate normally or exhibits a marked change in performance.

USING THE UNIT SAFELY

WARNING		CAUTION	
	Protect the unit from strong impact. (Do not drop it!)		Try to prevent cords and cables from becoming entangled. Also, all cords and cables should be placed so they are out of the reach of children.
	Do not force the unit's power-supply cord to share an outlet with an unreasonable number of other devices. Be especially careful when using extension cords-the total power used by all devices you have connected to the extension cord's outlet must never exceed the power rating (watts/amperes) for the extension cord. Excessive loads can cause the insulation on the cord to heat up and eventually melt through.		Never climb on top of, nor place heavy objects on the unit.
	Before using the unit in a foreign country, consult with your retailer or the nearest authorized Service Center.		Never handle the AC adaptor or its plugs with wet hands when plugging into, or unplugging from, an outlet or this unit.
	Batteries must never be recharged, heated, taken apart, or thrown into fire or water.		Before moving the unit, disconnect the AC adaptor and all cords coming from external devices.
	Only switching off the unit and unplugging from an outlet, the unit is powered off completely.		Before cleaning the unit, turn off the power and unplug the AC adaptor from the outlet.
	The unit and the AC adaptor should be located so their location or position does not interfere with their proper ventilation.		Whenever you suspect the possibility of lightning in your area, disconnect the AC adaptor from the outlet.
	Always grasp only the plug on the AC adaptor cord when plugging into, or unplugging from, an outlet or this unit.		<p>If used improperly, batteries may explode or leak and cause damage or injury. In the interest of safety, please read and observe the following precautions.</p> <ul style="list-style-type: none"> ● Carefully follow the installation instructions for batteries, and make sure you observe the correct polarity. ● Avoid using new batteries together with used ones. ● If a battery has leaked, use a soft piece of cloth or paper towel to wipe all remnants of the discharge from the battery compartment. Then install new batteries. To avoid inflammation of the skin, make sure that none of the battery discharge gets onto your hands or skin. Exercise the utmost caution so that none of the discharge gets near your eyes. Immediately rinse the affected area with running water if any of the discharge has entered the eyes. ● Never keep batteries together with metallic objects such as ballpoint pens, necklaces, hairpins, etc. ● Dispose of the waste battery according to national or local regulations regarding hazardous waste.
	At regular intervals, you should unplug the AC adaptor and clean it by using a dry cloth to wipe all dust and other accumulations away from its prongs. Also, disconnect the power plug from the power outlet whenever the unit is to remain unused for an extended period of time. Any accumulation of dust between the power plug and the power outlet can result in poor insulation and lead to fire.		Should you remove screws, keep them in a safe place out of children's reach, so there is no chance of them being swallowed accidentally.
			Shock hazardous voltages and currents are present inside the enclosure. Do not remove and replace the speaker grill and speaker by any means.

USING THE UNIT SAFELY

IMPORTANT NOTES

Power Supply: Use of Batteries

- Do not connect this unit to same electrical outlet that is being used by an electrical appliance that is controlled by an inverter (such as a refrigerator, washing machine, microwave oven, or air conditioner), or that contains a motor. Depending on the way in which the electrical appliance is used, power supply noise may cause this unit to malfunction or may produce audible noise. If it is not practical to use a separate electrical outlet, connect a power supply noise filter between this unit and the electrical outlet.
- The AC adaptor will begin to generate heat after long hours of consecutive use. This is normal, and is not a cause for concern.
- When installing or replacing batteries, always turn off the power on this unit and disconnect any other devices you may have connected. This way, you can prevent malfunction and /or damage to speakers or other devices.
- Use only suitable rechargeable batteries of the same size and type. Make sure the polarity is correct. Or it may cause this unit to malfunction.
- Please charge the battery as soon as you can when in low energy. The battery's storage capacity goes down if not using it for a long time.

Note: Please charge the battery once a month regularly if not using it for long period.

Placement

- Using the unit near power amplifier (or other equipment containing large power transformers) may induce hum. To alleviate the problem, change the orientation of this unit; or move it farther away from the source of interference.
- This device may interfere with radio and television reception. Do not use this device in the vicinity of such receivers.
- Noise may be produced if wireless communications devices, such as cell phones, are operated in the vicinity of this unit. Such noise could occur when receiving or initiating a call, or while conversing. Should you experience such problems, you should relocate such wireless devices so they are at a greater distance from this unit, or switch them off.
- Do not expose the unit to direct sunlight, place it near devices that radiate heat, leave it inside an enclosed vehicle, or otherwise subject it to temperature extremes. Also, do not allow lighting devices that normally are used while their light source is very close to the unit (such as a piano light), or powerful spotlights to shine upon the same area of the unit for extended periods of time. Excessive heat can deform or discolor the unit.

IMPORTANT NOTES

- When moved from one location to another where the temperature and /or humidity is very different, water droplets (condensation) may form inside the unit, you must allow it to stand for several hours, until the condensation has completely evaporated.
- Do not allow rubber, vinyl, or similar materials to remain on the unit for long periods of time. Such objects can discolor or otherwise harmfully affect the finish.
- Do not paste stickers, decals, or the like to this instrument. Peeling such matter off the instrument may damage the exterior finish.

Maintenance

- For everyday cleaning wipe the unit with a soft, dry cloth or one that has been slightly dampened with water. To remove stubborn dirt, use a cloth impregnated with a mild, non-abrasive detergent. Afterwards, be sure to wipe the unit thoroughly with a soft, dry cloth.
- Never use benzine, thinners, alcohol or solvents of any kind, to avoid the possibility of discoloration and/or deformation.

Additional Precautions

- Use a reasonable amount of care when using the unit's buttons, sliders, or other controls; and when using its jacks and connectors. Rough handling can lead to malfunctions.
- When connecting/disconnecting all cables, grasp the connector itself-never pull on the cable. This way you will avoid causing shorts, or damage to the cable's internal elements.
- To avoid disturbing your neighbors, try to keep the unit's volume at reasonable levels (especially when it is late at night or near specific places like schools or hospitals).
- When you need to transport the unit, package it in the box (including padding) that it came in, if possible. Otherwise, you will need to use equivalent packaging materials.
- Some connection cables contain resistors. Do not use cables that incorporate resistors for connecting to this unit. The use of such cables can cause the sound level to be extremely low, or impossible to hear. For information on cable specifications, contact the manufacturer of the cable.

PRODUCTS AND ACCESSORIES

PRODUCTS AND ACCESSORIES

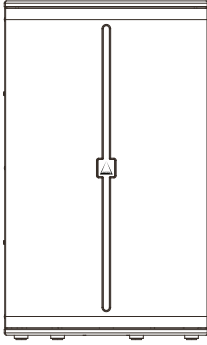

TILL 15P

Manual

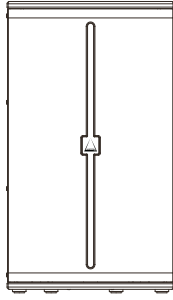

TILL 12P

Manual

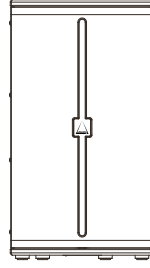

TILL 10P

Manual

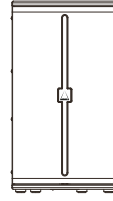

TILL 8P

Manual

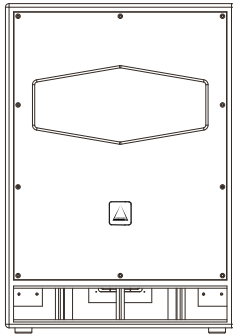

TILL 18P-SUB

Manual

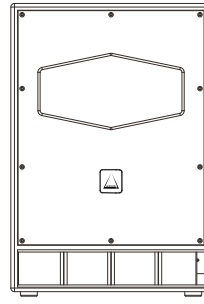

TILL 15P-SUB

Manual

TILL 15P/18P-SUB Optional accessories

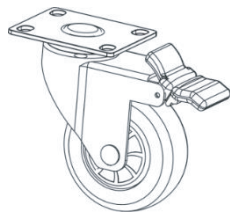

Wheel *4pcs

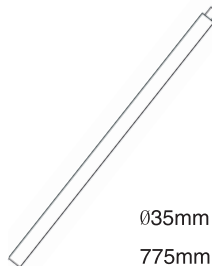

Ø35mm Pole
775mm Length

DESCRIPTION OF JUNCTION BOX

PANEL FUNCTIONS INSTRUCTIONS

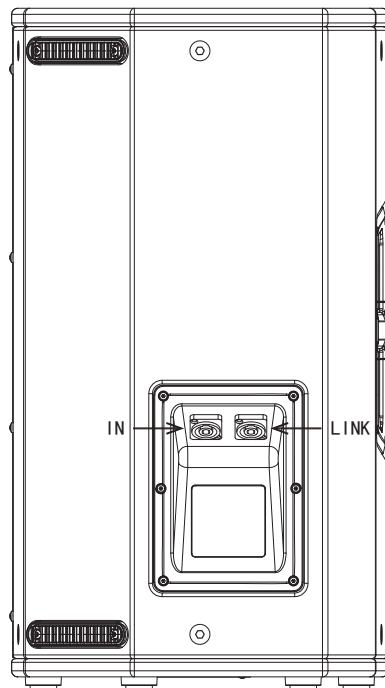
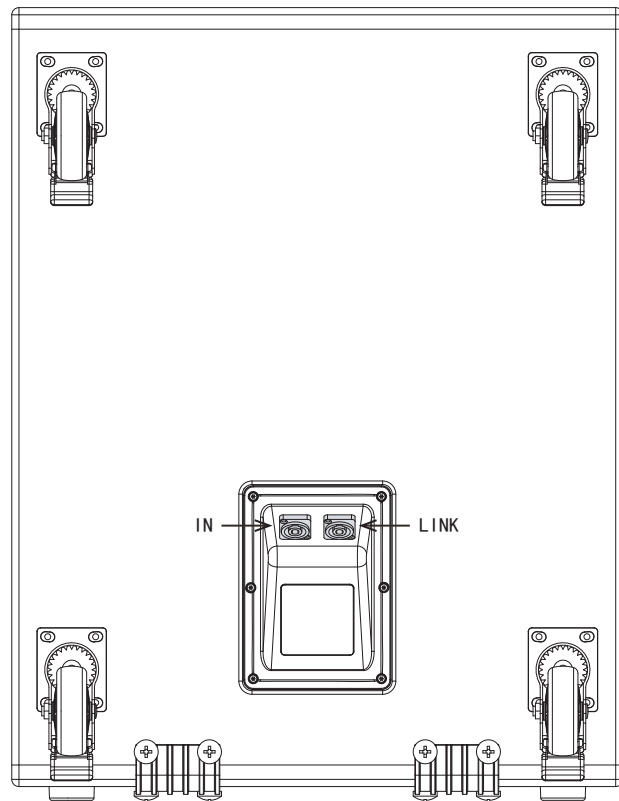

TECHNICAL SPECIFICATIONS

	TILL 8P	TILL 10P	TILL 12P	TILL 15P	TILL 15P-SUB	TILL 18P-SUB
Power handling	200W	250W	300W	300W	500W	600W
Impedance	8 ohm	8 ohm	8 ohm	8 ohm	8 ohm	8 ohm
Frequency Response	70-20KHz	60-20K Hz	50-20K Hz	45-20K Hz	38-120 Hz	35-120 Hz
sensitivity	93dB	94dB	95 dB	96 dB	96 dB	96 dB
Woofers	8" subwoofer *1	10" woofer *1	12" woofer *1	15" woofer *1	15" subwoofer *1	18" subwoofer *1
Driver	1" driver *1	1.35" driver *1	1.35" driver *1	1.35" driver *1	/	/
Coverage Pattern(H*V)	90°*60°	90°*60°	90°*60°	90°*60°	/	/
Crossover point	2 KHz	1.9 KHz	1.9 KHz	1.6KHz	/	/
Cabinet Material	12mm PLY 15mm PLY cabinet	15mm PLY cabinet	15mm PLY cabinet	15mm PLY cabinet	15mm PLY cabinet	18mm PLY cabinet
Color	black	black	black	black	black	black
Flypoints	M8	M8	M10	M10	/	/
Pole Socket	φ35mm	φ35mm	φ35mm	φ35mm	M20	M20
MEAS (H*W*D)	465*250*254mm	560*310*325mm	630*360*354 mm	730*440*439 mm	650*445*720 mm	730*510*820 mm
G.W.	8.3kg	13.5 kg	17 kg	32.7 kg	35 kg	44.8 kg

SUPPORT AND TROUBLESHOOTING

TROUBLESHOOTING

No sound from the loudspeaker	A. Make sure the power cord is fully and securely inserted. And ensure that the connected sound source and amplifier are in normal working condition.
Noise	A. Make sure the sound source is normal.
	B. Make sure the signal cable is connected normally.
Sound breaks up intermittently or sound distorts	A. Make sure the signal input is not over the range.
	B. Make sure the signal connecting wire is in good contact.
