







**Litedeer
Homes**

User Guider





Table of Contents

	Welcome & Congratulations	4
	IMPORTANT SAFETY INSTRUCTIONS	5-6
	Installation	7-10
	Grounding Instructions	11
	Operation	11-12
	Maintenance	12
	Warranty	13
	Technical Support	14
	Troubleshooting	14

Always Call a qualified technician or service agency to Install or repair

 **NOTE:** Procedures and techniques that are considered important enough to emphasize.

 **CAUTION:** Procedures and techniques which, if not carefully followed, will result in damage to the equipment.

 **WARNING:** Procedures and techniques which, if not carefully followed, will expose the user to the risk of fire, serious injury, or death.



**Litedeer
Homes**



Model: Latitude ZEF45
Latitude ZEF55
Latitude ZEF65
Latitude ZEF75

Product Dimensions:

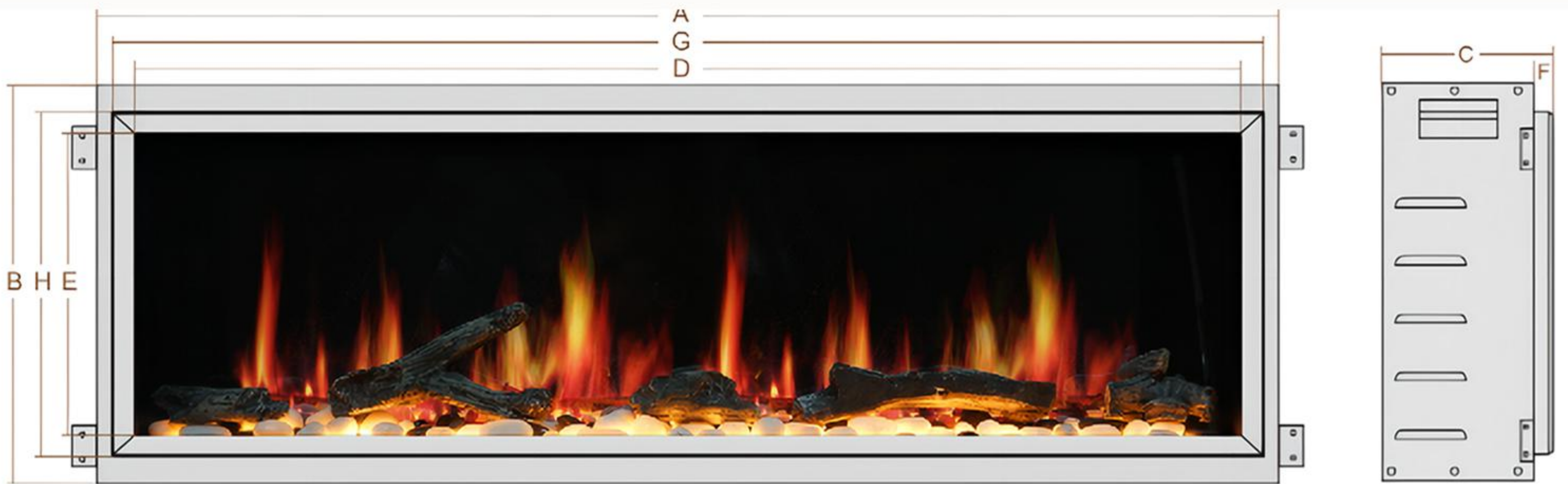

Latitude Series (Built-in)

Model#	A		B		C		D		E		F		G		H	
	mm	inch	mm	inch	mm	inch	mm	inch	mm	inch	mm	inch	mm	inch	mm	inch
ZEF45	1179	46 3/8"	425	16 3/4"	203	8"	1085	42 3/4"	300	11 3/4"	19	3/4"	1139	44 7/8"	353	13 7/8"
ZEF55	1429	56 5/16"	485	19"	203	8"	1335	52 1/2"	360	14 1/4"	19	3/4"	1389	54 5/8"	413	16 1/4"
ZEF65	1687	66 3/8"	425	16 3/4"	203	8"	1593	62 3/4"	300	11 3/4"	19	3/4"	1647	64 7/8"	353	13 7/8"
ZEF75	1941	76 3/8"	485	19"	203	8"	1847	72 3/4"	360	14 1/4"	19	3/4"	1901	74 7/8"	413	16 1/4"



IMPORTANT SAFETY INFORMATION: Always read this manual first before attempting to install . For your safety, always comply with all warnings and safety instructions contained in this manual to prevent personal injury or property damage.



Welcome & Congratulations

Thank you and congratulations for purchasing LiteDeer Homes electric Fireplace. Please use our convenient online registration page to record your model and serial numbers

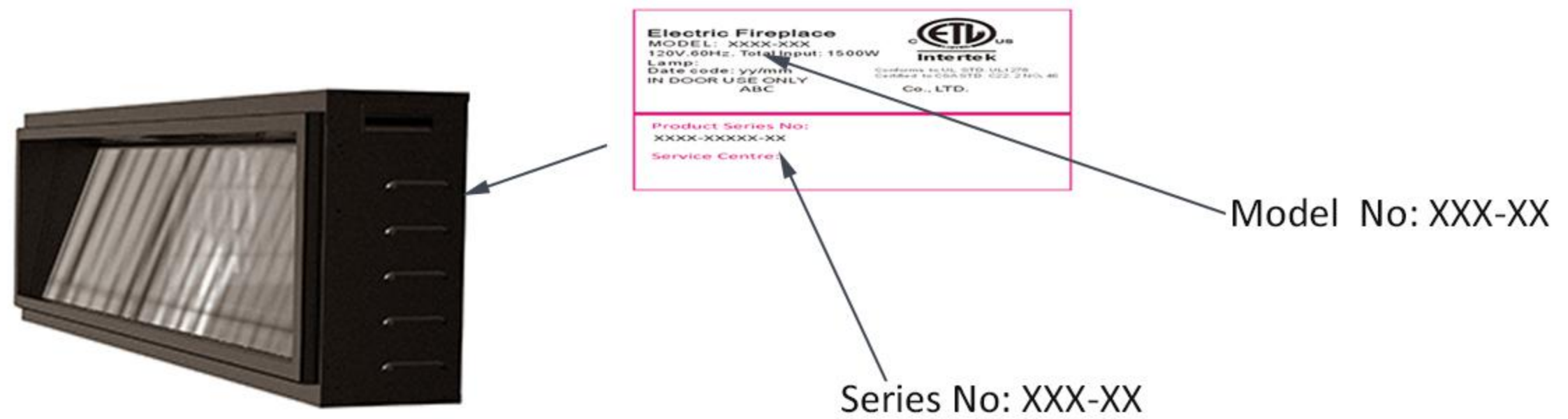

Please carefully read and save these instructions.



CAUTION: Read all instructions and warnings carefully before starting installation. Failure to follow these instructions may result in a possible electric shock, fire hazard and will void the warranty.

IMPORTANT SAFETY INSTRUCTIONS



When using electrical appliances, basic precautions should always be followed to reduce the risk of fire, electric shock, and injury to persons, including the following:

1. Read these instructions.
2. Keep these instructions.
3. Heed all warnings.
4. Follow all instructions.
5. Do not use this apparatus near water.
6. The appliance shall not be exposed to dripping or splashing and that no objects filled with liquid, such as vases, shall be placed on the apparatus.



WARNING: To reduce the risk of fire or electric shock,
Do NOT expose this apparatus to rain or moisture.

1. Clean only with dry cloth.
2. Do not block any ventilation openings. Install in accordance with the manufacturer's instructions.
3. Do not install near any heat sources such as radiators, heat registers, stoves, or other apparatus (including amplifiers) that produce heat.
4. No naked flame sources, such as candles should be placed on this apparatus.
5. Do not defeat the safety purpose of the polarized or grounding-type plug. A polarized plug has two blades with one wider than the other. A grounding type plug has two blades and a third grounding prong. The wide blade or the third prong are provided for your safety. If the provided plug does not fit into your outlet, consult an electrician for replacement of the obsolete outlet.



WARNING: This appliance is of Class I construction and must be connected to a power outlet with a protective grounded connection.

1. Protect the power cord from being walked on or pinched particularly at plugs, convenience receptacles, and the point where they exit from the apparatus.
2. Only use attachments/accessories specified by the manufacturer.
3. Use only with the cart, stand, tripod, bracket, or table specified by the manufacturer, or sold with the apparatus. When a cart is used, use caution when moving the cart/ apparatus combination to avoid injury from tip-over.
4. Disconnect power at the service panel during lightning storms or when unused for long periods of time.
5. Refer all servicing to qualified service personnel. Servicing is required when the apparatus has been damaged in any way, such as power-supply cord or plug is damaged, liquid has been spilled or objects have fallen into the apparatus, the apparatus has been exposed to rain or moisture, does not operate normally, or has been dropped.
6. If the appliance is damaged, check immediately with the supplier before installation and operation.

IMPORTANT SAFETY INSTRUCTIONS

7. Do not operate any unit with a damaged cord, or if the fireplace has been dropped or damaged in any manner, contact Technical Service
8. Do not modify the fireplace. Use it only as described in this manual. Any other use not recommended by the manufacturer may cause fire, electric shock or injury to persons.
9. When transporting or storing the unit and cord, keep in a dry place, free from excessive vibration and store so as to avoid damage.
10. Do not install the remote control battery backwards; charge; put in excessive heat such as fire, sunshine or the like; or mix with used or other battery types - may explode or leak causing injury.
11. When replacing the battery ensure that it is replaced with alkaline 1.5 Volt (AAA) batteries. Battery must be recycled or disposed of properly. Check with your Local Authority or Retailer for recycling advice in your area.

! NOTE: To disconnect from mains - set the mains switch to 'O'. The mains (power) switch is located at the top right hand side of the appliance above the manual controls - see 'O/I' Figure 1. Mains switch shall remain readily operable.

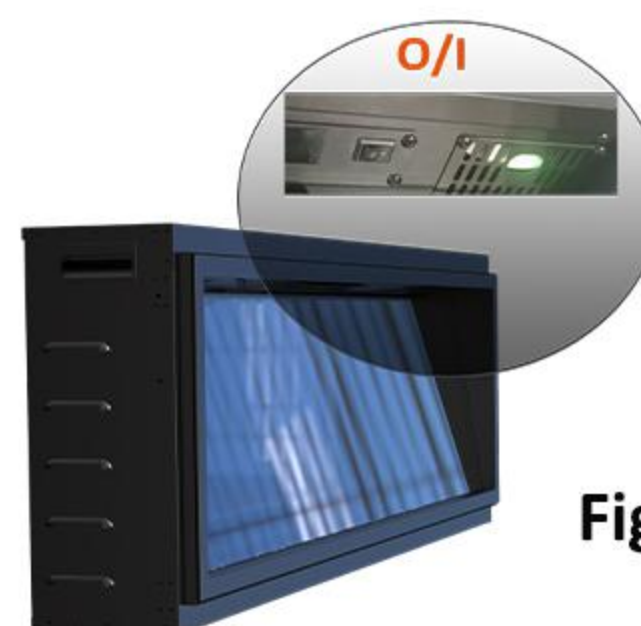

Figure 1



WARNING: Remote control contains small batteries. Keep away from children. If swallowed, seek medical attention immediately.



WARNING: To prevent injury, this apparatus must be securely attached to the floor, wall in accordance with the installation instructions.



NOTE: Changes or modifications not expressly approved by the party responsible for compliance could void user's authority to operate the equipment.



SA1965A

CAUTION
RISK OF ELECTRIC SHOCK
DO NOT OPEN
NO USER-SERVICEABLE PARTS INSIDE



ALWAYS SAVE THESE INSTRUCTIONS



Installation



WARNING: ANY INSTALLATION AND SERVICE WORK CAN ONLY BE PERFORMED BY QUALIFIED AND AUTHORIZED PERSONNEL. ALL INSTALLATIONS MUST COMPLY WITH ALL LOCAL CODES AND BY LAWS, AND INSPECTED AND APPROVED FOR OPERATION BY LOCAL GOVERNING AUTHORITY PRIOR TO USE.



WARNING: Construction and electrical outlet wiring must comply with local building codes and other applicable regulations to reduce the risk of fire, electric shock and injury to persons.

To position of the Latitude, Gloria & Marie Series use Visual-X Flame Technology, designed to achieve the best results when the ambient light level is low. If the Unit is installed in a bright area, strong reflections may weaken the flame. According to your specific application, it is very important to install the device at a height suitable for the audience to appreciate. It is recommended to use the following guidelines to locate the device.

! NOTE: Measurements are to the bottom of the viewing area of the flame.

For standing applications:

Minimum - 26" (66.0 cm) - Maximum - 51" (129.5 cm)

For sitting applications:

Minimum - 26" (66.0 cm) - Maximum - 36" (91.4 cm)

Plug-In Installation

You may run the power cord out of the framed wall opening to an existing outlet or install an outlet on a nearby wall stud within the wall. If the cord is not long enough to reach the outlet, a grounded extension cord minimum AWG No. 14 wiring and rated to a minimum of 1875 watts may be used.

Hardwire Installation

The Latitude, Gloria & Marie are supplied in an assembled state and is designed to be permanently installed. The unit comes ready for plug-in installation.



WARNING: Do not attempt to wire your own new outlets or circuits. To reduce the risk of fire, electric shock or injury to persons, always use a licensed electrician.



WARNING: Ensure that the On/Off switch is set to the Off position (refer to Operation section) and that the circuit on which the Unit is to be installed has the power cut off at the service panel until installation is complete.

! NOTE: Please read all instructions before installing.

Framing and installation

For rough in framing, the opening should follow the recommended dimensions located in Figure 1.

NOTE: Dimensions provided are minimum clearances and will vary depending on type of support framing and finishing options.

NOTE: Framing should be constructed to support:

ZEF45 (43KG/95Lbs) /ZEF55 (57KG/126Lbs) /ZEF65(63KG/139Lbs) /ZEF75 (71KG/157Lbs)



Installation

Framing Dimensions

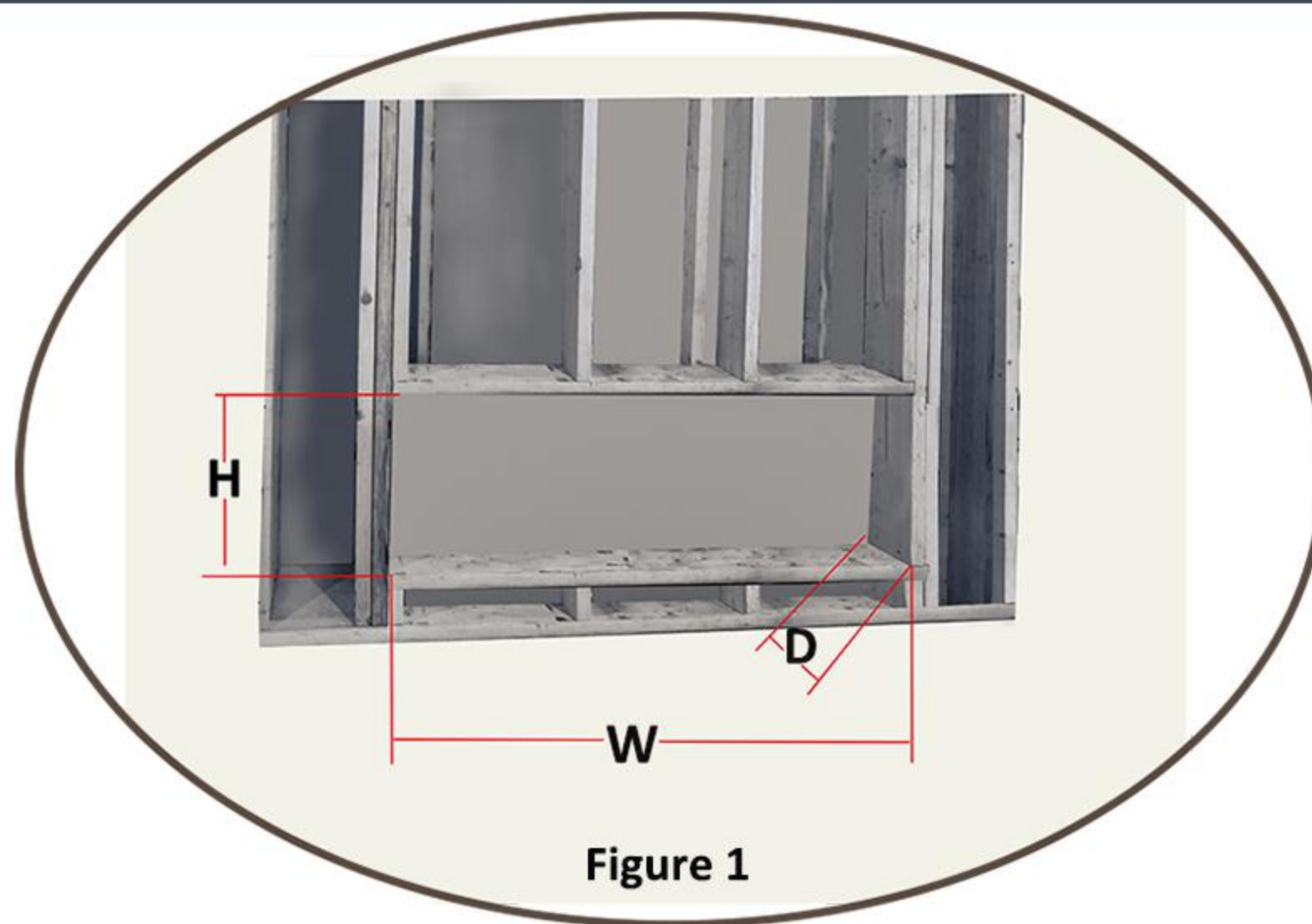

! Recommend Frame size

Model	W	H	D	Unit
ZEF45	47 ¹ / ₈ 1197	17 ¹ / ₂ 445	8 203	Inch mm
ZEF55	57 ¹ / ₈ 1451	19 ¹ / ₂ 495	8 203	Inch mm
ZEF65	67 ¹ / ₈ 1705	17 ¹ / ₂ 445	8 203	Inch mm
ZEF75	77 ¹ / ₈ 1959	19 ¹ / ₂ 495	8 203	Inch mm

Installation Steps:

1. Make sure that the main power switch is turned off, and then plug the power plug into the wall socket, place the fireplace into wall framing and use framing screws to secure the side brackets to wall (see Figure 2)

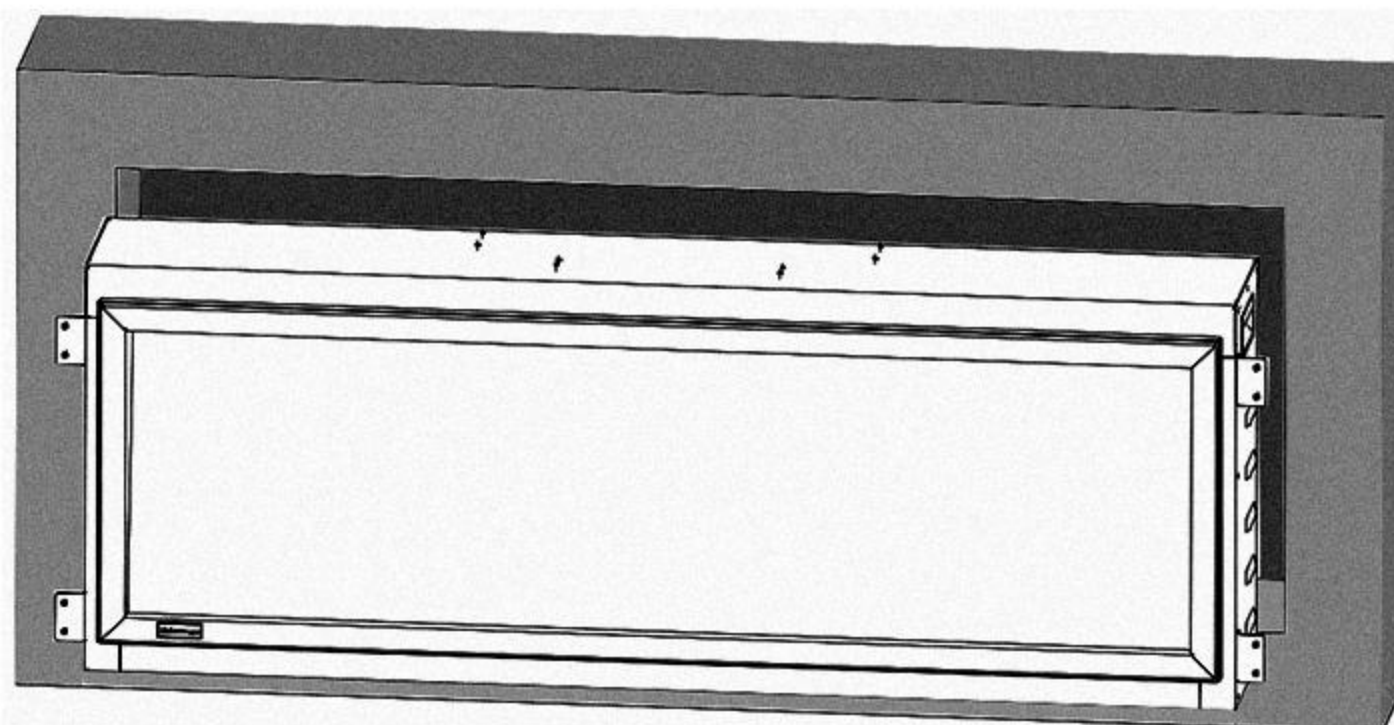

Figure 2



Installation

2. After placing the fireplace in the correct position, use the 8 screws provided with the fireplace to fix it to the wooden frame one by one to ensure that it is tightly locked.

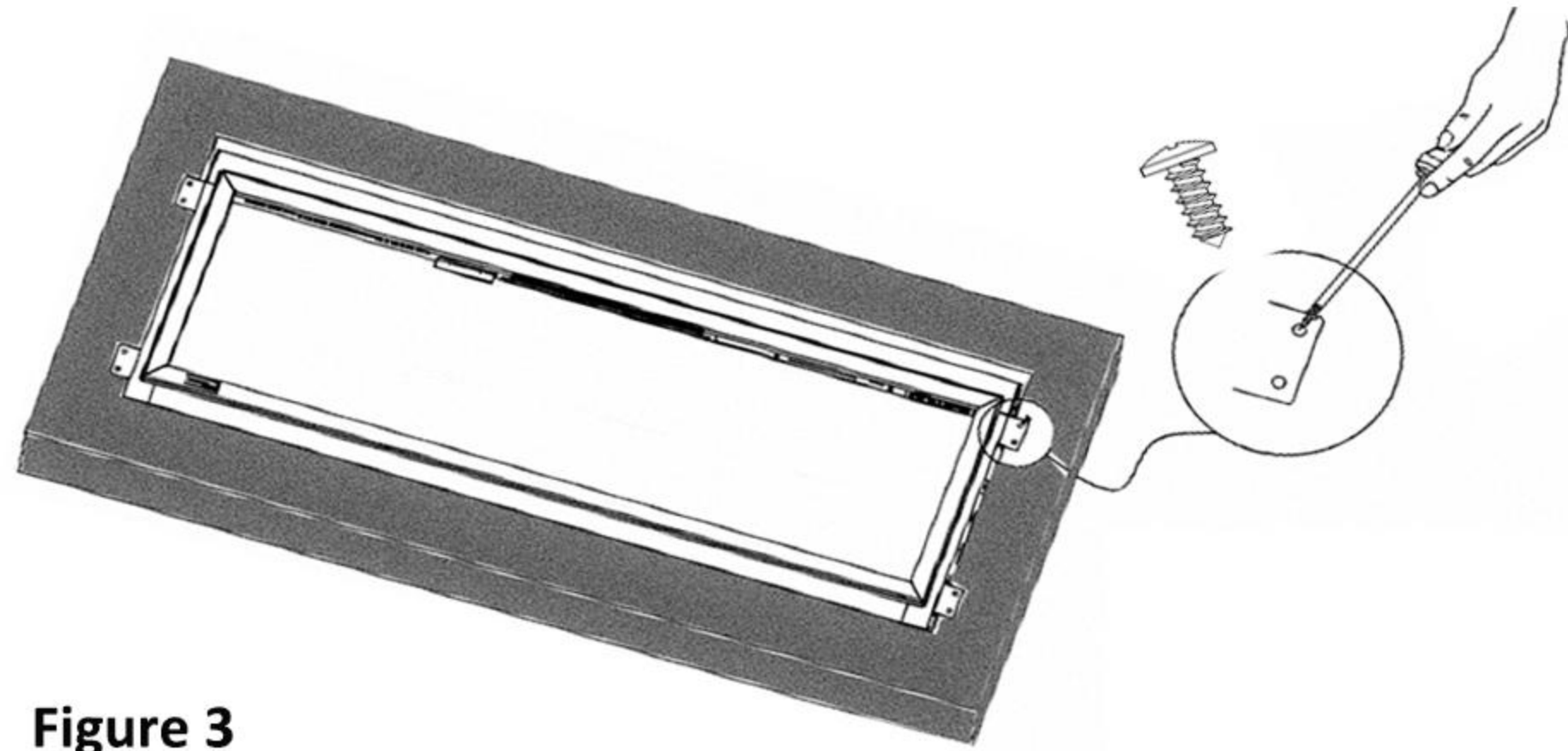

Figure 3

3. After finishing the above work, the next step is to loosen and remove the two screws that lock the outer frame, then take out the front trim piece. (see Figure 4)

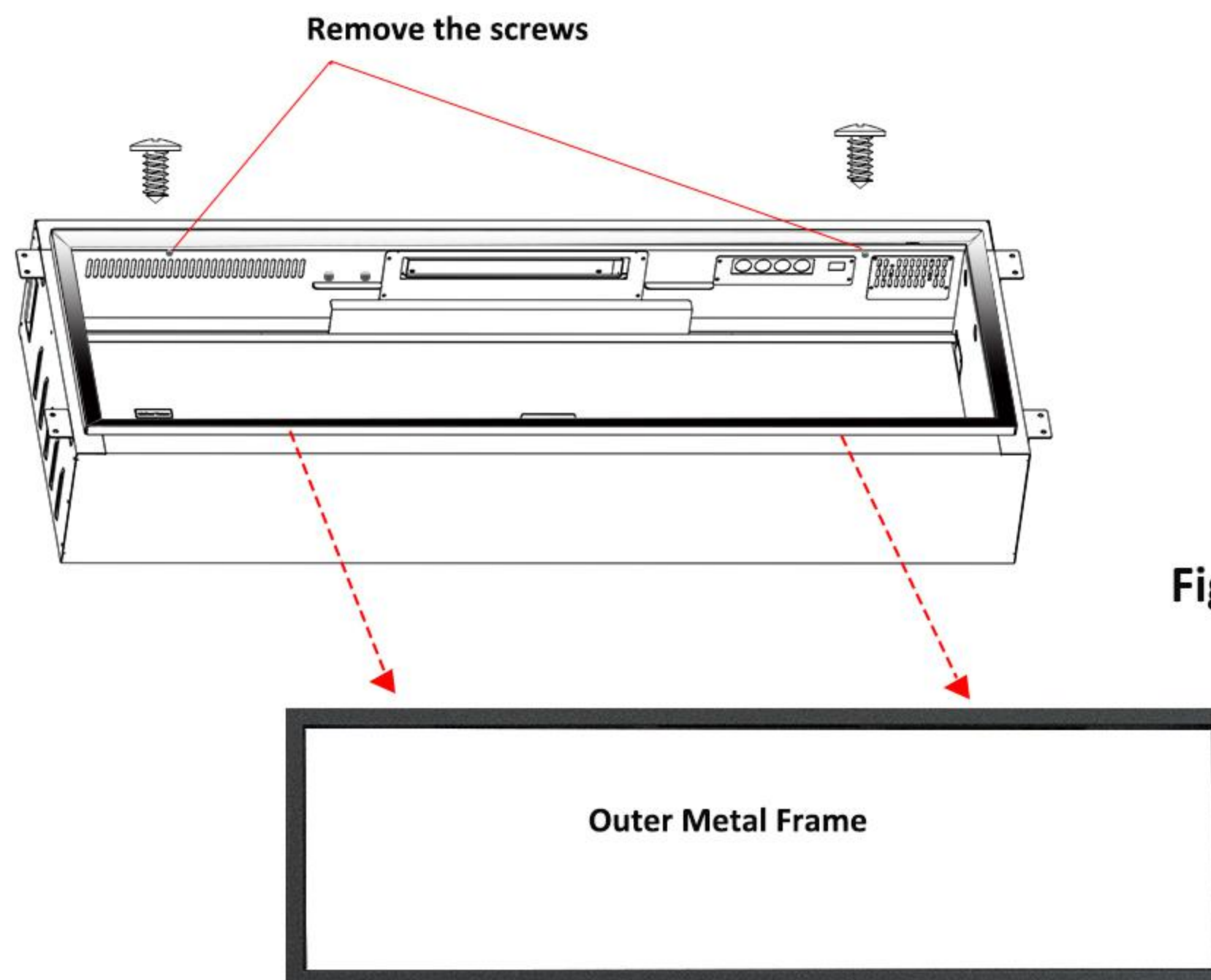

Figure 4

4. Loosen and remove hinge plate behind the top trim. Remove the two screws of the baffle bar on the inclined glass and remove the inclined glass. See figure 5.

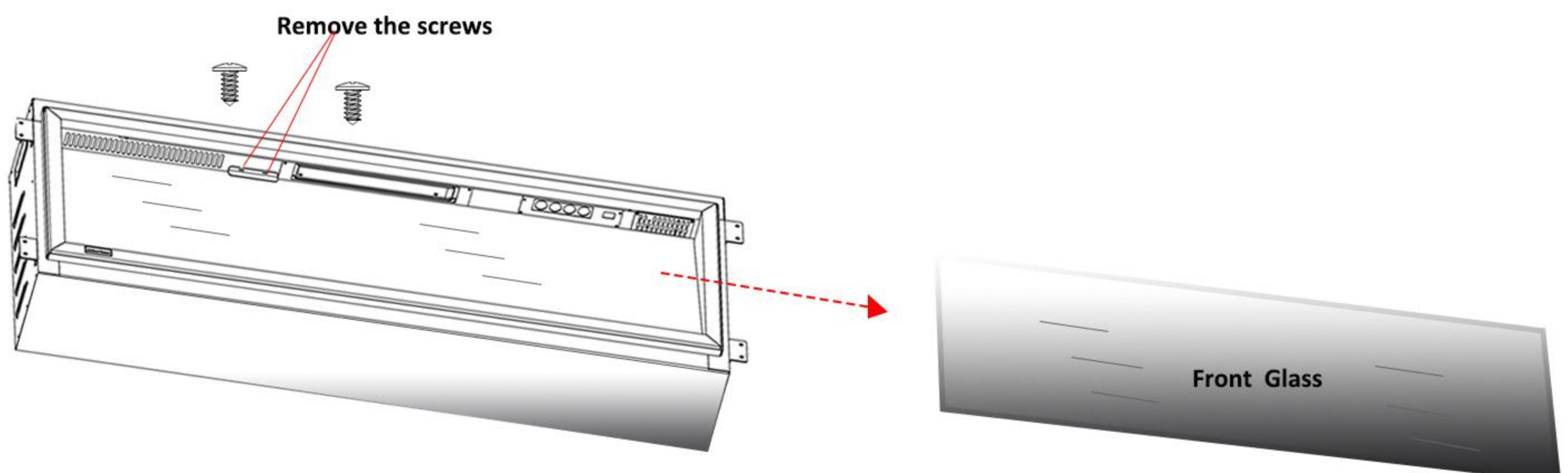

Figure 5



Installation

5. First, place natural pebbles on the bottom, and then put the driftwood log sets on the ember bed. (see Figure 6)



Figure 6



Nature pebbles



Driftwood log

6. When the ember bed decoration is complete. The first operation step is to put the glass back in place, Lock the hinge plate and fix the outer metal frame (see Figure 7). Reinstallation is just the opposite of the disassembly steps above.

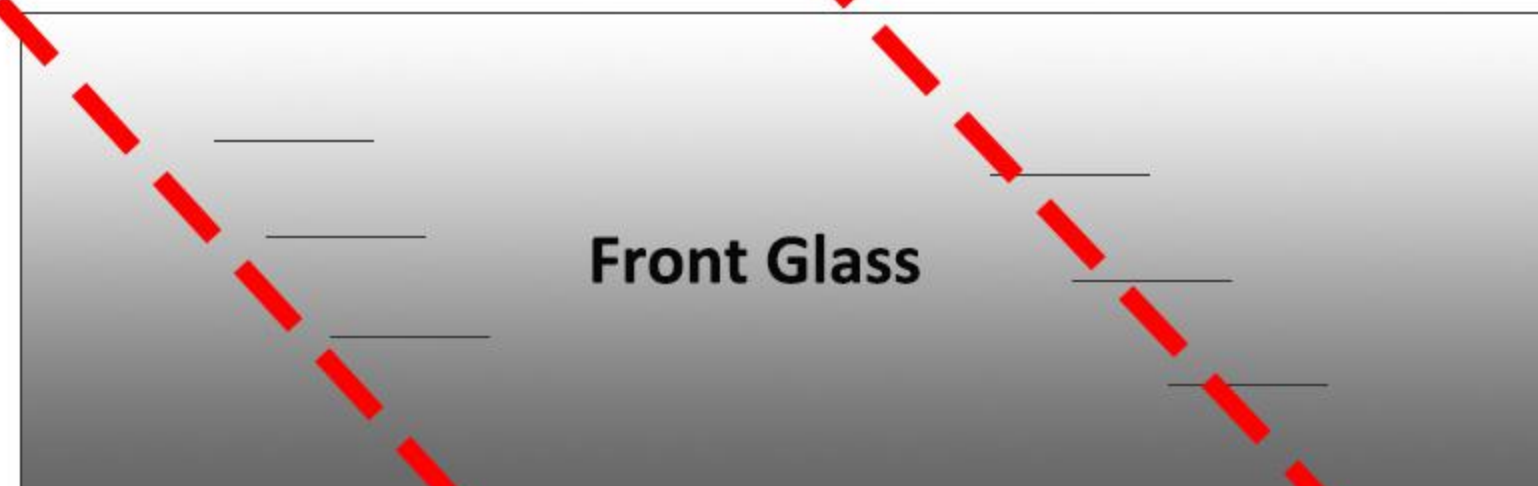
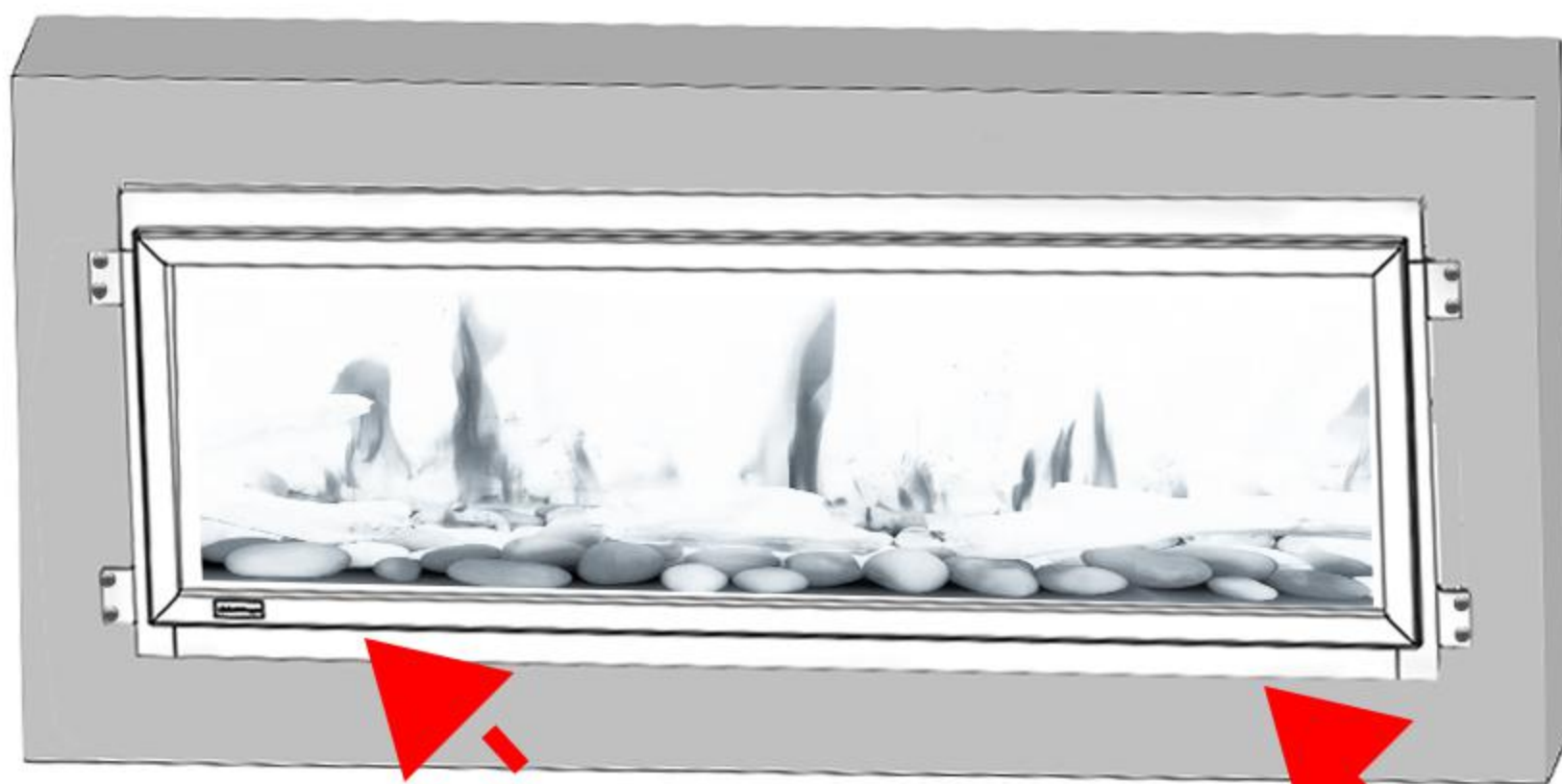

Front Glass

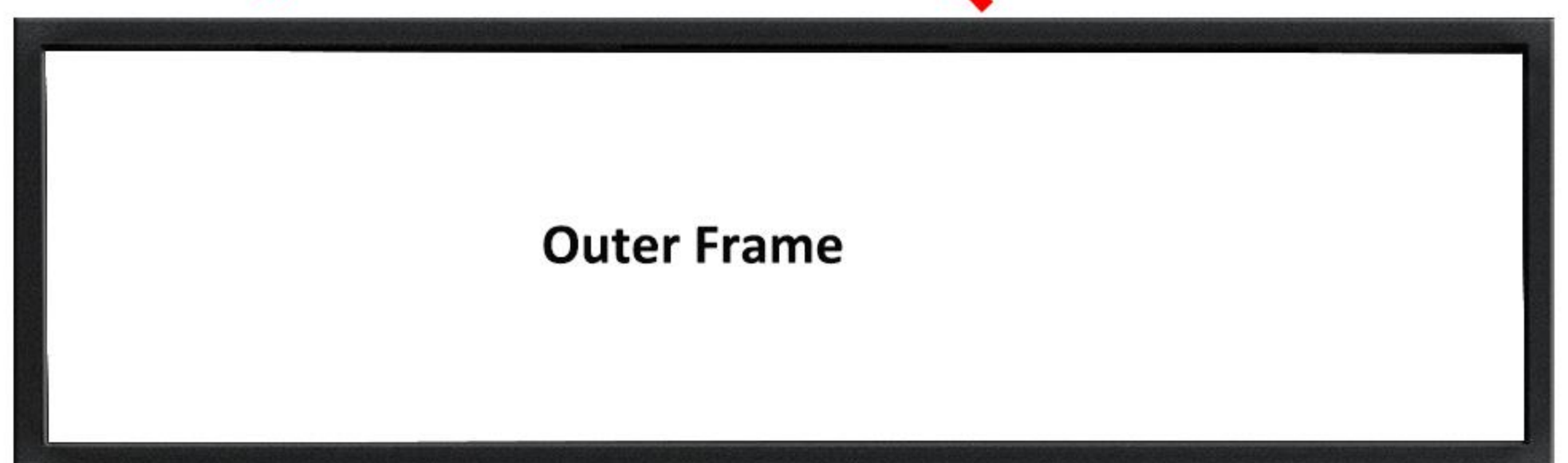

Outer Frame

Figure 7



Grounding instructions



This heater is suitable for 120 volts. The power cord has a plug, as shown in A, this is a highly recommended configuration.

If you want to use an adapter, as shown in Figure C, make sure that the adapter can be used to connect the three-prong grounding type plug into a two-slot socket. green ground lug extend from the adapter must be connected to a permanent ground, such as a properly grounded outlet box.

When properly installed, it provides a ground connection through the cord to the heater to protect the operator from electric shock.

Schematic diagram

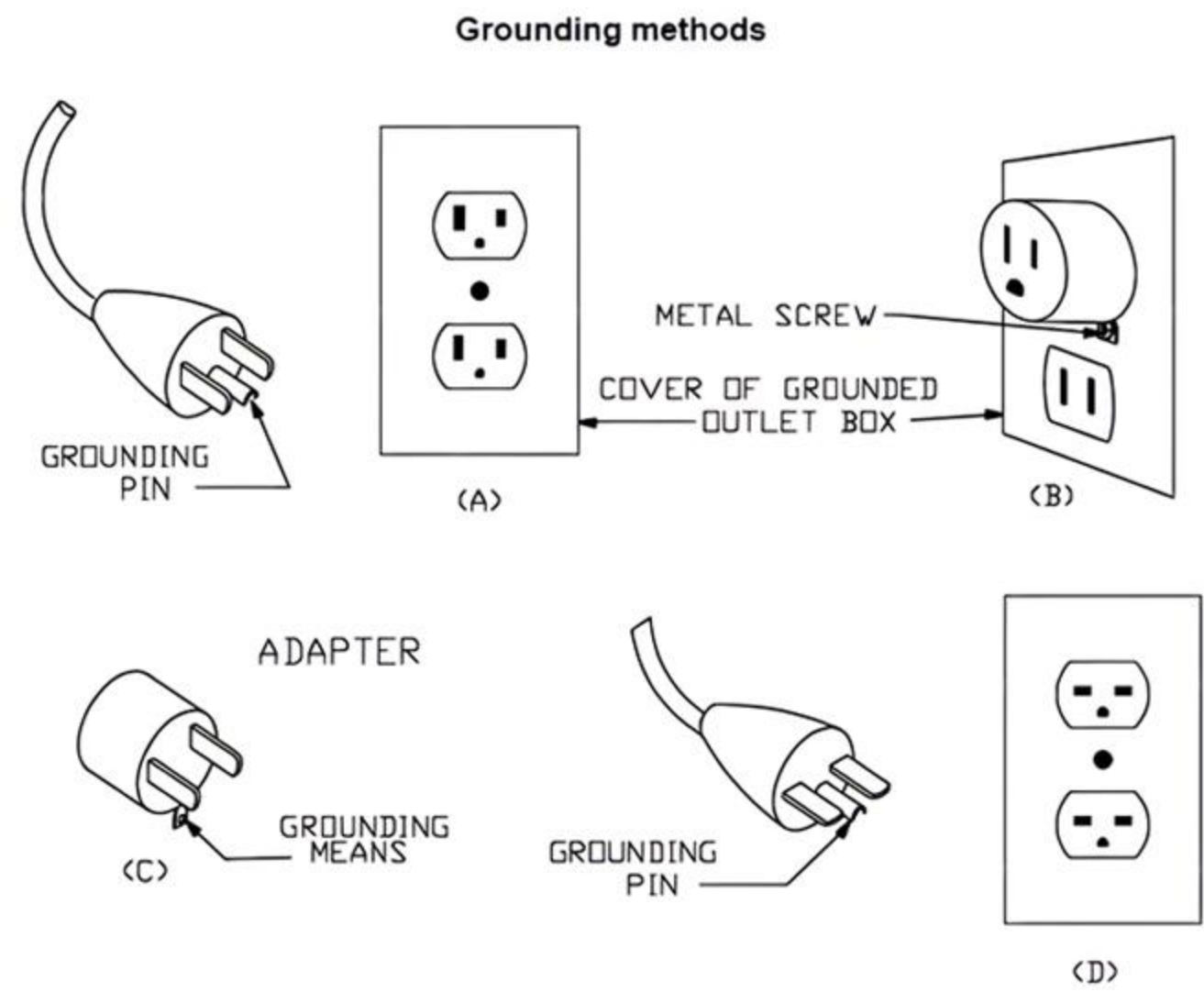

Operation

The appliance can be operated either by the switches located on the top right hand side of the fire or by supplied remote control.

TO ACCESS CONTROL PANEL

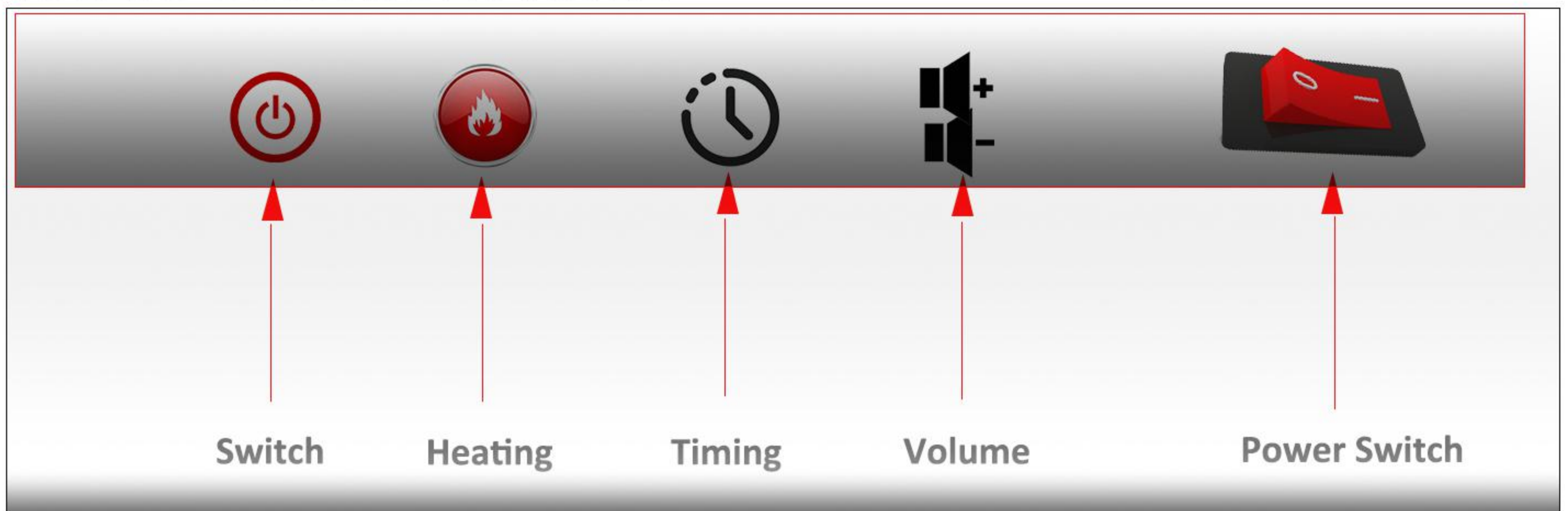

1. The POWER SWITCH must be first switch on. It takes some time for the receiver to respond to the transmitter. Do not PRESS the buttons more than once within two seconds for correct operation.
- 2 Press once the button ON/OFF on the remote control this turns ON/OFF the appliance and fire effect.
3. Press once the HEAT button for the LOW heat setting(750W); press twice for the HIGH heat setting (1500W); press again to TURN OFF the heater. Fan will be turn off in 10 seconds.
4. TIME setting. The timing function is superimposed for 1 hours each time until 2 hours, and for every hour above 2 hours (maximum 8 hours).
5. Volume adjustment from 0-100% in 5 levels.



Operation

Infrared Remote control



POWER

ON: Enables control panel functions and remote control. Turn on flame effect.
OFF: Disables control panel functions and remote control. Turn off flame effect

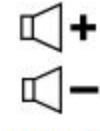

VOLUME

Volume button: Adjust the flame sound effect



TIMING

The timing function is superimposed for 0.5 hours each time until 2 hours, and for every hour above 2 hours (maximum 8 hours).



HEATING

HEATER button: Turn heater on and off.

NOTE: To prevent overheating, the heater fan will blow out cool air for 10 seconds after the heater turn off.

1. Press once. Indicator lights up. 750W heater turns on and blows warm air.
2. Press again. Indicator lights up. 1500W heaters turns on and blows hot air.
3. Press again. Heaters turn off.

The fan blows cool air for 10 seconds to allow heater to cool down, then turns off.



DIMMER

Flame size and shape switching.

REMOTE CONTROL

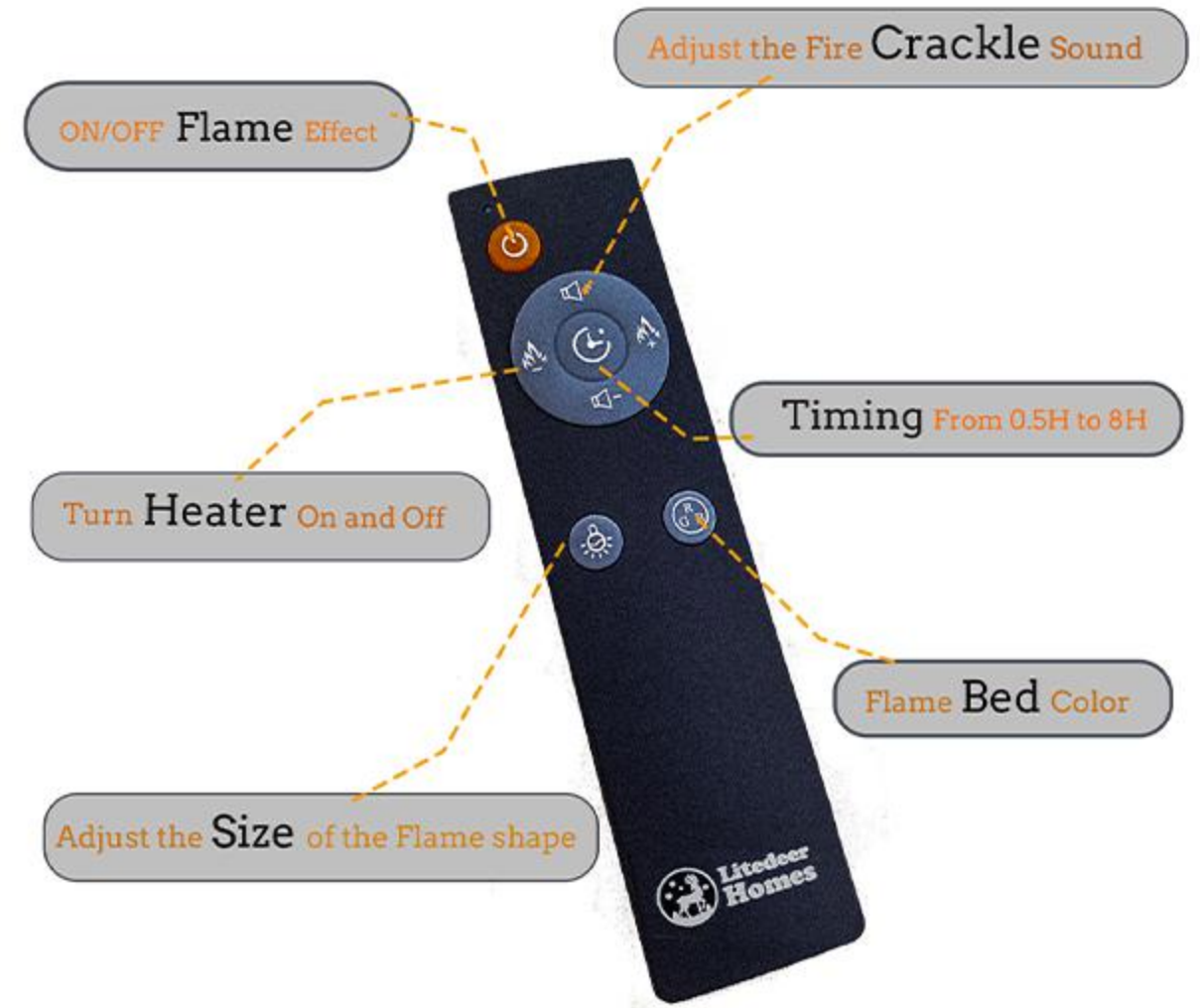

- DO NOT mix old and new batteries.
- DO NOT use rechargeable silver oxide cell batteries with remote control unit.
- DO NOT mix alkaline. Standard (Carbon-zinc). Or rechargeable (Nickle - Cadmium) batteries.
- DO NOT dispose of batteries in fire. Improper disposal may cause batteries to leak or explode.



Maintenance

LED Light Bulbs Replacement

When disassembling the equipment in any case, ensure that the power is cut off. Remove the ember bed cover plate below the inclined glass and replace the lamp strip.

Note: The flame effect on this electric fireplace insert is created by LED display screen.

The life of these LED displays will be 100,000 hours.

The users are not recommended to replace the LED displays. For any reason should the bulbs stop working properly, contact a qualified technician.

Cleaning:

Turn heater OFF and unplug from electrical outlet before any cleaning or maintenance is performed. Wait at least 10 minutes to allow all components to cool properly.

Use a vacuum or duster to keep heater and vent area clean from dust and dirt.

The exterior of the fireplace should be cleaned with a damp cloth or duster.

Do not use abrasive cleaners or liquid sprays.



WARNING: Disconnect power before attempting any maintenance or cleaning to reduce the risk of fire, electric shock or damage to persons.



Warranty

Two Year Limited Warranty

Products to which this limited warranty applies

This limited warranty applies to the following models of your newly purchased LiteDeer Homes Latitude /Glorie /Marie Series fireplace.

What this limited warranty covers and for how long

Products, other than surrounds (mantels) and trims, covered by this limited warranty have been tested and inspected prior to shipment and, subject to the provisions of this warranty, Litedeer Homes warrants such products to be free from defects in material and workmanship for a period of 2 years from the date of purchase of such products.

What this limited warranty does not cover

This limited warranty does not apply to products that have been repaired (except by Litedeer Homes or its authorized service representatives) or otherwise altered. This limited warranty does further not apply to defects resulting from misuse, abuse, accident, neglect, incorrect installation, improper maintenance or handling, or operation with an incorrect power source.

What you must do to get service under this limited warranty

Defects must be brought to the attention of Litedeer Homes Technical Service

Please have proof of purchase, catalogue/model and serial numbers available when calling. Limited warranty service requires a proof of purchase of the product.

What Litedeer Homes will do in the event of a defect

In the event a product or part covered by this limited warranty is proven to be defective in material or workmanship during (i) the 2 year limited warranty period for products other than surrounds (mantels) and trims, and (ii) the 1 year limited warranty period for surrounds (mantels) and trims, you have the following rights:

- (I) Litedeer Homes will in its sole discretion either repair or replace such defective product or part without charge. If Litedeer Homes is unable to repair or replace such product or part, or if repair or replacement is not commercially practicable or cannot be timely made, Litedeer Homes may, in lieu of repair or replacement, choose to refund the purchase price for such product or part.**
- (II) Limited warranty service will be performed solely by dealers or service agents of Litedeer Homes authorized to provide limited warranty services.**