

SAFETY PRECAUTIONS

1. The device must be installed by a qualified person,
2. Disconnect all power before working on the device. Don't touch any terminal when the power is ON.
3. Verify correct terminal connection when wiring.
4. Don't dismantle or repair the device whether it operates normally, otherwise no responsibility is assumed by producer and seller.
5. Never use the device at the site which can be invaded by corrode gas, strong sunshine light and rain.
6. Clean the device with a dry cloth.
7. Fail to follow these instructions will result in serious injury or death.

FEATURES

- Microcontroller based
- Digit display for operating voltage and current value
- Protect electrical device against over/under voltage, overcurrent, three phase asymmetry and incorrect phase sequence.
- Voltage measurement accuracy =1%
- Parameters setting by keys
- LEDs indication for over/under voltage and over current faults
- 5 Module, DIN Rail mounting

TECHNICAL DATA

Rated supply voltage	AC 220V
Operation voltage range	AC 50V~400V
Rated frequency	50/60Hz
Overvoltage(U>) setting range	220~300V
Undervoltage(U<) setting range	120~210V
Overcurrent setting range	5A~63A
Phase sequence setting	ON/OFF
Asymmetry setting range	20V~99V-OFF
Reset/start delay	Ts: 5s~600s
Overcurrent faults trip delay range	Ta: 5s~600s
Continuous overcurrent times setting	OFF-1~20
Auto reset setting	ON-OFF
Hysteresis	Overvoltage and asymmetry: 5V Undervoltage:3V
Overvoltage(U>) trip delay	0. 1s; ≤350V:0.02s
Undervoltage(U<) trip delay	≤120V:0.5s ,<120V:0.1s
Overcurrent(I>) trip delay	Iset<Ir<80A: Ta; Ir=80A: ≤0. 1s
Asymmetry trip delay	10s
Voltage measurement accuracy	≤1%(over the whole range)
Rated insulation voltage	450V
Output contact	1NO
Electrical life	10 ⁵
Mechanical life	10 ⁶
Protection degree	IP20
Pollution degree	3
Altitude	≤2000m
Operating temperature	-5°C~40°C
Humidity	≤50% at 40°C(without condensation)
Storage temperature	-25°C~55°C

* Operating current value

Technical parameter	Setting range	Step	Factory setting
Overvoltage trip value	220V~300V	1V	250V
Undervoltage trip value	120V~210V	1V	170V
Reset/start delay	5s~600s	1s	5s
Overcurrent trip value	5A~63A	1A	63A
Overcurrent trip delay	5s~600s	1s	15s
Asymmetry trip value	20V~99V-OFF	1V	50V
Continuous overcurrent faults times	OFF-1~20	1	3
Operation mode	□□□-□□□		□□□
Phase sequence protection	ON-OFF		OFF
Auto reset setting	ON-OFF		ON

□□□ : Synchronous mode; □□□ : Asynchronous mode

EVP-3PH

3 PHASE VOLTAGE AND CURRENT PROTECTOR

Please read complete instructions prior to installation and operation of the device.

FRONT-FACE PANEL

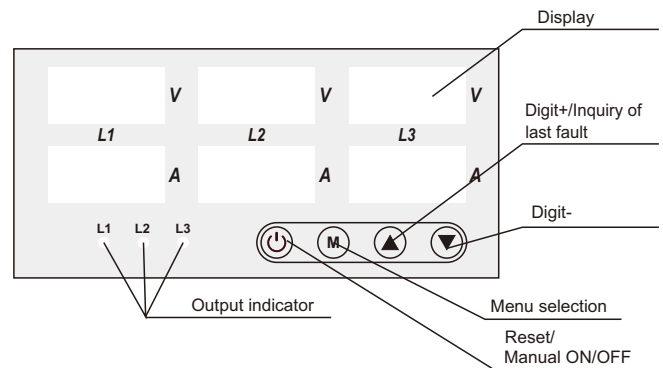

● Switch on/off manually

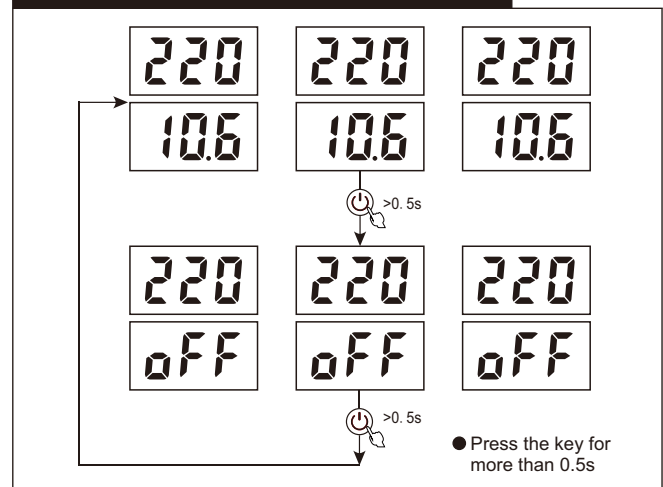

● Inquiry of faults

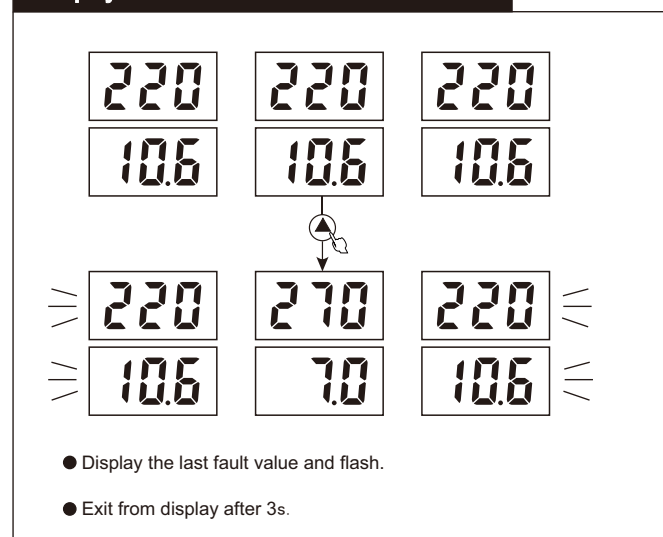

● Main menu setting

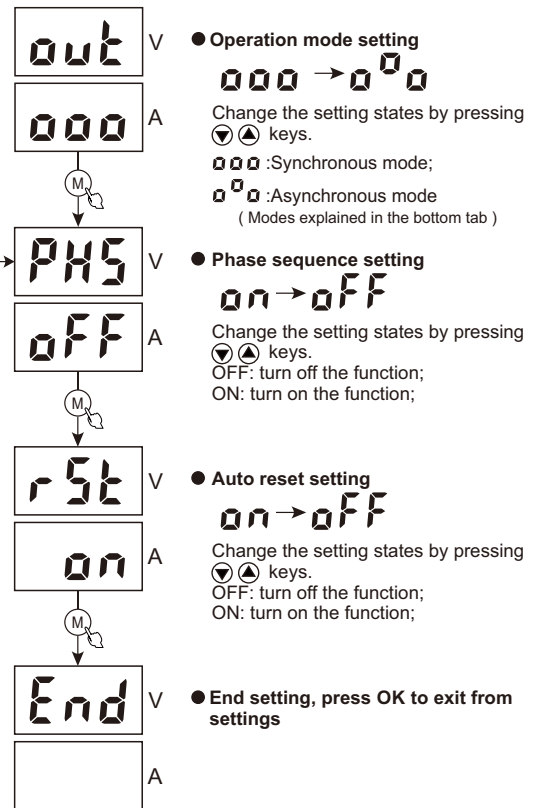
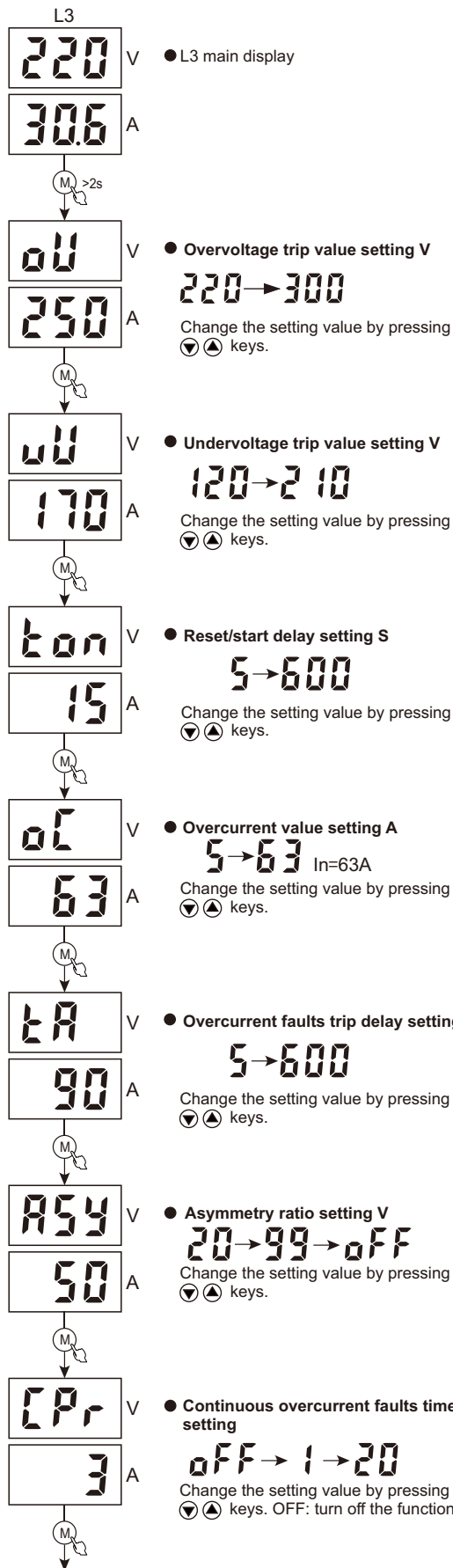

- Long press ▼ ▲ can increase or decrease rapidly.
- The relay will automatically exit from the menu and not save the modified value if not pressing the keys for continuous 60s during setting.
- Only L3 display when setting. L1 and L2 don't display.

Operating Modes

- 000 : Synchronous mode; In this mode the device works as a three phase voltage protector with N, L1, L2, L3 as single circuit
- 000 : Asynchronous mode : In this mode the device works as three Individual single phase protectors which can be connected to three separate circuits. Also the device can identify & stop/trip/ reset each of the three circuits independently
i.e "N - L1" & "N - L2" & "N - L3"

Synchronous Mode

Asynchronous Mode

● Reset/start delay display(synchronous)

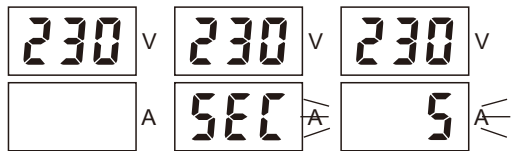

- Voltage operating values display on upper L1-L2-L3 and delay time flashes on the lower L3 during the counting of start delay; After the delay is over, the output relay closes.

● Reset/start delay display(asynchronous)

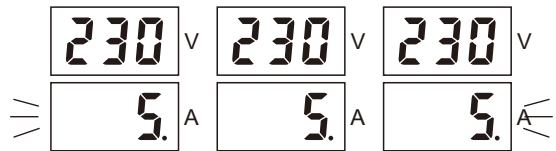

- Voltage operating values display on upper L1-L2-L3 and delay time flashes on the lower L1-L2- L3 during the counting of start delay; After the delay is over, the output relay closes.

● U> faults display(synchronous)

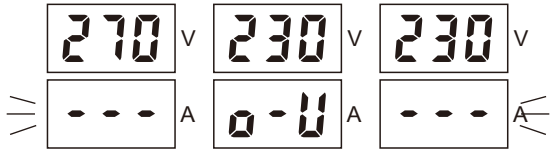

- Voltage operating values display on upper L1-L2-L3 and synchronous over voltage faults code display on the lower L1-L2- L3

● U> faults display(asynchronous)

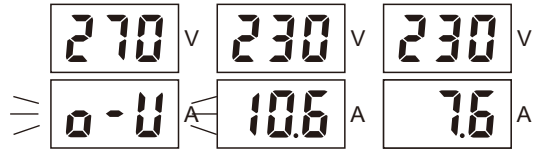

- Voltage operating values display on upper L1-L2-L3 and asynchronous over voltage faults code display on the lower L1-L2- L3

● U< faults display(synchronous)



- Voltage operating values display on upper L1-L2-L3 and synchronous under voltage faults code display on the lower L1-L2- L3

● U< faults display(asynchronous)

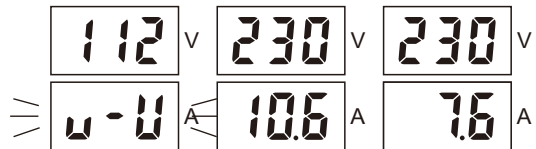

- Voltage operating values display on upper L1-L2-L3 and asynchronous under voltage faults code display on the lower L1-L2- L3

● I> faults display(synchronous)



- Voltage operating values display on upper L1-L2-L3 and synchronous over current faults code display on the lower L1-L2- L3

● I> faults display(asynchronous)

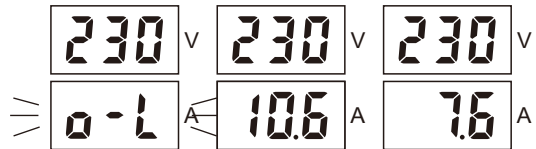

- Voltage operating values display on upper L1-L2-L3 and asynchronous over current faults code display on the lower L1-L2- L3

● Display of continuous I> faults (synchronous)

Display for continuous overcurrent faults after reset/start delay is over. overcurrent faults times is more than preset times.

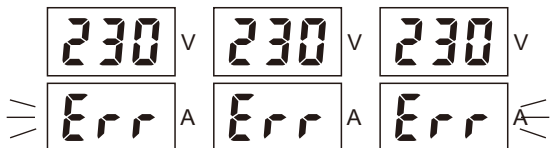

- Disconnect the overload device
- Start the relay after reset manually.

● Display of continuous I> faults (asynchronous)

Display for continuous overcurrent faults after reset/start delay is over. overcurrent faults times is more than preset times.

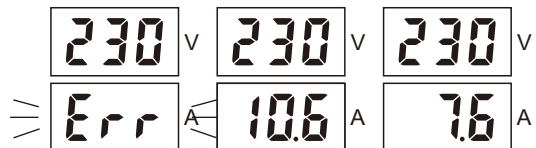

- Disconnect the overload device
- Start the relay after reset manually.

● Display of phase sequence fault



- Display L1-L3-L2 when phase failure fault occurs. User can change the position of L2 and L3 after disconnected supply.

● Display of asymmetry fault (only synchronous)

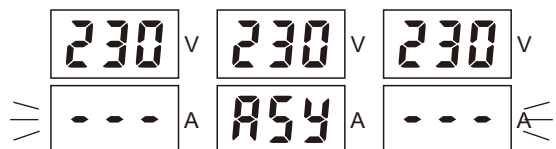

- Voltage operating values display on upper L1-L2-L3 and asymmetry fault code display on lower L2 during the counting of start delay; After the delay is over, the output relay closes.

● Manual reset

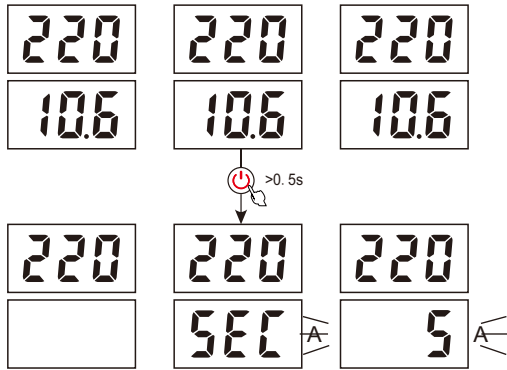

- Auto reset function is off.
- The device will begin counting of reset/start delay after reset for faults.

OPERATING INSTRUCTIONS

- If a voltage fault was detected when the reset/start delay of relay is counting, the output relay opens and faults indication LED lights up.
- The operating voltage and current values will be displayed on screen when the relay is operating normally. If a voltage or current fault was detected, the output relay opens and faults code display.
- Voltage faults: if input voltage was detected to have returned to **Hys** after tripped for voltage faults, the relay will reset automatically and begin the counting of reset/start delay.
Current faults: After the relay tripped for current faults, it will reset automatically begin the counting of reset/start delay.

FUNCTION DIAGRAMS

- Overvoltage and undervoltage

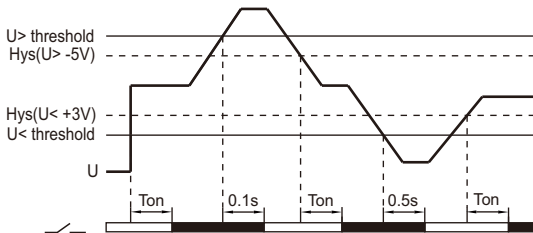

- Overcurrent

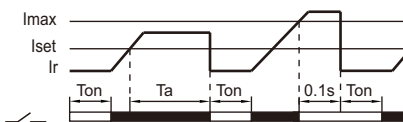

- Asymmetry

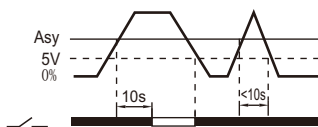

Ts: Reset/start delay
Ta: Overcurrent faults trip delay

SYMBOL

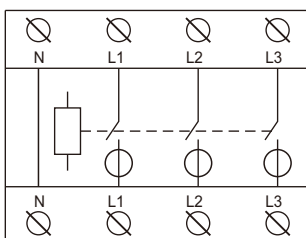

WIRING DIAGRAM

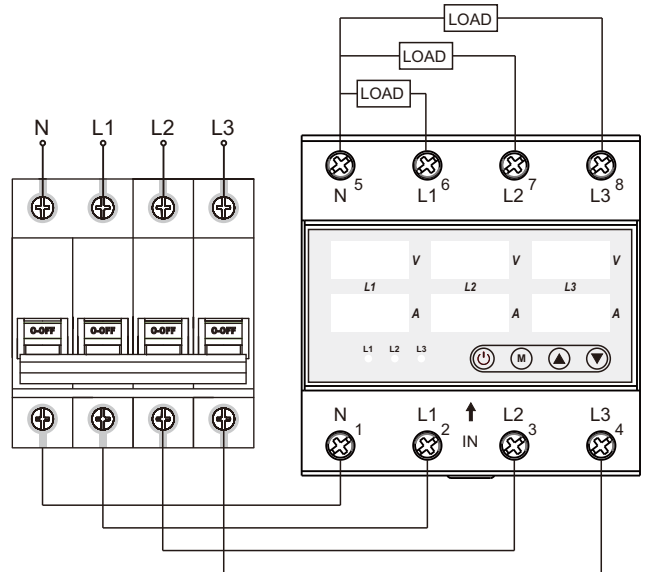

- Rated operating current of circuit breaker is 75% maximum current of the relay
 $I_e = 0.75 \times I_{max}$

DIMENSIONS

