

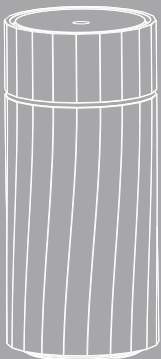

MADE BY ZEN®



## NOMAD

Rechargeable Aroma Diffuser with  
a soft ambient light band

# **TABLE OF CONTENTS:**

**A. ABOUT THE NOMAD**

**B. TECHNICAL SPECIFICATION**

**C. OPERATING INSTRUCTIONS**

**D. FEATURES**

**E. MAINTENANCE**

**F. TROUBLESHOOTING**

**G. WARRANTY**

**Congratulations on purchasing your MADE BY ZEN® Nomad Aroma Diffuser. Please keep this manual to help you get the most out of your Nomad and for maintenance.**

# A - ABOUT THE NOMAD

Slim, sleek, and powerful, the Nomad Aroma Diffuser releases a soothing aromatherapy mist to instantly scent your surroundings. Super versatile, simply charge, twist and move the Nomad to any room to give a boost of fragrance and serenity. Rechargeable for up to 4+ hours, the Nomad is perfect for your desk, bedside table, soothing bath time, placed next to your workout space or even on the go in your car.



Rechargeable



Compact size, ideal for travel, gym, office, home or car



Ambient light band



Intelligent memory: during operation simply twist and top up with your favourite oils in under a minute and the Nomad will intelligently return to its previous setting



Suitable for use with any essential or fragrance oils (MADE BY ZEN® oils recommended)

Thank you for purchasing the MADE BY ZEN® Nomad Aroma Diffuser.

# B - TECHNICAL SPECIFICATIONS

**Model Name:** Nomad Aroma Diffuser

**Model No:** EWX148

**Product Size:**  $\Phi 70 \times 155.5\text{mm}$

**Voltage:** DC 5V (3.7V Lithium Ion Battery)

**Power:** 10W

**Adaptor:** 5V/2A USB

**Water Capacity:** 50ml

**Run Time:** 3.5hours

01. Mist Outlet
02. Cover
03. Water Tank
04. Air Inlet
05. Power Button
06. Indication Light
07. USB Type C socket
08. Intelligent Sensors
09. Max Water level line
10. Drainage Direction
11. Ceramic Disc
12. USB cable
13. USB adaptor (not included, can be purchased separately)

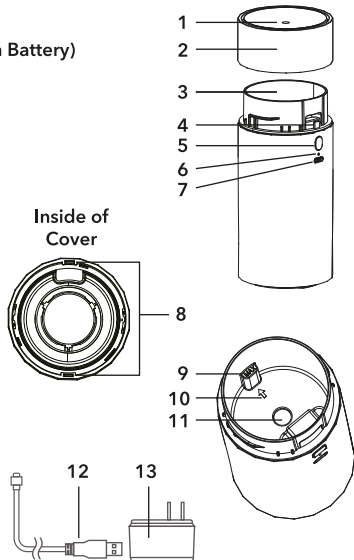

# IMPORTANT NOTES BEFORE

1. The Nomad must always be used with the USB cable provided (as other USB cables are not compatible with this product). Insert only into a 5V/2A power source. You can also use the cable provided with a 5V/2A USB adaptor, which can be purchased separately.
2. The Nomad Ultrasonic Diffuser is not suitable to be charged in a vehicle. Please note the Nomad operates with a 3.7V lithium ion rechargeable battery, many vehicle operate at 12V, which will damage the diffuser.
3. Place the Aroma Diffuser on a flat surface, at least 60cm away from the floor and at least 10cm away from the wall. DO NOT place the Aroma Diffuser on wooden or polished furniture that may be damaged by water moisture.
4. Always unplug the Aroma Diffuser from the electrical supply when cleaning or filling with water. Always use the power adaptor supplied. Ensure the cable is secure to avoid tripping or knocking over the Aroma Diffuser. If the power adaptor is damaged, it must be replaced with a suitable adaptor provided by the manufacturer or its agent. Alternatively, a new adaptor can be purchased from your retailer.
5. Use a suitable measuring cup to fill the water into the water tank. Never attempt to fill water under a running tap or whilst plugged in. Do not fill the water beyond the max water level line. If overfilled, carefully remove the excess water from the tank in the 'drainage direction' as shown by the arrow and away from the vent hole.
6. The Aroma Diffuser must be kept out of reach from children and pets to avoid risk of injury. Children should be supervised at all times to ensure they do not play with the appliance.
7. The Aroma Diffuser is not intended for use by persons (including children) with reduced physical, sensory or mental capabilities or lack of experience and knowledge, unless they have been given supervision or instruction concerning use of the appliance by a person responsible for their safety.
8. Keep the Aroma Diffuser in a clear space to allow the mist to freely spread and away from appliances especially those sensitive to water to avoid unnecessary accidents.
9. The Aroma Diffuser must be cleaned after each use and should always be kept clean and dry when not in use. Never leave stagnant oil and water in the water tank for prolonged periods.

10. Never attempt to disassemble your Aroma Diffuser or repair the product, as this will void your warranty and create a shock hazard. Contact your retailer if an internal inspection is required.
11. In case of abnormal observations such as smoke, peculiar smells or noise, stop using the Aroma Diffuser immediately and contact the retailer from where you purchased it. Never wrap the aroma diffuser or adaptor with cloth or paper as blocking ventilation could increase the risk of fire.
12. Always handle the Aroma Diffuser with care - accidental damage is not covered under the warranty.
13. Always use water at room temperature and use only fresh, clean water from a reliable source. Do not fill the water tank with other chemicals or liquids other than water and a few drops of fragrance or essential oils.
14. Never touch the water within the water tank when the diffuser is in operation as the water may become warm. It is perfectly normal for the water temperature to increase over time. Especially if it has been running for a few hours. This is caused by the energy created from the vibrating disc. The water should not exceed 40°C but for some models it can increase to 50°C (+/- 5°C). However, as the mist dissipates from the mist outlet, the water temperature cools rapidly due to the large surface area of each droplet, hence the mist is referred to as a 'cool mist'.
15. Always plug the adaptor into the DC jack before plugging into the mains.
16. NEVER touch the ultrasonic ceramic disc while the diffuser is plugged in as this could cause serious injury.
15. Do not touch, plug or unplug the aroma diffuser with wet hands.
16. Do not immerse the unit in water or other liquids and do not attempt to clean in a dishwasher.
17. Keep away from open flames, extended exposure may create risk of explosion. Store at room temperature.

# C - OPERATING INSTRUCTIONS

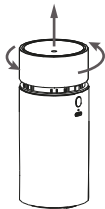

1. Place the diffuser on a firm and flat surface, in upright direction. Twist the cover anti-clockwise (to the right) to remove.

2. Add water to the water tank with a suitable measuring cup until the water reaches the max. water level line.

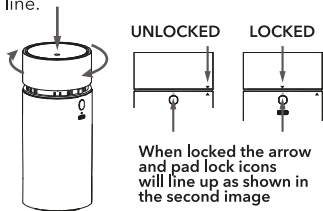
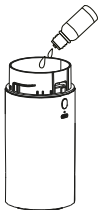

3. Add 3-5 drops of your favourite Fragrance or Essential Oil into the water (MADE BY ZEN® oils recommended).

4. Replace the cover by twisting clockwise (to the left) to secure the lid in place.

**Note: Do not lean or move or attempt to empty or refill the diffuser during operation. Always use in an upright position, never place the diffuser down horizontally when in use or when the water tank contains liquid.**

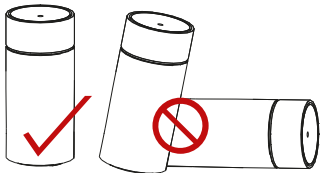

## **BUTTON FUNCTIONS**

- > Press once the ambient light will switch on and the diffuser will begin to mist. When the water level runs low the Nomad will switch off automatically.
- > Press twice the ambient light will switch off but the diffuser will continue to mist. When the water level runs low the Nomad will switch off automatically.
- > Press three times to turn off the mist function.

### **Intelligent memory function**

The Nomad will automatically shut off if the cover is removed during operation, if replaced within 1 minute the Nomad will continue to operate at its previous setting.

**NOTE:** At any point, hold and press the power button for 2 seconds to turn the Nomad off.



# CHARGING

The indication light will flash red to indicate the unit needs to be charged.

1. Plug the cable into the DC Jack before connecting to the USB power point or 5V/2A adaptor (not included).

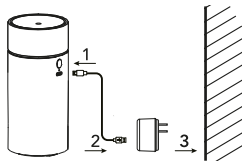
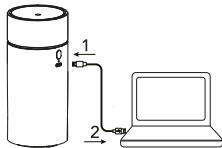

2. Once connected properly the indication light will turn red to indicate that the unit is being charged.

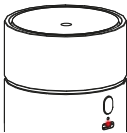

3. The indication light will turn green to indicate the unit is fully charged (time to fully charge approx. 3.5 hours)

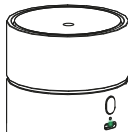

**Note: The Nomad operates most efficiently with a 5V/2A cable/adaptor. The Nomad can be used with a 5V/1A cable/adaptor but this will increase the charge time.**

## D - FEATURES

The Nomad Ultrasonic Aroma Diffuser provides a revolutionary way to fragrance your surroundings. It works by creating high frequency vibrations that breaks down the water and oil into minute particles which are then effectively diffused into the immediate surroundings.

- Rechargeable, compact, on the go solution
- Aroma Diffuser: Can be used with ambient lighting or without the light, ideal for night time use
- Intelligent memory: During operation simply twist and top up with your favourite oils in under a minute and the Nomad will intelligently return to its previous setting.
- Mini humidifier
- Quiet operation
- Auto-shut off when water runs out for an additional safety
- Easy to clean and use

## E - MAINTENANCE

Please ensure the unit is switched off and not connected to the power source.

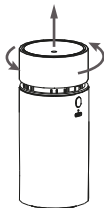

1. Twist the cover anti-clockwise (to the right) to remove.

**DO NOT EMPTY WATER FROM THE SIDE OF THE AIR INLET AS WATER MAY ENTER INTO THE UNIT.**



2. Empty water via the water drainage side, opposite the air inlet.

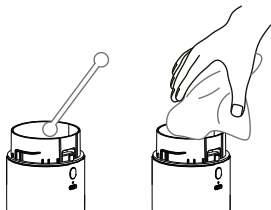

3. Use a clean swab or cloth to clean the unit. Please ensure no dust or dirt is obstructing the air inlet on the base of the unit.

**Caution:** Always switch off the unit and disconnect the cable from the power source before cleaning.

Always keep your Aroma Diffuser clean and dry when not in use.

Never leave stagnant oil and water inside the tank for prolonged periods. If the aroma diffuser stops generating mist (or generates little mist), clean the ceramic disc as indicated above. For stubborn oil build up, use sanitary alcohol on a cotton bud if required.

For stubborn oil build up, use sanitary alcohol on a cotton bud if required.

If the Aroma Diffuser does not generate mist (or generates little mist), clean the ceramic disc.

When cleaning, always take extra care to ensure water does not enter DC Jack power port. Allow the unit to dry thoroughly as advised below if water accidentally enters the electrical port.

**Accidental Leakage:** In the event of the aroma diffuser being knocked over during use, please follow the steps below to avoid malfunction.

- Unplug the diffuser from the mains and remove the cover carefully.
- Pour out any remaining water from the tank.
- Shake the diffuser gently to drain any water from inside, then leave for 24 hours for the diffuser to dry thoroughly in a well-ventilated area.

# F - TROUBLESHOOTING

Problem	Possible Cause	Solution
When switched on the unit powers off	The unit will not work without water	Fill the water tank with ordinary tap water. Take care not to fill past the max water level line.
No mist or mist volume significantly reduced	Water is lower than the water level sensor.	Refill the water tank with ordinary tap water. Take care not to fill past the max water level line.
	Water is exceeding the max water level line.	Carefully pour out excess water in the direction of the Water Discharge Indicator arrow, away from the vent hole.
	There may be a build-up of oil on the ceramic disc.	Clean the ceramic disc with water and a clean cloth.
	Mist outlet is blocked.	Clean the mist outlet by thoroughly cleaning the inside of the cover with clean water.
Unit will not switch on	There is insufficient water in the reservoir.	Carefully fill the reservoir with water to the Max Water Level. Do not overfill.
	The units charging (indicator light will flash red)	Plug the USB cable into a 5V/2A power source to charge the unit, using the cable provided. A red light will indicate that the unit is charging.
	The power cable may not be connected properly.	Disconnect the cable and try connecting properly. A red light will indicate that the unit is charging.
Water is leaking from the unit	Water may have entered the internal structure.	Follow the instructions for 'Accidental Leakage' above and try to operate the unit again.
	The cover is not positioned correctly.	Remove the cover and replace correctly, allowing the mist to release correctly.
	The unit has been tipped or knocked over.	Follow the instructions for 'Accidental Leakage' above and try to operate the unit again.
	The temperature is low and/or there is high humidity.	Under these conditions, mist can sometimes condense into water droplets.

**The intensity and amount of mist may vary, but this is not unusual and should not be considered as a fault. Factors that may affect this include water type, humidity, temperature, air currents etc.**

## G - WARRANTY

This product carries a 12-month warranty for proper use in accordance with this manual against any manufacturing defects. Accidental damage is not covered under the warranty.

The warranty period is 12 months from the date of purchase. In case of any problems arising during the warranty period, please contact your retailer for maintenance or claims. Proof of purchase will be required, so it is vital that you keep your receipt of purchase with this safety manual.

Corrosive oils such as Citronella may cause damage to the unit if left in the water tank. This type of damage is not covered under the warranty. This Aroma Diffuser must be cleaned after each use.



**IMPORTANT!**

MADE BY ZEN® Ultrasonic Aroma Diffusers comply with the WEEE Directive (Waste from Electrical and Electronic Equipment Directive) 2012/19/EU.

When the Nomad Aroma Diffuser reaches the end of its working life, it should not be disposed of in the normal waste stream, but at an appropriate collection point for the recycling of electrical products.

Caring for our planet is important to us, so please help us by disposing of Nomad correctly. Thank you.



MADE BY ZEN®

MADEBYZEN.COM