

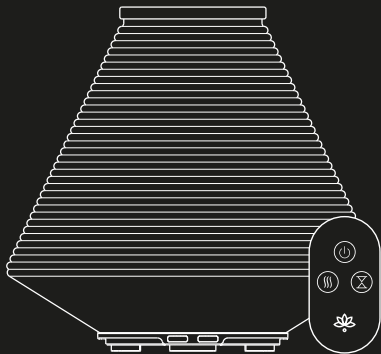

MADE BY ZEN®



NEGARA

Luxurious hand turned solid  
wood Aroma Diffuser

# **TABLE OF CONTENTS:**

**A. ABOUT THE NEGARA**

**B. TECHNICAL SPECIFICATION**

**C. OPERATING INSTRUCTIONS**

**D. FEATURES**

**E. MAINTENANCE**

**F. TROUBLESHOOTING**

**G. WARRANTY**

**Congratulations on purchasing your MADE BY ZEN® Negara Aroma Diffuser. Please keep this manual to help you get the most out of your Negara and for maintenance.**

# A - ABOUT THE NEGARA

Relax and rejuvenate with the luxurious beauty of the Negara Aroma Diffuser. The solid wood body is hand crafted with intricate grooves. Made from sustainable rubberwood, the Negara celebrates forests; the lungs of the earth. Releasing a calming aromatherapy mist, the Negara fills the air with irresistible fragrance. Unwind in nature with the deep rich colour of Negara's rubberwood body, creating an escape into tranquillity.



Hand turned solid wood cover



Multiple mist setting; low, high & intermittent mist.



Remote control



Suitable for use with any essential or fragrance oils (MADE BY ZEN® oils recommended)

Thank you for purchasing the MADE BY ZEN® Negara Aroma Diffuser.

# B - TECHNICAL SPECIFICATIONS

**Model Name:** Negara Aroma Diffuser

**Model No:** EWJS03-1RWD

**Product Size:**  $\Phi 190 \times 168\text{mm}$

**Voltage:** DC 24V

**Power:** 12W

**Water Capacity:** 100ml

**Run Time:** High mist 4 hours

Low mist 7 hours

Intermittent mist 10 hours

01. Mist Outlet
02. Wooden Cover
03. Inner Cover
04. Water Tank
05. Air Outlet
06. Continuous Mist Button
07. Intermittent Mist Button
08. Drainage Direction
09. Max. Water Level Line
10. Ceramic Disc
11. Air Inlet
12. DC Jack
13. Adaptor
14. Remote

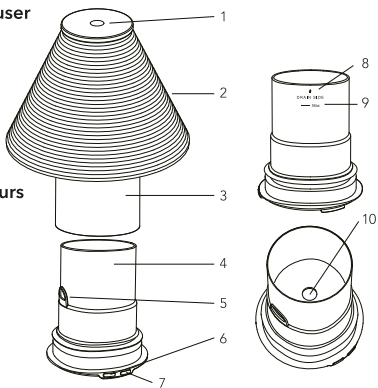

Underside of  
the base

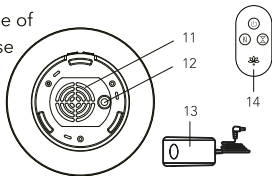

# IMPORTANT NOTES BEFORE

1. Place the Aroma Diffuser on a flat surface, at least 60cm away from the floor and at least 10cm away from the wall. DO NOT place the Aroma Diffuser on wooden or polished furniture that may be damaged by water moisture.
2. Always unplug the Aroma Diffuser from the mains electrical supply when cleaning or filling with water. Always use the power adaptor supplied. Ensure the cable is secure to avoid tripping or knocking over the Aroma Diffuser. If the power adaptor is damaged, it must be replaced with a suitable adaptor provided by the manufacturer or its agent. Alternatively, a new adaptor can be purchased from your retailer.
3. Use a suitable measuring cup to fill the water into the water tank. Never attempt to fill water under a running tap or whilst plugged in. Do not fill the water beyond the max water level line. If overfilled, carefully remove the excess water from the tank in the 'drainage direction' as shown by the arrow and away from the vent hole.
4. The Aroma Diffuser must be kept out of reach from children and pets to avoid risk of injury. Children should be supervised at all times to ensure they do not play with the appliance.
5. The Aroma Diffuser is not intended for use by persons (including children) with reduced physical, sensory or mental capabilities or lack of experience and knowledge, unless they have been given supervision or instruction concerning use of the appliance by a person responsible for their safety.
6. Keep the Aroma Diffuser in a clear space to allow the mist to freely spread and away from appliances especially those sensitive to water to avoid unnecessary accidents.
7. The Aroma Diffuser must be cleaned after each use and should always be kept clean and dry when not in use. Never leave stagnant oil and water in the water tank for prolonged periods.
8. Never attempt to disassemble your Aroma Diffuser or repair the product, as this will void your warranty and create a shock hazard. Contact your retailer if an internal inspection is required.
9. In case of abnormal observations such as smoke, peculiar smells or noise, stop using the Aroma Diffuser immediately and contact the retailer from where you purchased it. Never wrap the aroma diffuser or adaptor with cloth or paper as blocking ventilation could increase the risk of fire.

10. Always handle the Aroma Diffuser with care - accidental damage is not covered under the warranty.

11. Always use water at room temperature and use only fresh, clean water from a reliable source. Do not fill the water tank with other chemicals or liquids other than water and a few drops of fragrance or essential oils.

12. Never touch the water within the water tank when the diffuser is in operation as the water may become warm. It is perfectly normal for the water temperature to increase over time. Especially if it has been running for a few hours. This is caused by the energy created from the vibrating disc. The water should not exceed 40°C but for some models it can increase to 50°C (+/- 5°C). However, as the mist dissipates from the mist outlet, the water temperature cools rapidly due to the large surface area of each droplet, hence the mist is referred to as a 'cool mist'.

13. Always plug the adaptor into the DC jack before plugging into the mains.

14. Do not remove the cover during operation.

15. NEVER touch the ultrasonic ceramic disc while the diffuser is plugged in as this could cause serious injury.

16. Do not immerse the unit in water or other liquids and do not attempt to clean in a dishwasher.

17. Remove the plastic insert to activate the battery before using the remote control (as shown below) The remote comes with the battery already fitted.



# C - OPERATING INSTRUCTIONS

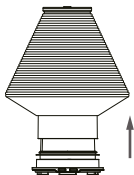

1. Place the diffuser on a firm and flat surface, in upright direction. Remove the wood cover and inner cover upward carefully as shown.



2. Add water to the water tank with a suitable measuring cup until the water reaches the max. water level line as shown.



3. Add 3-5 drops of your favourite Fragrance or Essential Oil into the water (MADE BY ZEN® oils recommended).

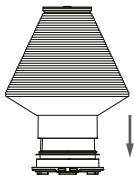

4. Replace the inner cover followed by the wood cover.

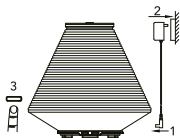

5. Plug the cable into the DC Jack before connecting the USB port to the power supply.

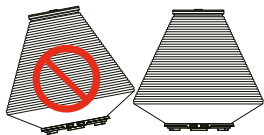

**Note: Do not lean or move or attempt to empty or refill the diffuser during operation.**

## BUTTON FUNCTIONS

The buttons on the base of the Negara can be used when your remote is not available.

### CONTINUOUS MIST CONTROL (LEFT BUTTON)

> **Press once** to operate the low mist function. The aroma diffuser will mist at low intensity until the water level runs low. At this point the Negara will switch off automatically.

> **Press twice** to operate the high mist function. The aroma diffuser will mist at high intensity until the water level runs low. At this point the Negara will switch off automatically.

> **Press three** times to turn off the continuous mist function.



## INTERMITTENT MIST CONTROL (RIGHT BUTTON)

> **Press once** to operate the intermittent mist function. The aroma diffuser will mist intermittently; 30 seconds on/30 seconds off. When the water level runs low the Negara will switch off automatically.

> **Press twice** to turn off the intermittent mist function.

## REMOTE CONTROL

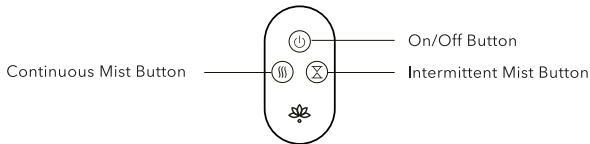

### **On/Off Button**

Switch on the Negara, using the On/Off button on the remote control panel

> **Press once** to switch on the unit, the aroma diffuser will operate the low mist function.

> **Press twice** to switch off the unit.

### Continuous Mist Button

(This button will activate only after switching on the unit using the On/Off Button)

- > **Press once** to operate the low mist function.
- > **Press twice** to operate the high mist function.
- > **Press three times** to turn off the continuous mist function.

### Intermittent Mist Button

(This button will activate only after switching on the unit using the On/Off Button)

- > **Press once** to operate the intermittent mist function. The aroma diffuser will mist intermittently; 30 seconds on/30 seconds off.
- > **Press twice** to turn off the intermittent mist function.

**NOTE: When the water level runs low the Negara will switch off automatically.**

## D - FEATURES

The Negara Ultrasonic Aroma Diffuser provides a revolutionary way to fragrance your surroundings. It works by creating high frequency vibrations that breaks down the water and oil into minute particles which are then effectively diffused into the immediate surroundings.

- Hand turned solid wood cover
- Multiple mist setting; low, high & intermittent mist
- Remote control
- Mini humidifier
- Quiet operation
- Auto-shut off when water runs out for an additional safety
- Easy to clean and use

## E - MAINTENANCE

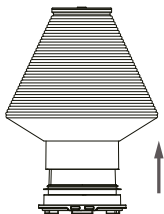
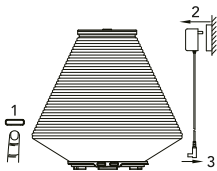

1. Make sure the mist functions have been switched off and unplug the power from the mains.

2. Remove the wood cover and inner cover upward carefully as shown.

**DO NOT EMPTY WATER FROM THE SIDE OF THE AIR INLET AS WATER MAY ENTER INTO THE UNIT.**

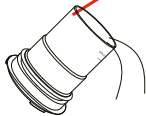

3. Empty water via the water drainage side, as shown on the water tank.

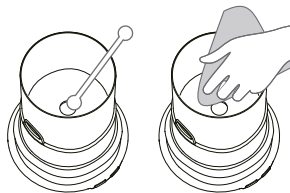

4. Use a clean swab or cloth to clean the unit.

**Caution:** Always switch off the appliance and disconnect the power source from electrical outlet before cleaning.

Always keep your Aroma Diffuser clean and dry when not in use.

Never leave stagnant oil and water inside the tank for prolonged periods. If the aroma diffuser stops generating mist (or generates little mist), clean the ceramic disc as indicated above. For stubborn oil build up, use sanitary alcohol on a cotton bud if required.

For stubborn oil build up, use sanitary alcohol on a cotton bud if required.

If the Aroma Diffuser does not generate mist (or generates little mist), clean the ceramic disc.

When cleaning, always take extra care to ensure water does not enter DC Jack power port. Allow the unit to dry thoroughly as advised below if water accidentally enters the electrical port.

**Accidental Leakage:** In the event of the aroma diffuser being knocked over during use, please follow the steps below to avoid malfunction.

- Unplug the diffuser from the mains and remove the cover carefully.
- Pour out any remaining water from the tank.
- Shake the diffuser gently to drain any water from inside, then leave for 24 hours for the diffuser to dry thoroughly in a well-ventilated area.

# F - TROUBLESHOOTING

Problem	Possible Cause	Solution
No Mist or mist volume significantly reduced	Power supply is not connected	Plug in the power adaptor and press the button on the base.
	Water is lower than the water level sensor	Refill the tank with ordinary tap water. Take care not to fill past the max water level line
	Water is exceeding the max water level line	Carefully pour out excess water in the direction of the water discharge arrow
	There may be a build-up of oil on the ceramic disc	Clean the ceramic disc with water and a clean cloth
	Mist outlet is blocked	Clean the mist outlet by thoroughly cleaning the inside of the cover with clean water
Unit will not switch on	There is an insufficient amount of water in the tank	Fill the water tank with water up to the max water level line. Do not over fill
	The power cable may not be connected properly	Disconnect the cable and try connecting properly
Water is leaking from the product	The cover is not positioned correctly	Remove the covers and replace correctly allowing mist to release correctly
	The unit has been tipped or knocked over	Follow the accidental leakage instructions
	The temperature is low or there is high humidity	Under these conditions the mist can sometimes condense into water droplets
	Water moisture has built up inside the cover	Remove the inner cover and dry off excess water from the inside of the cover
Remote control is not working	The battery may have stopped working	Please unscrew the battery section on the back of the remote and change the battery (screw driver not included)

The intensity and amount of mist may vary, but this is not unusual and should not be considered as a fault. Factors that may affect this include water type, humidity, temperature, air currents etc.

## G - WARRANTY

This product carries a 12-month warranty for proper use in accordance with this manual against any manufacturing defects. Accidental damage is not covered under the warranty.

The warranty period is 12 months from the date of purchase. In case of any problems arising during the warranty period, please contact your retailer for maintenance or claims. Proof of purchase will be required, so it is vital that you keep your receipt of purchase with this safety manual.

Corrosive oils such as Citronella may cause damage to the unit if left in the water tank. This type of damage is not covered under the warranty. This Aroma Diffuser must be cleaned after each use.



**IMPORTANT!**

MADE BY ZEN® Ultrasonic Aroma Diffusers comply with the WEEE Directive (Waste from Electrical and Electronic Equipment Directive) 2012/19/EU.

When the Negara Aroma Diffuser reaches the end of its working life, it should not be disposed of in the normal waste stream, but at an appropriate collection point for the recycling of electrical products.

Caring for our planet is important to us, so please help us by disposing of Negara correctly. Thank you.



MADE BY ZEN®

MADEBYZEN.COM