



MADE BY ZEN®
L O N D O N



NOVO SAPPHIRE

USB Aroma Diffuser with a soft ambient light
Zen on the Go®

TABLE OF CONTENTS:

A. ABOUT THE NOVO SAPPHIRE

B. TECHNICAL SPECIFICATION

C. OPERATING INSTRUCTIONS

D. FEATURES

E. MAINTENANCE

F. TROUBLESHOOTING

G. WARRANTY

Congratulations on purchasing your MADE BY ZEN® Novo Sapphire Aroma Diffuser. Please keep this manual to help you get the most out of your Novo and for maintenance.

A - ABOUT THE NOVO SAPPHIRE

The perfect wellness accessory for your desk, bedside table or wherever you need a zen boost. The Novo Aroma Diffuser is compact and sleek, releasing a cool aromatherapy mist to scent your surroundings.

The soft ambient lighting helps to create calm and balance. Use the USB cable to plug into your laptop to help improve focus and deliver mood-boosting benefits, naturally.



Built in LEDs provide a soft ambient light, to aid relaxation.



Sleep mode (no light) option



Calming aromatherapy mist



Suitable for use with any essential or fragrance oils (MADE BY ZEN® oils recommended)

Thank you for purchasing the MADE BY ZEN® Novo Sapphire Aroma Diffuser.

B - TECHNICAL SPECIFICATIONS

Model Name: Novo Aroma Diffuser

Model No: EW059

Product Size: Ø113 x 96mm

Voltage: DC 5V

Power: 5W

Water Capacity: 100ml

Run Time: 4+ hours

01. Mist output
02. Cover
03. Max. Water Level Line
04. Drainage Direction
05. Ceramic Disc
06. Air Outlet
07. Water Tank
08. Air Vent
09. USB Jack
10. Power Button
11. USB Cable

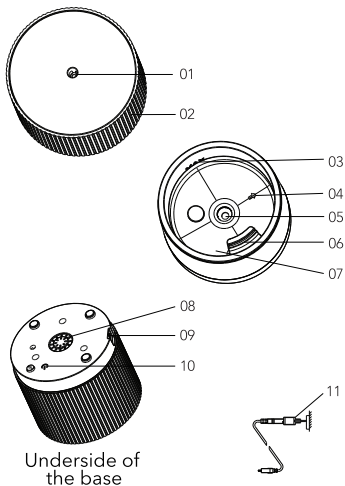

IMPORTANT NOTES BEFORE

The Aroma Diffuser **MUST** be cleaned before and after each use. When stored the unit should always be kept clean and dry. **NEVER** leave stagnant oil and water in the water tank for any prolonged period.

Whilst using your diffuser, you **MUST** clean the water tank every 3 days:



Micro-organisms that may be present in the water or in the environment where the appliance is used or stored, can develop in the water reservoir, and expelled into the air when next used causing very serious health risks. To prevent this the water tank **MUST be cleaned properly every 3 days.**

Der Aromadiffuser **MUSS** vor und nach jeder Verwendung gereinigt werden. Das Gerät sollte immer in einem sauberen und trockenen Zustand gelagert werden. Lassen Sie NIE über einen längeren Zeitraum Öl und Wasser im Wassertank stehen.

Während der Verwendung Ihres Diffusers **MÜSSEN** Sie den Wassertank **alle** drei Tagen reinigen:



Eventuell im Wasser oder der Umgebung, in der das Gerät verwendet bzw. gelagert wird, vorhandene Mikroorganismen können sich im Wassertank weiterentwickeln, bei der nächsten Verwendung in die Luft austreten und somit äußerst ernsthafte Gesundheitsrisiken hervorrufen. Zur Vermeidung dessen **MUSS der Wassertank alle drei Tage ordentlich gereinigt werden.**

يجب تنظيف الفواحة العطرية قبل وبعد كل استعمال. في حال حفظ وتخزين الجهاز، يجب دوماً المحافظة عليه نظيفاً وجافاً. لا تترك بقايا الزيت والماء الرாகباً في خزان الماء لمدة طويلة جداً.

أثناء استعمال الفواحة العطرية، يجب عليك تنظيف خزان الماء كل ٣ أيام.



يمكن للكائنات الدقيقة التي قد تكون موجودة في الماء أو في البيئة في حال استخدام الجهاز أو تخزينه أن تلمو في خزان الماء، وتنتشر في الهواء، وسوف يتسبب الاستعمال التالي للجهاز بأخطار صحية كبيرة جداً. لحماية خزان الماء، يجب تنظيفه على نحو مناسب كل ٣ أيام (٧٢ ساعة).

1. The Novo must always be used with the USB cable provided (as other USB cables are not compatible with this product). Insert only into a 5V/1A power source. You can also use the cable provided with a 5V mains USB adaptor, which must be purchased separately.
2. Ensure that the mist is not too close to any material sensitive to water and take care not to spill water around your computer.
3. The Novo Aroma Diffuser is not suitable for use in vehicles. Please note the Novo operates with a 5V power, many vehicles operate at 12V, which will damage the diffuser.
4. Place the Aroma Diffuser on a flat surface, at least 60cm away from the floor and at least 10cm away from the wall. Do not place the Aroma Diffuser on wooden or polished furniture that may be damaged by water moisture.
5. Always unplug the Aroma Diffuser from the USB electrical supply when cleaning or filling with water. Always use the USB cable supplied. Ensure the cable is secure to avoid tripping or knocking over the Aroma Diffuser. If the cable is damaged, it must be replaced with a suitable cable provided by the manufacturer or its agent. Alternatively, a new cable can be purchased from your retailer.
6. Use a suitable measuring cup to fill the water into the water reservoir. Never attempt to fill water under a running tap or whilst plugged in. Do not fill the water beyond the max. water level line. If overfilled, carefully remove the excess water from the water reservoir away from the vent hole.
7. The Aroma Diffuser must be kept out of reach of children and pets to avoid risk of injury. Children should be supervised at all times to ensure they do not play with the appliance.
8. The Aroma Diffuser is not intended for use by persons (including children) with reduced physical, sensory or mental capabilities or lack of experience and knowledge, unless they have been given supervision or instruction concerning use of the appliance by a person responsible for their safety.
9. Keep the Aroma Diffuser in a clear space to allow the mist to freely spread and away from appliances especially those sensitive to water to avoid unnecessary accidents.
10. The Aroma Diffuser must be cleaned after each use and should always be kept clean and dry when not in use. Never leave stagnant oil and water in the water tank for prolonged periods.

11. Never attempt to disassemble your Aroma Diffuser or repair the product, as this will void your warranty and create a shock hazard. Contact your retailer if your Aroma Diffuser develops a fault or an internal inspection is required.
12. Never touch the water within the water tank when the diffuser is in operation as the water may become warm. It is perfectly normal for the water temperature to increase over time. Especially if it has been running for a few hours. This is caused by the energy created from the vibrating disc. The water should not exceed 40°C but for some models it can increase to 50°C (+/- 5°C). However, as the mist dissipates from the mist outlet, the water temperature cools rapidly due to the large surface area of each droplet, hence the mist is referred to as a 'cool mist'.
13. In case of abnormal observations such as smoke, peculiar smells or noise, stop using the Aroma Diffuser immediately and contact the retailer from where you purchased it. Never wrap the adaptor with cloth or paper as blocking ventilation could increase the risk of fire.
14. Always handle the Aroma Diffuser with care - accidental damage is not covered under the warranty.
15. Always use water at room temperature and use only fresh, clean water from a reliable source. Do not fill the water tank with other chemicals or liquids other than water and a few drops of fragrance or essential oils.
16. Always plug the adaptor into the DC jack inlet before plugging into the USB power point.
17. Do not remove the cover during operation.
18. NEVER touch the ultrasonic ceramic disc while the diffuser is plugged in as this could cause serious injury.
19. Do not immerse the unit in water or other liquids and do not attempt to clean in a dishwasher.
20. Do not operate without water. The Aroma Diffuser is designed to enter standby mode when there is no water remaining in the water reservoir.

C - OPERATING INSTRUCTIONS

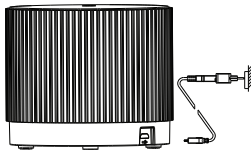

1. Place the cable into the USB jack before placing the USB port into the power supply.

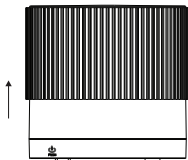

2. Place the diffuser upright on a firm and flat surface. Remove the cover carefully upwards.

DO NOT EXCEED
THE MAX WATER
LEVEL LINE

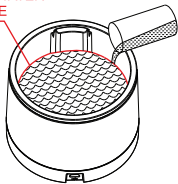

3. Add tap water to the water reservoir using a suitable filling cup to the max level line.

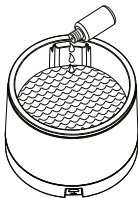

4. Add 3-5 drops of your favourite fragrance or essential oil into the water

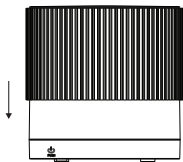

5. Replace the cover



Note: Do not lean or move or attempt to empty or refill the diffuser during operation.

BUTTON FUNCTIONS

Switch on the Aroma Diffuser by gently placing your hand over the cover as illustrated in the direction of the on/off switch on the base of the unit

Press ON/OFF BUTTON once (by gently placing your hand over the cover and applying pressure in the direction of the switch button, as illustrated):

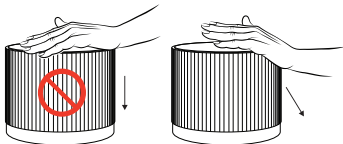

The Aroma Diffuser will begin to mist and the ambient light will switch on.

> **Press twice** the ambient light will switch off whilst the Aroma Diffuser will continue to mist. (Sleep mode, no light option)

> **Press three times** the Aroma Diffuser will switch off

Note: Under normal operation, the Aroma Diffuser will switch off automatically when the water level runs low.

D - FEATURES

The Novo Ultrasonic Aroma Diffuser provides a revolutionary way to fragrance your surroundings. It works by creating high frequency vibrations that breaks down the water and oil into minute particles which are then effectively diffused into the immediate surroundings.

- Unique patented design
- Aroma Diffuser: can be used with ambient lighting or without, ideal for night-time use
- Low energy LED ambient lights
- Mini humidifier
- Quiet operation
- Auto-shut off when water runs out for an additional safety
- Easy to clean and use
- Suitable for use in home, office & hotel rooms
- USB cable provided

E - MAINTENANCE

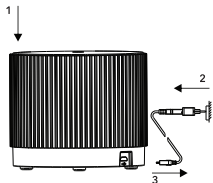

1. Press the ON/OFF button to switch off the Aroma Diffuser and unplug the USB from the mains.

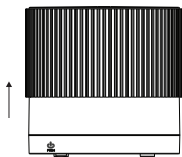

2. Remove the cover upward carefully as shown.

DO NOT EMPTY WATER FROM THE SIDE OF THE AIR OUTLET

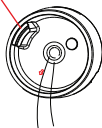

3. Empty water via the water drainage side as shown by the arrow at the base of the reservoir

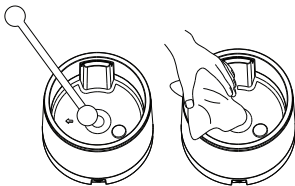

4. Use a clean swab or cloth to clean the unit.

Caution: Always switch off the appliance and disconnect the power source from electrical outlet before cleaning.

Always keep your Aroma Diffuser clean and dry when not in use. Never leave stagnant oil and water inside the tank for prolonged periods. If the aroma diffuser stops generating mist (or generates little mist), clean the ceramic disc as indicated above. For stubborn oil build up, use sanitary alcohol on a cotton bud if required.

When cleaning, always take extra care to ensure water does not enter DC Jack power port. Allow the unit to dry thoroughly as advised below if water accidentally enters the electrical port.

Accidental Leakage: In the event of the aroma diffuser being knocked over during use, please follow the steps below to avoid malfunction.

- Unplug the diffuser from the mains and remove the cover carefully.
- Pour out any remaining water from the tank.
- Shake the diffuser gently to drain any water from inside, then leave for 24 hours for the diffuser to dry thoroughly in a well-ventilated area.

F - TROUBLESHOOTING

Problem	Possible Cause	Solution
No Mist or mist volume significantly reduced	Power supply is not connected	Plug in the power adaptor and press to activate the button on the base.
	Water is lower than the water level sensor	Refill the tank with ordinary tap water. Take care not to fill past the max water level line
	Water is exceeding the max water level line	Carefully pour out excess water via the water drain side
	There may be a build-up of oil on the ceramic disc	Clean the ceramic disc with water and a clean cloth
	Mist outlet is blocked	Clean the mist outlet by thoroughly cleaning the inside of the cover with clean water
Unit will not switch on	There is an insufficient amount of water in the tank	Fill the water tank with water up to the max water level line. Do not over fill
	The power cable may not be connected properly	Disconnect the cable and try connecting properly
Water is leaking from the product	The cover is not positioned correctly	Remove the covers and replace correctly allowing mist to release correctly
	The unit has been tipped or knocked over	Follow the accidental leakage instructions
	The temperature is low or there is high humidity	Under these conditions the mist can sometimes condense into water droplets
	Water moisture has built up inside the cover	Remove the inner cover and dry off excess water from the inside of the cover

The intensity and amount of mist may vary, but this is not unusual and should not be considered as a fault. Factors that may affect this include water type, humidity, temperature, air currents etc.

G - WARRANTY

This product carries a 12-month warranty for proper use in accordance with this manual against any manufacturing defects. Accidental damage is not covered under the warranty, including glass breakage.

The warranty period is 12 months from the date of purchase. In case of any problems arising during the warranty period, please contact your retailer for maintenance or claims. Proof of purchase will be required, so it is vital that you keep your receipt of purchase with this manual safely.

Corrosive oils such as Citronella may cause damage to the unit if left in the water tank. This type of damage is not covered under the warranty. This Aroma Diffuser must be cleaned after each use.



IMPORTANT!

MADE BY ZEN® Ultrasonic Aroma Diffusers comply with the WEEE Directive (Waste from Electrical and Electronic Equipment Directive) 2012/19/EU.

Electrical equipment is a large source of waste and if not properly recycled could have damaging effects on the environment, whereas if it is recycled, the resources could be used again.

Electronic waste needs to be separated from other waste to be recycled properly. When the Novo Aroma Diffuser reaches the end of its working life, please deposit at an appropriate collection point for recycling of electrical products. You can also recycle used electronics at Household Waste Recycling Centres.

Caring for our planet is important to us, so please help us by disposing of the Novo correctly. Thank you.



MADE BY ZEN®
L O N D O N

MADEBYZEN.COM