

# Installation & Operation Manual

## Radiant Thermostat 519

### Introduction

The Radiant Thermostat 519 accurately controls the room and/or floor temperature for a hydronic heating zone using Pulse Width Modulation (PWM) technology. Simple up and down buttons and a display with large type make this thermostat easy to read and use. A Floor Sensor 079 is included to measure floor temperature to protect the floor from overheating and enhance comfort.

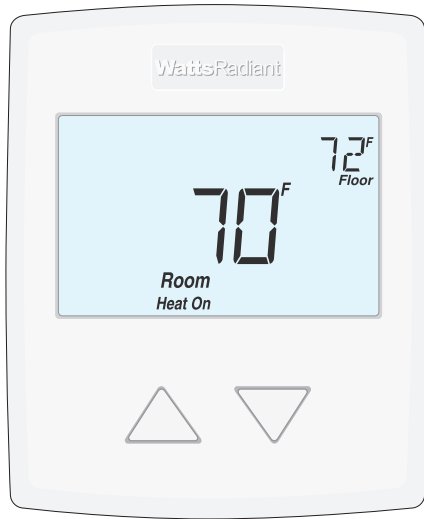

### Energy Saving Features

- Auto Heating Cycle

### Additional Features

- Radiant Floor Heating
- Pulse Width Modulation
- Floor & Air Temperature Control
- Outdoor & Floor Temperature Display
- Backlight
- Freeze Protection
- Includes Floor Sensor 079

Authorized Distributor:

**warmyourfloor™**  
the radiant floor heating experts™

customercare@warmyourfloor.com

(866) 558-3369

**WattsRadiant™**

## **⚠ WARNING**

It is your responsibility to ensure that this control is safely installed according to all applicable codes and standards. This electronic control is not intended for use as a primary limit control. Other controls that are intended and certified as safety limits must be placed into the control circuit. Watts Radiant is not responsible for damages resulting from improper installation and/or maintenance.



Read this Manual **BEFORE** using this equipment.

Failure to read and follow all safety and use information can result in personal injury, property damage, or damage to the equipment.

Keep this Manual for future reference.

## **Getting Started**

Congratulations on the purchase of your new thermostat.

This manual will step through the complete installation, programming and sequence of operation for this control. At the back, there are tips for control and system troubleshooting.

## **Table of Contents**

Installation .....	3	Sequence of Operation.....	12
Preparation .....	3	Heating Operation.....	12
Removing The Thermostat Base....	3	Programmable Settings .....	13
Mounting The Thermostat.....	4	Troubleshooting .....	14
Floor Sensor 079 Installation .....	5	Error Messages .....	14
Floor Sensor 079 Wiring .....	6	Frequently Asked Questions .....	15
Floor Sensor 079 Testing.....	7	Technical Data .....	15
Temperature vs. Resistance Table....	7	Limited Warranty and Product	
Thermostat Wiring .....	8	Return Procedure .....	16
Testing the Thermostat Wiring.....	10		
User Interface .....	11		
Home Screen.....	11		
Symbols Description.....	11		

# Installation

## Preparation

### Tools Required

- Jeweller screwdriver
- Wire Stripper
- Phillips head screwdriver

### Materials Required

- 18 AWG LVT Solid Wire  
(Low Voltage Connections)

### Installation Location

Choose the placement of the thermostats early in the construction process to enable proper wiring during rough-in.

Consider the following:

- Interior Wall.
- Keep dry. Avoid potential leakage onto the control.
- Relative Humidity less than 90%. Non-condensing environment.
- No exposure to extreme temperatures beyond 32-122°F (0-50°C).
- No draft, direct sun, or other cause for inaccurate temperature readings.
- Away from equipment, appliances, or other sources of electrical interference.
- Easy access for wiring, viewing, and adjusting the display screen.
- Approximately 5 feet (1.5 m) off the finished floor.
- The maximum length of wire is 500 feet (150 m).
- Strip wire to 3/8" (10 mm) for all terminal connections.
- Use standard 4 conductor, 18 AWG wire.

## Removing The Thermostat Base

To remove the thermostat base:

- Locate the tab on the bottom of the thermostat.
- Push the tab with either your thumb or with a screwdriver.
- Lift the thermostat front away from the thermostat's base.

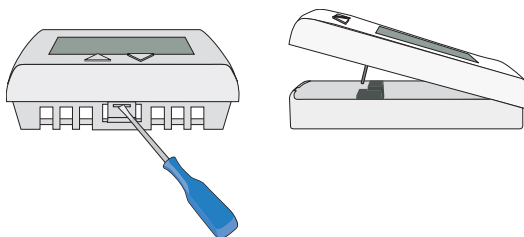

## Mounting The Thermostat

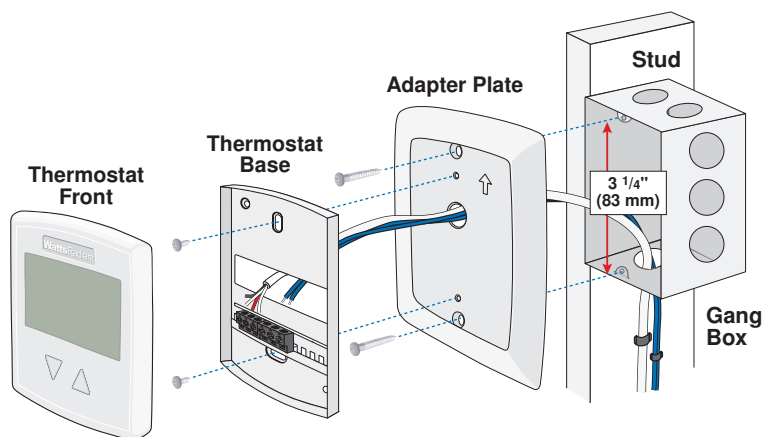

If a single gang box is used:

- Adapter Plate is required (sold separately).
- Feed the wiring through the hole in the adaptor plate and the thermostat base.
- Fasten the adaptor plate to the gang box.
- Fasten the base of the thermostat to the adaptor plate.
- Terminate wiring to the wiring strip.
- Push the thermostat front onto the thermostat base.

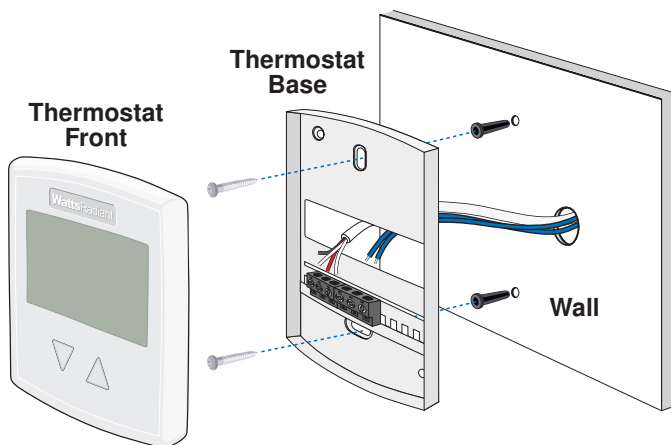

If mounting directly to the wall:

- Drill holes and install the wall anchors.
- Feed the wiring through the large hole in the thermostat base.
- Fasten the thermostat base to the wall using the wood screws to the wall anchors.
- Terminate wiring to the wiring strip.
- Push the thermostat front onto the thermostat base.

### New Installations

#### Thin-Set or Thin-Pour Applications

If the floor covering is to be installed over either a thin-set or thin-pour material of sufficient depth, the floor sensor can be placed directly into either the thin-set material or the thin-pour material and covered over.

Ensure that the sensor is located in such a position that the attached wire is able to reach to a suitable junction location. Splices within the thin-set or thin-pour should be avoided to ensure trouble free operation. The sensor should be located mid way between the heating elements to ensure a proper temperature reading.

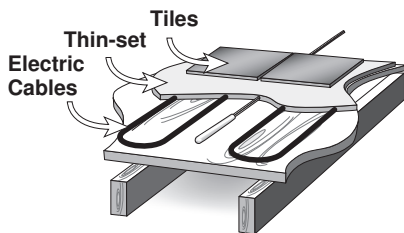

#### Thin Floor Coverings (less than 3/8" (10 mm))

If a thin floor covering is to be installed directly to the subfloor, a groove 1/8" (4 mm) wide by 1/16" (2 mm) deep can be cut into the surface of the subfloor to accommodate the wire for the sensor.

Ensure that the sensor is located in such a position that the attached wire is able to reach to a suitable junction location. Splices under the floor covering should be avoided to ensure trouble free operation. A groove 3/16" (5 mm) wide by 3/16" (5 mm) deep by 1-3/4" (45 mm) long should be cut to accommodate the sensor. The sensor should be located mid way between the heating elements to ensure a proper temperature reading.

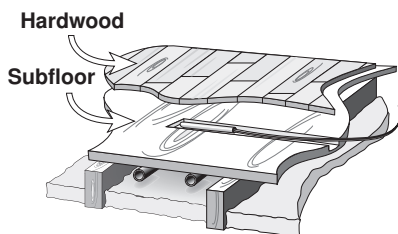

#### Thick Floor Coverings (greater than 3/8" (10 mm))

If a thick floor covering is to be installed directly to the subfloor, a groove 1/8" (4 mm) wide by 1/16" (2 mm) deep can be cut into the back of the flooring material to accommodate the wire for the sensor. Ensure that the sensor is located in such a position that the attached wire is able to reach to a suitable junction location.

Splices under the floor covering should be avoided to ensure trouble free operation. A groove 3/16" (5 mm) wide by 3/16" (5 mm) deep by 1-3/4" (45 mm) long should be cut to accommodate the sensor. The sensor should be located mid way between the heating elements to ensure a proper temperature reading.

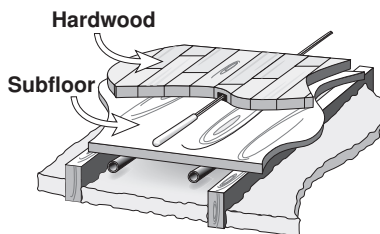

#### NOTICE

If it is not practical to cut a groove in the surface covering, follow the installation method used for thin floor coverings.

## Retrofit Installations

### Tile Floor Coverings

If a Floor Sensor 079 is to be installed into an existing tile floor with sufficiently large grout lines, the sensor and wire can be installed in one of the grout lines between the tiles. Select a low traffic area of the floor that is mid way between the heating elements for the sensor location. Ensure that the sensor is located in such a position that the attached wire is able to reach to a suitable junction location. Splices within the grout should be avoided to ensure trouble free operation. Remove the appropriate grout line and place the sensor and wire in the floor. Re-grout the area.

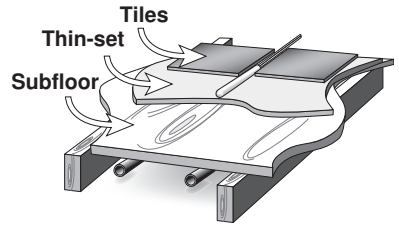

### Installing the Sensor to the Bottom of a Subfloor

If the sensor is to be installed to the bottom of a subfloor, cut a piece of 1" (25 mm) thick rigid insulation into a 6" (150 mm) by 6" (150 mm) square. A groove 3/16" (5 mm) wide by 3/16" (5 mm) deep by 1-3/4" (45 mm) long should be cut into the insulation to accommodate the sensor. Place the sensor in the groove and sandwich the sensor between the insulation and the subfloor. Use a suitable fastening method to affix the insulation to the subfloor.

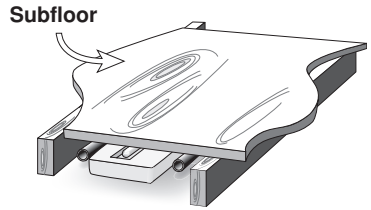

#### **⚠ CAUTION**

Do not run sensor wires parallel to telephone or power cables. If the sensor wires are located in an area with strong sources of electromagnetic interference, shielded cable or twisted pair should be used or the wires can be run in a grounded metal conduit. If using shielded cable, the shield wire should be connected to the Com terminal on the control and not to earth ground.

### Floor Sensor 079 Wiring

The Floor Sensor 079 is supplied with 10' (3 m) of cable. If a longer length is required, 24 AWG or larger wire can be spliced onto the two wires from the sensor. The splices should be properly soldered and protected in an accessible junction box. Follow the sensor testing instructions given in this brochure and then connect the wires to the control.

## Floor Sensor 079 Testing

A good quality test meter capable of measuring up to 5,000 k $\Omega$  (1 k $\Omega$  = 1000 $\Omega$ ) is required to measure the sensor resistance. In addition to this, the actual temperature must be measured with either a good quality digital thermometer, or if a thermometer is not available, a second sensor can be placed alongside the one to be tested and the readings compared.

First measure the floor temperature using the thermometer. Disconnect the S1 and Com wires from the thermostat. Using an electrical meter, measure the resistance of the S1 and Com wires at the thermostat location. Using the temperature versus resistance table, estimate the temperature measured by the sensor. The sensor measurement and thermometer readings should be close. If the test meter reads a very high resistance, there may be a broken wire, a poor wiring connection or a defective sensor. If the resistance is very low, the wiring may be shorted, there may be moisture in the sensor or the sensor may be defective. To test for a defective sensor, measure the resistance directly at the sensor location. Once the test has been completed, reconnect the S1 and Com wires to the thermostat.

### CAUTION

Do not apply voltage to a sensor at any time as damage to the sensor may result.

## Temperature vs. Resistance Table

Temperature		Resistance	Temperature		Resistance
°F	°C	$\Omega$	°F	°C	$\Omega$
-50	-46	490,813	35	2	29,996
-45	-43	405,710	40	4	26,099
-40	-40	336,606	45	7	22,763
-35	-37	280,279	50	10	19,900
-30	-34	234,196	55	13	17,436
-25	-32	196,358	60	16	15,311
-20	-29	165,180	65	18	13,474
-15	-26	139,402	70	21	11,883
-10	-23	118,018	75	24	10,501
-5	-21	100,221	80	27	9,299
0	-18	85,362	85	29	8,250
5	-15	72,918	90	32	7,334
10	-12	62,465	95	35	6,532
15	-9	53,658	100	38	5,828
20	-7	46,218	105	41	5,210
25	-4	39,913	110	43	4,665
30	-1	34,558	115	46	4,184

## Temperature vs. Resistance Table *Continued*

Temperature		Resistance	Temperature		Resistance
°F	°C	Ω	°F	°C	Ω
120	49	3,760	175	79	1,281
125	52	3,383	180	82	1,172
130	54	3,050	185	85	1,073
135	57	2,754	190	88	983
140	60	2,490	195	91	903
145	63	2,255	200	93	829
150	66	2,045	205	96	763
155	68	1,857	210	99	703
160	71	1,689	215	102	648
165	74	1,538	220	104	598
170	77	1,403	225	107	553

## Thermostat Wiring

### Zone Valve

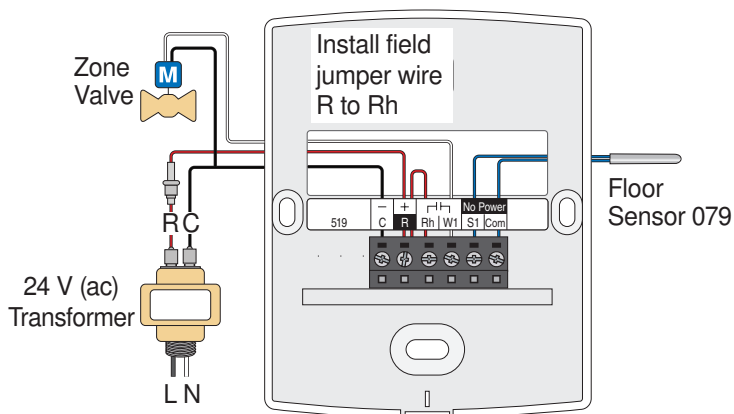



# 24-Volt Master Zone Control Module

24-Volt Master Zone Control Module for 14 Volt Actuators  
 Order: 81006626

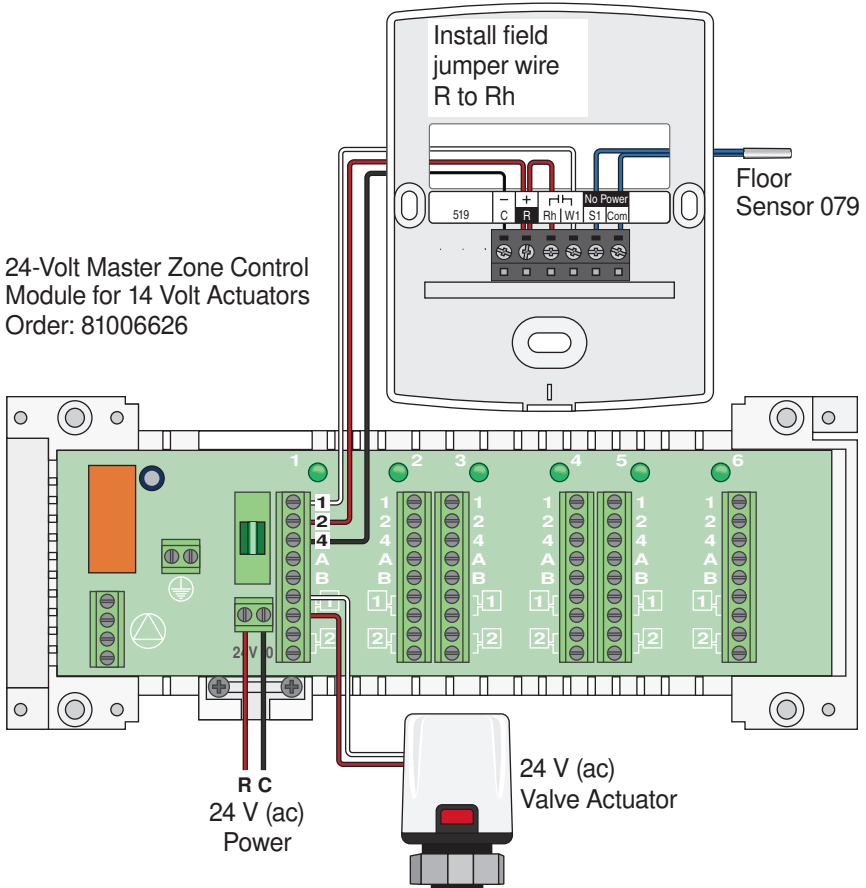

# Relay

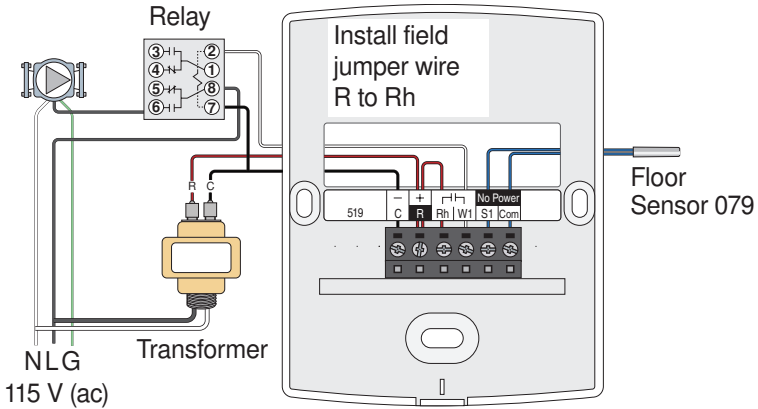

## Switching Relay

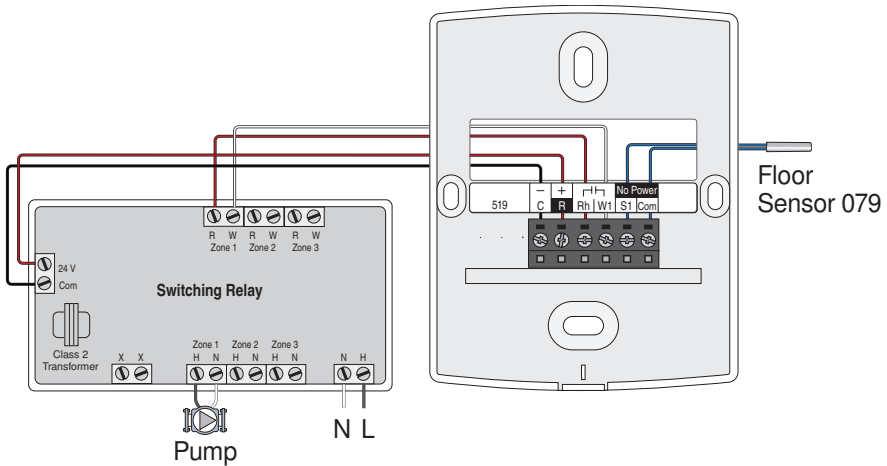

## Testing the Thermostat Wiring

### Testing the Power

If the thermostat display turns on, this indicates that the thermostat is operating correctly and there are no electrical issues. In the event that the display is permanently off:

1. Remove the thermostat front.
2. Use an electrical meter to measure voltage between the R and C wiring terminals. For AC power supplies the voltage should measure between 10 to 30 V (ac). For DC power supplies the voltage should measure between 10 to 30 V (dc).
3. If the voltage on the R and C wire terminations is continuous and the thermostat display is not on, the thermostat may have a fault. Contact your Watts Radiant sales representative for assistance.

If the thermostat display initially powers on but later shuts off intermittently, there may be a short circuit from the W1 wire to ground, or the power supply is too small to power the load.

### Testing the Heat Zone Output Wiring

1. Touch the  $\Delta$  button and set the heating temperature above the current room temperature. Make sure the display does not flash "Max" if using a floor sensor.
2. When the "Heat On" symbol appears on the display, use an electrical meter to check for voltage on the W1 and C wires connected to the zone valve, wiring center, relay or switching relay. The electrical meter should read 10 to 30 V (ac) or (dc).
3. If the W1 and C wire have voltage, check the zone valve, wiring center, relay or pump to determine if the heat device is operating correctly.

# User Interface

## Home Screen

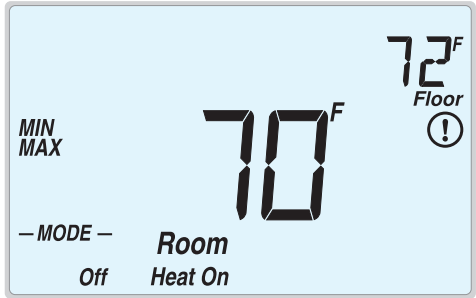

## Symbols Description

<p><i>Heat On</i>    <b>HEAT ON</b> Heat is turned on.</p>	<p><b>MIN</b> The floor is at or below the floor minimum temperature.</p>
<p><i>-MODE-</i>    <b>MODE OFF</b> <i>Off</i>    The heating system is off.</p>	
<p>    <b>WARNING SYMBOL</b> Indicates an error is present.</p>	<p><b>MAX</b> The floor has reached the floor maximum temperature.</p>

# Sequence of Operation

## Heating Operation

To change the heat temperature setting, push the  $\Delta$  or  $\nabla$  button to select a preferred temperature setting. The Heat On symbol is shown on the display when the thermostat is heating. The heat can cycle on and off within  $\pm 1.5^\circ\text{F}$  ( $1^\circ\text{C}$ ) of the temperature setting.

The floor and air heating can be shut off by holding the  $\nabla$  button until Set Room is Off. To resume heating when the Mode is Off, press the  $\Delta$  button to navigate to the Mode setting, then press the  $\Delta$  button to select Mode Heat. The thermostat will resume heating at the last previously set temperature.

### Air Temperature Only

If there is only an air temperature sensor (no floor sensor), the thermostat operates to control your desired air temperature.

### Floor Temperature Only

If the air sensor has been disabled, the thermostat will only maintain floor temperature and ignore air temperature. This operation is recommended for areas such as bathrooms to ensure that tile floors are warm to the touch.

### Floor and Air Temperature







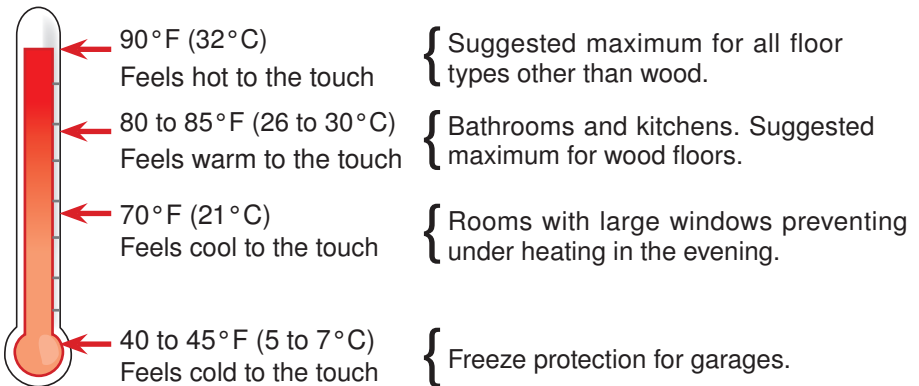



If the air sensor is turned on and a floor sensor is connected, the thermostat will maintain the desired air temperature as well as a minimum floor temperature.

This operation is recommended for areas with large windows that allow the sun to shine into a room and keep it warm without the need for heat. This can allow the floors to cool off during the afternoon. When the sun goes down, it can take a long time for the floors to get warm again. This may cause the room to cool off too much in the early evening. A floor minimum setting can help with this condition by maintaining a floor minimum temperature. Keep in mind the floor minimum temperature will override the air temperature, and if set too high, may overheat the room.

This operation is also recommended for rooms with hardwood floors. Setting floor minimum and maximum temperatures is a way of enhancing the comfort of the living space while protecting floor coverings.







# Programmable Settings

Setting	Display
<b>User settings. Press the <math>\Delta</math> and <math>\nabla</math> buttons together for 3 seconds to enter and advance to the next setting.</b>	
<b>MODE</b> Select heat or off.	
Range: HEAT, OFF	Default: HEAT
<b>UNITS</b> Select the temperature units.	
Range: °F or °C	Default: °F
<b>LIGHT</b> Select when the display back light should operate. Auto operates the backlight for 30 seconds after a keystroke.	
Range: OFF, AUTO, ON	Default: AUTO
<b>SET FLOOR</b> Set the floor minimum temperature. Available when an auxiliary floor sensor is connected and the built-in room sensor is on.	
Range: OFF, 40 to 122°F (4.5 to 50.0°C)	Default: 72°F (22.0°C)
<b>TYPE</b> Device Type number. Hold the $\Delta$ button to view the software version.	
<b>ESCAPE</b> Release the $\Delta$ and $\nabla$ buttons to return to the home screen.	
<b>Installer settings. Press the <math>\Delta</math> and <math>\nabla</math> buttons together for 5 more seconds.</b>	
<b>AUXILIARY SENSOR</b> Select the type of auxiliary sensor. Available when an auxiliary sensor is automatically detected.	
Range: <b>NONE</b> = no auxiliary sensor, <b>ROOM</b> = Indoor Sensor, <b>FLOR</b> = Slab Sensor, <b>OUT</b> = Outdoor Sensor	Default: OFF
<b>ROOM SENSOR</b> Select if the built-in room temperature sensor is on or off. The built-in room sensor can only be disabled when an auxiliary room or slab sensor is connected.	
Range: ON or OFF	Default: ON
<b>SET FLOOR MAXIMUM</b> Set the floor maximum temperature in order to protect the floor covering. Suggested settings: Tile = 90°F (32°C), Wood Floor = 85°F (29°C)	
Range: 40 to 122°F (4.5 to 50.0°C), OFF	Default: 85°F (29.5°C)
<b>ESCAPE</b> Release the $\Delta$ and $\nabla$ buttons to return to the home screen.	

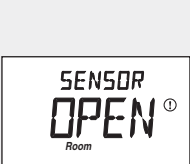
# Troubleshooting

## Error Messages

Error Message	Description
	<b>SETUP MENU SAVE ERROR</b> The thermostat failed to read the Programmable Settings from memory and has reloaded the factory default settings. The thermostat stops normal operation until all Programmable Settings are checked except to provide freeze protection.
	<b>ROOM SENSOR OPEN CIRCUIT ERROR</b> The built-in air temperature sensor has an open circuit fault. Do not confuse this error with the auxiliary room sensor short circuit error.  This error cannot be field repaired. Contact your wholesaler or Watts Radiant sales representative for details on repair procedures.
	<b>ROOM SENSOR SHORT CIRCUIT ERROR</b> The built-in air temperature sensor has a short circuit fault. Do not confuse this error with the auxiliary room sensor short circuit error.  This error cannot be field repaired. Contact your wholesaler or Watts Radiant sales representative for details on repair procedures.
	<b>AUXILIARY SENSOR OPEN CIRCUIT ERROR</b> The auxiliary sensor has an open circuit. Check for loose or damaged wires. Locate and repair the problem as described in the Sensor Testing section of this brochure. The error clears after the auxiliary sensor fault is corrected. If the auxiliary sensor was intentionally removed, power the thermostat down and up to clear the error.
	<b>AUXILIARY SENSOR SHORT CIRCUIT ERROR</b> The auxiliary sensor has a short circuit. Check for damaged wires. Locate and repair the problem as described in the Sensor Testing section of this brochure. The error clears after the auxiliary sensor fault is corrected.

## Frequently Asked Questions

Symptom	Look for...	Corrective Action
Display powering on and off.	Measure voltage at wiring terminals R and C.	The power supply transformer may have limited VA capacity. A transformer with a larger VA rating is recommended.
Thermostat does not heat.	Mode Off	Thermostat must be in Mode Heat in order to provide heating.

## Technical Data

### Radiant Thermostat 519 *Air/Floor, Digital, 24V, incl floor sensor 079*

Literature	IOM-WR-Radiant_Thermostat-519, PG-WR-Radiant_Thermostat-519, ES-WR-Radiant_Thermostat-519, IS-WR-Radiant_Thermostat-519
Control	Microprocessor control. This is not a safety (limit) control
Packaged weight	0.6 lb. (270 g)
Dimensions	3-11/16" H x 3" W x 15/16" D (94 x 76 x 24 mm)
Enclosure	White PVC plastic, NEMA Type 1
Approvals	Meets Class B: ICES & FCC Part 15
Ambient conditions	Indoor use only, 32 to 122°F (0 to 50°C), RH ≤90% non-condensing
Power supply	10 to 30 V (ac/dc), 50/60 Hz, 1.8 VA standby, 56 VA max fully loaded, Class 2
Relay	30 V (ac/dc) 2 A, Class 2 circuits
Sensor	NTC thermistor, 10 kΩ @ 77°F (25°C ±0.2°C) β=3892
– Included	Floor Sensor 079

### Floor Sensor 079, *extra*

Packaged weight	0.1 lb. (50 g)
Dimensions	3/16" OD x 1-1/2" (5 mm OD x 38 mm)
Sensor Material	316 stainless steel, 10' (3 m) 24 AWG, 300 volt PVC insulated Zipcord
Approvals	CSA C US
Operating range	-58 to 221°F (-50 to 105°C)
Sensor	NTC thermistor, 10 kΩ @ 77°F (25°C ±0.2°C) β=3892

**WARNING:** This product contains chemicals known to the State of California to cause cancer and birth defects or other reproductive harm.  
**For more information:** [www.watts.com/prop65](http://www.watts.com/prop65)

## Hydronic System Electronic Controls and Thermostats Limited Warranty

Watts Radiant (the Company) warrants its hydronic system electronic controls and thermostats (the Product) to be free from defects in materials and workmanship under normal usage for a period of one year from the documented date of installation of the Product. In the event of defects within the warranty period, the Company will replace the Product without charge. This remedy is the sole and exclusive remedy for breach of warranty. This warranty is transferable to subsequent owners.

Under this Limited Warranty, the Company will provide the following:

In order to make a claim, you must:

- (a) Provide the Company with sufficient details relating to the nature of the defect, the installation, the history of operation, and any repairs that may have been made.
- (b) At the Company's discretion and at the owner's expense, ship the Product to the Company or the Company's local representative or distributor.
- (c) Provide proof that the Product was installed in accordance with the applicable Product Installation Manual and any special written design or installation guidelines by the Company for this project.
- (d) Provide proof that the Product was installed in accordance with the National Electrical Code (NEC) or the Canadian Electrical Code (CEC), and all applicable local building and electrical codes.
- (e) Provide a retail sales receipt or proof of purchase.

The following are not covered by this Limited Warranty:

- (a) Any incidental or consequential damage, including inconvenience, loss of time or loss of income.
- (b) Any labor or materials required to repair or replace the Product that are not authorized in writing by the Company.
- (c) Any labor or materials required to remove, repair or replace materials other than the Products.
- (d) Any freight or delivery costs related to the Product or any related electrical products.

Watts Radiant assumes no responsibility under this Limited Warranty for any damage to the Product caused by any trades people, visitors on the job site, or damage caused as a result of post-installation work. This Limited Warranty shall be invalidated by any abuse, misuse, misapplication or improper installation of the Products. The staff at the Company is available to answer any questions regarding the proper installation or application of the Product at this toll-free phone number: 800-276-2419 (USA/International) or 888-208-8927 (Canada). If you are ever in doubt about the correct installation procedure to follow, or if the Product appears to be damaged, you must call us before proceeding with the installation or proposed repair.

WATTS RADIANT DISCLAIMS ANY WARRANTY NOT PROVIDED HEREIN, INCLUDING ANY IMPLIED WARRANTY OF MERCHANTABILITY OR IMPLIED WARRANTY OF FITNESS FOR A PARTICULAR PURPOSE. WATTS RADIANT FURTHER DISCLAIMS ANY RESPONSIBILITY FOR SPECIAL, INDIRECT, SECONDARY, INCIDENTAL, OR CONSEQUENTIAL DAMAGES ARISING FROM OWNERSHIP OR USE OF THIS PRODUCT, INCLUDING INCONVENIENCE OR LOSS OF USE. THERE ARE NO WARRANTIES WHICH EXTEND BEYOND THE FACE OF THIS DOCUMENT. NO AGENT OR REPRESENTATIVE OF WATTS RADIANT HAS ANY AUTHORITY TO EXTEND OR MODIFY THIS WARRANTY UNLESS SUCH EXTENSION OR MODIFICATION IS MADE IN WRITING BY A CORPORATE OFFICER.

Some states/provinces do not allow the exclusion or limitation of incidental or consequential damages and some states/provinces do not allow limitations on how long implied warranties may last. Therefore, the above limitations or exclusions may not apply to you. This warranty gives you specific legal rights and you may also have other rights, which vary from state to state or province to province. SO FAR AS IS CONSISTENT WITH APPLICABLE STATE/PROVINCIAL LAW, ANY IMPLIED WARRANTIES THAT MAY NOT BE DISCLAIMED, INCLUDING IMPLIED WARRANTIES OF MERCHANTABILITY OR FITNESS FOR A PARTICULAR PURPOSE ARE LIMITED IN DURATION TO ONE YEAR FROM THE DATE OF MANUFACTURE.

**Effective:** May 1, 2013. This warranty applies to all Products purchased after this date.

Authorized Distributor:

**warmyourfloor**<sup>TM</sup>  
the radiant floor heating experts<sup>TM</sup>  
customer@warmyourfloor.com  
(866) 558-3369

**WattsRadiant**<sup>TM</sup>

A Watts Water Technologies Company

USA: Springfield, MO • Tel. (800) 276-2419 • Fax: (417) 864-8161 • [www.wattsradiant.com](http://www.wattsradiant.com)

Canada: Burlington, ONT. • Tel. (905) 332-4090 • Fax: (905) 332-7068 • [www.watts.ca](http://www.watts.ca)