

Fast heating wire installation • Crack isolation • Waterproofing

Installation rapide de câble chauffant • Isolation des fissures • Imperméabilisation

Instalación cableada con calefacción rápida • Aislamiento de grietas • Impermeabilidad

HeatMatrix[™]

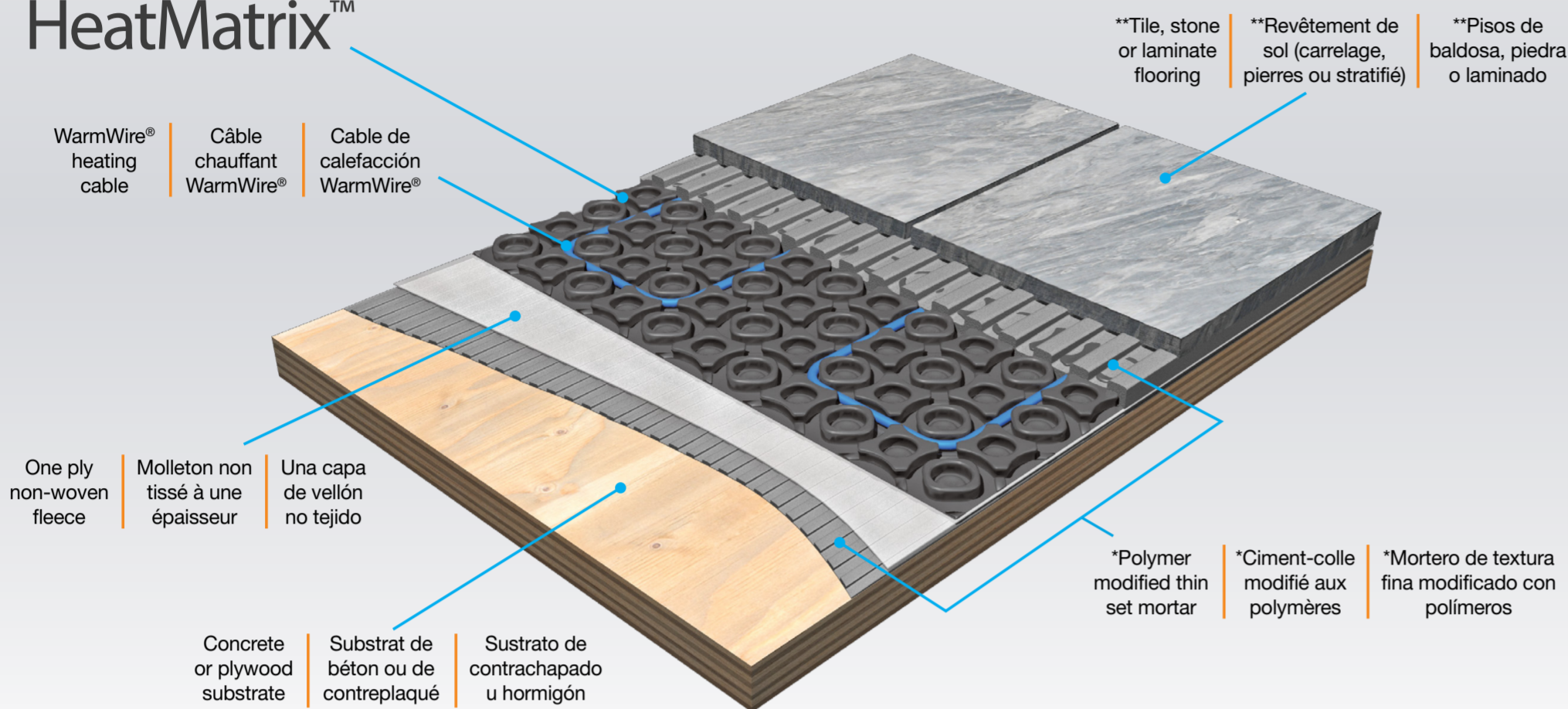

HeatMatrix

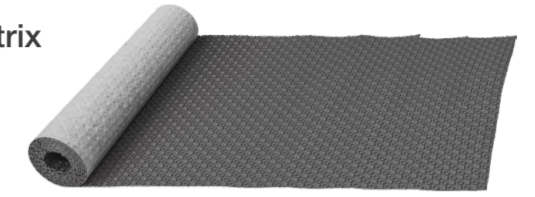

ft ² pi ² pies ²	m ²	L	W larg A	Order# # de commande Orden#	Model Modèle Modelo
161	15	49.2' (15m)	3.28' (1m)	81019454	8006GRY161-ST
40	1	12.2' (3.7m)	3.28' (1m)	81019455	8006GRY40-ST
10.2	.95	3.1' (.95m)	3.28' (1m)	81020013	8006GRY11-ST

HeatMatrix Joint Tape



ft ² pi ² pies ²	m ²	L	W larg A	Order# # de commande Orden#	Model Modèle Modelo
10.4	.96	25' (7.6m)	5" (.13m)	81019457	8001GRY25R-ST

Approximately 3" (7.6 cm) cable spacing: for most efficient heat distribution.

Versatile heating cable capability: Spacing can be adjusted to match floor and room heating needs. Alternate between 2" and 3" (5 and 7.6 cm) spacing for high heat loss areas or between 3 and 4" (7.6 and 10 cm) for lower heat loss areas. 3" (7.6 cm) spacing is the standard.

Lightweight uncoupling with shear stress control: One-ply non-woven fleece under the membrane neutralizes stress caused by movement in the substrate.

0.24" (6 mm) thick membrane: Can be used without heating cables as an uncoupling membrane for matching up to higher floors to achieve a level transition.

Waterproofing: Protects the substrate from moisture penetration and water seepage.

Vapor management system: Deep groove air channels above the fleece layer provide a path for moisture to dissipate. Well suited for below-grade installations.

Espacement des câbles d'environ 3 po (7,6 cm) pour une diffusion de chaleur avec une efficacité optimale.

Câble chauffant polyvalent : Possibilité de choisir l'espacement selon le revêtement de sol et les besoins de chauffage ambiant. Choisissez un espacement entre 2 po et 3 po (5 et 7,6 cm) dans les zones à fortes pertes de chaleur ou un espacement entre 3 po et 4 po (7,6 et 10 cm) dans les zones à faibles pertes de chaleur. L'espacement standard est de 3 (7,6 cm) pouces.

Désolidarisation légère avec contrôle de la tension de cisaillement : Molleton non tissé à une épaisseur sous la membrane neutralisant la tension causée par les mouvements du substrat.

Membrane de 0,24 po (6 mm) : Possibilité d'utilisation sans câble chauffant à titre de membrane de désolidarisation pour les transitions de hauteur de revêtement de sol.

Imperméabilisation : Protège le substrat contre les suintements et les infiltrations d'eau.

Système de gestion de vapeur : Conduits d'air profonds au-dessus du molleton pour permettre la dissipation de l'humidité. Convient aux installations sous le niveau du sol.

Aproximadamente 3 pulg. (7,6 cm) de espacio de cable: para una distribución más eficaz del calor.

Capacidad de cable de calefacción versátil: El espacio puede ajustarse según las necesidades de calefacción del piso y del ambiente. Alterne entre espacios de 2 y 3 pulg (5 y 7,6 cm) para áreas de gran pérdida de calor o entre 3 y 4 pulg (7,6 y 10 cm) para áreas de menor pérdida de calor. El espacio estándar es de 3 pulg (7,6 cm).

Desacoplamiento liviano con control de esfuerzo de corte: Una capa de vellón no tejido debajo de la membrana neutraliza la tensión que provoca el movimiento en el sustrato.

Membrana gruesa de 0,24 pulg. (6 mm): Puede usarse sin cables de calefacción como membrana de desacoplamiento para ajustarse a pisos más altos y lograr la transición de nivel.

Impermeabilidad: Protege el sustrato de la penetración de humedad y la filtración de agua.

Sistema de administración del vapor: Los canales de aire con ranura profunda sobre la capa de vellón ofrecen una vía de disipación de la humedad. Apto para instalaciones debajo del nivel del suelo.

PLANNING | PLANIFICATION | PLANIFICACIÓN

Step 1 Calculate the area of the floor to be heated.

- Measure total wall-to-wall area of the room and subtract the square footage of all built-ins (tub, toilet, cabinets, etc.)
- Multiply this area by 0.9 and round to the nearest 5ft² (0.46m²). This is the heated area.
- Select the appropriate WarmWire size that covers your needs based on the square footage of the heated area.

Step 2 Calculate the area of the room to be tiled.

- Measure total wall-to-wall area of the room and include the square footage of any built-ins (tubs, toilet, cabinets, etc.) where HeatMatrix will be installed.
- Select the appropriate HeatMatrix roll that covers your needs based on the total square footage of the tiled area.

Étape 1 Calculez la superficie de sol à chauffer.

- Mesurez d'abord la superficie totale mur-à-mur de la pièce, puis soustrayez la superficie des éléments (baignoire, toilette, armoires, etc.)
- Multipliez cette superficie par 0,9 et arrondissez le résultat au multiple de 5 pieds carrés le plus près (0,46 m²). Vous avez alors la superficie chauffée.
- Choisissez la grosseur appropriée de câble WarmWire correspondant à vos besoins, selon la superficie de la zone chauffée.

Étape 2 Calculez la superficie de carrelage à installer.

- Mesurez d'abord la superficie totale mur-à-mur de la pièce en incluant la superficie des éléments (baignoire, toilette, armoires, etc.) où la membrane HeatMatrix sera installée.
- Choisissez le rouleau approprié de membrane HeatMatrix correspondant à vos besoins, selon la superficie totale du carrelage.

Paso 1 Calcule el área del piso que desea calefaccionar.

- Mida el área total de la habitación de pared a pared y reste los pies cuadrados que ocupan todos los muebles empotrados (bañera, inodoro, gabinetes, etc.)
- Multiplique esta área por 0,9 y redondee al valor 5 pies² (0,46 m²) más cercano. Esta es el área de calefacción.
- Seleccione el tamaño de WarmWire adecuado para cubrir sus necesidades según los pies cuadrados del área de calefacción.

Paso 2 Calcule el área de la habitación que desea cubrir con baldosas.

- Mida el área total de la habitación de pared a pared y reste los pies cuadrados que ocupan todos los muebles empotrados (bañera, inodoro, gabinetes, etc.) donde se instalará HeatMatrix.
- Seleccione el tamaño de HeatMatrix adecuado para cubrir sus necesidades según los pies cuadrados totales del área para cubrir con baldosas.

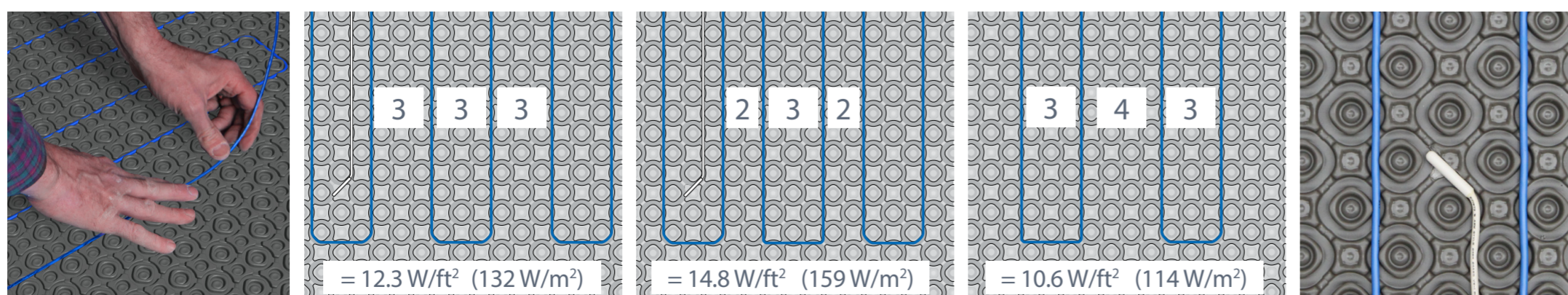

MATERIALS AND TOOLS REQUIRED FOR INSTALLATION

- Premium modified thin set mortar
- Notched trowel
- Hand roller or grout float

* modified or non-modified thin-set mortar as recommended by the tile manufacturer. Refer to mortar manufacturer specifications to ensure product selected is suitable for use over an uncoupling membrane.

** 2 by 2 inch minimum tile size

MATÉRIAUX ET OUTILS NÉCESSAIRES POUR L'INSTALLATION

- Ciment-colle modifié de qualité supérieure
- Truelle brettée
- Rouleau à main ou taloche à joints

* ciment-colle modifié ou non modifié, selon les recommandations du fabricant de carrelage. Consulter les spécifications du fabricant de ciment-colle afin de vérifier que le produit choisi peut être appliqué sur une membrane de désolidarisation.

** 2 par 2 pouces de taille minimum de carreaux

MATERIALES Y HERRAMIENTAS NECESARIAS PARA LA INSTALACIÓN

- Mortero de textura fina premium modificado
- Llana dentada
- Rodillo manual o talocha

* mortero de textura fina modificado o no modificado, según la recomendación del fabricante de baldosas. Consulte las especificaciones del fabricante de morteros para asegurarse de que el producto seleccionado sea adecuado para el uso con una membrana de desacoplamiento.

** tamaño mínimo de azulejo de 2 por 2 pulgadas

10 Year performance /
25 year composition warranty
Garantie de 10 ans sur le rendement /
25 ans sur la composition
Garantía de 10 años de desempeño /
25 años para la composición

NOTICE

- Read the WarmWire and SunStat manuals prior to installing
- Install floor heating sensor at least 1' (305 mm) into the area to be heated between two of the heating cables.
- Do not allow the sensor wire to cross over heating wire.
- Do not cross the heating wires or install less than 2" (51 mm) from each other. Dangerous overheating can result.
- Never cut the heating wire.
- Follow the WarmWire manual testing instructions before installing tile.
- Protect the WarmWire / HeatMatrix assembly against heavy mechanical loads prior to tile installation.

AVIS

- Avant de débiter l'installation, lisez le manuel des produits WarmWire et SunStat.
- Installez le capteur thermique de sol à 12 po (30 cm) ou plus du bord de la zone à chauffer, entre deux câbles chauffants.
- Assurez-vous que le fil du capteur ne passe pas sur le câble chauffant.
- Les câbles chauffants doivent être espacés d'au moins 2 pouces (51 mm) sans jamais se croiser. Une sur-chauffe dangereuse pourrait survenir.
- Ne coupez jamais le câble chauffant.
- Avant d'installer le carrelage, exécutez les vérifications décrites dans le manuel WarmWire.
- Avant l'installation du carrelage, l'assemblage Warm-Wire/HeatMatrix doit être protégé des charges lourdes.

AVISO

- Lea los manuales de WarmWire y SunStat antes de realizar la instalación.
- Instale el sensor de calefacción de piso al menos a 1 pie (30 cm) del área que desea calefaccionar, entre dos de los cables de calefacción.
- No permita que el cable del sensor se entrecruce con el cable de calefacción.
- No cruce los cables de calefacción ni los instale a menos de 2 pulg. (51 mm) entre sí. Es posible que provoque un sobrecalentamiento peligroso.
- Nunca corte el cable de calefacción.
- Siga las instrucciones de pruebas manuales de WarmWire antes de instalar las baldosas.
- Proteja el conjunto de WarmWire/HeatMatrix de cargas mecánicas pesadas antes de la instalación de las baldosas.

HeatMatrix JointTape

In potentially high moisture areas, apply JointTape after the WarmWire® heating cable is installed into the HeatMatrix uncoupling membrane. Using a 1/4" x 1/4" (6 x 6 mm) notched trowel, apply mortar over the joint and press the JointTape into the mortar with the flat side of the trowel. Make sure the tape is centered over the joint and has full coverage of mortar. Apply the JointTape from edge to edge over all joints.

For further moisture protection, JointTape can be installed at the edge of HeatMatrix along a wall by folding it to maintain at least 2" (5 cm) overlap on the wall. Use mortar to secure it in place and follow the same steps to ensure it has complete mortar coverage between JointTape and the wall and HeatMatrix.

Step 1 Preparation

HeatMatrix is recommended for use with WarmWire® heating cables. Details about wire, sensor and thermostat placement are included in the WarmWire manual. **Read the manual before installing WarmWire.** The substrate must be flat, clean, dry, structurally sound, adequately load bearing and free from material which may prevent bonding with the cement mortar. The type of mortar used to secure the membrane to the subfloor depends on the type of substrate. For most substrates, a premium modified thinset mortar is recommended. When selecting mortar for use under the tile, refer to the manufacturers guidelines to ensure the product selected is suitable for use over an uncoupling membrane, and is compatible with the tile selected.

Étape 1 Préparation

Il est recommandé d'utiliser une membrane HeatMatrix soit utilisée avec les câbles chauffants WarmWire®. Le manuel WarmWire contient des informations détaillées sur le positionnement du câble chauffant, du capteur thermique et du thermostat. Lisez attentivement ce manuel avant d'installer le câble chauffant WarmWire. Le substrat doit être plat, propre, sec, structurellement solide, être capable de supporter un poids approprié et n'avoir sur sa surface aucune substance pouvant nuire à l'adhésion du ciment-colle. Le type ciment utilisé pour coller la membrane dépend du type de substrat. Un ciment-collé modifié de qualité supérieure est recommandé pour la plupart des substrats. Au moment de choisir le ciment devant être appliqué sous le carrelage, consultez les directives du fabricant pour vous assurer que le produit choisi peut être appliqué sur une membrane de désolidarisation et qu'il est compatible avec le carrelage installé.

Paso 1 Preparación

Se recomienda usar HeatMatrix con cables de calefacción WarmWire®. En el manual de WarmWire se incluyen detalles sobre el posicionamiento de los cables, sensores y el termostato. Lea el manual antes de instalar WarmWire. El sustrato debe ser plano y debe estar limpio, seco y en buen estado estructural, debe poder soportar adecuadamente la carga y no debe contener materiales que puedan evitar la adhesión con el mortero de cemento. El tipo de mortero usado para fijar la membrana al subsuelo depende del tipo de sustrato. Para la mayoría de los sustratos, se recomienda el mortero de textura fina premium modificado. Cuando seleccione un mortero para usar debajo de la baldosa, consulte las pautas del fabricante para asegurarse de que el producto seleccionado sea adecuado para el uso con una membrana de desacoplamiento y sea compatible con la baldosa seleccionada.

Step 2 Membrane Installation

Measure and cut HeatMatrix to the required length for each row. Mark the boundary edge on the subfloor to use as a guide for mortar application. Apply the mortar for the first row cut 1/4" x 1/4" (6 x 6 mm) notched trowel. Place the tile with a length of HeatMatrix over the mortar. Position membrane, then readjust alignment if necessary by lifting one end, and pulling lightly. **Do not leave gaps between sections of HeatMatrix.** Work HeatMatrix in using a float or flat trowel. The entire surface of the fleece on the underside of the membrane should be securely bonded to the mortar. Observe the mortar open time while working. Trim out any rough drain openings or other obstructions if necessary. Repeat the application process for each row until the space to be tiled is completely covered.

Étape 2 Installation de la membrane

Mesurez et coupez la membrane HeatMatrix à la longueur appropriée pour chaque rang. Marquez la position du bord de la membrane sur le substrat pour guider l'application du ciment-colle. Appliquez le ciment du premier rang avec une truelle brettée de 1/4 po x 1/4 po (6 x 6 mm). Placez la longueur coupée de membrane HeatMatrix sur le ciment. Positionnez la membrane et corrigez l'alignement si nécessaire en soulevant une extrémité tout en tirant légèrement. **Ne laissez aucun espace entre les segments de membrane HeatMatrix.** Appuyez sur toute la superficie de la membrane HeatMatrix avec une taloche à joints ou une truelle plate. Toute la surface du molleton sous la membrane devrait être solidement collée sur le ciment. N'oubliez pas de respecter le temps d'ouverture du ciment lorsque vous travaillez. Découpez le contour des orifices de drainage rugueux et les autres obstacles, s'il y a lieu. Répétez la procédure d'application sur chaque rang de membrane jusqu'à ce que vous ayez terminé toute la superficie devant être carrelée.

Paso 2 Instalación de la membrana

Mida y corte HeatMatrix según la longitud que desee para cada fila. Marque el borde del subsuelo para usarlo como guía en la aplicación del mortero. Aplique el mortero para la primera fila con una llana dentada de 1/4 pulg. x 1/4 pulg. (6 x 6 mm). Coloque la longitud cortada de HeatMatrix sobre el mortero. Coloque la membrana, levante un extremo y tire suavemente para reajustar la alineación, si fuera necesario. **No deje espacios entre las secciones de HeatMatrix.** Inserte HeatMatrix con una llana lisa o flotante. Toda la superficie del vellón ubicada en la parte inferior de la membrana debe estar adherida de manera segura al mortero. Observe el tiempo de fraguado del mortero. Reduzca cualquier abertura de drenaje u obstrucción irregular, si fuera necesario. Repita el proceso de aplicación para cada fila hasta que el espacio quede completamente cubierto con baldosas.

Step 3 Heating Cable Installation

Consult the WarmWire instruction manual before installing wire. Begin by inserting the wire nearest to the power lead into the membrane channels. (A hand roller or grout float may be used to aid in installation). For the standard heat output, space the wire in rows 3 shapes apart. If the area has high heat loss, heating output can be increased by alternating between 3 and 2 shape spacing. If the area does not require very much heat, output can be lowered by alternating between 3 and 4 shapes. Continue installing until all wire is in place. **Do not cut the heating wire** if extra is left over after covering the space. Adjust the layout to use up the extra length, or route the wire into areas around the HeatMatrix perimeter if necessary.

Étape 3 Installation du câble chauffant

Avant de débiter l'installation du câble, lisez le manuel WarmWire. Insérez d'abord le câble dans les rainures de la membrane tout près du fil d'alimentation électrique (Pour faciliter l'installation, vous pouvez utiliser un rouleau à main ou une taloche à joints). Pour une puissance de chauffage ordinaire, comptez 3 formes rainurées entre chaque ligne de câble. Si la zone est sujette à de fortes pertes de chaleur, alternez entre 3 et 2 formes rainurées pour séparer les lignes de câble. Si la pièce ne perd pas beaucoup de chaleur, la puissance de chauffage peut être diminuée en alternant entre 3 et 4 formes pour séparer les lignes de câble. Continuez l'installation jusqu'à ce que tout le câble soit en place. S'il reste une longueur de câble après avoir terminé, ne le coupez pas. Modifiez la configuration du câble installé afin d'utiliser la longueur restante. Vous pouvez même installer du câble sur le périmètre de la membrane HeatMatrix si nécessaire.

Paso 3 Instalación de cables de calefacción

Consulte el manual de instrucciones de WarmWire antes de instalar los cables. Para comenzar, inserte el cable más cercano al cable de alimentación en los canales de la membrana. (Puede usar un rodillo manual o una taloche para facilitar la instalación). Para la salida de calor estándar, coloque el cable en filas cada 3 figuras. Si el área presenta gran pérdida de calor, la salida de calor puede aumentar si se alterna el espacio entre 3 y 2 figuras. Si el área no requiere mucho calor, la salida puede disminuir si se alterna entre 3 y 4 figuras. Continúe la instalación hasta colocar todos los cables debidamente. No corte el cable de calefacción si queda longitud adicional después de cubrir el espacio. Ajuste la disposición para aprovechar la longitud adicional o pase el cable por las áreas que rodean el perímetro de HeatMatrix, si fuera necesario.

Step 4 Tile Installation

After the WarmWire has been tested, the tiles may be laid on top of the HeatMatrix using a thin-bed method. It is advisable to apply the mortar in a single process. Fill voids with flat side of the trowel first, then add a combed layer with the notched side. Ensure 100% coverage while taking precautions to not damage the heating cables. Avoid lining up tile grout lines with the joints between sections of HeatMatrix. Match the notch size of the trowel to the type and size of tile and observe the open time of mortar as per manufacturer specifications. Grout can be applied following the mortar manufacturers recommended wait time. Ensure the mortar is fully cured before operating the heating system. If heat is applied too soon it can interfere with proper curing of the mortar.

Laminate / Floating Wood Installation

Fill the voids in the HeatMatrix with the flat of the trowel, let fully cure, then lay the required underlayment and flooring on top.

Étape 4 Installation du carrelage

Lorsque le câble chauffant WarmWire a été testé, le carrelage peut être installé sur la membrane HeatMatrix en utilisant une technique de pose à couche mince. Il est recommandé d'appliquer le ciment d'une seule traite. Remplissez d'abord les creux avec le côté plat de la truelle, puis ajoutez une couche peignée avec le côté denté. Assurez-vous de couvrir toute la surface en faisant attention de ne pas endommager le câble chauffant. Évitez d'aligner les joints des carreaux avec les joints des sections de membrane HeatMatrix. Assurez-vous que le côté denté de la truelle est adapté au type et aux dimensions des carreaux, sans oublier de respecter le temps d'ouverture du ciment indiqué par le fabricant. Le coulis peut être appliqué après avoir respecté le temps d'attente recommandé par le fabricant du ciment. Assurez-vous que le ciment a entièrement durci avant de débiter l'utilisation du système de chauffage. Une utilisation trop hâtive du système de chauffage pourrait nuire au durcissement du ciment.

Installation sur du laminé/bois flottant

Remplissez les vides dans le HeatMatrix avec le plat de la truelle, laissez complètement sécher, puis posez la sous-couche requise et le plancher par-dessus.

Paso 4 Instalación de baldosas

Una vez que haya sometido WarmWire a pruebas, las baldosas pueden colocarse sobre HeatMatrix mediante un método de capa delgada. Se aconseja aplicar el mortero en un solo proceso. Llène los espacios vacíos primero con el lado plano de la llana y luego agregue una capa peinada con el lado dentado. Asegúrese de cubrir el 100% y tomar las precauciones necesarias para no dañar los cables de calefacción. Evite formar filas con las líneas de lechada de las baldosas y las juntas entre secciones de HeatMatrix. Haga coincidir el tamaño de la muesca de la llana con el tipo y el tamaño de baldosa, y respete el tiempo de fraguado del mortero según las especificaciones del fabricante. Es posible aplicar lechada después del período de espera que recomienda el fabricante del mortero. Asegúrese de que el mortero esté completamente curado antes de poner el sistema de calefacción en funcionamiento. Si se aplica calor demasiado pronto, es posible que interfiera en el curado correcto del mortero.

Instalación de madera laminada o flotante

Llene los huecos en la membrana HeatMatrix con el lado plano de la paleta, permita que se fragüe por completo, luego coloque el contrapiso necesario y el piso encima.

WARRANTY | GARANTIE | GARANTÍA

Watts Radiant (the "Company") warrants that its SunTouch® and Watts Radiant® WarmWire® HeatMatrix™ membrane (the Product) will meet all composition criteria for twenty-five (25) years from the date of manufacture. Additionally, the Company warrants that the Product will conform to its performance criteria for ten (10) years from the date of purchase. This Limited Warranty extends only to the original owner and is not transferable.

Under this Limited Warranty, the Company will provide the following:

If, upon inspection, the Company determines that the Product fails to meet the warranty described above, the Company will, in its sole discretion; either (1) reinstall or replace the failed portion of the floor covering system (defined below) of which the Product is a part OR (2) pay to the owner an amount up to, but not exceeding, the original cost per square foot for the failed portion of the floor covering system, plus a reasonable labor allowance as determined by the Company. In the event the Company elects the warranty set forth in clause (2), then if the warranty claim is made within the first five (5) years of the warranty period, the Company shall reimburse the owner for 100% of the original cost per square foot for the failed floor covering system. If the warranty claim is made thereafter, then the Company shall reimburse the owner for a prorated amount of such original cost, based on a diminishing 10-year scale.

For example:

a. If the Product is found defective in the fourth year of the warranty period, then the owner shall be reimbursed for 100% of the original cost described above.

b. If the Product is found defective in the eighth year of the warranty period, then the owner shall be reimbursed for two-thirds of the original cost described above.

c. Use and install the Product in accordance with the American National Standards Institute (ANSI) standards and guidelines specified by the Tile Council of North America (TCNA).

d. Allow the Company, at its discretion, to inspect the floor covering system installation and obtain prior written authorization from the Company for any labor allowance or materials reimbursement before commencing any work or repairs. For any claim that is not valid, the Company shall be reimbursed for reasonable charges, including travel and labor, associated with investigation of such claim.

The following are not covered by this Limited Warranty:

- Efflorescence is considered to be a natural occurrence with cementitious materials and is therefore not considered to be a defective condition and is not covered by this Limited Warranty.
- Failure in the supporting structure and/or subfloor.
- Improper storage, maintenance or installation of the Product.
- Any Product subjected to misuse/abuse, lack of maintenance, or use other than that for which the Products were manufactured.
- Claims or damages resulting from altered or modified Product.
- Any incidental or consequential damage, including inconvenience, loss of time or loss of income.
- Any labor or materials required to repair or replace the Product that were not authorized in writing in advance by the Company.
- Any freight or delivery costs related to the Product or any related flooring or electrical products.
- Any damage to the Product caused by any tradespeople, visitors on the job site or post-installation work. The Company's customer service staff is available to answer any questions regarding the installation or application of the Product at this toll-free number: (800) 276-2419. If you are ever in doubt about the correct installation procedure to follow, or if the Product appears to be damaged, you must call us before proceeding with the installation or proposed repair.

Acceptable Materials and Conditions

This Limited Warranty covers Products installed in indoor applications only. It is the responsibility of the owner/installer to ensure the suitability of the Product and associated building and installation materials for the owner's intended use. It is recommended that the owner consults and/or obtains the services of an experienced and professional installer.

In case an owner/installer installs WarmWire HeatMatrix with a heating cable other than the Company's WarmWire, a twenty-five (25) year composition limited warranty and five (5) year performance warranty will apply to the WarmWire HeatMatrix only when the other heating cable's specifications are comparable to those of WarmWire, including those related to performance and physical properties, and such heating cable is certified by a recognized third-party testing agency. At no time and under no circumstances will the Company be liable or responsible for any failures caused by electrical heat cable not manufactured or sold by the Company or any other components or materials sold by another manufacturer other than the Company.

Disclaimers

THE COMPANY DISCLAIMS ANY OTHER WARRANTY NOT PROVIDED HEREIN, EXPRESS OR IMPLIED, INCLUDING THE IMPLIED WARRANTIES OR CONDITIONS OF MERCHANTABILITY OR FITNESS FOR A PARTICULAR PURPOSE. THE COMPANY FURTHER DISCLAIMS ANY RESPONSIBILITY FOR SPECIAL, INDIRECT, SECONDARY, INCIDENTAL OR CONSEQUENTIAL DAMAGES ARISING FROM OWNERSHIP OR USE OF THIS PRODUCT, INCLUDING INCONVENIENCE OR LOSS OF USE. THERE ARE NO WARRANTIES WHICH EXTEND BEYOND THE FACE OF THIS DOCUMENT. NO AGENT OR REPRESENTATIVE OF THE COMPANY HAS ANY AUTHORITY TO EXTEND OR MODIFY

THIS WARRANTY UNLESS SUCH EXTENSION OR MODIFICATION IS MADE IN WRITING BY A CORPORATE OFFICER. Acts of God, including but not limited to flooding, hurricane, tornado, and earthquakes, acts of war, terrorism, intentional acts of destruction and fire shall not be covered under this Limited Warranty. Damage due to structural movement, excessive deflection, or other failure of the substrate and damage to structural or subfloor elements from water are also not covered under this warranty. The Company is not responsible for any items not sold by the Company. Products manufactured by another company should be reported to that manufacturer for its warranty response.

Some states do not allow the exclusion or limitation of incidental or consequential damages, and some states do not allow limitations on long implied warranties may exist. Therefore, the above limitations or exclusions may not apply to you. This warranty gives you specific legal rights, and you may also have other rights which may apply from state to state.

Effective Date: June 1, 2016. This Limited Warranty applies to all Products purchased after this date.

Watts Radiant (« l'entreprise ») garantit que ses membranes SunTouch® et Watts Radiant® WarmWire® HeatMatrix™ (« les produits ») respectent tous les critères de composition pendant vingt-cinq (25) ans à compter de leur date de fabrication. En outre, l'entreprise garantit que les produits respectent leurs critères de rendement pendant dix (10) ans à compter leur date d'achat. Cette garantie limitée s'applique uniquement au propriétaire original et n'est pas transférable.

Dans le cadre de cette garantie limitée, l'entreprise offre les services suivants :

Si après inspection, l'entreprise détermine qu'un produit n'est pas conforme à la garantie énoncée ci-dessus, l'entreprise choisira à sa discrétion de (1) réinstaller ou remplacer la partie défectueuse du système de revêtement de sol (voir définition ci-dessous) dont le produit fait partie OU (2) verser au propriétaire un dédommagement approprié ne dépassant pas le coût original par pied carré de la partie défectueuse du système de revêtement de sol, plus un montant raisonnable pour la main-d'œuvre, à la discrétion de l'entreprise. Si l'entreprise choisit la solution (2) et que la réclamation sous garantie est présente durant les cinq (5) premières années de la garantie, l'entreprise remboursera au propriétaire 100 % du coût original par pied carré de la partie défectueuse du système de revêtement de sol. Si la réclamation sous garantie est présente après un délai de cinq (5) ans, l'entreprise versera au propriétaire un remboursement proportionnel à la durée restante d'un cycle de dix (10) ans.

- Exemples :**
- Si le produit s'avère défectueux durant la quatrième année de la garantie, le propriétaire sera remboursé à hauteur de 100 % du coût original, conformément aux indications ci-dessus.
 - Si le produit s'avère défectueux durant la huitième année de la garantie, le propriétaire sera remboursé

à hauteur de 20 % du coût original, conformément aux indications ci-dessus.

Dans le cadre de la présente garantie limitée, l'expression « système de revêtement de sol » signifie le produit, le revêtement de sol au-dessus du produit et les matériaux adhésifs ou de fixation utilisés pour installer le produit et le revêtement de sol. De son intervention, l'entreprise réinstalle tous les matériaux de revêtement de sol affectés qu'elle considère réutilisables. À cause de facteurs échappant au contrôle de l'entreprise, notamment en ce qui concerne la disponibilité des rouleaux et des motifs, l'abandon de certains styles par les fabricants et l'usure normale des matériaux, l'entreprise ne peut garantir une concordance parfaite des matériaux de remplacement avec les matériaux existants.

Pour avoir droit aux protections de la garantie limitée, vous devez vous conformer aux obligations suivantes :

- Contactez l'entreprise dans un délai de 30 jours après la découverte d'un défaut sur un produit.
- Fournir la preuve que le produit a été installé en respectant les instructions d'installation WarmWire HeatMatrix, ainsi que les instructions écrites spéciales de conception ou d'installation fournies par l'entreprise pour ce projet.
- Utiliser et installer le produit conformément aux normes et directives de l'ANSI (American National Standards Institute) et du TCNA (Tile Council of North America).
- Autoriser l'entreprise à inspecter à sa discrétion le système de revêtement de sol installé, ainsi qu'à obtenir une autorisation écrite de l'entreprise concernant tout remboursement de matériaux et de frais de main-d'œuvre avant de débiter des travaux ou réparations. Si une réclamation est jugée non valide,

l'entreprise pourra exiger le remboursement de ses frais raisonnables, incluant les frais de déplacement et de main-d'œuvre associés aux vérifications de cette réclamation.

Les éléments suivants ne sont pas couverts par cette garantie limitée :

- Efflorescence est un phénomène pouvant se manifester naturellement sur des matériaux à base de ciment et ne constitue donc pas un défaut couvert par cette garantie limitée.
- Défaît de la structure d'appui ou du substrat.
- Négligence lors de l'entreposage, de l'entretien ou de l'installation du produit.
- Produit ayant fait l'objet d'une mauvaise utilisation, d'un usage abusif, d'un entretien défectif ou d'une autre utilisation que celle prévue par le fabricant.
- Réclamations ou dommages résultant d'un produit modifié ou altéré.
- Tout dommage accessoire ou indirect, notamment les inconvénients, la perte de temps et la perte de revenus.
- Toute main-d'œuvre ou tout matériel utilisé pour réparer ou remplacer le produit, sans autorisation écrite de l'entreprise.
- Tout frais de transport ou d'expédition relatif au produit ou aux produits de revêtement de sol ou électriques associés.
- Tout dommage au produit causé par des ouvriers, par des visiteurs sur le site d'installation ou par des travaux après l'installation.

Esta garantía limitada no cubre lo siguiente:

- La eflorescencia se considera un hecho natural con materiales cementosos. Por ende, no se considera un defecto y no está cubierta por esta garantía limitada.
- Una falla del subsuelo y/o la estructura de soporte.
- El almacenamiento, el mantenimiento o la instalación inadecuados del Producto.
- Cualquier producto que esté sujeto al uso incorrecto o al abuso, a la falta de mantenimiento o a un uso contrario al previsto por el fabricante de los Productos.
- Los reclamos o daños que provengan de un Producto alterado o modificado.
- Cualquier daño incidental e indirecto, incluidos inconvenientes, pérdida de tiempo o lucro cesante.
- Cualquier tarea de mano de obra o materiales requeridos para reparar o reemplazar el Producto que la compañía no haya autorizado por escrito y con anticipación.
- Cualquier costo de transporte o entrega relacionado con el Producto o cualquier producto eléctrico o de pisos relacionado.
- Cualquier daño al Producto ocasionado por comerciantes, visitantes al lugar de trabajo o daño resultante de un trabajo realizado después de la instalación.

El personal de atención al cliente de la Compañía está disponible para responder cualquier consulta relacionada con la instalación o aplicación del Producto en el siguiente número telefónico gratuito: (800) 276-2419. Si alguna vez tiene dudas sobre el procedimiento para la correcta instalación o si el Producto parece estar dañado, primero debe comunicarse con nosotros antes de proceder con la instalación o la reparación propuesta.

Watts Radiant (la "Compañía") garantiza que su sistema SunTouch® y membrana Watts Radiant® WarmWire® HeatMatrix™ (el Producto) cumplirán con los criterios de composición durante veinticinco (25) años a partir de la fecha de fabricación. Además, la Compañía garantiza que el Producto cumplirá con los criterios de desempeño durante diez (10) años a partir de la fecha de compra. Esta garantía limitada se extiende solo al propietario original y no es transferible.

Bajo esta garantía limitada, la Compañía proporcionará lo siguiente:

Si, al momento de inspección, la Compañía determina que el Producto no logra cumplir con la garantía descrita anteriormente, la Compañía podrá, a su entera discreción: (1) reinstalar o reemplazar la parte del sistema de revestimiento de piso que presenta fallas (según se define a continuación) de la cual forma parte el Producto O BIEN (2) pagar al propietario un monto equivalente, pero no superior, al costo original por pie cuadrado para el sistema de revestimiento de piso que presentó fallas. Si el reclamo de garantía se realiza con posterioridad, la Compañía reembolsará al propietario un monto prorrateado de dicho costo original, sobre la base de una escala dependiente de 10 años.

- Por ejemplo:**
- Si se detectan defectos en el Producto en el cuarto año del período de garantía, el propietario deberá reembolsar el 100% del costo original descrito anteriormente.
 - Si se detectan defectos en el Producto en el octavo año del período de garantía, el propietario deberá reembolsar dos décimas partes del costo original descrito anteriormente.

Tal como se utiliza en esta garantía limitada, "sistema de revestimiento de piso" hace referencia al Producto, a la superficie del piso sobre el Producto y a los adhesivos y materiales de colocación necesarios para instalar el Producto y la superficie del piso. Mediante este recurso, la Compañía deberá reinstalar cualquier material afectado de la superficie del piso que sea reutilizable. Debido a las condiciones que exceden el control de la Compañía, como por ejemplo, la disponibilidad de colores y diseños, la interrupción de ciertos estilos y el desgaste y el deterioro normales, o cualquier otro factor, la Compañía no puede garantizar una concordancia exacta del material de piedra, baldosa o cualquier otro material de revestimiento de piso.

Para poder acceder a los recursos de la garantía limitada, debe realizar lo siguiente:

- Informar a la Compañía por escrito en un plazo de 30 días a partir de la detección del defecto en el Producto.
- Proporcionar la prueba de que el Producto se instaló de acuerdo con las instrucciones de instalación de WarmWire HeatMatrix y cualquier diseño especial por escrito o las guías de instalación que proporcione la Compañía para este proyecto.
- Usar e instalar el Producto de acuerdo con las normas y pautas del Instituto Nacional Estadounidense de Estándares (ANSI, American National Standards Institute) que especifica el Consejo Cerámico de Norte América (TCNA, Tile Council of North America).
- Permitir que la Compañía, a su entera discreción, inspeccione la instalación del sistema de revestimiento de piso y obtener una autorización previa por escrito de la Compañía para cualquier asignación de mano de obra o reembolso de materiales antes de comenzar cualquier tarea o reparación. En el caso de los reclamos que no sean válidos, la Compañía deberá recibir el reembolso de los cargos razonables, incluidos los viajes y la mano de obra, asociados con la investigación de dicho reclamo.

Materiales y condiciones aceptables

Esta garantía limitada cubre los Productos instalados únicamente en espacios interiores. Es responsabilidad del propietario/instalador garantizar la idoneidad del Producto y los materiales de instalación y construcción asociados para el uso previsto del propietario. Se recomienda que el propietario consulte a un encargado de instalación profesional con experiencia y/o recorra a sus servicios.

En caso de que un propietario/encargado de instalación instale WarmWire HeatMatrix con un cable de calefacción distinto a WarmWire de la Compañía, se aplicará a WarmWire HeatMatrix la garantía limitada de veinticinco (25) años para la composición y cinco (5) años para el desempeño solo cuando las especificaciones del otro cable de calefacción sean equivalentes a las de WarmWire, incluso aquellas relacionadas con el desempeño y las propiedades físicas, y dicho cable de calefacción cuente con la certificación de una agencia de verificación independiente reconocida. En ningún momento y bajo ninguna circunstancia, la Compañía asumirá la obligación o la responsabilidad por las fallas ocasionadas por cables de calefacción eléctricos que dicha Compañía no fabrica ni vende, ni por otros componentes o materiales que vendan otros fabricantes ajenos a la Compañía.

Descargo de responsabilidad

L'ENTREPRISE RÉFUTE TOUTE GARANTIE NON PROPORCIONNÉE AQUÍ, EXPRESA O IMPLÍCITA, INCLUYENDO CUALQUIER GARANTÍA IMPLÍCITA O ESTADOS DE COMERCIALIZACIÓN O TÍTULO PARA UN FIN EN PARTICULAR. LA COMPAÑÍA TAMBIÉN RECHAZA CUALQUIER RESPONSABILIDAD POR DAÑOS ESPECIALES, INDIRECTOS, SECUNDARIOS, INCIDENTALES O RESULTANTES QUE SE DERIVEN DE LA PROPIEDAD O EL USO DE ESTE PRODUCTO, INCLUIDOS LOS INCONVENIENTES O LA PERDIDA DE USO. NO HAY GARANTÍAS CON UNA COBERTURA MÁS AMPLIA DE LA QUE SE ESPECIFICA EN ESTE DOCUMENTO. NINGÚN AGENTE O REPRESENTANTE DE LA COMPAÑÍA TIENE AUTORIDAD ALGUNA PARA AMPLIAR O MODIFICAR ESTA GARANTÍA, A NO SER QUE DICHA

AMPLIACIÓN O MODIFICACIÓN LA REALICE UN DIRECTOR EJECUTIVO DE LA COMPAÑÍA POR ESCRITO. Los casos de fuerza mayor, incluidos, entre otros, inundaciones, huracanes, tornados y terremotos, los hechos de guerra, el terrorismo, las acciones intencionales de destrucción e incendio no están cubiertas por esta garantía limitada. Los daños causados por el movimiento o estructural, la desviación excesiva o cualquier otra falla del sustrato, y los daños en los elementos estructurales o del subsuelo como consecuencia del agua tampoco están cubiertos por esta garantía. La Compañía no asumirá la responsabilidad por los elementos que no venden. Los productos fabricados por otra compañía deben informarse al fabricante correspondiente para acceder a su garantía.

Algunos estados no permiten la exclusión o limitación de los daños incidentales o indirectos, y algunos de ellos no permiten limitaciones en cuanto a la duración de las garantías implícitas. Por lo tanto, es posible que las limitaciones o exclusiones anteriores no se apliquen en caso de esta garantía. El otorgar derechos legales específicos, y posiblemente usted tenga otros derechos que varían de un estado a otro.

Fecha de entrada en vigencia: 1 de junio de 2016. Esta garantía limitada se aplica a todos los Productos adquiridos después de esta fecha.

warmyourfloor™
the radiant floor heating experts™

Warm Your Floor
20918 Bake Pkwy
Suite 104 & 106
Lake Forest, CA 92630
Toll-free: 866-558-3369
Fax: 866-558-2010
WarmYourFloor.com

WarmWire®

Installation Manual



Series
WB & WR



⚠ WARNING

Please be aware local codes may require this product and/or the thermostatic control to be installed or connected by an electrician.

⚠ WARNING



**THINK
SAFETY
FIRST**

Read this Manual BEFORE using this equipment.

Failure to read and follow all safety and use information can result in death, serious personal injury, property damage, or damage to the equipment.

Keep this Manual for future reference.

WarmWire® is a simple, economical way to warm any floor, and provide years of lasting comfort. This instruction manual provides complete details, suggestions, and safety precautions for installing this floor-warming system. Fasten the cables to the floor. Then, depending on the floor coverings to be used, put down a layer of thin-set, thick-set, or self-leveling mortar on top of the cables. Finally, install the floor coverings. It's that simple!

Specifications for WarmWire:

WarmWire is a complete heating cable consisting of a series resistance heating cable and a power lead for connection to the electric power supply. The heating cable cannot be cut to fit.

Voltages: 120 VAC, 240 VAC, 1-phase

Watts: 3 W/linear foot. Approximately 10.3 W/ft² (34 Btu/h/ft²) for 3.5" spacing, 12 W/ft² (41 Btu/h/ft²) for 3" spacing. and 14.4 W/ft² (51 Btu/h/ft²) for 2.5" spacing. (See Table 2)

2.5" spacing may only be used under masonry surfaces with a maximum floor covering R-value of R-1.5 as indicated in this manual. 3" or 3.5" spacing may be used under floor covering types with a maximum R-value of R-2.5.

Maximum circuit load: 15 amps

Maximum circuit overload protection: 20 amp breaker

GFCI: (Ground Fault Circuit Interrupter) required for each circuit (included in the SunStat control)

Listing: UL Listed for U.S. and Canada under UL 1673 and CAN/CSA C22.2 No. 130.2-93, File No. E185866

Application: Indoor floor heating only (-X on the nameplate label indicates CUL Listing for this application). Suitable for installation in a shower area (see pg 18 for restrictions) (-W on the nameplate label indicates CUL Listing for Wet Location in Canada per Canadian Electrical Code, Part I (CEC)).

Embedded in cement based mortar only, polymer-modified preferred (see Appendix 1).

Minimum bend radius: 1 inch

Maximum exposure temperature:
(continuous and storage) 194°F (90°C)

Minimum installation temperature: 50°F (10°C)

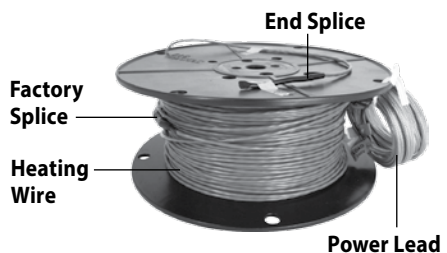

⚠ WARNING

Installation must be performed by qualified persons, in accordance with local codes, ANSI/NFPA 70 (NEC Article 424) and CEC Part 1 Section 62 where applicable. Prior to installation, please consult the local codes in order to understand what is acceptable. To the extent this information is not consistent with local codes, the local codes should be followed. However, electrical wiring is required from a circuit breaker or other electrical circuit to the control. It is recommended that an electrician perform these installation steps. Please be aware local codes may require this product and/or the control to be installed by an electrician.

Expected floor temperature

Heating performance is never guaranteed. The floor temperature attainable is dependent on how well the floor is insulated, the temperature of the floor before start up, and the overall thermal drain of the floor mass. Insulation is required for best performance. Refer to Phase 9 for important design considerations.

These are the three most common installations:

- 1. Wood framing:** With the cable installed on a well-insulated wood subfloor, and thin-set mortar and tile on top, most floors can be heated up to 20°F warmer than they would otherwise be.
- 2. Insulated concrete slab:** With the cables installed on an insulated concrete slab, and thin-set mortar and tile on top, most floors can be heated up to perhaps 15°F warmer than they would otherwise be.
- 3. Uninsulated concrete slab:** With the cables installed on an uninsulated concrete slab, and thin-set mortar and tile on top, most floors can be heated up to perhaps 10°–15°F warmer than they would otherwise be.

Please consult a designer or the factory if questions remain about the surface temperature that can be expected from the cables in any particular construction. Please see “Phase 10: Install Insulation” on page 22.

Table of Contents

Important Safety Information.....	3	7 - Finish Wiring	20
1 - Preparations	5	8 - Control Installation	21
2 - Electrical Rough-in	9	9 - Install the Floor Coverings.....	21
3 - HeatMatrix Cable Install	11	10 - Install Insulation	22
4 - CableStrap / Cable Install	14	Appendices	23
5 - Shower Area Installation.....	18	Troubleshooting	33
6 - Final Steps	19	Warranty.....	35

Important Safety Information



This is a safety-alert symbol. The safety alert symbol is shown alone or used with a signal word (DANGER, WARNING, or CAUTION), a pictorial and/or a safety message to identify hazards.

When you see this symbol alone or with a signal word on your equipment or in this Manual, be alert to the potential for death or serious personal injury.



This pictorial alerts you to electricity, electrocution, and shock hazards.

WARNING

This symbol identifies hazards which, if not avoided, could result in death or serious injury.

CAUTION

This symbol identifies hazards which, if not avoided, could result in minor or moderate injury.

NOTICE

This symbol identifies practices, actions, or failure to act which could result in property damage or damage to the equipment.

Table 1

⚠ WARNING



As with any electrical product, care should be taken to guard against the potential risk of fire, electric shock, and injury to persons. The following cautions must be observed:

NEVER install WarmWire under carpet, wood, vinyl, or other non-masonry flooring without embedding it in thin-set, thick-set, or self-leveling mortar.

NEVER install WarmWire in adhesives or glues intended for vinyl tile or other laminate flooring, or in pre-mix mortars. It must be embedded in cement based mortar.

NEVER cut the heating wire. Doing so will cause dangerous overheating and will void the warranty. The power lead may be cut shorter if necessary, but never remove completely from the heating wire.

NEVER bang a trowel or other tool on the heating wire. Be careful not to nick, cut, or pinch the wire causing it to be damaged.

NEVER use nails, staples, or similar to fasten the heating wire to the floor.

NEVER attempt to repair a damaged heating wire, splice, or power lead using unauthorized parts. Use only factory authorized repair parts and methods.

NEVER splice one heating wire to another heating wire to make it longer. Multiple WarmWire power leads must be connected in parallel in a junction box or to the thermostat.

NEVER install one wire on top of another or overlap the heating wire on itself. This will cause dangerous overheating.

NEVER forget to install the floor sensor included with the thermostat.

NEVER install WarmWire in any walls, or over walls or partitions that extend to the ceiling.

NEVER install wires under cabinets or other built-ins having no floor clearance, or in small closets. Excessive heat will build up in these confined spaces, and the wire can be damaged by fasteners (nails, screws, etc.) used to install built-ins.

NEVER remove the nameplate label from the power leads. Make sure it is viewable for inspection later.

NEVER extend the heating wire beyond the room or area in which it originates.

NEVER allow a power lead or sensor wire to cross over or under a heating cable. Damage could result.

NEVER put the system into full operation until the tile or flooring installer verifies all cement materials are fully cured (typically two to four weeks).

NEVER energize WarmWire while it is on the spool. Damage will result.

ALWAYS completely embed the heating wire and factory splices in the floor mortar.

ALWAYS maintain a minimum of 2" spacing between heating wires.

ALWAYS pay close attention to voltage and amperage requirements of the breaker, the thermostat, and the WarmWire. For instance, do not supply 240 VAC power to 120 VAC WarmWire as damage will result.

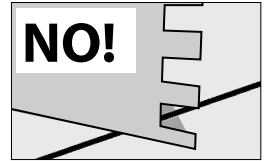

NEVER bang a trowel or other tool on the heating cable.



ALWAYS completely embed the factory splice and all heating wire in mortar. **NEVER** bend the splice or place any part of it in the wall or through the floor.

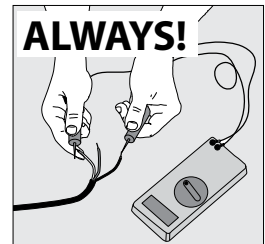

ALWAYS test the wire before and after installation.

ALWAYS make sure all electrical work is done by qualified persons in accordance with local building and electrical codes, Section 62 of the Canadian Electrical Code (CEC) Part I, and the National Electrical Code (NEC), especially Article 424.

ALWAYS use copper only as supply conductors to the thermostat. Do not use aluminum.

ALWAYS seek help if a problem arises. If ever in doubt about the correct installation procedure to follow, or if the product appears to be damaged, the factory must be called before proceeding with the installation.

⚠ WARNING

Installation must be performed by qualified personnel, in accordance with local codes and standards. A licensed electrician is recommended.

Phase 1 - Preparations

Before installing WarmWire, make sure to fully inspect the products and carefully plan the site. All electrical components selected must be certified for use in your location.

Items Needed

Materials:

- WarmWire® system
- CableStrap™ or HeatMatrix™ crack-isolation membrane (purchased separately or as part of a kit from SunTouch).
- SunStat® Thermostat with floor sensor (SunStat thermostats are UL Listed)
- SunStat Relay control if required (SunStat relays are UL Listed)
- Control electrical box (UL Listed, extra deep, see control instructions for size and type required)
- Junction electrical box (if required, must be UL Listed and proper size)
- Wire nuts (if required, must be UL Listed and proper size)
- Flexible or rigid conduit (if required, see Step 2.4, must be UL Listed and proper size)
- 12-gauge or 14-gauge electrical wiring cable (UL Listed, see Step 2.1)
- Nail plate

Tools:

- Digital multi-meter (for ohms testing; must read up to 20,000 ohms (Ω) to measure sensor)
- Drill with 1/2" and 3/4" bits
- Hammer and chisel
- Hot glue gun and hot glue (craft grade)
- Wire strippers
- Phillips screwdriver
- Fish tape
- Hole saw
- Floor covering installation tools



Floor sensor is included in the thermostat packaging. This must be installed in the floor with the cable.

Table 2 - Cable sizes (all Models with suffix WB & WR)

Please check the product label for exact ratings. This table is for reference only.

The coverage areas below are for CableStrap or HeatMatrix installation. Contact the factory if using alternate attachment materials that may require different wire spacing. The area coverages shown are approximate and may vary due to installation pattern variations. Also, the heating cable is designed to operate 3 W/linear foot. Values for heat output per square foot may vary depending on installation variations.

120 VAC

Model Number	Total Sq. ft. 2.5" Spacing 14.4 watts/ft ²	Total Sq. ft. 3" Spacing 12 watts/ft ²	Total Sq. ft. 3.5" Spacing 10.3 watts/ft ²	Wire Length (ft.)	Amp Draw	Resistance (ohms)
120010	8	10	12	39	1.0	108 - 134
120015	13	15	18	59	1.5	72 - 89
120020	17	20	24	78	2.0	53 - 66
120025	21	25	30	98	2.5	42 - 52
120030	25	30	36	117	3.0	33 - 42
120035	29	35	42	137	3.5	29 - 37
120040	34	40	48	157	4.0	25 - 32
120045	38	45	54	176	4.5	22 - 28
120050	42	50	60	196	5.0	20 - 26
120060	51	60	72	235	6.0	16 - 21
120070	59	70	84	274	7.0	14 - 19
120080	67	80	96	313	8.0	12 - 16
120090	76	90	108	352	9.0	11 - 14
120100	84	100	120	391	10.0	10 - 13

240 VAC

Model Number	Total Sq. ft. 2.5" Spacing 14.4 watts/ft ²	Total Sq. ft. 3" Spacing 12 watts/ft ²	Total Sq. ft. 3.5" Spacing 10.3 watts/ft ²	Wire Length (ft.)	Amp Draw	Resistance (ohms)
240020	17	20	24	78	1.0	217 - 267
240030	25	30	36	117	1.5	143 - 176
240040	34	40	48	157	2.0	107 - 132
240050	42	50	60	196	2.5	84 - 104
240060	51	60	72	235	3.0	67 - 83
240070	59	70	84	274	3.5	59 - 73
240080	67	80	96	313	4.0	50 - 63
240090	76	90	108	352	4.5	45 - 56
240100	84	100	120	391	5.0	40 - 50
240120	101	120	144	470	6.0	33 - 42
240140	118	140	168	548	7.0	29 - 37
240160	135	160	192	626	8.0	24 - 31
240180	151	180	216	704	9.0	22 - 28
240200	168	200	240	783	10.0	20 - 26

NOTICE

It is important to select the proper size cable for the given area. WarmWire cannot be cut shorter in order to fit a given area. Doing so will damage the heating wire and prevent the system from working.

⚠ WARNING



To prevent the risk of personal injury and/or death, make sure power is not applied to the product until it is fully installed and ready for final testing. All work must be done with power turned off to the circuit being worked on.

STEP 1.1

Remove the WarmWire, SunStat thermostat, and SunStat sensor from their packages. Inspect them for any visible damage. Verify everything is the correct size and type according to the plan and the order. Do not attempt to install a damaged product.

STEP 1.2

Record the product information. There is a factory-applied nameplate label on the power leads. Do not remove this label. Record the cable serial number, model number, voltage, and cable resistance range in the Cable and Sensor Resistance Log (Table 4). If installing more than one cable, do this for each of them.

STEP 1.3

Use a digital multi-meter set to the 200Ω or 2000Ω (2kΩ) range to measure the resistance between the conductors of the cable power leads. Record these resistances in Table 4 under “Out of the box before installation”. The resistance should measure within the resistance range on the nameplate label. If it is a little high or low, it may be due to air temperatures or meter calibration. Consult the factory if in doubt.

Measure the resistance between either of the white or black leads and ground lead. This measurement should be “open”, usually indicated by an “OL” or a “1”. This is the same as displayed when the test leads are not touching anything.

If there is any change in the reading, record this information and contact the factory before continuing. This could indicate damage, test lead problems, or a number of other issues. Try “pinning” the test leads to the cable lead wires against a hard non-metal surface if the readings continue to fluctuate.

Change the meter to the 20,000 ohms (20 kΩ) range. Measure between the lead wires of the SunStat sensor. This resistance varies according to the temperature sensed. Table 3 provides approximate resistance-to-temperature values for reference.

Table 3 - Floor Sensor Resistance Values

Temperature	Typical Values
55°F (13°C)	17,000 ohms
65°F (18°C)	13,000 ohms
75°F (24°C)	10,000 ohms
85°F (29°C)	8,000 ohms

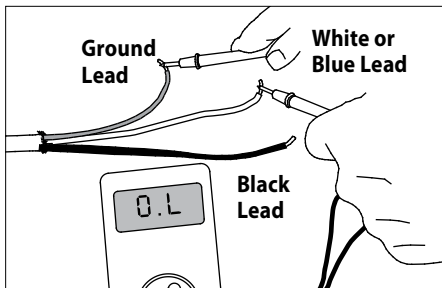
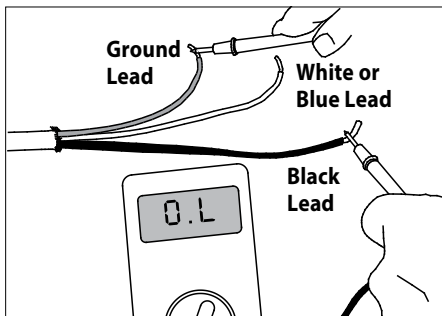
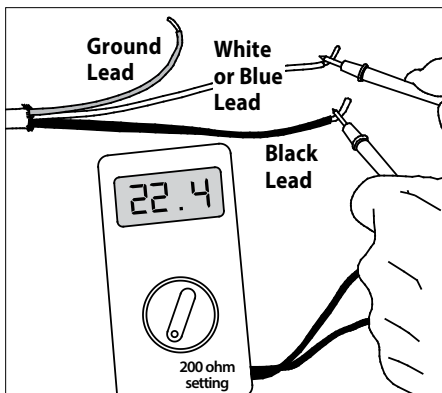

Table 4 - Cable and Sensor Resistance Log

	Cable 1	Cable 2	Cable 3
Cable serial number			
Cable model			
Cable voltage			
Factory cable resistance range			
OUT OF THE BOX BEFORE INSTALLATION (OHMS)			
Cable black to white (black to blue for 240VAC)			
Cable black to ground			
Cable white to ground (blue to ground for 240VAC)			
Sensor wire			
AFTER CABLE AND SENSOR ARE FASTENED TO FLOOR (OHMS)			
Cable black to white (black to blue for 240VAC)			
Cable black to ground			
Cable white to ground (blue to ground for 240VAC)			
Sensor wire			
AFTER FLOOR COVERINGS ARE INSTALLED (OHMS)			
Cable black to white (black to blue for 240VAC)			
Cable black to ground			
Cable white to ground (blue to ground for 240VAC)			
Sensor wire			
Retain this log to retain the warranty! Do not discard!			

INSTALLATION NOTES

Phase 2 - Electrical Rough-in

WARNING

To prevent the risk of personal injury and/or death, make sure power is not applied to the product until it is fully installed and ready for final testing. All work must be done with power turned off to the circuit being worked on.

STEP 2.1:

Circuit Breaker (Overcurrent Protection)

WarmWire must be protected against overload by a circuit breaker. GFCI type (ground fault circuit interrupter) or AFCI type (arc-fault circuit interrupter) breakers may be used if desired, but are not necessary when using SunStat controls with integral GFCI.

The rating of the breaker (**see Table 5**) is determined by the amp draw of the heating cables. Add the amp ratings of all cables to be connected to the SunStat control (see Table 2 or the Nameplate Label on the cable). If the total is less than 12 amps, use a 15 or 20 Amp breaker (preference is 15 A). If the total is between 12 and 15 amps, use a 20 Amp breaker. If the total is over 15 A, another circuit will be required with its own breaker and SunStat control.

It may be possible to tap into an existing circuit as long as there is adequate capacity for the cables(s) and any additional appliance, such as a hair dryer or vacuum cleaner. Avoid circuits which have lighting, motors, exhaust fans, or hot tub pumps due to possible interference.

Table 5

Circuit Breakers and Supply Wire					
Cable(s)		Supply Wire		Breaker	
VAC	total amps	(AWG)*	qty	type**	rating
120	up to 12 amps	14	1	SP	15 or 20 A
120	up to 15 amps	12	1	SP	20 A
240	up to 12 amps	14	1	DP	15 or 20 A
240	up to 15 amps	12	1	DP	20 A

* Recommended only. Follow local codes for wire gauge size.

** SP= single-pole, DP=double-pole

STEP 2.2:

Install Electrical Boxes

SunStat® Thermostat:

Install an extra-deep electrical box for the SunStat Thermostat. Follow the instructions included with the thermostat for complete information on location and wiring.

SunStat Relay:

Install an extra-deep electrical box for any SunStat Relay(s). The SunStat Relay is used when more than 15 amps must be controlled by one SunStat Thermostat. Follow the instructions included with the SunStat Relay for complete information on location and wiring.

Junction Boxes:

If a cable is to be located so its power lead is not long enough to reach the SunStat thermostat or SunStat Relay directly, a junction box must be installed. Do not attempt to make a connection to other wiring without a junction box. Use a standard junction box with a cover, mounting it below the subfloor, in the attic, in the wall, or in another location easily accessible after all coverings are complete. If the SunStat sensor wire is not long enough to reach the SunStat thermostat directly, it may be extended. A junction box may be required by local code to make this connection. Follow the installation instructions included with the SunStat for details.

For construction with an existing wall or where the wall is covered, cut the necessary openings to mount the electrical boxes listed above. Wait to install the boxes until all wiring is fed into these locations to make it easier to pull the wire.

STEP 2.3:

Bottom Plate Work

Drill or chisel holes at the bottom plate as indicated. One hole is for routing the power lead conduit and the other is for the thermostat sensor. These holes should be directly below the electrical box(es).

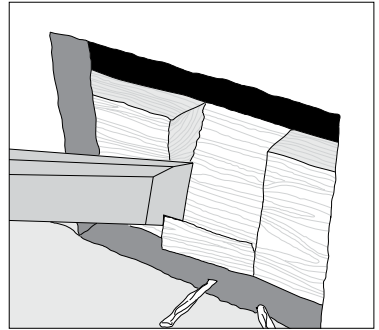
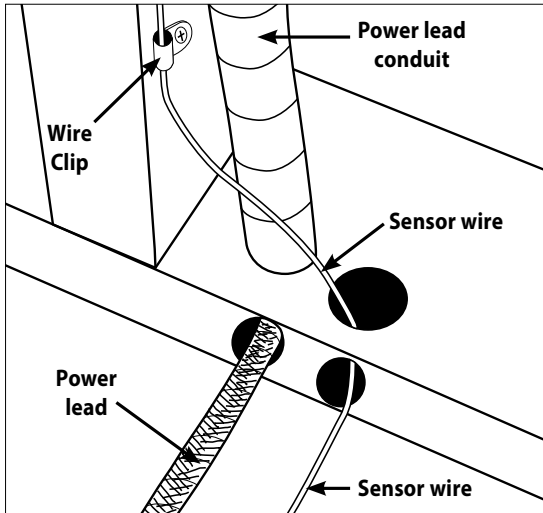

If going in to an existing wall, cut out dry wall and chisel out bottom plate to route wires to control.

STEP 2.4:

Install Power Lead Conduit and Thermostat Sensor

Power Lead Conduit:

The shielded power lead can be installed with or without electrical conduit (recommended for added protection against nails or screws) depending on code requirements. Remove one of the knock-outs in the electrical box to route the power lead. If electrical conduit is not required by code, install a wire collar to secure the power leads where they enter the box. If conduit is required by code, install 1/2" (minimum) conduit from the bottom plate up to the electrical box. For multiple power leads (multiple cables) install 3/4" conduit.

SunStat Thermostat Sensor:

The SunStat sensor can be installed with or without electrical conduit depending on code requirements. Conduit is recommended for added protection against nails or screws. Do not place the sensor in the same conduit as the power leads to avoid possible interference. Open a separate knock-out in the bottom of the thermostat box. Feed the sensor (and conduit, if used) through the knock-out, down through the cut-out in the bottom plate, and out into the floor where the heating cable will be installed. If the sensor wire needs to be secured to the wall stud, wait until after the cable and sensor are completely installed on the floor.

STEP 2.5:

Rough-in Wiring:

Install appropriate 12 or 14 AWG electrical wire from the circuit breaker or branch circuit source to the SunStat Thermostat electrical box (and SunStat Relay box(es) if needed) following all codes, see **Table 5**.

If SunStat Relay(s) are used, feed appropriate wire (see SunStat Relay installation manual for size and type) between the SunStat Relay(s) and the SunStat thermostat.

See SunStat Relay instructions for details of wire size and type.

There are 2 installation methods for securing WarmWire:

- HeatMatrix offers an easy way to install WarmWire while providing crack-isolation, vapor management and waterproofing for installations with tile or stone. To install, WarmWire is simply pressed into the HeatMatrix channels at a selected spacing. With HeatMatrix, the space between rows can be easily adjusted to accommodate additional wire or provide more or less heat in defined areas.
- CableStrap is used for installations where crack-isolation and waterproofing are not required, or in areas that need a lower profile. CableStrap be covered with a smooth mortar finish for use under hardwood, laminate or resilient flooring. For CableStrap installation instructions, refer to Phase 4.

Phase 3 - Cable Installation with HeatMatrix

STEP 3.1:

Determine the area for HeatMatrix

HeatMatrix is installed in both unheated and heated areas to provide crack-isolation and waterproofing. Order a quantity that will cover the full square footage of the area to be tiled.

STEP 3.2:

Substrate preparation

The substrate must be flat, clean, dry, structurally sound, adequately load bearing and free from material which may prevent bonding with the cement mortar.

STEP 3.3:

Cut lengths of HeatMatrix to fit the installation area

Measure and cut HeatMatrix to the required length for each row. Mark the boundary edge on the subfloor to use as a guide for mortar application.

STEP 3.4:

Secure HeatMatrix to the substrate with mortar

The type of mortar used to secure the membrane to the subfloor depends on the type of substrate. For most substrates, a premium modified thinset mortar is recommended. Apply the mortar for the first row using a 1/4" x 1/4" notched trowel. Place the cut length of HeatMatrix over the mortar. Position membrane, then readjust alignment if necessary by lifting one end, and pulling lightly. Do not leave gaps between sections of HeatMatrix and ensure the pattern is aligned. Work HeatMatrix in using a float or flat trowel. The entire surface of the fleece on the underside of the membrane should be securely bonded to the mortar. Observe the mortar open time while working. Trim out any rough drain openings or other obstructions if necessary. Repeat the application process for each row until the space to be tiled is completely covered.

STEP 3.5:

Outline the heated area

Mark the areas where the WarmWire cable will be installed. WarmWire should not be installed:

- Within 3" of the wall perimeter, door jamb, tub or shower base
- Within 6" of toilet flanges
- Under cabinets or fixtures that have no clearance under them
- Within confined spaces like closets or pantries where the heat cannot disperse, particularly when objects are left on the floor.

Wire may be omitted from areas with no foot traffic. Refer to Appendix 1 for a table of recommended clearances.

STEP 3.6:

Make sure the cable fits

Check the cable size to ensure it will fit inside the Heated Area at the selected wire spacing (see Table 2)

⚠ WARNING

The heating cable CANNOT be cut to fit. It must be kept its original length and fully embedded in the mortar in the floor. Any modification or mis-use of the heating cable will void the warranty and cause potential shock or fire hazard.

STEP 3.7:

Decide the cable layout

Decide which direction the cables will run on the floor for the easiest coverage. Refer to the sample layouts in this manual for assistance. Depending on the shape of the area, it may help to think of it in terms of several smaller areas.

If more than one heating cable is to be installed in the area, all Power Leads must come back to the control or to a junction box and then to the control. Ensure there is sufficient space to allow this when planning the wire layout.

⚠ WARNING

NEVER run Power Leads across heating cables, under baseboard areas, or other potentially damaging areas.

NEVER place heating cables closer than 2" from other heating cables.

NEVER place heating cables closer than 1" from Power Leads.

STEP 3.8:

Position the Power Leads & Factory Splice

Carefully cut the tie binding the power lead coil. Do not nick the braid covering the power lead. Locate the Factory Splice to ensure the power lead will reach the SunStat electrical box or junction box location. It is acceptable to run the power leads several feet in the floor area embedded in mortar if needed.

Draw an outline around the Factory Splice and move it aside. Cut a shallow channel in the HeatMatrix to allow the Factory Splice to lay flat with the rest of the heating cable in the channel.

Pull the Power Leads up into the wall or conduit.

Add hot glue in the channel and set the Factory Splice and Power Lead in place.

⚠ CAUTION

Completely embed the Factory Splice and heating cable in the floor mortar. Never bend the factory splice. Never allow any part of the Factory Splice or heating cable to enter a wall or cabinet or drop through the subfloor. Damage to the product will result.

STEP 3.9:

Install Cable

Press the heating cable into the HeatMatrix channels at the determined spacing. A hand roller or grout float may be used to aid in installation.

WarmWire spacing in HeatMatrix:

- Install WarmWire with 3-shapes in-between each row for approx. 12.3 W/ft² heat output (standard spacing)
- Alternate between 3-shapes and 2 for a higher heat output of 14.8 W/ft²
- Alternate between 3-shapes and 4 for a lower heat output of 10.6 W/ft²

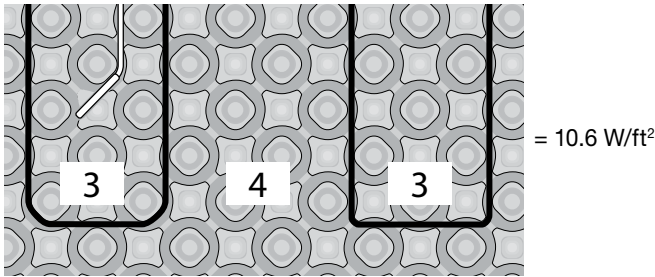
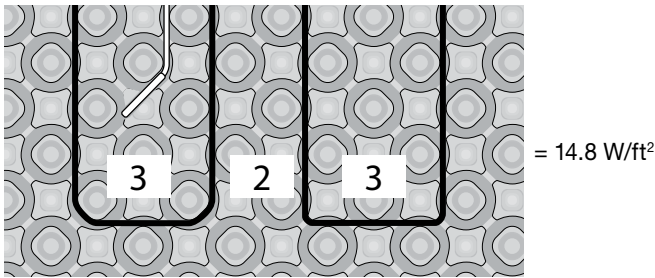
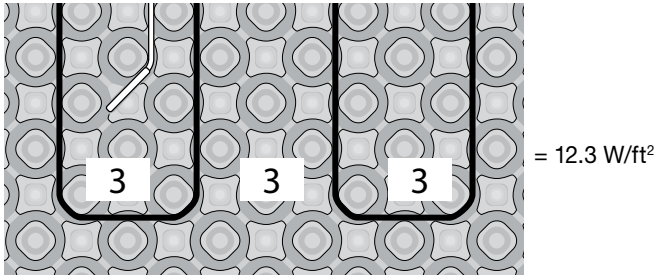

STEP 3.10

Bench seat

If covering a bench seat or step area (not in a shower area), place a single run of cable up the riser. Use a section of HeatMatrix to secure the cable to the seat at the desired spacing, then install a single run down the riser. Use an "s-shaped" curve to avoid sharp bends in the cable at corners and help the cable to lay flat. The cable **MUST** be fully embedded in mortar and have approved floor coverings. Use hot glue where necessary to secure the cable flat against the riser.

NOTICE

NEVER space the cables less than 2" apart at any point, and never less than 2.5" average. Never space more than 3.5" average.

Phase 4 - Cable Installation with CableStrap™

STEP 4.1:

Floor Cleaning

The floor must be completely swept of all debris including all nails, dirt, wood, and other construction debris. Make absolutely sure there are no objects on the floor which might damage the wire.

Wet mop the floor at least twice to ensure there is no dirt or dust. This will allow proper bonding of the mortar and proper stick of any adhesives or double-sided tape used later.

STEP 4.2:

Outline the Heated Area

Use a marker to outline the area where the heating cable will be installed. Refer to the Appendix for a table of recommended clearances.

Cabinet vanities: Draw the border right up to the toe-kick. The wire can be installed up to 1" away from the vanity toe-kick.

Tubs and shower entries: Draw the border about 3" from the edge of the tub or shower.

Walls: Draw the border about 3" from the wall. If required to help the cable fit better, it may be drawn 4" to 6" from the wall since people do not generally stand this close to a wall anyway. It may also be drawn closer, but be careful that the cable will not be placed under any trimwork.

WARNING

- Keep the cable at least 6" from toilet flanges
- Do not run the cable under cabinets or fixtures that have no clearance under them.
- Avoid running the cable into a small closet or pantry. The heat cannot escape and things can be laid on the floor, blocking the heat and potentially overheating and causing a fire hazard.

STEP 4.3

Make Sure the Cable Fits

Check the cable size to ensure it will fit inside the Heated Area at the selected wire spacing. See Table 2.

WARNING

Remember the heating cable length CANNOT be cut to fit. It must be kept its original length and fully embedded in the mortar in the floor. Any modification or mis-use of the heating cable will void the warranty and cause potential shock or fire hazard.

STEP 4.4

Decide the Layout

Decide which direction the cables will run on the floor for the easiest coverage. Refer to the sample layouts in this manual for assistance. Depending on the shape of the area, it may help to think of it in terms of several smaller areas.

Install CableStrap

STEP 4.5

Measure the edge of the Heated Area where CableStrap will be installed.

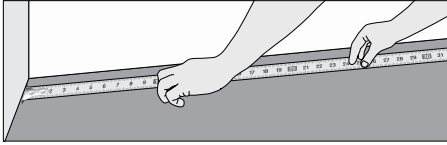

STEP 4.6

Cut the CableStrap to length using metal shears.

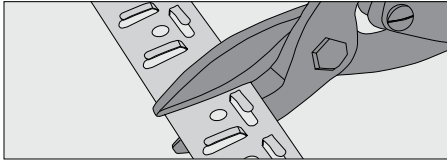

STEP 4.7

Secure the strap to the floor. Depending on the floor type, different methods may be used.

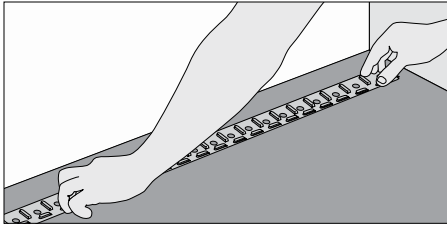

Plywood, cement board, or similar: Galvanized nails or screws may be used to secure the strap every 6" to 10".

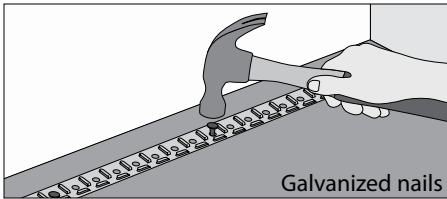

Galvanized nails

OR

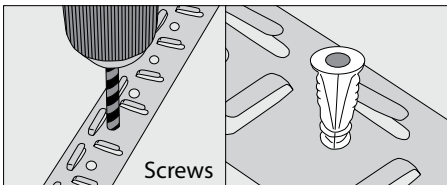

Screws

Concrete, self-level, or similar: Double-sided tape (if included with your cable), hot glue, or strong spray adhesive may be used if the floor is well cleaned and the strap is wiped free of any oils. However, it is highly recommended to also place screws at each end of the strap, and every 4 to 5 feet, to ensure it does not come loose. If using a strong spray adhesive, apply to both the back of the strap and the floor where it will be placed, and carefully follow all spray manufacturer's instructions and cautions.

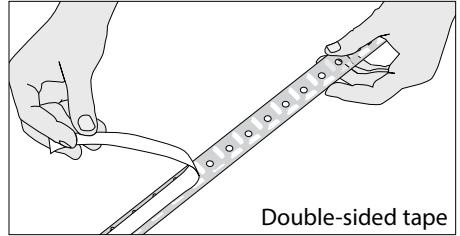

Double-sided tape

OR

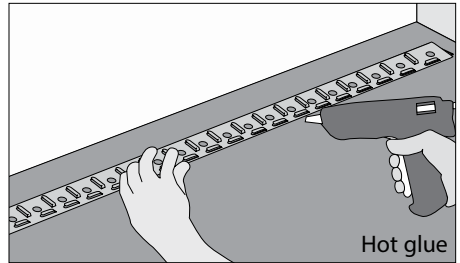

Hot glue

OR

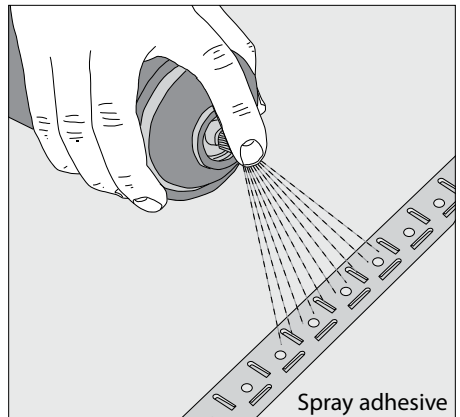

Spray adhesive

Cut another piece of strap for the other end of the area and secure to the floor.

⚠ CAUTION

Completely embed the Factory Splice and heating cable in the floor mortar. Never bend the factory splice. Never allow any part of the Factory Splice or heating cable to enter a wall or cabinet or drop through the subfloor. Damage to the product will result.

Position the Power Leads & Factory Splice

STEP 4.8

Carefully cut the tie binding the power lead coil. Do not nick the braid covering the power lead. Locate the Factory Splice to ensure the power lead will reach the SunStat electrical box or junction box location. It is acceptable to run the power leads several feet in the floor area embedded in mortar if needed.

STEP 4.9

Draw an outline around the Factory Splice and move it aside. Chisel a shallow channel to allow the Factory Splice to lay flat with the rest of the heating cable in the channel. Add hot glue in the channel and set the Factory Splice in place.

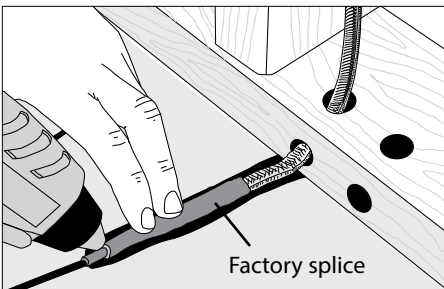
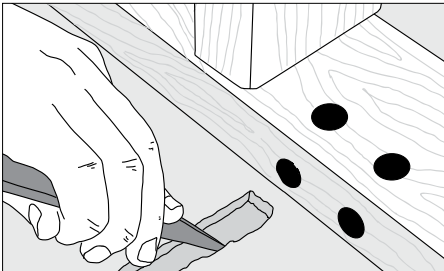

Installing Cables on CableStrap

STEP 4.10

Weave the cable back and forth across the area at the desired spacing until the other side of the room has been reached. Once this area is completed, press down all the tabs.

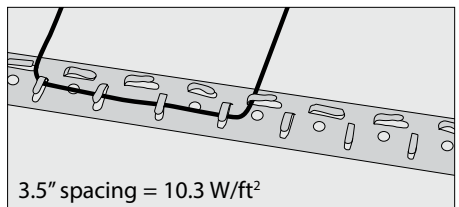
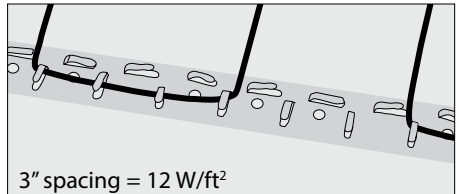
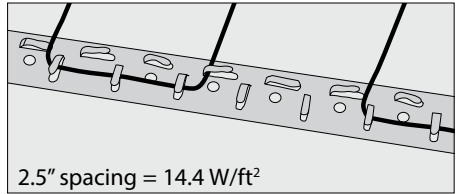
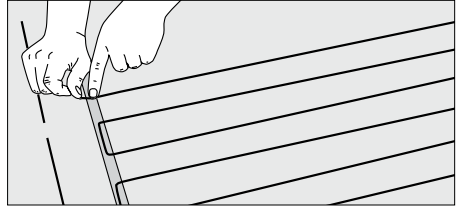

NEVER space the cables less than 2" apart at any point, and never less than 2.5" average. Never space more than 3.5" average.

STEP 4.11

If there are additional areas to cover with cable, cut the lengths of strap necessary, attach them to the floor, and begin weaving the cable into that area.

STEP 4.12

To secure long lengths of heating cable, place additional, short lengths of the strap at 3–4-ft. intervals. Spray the back of the strap with a high-tack adhesive, and slide the strap, upside down, under the cables. Turn the strap over when it is positioned and adhere to the floor. Press the tabs down over the cables. If a spray adhesive was not used, carefully secure these short lengths of strap to the floor without damaging the cable.

Install second cable

STEP 4.13

If a second cable is to be installed in the area, all power leads must come back to the control, or to a junction box and then to the control. NEVER run power leads across heating cables, under baseboard areas, or other potentially damaging areas. Never join two cables in series.

Other Installations

Because many different room shapes and floor obstructions may be encountered in any given installation, additional layouts are provided below to assist in determining the best way to complete installations in odd-shaped areas.

Corner shower or vanity using CableStrap

STEP 4.14

For an angled area, such as a corner shower, lay CableStrap at an angle and adjust tab spacing to keep the wire spacing consistent. Maintain a minimum of 3" distance between the shower curb and wire.

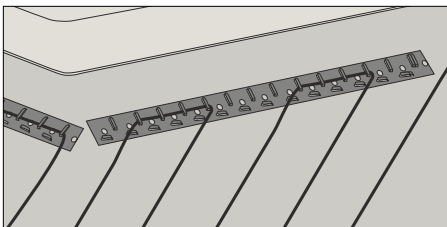

STEP 4.15

Fill in the section with cable. Make sure that the cables are spaced evenly and parallel to one another.

Door entryway using CableStrap

STEP 4.16

For an entryway or other small area where warmth is required, cut small sections of strap to fit the ends of that area. Keep wire 3" away from the framing.

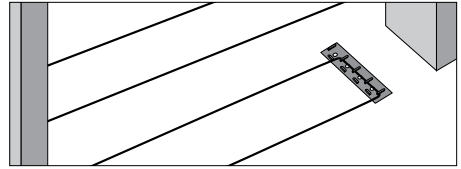

STEP 4.17

Fill in with cable, adjusting spacing as necessary to fill in as much of the area as possible.

Bench Seat

STEP 4.18

If covering a bench seat or step area (not in a shower area), place a single run of cable up the riser. Use CableStrap to secure the cable to the seat area at the desired spacing, then install a single run down the riser. Use an "s-shaped" curve to avoid sharp bends in the cable at corners and help the cable to lay flat. Again, the cable on the riser and seat area MUST be fully embedded in mortar and have approved floor coverings. Use hot glue where necessary to secure the cable flat against the riser.

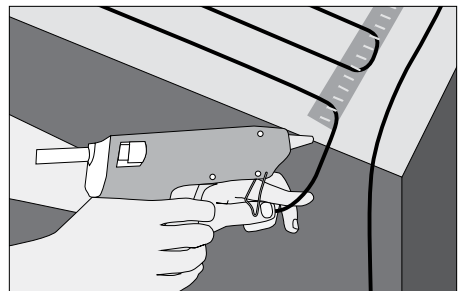

Phase 5 - Shower Area Installation

NOTICE

This application into a shower area must be verified by the local inspector or the authority having jurisdiction (AHJ).

STEP 5.1

Cables only with (-W) on the nameplate label may be installed into a floor or bench seat located in a shower area. It must never be installed into walls. In general, the cable should be completely embedded into mortar as close to the surface coverings as possible. The cable may be placed directly below the tile or stone coverings for the best performance by using hot glue to secure the cable to the substrate.

If HeatMatrix or CableStraps are intended to be used instead, two methods may be used to help avoid obstructing the flow of water to the drain when grout sealants begin to degrade: (1) Place the HeatMatrix or CableStrap below the waterproofing system used, or (2) place a 3" wide strip of HeatMatrix or CableStrap only around the perimeter of the shower floor and cover above this with HeatMatrix Joint Strip or similar waterproofing and use hot glue everywhere else to secure the cable.

See the Appendix for an example of this type installation.

⚠ CAUTION

Do not secure HeatMatrix or CableStrap with fasteners that may penetrate the waterproofing membrane.

It is recommended that a dedicated cable be installed in the shower area separate from the rest of the bath floor. In case there is ever a problem with the shower installation, this cable could be disconnected without loss of heat to the rest of the floor.

STEP 5.2

Make sure the power lead factory splice (the connection between the power leads and the heating cable) is located outside the shower area and at least 1' away from shower openings and other similar areas normally exposed to water. Make sure the control is located at least 4' away from shower openings such that it cannot be exposed to water or touched by a person in the shower area.

STEP 5.3

If the heating cable must enter the shower area over a curb, secure the cable at the edges in an "s-shaped" curve to ensure the cable is not bent sharply or pinched when surface coverings are installed. If the cable is installed below the waterproofing membrane, the curb surface may be notched 1" wide and 1/8" deep to help the cable lay flat, and coated with mortar before applying the waterproofing. Do not damage any waterproofing components, and do not run the heating cable through a non-masonry curb, causing it to overheat.

STEP 5.4

Fill in the floor area with cable. Around the drain leave at least 2" spacing from the edge of the flange. Make sure cable is not placed where door hardware, handrails, or other items may mount to the floor.

SunStat Thermostat

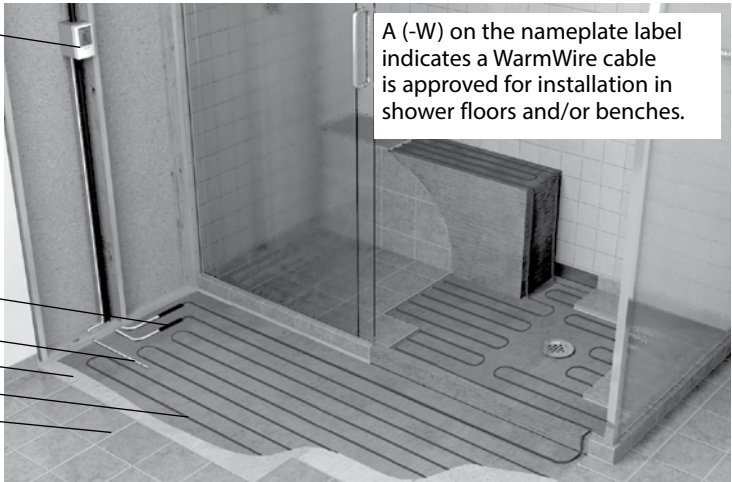

A (-W) on the nameplate label indicates a WarmWire cable is approved for installation in shower floors and/or benches.

Factory Splice

Floor Sensor

Thin Set Mortar

WarmWire

Tile/Stone

STEP 5.5

If covering a bench seat in the shower with cable, secure it with hot glue or with HeatMatrix or CableStrap located underneath waterproofing. Do not use fasteners that penetrate any waterproofing membrane or waterproofing system. Use hot glue to secure a single run of cable up the side of the bench riser. Fill in the seat area with cable. Then secure a single run of cable down the riser if needed. Use an "s-shaped" curve to avoid sharp bends in the cable at corners and help the cable to lay flat.

STEP 5.6

If the cable cannot exit the shower area, the end of the cable has a waterproof splice that may be located in the shower area, fully embedded into the mortar like the heating cable.

STEP 5.7

If any part of the heating cable entering a shower area is damaged during installation, **do not attempt to repair it**. A field repair or modification of the cable may result in serious shock hazard.

Phase 6 - Final Steps

STEP 6.1

After the cable installation is completed, inspect the work. Make sure cable spacings are correct and consistent, having no place where cables are less than 2" spacing, nor greater than 4" spacing in the heated areas, no cables cross over each other, all the cables are undamaged, and all areas to be heated are covered with cable.

STEP 6.2

Take resistance readings of the cable again to make sure it has not been damaged during the installation. This is very important to do. Record these readings in the Cable and Sensor Resistance Log (Table 4).

STEP 6.3

Lay cardboard, carpet, or similar material over the cables to protect them from damage until the floor covering is installed.

Phase 7 - Finish Wiring

STEP 7.1

Feed the power leads from the cable up through the hole drilled in the baseplate, or up into the conduit to the control electrical box (or junction box if one was used).

STEP 7.2

Below the control, or wherever the floor sensor is to be located, measure at least 1 ft. into the heated area. Mark the spot where the sensor will be attached to the floor. Be sure to locate the sensor exactly between two of the heating cables.

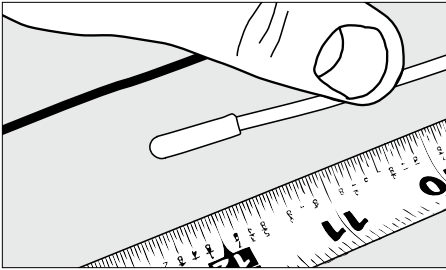

When using HeatMatrix, the sensor wire is pressed into the channel between 2 wire rows. For 3-shape spacing, the sensor is placed at an angle with a small portion of the membrane cut out to allow the sensor to sit flush. For 4-shape spacing, the sensor is positioned in the channel exactly between 2 wires. Do not install the sensor between wire spaced 2-shapes apart.

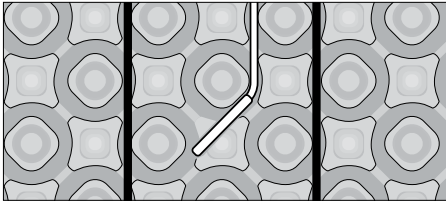

3-shape spacing

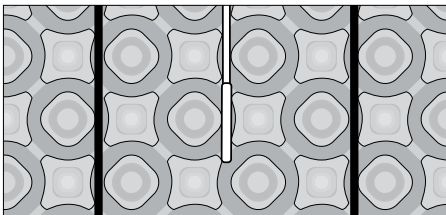

4-shape spacing

STEP 7.3

To make sure the sensor tip does not create a high spot in the floor, it may be necessary to chisel a channel into the floor and lay the sensor tip into the channel. Hot glue the tip into place.

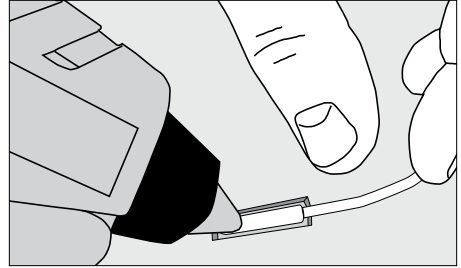

STEP 7.4

Feed the sensor wire up to the control box. Finish by securing a steel nail plate over the wires to protect them against baseboard nails later.

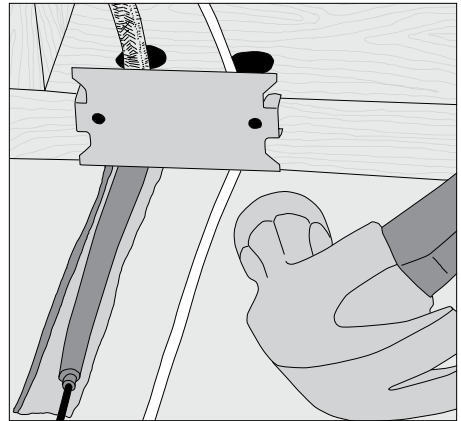

STEP 7.5

If it was necessary to end a power lead at a junction box, feed 14- or 12-gauge electrical wire from this box to the control box.

Tip: If more than one cable was installed, label the ends of the power leads with a brief description as to which area they supply power. Use tape to label them "Cable 1," "Cable 2," "Kitchen," "Bath," or similar. This will make it easier to identify the leads later on. Take photos of the installation. This will provide a useful record for any future needs.

Phase 8 - Control Installation

STEP 8.1:

If it has not already been done, install an electrical box for the SunStat® thermostat and SunStat Relay. See Step 2.2 for details.

STEP 8.2

Read and follow the instructions included with the SunStat thermostat and SunStat Relay for complete connection instructions, requirements, and mounting.

STEP 8.3

Make any final connections to the circuit breaker or branch circuit source.

WARNING

Make sure 120 VAC is supplied to 120 VAC cables and 240 VAC is supplied to 240 VAC cables. Otherwise, dangerous overheating and possible fire hazard can result.

STEP 8.4

System Start Up

After all controls are installed, do not energize the system, except to briefly test operation of all components (no longer than 10 minutes). **Do not put the system into full operation until the tile or flooring installer verifies all cement materials are fully cured (typically two to four weeks).** See mortar manufacturer's instructions for recommended curing time.

NOTICE

Refer to the installation sheets provided with the controls for proper setting. The system should now operate as designed. **Please leave this instruction manual, SunStat Control instructions, and copies of photos of the installed heating system with the end user.**

NOTICE

Most laminate and wood floor manufacturers specify their flooring should not be subjected to temperatures over 82° to 84°F (27° to 28°C). Check with the flooring dealer or manufacturer and set the thermostat Floor Limit temperature appropriately.

Phase 9 - Floor Coverings / General Recommendations

NOTICE

Please note, this installation manual is not a structural or a floor covering installation manual and is intended only for general guidance as it applies to the SunTouch WarmWire product. It is recommended to consult with professional flooring installers to make sure proper materials are used and proper installation techniques are followed.

When installing tile or stone, the Tile Council of North America (TCNA) guidelines or ANSI specifications should be followed as a minimum standard.

A latex-modified thin-set cement-based mortar and grout is recommended instead of water-based multi-purpose materials when installing a radiant product.

NOTICE

Do not use solvent based adhesives or pre-mix mortars because they are not as heat resistant and do not conduct heat well.

- When installing over HeatMatrix, read and follow the instructions given with the HeatMatrix product. Apply the mortar by filling all voids in the HeatMatrix with the flat side of the trowel, then comb to ensure 100% coverage. Avoid lining up tile grout lines with joints between sections of HeatMatrix.
- Select the proper size trowel for the installation of tile or stone. We recommend a minimum 3/8" x 1/4" trowel. This trowel works well for most ceramic tile. A thicker thin-set can be used if required. Select the thin-set thickness in accordance with the floor covering requirements.
- For additional information on tile installation, please contact TCNA at 864-646-8453 or visit their web site at www.tileusa.com, or contact NTCA at 601-939-2071 or see their web site at www.tile-assn.com.
- When installing floor coverings other than tile or stone, follow industry and/or manufacturer's recommendations. Ensure the wire is first covered with a layer of self-leveling cement based mortar, letting it cure fully before applying any surface underlayment, floating wood or laminate flooring, carpet, etc.
- With 3" or 3.5" spacing, the combined R-values of all floor coverings over the wire should not exceed R-2.5. With 2.5" spacing, the combined R-value should not exceed R-1.5. Higher R-values will diminish performance and trap too much heat. Consult the floor covering manufacturer to verify compatibility with radiant electric heat.
- Make sure nails, screws, or other fasteners do not penetrate the floor in the heated area. The wire can easily be damaged by fasteners penetrating the floor.
- All floor coverings must be in direct contact with the cement-based mortar encasing the wire. Do not elevate the floor above the mortar mass.
- Do not install 2" x 4" wooden nailers (sleepers) on top of a slab for the purpose of attaching hardwood. Any air gap between the heating wire and the finished floor covering will drastically reduce the overall output of the heated floor.
- Care should be taken when laying area rugs, throw rugs, and other surface products on the floor. Most products are okay to use, but if in doubt, consult the product manufacturer for compatibility. Do not use rubber backed products.
- When placing furniture make sure an air clearance of at least 1-1/2" is available. Furniture able to trap heat can damage the heating system, the flooring, and the furniture over time.
- After floor coverings have been installed, take resistance readings of the cable again to make sure it has not been inadvertently damaged. Record these readings in the Cable and Sensor Resistance Log (Table 4).

Phase 10 - Install Insulation

Insulate under the subfloor for better performance and efficiency of the system. Refer to the Appendix for diagrams and insulation recommendations.

Appendix 1: Minimum Clearances for WarmWire

	Minimum Clearance
Bathroom vanity or kitchen cabinet toe-kick	1"
Showers or tub boundaries	3"
Doorway framing	3"
Walls	3"
Toilet flange	6"
Other heating wire	2"
Heating cable power lead	1"
Appliances (washer, dryer, oven)	1"
Baseboard heaters or radiators	3"
Below a built-in, cabinet, furniture	1-1/2"
Drains	2"

Do not install WarmWire in closets, pantries or in other small enclosed spaces.

Appendix 2: Types of Construction and Applications

Types of Construction

Tile or stone applications with HeatMatrix

To install tile or stone over HeatMatrix and WarmWire, refer to the manufacturers recommendations on mortar type, notch size and curing time. For areas exposed to surface water, the seam between rows of HeatMatrix should be sealed with HeatMatrix Joint Strip. This is done by troweling a strip of mortar over the seam, then pressing Joint Strip into the mortar. Ensure these sections are as flush with the adjacent surfaces as possible. Once set, the tile can be installed over these areas as usual.

Laminate, resilient or hardwood over HeatMatrix

When applying mortar over HeatMatrix in this application, the finish must be smooth instead of notched. Do not use nails or screws to attach any type of flooring to the finished mortar surface. A 'floating' floor installation is typically recommended for wood or laminate flooring due to expansion and contraction caused by changes in floor temperature. When selecting floor coverings, the R-value should not exceed R-2.5. when using 3" or 3.5" wire spacing and not exceed R-1.5 when using 2.5" spacing.

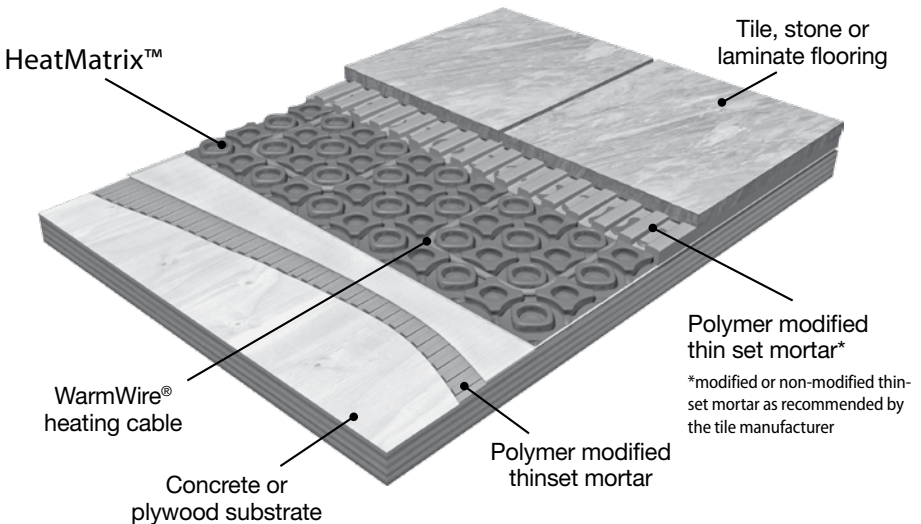

Mortar Applications with CableStrap:

1. If a backer board or plywood sheeting is used to strengthen the floor, or if the heating wire will be placed directly onto the slab, install WarmWire in the thin-set mortar bond coat above these materials.
2. If a thicker mortar bed, or self-leveling concrete, is used to strengthen the floor, the heating wire can be installed in either the mortar bed (dry-set) or in the mortar bond coat directly below the tile or stone.

The heating wire is generally installed above the self-leveling mortar in a thin-set bond coat. Use plastic lath instead of the typical metal lath when installing in a self-leveling layer.

Self-leveling mortar with CableStrap:

Self-leveling mortar may be used in CableStrap / WarmWire installations when the finished surface needs to be smooth. This applies to engineered wood, vinyl, laminate, or carpet floor coverings. Attach the WarmWire to CableStrap on the subfloor or slab, then pour self-leveling mortar 1/4" to 1/2" thick according to manufacturer's specifications. Install floor covering after the mortar has fully cured.

Special Precautions

Isolation Membrane: Install the heating wire above the membrane, whenever possible, unless recommended otherwise by the membrane manufacturer.

Insulation: Insulation dramatically enhances the performance and efficiency of floor-warming systems. Do not install rigid insulation directly above or below backer board or mortar.

Mosaic Tile: When installing mosaic tile, it is recommended to apply a two-step process. First, embed the heating wire in a thin self-level mortar bed (1/4"-3/8"), then thin-set the mosaic tile according to typical practice.

Expansion Joints: Do not install heating wires through an expansion joint. Install heating wire right up to the joint, if necessary, but not through the joint.

⚠ CAUTION

Never bang a trowel on the Heating Wire to remove excess mortar from the trowel. This could damage the heating wire.

Double-plywood over frame floor

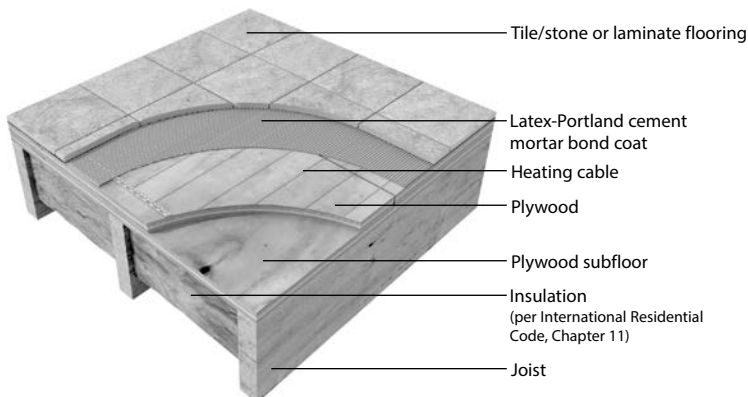

Cement backboard over frame floor

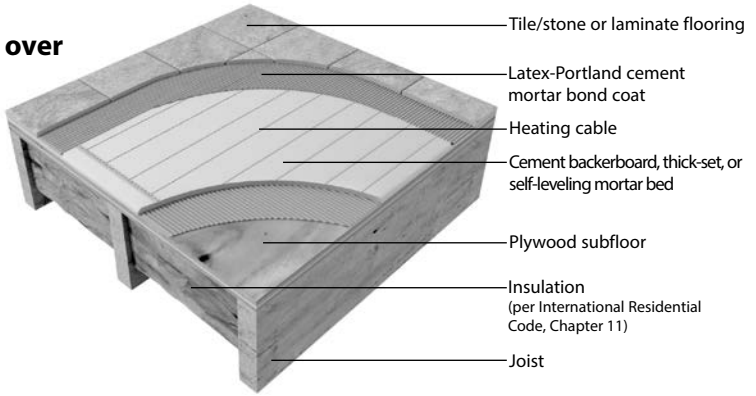

Thin-set over slab on grade

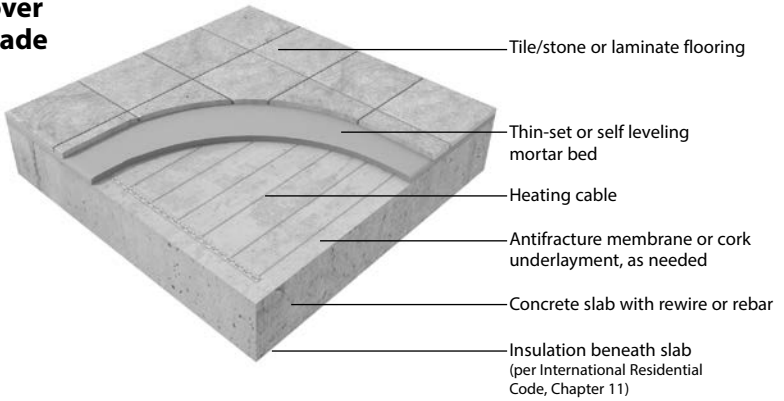

Connecting Multiple Cables

⚠ WARNING

To prevent the risk of personal injury and/or death, do not perform any electrical work unless qualified to do so. Work should be done with great care and with power turned off to the circuit being worked on. Follow all local building and electrical codes.

SunStat / Relay Connections

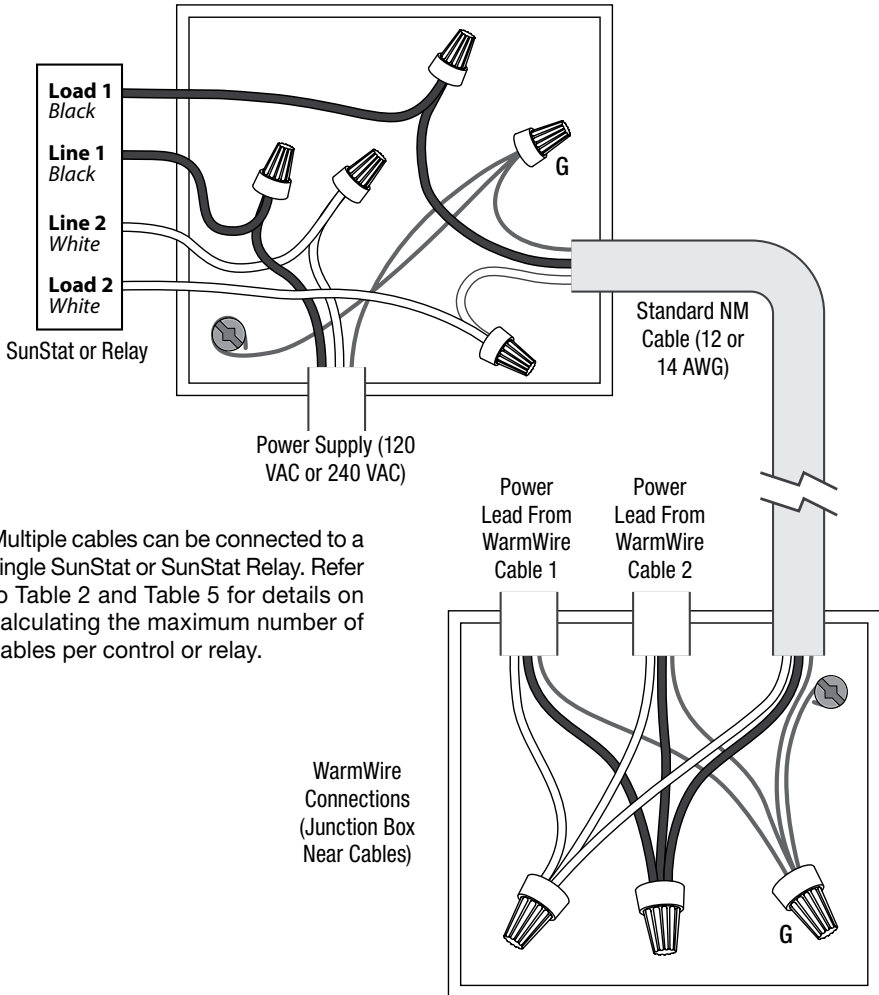

Multiple cables can be connected to a single SunStat or SunStat Relay. Refer to Table 2 and Table 5 for details on calculating the maximum number of cables per control or relay.

WarmWire
Connections
(Junction Box
Near Cables)

⚠ WARNING

The SunStat is not fully illustrated in these diagrams in order to simplify them. These diagrams are given only as examples of how to properly connect multiple cables. Care must be taken not to overfill a box. Be sure to use wire nuts that are the correct size for the connections being made. Follow all codes for wiring.

All electrical work must be done by a qualified licensed electrician in accordance with local building and electrical codes, and the National Electrical Code (NEC), especially Article 424 of the NEC, ANSI/NFPA70 and Section 62 of CEC Part 1.

Appendix: Sample Layouts

Kitchen and Family Room (normal heat loss, slab on grade with insulation)

Two zones, 240 volts: Three cables. 190 ft. of CableStrap, or eight 25-ft. rolls.

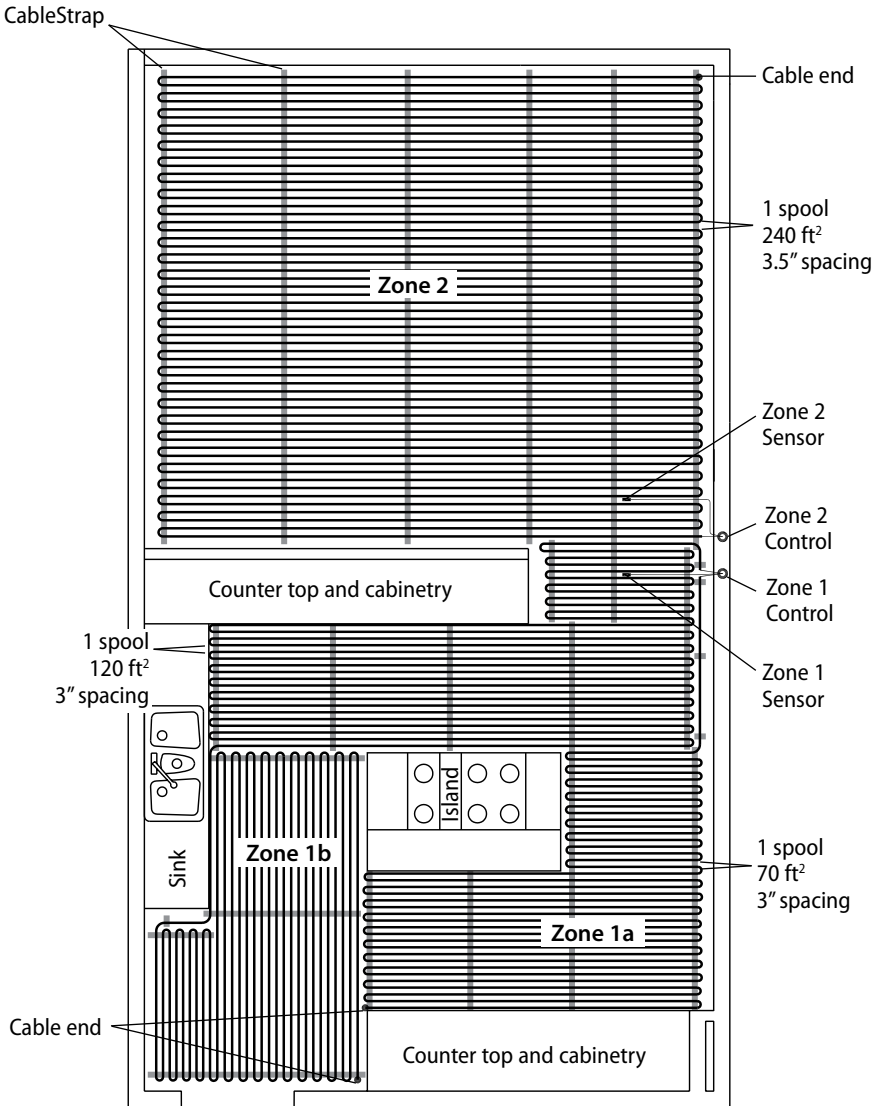

Kitchen and SunRoom (normal and high heat loss, framed floor construction)
One zone, 240 volts: Two cables. 104 ft. of CableStrap, or five 25-ft. rolls.

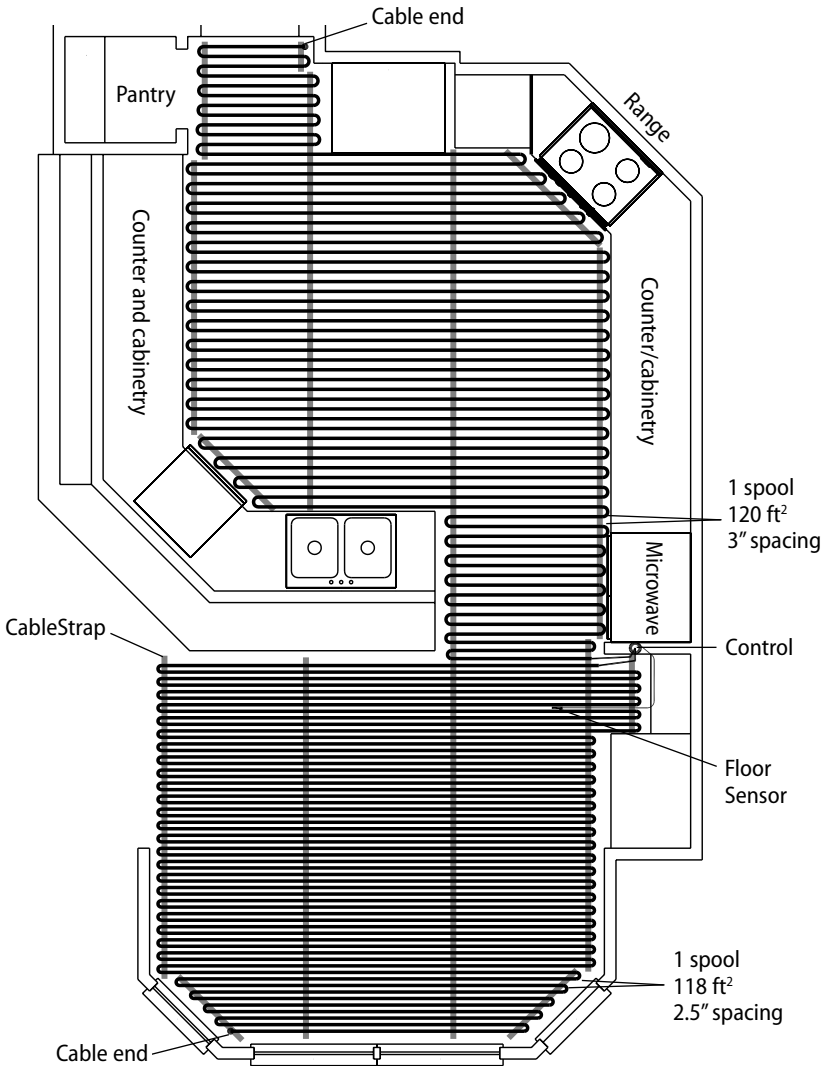

Master Bathroom (normal heat loss, framed floor construction)

One zone, 120 volts: One cable. 35 ft. of CableStrap, or two 25-ft. rolls.

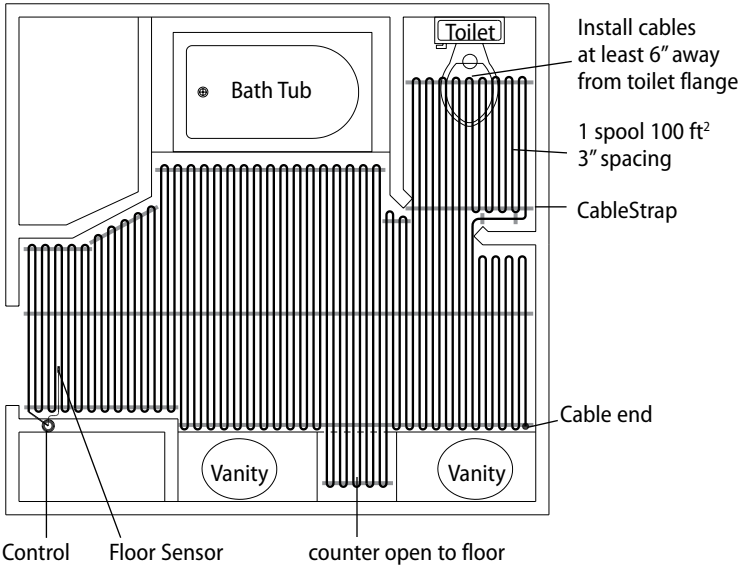

Master Bathroom

(normal heat loss, framed floor construction)

One zone, 120 volts: One cable. 49 ft. of CableStrap, or two 25-ft. rolls.

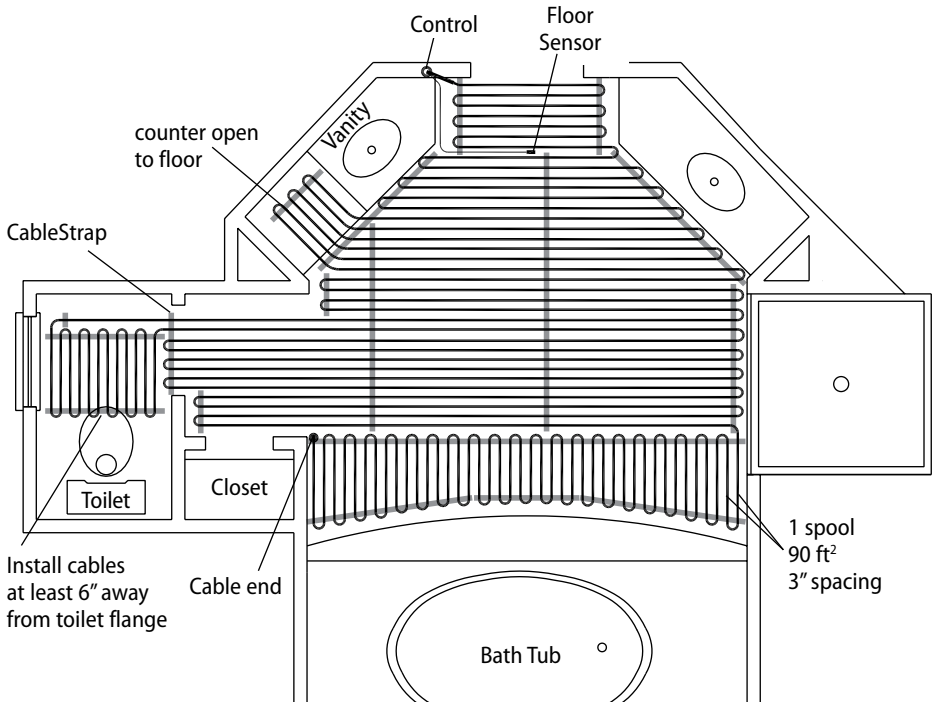

Basement Bathroom (high heat loss, below grade basement slab)

One zone, 120 volts: One cable. 39 ft. of CableStrap, or two 25-ft. rolls.

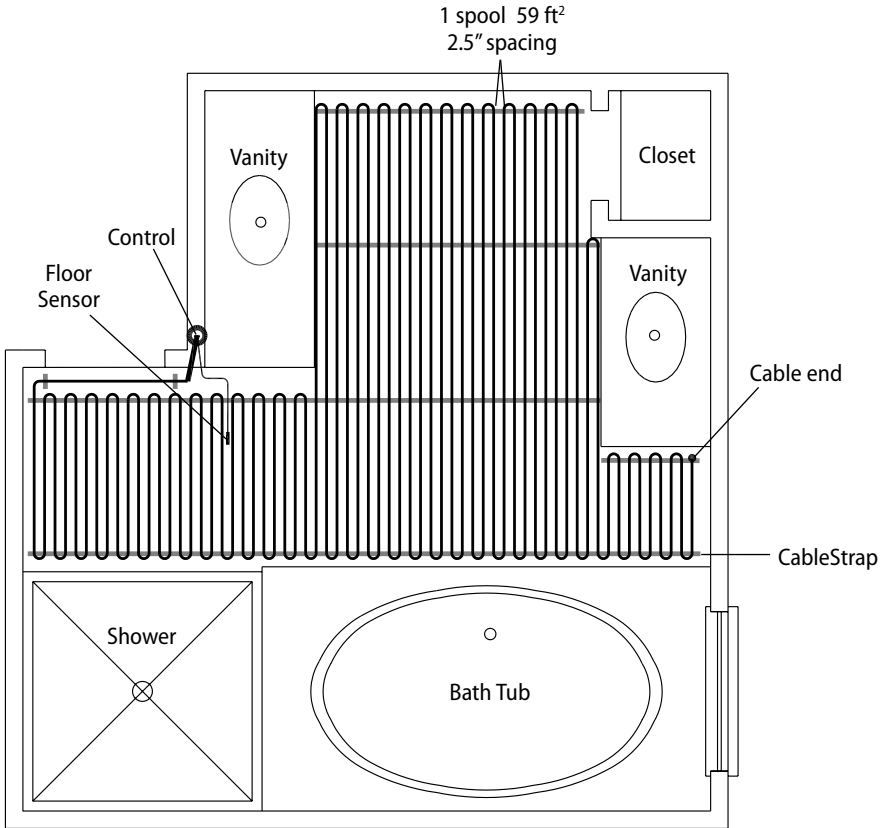

Master Bathroom (normal heat loss, framed floor construction)

Two zones, 120 volts: Two Cables

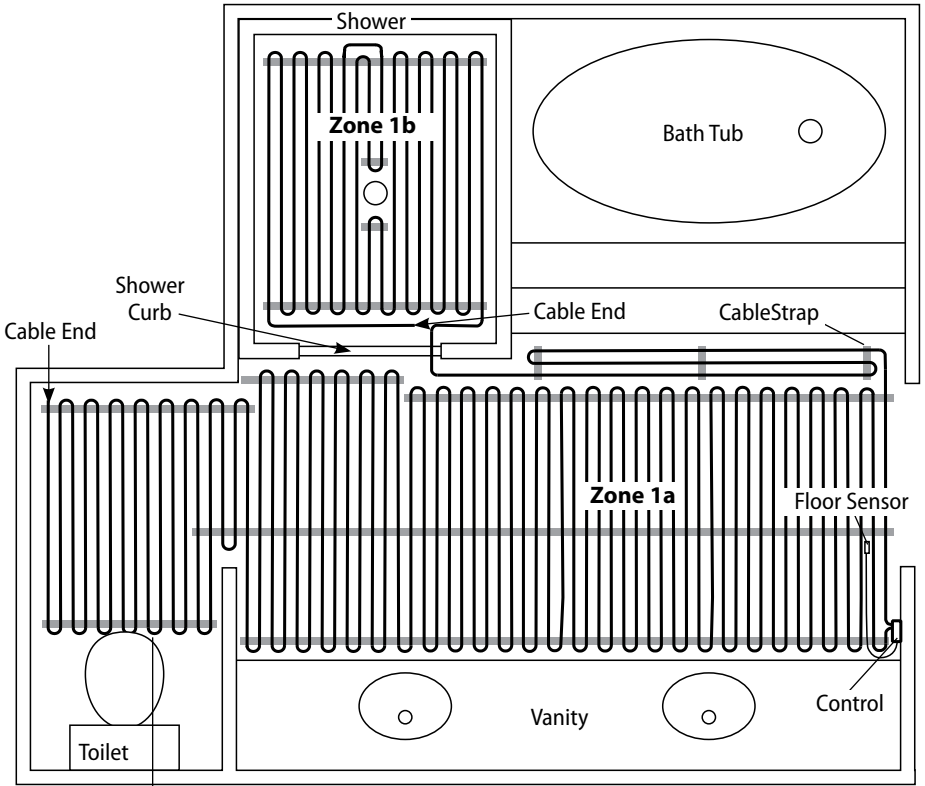

Install cables at least 6" away from toilet rings

Example of Cables only with (-W) on the nameplate label, where cable is installed in a shower area and enters over the curb.

Shower Details

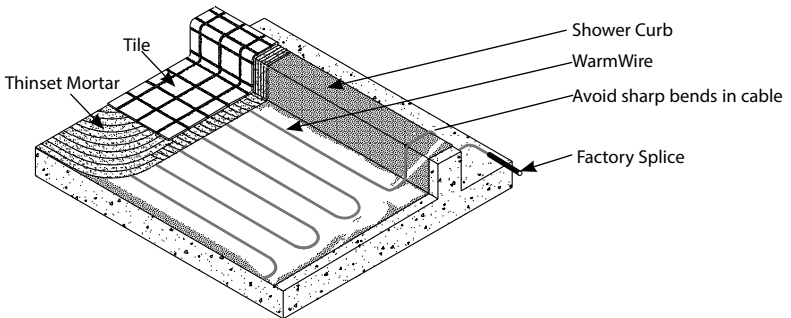

Installing WarmWire above the waterproof liner

WarmWire can be installed above the waterproofing liner if the attachment method does not puncture the liner. A overlay of thinset is first applied over the liner. CableStrap or 2-inch HeatMatrix strips are then attached to opposite sides of the shower using hot glue or double sided tape. Leave a 2 inch gap between the drain flange and WarmWire. When using HeatMatrix, strips are covered with mortar and Joint Tape after the wire is in place. This reduces the chance of water becoming trapped in the low sections of the HeatMatrix membrane. Ensure WarmWire is fully embedded within a cement based mortar before tiling.

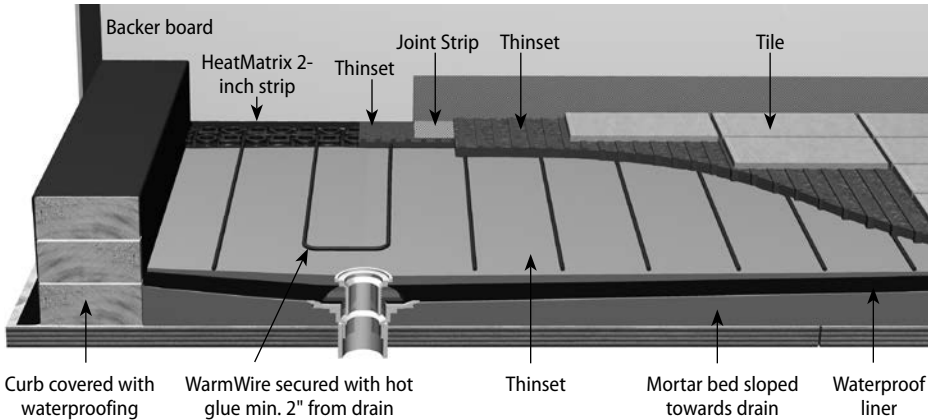

Installing WarmWire below the waterproof liner

WarmWire can be installed on a sloped mortar bed below the waterproof liner layer using CableStrap or a 2-inch strip of HeatMatrix. Ensure the WarmWire and CableStrap or HeatMatrix are fully covered in mortar, and trowel to provide a smooth finished surface. Apply waterproof liner over the smoothed mortar surface according to the liner manufacturer's instructions. Ensure the coverings above the waterproof liner do not exceed R-0.5 to avoid capturing too much heat.

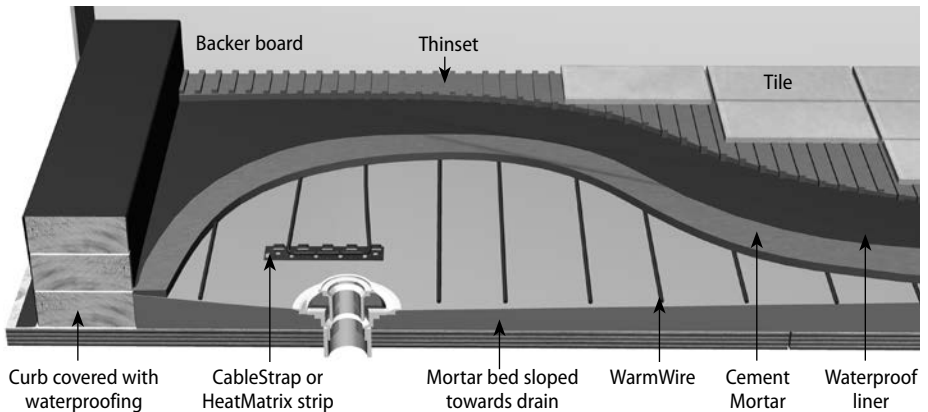

NOTICE

See phase 5 for complete details and Cautions. This application into a shower area must be verified by the local inspector or the authority having jurisdiction.

Troubleshooting Guide

If not qualified to perform electrical installations, it is strongly recommended that a qualified, licensed electrician be hired to install the heating cables and related electrical components. If problems with the system arise, please consult the troubleshooting guide below.

WARNING

Any electrical troubleshooting work should be performed with the power removed from the circuit, unless otherwise noted.

Problem	Possible Cause	Solution
Cable resistance measurement is outside the range printed on the nameplate label.	An analog ohmmeter (using a moving needle) was used to take the reading.	Obtain a digital ohmmeter able to read 0 to 20,000 ohms and remeasure the resistance.
	If measurement shows an open or short circuit, the cable has been damaged.	Record resistances between all wires and contact the manufacturer.
	If measurement is just a little low or high, room temperature has affected the resistance.	Make the room temperature 65°–75°F (18°–24°C), or contact the manufacturer.
	The resistance measurement could be from more than one cable wired in series, or wired in parallel. Either will provide false resistance readings.	Make sure resistance measurements are for only one cable at a time.
	The multi-meter may be set to the wrong scale.	The ohmmeter should typically be set to the 200 (200Ω) scale. For heating wire with resistance range higher than 200 ohms on the nameplate label, set the meter to the 2000 ohm (2kΩ) scale.
Floor does not get warm.	Cable has been damaged.	Measure cable resistance. Check for both “open circuit” and “short circuit” as detailed earlier in this manual. If damaged, record resistances between all wires and contact the manufacturer.
	GFCI has tripped, indicated by a light on the control or “GFCI TRIP”.	Check for loose wire connections. Reset the GFCI on the control or circuit breaker. If it trips again, check for a short circuit in the cable as detailed earlier in this manual. If cable is damaged, record resistances between all wires and contact the manufacturer. If cable is not damaged, replace the GFCI control. Also see “GFCI conflicts” below.
	Incorrect voltage supplied, or mismatched electrical components used.	Measure “line” voltage, 120 VAC cables have black and white leads. 240 VAC cables have black and blue leads.
	Uninsulated concrete slab floor.	Surface temperatures rise slowly on an uninsulated slab and heat is lost to the ground below. If, after 5 to 8 hours of heating, the floor is not warmer to the touch, check for cable damage (see “Cable has been damaged” above). Measure “load” voltage/ amperage to cable.
	Cables are wired in “series” or “daisy chained” (end-to-end).	Multiple cables must be connected in “parallel” (or black-to-black, white-to-white).

Problem	Possible Cause	Solution
Floor heats continuously.	Incorrect wiring. The control was “bypassed” when it was wired to the power supply.	Make sure wiring connections are correct. Consult the wiring diagram on the back of the control, the instructions that came with the control, or the wiring diagrams in the Appendix.
	Defective control.	Return control to dealer for replacement.
Control is not working correctly.	If a programmable control, the programming may be incorrect.	Carefully read and follow control programming instructions.
	Incorrect voltage supplied, or mismatched components used.	Test voltage, verify parts. See “Incorrect voltage supplied” section
	Floor sensor is not wired properly, or is not working properly.	Make sure only one floor sensor is connected to the control.
	Loose connection(s) on line side and/or load side of control.	Remove and reinstall the wire nuts at each connection. Make sure the wire nuts are tight. Check all connections back to the breaker.
	Defective control.	Return control to dealer for replacement.
Control is not working at all.	No power is supplied.	Check circuit breaker. Measure voltage at the control. Check all connections between breaker and control.
	Floor sensor is not wired properly, or is not working properly.	Make sure only one floor sensor is connected to the control.
	Defective control.	Return control to dealer for replacement.
GFCI conflicts and false-trips.	An electric motor or a ballasted light source is sharing the circuit with the cable(s).	Electric motors and similar electrical devices can cause a GFCI to false-trip. Run a dedicated circuit to the floor-warming system or select a different branch circuit.

Although this troubleshooting guide is provided to assist with problems experienced with a floor-warming system, results are never guaranteed. The company does not assume any liability or responsibility for damage or injury that may occur from using this guide.

If problems with the system persist, call the manufacturer.

WARNING: This product contains chemicals known to the State of California to cause cancer and birth defects or other reproductive harm. For more information: www.watts.com/prop65

Electric Floor-warming Products 25-year Limited Warranty

SunTouch and Watts Radiant (the Companies) warrant their respective electric floor heating mats and cables (the Products) to be free from defects in materials and workmanship for twenty-five (25) years from the date of manufacture. Thermostats and controls sold by the Companies are warranted, parts and materials, for two (2) years from the date of purchase. The sole remedy for controls is product replacement. This warranty is only provided to customers who purchase the Products from authorized resellers, and is transferable to subsequent owners of properties where the Products are initially installed.

Under this Limited Warranty, the Companies will provide the following:

If the Product is determined by the Companies to be defective in materials and workmanship, and has not been damaged as a result of abuse, misapplication or modification, the Companies will refund all or part of the manufacturer's published list price of the Product at the time of purchase in accordance with the following: 100% for the first ten (10) years, then prorated on a diminishing 25-year scale for the remaining warranty period.

For example:

- (1) Product found defective in the 5th year will receive the full manufacturer's published list price of the Product at the time of purchase;
- (2) Product found defective in the 15th year, with 10 years remaining in the warranty period, will receive 10/25ths of the manufacturer's published list price of the Product at the time of purchase.

In order to make a claim, you must:

- (a) Provide the Company with sufficient details relating to the nature of the defect, the installation, the history of operation, and any repairs that may have been made.
- (b) At the Company's discretion and at the owner's expense, ship the Product to the Company or the Company's local representative or distributor.
- (c) Provide proof that the Product was installed in accordance with the applicable Product Installation Manual and any special written design or installation guidelines by the Companies for this project.
- (d) Provide proof that the Product was installed in accordance with the National Electrical Code (NEC) or the Canadian Electrical Code (CEC), and all applicable local building and electrical codes.
- (e) Provide a retail sales receipt or proof of purchase.

The following are not covered by this Limited Warranty:

- (a) Any incidental or consequential damage, including inconvenience, loss of time or loss of income.
- (b) Any labor or materials required to repair or replace the Product or control, not authorized in writing by the Company.
- (c) Any labor or materials required to remove, repair or replace flooring materials.
- (d) Any freight or delivery costs related to the Product, the control, or any related flooring or electrical products.

The Companies assume no responsibility under this warranty for any damage to the Product caused by any trades people, visitors on the job site, or damage caused as a result of post-installation work. The staff at the Company is available to answer any questions regarding the proper installation or application of the Product at this toll-free phone number: 800-276-2419. If you are ever in doubt about the correct installation procedure to follow, or if the Product appears to be damaged, you must call us before proceeding with the installation, or proposed repair.

THE COMPANIES DISCLAIM ANY WARRANTY NOT PROVIDED HEREIN, INCLUDING ANY IMPLIED WARRANTY OF MERCHANTABILITY OR IMPLIED WARRANTY OF FITNESS FOR A PARTICULAR PURPOSE. THE COMPANIES FURTHER DISCLAIM ANY RESPONSIBILITY FOR SPECIAL, INDIRECT, SECONDARY, INCIDENTAL, OR CONSEQUENTIAL DAMAGES ARISING FROM OWNERSHIP OR USE OF THIS PRODUCT, INCLUDING INCONVENIENCE OR LOSS OF USE. THERE ARE NO WARRANTIES WHICH EXTEND BEYOND THE FACE OF THIS DOCUMENT. NO AGENT OR REPRESENTATIVE OF THE COMPANIES HAS ANY AUTHORITY TO EXTEND OR MODIFY THIS WARRANTY UNLESS SUCH EXTENSION OR MODIFICATION IS MADE IN WRITING BY A CORPORATE OFFICER.

DUE TO DIFFERENCES IN BUILDING AND FLOOR INSULATION, CLIMATE, AND FLOOR COVERINGS, THE COMPANIES MAKE NO REPRESENTATION THAT THE FLOOR TEMPERATURE WILL ACHIEVE ANY PARTICULAR TEMPERATURE, OR TEMPERATURE RISE. UL® STANDARD LISTING REQUIREMENTS LIMIT THE HEAT OUTPUT OF REGULAR MATS AND CABLES TO 15 WATTS PER SQUARE FOOT DEPENDING ON CABLE INSTALL SPACING, AND UNDERFLOOR MATS TO 10 WATTS PER SQUARE FOOT, AND AS SUCH, USERS MAY OR MAY NOT BE SATISFIED WITH THE FLOOR WARMTH THAT IS PRODUCED. THE COMPANIES DO WARRANT THAT ALL PRODUCTS WILL PRODUCE THE RATED OUTPUT LISTED ON THE PRODUCT NAMEPLATE, WHEN OPERATED AT THE RATED VOLTAGE.

Some states do not allow the exclusion or limitation of incidental or consequential damages and some states do not allow limitations on how long implied warranties may last. Therefore, the above limitations or exclusions may not apply to you. This warranty gives you specific legal rights and you may also have other rights, which vary from state to state. SO FAR AS IS CONSISTENT WITH APPLICABLE STATE LAW, ANY IMPLIED WARRANTIES THAT MAY NOT BE DISCLAIMED, INCLUDING IMPLIED WARRANTIES OF MERCHANTABILITY OR FITNESS FOR A PARTICULAR PURPOSE ARE LIMITED IN DURATION TO TWENTY-FIVE YEARS FROM THE DATE OF MANUFACTURE.

Terms and Conditions

Shipping Discrepancies: Incoming materials should be inventoried for completeness and for possible shipping damage. Any visible damages or shortages must be noted prior to accepting the material. Once the receiving personnel accept the material on their dock, they have relieved the freight company of any responsibility. Any discrepancy concerning type or quantity of material shipped, must be brought to the attention of the Companies within 15 days of the shipping date entered on the packing slip for the order.

Return Policy: The Companies items may be returned within one year from the date of purchase, if they are not damaged or used. There will be a 15% restock charge applied to items returned due to overstock or customer order error. All returned items must be in new condition. Products, controls or other parts that have a quality defect will be replaced (not credited) at no charge to the customer. If an item is shipped in error, there will be no restocking charge. All items returned, for replacement, credit or repair, must have a Returned Goods Authorization (RGA) number, or they will not be accepted. Please call our order desk for an RGA number. Products older than one year are excluded from these terms and conditions and may not be returned. No returns will be accepted for the Custom TapeMat product. Products that have been damaged, or Products that have been cut, may not be returned. This includes Products that have had mortar or concrete materials applied to them. These Products cannot be repaired and cannot be resold; therefore, we cannot accept them.

Effective: APRIL 1, 2006. This warranty applies to all Products purchased after this date.

warm*your***floor**[™]
the radiant floor heating experts™ 

Warm Your Floor
20918 Bake Pkwy
Suite 104 & 106
Lake Forest, CA 92630
Toll-free: 866-558-3369
Fax: 866-558-2010
WarmYourFloor.com
