



Plastic Surgery

Scissors	748 - 768
Needle Holders	768 - 772
Forceps	773 - 782
Hooks and Retractors	783 - 793
Aluminum Hand	794
Knives	795 - 797
Suction Instruments	798
Bone Instruments	799 - 807
Micro Vessel Clips and Clamps	808 - 810

Plastic Surgery

Scissors

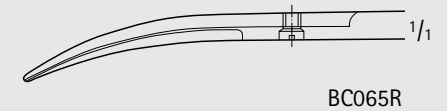
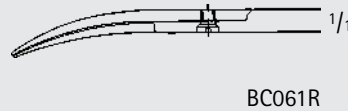
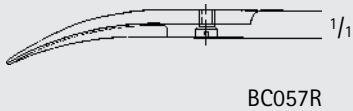
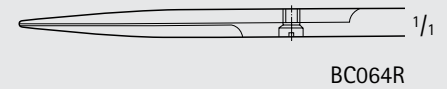
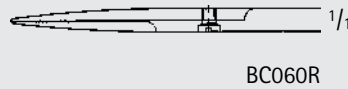
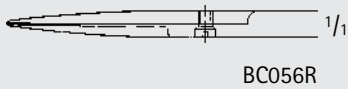
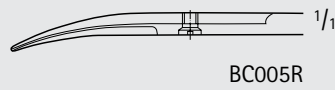
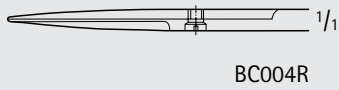
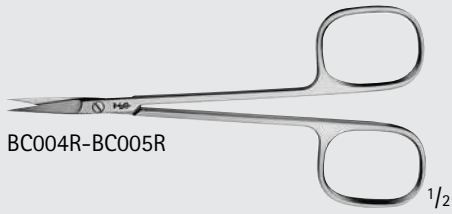
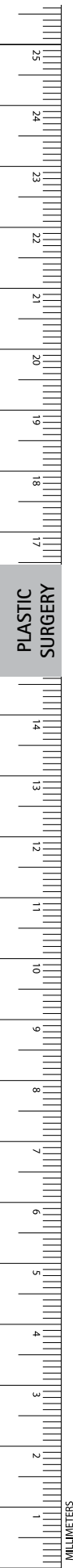

Iris Scissors, Delicate

Catalog Number	Tip	Blade	Handle	Length (in.)
BC004R	S/S	STR	SQUARE	4 1/2
BC005R	S/S	CVD	SQUARE	4 1/2
BC056R	S/S	STR	ROUND	3 3/4
BC060R	S/S	STR	ROUND	4 1/8
BC064R	S/S	STR	ROUND	4 3/4
BC057R	S/S	CVD	ROUND	3 3/4
BC061R	S/S	CVD	ROUND	4 1/8
BC065R	S/S	CVD	ROUND	4 3/4

Iris Scissors, Ribbon Handle

Catalog Number	Tip	Blade	Length (in.)
MB605R	S/S	STR	4
BC190R	S/S	CVD	4



Suture Scissors

Catalog Number	Tip	Blade	Length (in.)
BC130R	S/S	STR	4 3/4
BC140R	S/S	STR	5 1/8
BC144R	B/B	STR	5 1/8
BC135R	B/B	CVD, DEL	4 3/4
BC131R	S/S	CVD	4 3/4
BC141R	S/S	CVD	5 1/8
BC145R	B/B	CVD	5 1/8

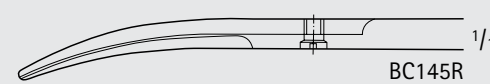
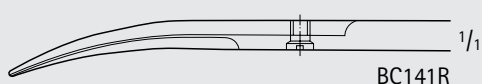
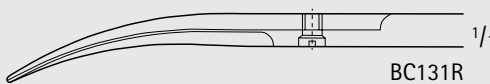
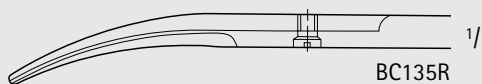
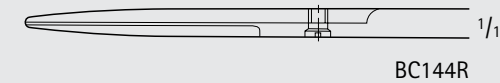
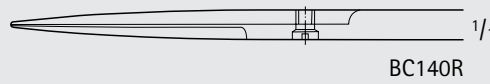
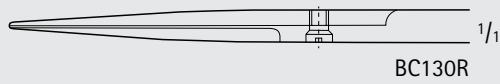

Plastic Surgery

Scissors

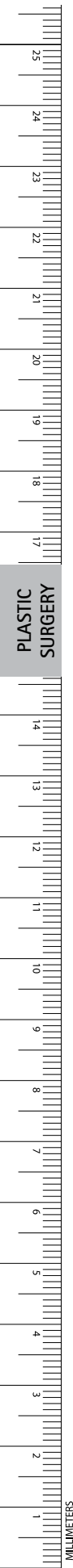

OK365R-OK367R

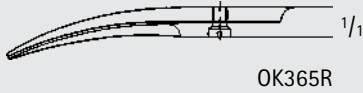

OK365R

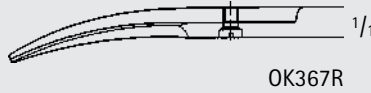

OK367R

COTTLE-MASING Plastic Scissors

Catalog Number	Tip	Blade	Length (in.)
OK365R	S/S	CVD	4 1/8
OK367R	B/B	CVD	4 1/8

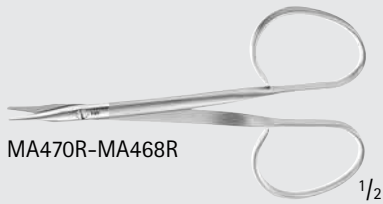

MA470R-MA468R

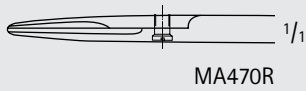

MA470R

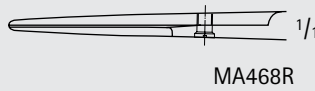

MA468R

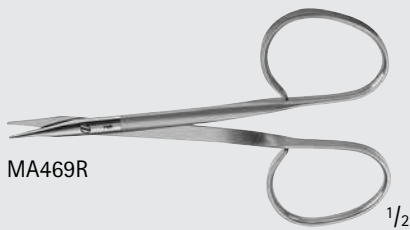

MA469R

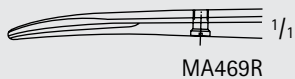

MA469R

STEVENS Tenotomy Scissors

Catalog Number	Tip	Blade	Handle	Weight	Length (in.)
MA470R	B/B	STR	RIBBON	LIGHT	3 3/4
MA468R	B/B	STR	RIBBON	HEAVY	3 7/8
MA469R	B/B	CVD	RIBBON	HEAVY	3 3/4

STEVENS Tenotomy Scissors
(continued)

Catalog Number	Tip	Blade	Handle	Length (in.)
BC008R	S/S	STR	SQUARE	4 1/2
BC010R	B/B	STR	SQUARE	4 1/2
BC009R	S/S	CVD	SQUARE	4 1/2
BC011R	B/B	CVD	SQUARE	4 1/2
BC170R	S/S	STR	ROUND	4 1/4
BC172R	B/B	STR	ROUND	4 1/4
MA467R	B/B	STR	ROUND	5 3/4
BC171R	S/S	CVD	ROUND	4 1/4
BC173R	B/B	CVD	ROUND	4 1/4
MA466R	B/B	CVD	ROUND	5 3/4

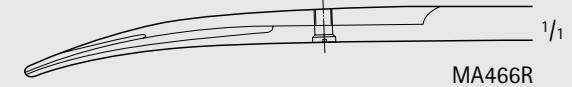
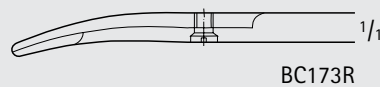
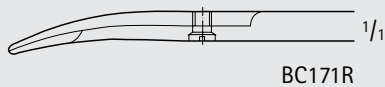
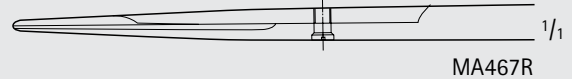
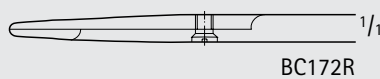
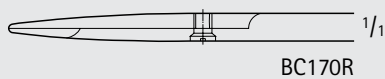
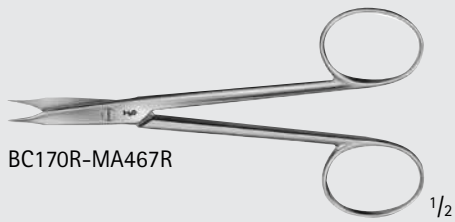
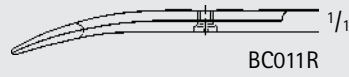
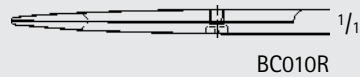
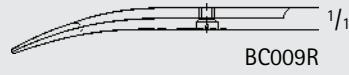
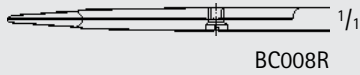
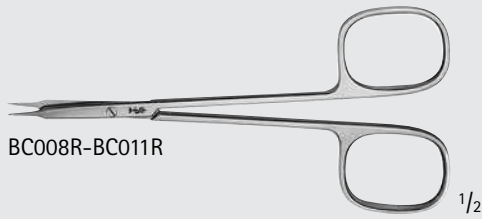

Plastic Surgery

Scissors

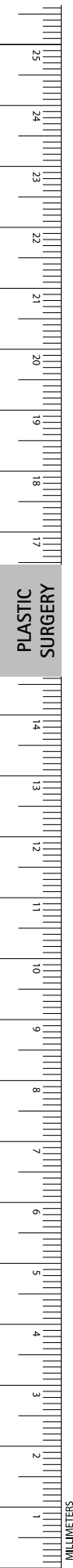

BC194R-BC195R

1/2

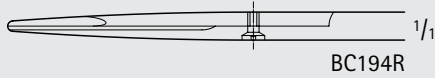

BC194R

1/1

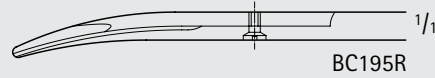

BC195R

STEVENS Tenotomy Scissors, Delicate

Catalog Number	Tip	Blade	Length (in.)
BC194R	B/B	STR	5
BC195R	B/B	CVD	5

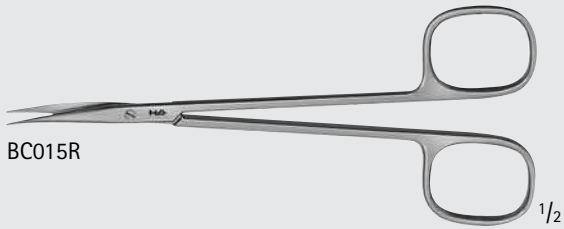

BC015R

1/2

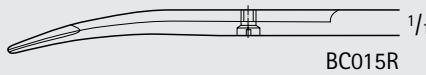

BC015R

1/1

REYNOLDS-JAMESON Tenotomy Scissors, Delicate

Catalog Number	Tip	Blade	Handle	Length (in.)
BC015R	B/B	CVD	SQUARE	5 1/2



BC180R-BC181R

1/2

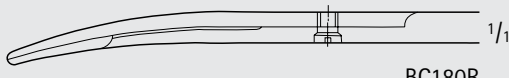

BC180R

1/1

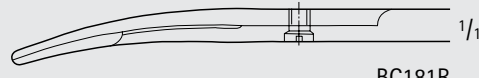

BC181R

REYNOLDS Tenotomy Scissors, Delicate

Catalog Number	Tip	Blade	Length (in.)
BC180R	B/B	CVD	5 3/4
BC181R	B/B	CVD	6 7/8

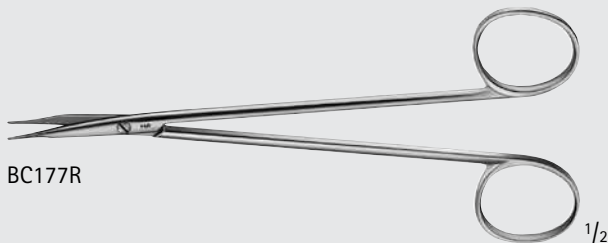

BC177R

1/2

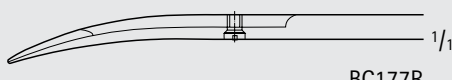

BC177R

1/1

JAMESON Tenotomy Scissors, Delicate

Catalog Number	Tip	Blade	Length (in.)
BC177R	B/B	CVD	6

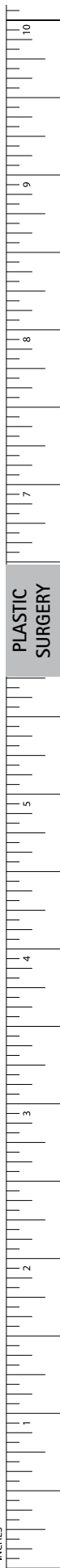

JAMESON SuperCut Scissors, Delicate

Catalog Number	Tip	Blade	Length (in.)
BC911R	B/B	CVD	5 1/8
BC915R	B/B	CVD	6
BC919R	B/B	CVD	7



POTTS Tenotomy Scissors

Catalog Number	Tip	Blade	Length (in.)
BC178R	B/B	CVD	6 7/8
BC179R	B/B	CVD	8

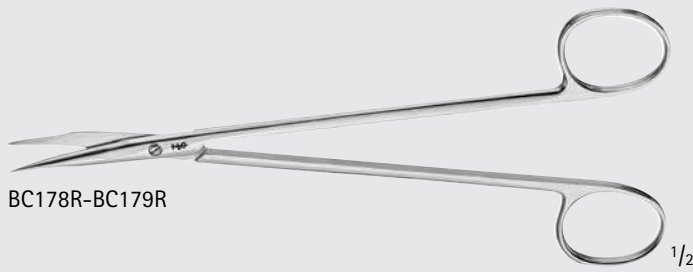

Nerve Dissecting Scissors

Catalog Number	Tip	Blade	Length (in.)
BC628R	S/S	CVD	6

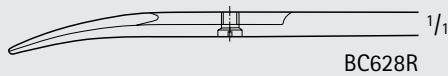
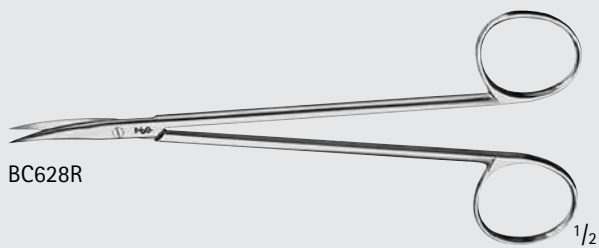

Plastic Surgery

Scissors

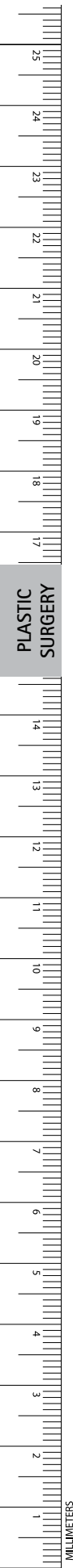

BC006R-BC007R

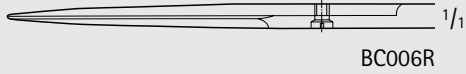

BC006R

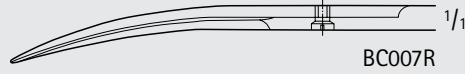

BC007R

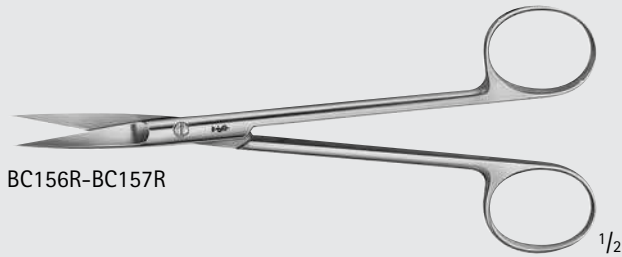

BC156R-BC157R

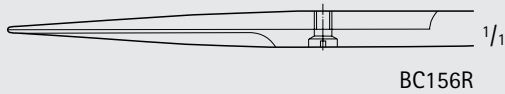

BC156R

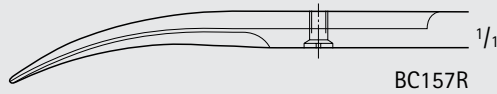

BC157R

JOSEPH Scissors, Delicate

Catalog Number	Tip	Blade	Handle	Length (in.)
BC006R	S/S	STR	SQUARE	6
BC007R	S/S	CVD	SQUARE	6
BC156R	S/S	STR	ROUND	6
BC157R	S/S	CVD	ROUND	6

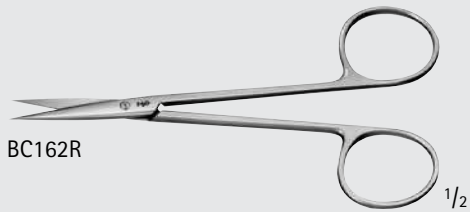

BC162R

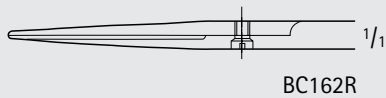

BC162R

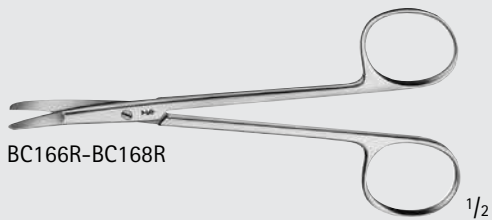

BC166R-BC168R

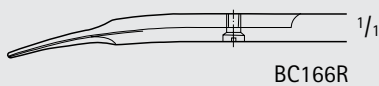

BC166R

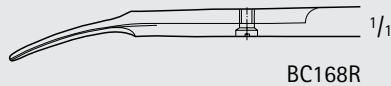

BC168R

KILNER Scissors

Catalog Number	Tip	Blade	Length (in.)
BC162R	S/S	STR	4 1/2
BC166R	FLAT	CVD	5
BC168R	FLAT	CVD	6

Strabismus Scissors

Catalog Number	Tip	Blade	Length (in.)
BC164R	B/B	STR	4 1/2
BC165R	B/B	CVD	4 1/2

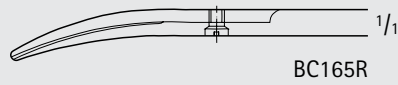
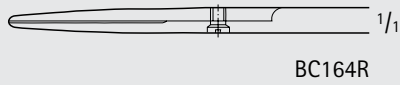

LITTLER Scissors

Catalog Number	Tip	Blade	Length (in.)
BC163R	W/EYE	CVD	4 1/2

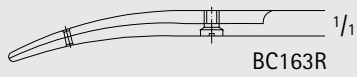

Plastic Surgery

Scissors

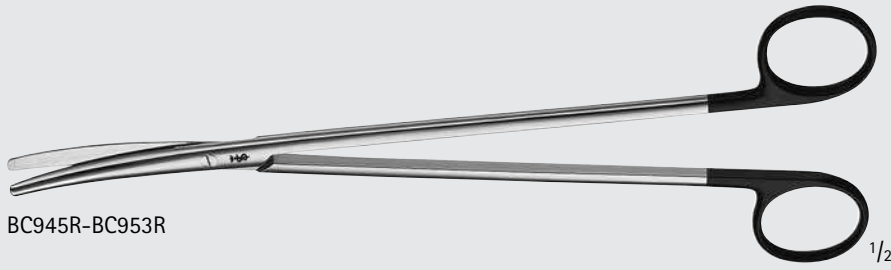
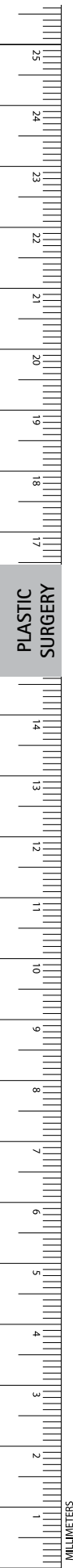

BC945R-BC953R

METZENBAUM SuperCut Scissors

Catalog Number	Tip	Blade	Length (in.)
BC945R	B/B	CVD	9
BC947R	B/B	CVD	10 1/4
BC949R	B/B	CVD	11 1/4
BC951R	B/B	CVD	11 3/4
BC953R	B/B	CVD	14

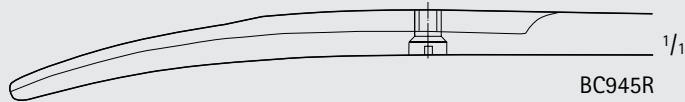

BC945R

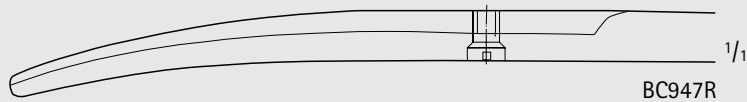

BC947R

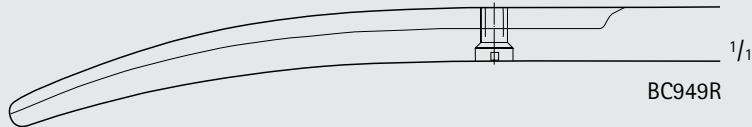

BC949R

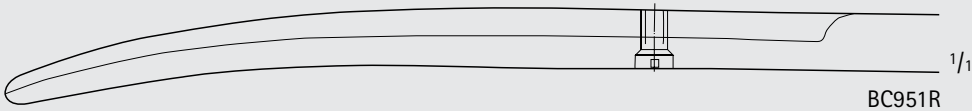

BC951R

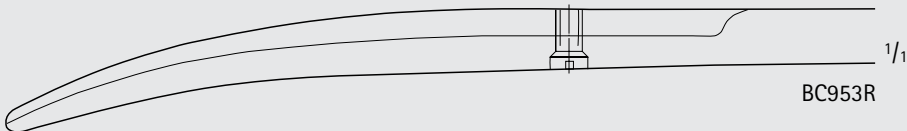

BC953R

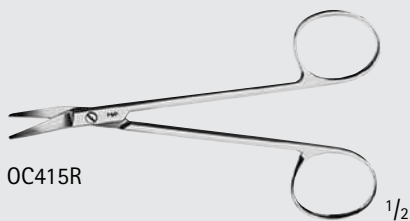

OC415R

GRAEFE Scissors

Catalog Number	Tip	Blade	Length (in.)
OC415R	B/B	LAT-ANG	4

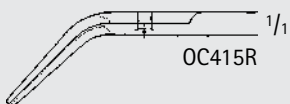

OC415R

FOMON Lower Lateral Scissors

Catalog Number	Tip	Blade	Length (in.)
OK373R	B/B	HEAVY-CVD	4 1/2
OK372R	B/B	HEAVY-CVD	5 1/4

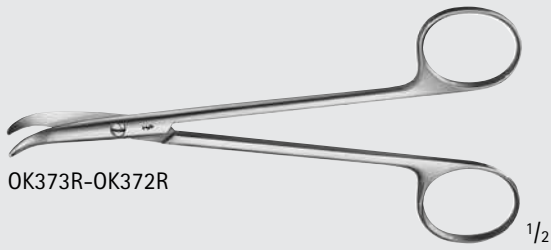

OK373R-OK372R

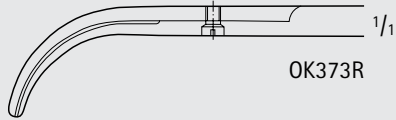

OK373R

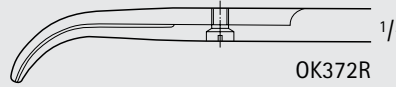

OK372R

SPENCER Suture Scissors

Catalog Number	Blade	Length (in.)
BC801R	STR	3 1/2
BC802R	STR	4 1/2



BC801R-BC802R

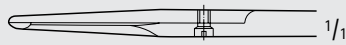

BC801R



BC802R

LITTAUER Ligature Scissors

Catalog Number	Blade	Length (in.)
BC803R	STR	5 1/4



BC803R

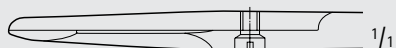

BC803R



Plastic Surgery

Scissors

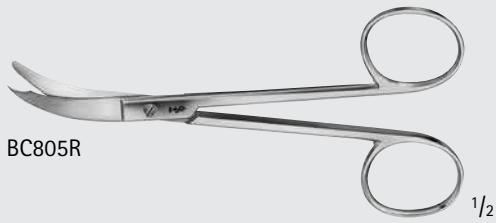

BC805R

1/2

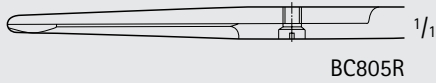

BC805R

1/1

NORTHBENT Ligature Scissors

Catalog Number	Tip	Blade	Length (in.)
BC805R	B/B	LAT-CVD	4 3/4

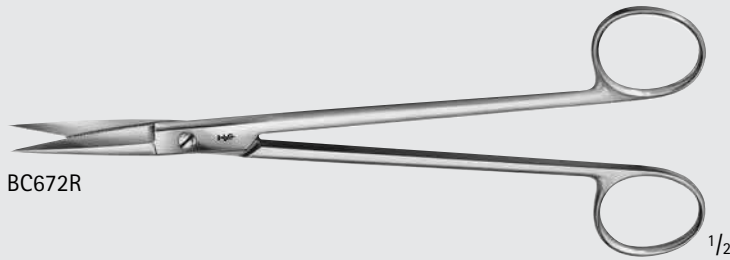

BC672R

1/2



BC672R

1/1

Cartilage Scissors

Catalog Number	Tip	Blade	Length (in.)
BC672R	S/S	SERR	7 1/4



MA458R-MB109R

1/2

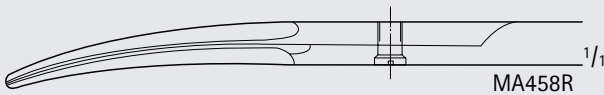

MA458R

1/1

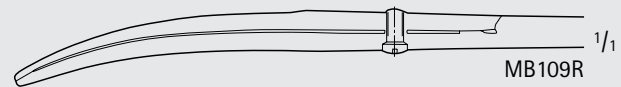

MB109R

1/1

KAYE Facelift Scissors

Catalog Number	Tip	Blade	Length (in.)
MA458R	SEMI-SHARP	CVD, SERR	6
MB109R	SEMI-SHARP	CVD, SERR	7 1/2



MB150R

1/2

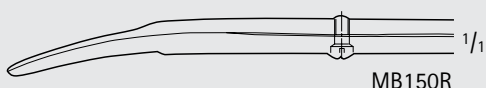

MB150R

1/1

METZENBAUM-LIPSETT Scissors

Catalog Number	Tip	Blade	Length (in.)
MB150R	B/B	CVD	5 1/2

PLASTIC SURGERY

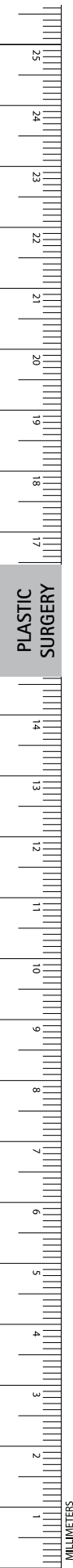

GORNEY Scissors

Catalog Number	Tip	Blade	Length (in.)
BC184R	B/B	STR	5
BC188R	B/B	STR	7 3/4
BC189R	B/B	SLIGHT-CVD	7 3/4



BC184R-BC189R $\frac{1}{2}$

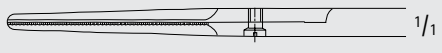

BC184R $\frac{1}{1}$

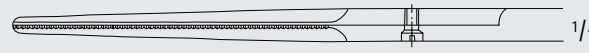

BC188R $\frac{1}{1}$

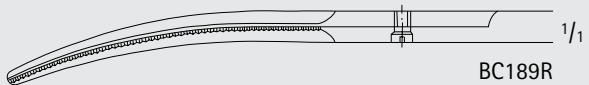

BC189R $\frac{1}{1}$

GORNEY-FREEMAN SuperCut Scissors

Catalog Number	Tip	Blade	Length (in.)
MB632R	BEVELED BLUNT	STR	7 1/4
MB633R	BEVELED BLUNT	CVD	7 1/4

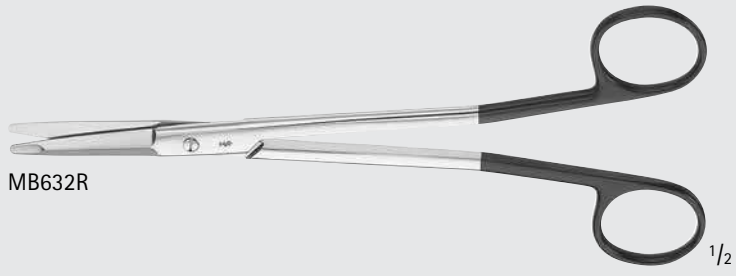

MB632R $\frac{1}{2}$

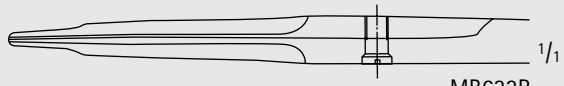

MB632R $\frac{1}{1}$



MB633R $\frac{1}{2}$

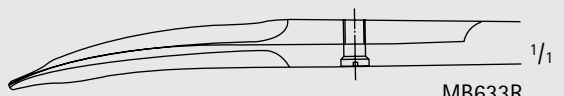

MB633R $\frac{1}{1}$

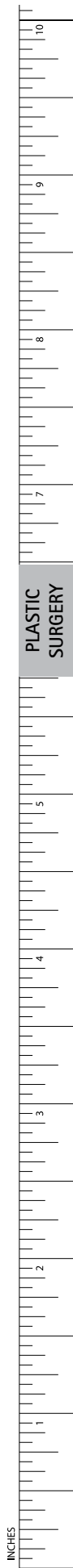

Plastic Surgery

DUROTIP™ TC Scissors

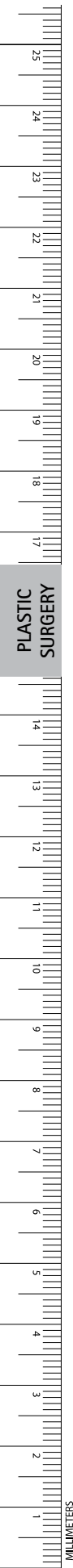
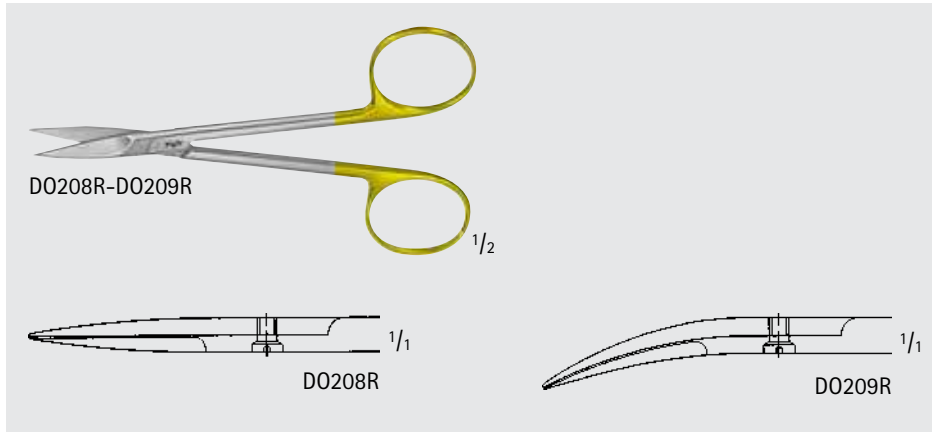
DO208R-DO209R

1/2

1/1

DO208R

1/1

DO209R

DUROTIP TC Delicate Scissors

Catalog Number	Tip	Blade	Length (in.)
DO208R	S/S	STR	4 3/4
DO209R	S/S	CVD	4 3/4

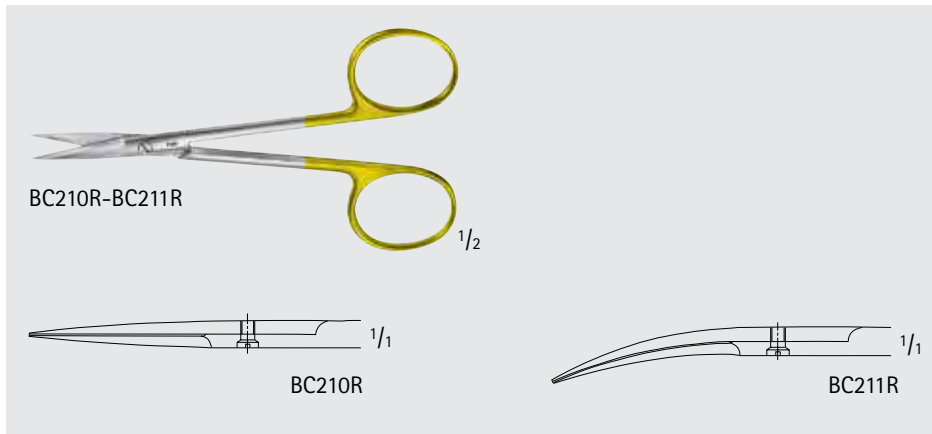

BC210R-BC211R

1/2

1/1

BC210R

1/1

BC211R

DUROTIP TC Iris Scissors, Delicate

Catalog Number	Tip	Blade	Length (in.)
BC210R	S/S	STR	4 1/4
BC211R	S/S	CVD	4 1/4

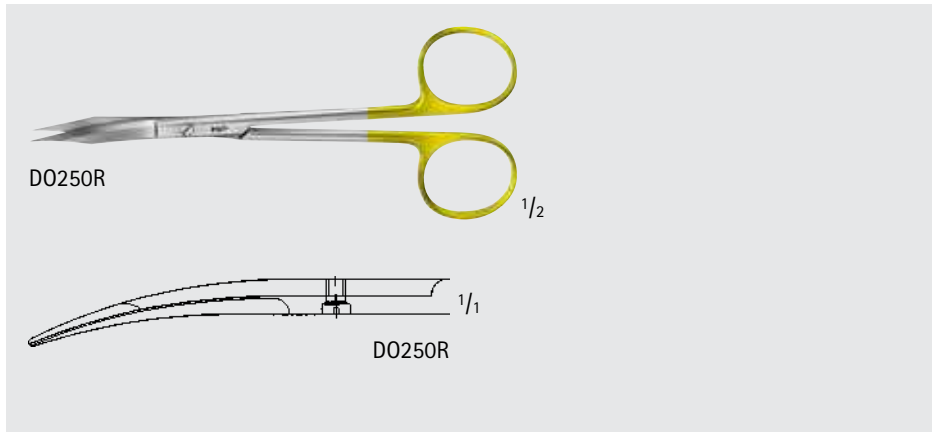

DO250R

1/2

1/1

DO250R

DUROTIP TC GOLDMAN-FOX Tenotomy Scissors, Delicate

Catalog Number	Tip	Blade	Length (in.)
DO250R	S/S	CVD, 1/SERR	5 1/8

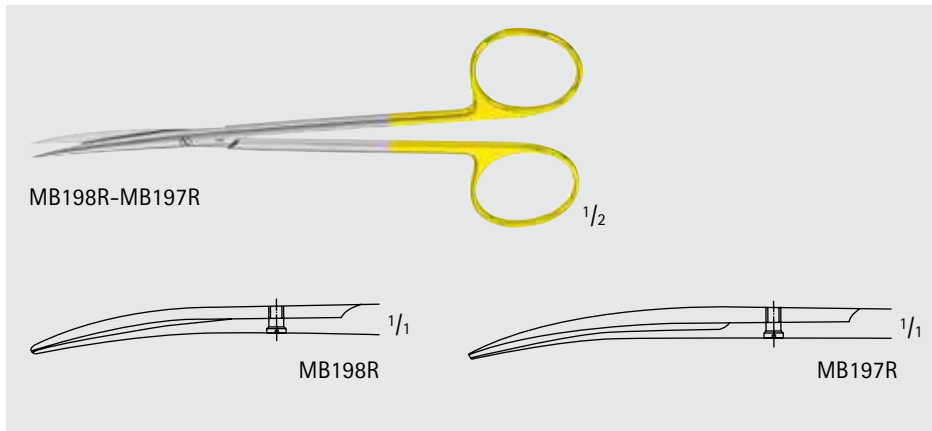

MB198R-MB197R

1/2

1/1

MB198R

1/1

MB197R

DUROTIP TC Par Scissors

Catalog Number	Tip	Length (in.)
MB198R	CVD, BLUNT	4 1/2
MB197R	CVD, BLUNT	5 3/4

**DUROTIP TC GORNEY-FREEMAN
Facelift Scissors**

Catalog Number	Blade	Length (in.)
MB648R	STR, SERR	7 3/4
MB649R	CVD, SERR	7 3/4

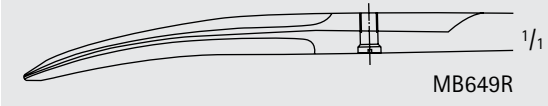
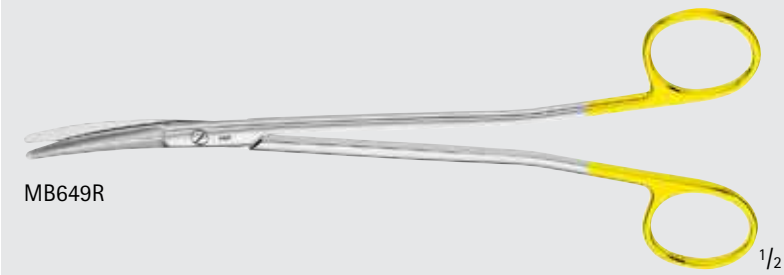
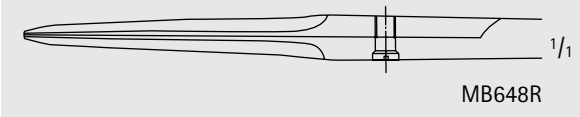
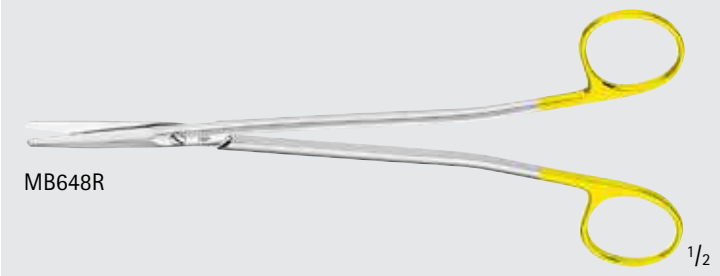

Wavecut
Wavecut scissors have one serrated cutting edge to help prevent tissue from slipping. The W after the item number indicates the scissors are the wavecut style, e.g. BC211W.

DUROTIP TC Iris Scissors, Wavecut

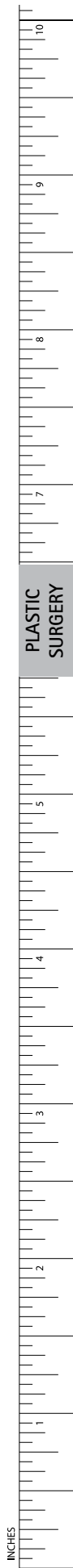
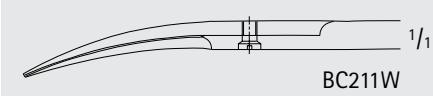

Catalog Number	Tip	Blade	Length (in.)
BC211W	S/S	CVD	4 1/4



PLASTIC SURGERY

INCHES

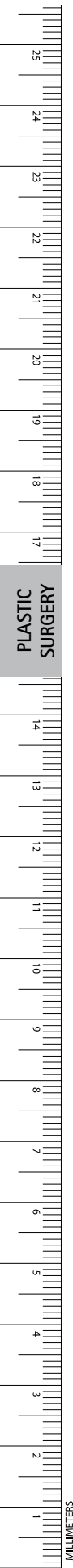
Plastic Surgery
DUROTIP™ TC Scissors

BC259W $\frac{1}{2}$

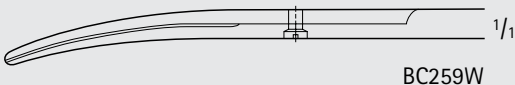

BC259W $\frac{1}{1}$

**DUROTIP TC Baby METZENBAUM
Wavecut Dissecting Scissors, Delicate**

Catalog Number	Tip	Blade	Length (in.)
BC259W	B/B	CVD	5 3/4

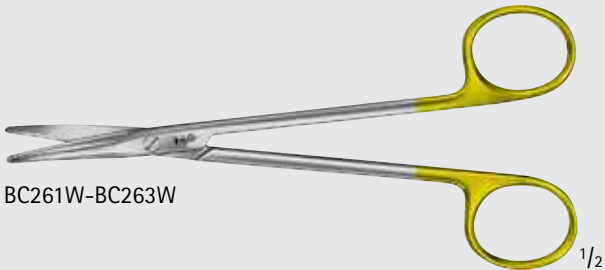

BC261W-BC263W $\frac{1}{2}$

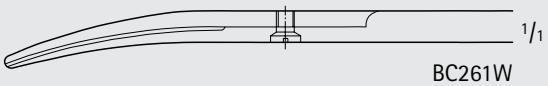

BC261W $\frac{1}{1}$

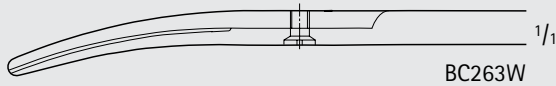

BC263W $\frac{1}{1}$

**DUROTIP TC METZENBAUM
Wavecut Dissecting Scissors**

Catalog Number	Tip	Blade	Length (in.)
BC261W	B/B	CVD	5 3/4
BC263W	B/B	CVD	7

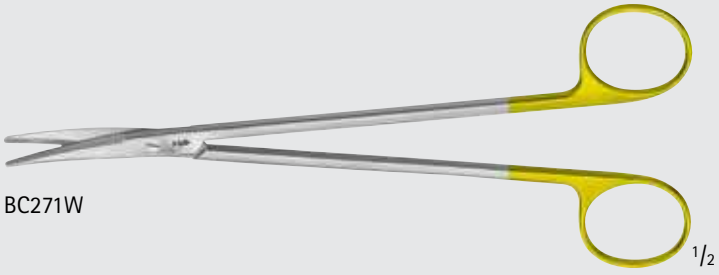

BC271W $\frac{1}{2}$

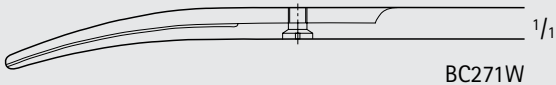

BC271W $\frac{1}{1}$

**DUROTIP TC METZENBAUM
Wavecut Delicate Scissors**

Catalog Number	Tip	Blade	Length (in.)
BC271W	B/B	CVD	7

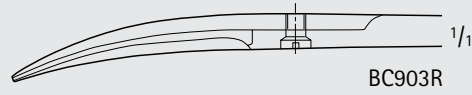

SuperCut Scissors, Delicate

Catalog Number	Tip	Blade	Length (in.)
BC903R	S/S	CVD	5

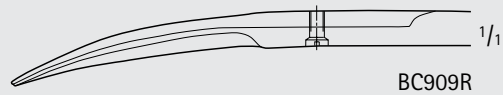

GOLDMANN-FOX SuperCut Scissors, Delicate

Catalog Number	Tip	Blade	Length (in.)
BC909R	S/S	CVD	5 1/8

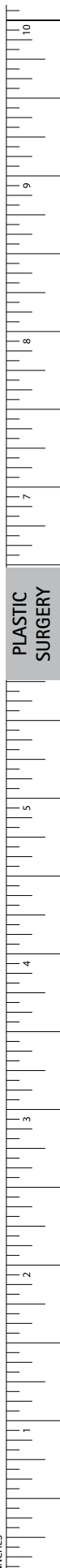

Plastic Surgery

SuperCut Scissors

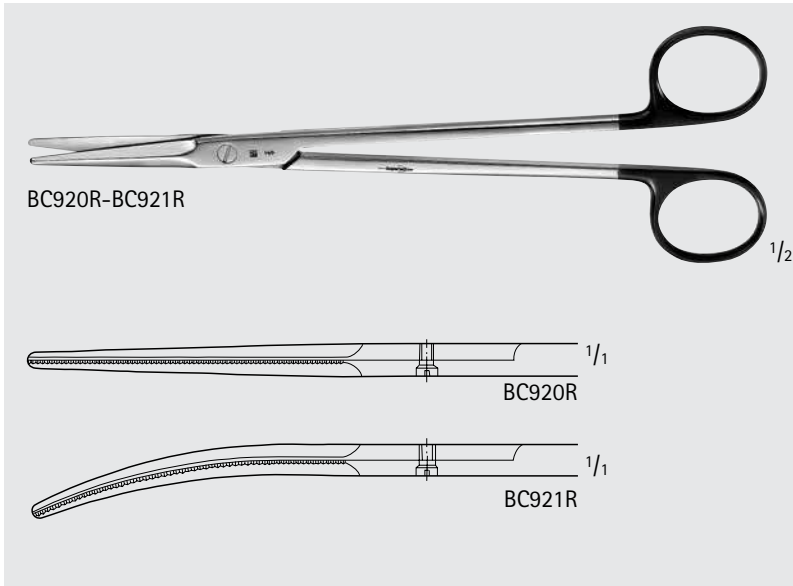
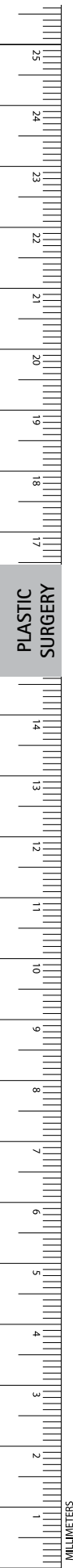

GORNEY SuperCut Scissors, Delicate

Catalog Number	Tip	Blade	Length (in.)
BC920R	B/B	STR	7 3/4
BC921R	B/B	CVD	7 3/4

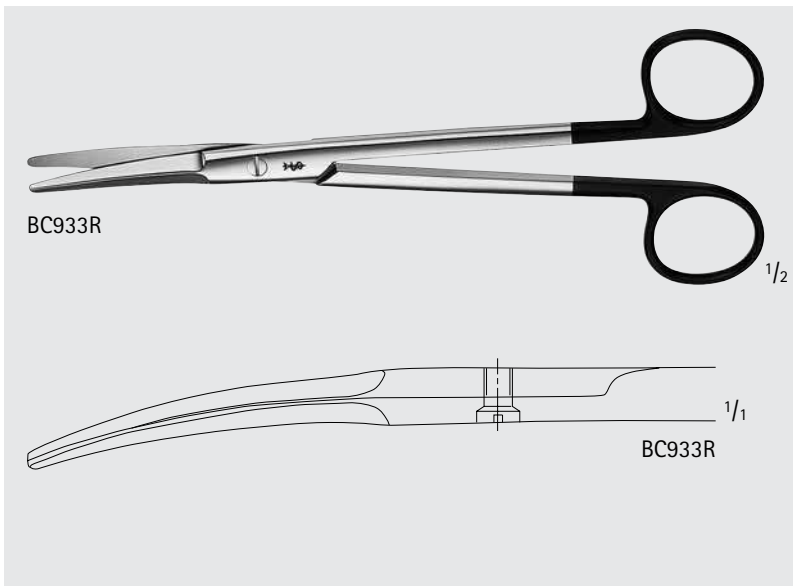

KAYE SuperCut Scissors, Delicate

Catalog Number	Blade	Length (in.)
BC933R	CVD	7 3/4

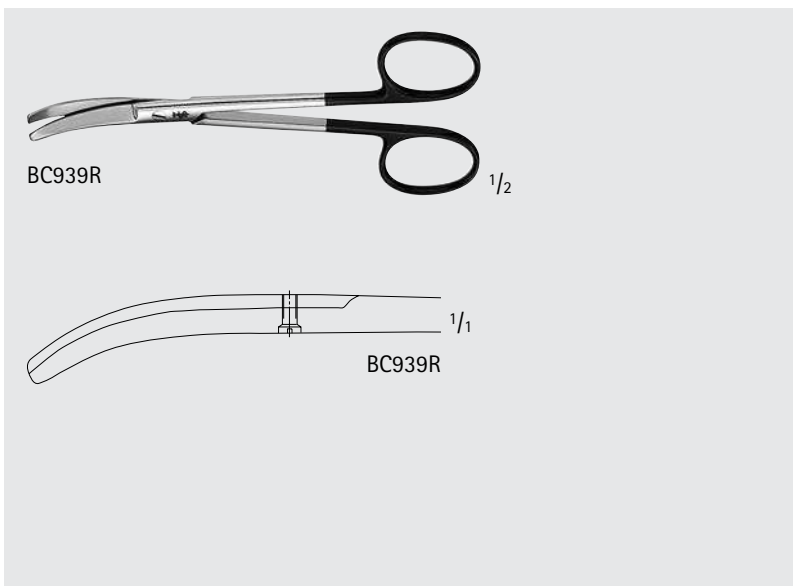

FOMON SuperCut Scissors

Catalog Number	Tip	Blade	Length (in.)
BC939R	B/B	CVD	4 1/2

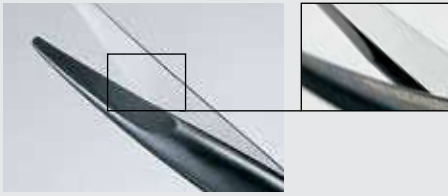

Microtome Edge

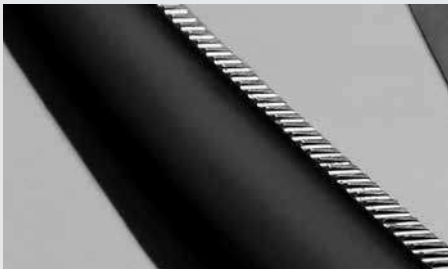

Wavecut

Noir Supreme Cut Scissors

- **Noir**
The combination of the renowned Aesculap Tungsten Carbide technology with the Aesculap Noir coating results in an extremely high surface hardness and therefore high wear resistance in daily hospital use.
- **Microtome edge**
The extremely sharp cutting edge of the scissors blade facilitates gentle cutting of tissue with minimal use of force.
- **Wavecut** helps prevent tissue from slipping out during the cutting process.
- The WB after the item number indicates the Noir scissors are the wavecut style, e.g. BC211WB.

For more information see our brochure number DOC637.



Noir Iris Dissecting Scissors

Catalog Number	Tip	Blade	Length (in.)
BC210B	S/S	STR	4 1/4
BC211B	S/S	CVD	4 1/4
BC211WB	S/S	CVD	4 1/4



Noir Strabismus Dissecting Scissors

Catalog Number	Tip	Blade	Length (in.)
BC257B	B/B	CVD	4 1/2
BC257WB	B/B	CVD	4 1/2



Noir Baby METZENBAUM Dissecting Scissors

Catalog Number	Tip	Blade	Length (in.)
BC259B	B/B	CVD	5 3/4
BC259WB	B/B	CVD	5 3/4

Plastic Surgery

Noir™ Supreme Cut Scissors

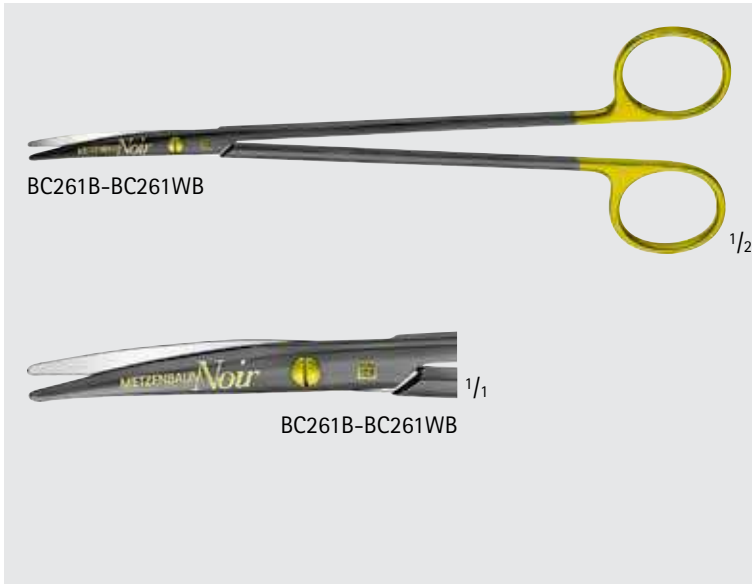
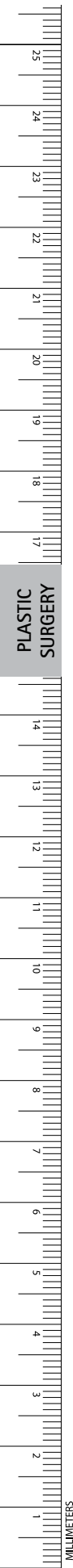

Noir METZENBAUM Dissecting Scissors

Catalog Number	Tip	Blade	Length (in.)
BC261B	B/B	CVD	5 3/4
BC261WB	B/B	CVD	5 3/4

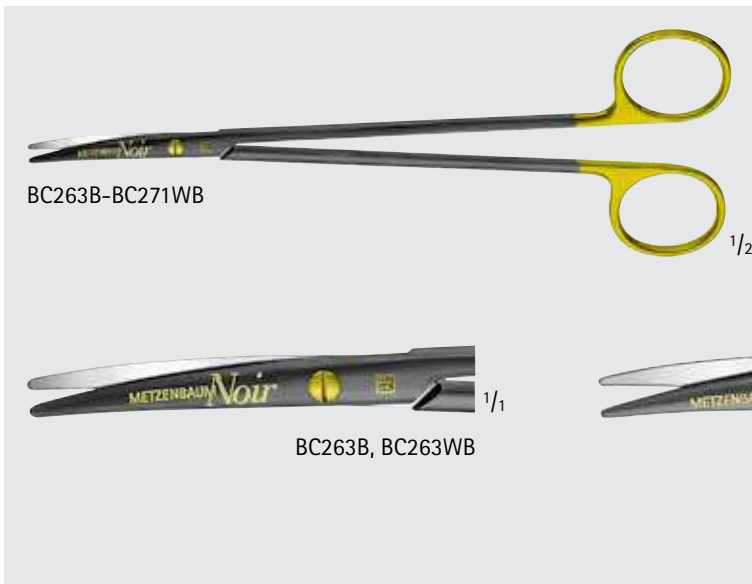

Noir METZENBAUM Dissecting Scissors

Catalog Number	Tip	Blade	Length (in.)
BC263B	B/B	CVD	7
BC263WB	B/B	CVD	7
BC271B	B/B	CVD, DEL	7
BC271WB	B/B	CVD, DEL	7



Noir TOENNIS-ADSON Dissecting Scissors

Catalog Number	Tip	Blade	Length (in.)
BC273B	B/B	CVD, DEL	6 7/8
BC273WB	B/B	CVD, DEL	6 7/8



FM010R-FM040R

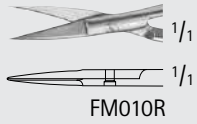

FM010R

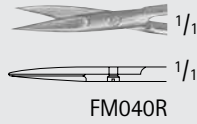

FM040R



FM011R-FM041R

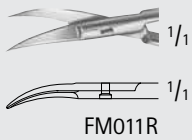

FM011R

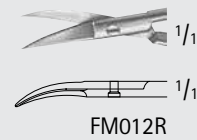

FM012R

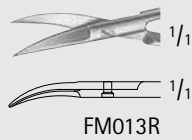

FM013R

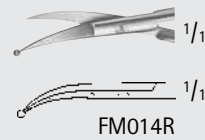

FM014R

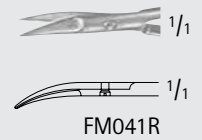

FM041R

MUELLER Micro Scissors

Catalog Number	Tip	Handle Color	Blade	Length (in.)
FM010R	S/S	BLUE	STR	4 3/4
FM040R	S/S	BLUE	STR	6 3/4
FM011R	S/S	BLUE	CVD	4 3/4
FM012R	S/B	BLUE	CVD	4 3/4
FM013R	B/B	BLUE	CVD	4 3/4
FM014R	S/BALL-PT	BLUE	CVD	4 3/4
FM041R	S/S	BLUE	CVD	6 3/4



FD251R-FD252R



FD252R

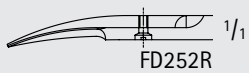

FD251R

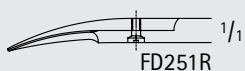

Micro Scissors, Golf Ball Handle

Catalog Number	Blade	Length (in.)
FD252R	SLIGHT CVD, 1/SERR	7
FD251R	CVD	7

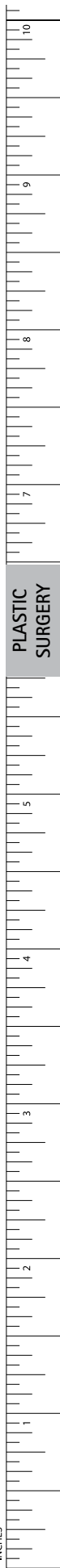

Plastic Surgery

Micro Scissors and Needle Holders

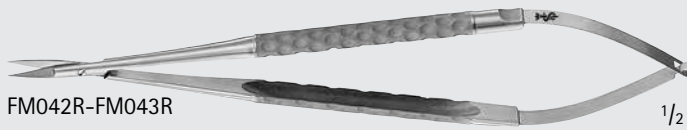

Micro Scissors, Golf Ball Handle

Catalog Number	Blade	Length (in.)
FM042R	STR	7
FM043R	CVD	7

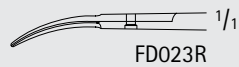
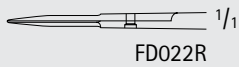

YASARGIL Micro Vessel Scissors

Catalog Number	Blade	Handle	Length (in.)
FD022R	STR	FLAT, SERR	7 1/4
FD023R	CVD	FLAT, SERR	7 1/4

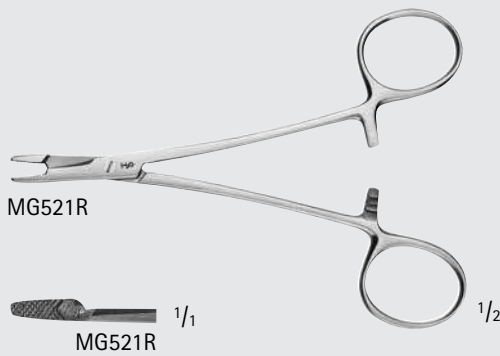

HEGAR-OLSEN Needle Holder

Catalog Number	Tip	Length (in.)
MG521R	SERR	4 3/4

PLASTIC SURGERY

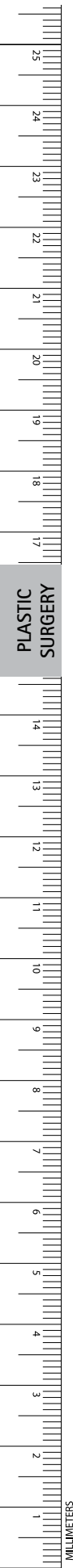

Aesculap features Needle Holders with Tungsten Carbide (TC) inserts. A smooth jaw and three different serration patterns are available, depending on the size of the suture needle.

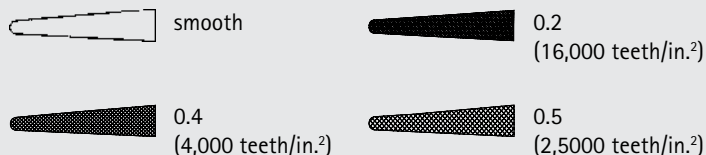
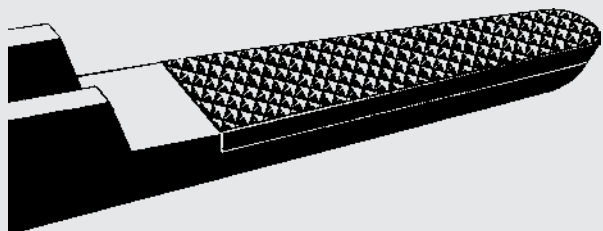

We recommend carbide inserts as follows:

Jaw Surface	Suture Material
Smooth	9/0 - 11/0
0.2 mm pitch of serration	6/0 - 10/0
0.4 mm pitch of serration	4/0 - 6/0
0.5 mm pitch of serration	up to 3/0

DUROGRIP TC CASTROVIEJO Micro Needle Holder, Flat Handle

Catalog Number	Jaw	Length (in.)
BM001R	SMOOTH	5 3/4
BM002R	SERR	5 3/4
BM004R	SERR	7
BM005R	SERR	8 1/2



BM001R



BM002R



BM004R



BM005R

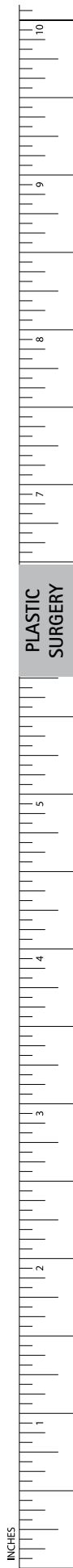

INCHES

Plastic Surgery

DUROGRIP™ TC Needle Holders

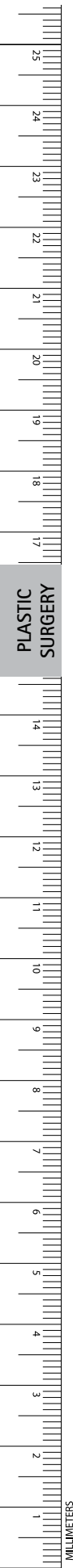
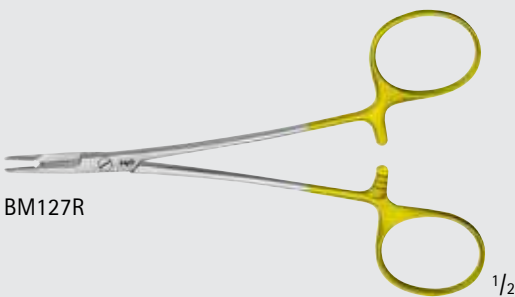

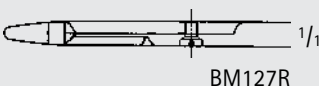

BM127R $\frac{1}{2}$

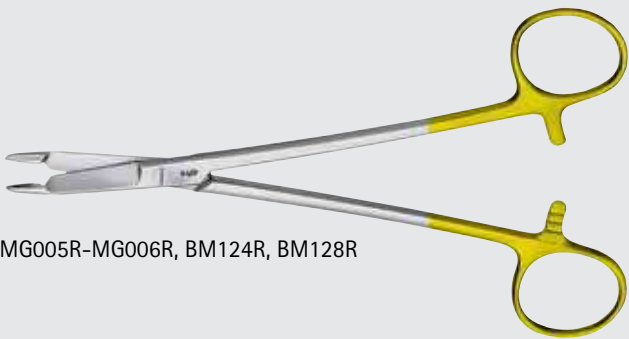

BM127R $\frac{1}{1}$

DUROGRIP TC LEWIN Needle Holder/Scissors		
Catalog Number	Jaw	Length (in.)
BM127R	SMOOTH	5



MG005R-MG006R, BM124R, BM128R



MG005R $\frac{1}{1}$



MG006R $\frac{1}{1}$

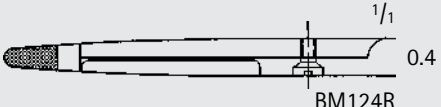

BM124R $\frac{1}{1}$ 0.4

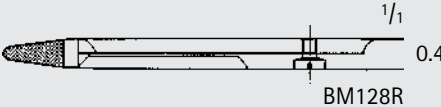

BM128R $\frac{1}{1}$ 0.4

DUROGRIP TC HEGAR-OLSON Needle Holder/Scissors		
Catalog Number	Jaw	Length (in.)
MG005R	SMOOTH	4 3/4
MG006R	SERR	4 3/4
BM128R	SERR	5 3/4
BM124R	SERR	6 1/2

**DUROGRIP TC GILLIES Needle Holder/
Scissors**

Catalog Number	Jaw	Handle	Length (in.)
BM129R	SERR	OFF-SET	6 1/4

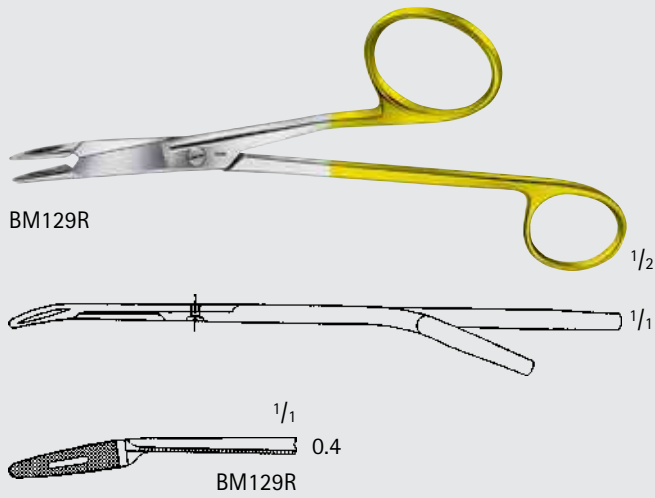

**DUROGRIP TC CRILE-WOOD
Needle Holder**

Catalog Number	Jaw	Length (in.)
BM016R	SERR	5 3/4
BM017R	SERR	7 1/4
BM019R	SERR	7 7/8
BM030R	SERR	10 5/8
BM021R	SERR	12

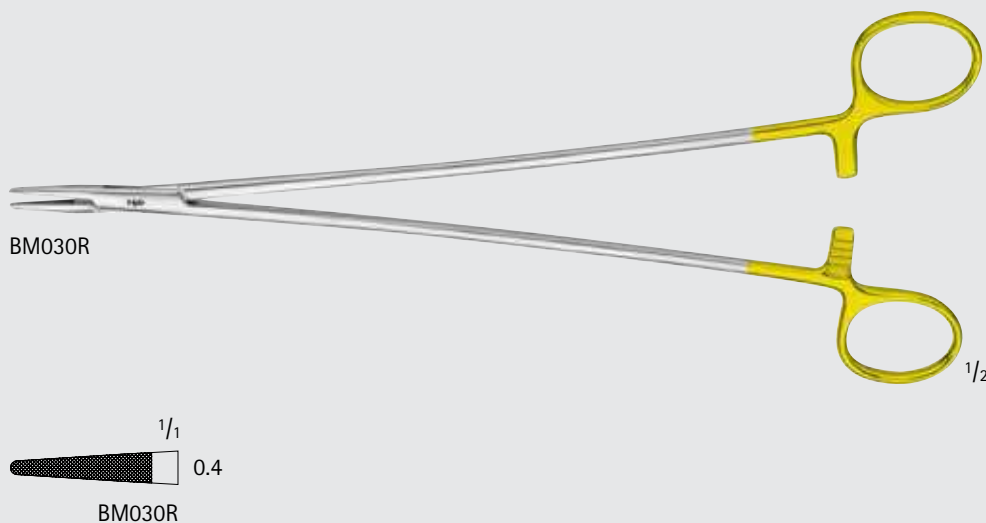
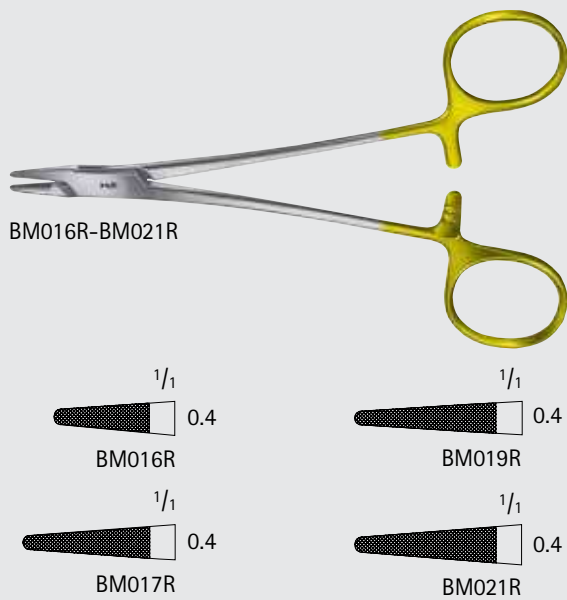

PLASTIC SURGERY

INCHES

Plastic Surgery

DUROGRIP™ TC Needle Holders

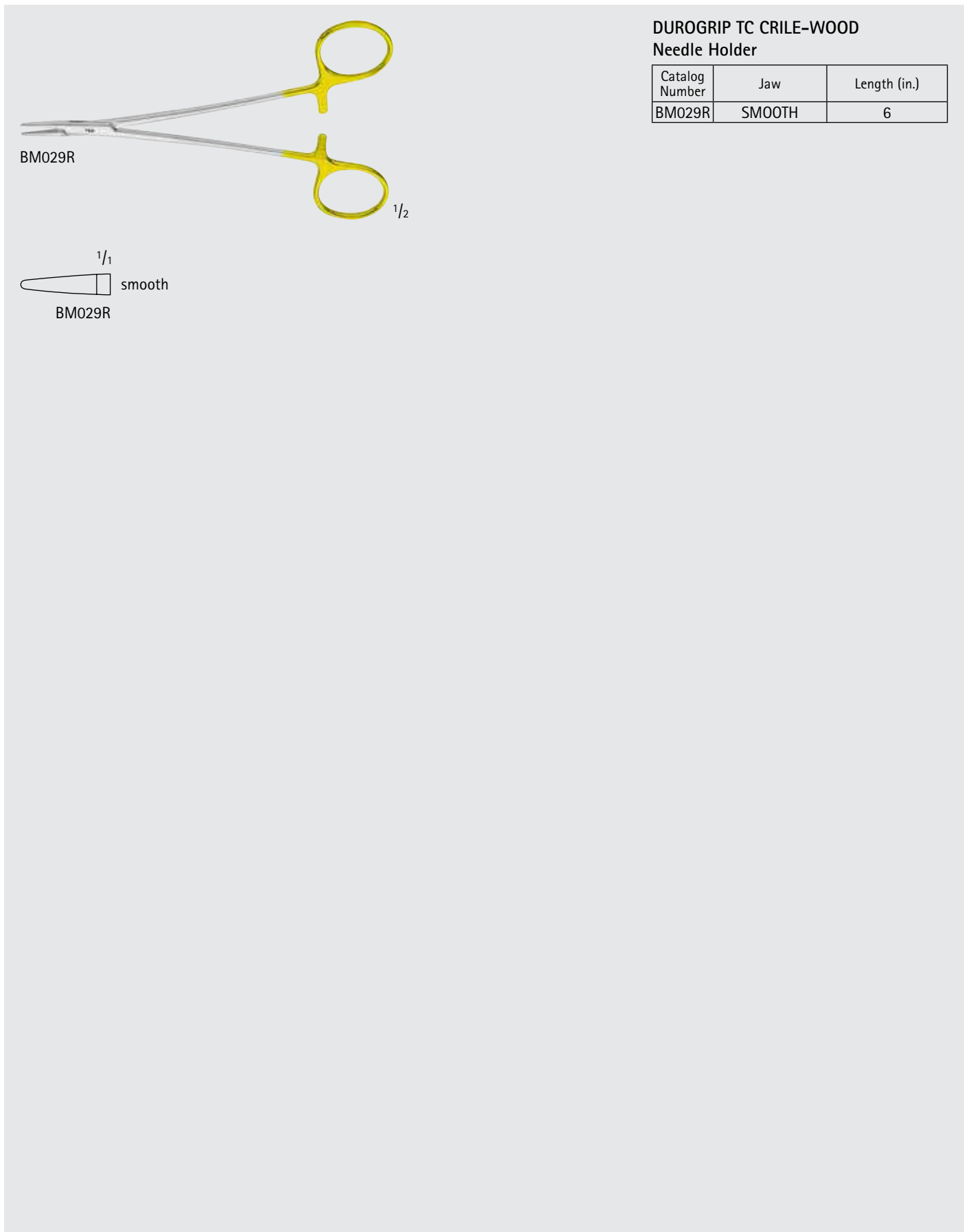
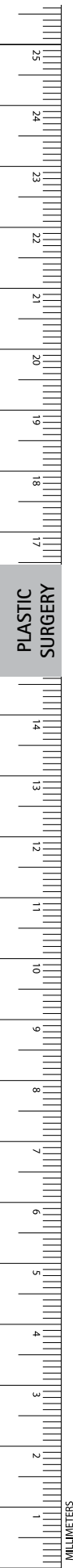

**DUROGRIP TC CRILE-WOOD
Needle Holder**

Catalog Number	Jaw	Length (in.)
BM029R	SMOOTH	6

BM029R

1/2

1/1

smooth

BM029R

PLASTIC SURGERY



MB295R



MB295R

CASTROVIEJO Suture Forceps

Catalog Number	Tip Size (mm)	Teeth	Length (in.)
MB295R	0.12	1 x 2	4 1/8



MB294R



MB294R

CASTROVIEJO COLIBRI Type Corneal Forceps

Catalog Number	Tip Size (mm)	Teeth	Length (in.)
MB294R	0.12	1 x 2	4 1/8



BD505R

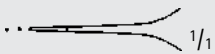

BD505R

BONN Eye Forceps, W/ Platform

Catalog Number	Tip Size (mm)	Teeth	Length (in.)
BD505R	0.2	1 x 2	3 3/4



BD329R



BD329R

Jewelers Forceps

Catalog Number	Tip Size (mm)	Tip	Length (in.)
BD329R	0.3	ANG	4 1/4



BD330R



BD330R

Micro Forceps #4 Jewelers

Catalog Number	Tip Size (mm)	Length (in.)
BD330R	0.2	4 1/4

Plastic Surgery

Dressing and Tissue Forceps

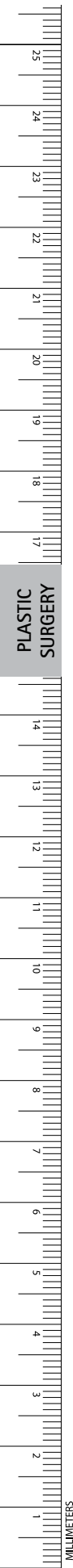



BD345R 1/2

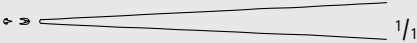

BD345R 1/1

Micro Jewelers Forceps

Catalog Number	Tip Size (mm)	Teeth	Length (in.)
BD345R	0.4	1 x 2	5 1/4



BD336R 1/2



BD336R 1/1



BD337R 1/2



BD337R 1/1

WISE Micro Suture Forceps

Catalog Number	Tip Size (mm)	Tip	Length (in.)
BD336R	0.3	STR	5 1/4
BD337R	0.3	CVD	5 1/4



BD338R 1/2

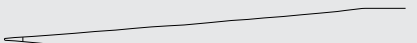

BD338R 1/1

Micro Suture Forceps, W/ Platform

Catalog Number	Tip Size (mm)	Length (in.)
BD338R	0.3	4 3/4



BD340R 1/2

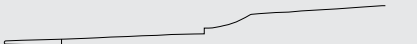

BD340R 1/1

AUSTIN Micro Suture Forceps, W/ Platform

Catalog Number	Tip Size (mm)	Length (in.)
BD340R	0.8	5 1/2



FD284R-FD287R

Micro Suture Forceps, Round Handle

Catalog Number	Tip Size (mm)	Tip	Length (in.)
FD284R	0.3	STR	6
FD286R	0.5	STR	7
FD285R	0.3	CVD	6
FD287R	0.5	CVD	7

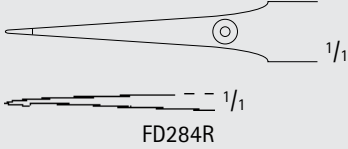

FD284R

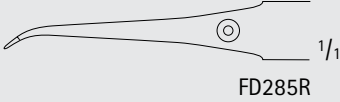

FD285R

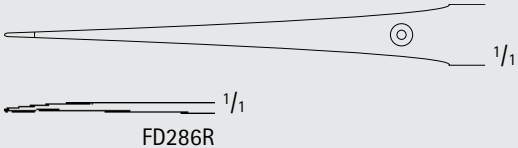

FD286R

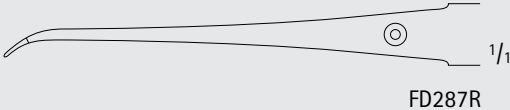

FD287R



BD509R

MICRO-ADSON-BIEMER Forceps

Catalog Number	Teeth	Length (in.)
BD509R	1 x 2	4 3/4

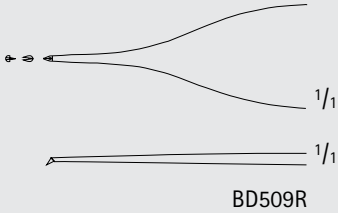

BD509R

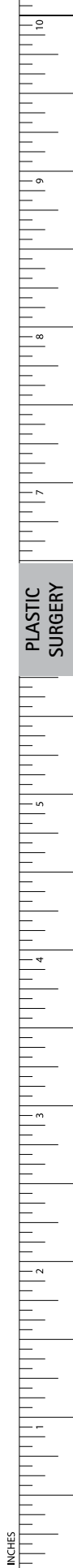

Plastic Surgery

Dressing and Tissue Forceps



FM001R-FM006R

MUELLER Micro Forceps

Catalog Number	Tip Size (mm)	Handle Color	Teeth	Length (in.)
FM001R	0.15	BROWN	-	4 1/4
FM002R	0.20	BROWN	-	4 1/4
FM003R	0.30	BROWN	-	4 1/4
FM004R	0.50	BLACK	1 x 2	4 1/4
FM005R	1.20	GREY	RING	4 1/4
FM006R	1.20	GREY	TRI	4 1/4

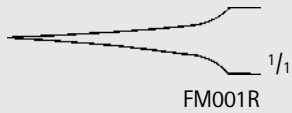

FM001R

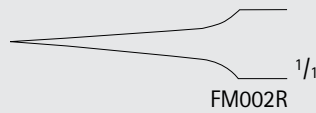

FM002R

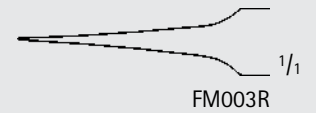

FM003R

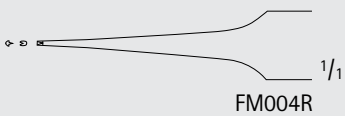

FM004R

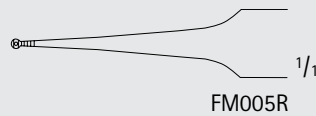

FM005R

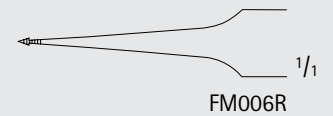

FM006R



BD260R

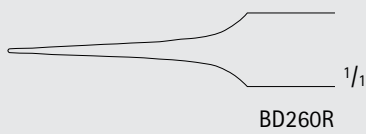

BD260R



BD261R

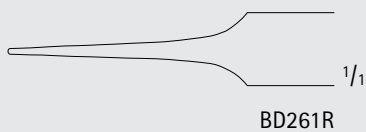

BD261R

LAZAR Micro Suture Forceps

Catalog Number	Tip Size (mm)	Length (in.)
BD260R	0.5	6 1/8
BD261R	0.8	6 1/8

PLASTIC SURGERY

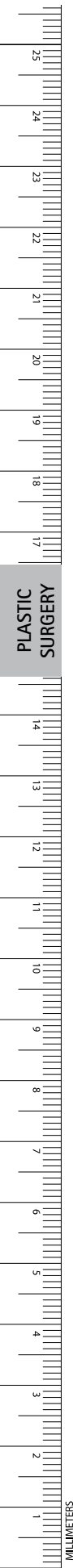

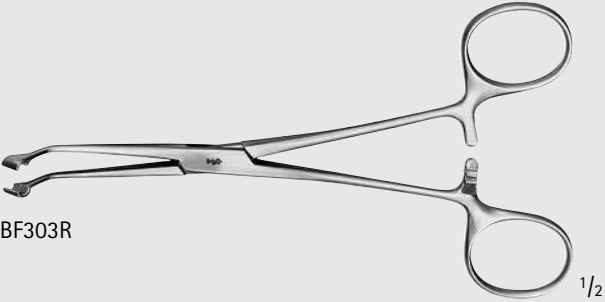

BF303R $\frac{1}{2}$



$\frac{1}{1}$



BF303R $\frac{1}{1}$

HERZ Tendon Seizing Forceps		
Catalog Number	Jaw	Length (in.)
BF303R	CVD	6 1/8

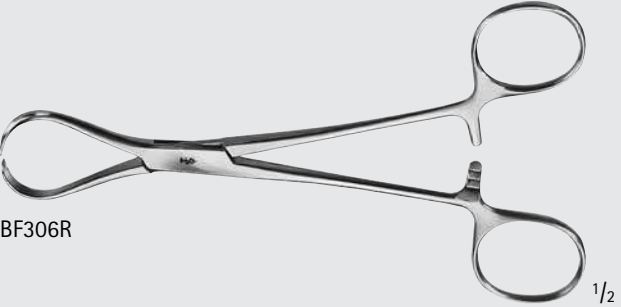

BF306R $\frac{1}{2}$

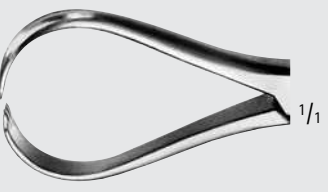

$\frac{1}{1}$



BF306R $\frac{1}{1}$

JACKSON Tendon Seizing Forceps		
Catalog Number	Teeth	Length (in.)
BF306R	4 x 5	6 1/8



FO940R, MB363C $\frac{1}{2}$

BUNNELL Tendon Passing Probe	
Catalog Number	Length (in.)
MB363C	7 3/8
FO940R	9



Plastic Surgery

Bone and Tendon Forceps

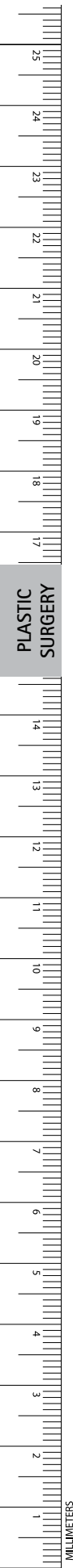
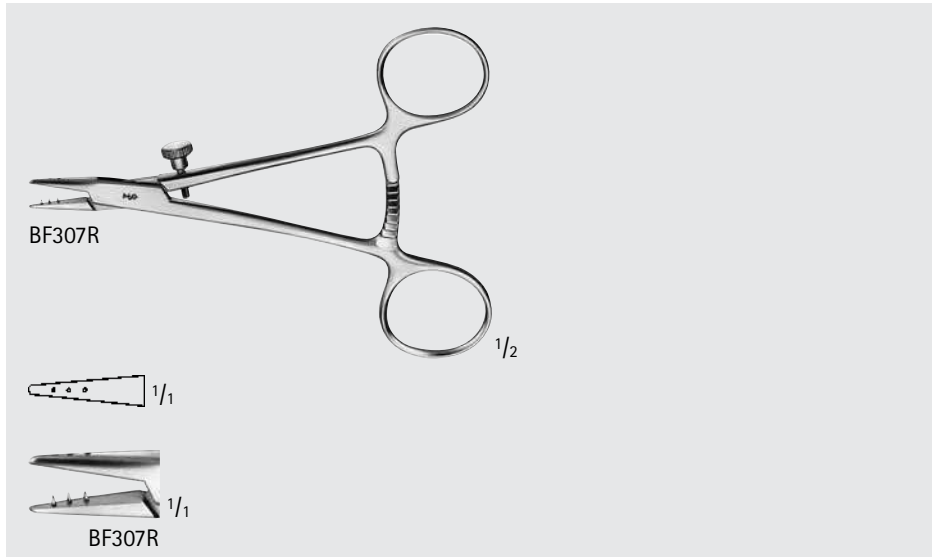
Tendon Seizing Forceps, W/ 3 Pins

Catalog Number	Length (in.)
BF307R	4 3/4

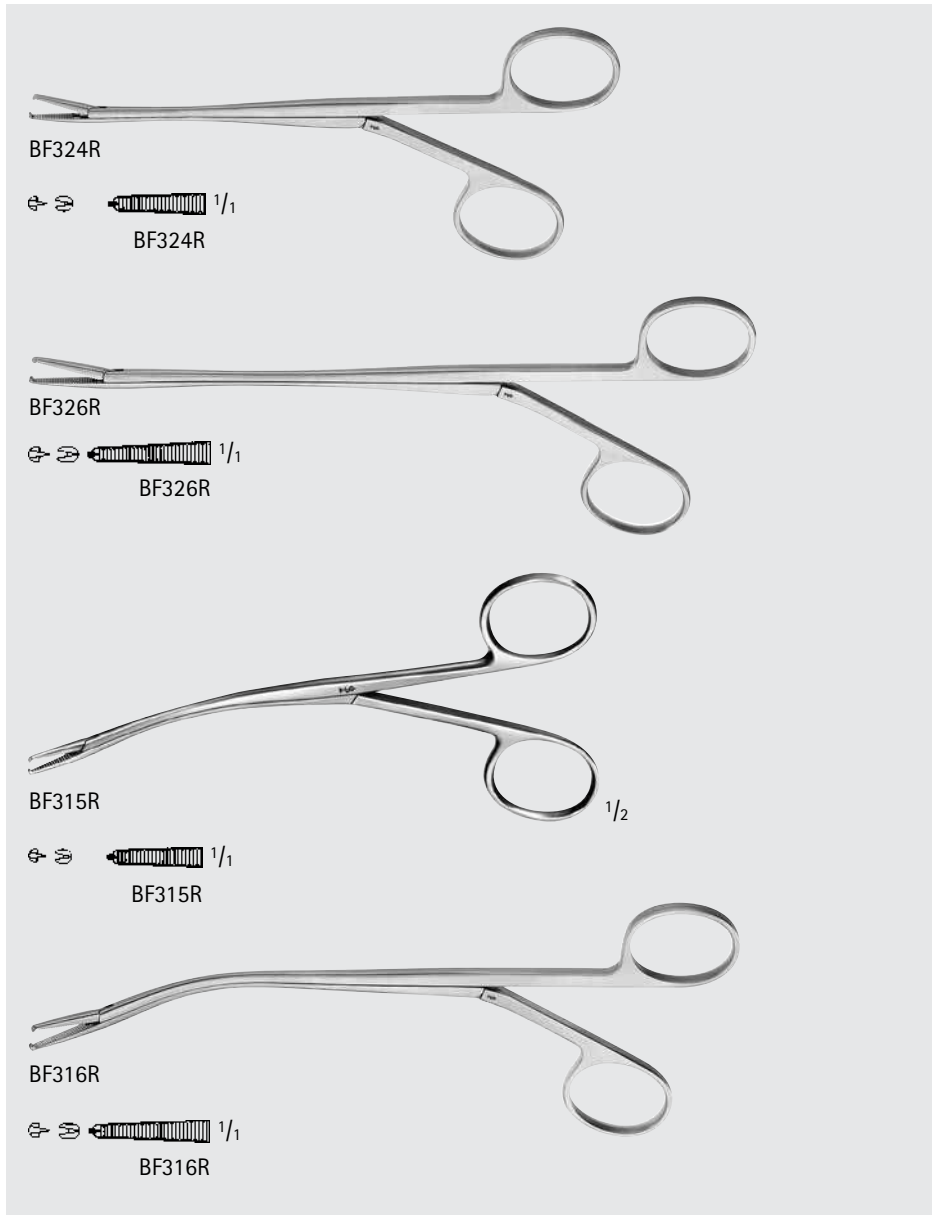

BRAND Tendon Holding Forceps

Catalog Number	Jaw	Teeth	Length (in.)
BF324R	STR	1 x 2	6
BF326R	STR	1 x 2	7 1/4
BF315R	CVD	1 x 2	6
BF316R	CVD	1 x 2	7 1/4

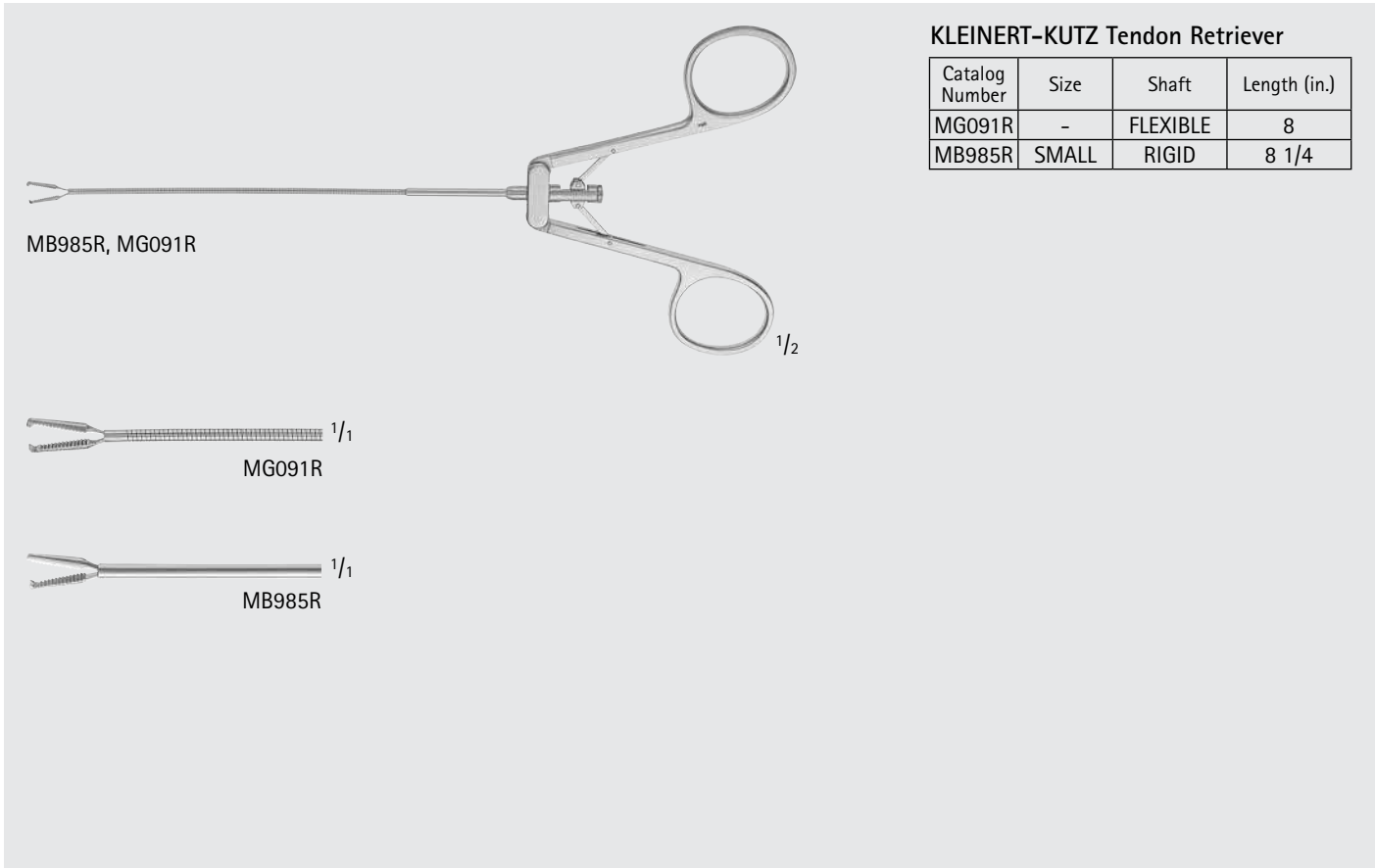

KLEINERT-KUTZ Tendon Retriever

Catalog Number	Size	Shaft	Length (in.)
MG091R	-	FLEXIBLE	8
MB985R	SMALL	RIGID	8 1/4

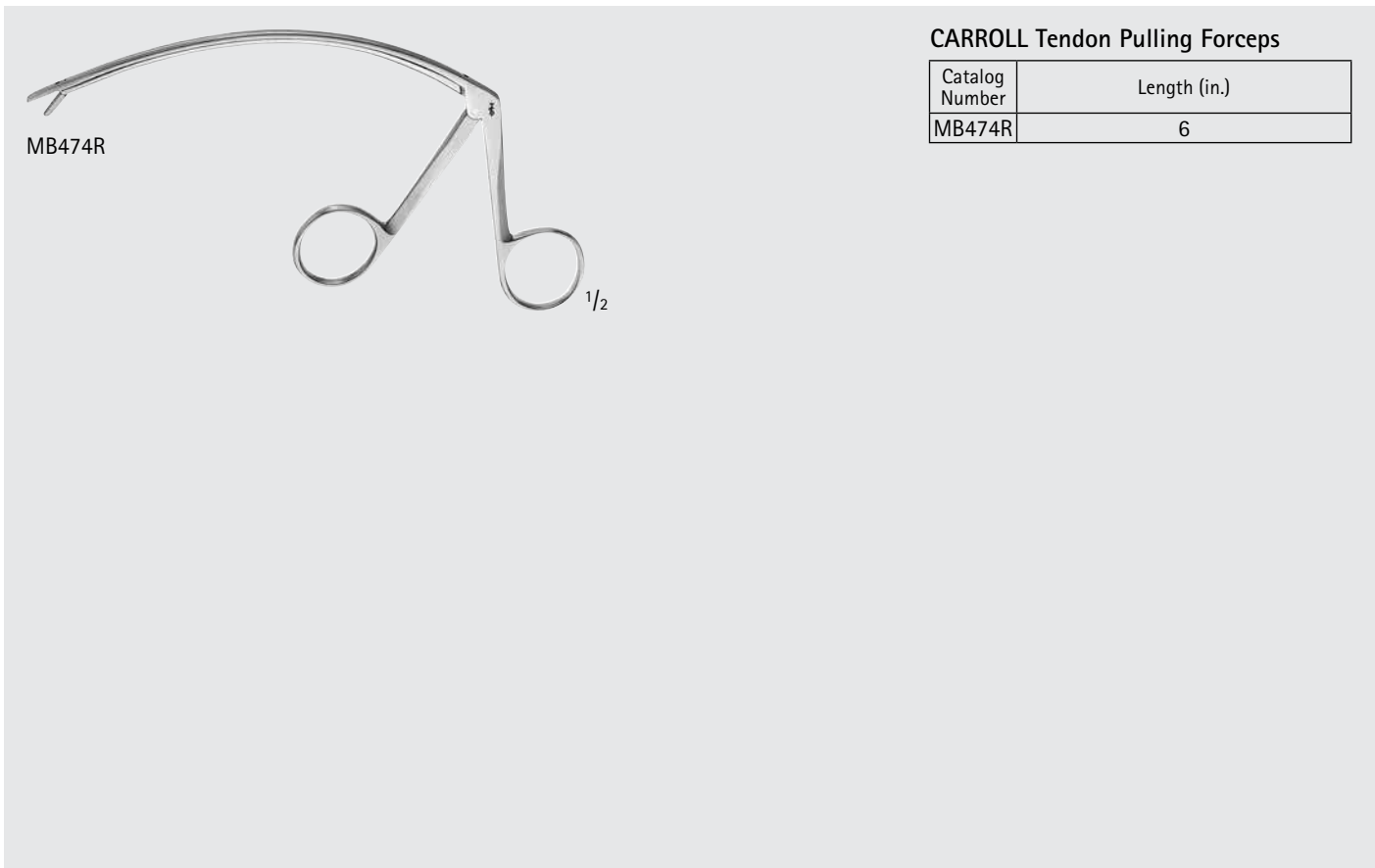

CARROLL Tendon Pulling Forceps

Catalog Number	Length (in.)
MB474R	6



Plastic Surgery

Bone and Tendon Forceps

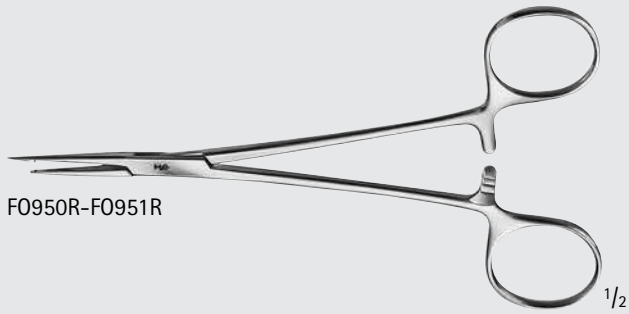
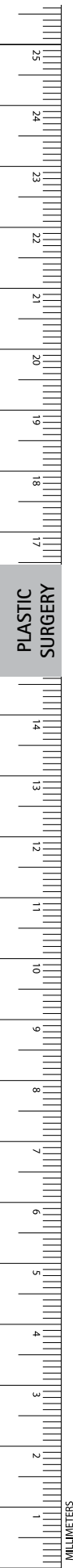

F0950R-F0951R

1/2

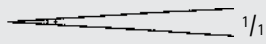

1/1



1/1

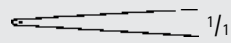

1/1

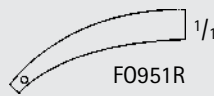

1/1

F0950R

F0951R

Tendon Interlacing Forceps

Catalog Number	Jaw	Length (in.)
F0950R	STR	6
F0951R	CVD	6



F0935R-F0939R

1/2

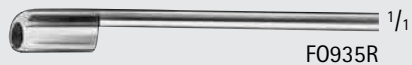

1/1

F0935R



1/1

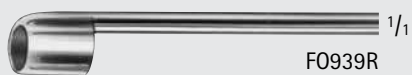

1/1

F0939R



1/1

Tendon Stripper

Catalog Number	Length (in.)
F0935R	11 3/4
F0939R	19 3/4



BD952R



BD952R

Splinter Forceps

Catalog Number	Length (in.)
BD952R	3 1/8



BD963R-BD965R



BD963R



BD964R



BD965R

FEILCHENFELD Splinter Forceps

Catalog Number	Length (in.)
BD963R	3
BD964R	3 3/4
BD965R	4 1/2

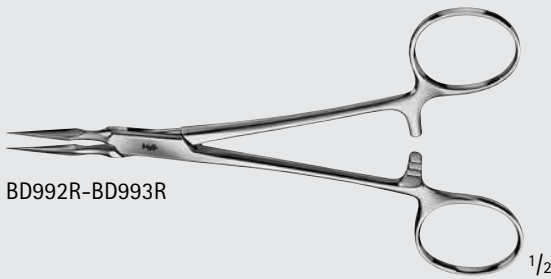

BD992R-BD993R



BD992R

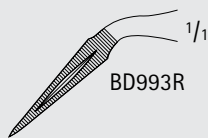

BD993R

STIEGLITZ Splinter Forceps

Catalog Number	Jaw	Length (in.)
BD992R	STR	5 1/2
BD993R	CVD	5 1/2

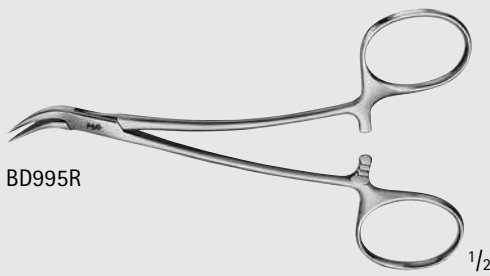

BD995R



BD995R

PEET Splinter Forceps

Catalog Number	Length (in.)
BD995R	4 3/4

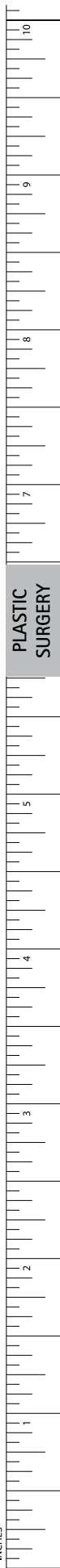

PLASTIC SURGERY

INCHES

Plastic Surgery

Hemostatic Forceps

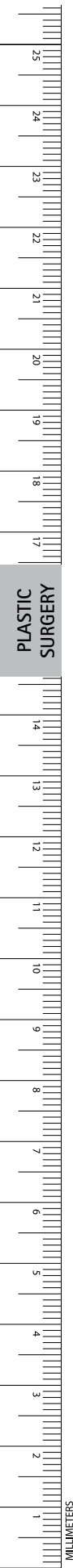

BH100R



BH100R

CARREL Artery Forceps

Catalog Number	Length (in.)
BH100R	3 1/4



BH139R-BH143R

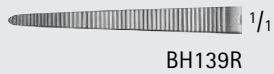

BH139R

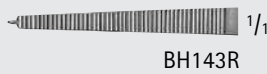

BH143R

DANDY Forceps

Catalog Number	Jaw	Jaw Shape	Length (in.)
BH139R	SERR	CVD	5 1/2
BH143R	1 x 2 Teeth	LAT-CVD	5 1/2



GRAEFE Hook

Catalog Number	Tip	Length (in.)
OA332R	SHARP	5
OA333R	BLUNT	5

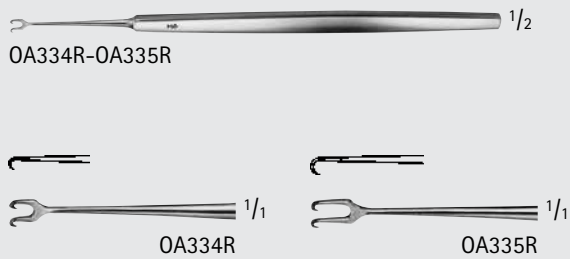

GUTHRIE Double Hook

Catalog Number	Tip	Length (in.)
OA334R	SHARP	5
OA335R	SHARP	5 1/8

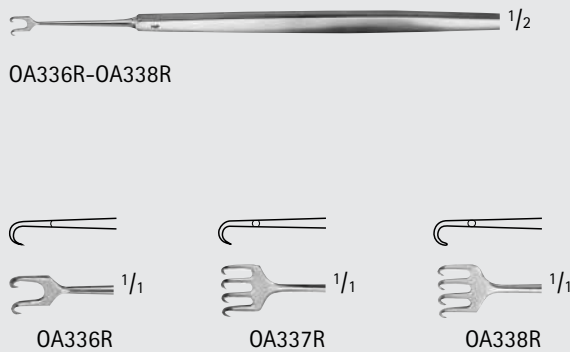

ROLLET Hook Retractor

Catalog Number	Tip	Blade End	Length (in.)
OA336R	SHARP	2 PRONG	5 1/8
OA337R	SHARP	4 PRONG	5 1/4
OA338R	BLUNT	4 PRONG	5 1/4

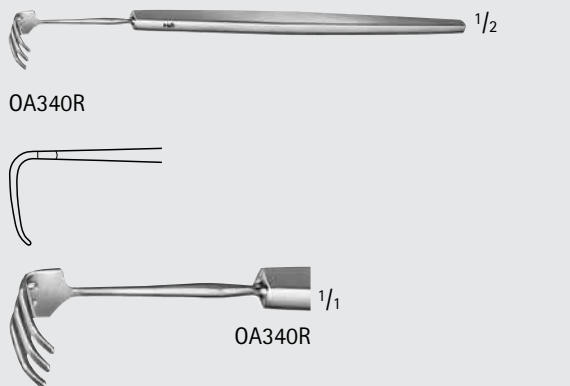

PAUL Tendon Hook

Catalog Number	Tip	Blade End	Tip Size (mm)	Length (in.)
OA340R	BLUNT	3 PRONGS	11 x 8	4 3/4



JAEGER Hook Retractor, Fine

Catalog Number	Tip	Length (in.)
OA351R	SHARP	5 1/4



PLASTIC SURGERY

INCHES

Plastic Surgery

Hooks and Retractors



OL601R-OL603R



OL601R



OL602R



OL603R

KLEINERT-KUTZ Skin Hook

Catalog Number	Size	Tip	Tip Size (mm)	Length (in.)
OL601R	1	SHARP	2.5	6 1/4
OL602R	2	SHARP	4.2	6 1/4
OL603R	3	SHARP	4.8	6 1/4



OL610R



OL610R

KILNER Skin Hook

Catalog Number	Tip	Length (in.)
OL610R	SHARP	6 1/4



OL611R-OL612R



OL611R



OL612R

GILLIES Skin Hook

Catalog Number	Hook End	Tip	Length (in.)
OL611R	SMALL	SHARP	7
OL612R	LARGE	SHARP	7



OL619R



OL619R



OL617R





OL617R

COTTLE Hook

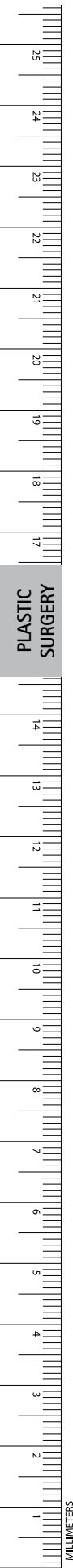
Catalog Number	Tip	Length (in.)
OL619R	CVD, SHARP	6 1/4
OL617R	ANG, SHARP	6 1/4

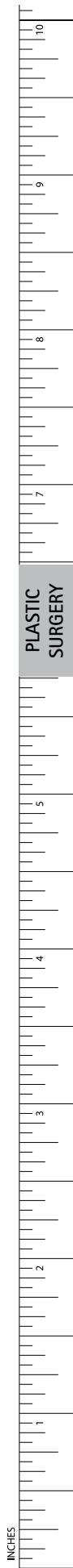

OL620R, MA185R, OL622R-OL624R, MD581

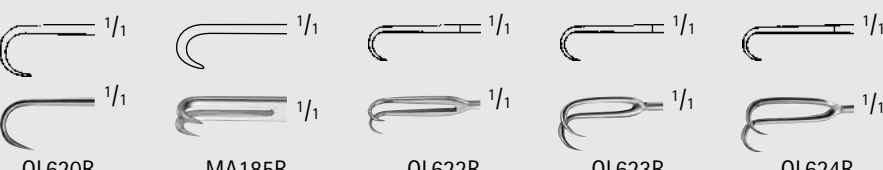

OL620R MA185R OL622R OL623R OL624R



MD581

JOSEPH Skin Hook

Catalog Number	Tip	Prongs	Tip Size (mm)	Length (in.)
OL620R	SHARP	1	-	6 1/2
MA185R	SHARP	2	2	6 1/4
OL622R	SHARP	2	3	6 1/2
OL623R	SHARP	2	6	6 1/2
OL624R	SHARP	2	8	6 1/2
MD581	SHARP	2	10	6 1/2



MG370R



MG370R

COTTLE-JOSEPH Double Hook

Catalog Number	Tip Size (mm)	Length (in.)
MG370R	12	5 3/4



OL621R



OL621R

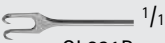

OL621R

FREER Double Hook

Catalog Number	Length (in.)
OL621R	6



OA357R-OA359R

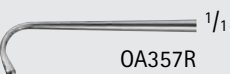

OA357R

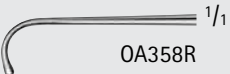

OA358R

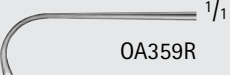

OA359R

GRAEFE Strabismus Nerve/Vessel Hook

Catalog Number	Tip	Length (in.)
OA357R	SMALL	5 1/2
OA358R	MEDIUM	5 1/2
OA359R	LARGE	5 1/2

Plastic Surgery

Hooks and Retractors

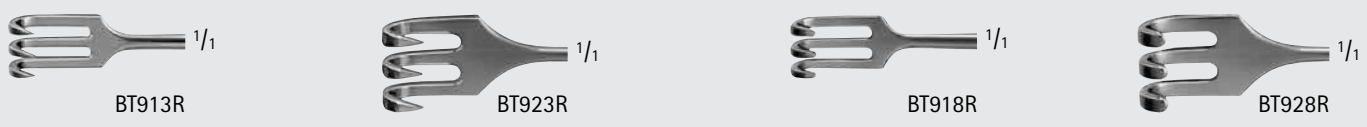
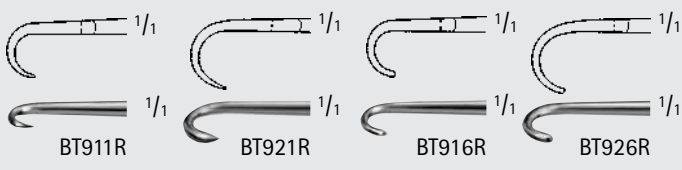
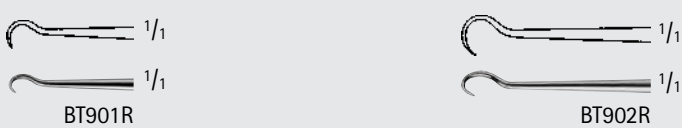
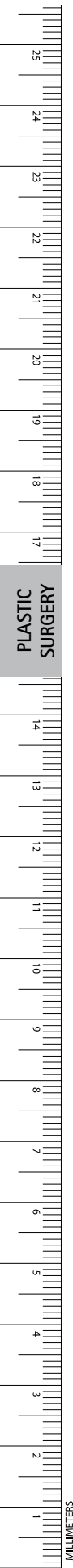

MANNERFELT Retractor

Catalog Number	Prongs	Tip	Blade Shape	Blade Size (mm)	Length (in.)
BT901R	1	SHARP	HOOK CVD	-	5 1/4
BT902R	1	SHARP	HOOK CVD	-	6 1/8
BT911R	1	SHARP	SMALL CVD	SMALL PRONG	6 1/8
BT921R	1	SHARP	SMALL CVD	LARGE PRONG	6 1/8
BT916R	1	BLUNT	SMALL CVD	SMALL PRONG	6 1/8
BT926R	1	BLUNT	SMALL CVD	LAGRGE PRONG	6 1/8
BT904R	2	SHARP	SMALL CVD	3.5 x 12	6 1/8
BT912R	2	SHARP	SMALL CVD	5 x 4	6 1/8
BT922R	2	SHARP	SMALL CVD	8 x 8	6 1/8
BT917R	2	BLUNT	SMALL CVD	5.5 x 4	6 1/8
BT927R	2	BLUNT	SMALL CVD	7 x 8	6 1/8
BT906R	2	SHORT	ANG	8 x 12.5	6 1/8
BT913R	3	SHARP	SMALL CVD	5.5 x 7.2	6 1/8
BT923R	3	SHARP	SMALL CVD	7 x 11	6 1/8
BT918R	3	BLUNT	SMALL CVD	5.5 x 7.2	6 1/8
BT928R	3	BLUNT	SMALL CVD	7 x 11	6 1/8

PLASTIC SURGERY

LANGENBECK-MANNERFELT Retractor

Catalog Number	Blade Size (mm)	Length (in.)
BT943R	15 x 6	6 1/8
BT944R	20 x 6	6 1/8
BT945R	25 x 6	6 1/8
BT946R	30 x 8	6 1/8

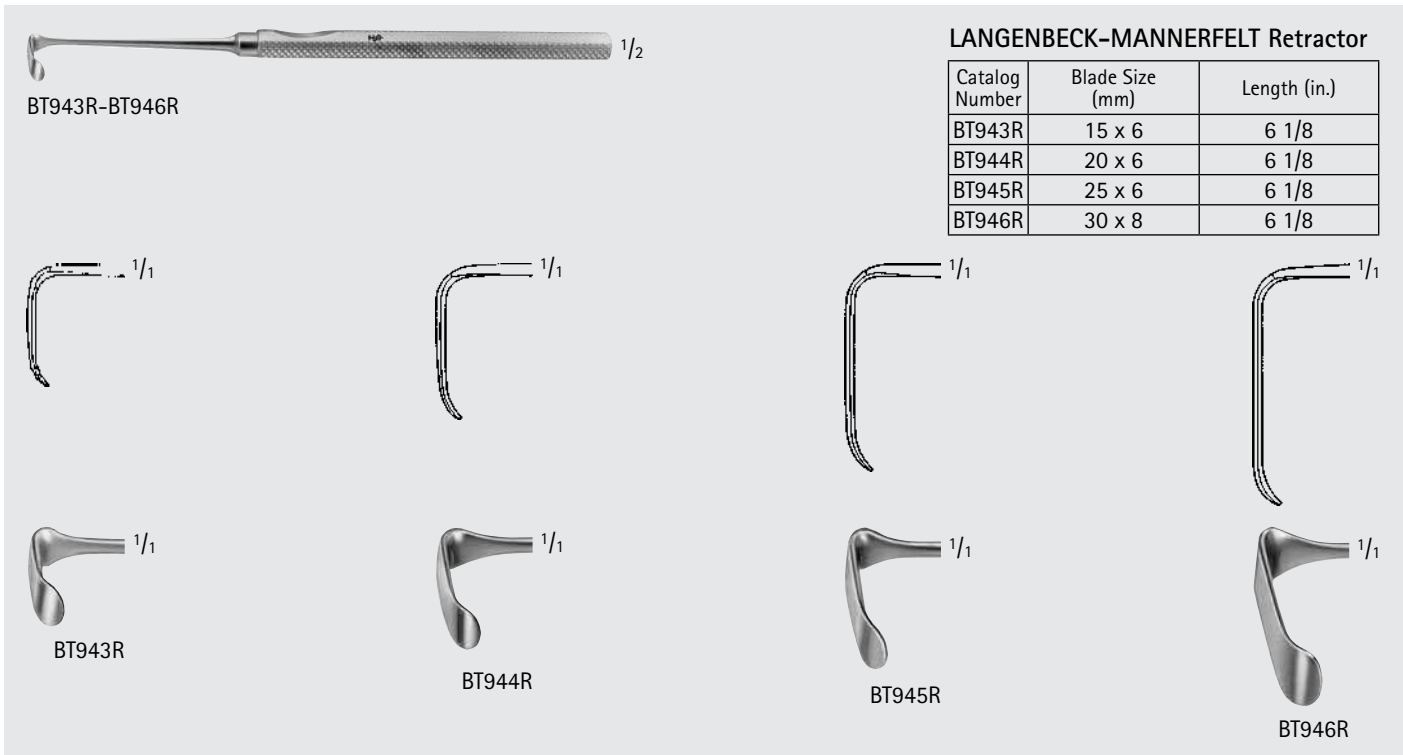

MANNERFELT Saddle Hook

Catalog Number	Tip Size (mm)	Length (in.)
BT940R	16 x 16	6 1/8
BT948R	12 x 12	6 1/8
BT949R	12 x 14	6 1/8
BT951R	14 x 16	6 1/8
BT958R	12 x 12 FEN	6 1/8

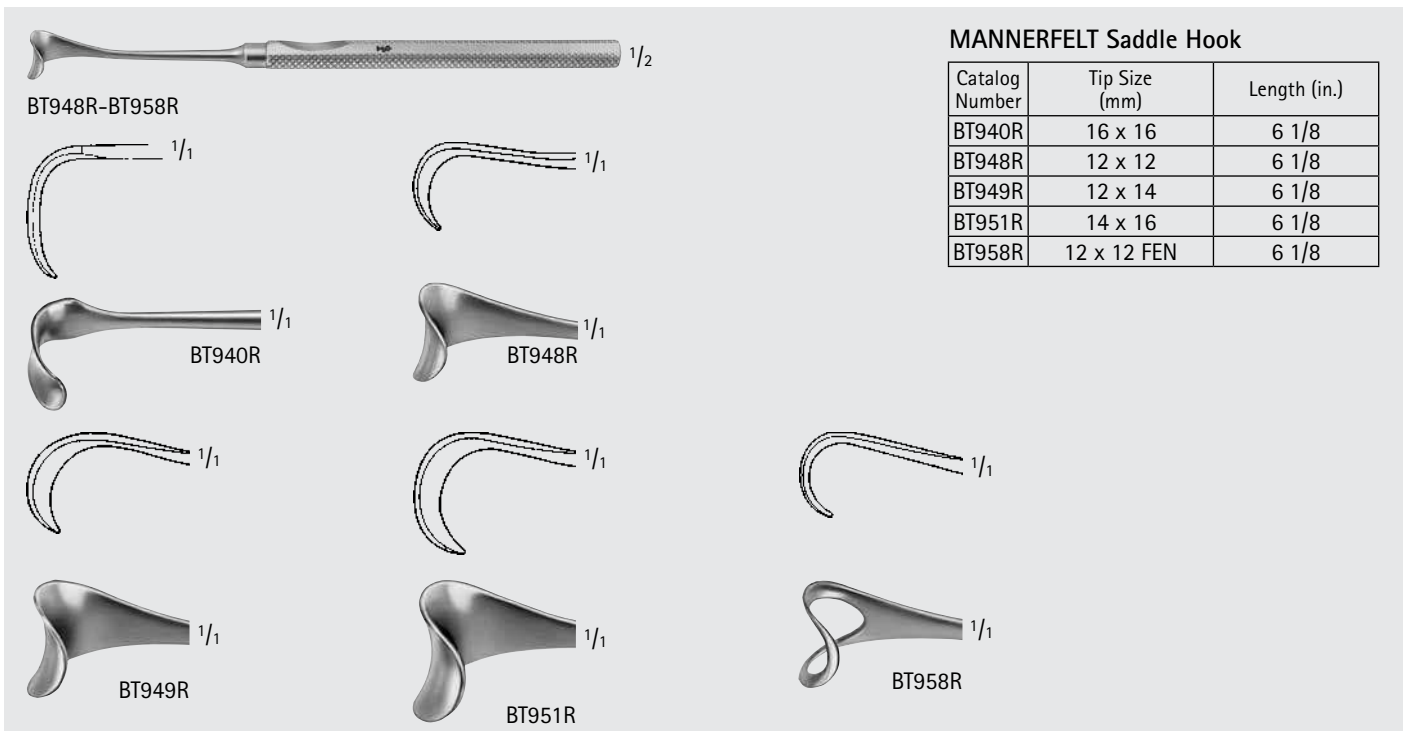

MANNERFELT Tendon Double Hook

Catalog Number	Length (in.)
BT964R	6 1/4

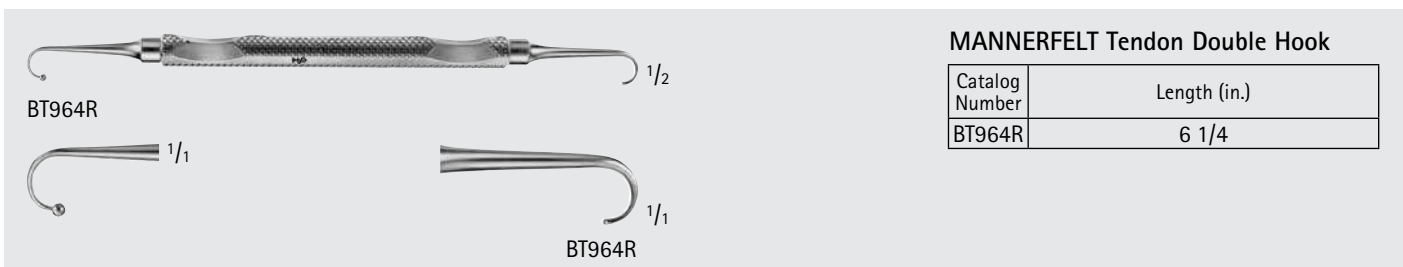
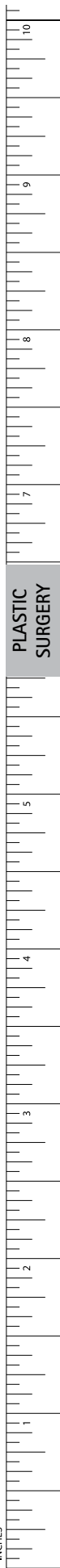
Plastic Surgery

Hooks and Retractors



BT966R

1/2



1/1



1/1

BT966R

MANNERFELT Double Spatula

Catalog Number	Length (in.)
BT966R	6 1/4



MB727R-MB733R

1/2

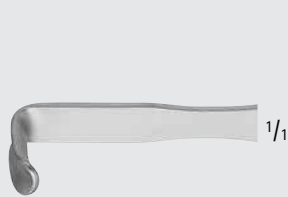

1/1



1/1

MB727R-MB733R

CRILE Retractor

Catalog Number	Size	Blade Size (mm)	Length (in.)
MB727R	1	3 x 11 / 6 x 21	4 1/4
MB728R	2	6 x 13 / 10 x 21	6 1/8
MB729R	3	16 x 25 / 17 x 35	6 1/4
MB730R	4	22 x 29 / 29 x 44	7
MB731R	5	29 x 41 / 35 x 51	7
MB732R	6	32 x 64 / 35 x 70	7 7/8
MB733R	7	41 x 76 / 51 x 79	8 7/8



MB384R

1/2

TEBBETTS Breast Spatula, Semi-Malleable

Catalog Number	Length (in.)
MB384R	12 1/2

PLASTIC SURGERY

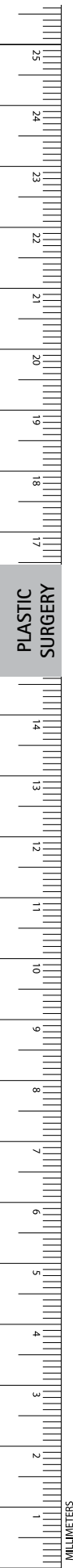

TEBBETTS Breast Retractor

Catalog Number	Blade	Length (in.)
MB647R	DBL-ENDED	12



MB647R

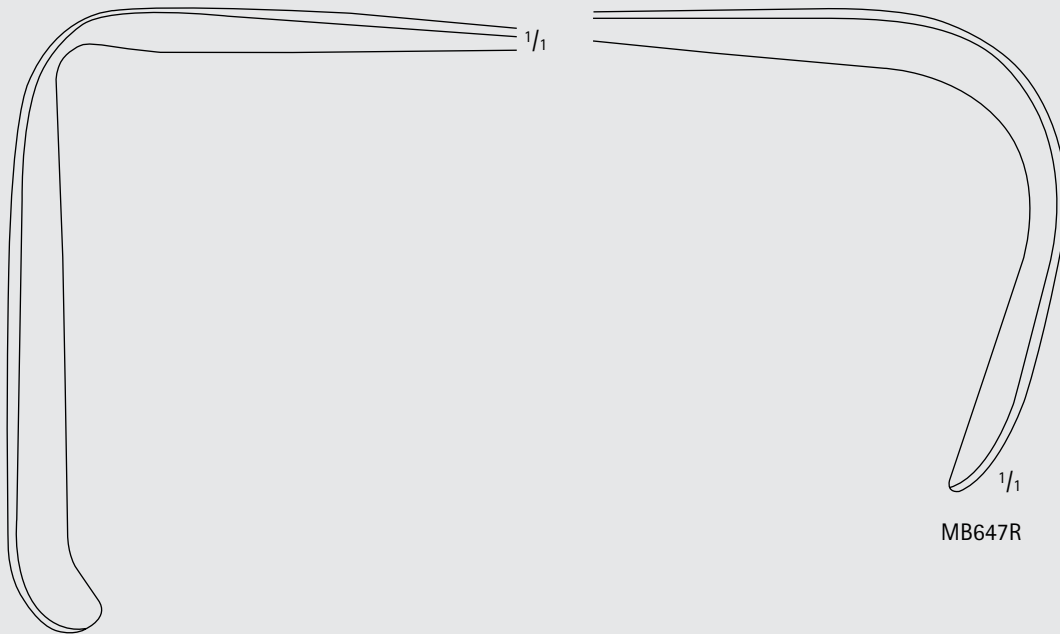

MB647R



MB934R

FREEMAN Facelift Retractor

Catalog Number	Length (in.)
MB934R	7

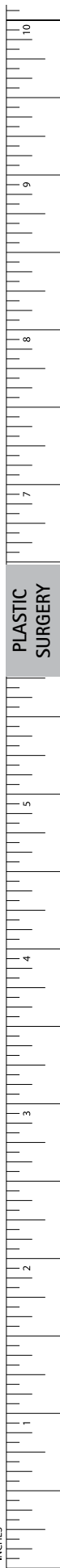

Plastic Surgery

Hooks and Retractors



OL211R



OL211R



OL212R



OL212R

COTTLE Alar (MASING) Retractor

Catalog Number	Blade Size (mm)	Length (in.)
OL211R	6 x 12	5 1/2
OL212R	10 x 12	5 1/2



OA310R-OA314R



OA310R



OA311R



OA312R



OA313R



OA314R

DESMARRES Lid Retractor

Catalog Number	Blade Size (mm)	Length (in.)
OA310R	9 x 9	5 1/2
OA311R	9 x 12	5 1/2
OA312R	11 x 14	5 1/2
OA313R	12 x 16	5 1/2
OA314R	13 x 18	5 1/2

PLASTIC SURGERY

MILLIMETERS



BV001R

1/2

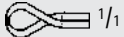

BV001R

1/1

FINSEN Retractor

Catalog Number	Tip	Blade End	Length (in.)
BV001R	SHARP	2 x 3 PRONGS	2



BV002R

1/2

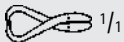

BV002R

1/1

FINSEN Retractor

Catalog Number	Tip	Blade End	Length (in.)
BV002R	SHARP	3 x 4 PRONGS	2 3/4



BV003R

1/2

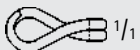

BV003R

1/1

FINSEN Modified Retractor

Catalog Number	Tip	Blade End	Length (in.)
BV003R	BLUNT	2 x 3 PRONGS	3

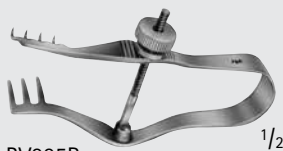

BV005R

1/2



BV005R

1/1

FINSEN Retractor

Catalog Number	Tip	Blade End	Length (in.)
BV005R	SHARP	3 x 4 PRONGS	2 3/4



BV008R, BV015R

1/2



BV015R

1/1



BV008R

1/1

HEISS Self-Retaining Retractor

Catalog Number	Tip	Prongs	Length (in.)
BV015R	SHARP	4 x 4	4
BV008R	BLUNT	4 x 4	4



PLASTIC SURGERY

INCHES

Plastic Surgery

Hooks and Retractors



BV006R-BV007R



BV006R



BV007R

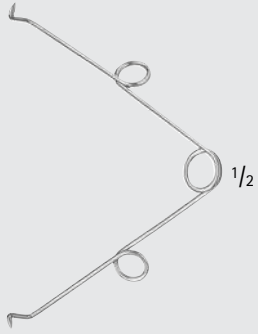

MD471

Spring Wire Retractor

Catalog Number	Tip	Prongs	Length (in.)
BV006R	BLUNT	3 x 3	1 3/4
BV007R	BLUNT	3 x 3	2 1/4
MD471	SHARP	1 x 1	3

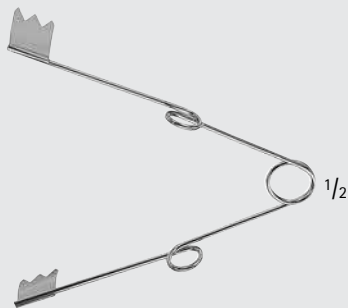

MB194R-MB195R

Spring Wire Retractor

Catalog Number	Length (in.)
MB194R	3 1/2
MB195R	4 1/2

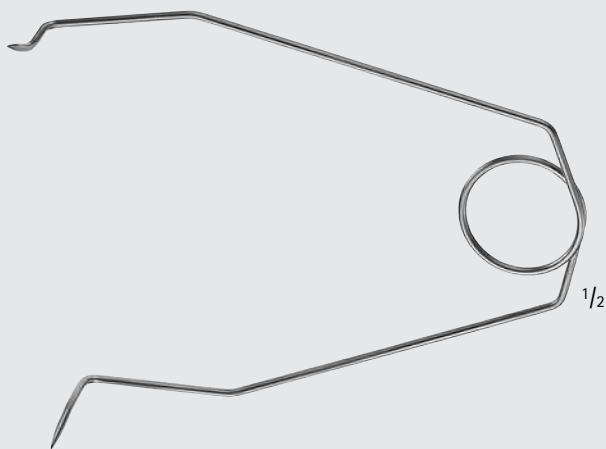

MB777R-MB196R

Spring Wire Retractor

Catalog Number	Size	Length (in.)
MB777R	SMALL	5
MB778R	MEDIUM	5 1/8
MB196R	LARGE	9

PLASTIC SURGERY

MILLIMETERS



BV010R-BV011R

ALM Retractor

Catalog Number	Tip	Prongs	Length (in.)
BV010R	SHARP	4 x 4	2 3/4
BV011R	SHARP	4 x 4	4



BV010R



BV011R



BV028R

ALLPORT Retractor

Catalog Number	Tip	Prongs	Length (in.)
BV028R	SHARP	4 x 4	3 3/4



BV028R

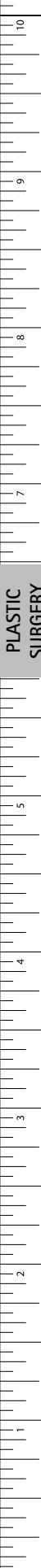

PLASTIC SURGERY

INCHES

Plastic Surgery

Aluminum Hand

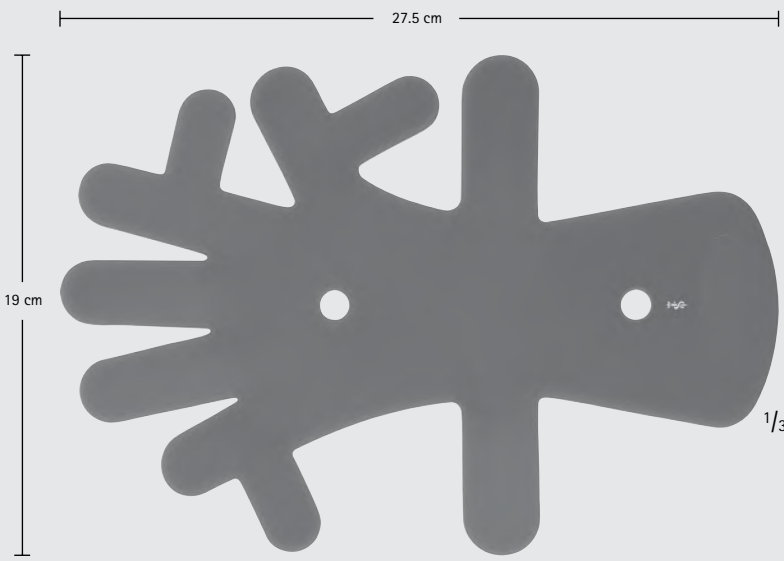
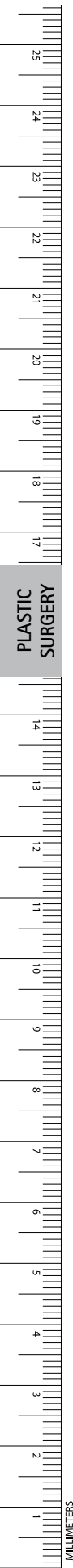

F0917A

Aluminum Hand, Blue Silicone Coated

Catalog Number	Size (in.)
F0917A	10 3/4 x 7 1/2
F0918A	16 1/8 x 11

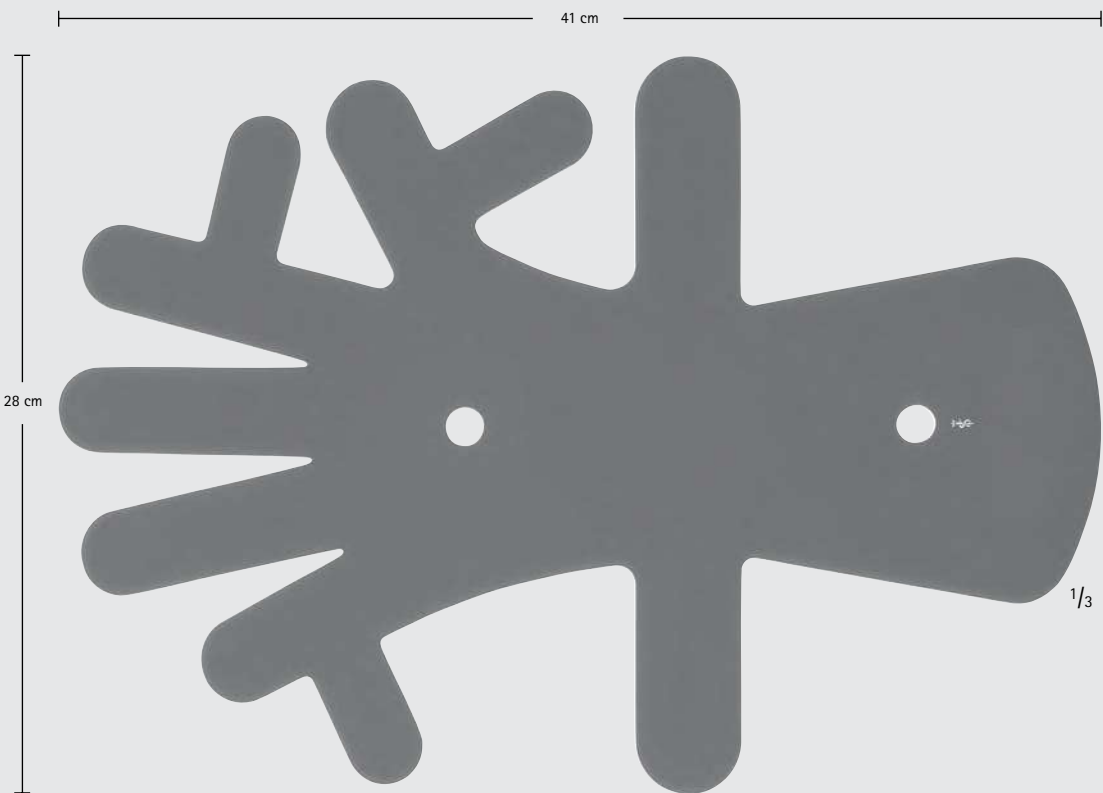

F0918A

Areola Cookie Cutter

Catalog Number	Diameter (mm)	Blade
AD123R	33.0	TOOTHED
AD125R	38.0	TOOTHED
AD127R	42.0	TOOTHED
AD129R	48.0	TOOTHED



SCHINK Knife, Adjustable From 0.1 To 2.0MM

Catalog Number	Length (in.)
BA706R	11 3/4
BA708R	

BA706R Includes:
1 Spare Blade BA708R and
1 Skin Straightening Plate BA709R

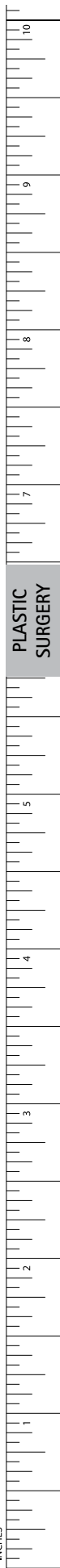

PLASTIC SURGERY

INCHES

Plastic Surgery

Knives

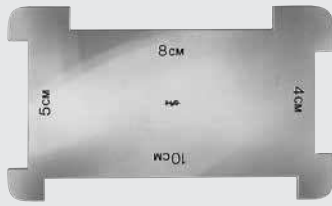

BA709R

Skin Straightening Plate

Catalog Number
BA709R



MD025

GOULIAN Skin Graft Knife Set

Catalog Number	Length (in.)
MD025	7 1/4
BA711R	BOX/50

MD025 includes 3 grafting templates: .20, .25, and .30 mm thick and blades



BA711R



MG575R

TEBBETTS Precision Knife Handle

Catalog Number	Blade Size (mm)	Length (in.)
MG575R	10 - 15	5 3/4



MG575R

PLASTIC SURGERY

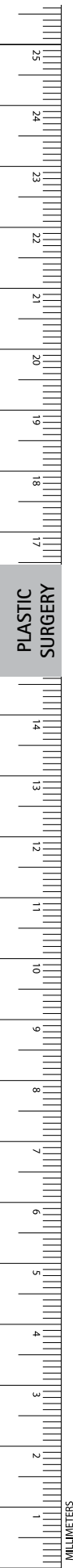

Skin Graft Knife

Catalog Number	Item	Length (in.)
BA718R	SPARE BLADE, STERILE, 10/PKG	-
BA719R	KNIFE, W/ O BLADE	11 3/4

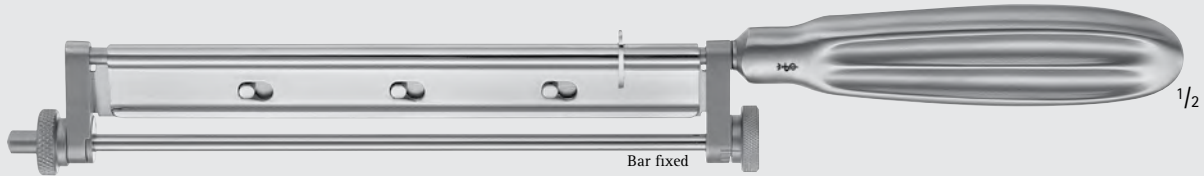

BA718R-BA719R

KEYES Dermal Punch Set

Catalog Number
OL670R

OL670R includes:
5 interchangeable tips, handle and rack



OL670R

FOX Dermal Currettes

Catalog Number	Diameter (mm)	Length (in.)
MG150R	2	5 5/8
MG151R	3	5 5/8
MG152R	4	5 5/8
MG153R	5	5 5/8
MG154R	6	5 5/8

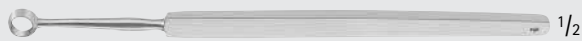

MG150R-MG154R



MG150R



MG151R



MG152R



MG153R



MG154R

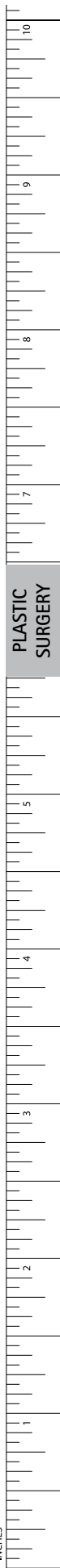

Plastic Surgery

Suction Instruments

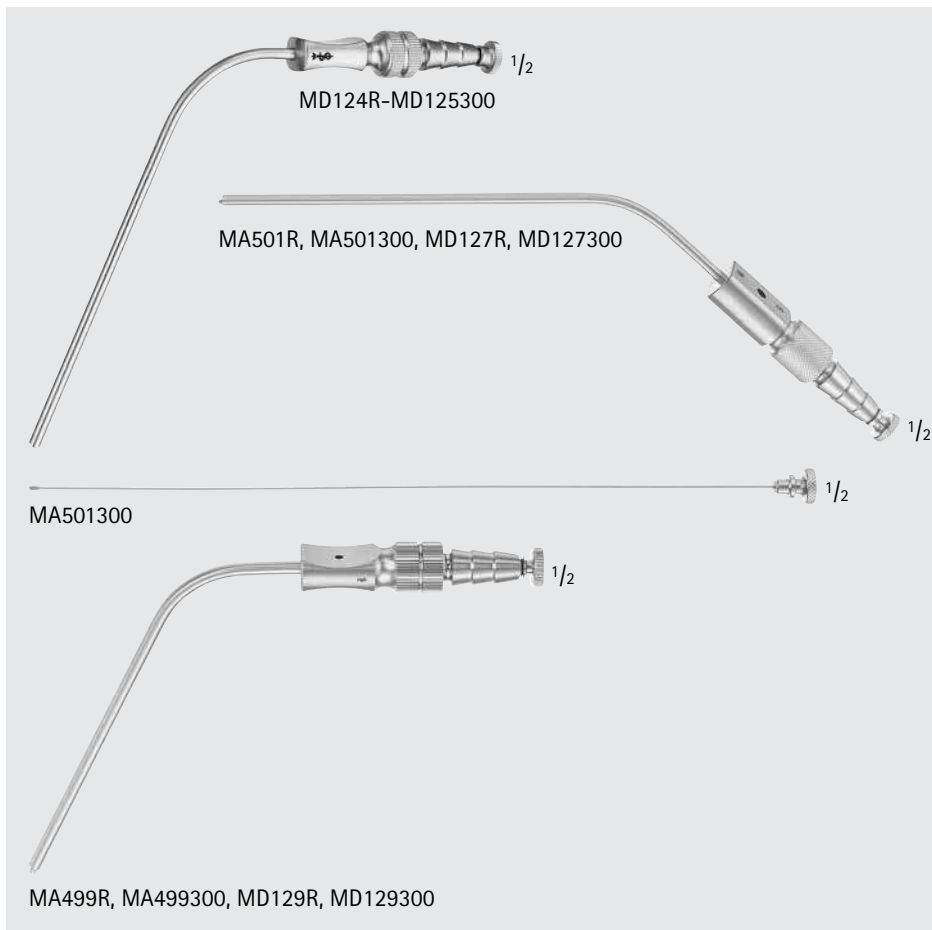
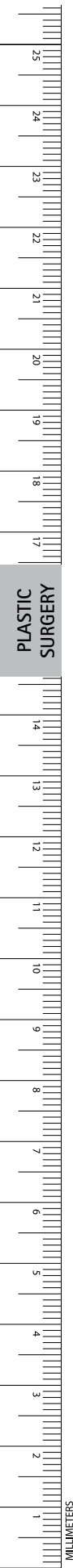

FRAZIER Suction Tube

Catalog Number	Tip Size (FR)	Description	Working Length (in.)
MD124R	7		4 1/4
MD124300	7	SUCTION STYLET W/ OLIVE TIP FOR MD124R	
MD125R	7		4 1/4
MD125300	8	SUCTION STYLET W/ OLIVE TIP FOR MD125R	
MA501R	9		4 1/4
MA501300		SUCTION STYLET W/ OLIVE TIP FOR MA501R	
MD127R	10		4 1/4
MD127300	10	SUCTION STYLET W/ OLIVE TIP FOR MD127R	
MA499R	11		4 1/4
MA499300	11	SUCTION STYLET W/ OLIVE TIP FOR MA499R	
MD129R	12		4 1/4
MD129300	12	SUCTION STYLET W/ OLIVE TIP FOR MD129R	

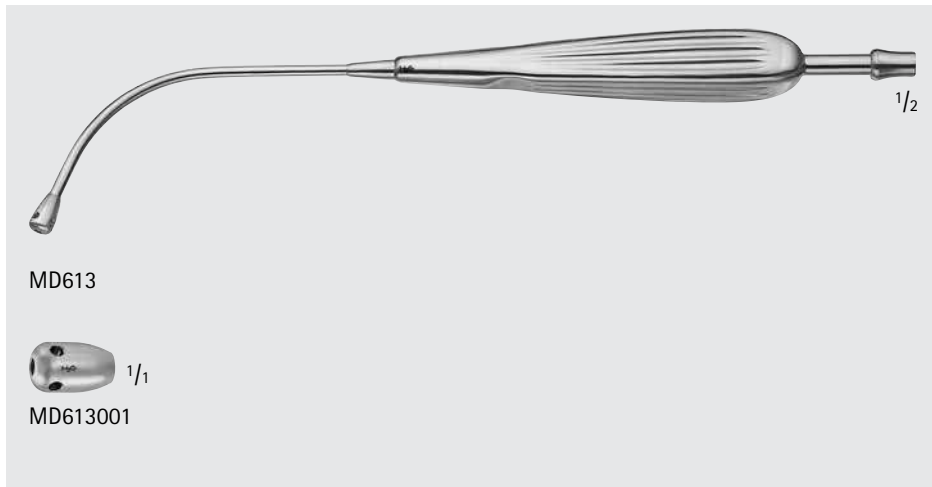

ANDREWS Pynchon Suction Tube

Catalog Number	Description	Length (in.)
MD613	-	9
MD613001	TIP ONLY F/ MD613	-

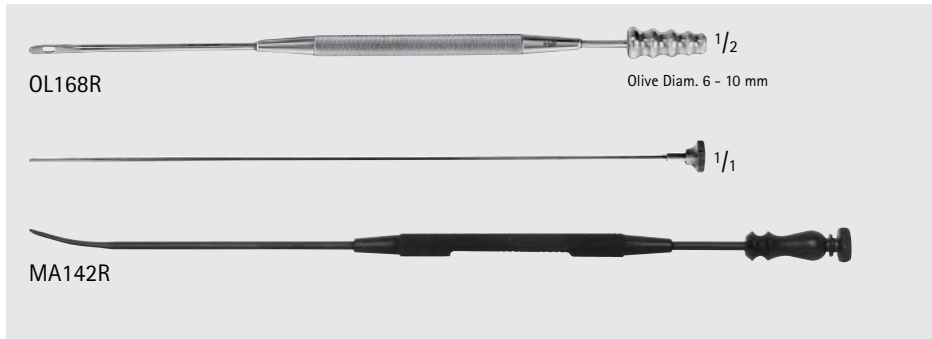

GORNEY Suction Dissector, Elevator

Catalog Number	Tip Size (mm)	Length (in.)
OL168R	6-10	7
MA142R	3	8 1/2



D0711R

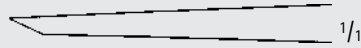

D0711R

LUCAS Chisel, Angled

Catalog Number	Tip Size (mm)	Length (in.)
D0711R	4	6 1/4



FL120R-FL128R



FL120R-FL128R

Chisel, Angled

Catalog Number	Tip Size (mm)	Length (in.)
FL120R	4	5 1/2
FL122R	6	5 1/2
FL124R	8	5 1/2
FL126R	10	5 1/2
FL128R	12	5 1/2



FL173R-FL176R

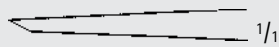

FL173R-FL176R



FL183R-FL187R

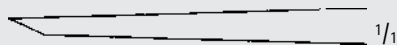

FL183R-FL187R

PARTSCH Chisel

Catalog Number	Tip Size (mm)	Length (in.)
FL173R	3	5 1/2
FL174R	4	5 1/2
FL175R	5	5 1/2
FL176R	6	5 1/2
FL183R	3	6 3/4
FL184R	4	6 3/4
FL185R	5	6 3/4
FL186R	6	6 3/4
FL187R	7	6 3/4



PLASTIC SURGERY

INCHES

Plastic Surgery

Bone Instruments



D0715R

LUCAS Gouge

Catalog Number	Tip Size (mm)	Length (in.)
D0715R	3	6 1/4

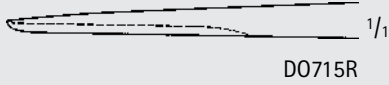

D0715R



FL130R-FL136R

Gouge

Catalog Number	Tip Size (mm)	Length (in.)
FL130R	4	5 1/2
FL132R	6	5 1/2
FL134R	8	5 1/2
FL136R	10	5 1/2

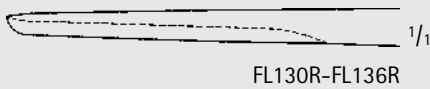

FL130R-FL136R



FL153R

MANNERFELT Gouge

Catalog Number	Tip Size (mm)	Length (in.)
FL153R	3	6 1/8

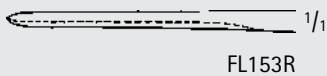

FL153R



FL213R-FL216R

PARTSCH Gouge

Catalog Number	Tip Size (mm)	Length (in.)
FL213R	3	5 1/2
FL214R	4	5 1/2
FL215R	5	5 1/2
FL216R	6	5 1/2
FL223R	3	6 3/4
FL224R	4	6 3/4
FL225R	5	6 3/4
FL226R	6	6 3/4
FL227R	7	6 3/4



FL213R-FL216R



FL223R-FL227R

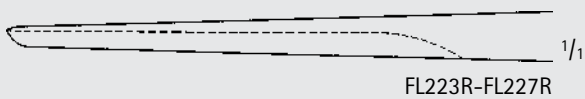

FL223R-FL227R



FL343R-FL347R

ALEXANDER Gouge

Catalog Number	Tip Size (mm)	Length (in.)
FL343R	7	6 3/4
FL345R	9	6 3/4
FL347R	11	6 3/4

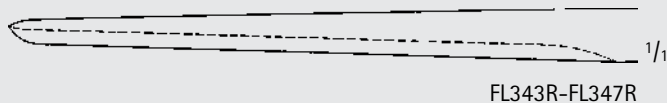

FL343R-FL347R

PLASTIC SURGERY

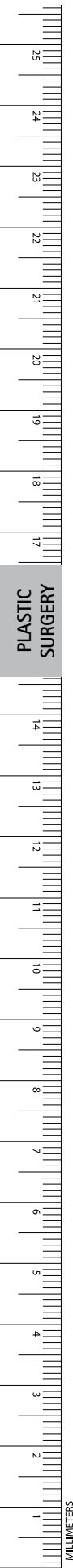

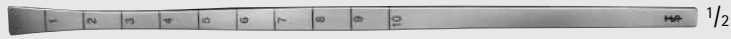
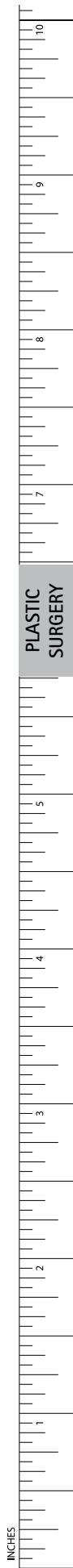

COTTLE Fishtail Chisel, W/ Protected Ends

OL307R

Catalog Number	Tip Size (mm)	Length (in.)
OL307R	8	7



OL307R



STRAND Osteotome

FL110R-FL118R

Catalog Number	Tip Size (mm)	Blade	Length (in.)
FL110R	4	STR	5 1/2
FL112R	6	STR	5 1/2
FL114R	8	STR	5 1/2
FL116R	10	STR	5 1/2
FL118R	12	STR	5 1/2



FL110R-FL118R



MANNERFELT Osteotome

FL144R-FL148R

Catalog Number	Tip Size (mm)	Length (in.)
FL144R	4	6 1/8
FL146R	6	6 1/8
FL148R	8	6 1/8



FL144R-FL148R



Mallet, Lead Filled, 80gr

DF112R

Catalog Number	Diameter (mm)	Length (in.)
DF112R	22	6 1/2

Ø 22.5 mm

Plastic Surgery
Bone Instruments

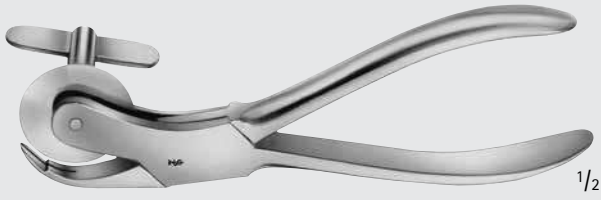

F0900R-F0901R



F0901R

Finger Ring Saw

Catalog Number	Item	Length (in.)
F0900R	COMPLETE	6
F0901R	REPLACEMENT BLADE	-



F0903R



F0903R

Nail Extracting Forceps

Catalog Number	Length (in.)
F0903R	5 1/4

PLASTIC SURGERY

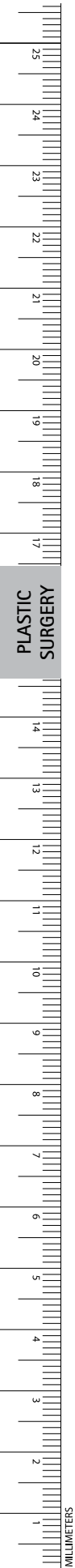



D0810R

OBWEGESER Awl F/ Lower Jaw

Catalog Number	Length (in.)
D0810R	5 1/2



D0810R



D0812R

OBWEGESER Suture Wire Awl

Catalog Number	Length (in.)
D0812R	7 3/4
D0811R	9



D0812R



D0811R



D0811R



PLASTIC SURGERY

INCHES

Plastic Surgery

Bone Instruments

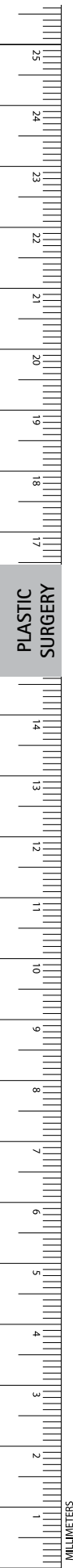

FK318R

1/2

6 mm

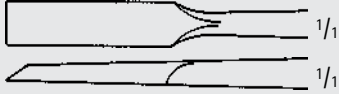

1/1

1/1

FK318R



FK317R

1/2

3 mm

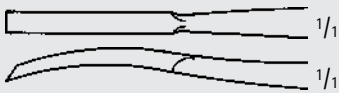

1/1

1/1

FK317R



FK319R

1/2

6 mm

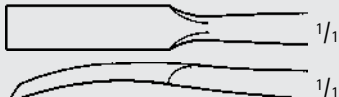

1/1

1/1

FK319R



FK321R

1/2

6 mm

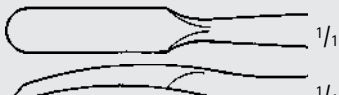

1/1

1/1

FK321R

Raspatory W/ PEEK Handle

Catalog Number	Tip	Tip Size (mm)	Blade	Length (in.)
FK318R	FLAT	6	STR	7 1/2
FK317R	FLAT	3	CVD	7 1/4
FK319R	FLAT	6	CVD	7 1/2
FK321R	RND	6	CVD	7 1/2



D0543R

1/2

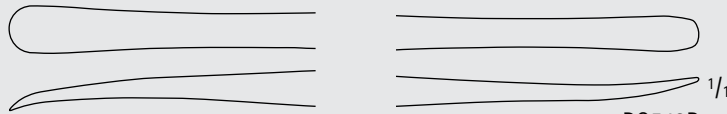

D0543R

1/1

MOLT Raspatory and Elevator, Double Ended

Catalog Number	Length (in.)
D0543R	7



D0552R-D0553R

1/2



D0552R

1/1



D0553R

1/1



SELDIN Raspatory, Double Ended

Catalog Number	Size	Length (in.)
D0552R	SMALL	7 3/4
D0553R	LARGE	7 3/4

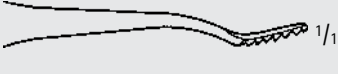

D0773R 1/2

MILLER Bone Rasp		
Catalog Number	Tip Size (mm)	Length (in.)
D0773R	6.0 / 5.0	7



6 mm 5 mm

D0773R



FK530R-FK552R 1/2

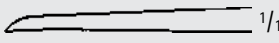
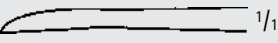

MANNERFELT Modified Elevator			
Catalog Number	Tip	Tip Size (mm)	Length (in.)
FK530R	SPOON	4	6 1/8
FK532R	SPOON	7	6 1/8
FK534R	SPOON	9	6 1/8
FK541R	CVD	3	6 1/8
FK543R	CVD	6	6 1/8
FK552R	SLIGHT-CVD, ROUND	8	6 1/8

FK530R FK532R

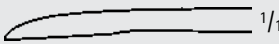
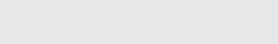
FK534R

FK541R FK543R FK552R

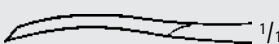
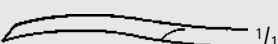
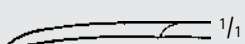
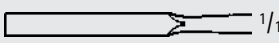

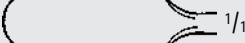
DP031R 1/2

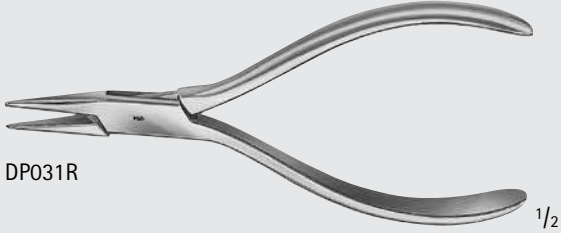

DP031R

MARBURG Needle Nose Pliers		
Catalog Number	Tip	Length (in.)
DP031R	SERR	5 1/2



PLASTIC SURGERY

INCHES

Plastic Surgery

Bone Instruments

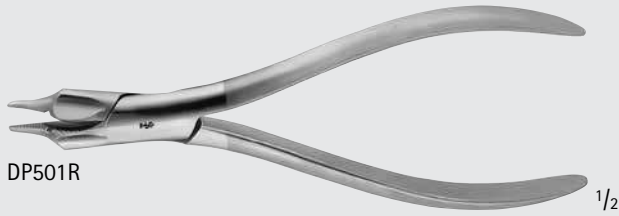
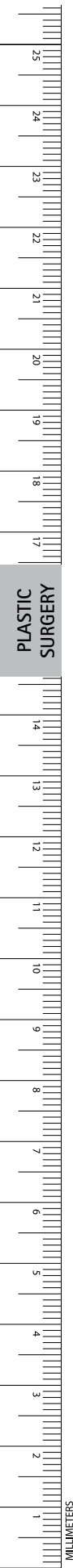

Universal Wire Cutter

Catalog Number	For Wire Size	Length (in.)
DP501R	SOFT, UP TO 1.5MM AND HARD, UP TO 1.0MM	6
DP505R	SOFT, UP TO 1.5MM AND HARD, UP TO 1.2MM	6 1/4

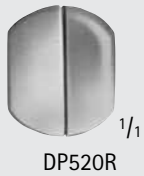

Wire Cutter, W/ Specially Hardened Cutting Edges

Catalog Number	For Wire Size	Blade End	Length (in.)
DP520R	SOFT, UP TO 1.5MM AND	X-HARD EDGE	5 3/4
DP530R	SOFT, UP TO 1.5MM AND	X-HARD EDGE	5 1/2

DUROTIP™ TC Wire Cutting Scissors

Catalog Number	For Wire Size	Blade	Length (in.)
DP552R	SOFT, UP TO 1.2MM AND HARD, UP TO 0.8 MM	1-SERR	4 3/4

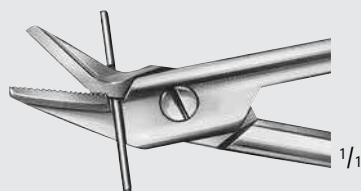
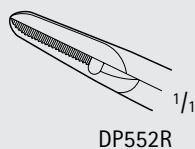
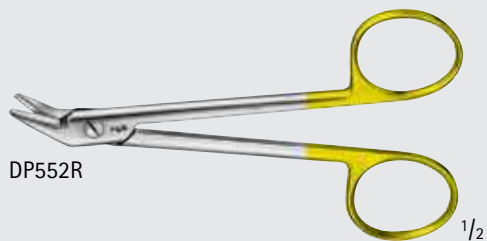

BEEBE Crown Scissors

Catalog Number	Tip	Blade	Length (in.)
DP560R	SHARP	STR	4 1/4
DP561R	SHARP	CVD	4 1/4
DP563R	BROAD	CVD	4 1/4
DP569R	ONE-SERR	CVD	4 1/4

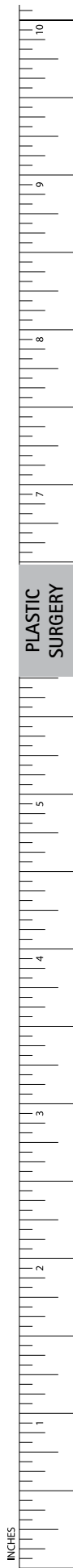
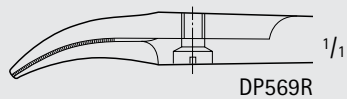
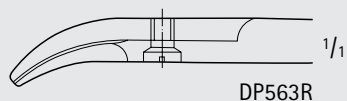
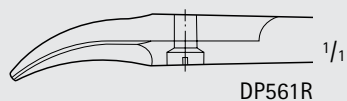
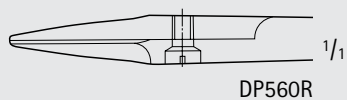

INCHES

Plastic Surgery

Micro Vessel Clips and Clamps

- The arterial clips have a slightly inwards curved jaw tip to prevent slipping, see Fig.1
- The venous clips have a flat parallel closing jaw, see Fig. 2

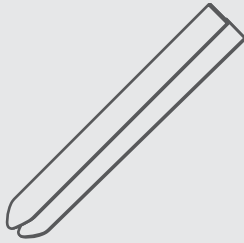

Fig. 1

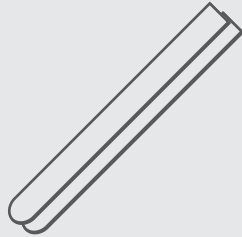

Fig. 2



FD870R-FD874R



FD875R-FD878R



FD879R-FD880R



FD881R-FD884R



FD885R-FD888R



FD889R-FD890R



FD891R-FD894R



FD895R



FD896R-FD897R



FD896R

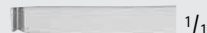

FD897R

ACLAND Micro Vessel Clips

Catalog Number	Jaw Length (mm)	Size	Description	Vessel Size (mm)
FD870R	8	B-1	Artery	0.3-1.0
FD871R	8	B-1	Vein	0.3-1.0
FD872R	11	B-2	Artery	0.6-1.4
FD873R	11	B-2	Vein	0.6-1.4
FD874R	16	B-3	Artery	1.0-2.2
FD875R	16	B-3	Vein	1.0-2.2
FD876R	24	HD-S	Artery	1.5-3.3
FD877R	24	HD-S	Vein	1.5-3.3
FD878R	35	RD-S	Artery	2.0-5.0
FD879R	35	RD-S	Vein	2.0-5.0
FD880R	8	B-1	Artery	0.3-1.0
FD881R	8	B-1	Vein	0.3-1.0
FD882R	11	B-2	Artery	0.6-1.4
FD883R	11	B-2	Vein	0.6-1.4
FD884R	16	B-3	Artery	1.0-2.2
FD885R	16	B-3	Vein	1.0-2.2
FD886R	24	HD-D	Artery	1.5-3.3
FD887R	24	HD-D	Vein	1.5-3.3
FD888R	35	RD-D	Artery	2.0-5.0
FD889R	35	RD-D	Vein	2.0-5.0
FD890R	8	B-1	Artery	0.3-1.0
FD891R	8	B-1	Vein	0.3-1.0
FD892R	11	B-2	Artery	0.6-1.4
FD893R	11	B-2	Vein	0.6-1.4
FD894R	16	B-3	Artery	1.0-2.2
FD895R	16	B-3	Vein	1.0-2.2
FD896R	5 1/2	B-1, B-2	Clip Applying Forceps	-
FD897R	5 1/2	B-3, HD, RD	Clip Applying Forceps	-

All items are sold individually





FD560R-FD562R

BIEMER Vessel Clip

Catalog Number	Jaw Length (mm)	Jaw Opening (mm)	Closing Force
FD560R	6	4	30 - 40
FD561R	9	5	30 - 40
FD562R	9	5	20 - 25

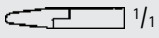

FD560R

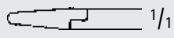

FD561R

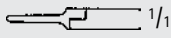

FD562R

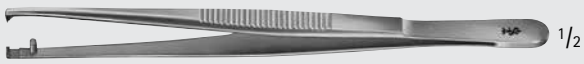

FD568R

**BIEMER Applying Forceps,
F/ FD560R-FD562R, FD611R-FD615R**

Catalog Number	Description	Length (in.)
FD568R	W/ O LOCK	5 1/2
FD569R	W/ LOCK	5 1/2



FD569R



FD571R

BIEMER Micro Approximator Only

Catalog Number	Jaw Length (mm)	Jaw Opening (mm)	Closing Force (gr)
FD571R	6	2	30 - 40

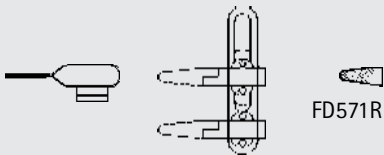

FD571R



FD572R

BIEMER Applying Forceps, F/ FD571R

Catalog Number	Length (in.)
FD572R	5 3/4



FD572R

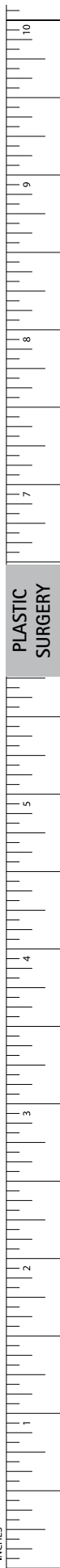

INCHES

Plastic Surgery

Micro Vessel Clips and Clamps



FD575R

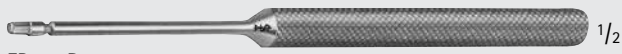

FD576R

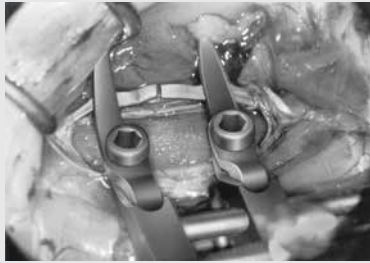

Micro Approximator

Catalog Number	Description
FD575R	COMPLETE WITH KEY
FD576R	KEY ALONE

BIEMER-MÜLLER Approximator

Catalog Number	Blade	Jaw Length (mm)	Jaw Opening (mm)	Closing Force (gr)
FD613R	STR, DEL	9	4	25 - 30
FD615R	STR	4,5	3	25 - 30
FD611R	STR	9	3	25 - 30
FD614R	ANG, DEL	9	3	25 - 30
FD612R	ANG	9	3	25 - 30



FD613R



FD615R



FD611R



FD614R



FD612R

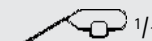
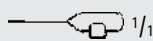
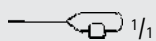
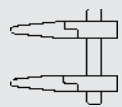
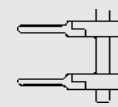
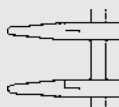
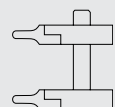
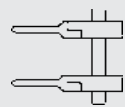

FD576R



FD635R

BIEMER Approximator, F/ Nerves

Catalog Number	Description
FD576R	KEY ALONE
FD635R	APPROXIMATOR COMPLETE WITH KEY AND NEEDLES
FD636R	SPARE NEEDLES, PR

PLASTIC SURGERY

ROYAL

INTERNATIONAL



ALIS



Manufacturing Unit -

**115-A Waryana Industrial Complex, Leather Complex Road,
Jalandhar Punjab, 144021**



Sales Office -

**Plot No. 581- Kakrola Housing Complex, Near Metro Pillar 802,
Dwarka Mor, Delhi, 110078**



Our Certifications -

**UDYAM , ISO 13485, WHO-GMP, ISO 9001:2015, CE , ROHS,
FDA , MD-42, MD-5**

CONTACT US:



+91- 98141-81255, +91- 98142-62255



www.alisprofessional.com



info@royalinternational.org