



Orthopedics/Spine

Scissors	880 - 885
Plaster/Nail/Wire Instruments	886 - 898
Meniscus Instruments	899
Forceps	900 - 916
Retractors	917 - 956
Rasps	957 - 959
Elevators and Bone Levers	960 - 973
Chisels/Gouges/Osteotomes	974 - 987
Mallets/Impactors/Bone Tamps	988 - 994
Drills/Burr/Reamers	995 - 996
Reamers and Trephines	997
Curettes	998 - 1013
Microdissectomy Instruments	1014 - 1018
Dissectors and Probes	1019
Rongeurs	1020 - 1049
Kerrison Bone Punches	1050 - 1057
KAIRison Pneumatic Bone Punch	1058 - 1059
Bone Cutters	1060 - 1063
Rulers, Calipers and Gauges	1064 - 1065

Orthopedics/Spine

Scissors



BC881R-BC989R

1/2

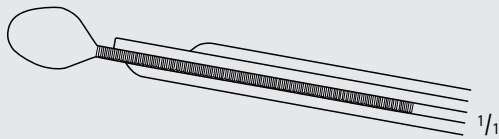

BC881R-BC989R

1/1

Universal Bandage Scissors

Catalog Number	Handle Color	Length (in.)
BC881R	BLACK	7
BC980R	RED	7
BC981R	BLUE	7
BC983R	YELLOW	7
BC985R	ORANGE	7
BC987R	PINK	7
BC988R	LIGHT GREEN	7
BC989R	VIOLET	7



BC885R-BC979R

1/2

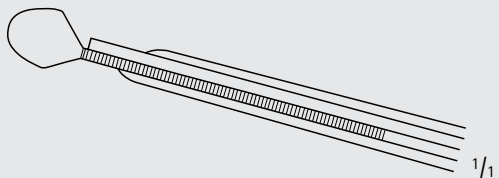

BC885R-BC979R

1/1

LISTER Universal Bandage Scissors

Catalog Number	Handle Color	Length (in.)
BC885R	BLACK	5 3/4
BC970R	RED	5 3/4
BC971R	BLUE	5 3/4
BC973R	YELLOW	5 3/4
BC975R	ORANGE	5 3/4
BC977R	PINK	5 3/4
BC978R	LIGHT GREEN	5 3/4
BC979R	VIOLET	5 3/4



ORTHO
SPINE

MILLIMETERS



BC876R, MB146R

1/2

LISTER Bandage Scissors, Serrated

Catalog Number	Length (in.)
MB146R	3 1/2
BC876R	6 1/4

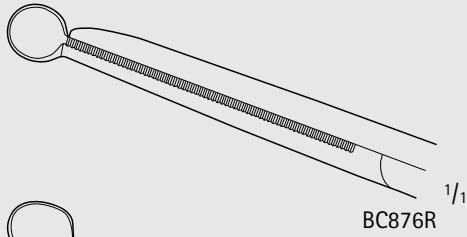

BC876R

1/1

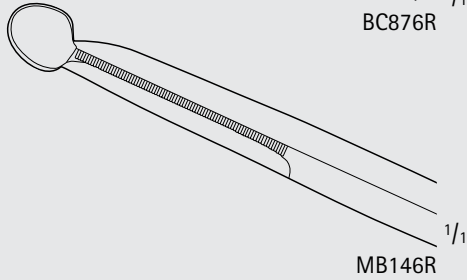

MB146R

1/1



ORTHO
SPINE

INCHES

Orthopedics/Spine

Scissors





BC848R-BC863R 1/2

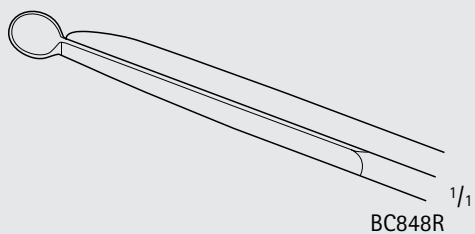

BC848R 1/1

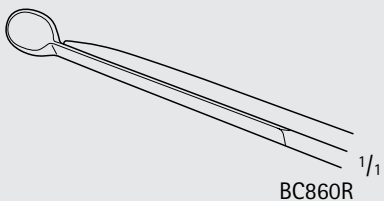

BC860R 1/1

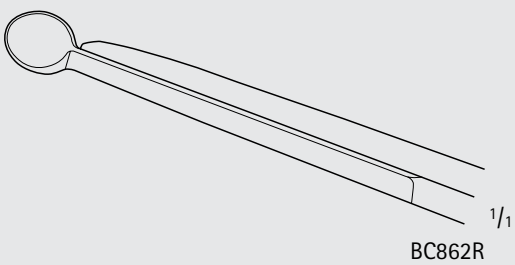

BC862R 1/1

LISTER Bandage Scissors

Catalog Number	Blade	Length (in.)
BC848R	LONG	6 1/8
BC849R	LONG	7
BC860R	STANDARD	4 1/2
BC861R	STANDARD	5 1/2
BC862R	STANDARD	7
BC863R	STANDARD	7 7/8

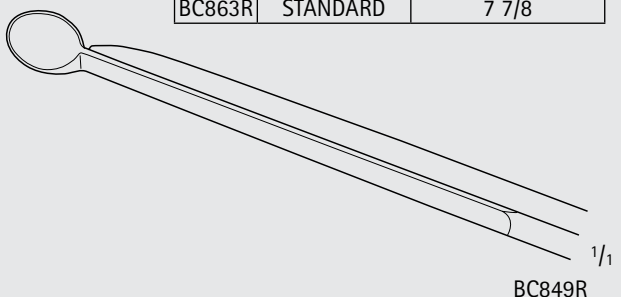

BC849R 1/1

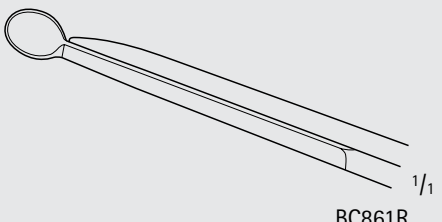

BC861R 1/1

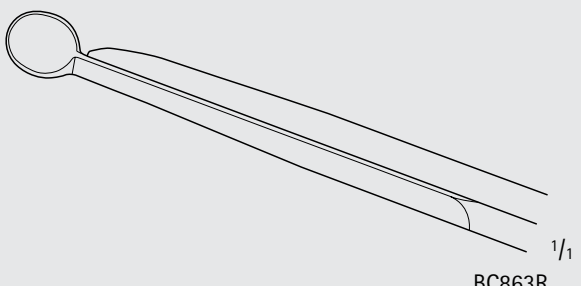

BC863R 1/1



MB223 1/2



MB223 1/1

LISTER Bandage Scissors W/ One Large Ring

Catalog Number	Length (in.)
MB223	8

Plaster and Bandage Scissors

Catalog Number	Length (in.)
LX558R	9 1/4

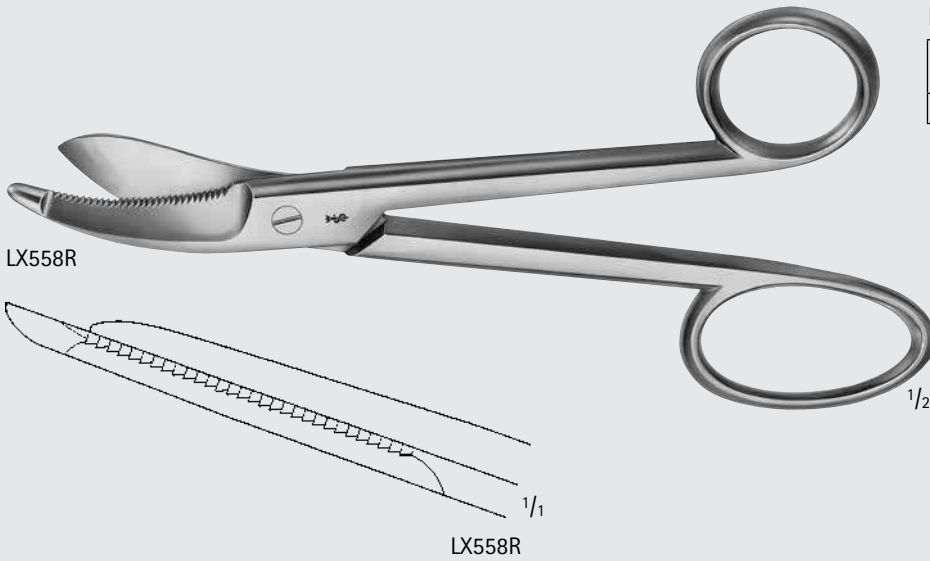

Plaster Scissors

Catalog Number	Length (in.)
LX548R	6 1/4



BRUNS Plaster Scissors

Catalog Number	Length (in.)
LX556R	9 1/4

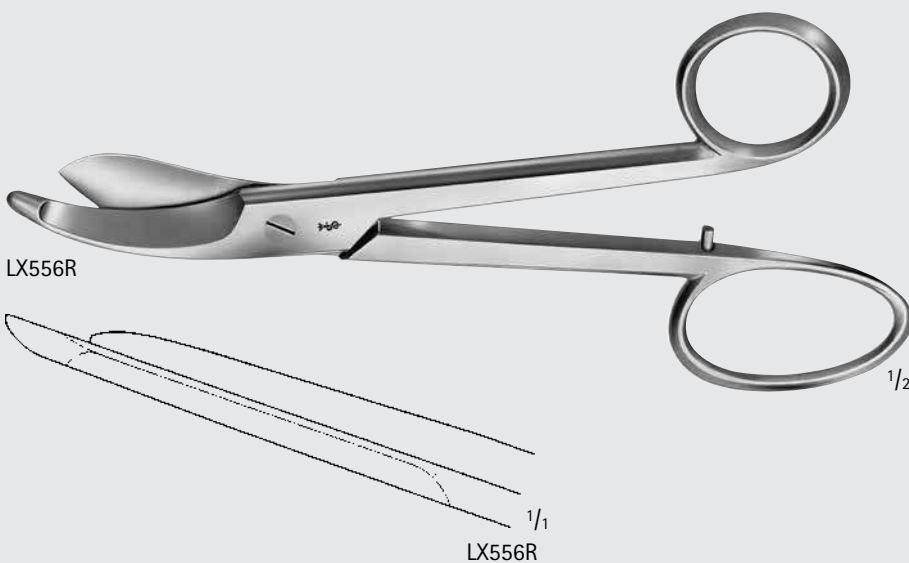

Orthopedics/Spine

Scissors

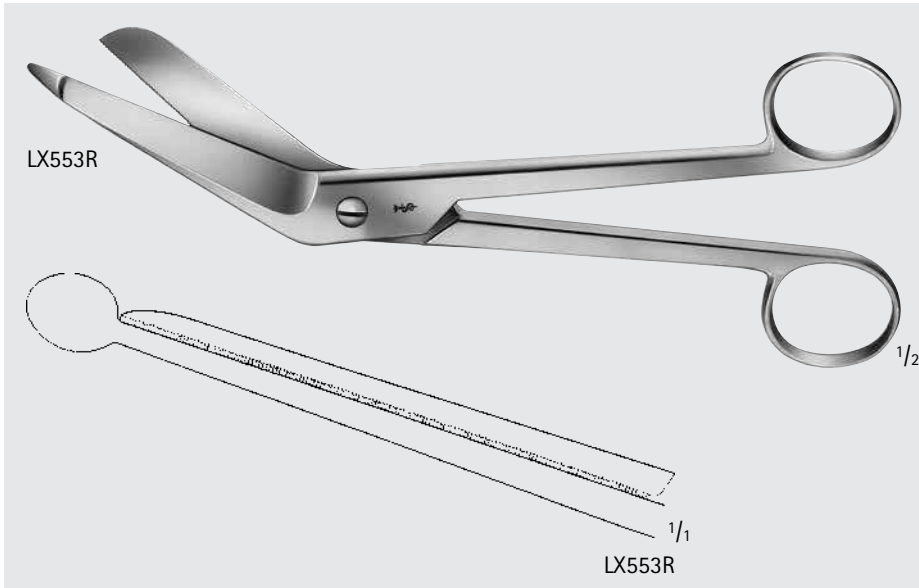

BERGMANN Plaster Scissors

Catalog Number	Length (in.)
LX553R	9

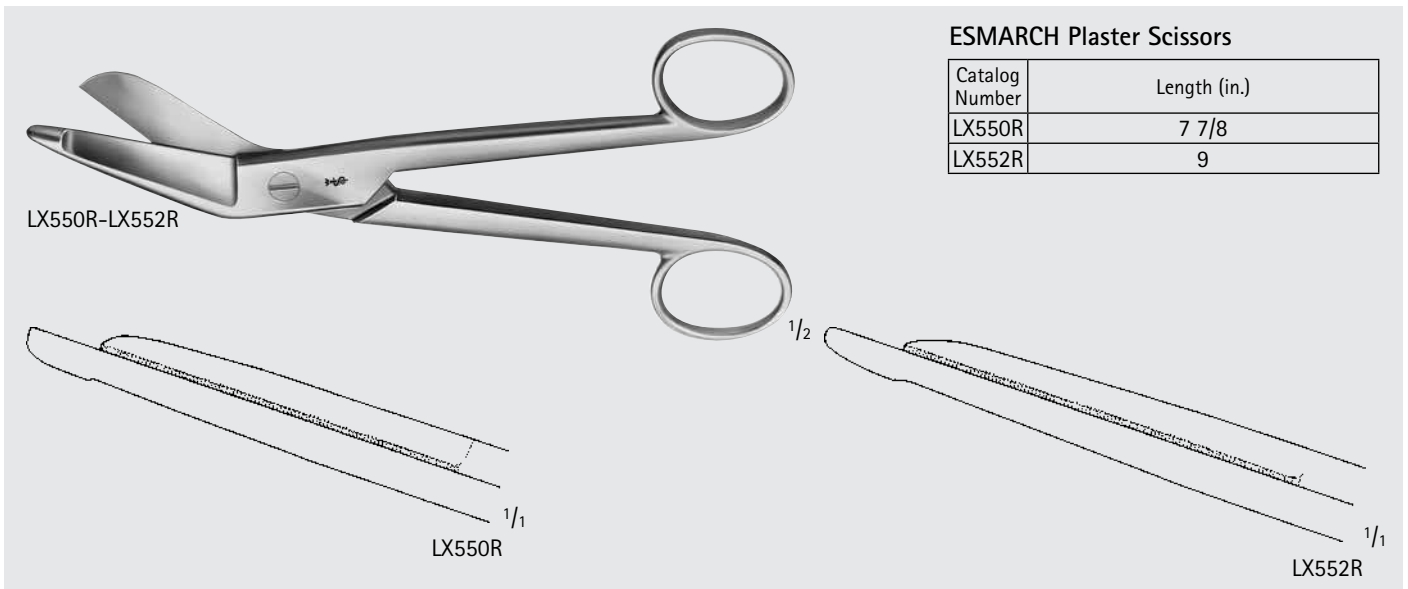

ESMARCH Plaster Scissors

Catalog Number	Length (in.)
LX550R	7 7/8
LX552R	9

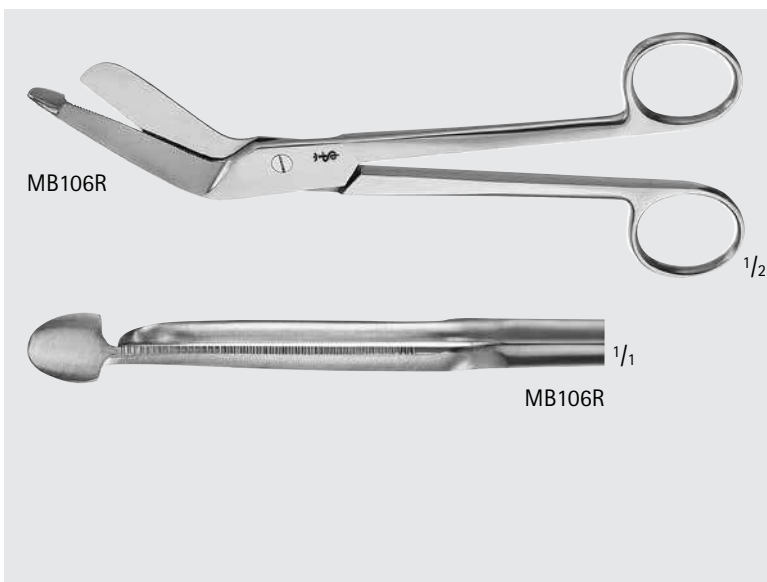

HERCULES Plaster Shears

Catalog Number	Length (in.)
MB106R	7 1/2

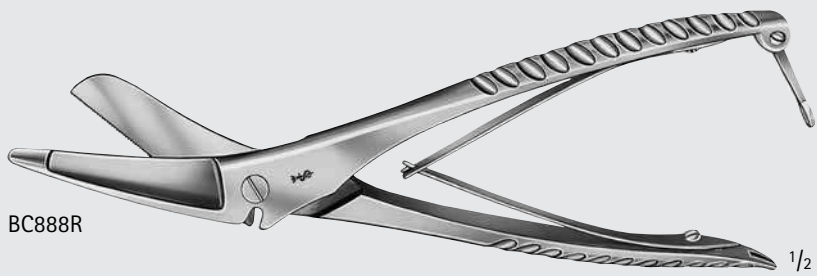

BC888R 1/2

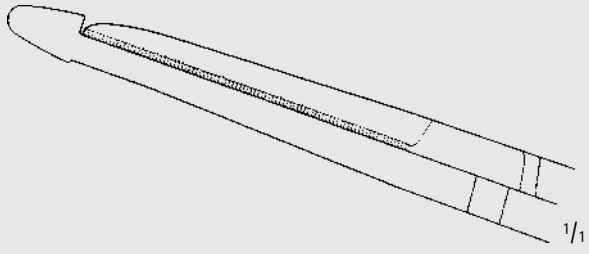

1/1

BC888R

Plaster Scissors

Catalog Number	Length (in.)
BC888R	8



LX565R 1/2

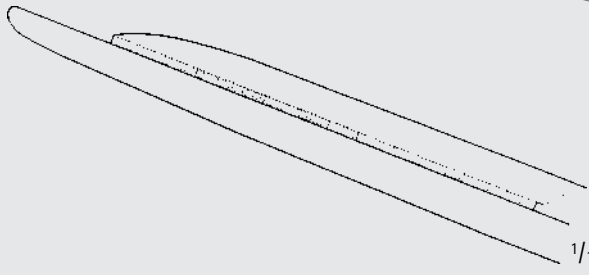

1/1

LX565R

SEUTIN Plaster and Bandage Scissors

Catalog Number	Length (in.)
LX565R	9

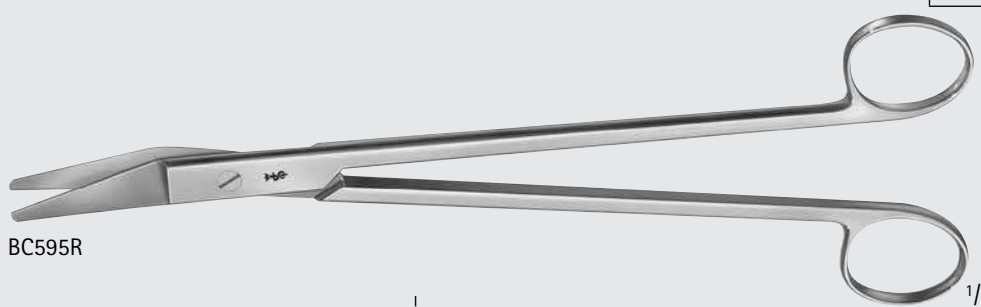

BC595R 1/2

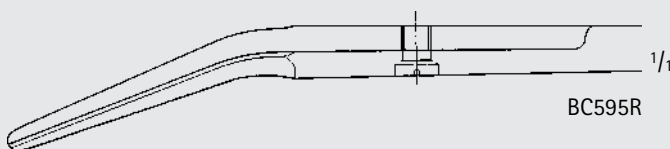

1/1

BC595R

RESANO Cartilage Scissors

Catalog Number	Tip	Blade	Length (in.)
BC595R	B/B	ANG	9 3/4



Orthopedics/Spine

Plaster and Nail Instruments



LX600R

1/3

HENNIG Plaster Spreader

Catalog Number	Length (in.)
LX600R	10 5/8



LX605R

1/3

Plaster Spreader

Catalog Number	Length (in.)
LX605R	9



LX618R-LX624R

1/2

WOLFF Plaster Breaker

Catalog Number	Length (in.)
LX618R	7
LX624R	9 1/2



HF213R

1/2

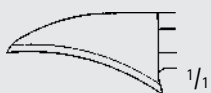

HF213R

1/1

Nail Cutter

Catalog Number	Length (in.)
HF213R	5 1/4





BC521R $\frac{1}{2}$

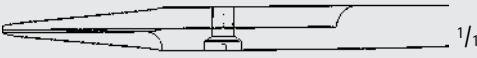

BC521R $\frac{1}{1}$

SYSTRUNK Nail Splitting Scissors

Catalog Number	Tip	Blade	Length (in.)
BC521R	S/S	STR	5 1/8



HF021R $\frac{1}{2}$

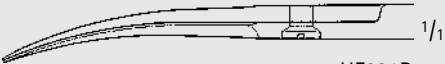

HF021R $\frac{1}{1}$

Nail Scissors

Catalog Number	Tip	Blade	Length (in.)
HF021R	S/S	CVD	4 1/4



MB370R $\frac{1}{2}$

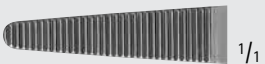

MB370R $\frac{1}{1}$

Needle Nose Pliers/Wire Cutters

Catalog Number	Length (in.)
MB370R	7 1/4



Orthopedics/Spine

Wire Instruments

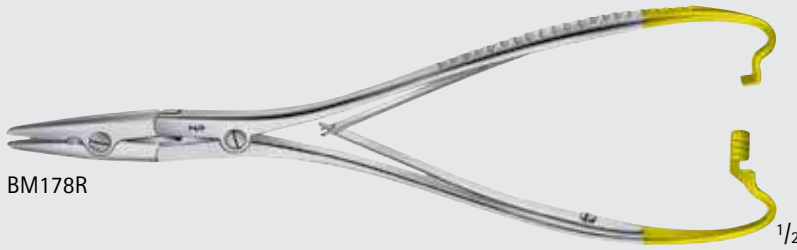

BM178R

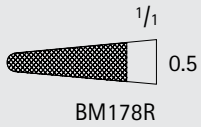

BM178R

DUROGRIP™ TC AESCULAP Needle Holder, Double Action

Catalog Number	Handle	Jaw	Length (in.)
BM178R	RATCHET	SERR	7 7/8



LX150R

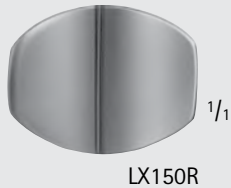

LX150R



LX152R



LX152R

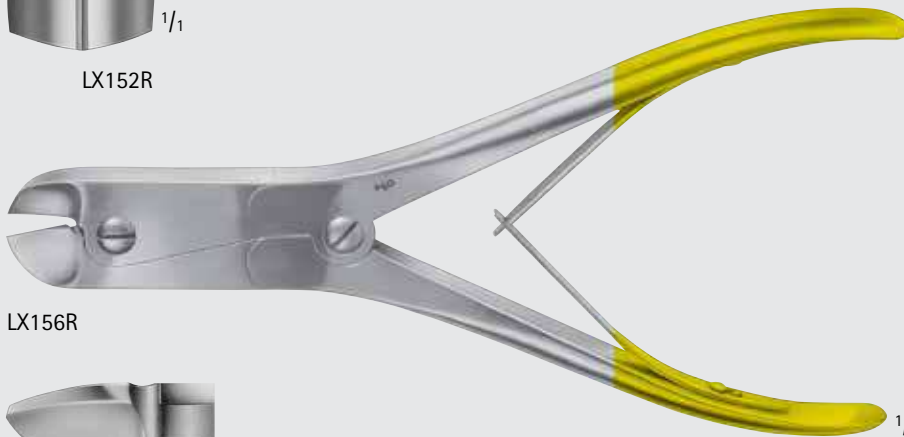

LX156R



LX156R

Wire Cutter, W/ Specially Hardened Cutting Edges

Catalog Number	For Wire Size	Length (in.)
LX150R	SOFT, UP TO 2MM AND HARD, UP TO 1.5MM	5 3/4
LX152R	SOFT, UP TO 3.5MM AND HARD, UP TO 2.0MM	8 3/4
LX156R	SOFT, UP TO 3MM AND HARD, UP TO 2.2MM	9 1/4



ORTHO
SPINE

MILLIMETERS

HARVEY Wire Cutter, W/ Specially Hardened Cutting Edges

Catalog Number	For Wire Size	Tip	Length (in.)
LX157R	SOFT, UP TO 3MM AND HARD, UP TO 2.2MM	ANG	9 1/4

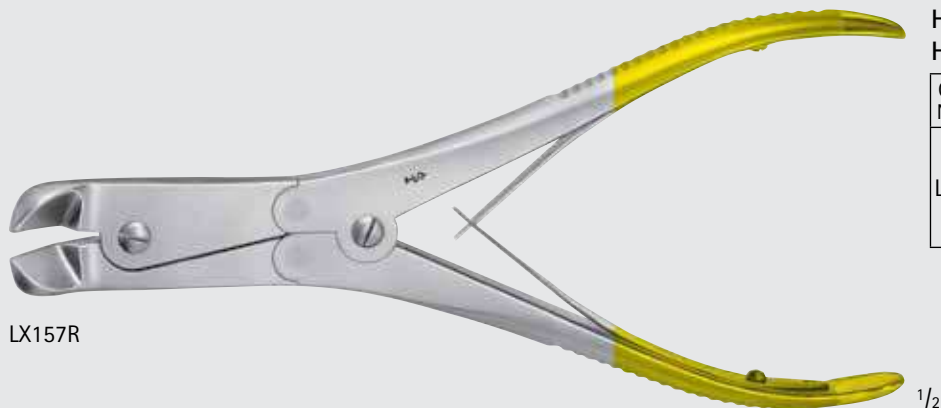

LX157R

1/2

Wire Cutter, Front and Lateral, W/ Specially Hardened Cutting Edges

Catalog Number	Wire Size	Length (in.)
LX158R	SOFT, UP TO 2MM AND HARD, UP TO 1.5MM	7



LX158R

1/2



1/1

LX158R



Orthopedics/Spine

Wire Instruments



LX159R



LX159R

REILL Cutter, F/ Wire Close To Bone, W/ Specially Hardened Cutting Edges

Catalog Number	For Wire Size	Length (in.)
LX159R	SOFT, UP TO 2MM AND HARD, UP TO 1.5MM	6 7/8

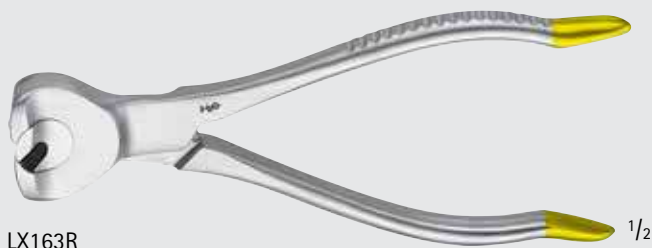

LX163R



LX163R

Front Cutter, W/ Specially Hardened Cutting Edges

Catalog Number	For Wire Size	Length (in.)
LX163R	SOFT, UP TO 3.5MM AND HARD, UP TO 2.5MM	6 1/2



LX162R

TC Wire Cutter W/ Carbide Cutting Edges

Catalog Number	Length (in.)
LX162R	9 1/2



TC Wire Cutter Double Action

Catalog Number	Packaging	Tip	Length (in.)
MG025R	2.5	ANG	8 3/4

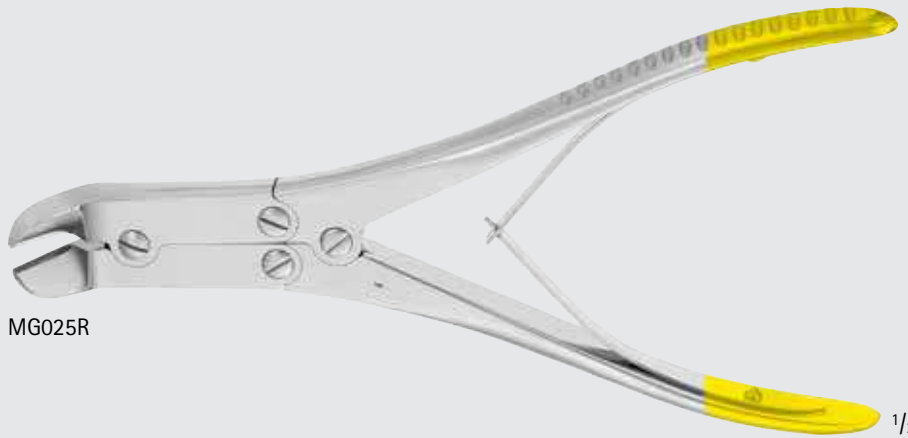

MG025R

1/2



MG025R

1/1

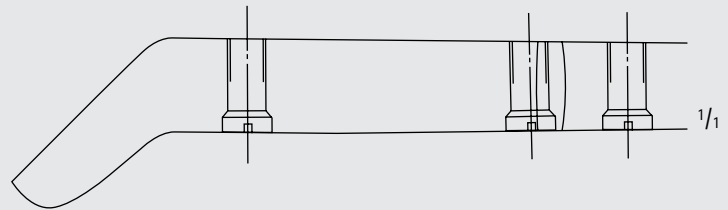

1/1

TC Flush Wire Cutter

Catalog Number	Packaging	Tip	Length (in.)
MG029R	1.6	FRONT AND LATERAL	6 3/4



MG029R

1/2



Orthopedics/Spine

Wire Instruments

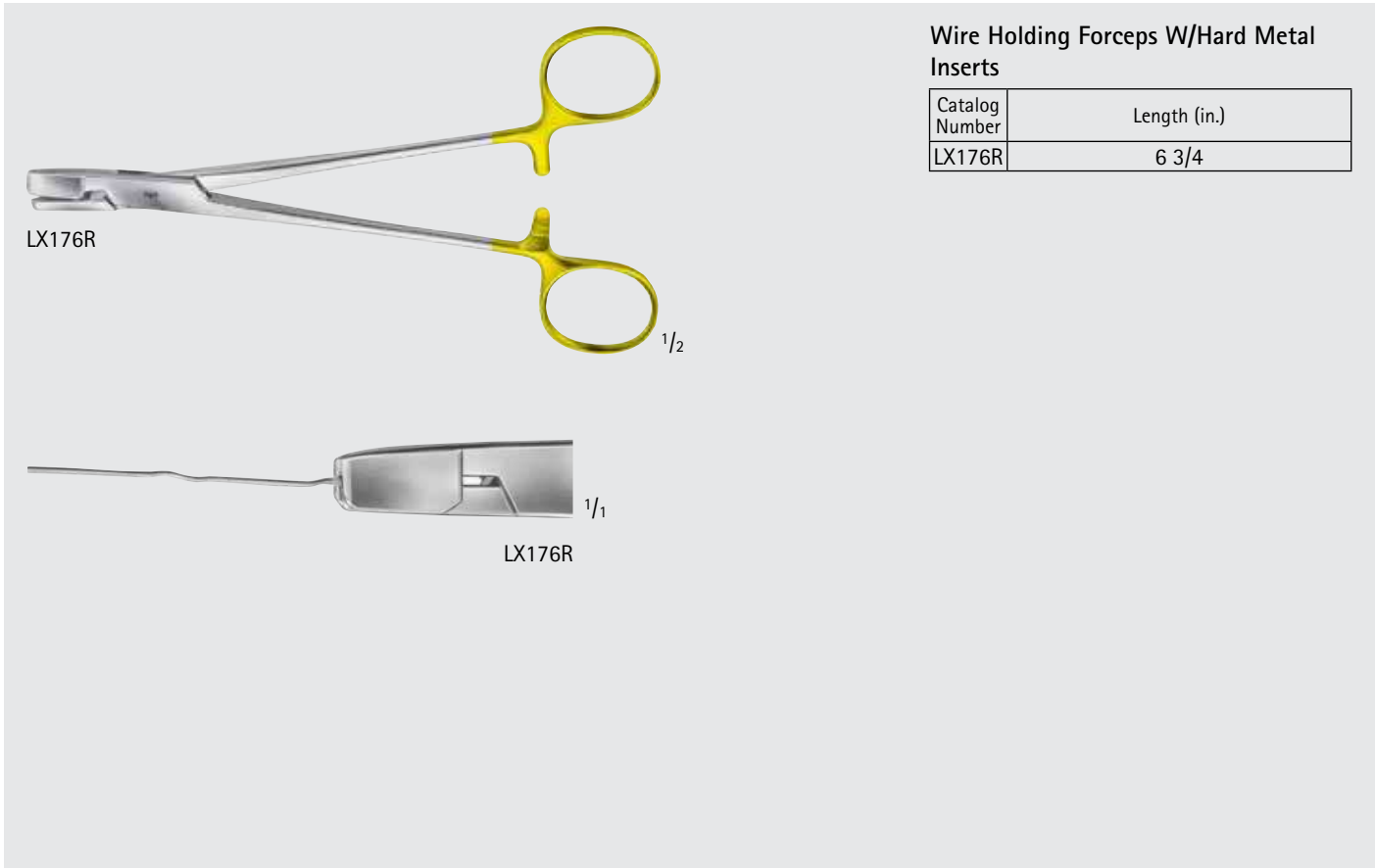

Wire Holding Forceps W/Hard Metal Inserts

Catalog Number	Length (in.)
LX176R	6 3/4

LX176R

1/2

1/1

LX176R

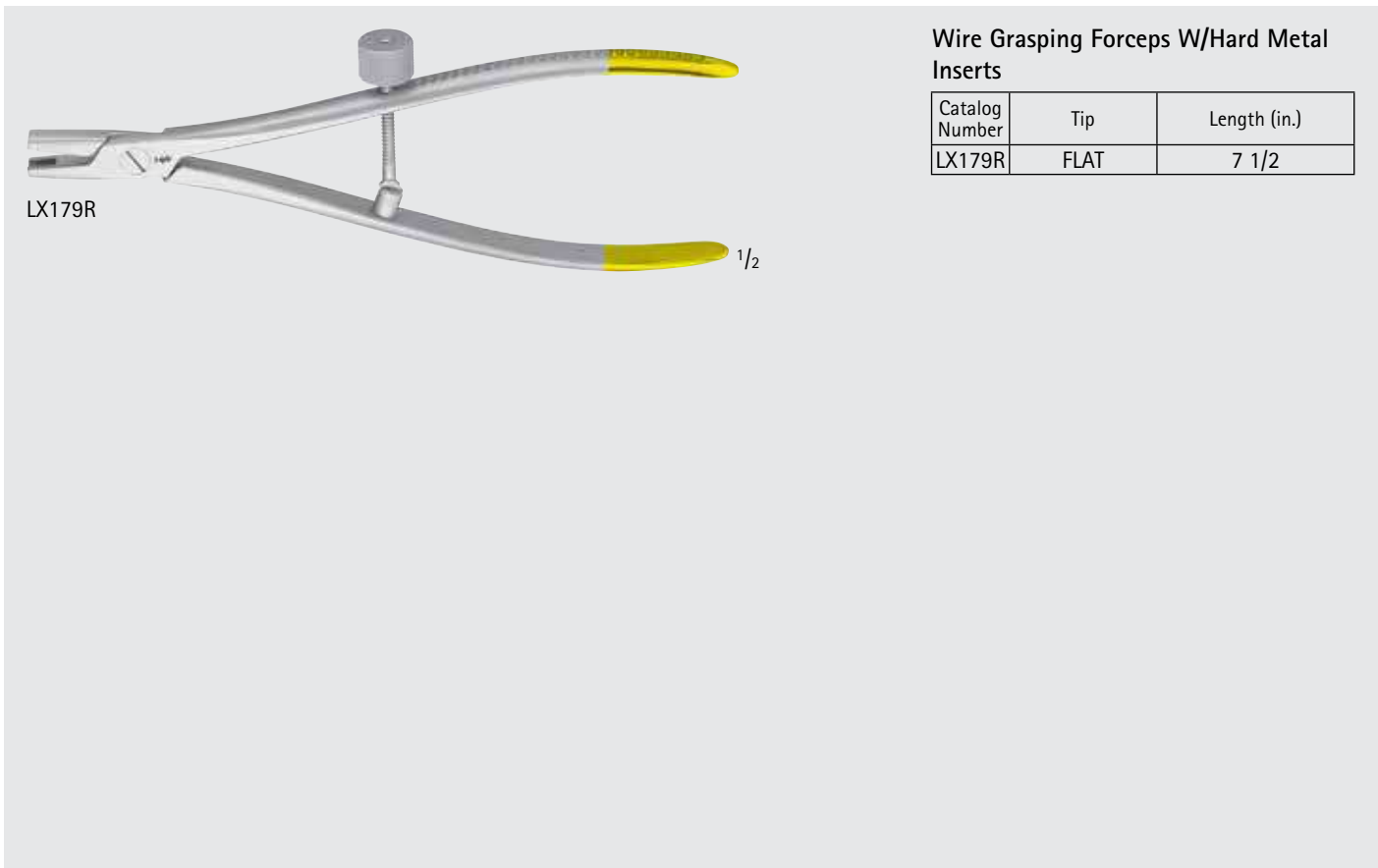

Wire Grasping Forceps W/Hard Metal Inserts

Catalog Number	Tip	Length (in.)
LX179R	FLAT	7 1/2

LX179R

1/2

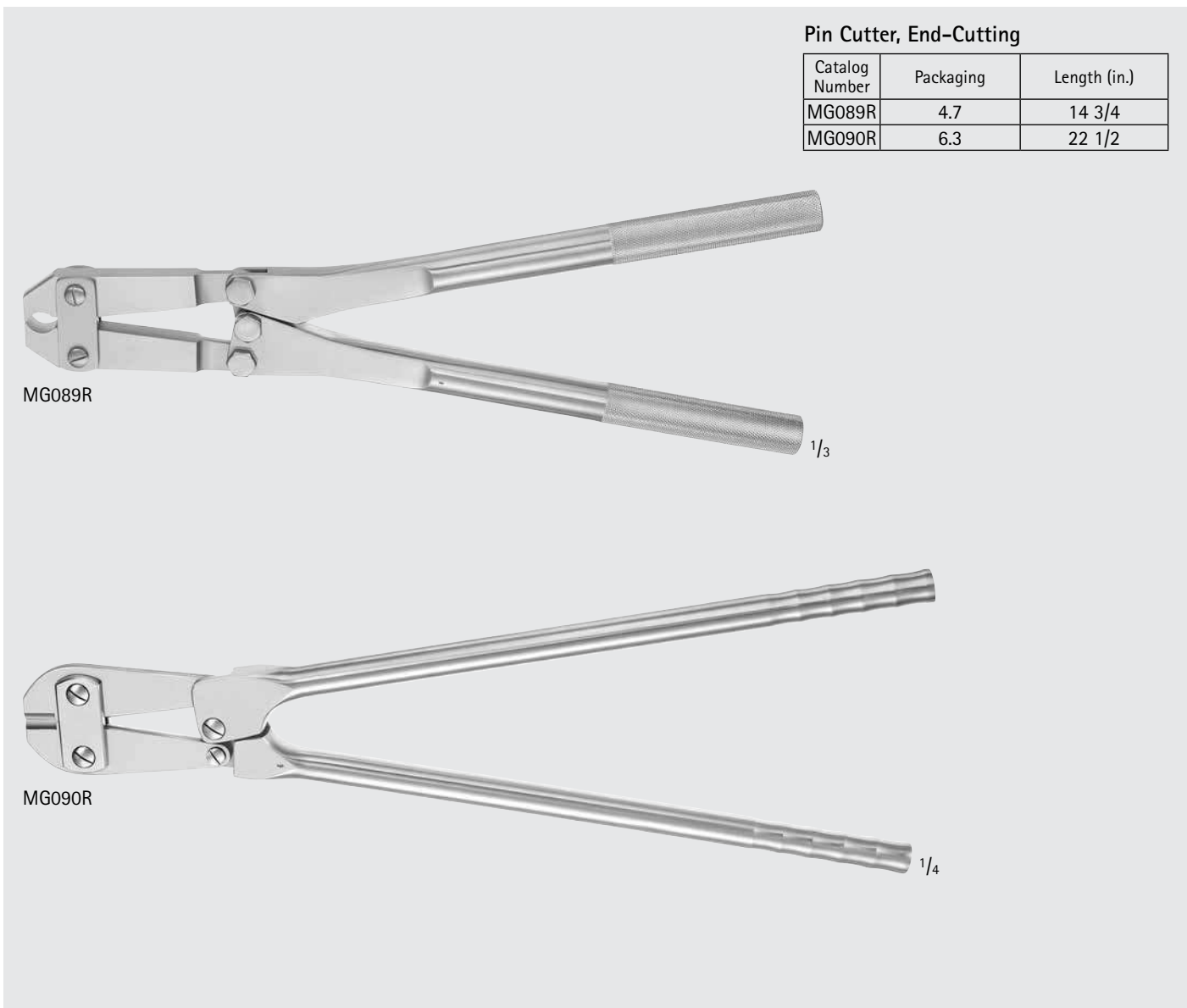
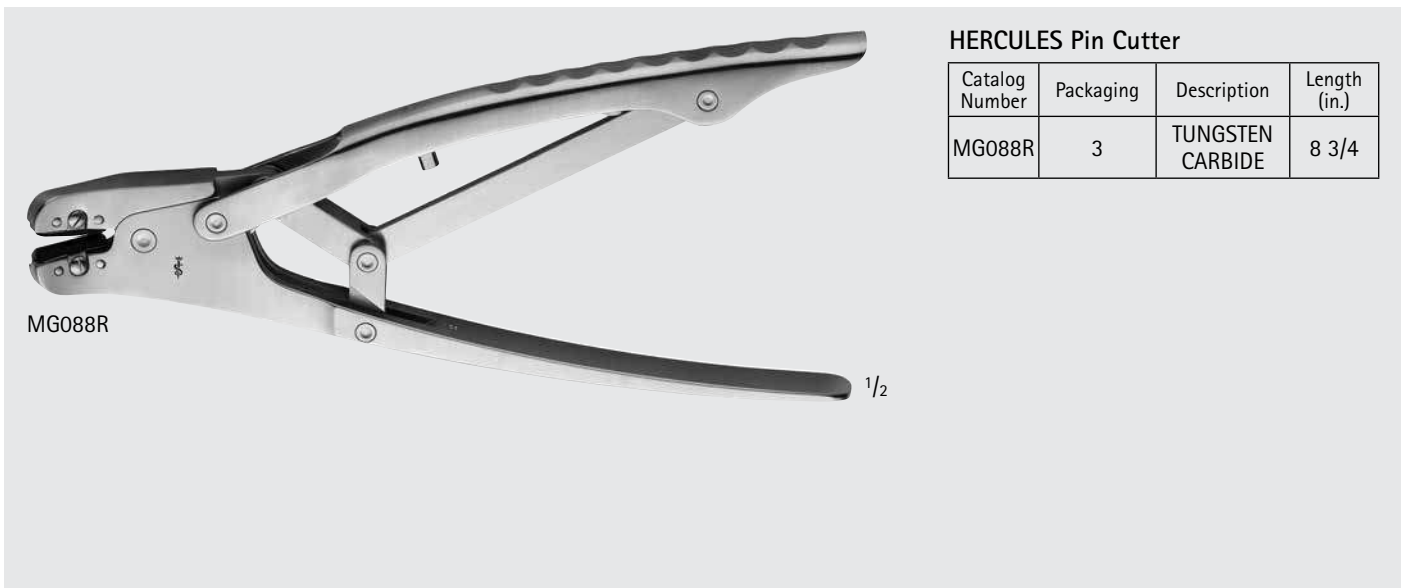



Bolt Cutter

Catalog Number	Item	Length (in.)
LX164R	F/KIRSCHNER WIRES, TIBIA HEAD SCREWS, BOLTS, PINS, UP TO 6MM	18 1/2

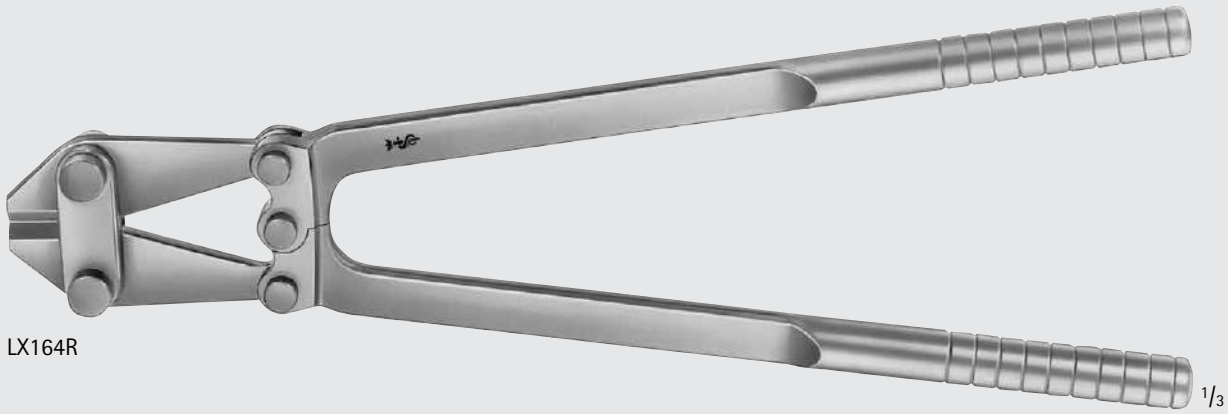

LX164R

1/3

Bolt Cutter

Catalog Number	Item	Length (in.)
LX165R	F/KIRSCHNER WIRES, TIBIA HEAD SCREWS, BOLTS, PINS, UP TO 6MM	12 1/2



LX165R

1/3



LX165R



LX170R-LX171R 1/2



LX170R 1/1



LX171R 1/1

Catalog Number	Tip	Length (in.)
LX170R	SERR	6 3/4
LX171R	CROSS-GROOVES	6 3/4



LX172R 1/2



LX172R 1/1

Catalog Number	Tip	Length (in.)
LX172R	SERR	7 1/2

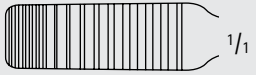

MG026R 1/2

MG026R 1/1

Catalog Number	Tip	Tip Size (mm)	Length (in.)
MG026R	LOCKING	7	7



Orthopedics/Spine

Wire Instruments



MG028R

Wire Holding Needle-Nose Pliers

Catalog Number	Tip	Tip Size (mm)	Length (in.)
MG028R	LOCKING, NEEDLE-NOSE	5	9 1/2



1/16

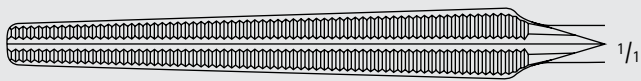

1/16

MG028R



LX174R

Vise Grip Pliers

Catalog Number	Tip	Length (in.)
LX174R	FLAT NOSE	7 7/8



1/16

LX174R



LX175S

Bending Iron

Catalog Number	FOR BORING WIRE SIZE	Length (in.)
LX175S	UP TO 2.7MM	4 3/4



LX177R-LX178R

Wire Extraction Pliers

Catalog Number	Length (in.)
LX177R	5 1/8
LX178R	7

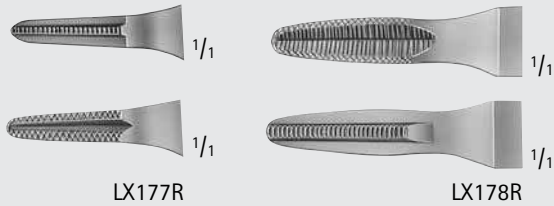

LX177R

LX178R

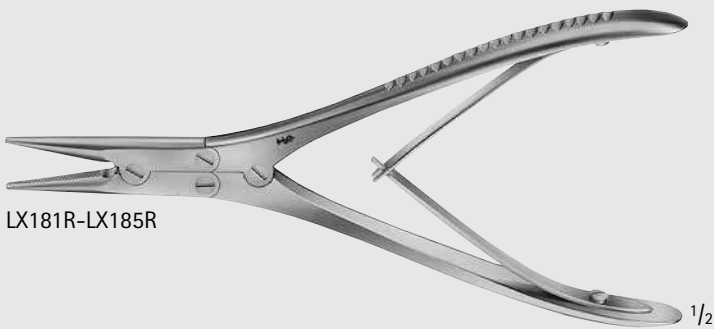

LX181R-LX185R

Wire Extraction Pliers

Catalog Number	Tip	Length (in.)
LX181R	RND	7
LX182R	RND, SHORT JAW	7
LX183R	FLAT	7
LX185R	PARALLEL	5 3/4

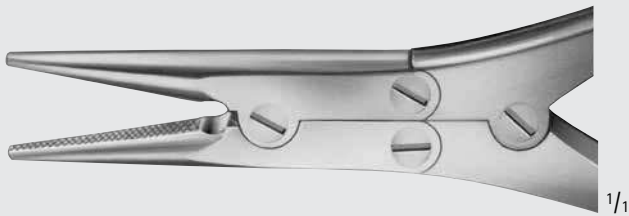

1/1



LX181R



LX182R

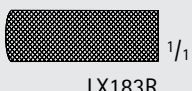

LX183R



LX185R



ORTHO
SPINE

INCHES

Orthopedics/Spine

Wire Instruments

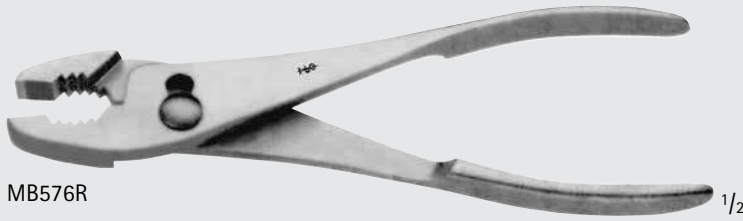

MB576R

Utility Pliers

Catalog Number	Length (in.)
MB576R	7 3/4



LX189R

Flat Nosed Pliers

Catalog Number	Tip	Length (in.)
LX189R	PARALLEL	7 1/4



LX189R

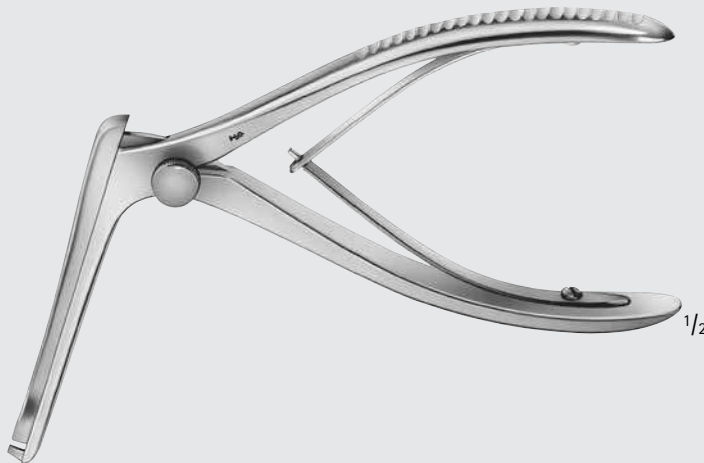

LX190R

Wire Bending Pliers

Catalog Number	For Wire Size
LX190R	UP TO 1.8MM

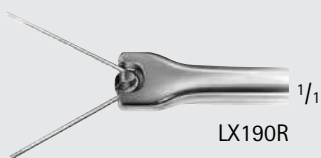

LX190R



SMILLIE Meniscotome

Catalog Number	Jaw	Length (in.)
F0857R	STRAIGHT	6 3/4
F0855R	LEFT	6 3/4
F0856R	RIGHT	6 3/4

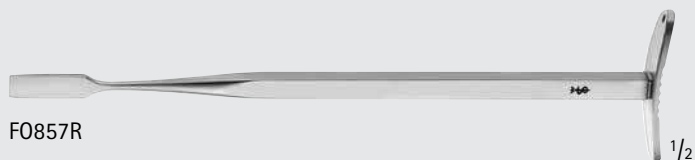

F0857R



1/1

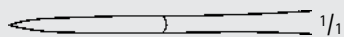

1/1

F0857R



F0855R



1/1



1/1

F0855R



F0856R



1/1

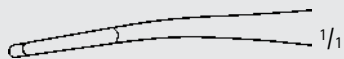

1/1

F0856R



Orthopedics/Spine

Forceps

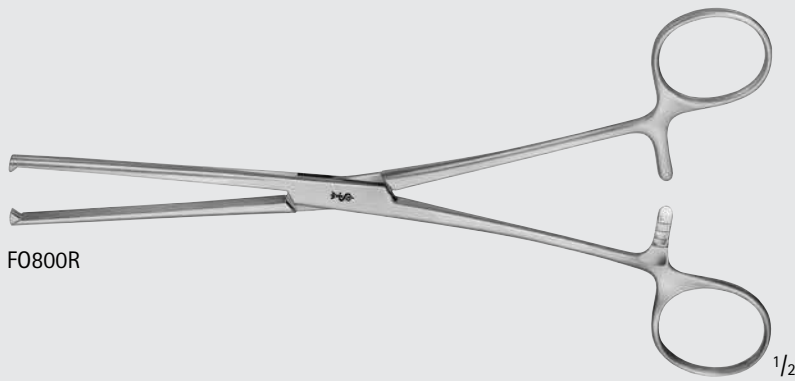

FO800R



FO800R

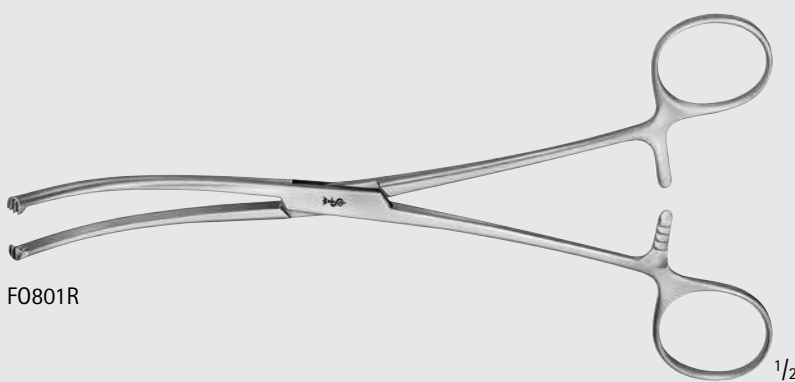

FO801R

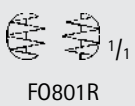

FO801R

BIRCHER Cartilage Forceps

Catalog Number	Jaw	Length (in.)
FO800R	STR	7 7/8
FO801R	CVD	7 7/8

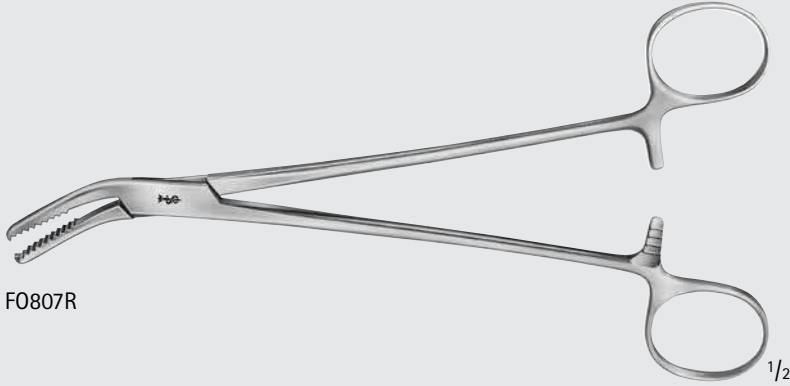

FO807R $\frac{1}{2}$



FO807R $\frac{1}{1}$

WELLER Cartilage Forceps

Catalog Number	Jaw	Length (in.)
FO807R	CVD	7 7/8

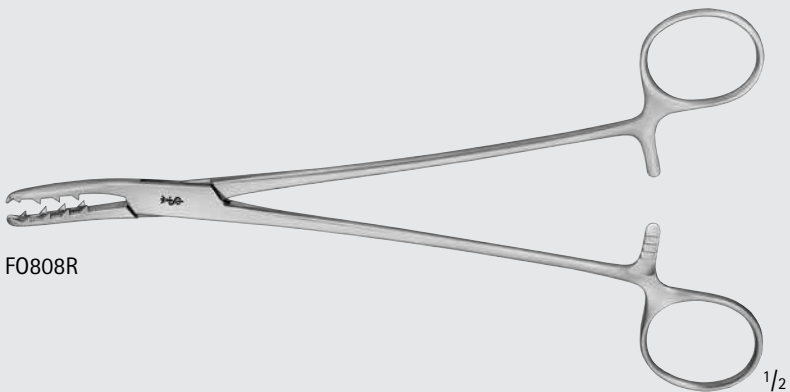

FO808R $\frac{1}{2}$



FO808R $\frac{1}{1}$

BIRCHER-GANSKE Cartilage Forceps

Catalog Number	Jaw	Length (in.)
FO808R	SLIGHT CVD	7 7/8



Orthopedics/Spine

Forceps

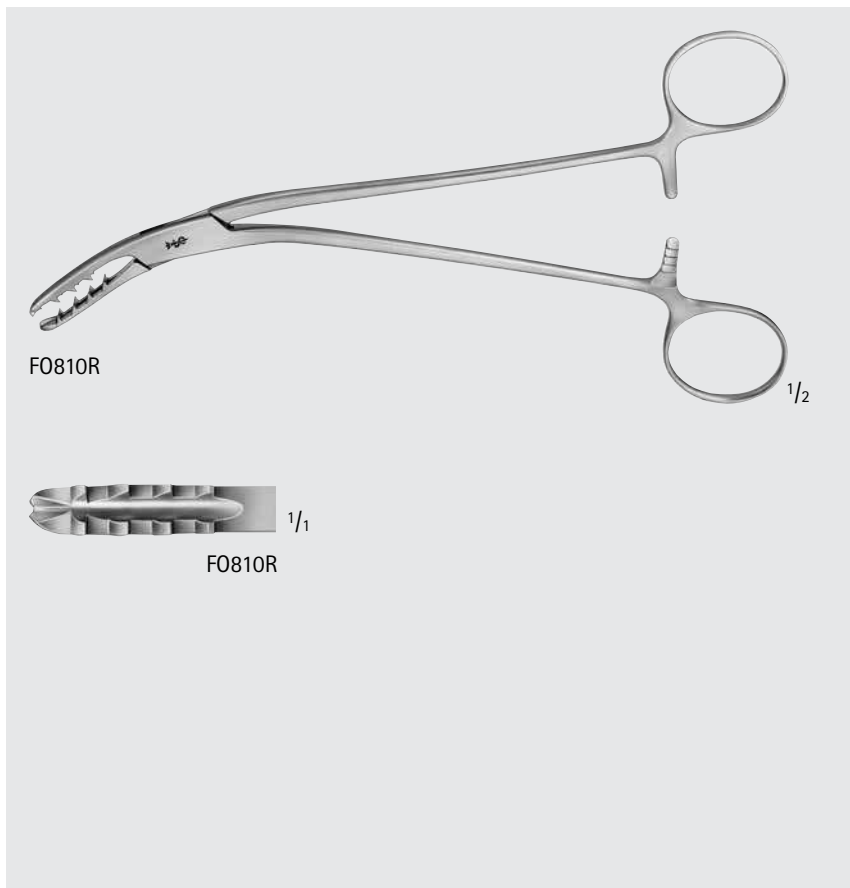



BIRCHER-GANSKE Cartilage Forceps (continued)

Catalog Number	Jaw	Length (in.)
F0810R	CVD	7 7/8

F0810R $\frac{1}{2}$

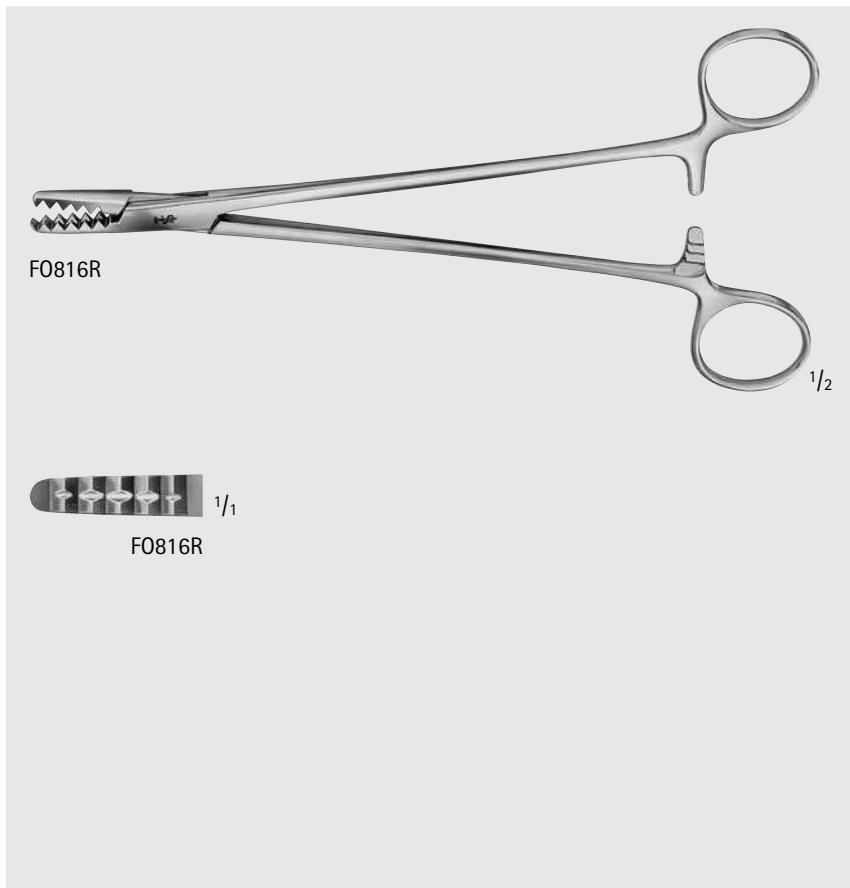
F0810R $\frac{1}{1}$



MARTIN Cartilage Forceps

Catalog Number	Jaw	Length (in.)
F0816R	STR	8

F0816R $\frac{1}{2}$

F0816R $\frac{1}{1}$

MEYER Reposition Forceps, F/ Wires

Catalog Number	For Wire Size	Length (in.)
FO106R	UP TO 1MM	6 3/4
FO108R	UP TO 2MM	8

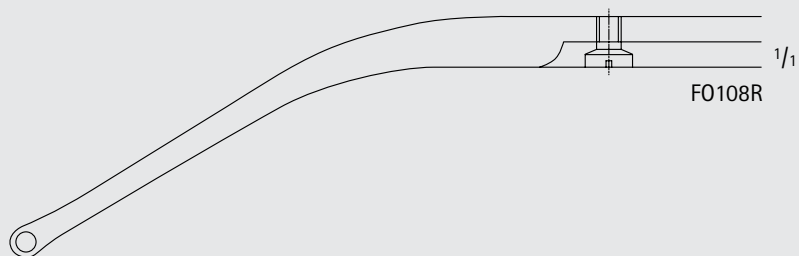
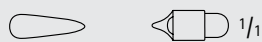
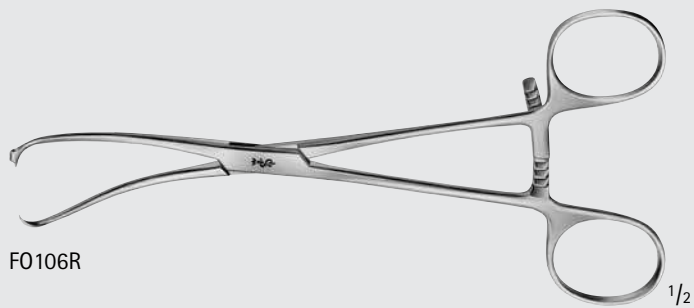

Orthopedics/Spine

Bone Holding Forceps

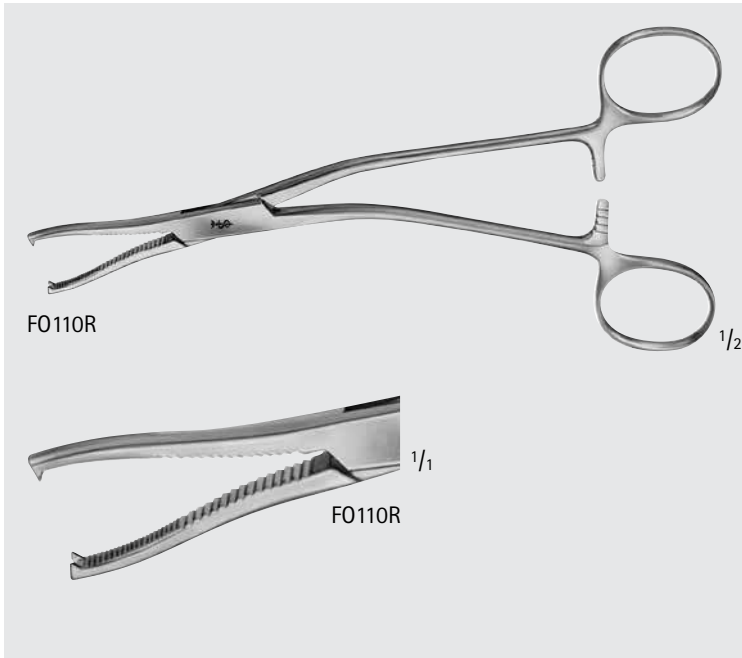

DINGMANN Bone Holding Forceps

Catalog Number	Teeth	Length (in.)
FO110R	2 x 2	7 1/4

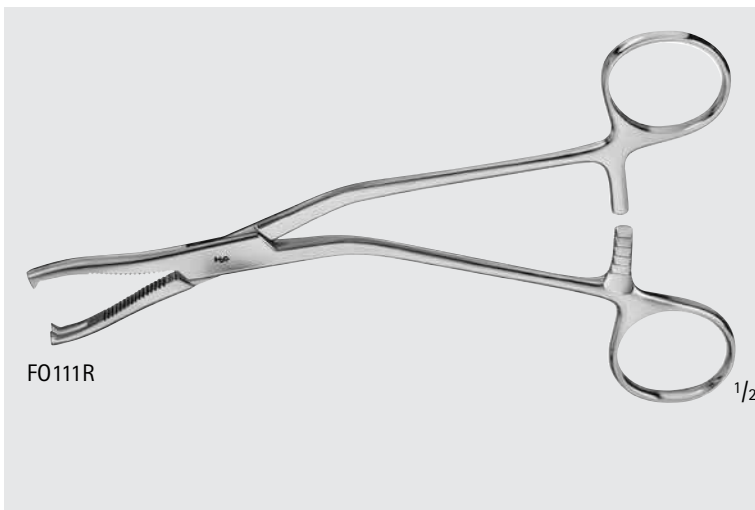

DINGMANN Bone Holding Forceps

Catalog Number	Teeth	Shaft	Length (in.)
FO111R	2 x 2	CVD	7 1/4

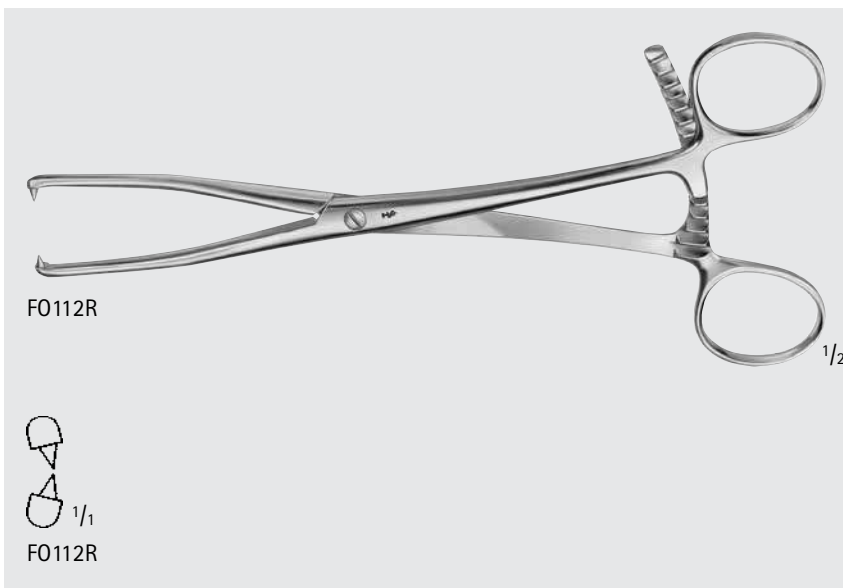

Bone Holding Forceps

Catalog Number	Length (in.)
FO112R	8 1/4



FO113R

$\frac{1}{2}$



$\frac{1}{1}$

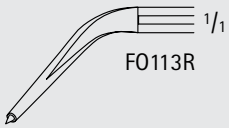

FO113R

$\frac{1}{1}$

Finger Reposition Forceps, Stepped Tips

Catalog Number	Length (in.)
FO113R	3 $\frac{3}{4}$

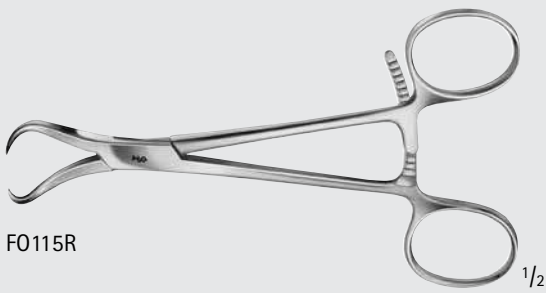

FO115R

$\frac{1}{2}$

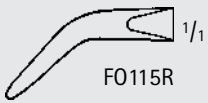

FO115R $\frac{1}{1}$

Finger Reposition Forceps, F/ Small Fragments

Catalog Number	Length (in.)
FO115R	5 $\frac{1}{4}$



FO116R

$\frac{1}{2}$

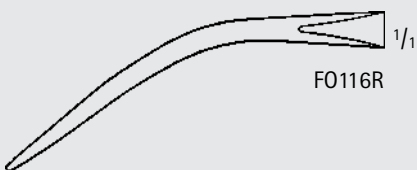

FO116R

$\frac{1}{1}$

REILL Reposition Forceps

Catalog Number	Length (in.)
FO116R	6 $\frac{3}{4}$



ORTHO
SPINE

INCHES

Orthopedics/Spine

Bone Holding Forceps

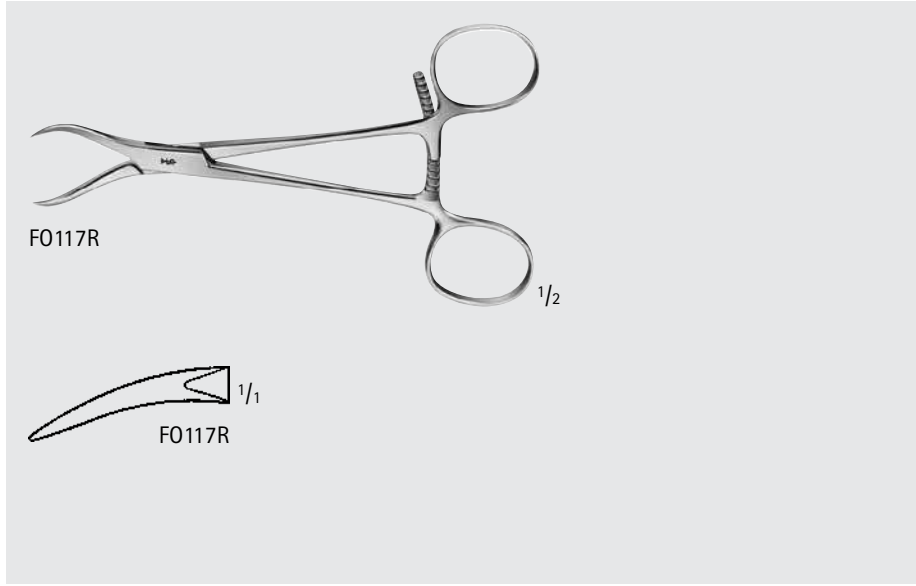

Forceps for Maxillary Reposition

Catalog Number	Length (in.)
FO117R	5 1/4

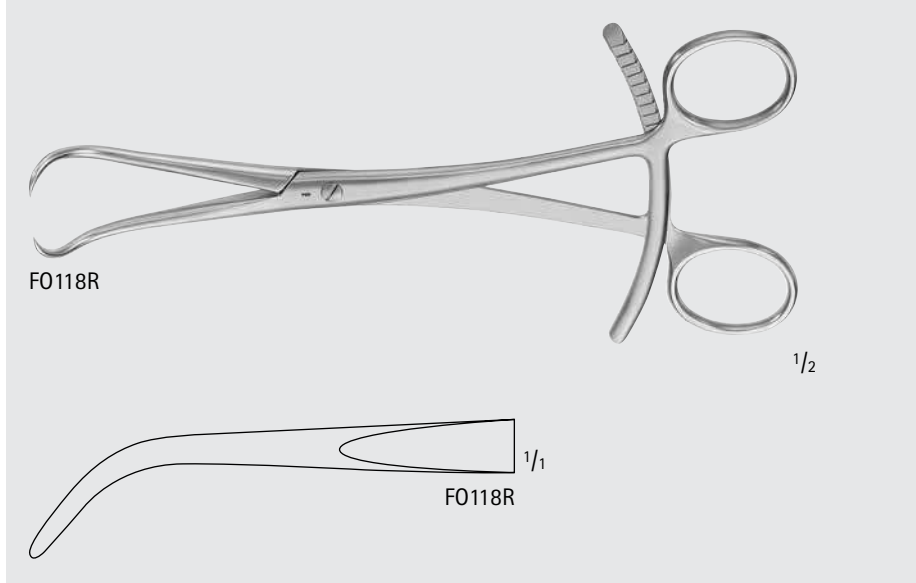

Bone Reposition Forceps, Double Ratchet

Catalog Number	Length (in.)
FO118R	8

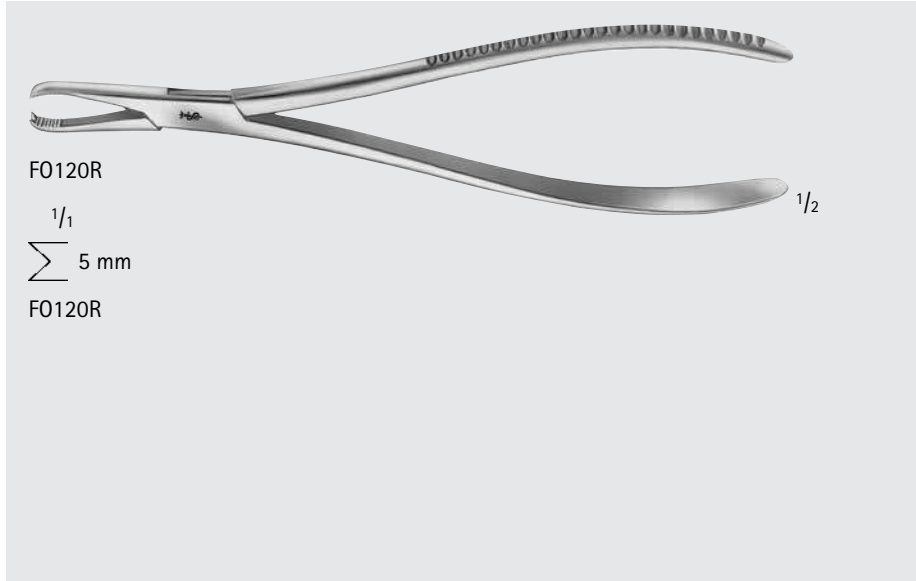

Bone Holding Forceps

Catalog Number	Length (in.)
FO120R	7 7/8

Bone Reduction Forceps

Catalog Number	Length (in.)
F0123R	5 1/2



Bone Reduction Forceps, W/ Screw Lock and Thread Fixation

Catalog Number	Length (in.)
F0124R	6 3/4
F0125R	9 1/4

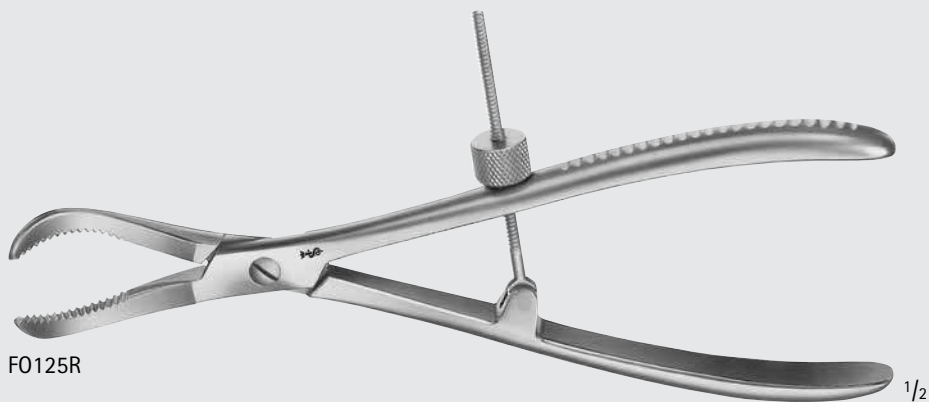
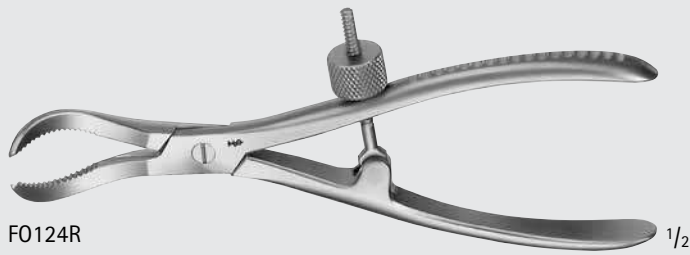

Orthopedics/Spine

Bone Holding Forceps

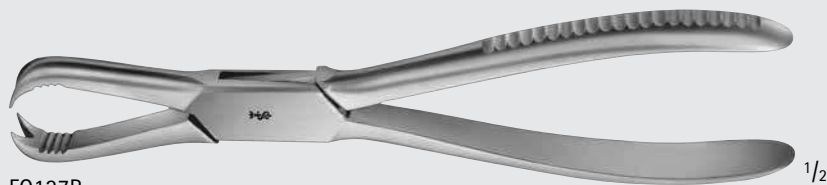

FO127R

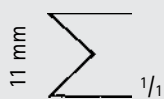

FO127R

LANGENBECK Bone Holding Forceps

Catalog Number	Tip Size (mm)	Length (in.)
FO127R	11	8



FO130R



FO130R

FERGUSSON Bone Holding Forceps

Catalog Number	Tip Size (mm)	Length (in.)
FO130R	12	8

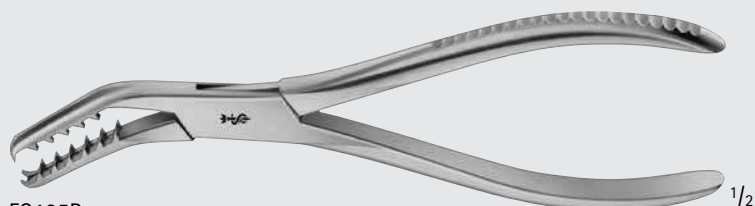

FO135R



FO135R



FO136R



FO136R

SEMB Rib/Bone Holding Forceps

Catalog Number	Tip Size (mm)	Item	Length (in.)
FO135R	8	W/O RATCHET	7 1/2
FO136R	8	W/ RATCHET	7 1/2



FARABEU F Bone Holding Forceps

Catalog Number	Tip Size (mm)	Length (in.)
FO140R	9	9
FO141R	11	10



FO140R

1/2

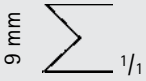
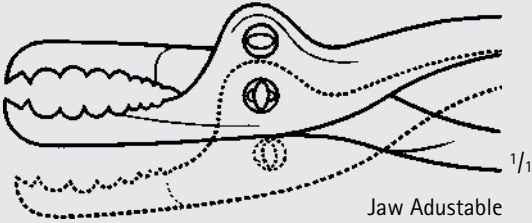

FO140R



FO141R

1/2

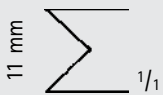

FO141R

FARABEU-F-LAMBOTTE Forceps, W/ Ratchet

Catalog Number	Tip Size (mm)	Length (in.)
FO143R	11	10



FO143R

1/2

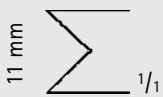

FO143R



ORTHO
SPINE

INCHES

Orthopedics/Spine

Bone Holding Forceps



KERN Mini Bone Holding Forceps, W/ Ratchet

Catalog Number	Tip Size (mm)	Length (in.)
FO148R	7.5	6 1/8

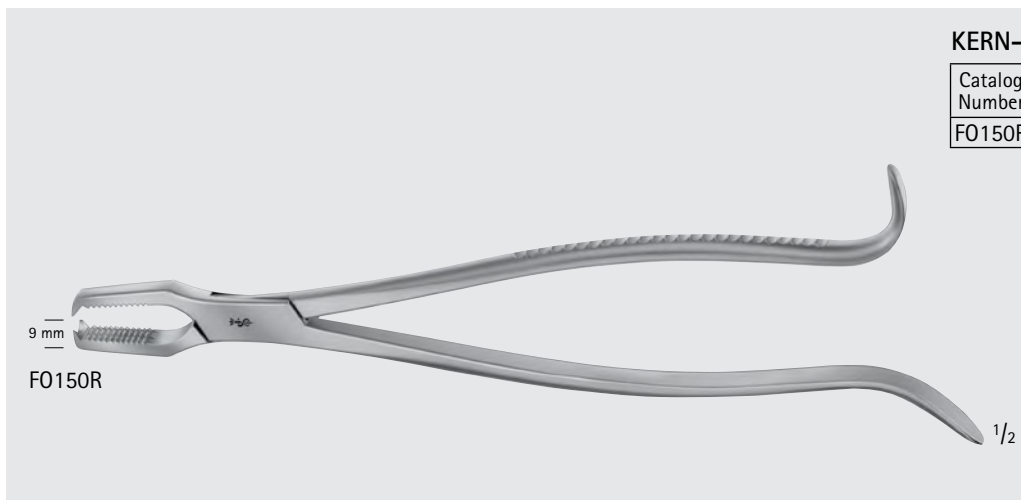

KERN-LANE Bone Holding Forceps

Catalog Number	Tip Size (mm)	Length (in.)
FO150R	9	9 1/2

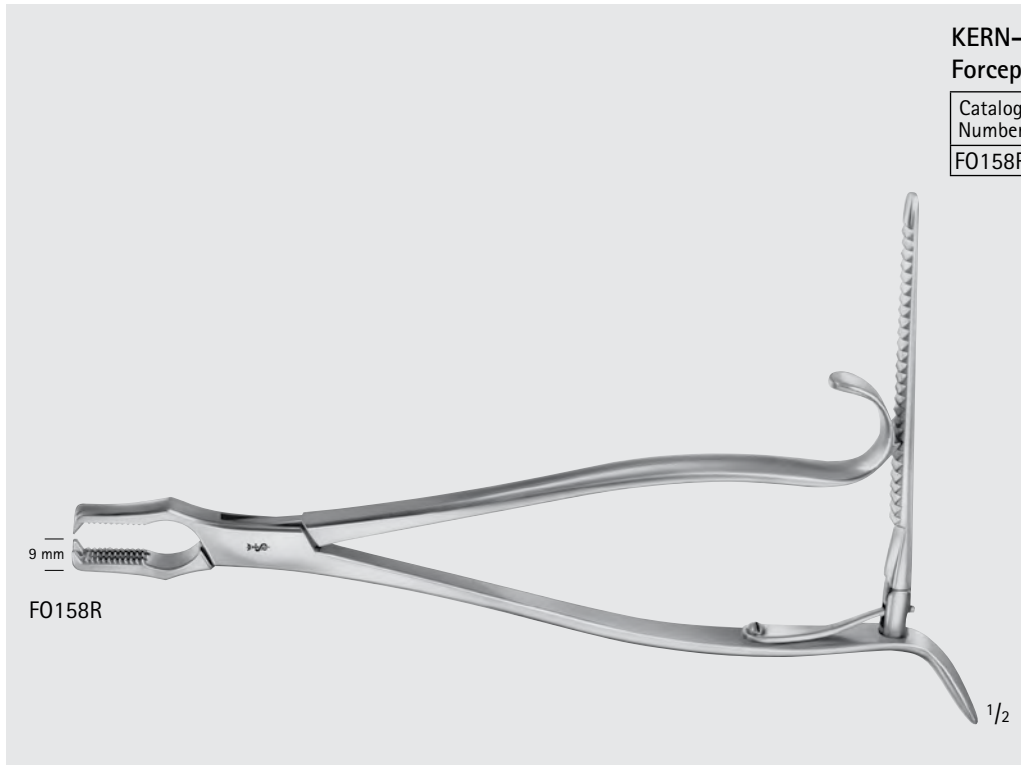

KERN-LANE Bone Holding Forceps, W/ Ratchet

Catalog Number	Tip Size (mm)	Length (in.)
FO158R	9	9 1/2

LANE Bone Holding Forceps

Catalog Number	Tip Size (mm)	Description	Length (in.)
F0151R	9	W/O RATCHET	13
F0159R	13	W/ RATCHET	12 1/2

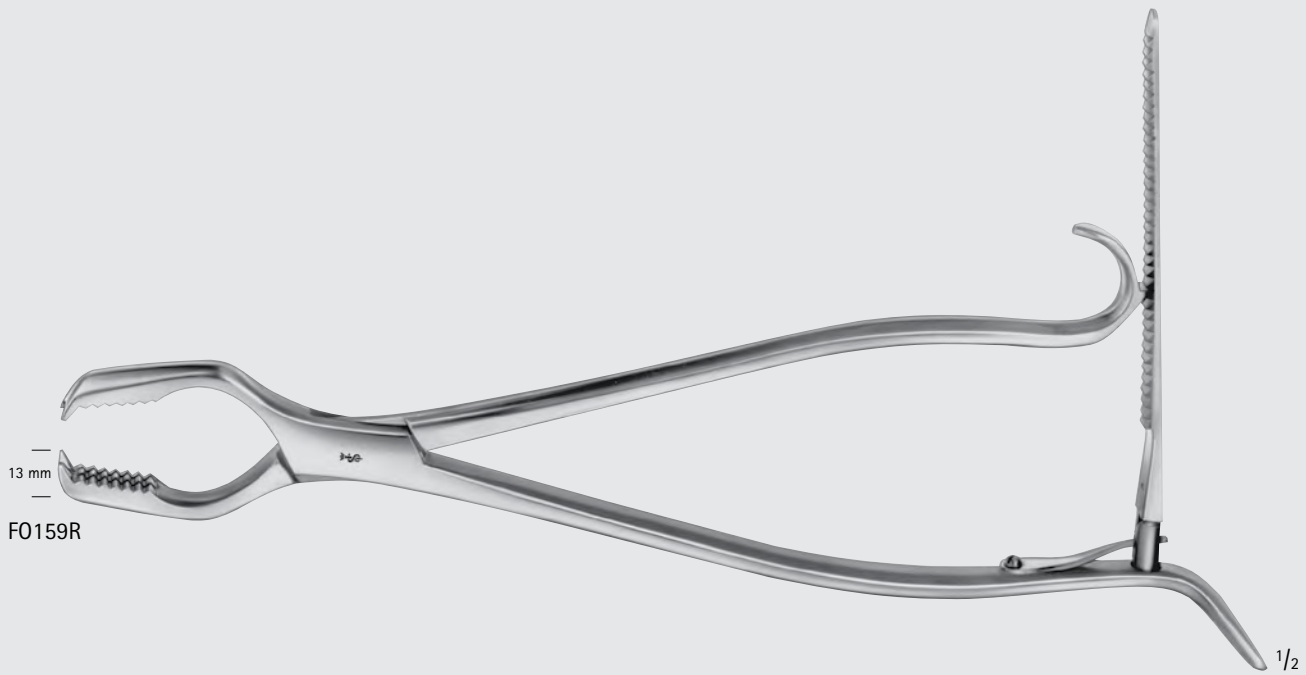
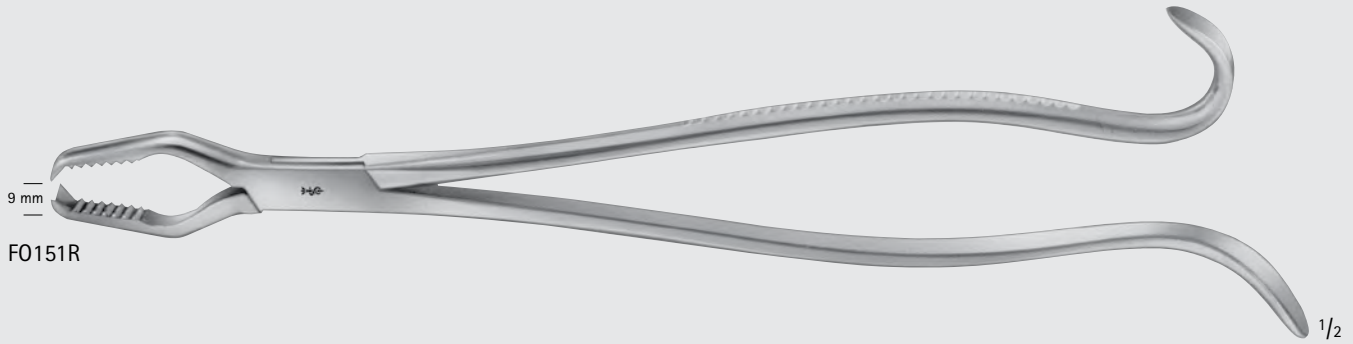

Orthopedics/Spine

Bone Holding Forceps

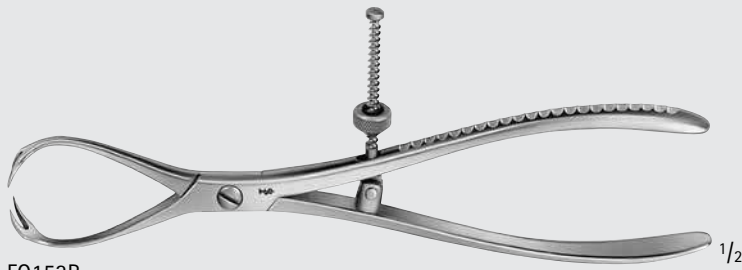

FO153R

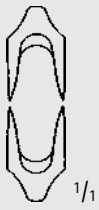

FO153R

Patella Forceps W/ Screw Lock

Catalog Number	Length (in.)
FO153R	7 1/4

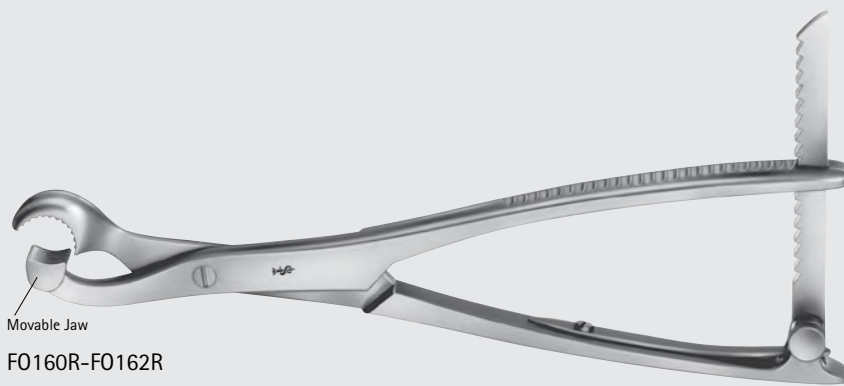

FO160R-FO162R



FO160R

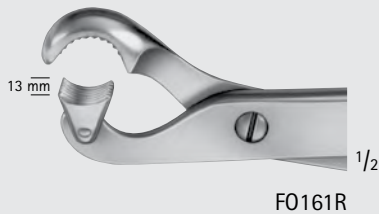

FO161R



FO162R

LAMBOTTE Bone Holding Forceps, W/ Movable Jaw and Ratchet

Catalog Number	Tip Size (mm)	Length (in.)
FO160R	10	8 3/4
FO161R	13	10 1/4
FO162R	16	13



F0169R-F0173R

Self-Centering Forceps, W/ Screw Lock and Thread Fixation

Catalog Number	Tip Size (mm)	Length (in.)
F0169R	3/3	5 3/4
F0170R	7 / 2.5	7 1/2
F0171R	10.5 / 3.5	9 1/2
F0172R	11 / 3.5	10 1/4
F0173R	11.5 / 4.5	10 3/4

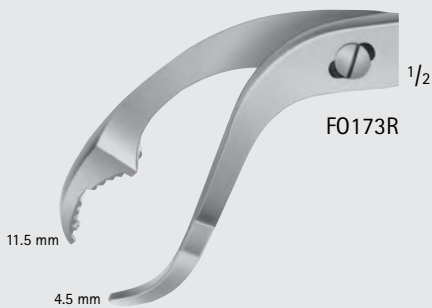
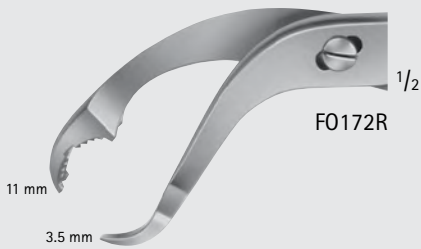
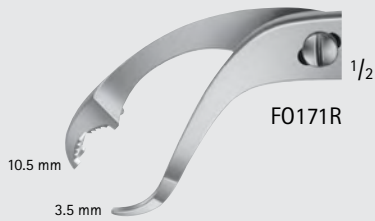

ORTHO
SPINE

INCHES

Orthopedics/Spine

Bone Holding Forceps

VERBRUGGE Bone Forceps

Catalog Number	Tip Size (mm)	Length (in.)
FO180R	5	6 7/8
FO181R	10 / 4.0	9 3/4
FO182R	11 / 4.5	10 1/2
FO183R	12 / 4.5	10 5/8

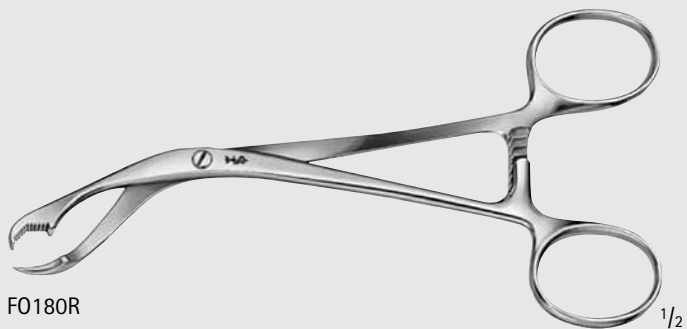

FO180R



FO180R



FO181R-FO183R



FO181R

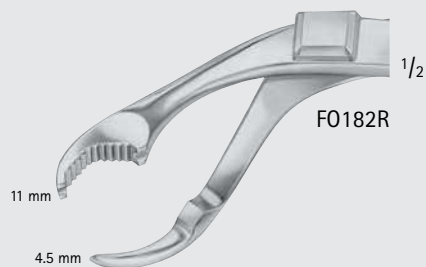

FO182R



FO183R





FO190R-FO191R

LOWMAN Bone Clamp

Catalog Number	Length (in.)
FO190R	6 7/8
FO191R	8



FO192R

LOWMAN-GERSTER Bone Clamp

Catalog Number	Length (in.)
FO192R	8 1/4



FO193R

LOWMAN-HOGLUND Bone Clamp

Catalog Number	Length (in.)
FO193R	6 7/8



ORTHO
SPINE

Orthopedics/Spine

Bone Holding Forceps

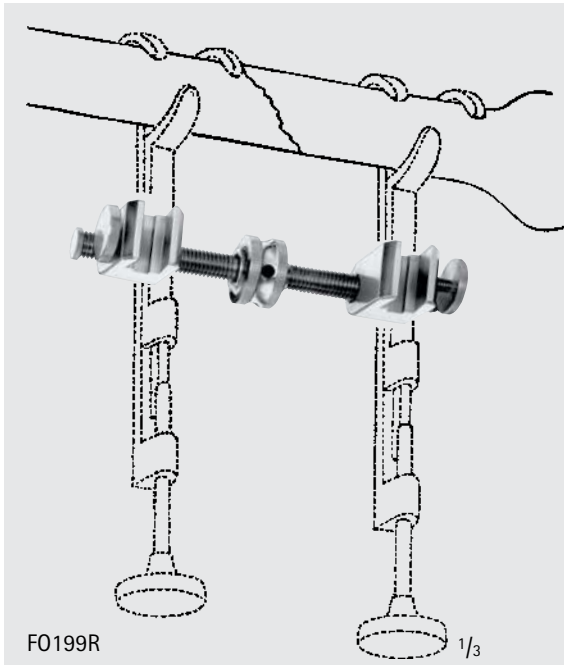

**GERSTER Traction Bar
F/FO190R-FO193R**

Catalog Number
FO199R

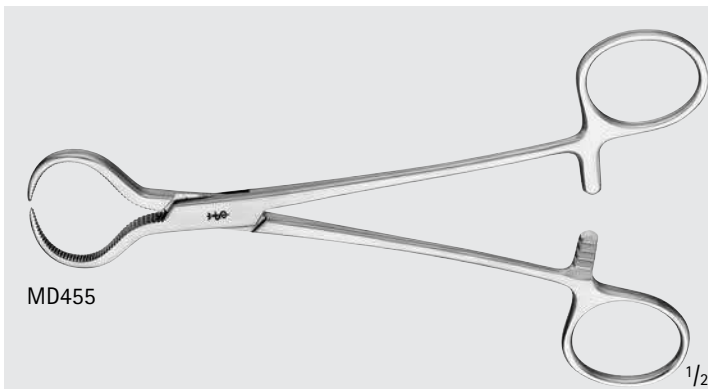

LEWIN Bone Clamp

Catalog Number	Tip	Length (in.)
MD455	SERR	7

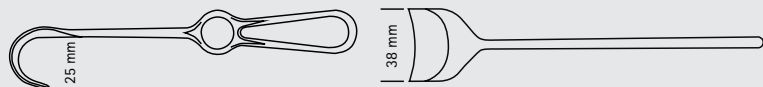

Dimensions for blade size of retractors
 1st number = depth Example: 25 x 38 mm
 2nd number = width



Knee Retractor

Catalog Number	Blade Size (mm)	Length (in.)
BT419R	39 x 9	8 7/8

BT419R

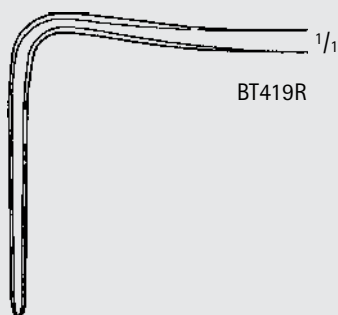

BT419R

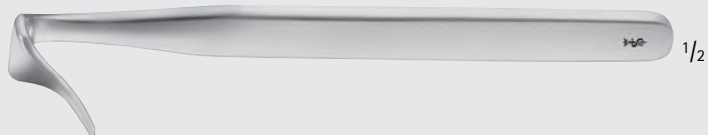

BLOUNT Knee Retractor

Catalog Number	Blade Size (mm)	Length (in.)
BT420R	40 x 4	6 7/8

BT420R

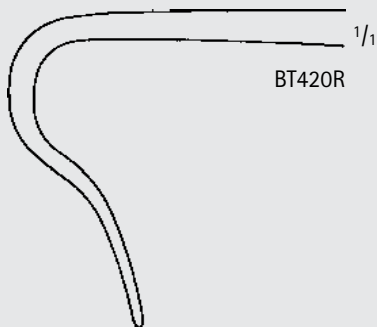

BT420R



ORTHO
SPINE

INCHES

Orthopedics/Spine

Retractors

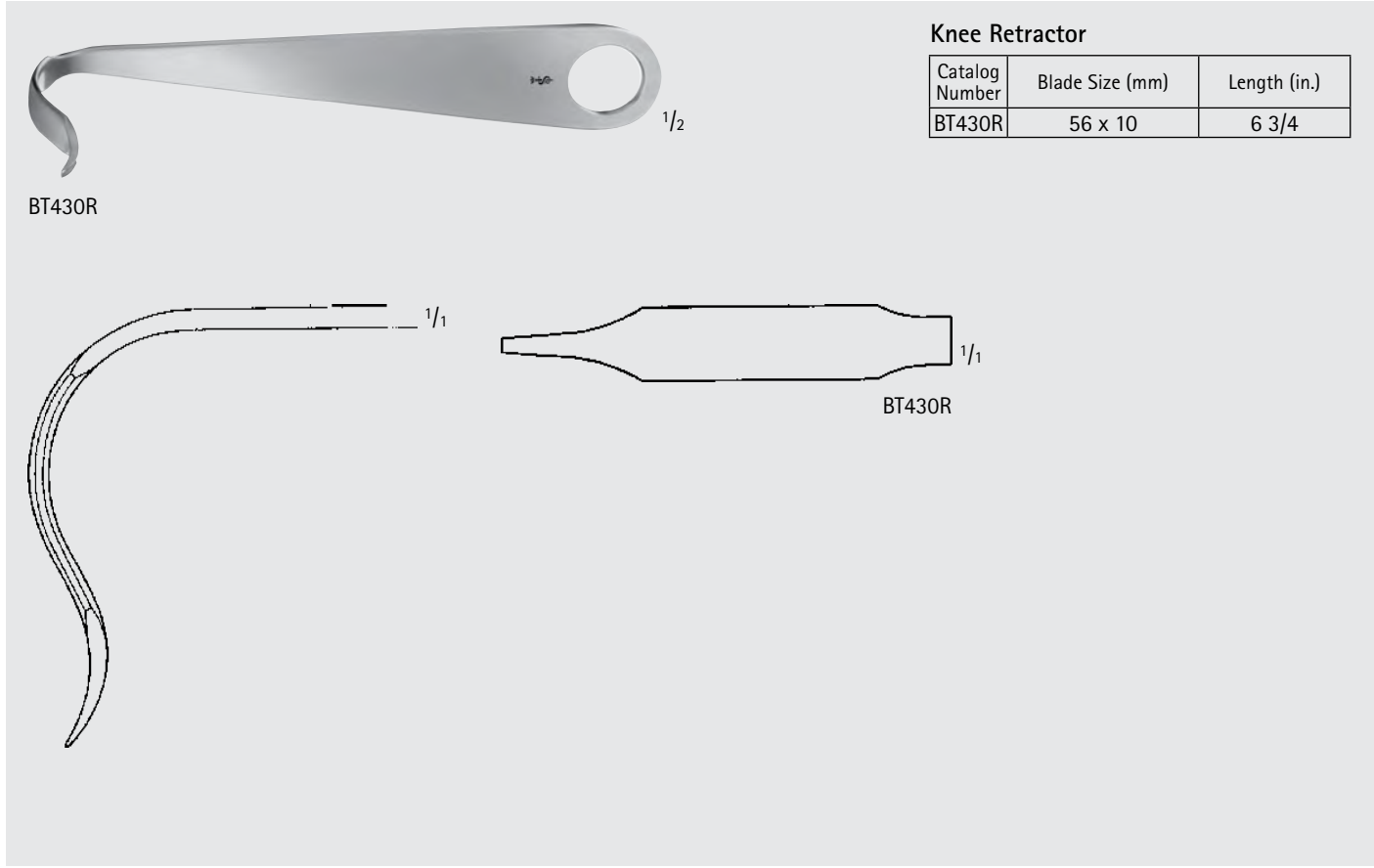

Knee Retractor

Catalog Number	Blade Size (mm)	Length (in.)
BT430R	56 x 10	6 3/4

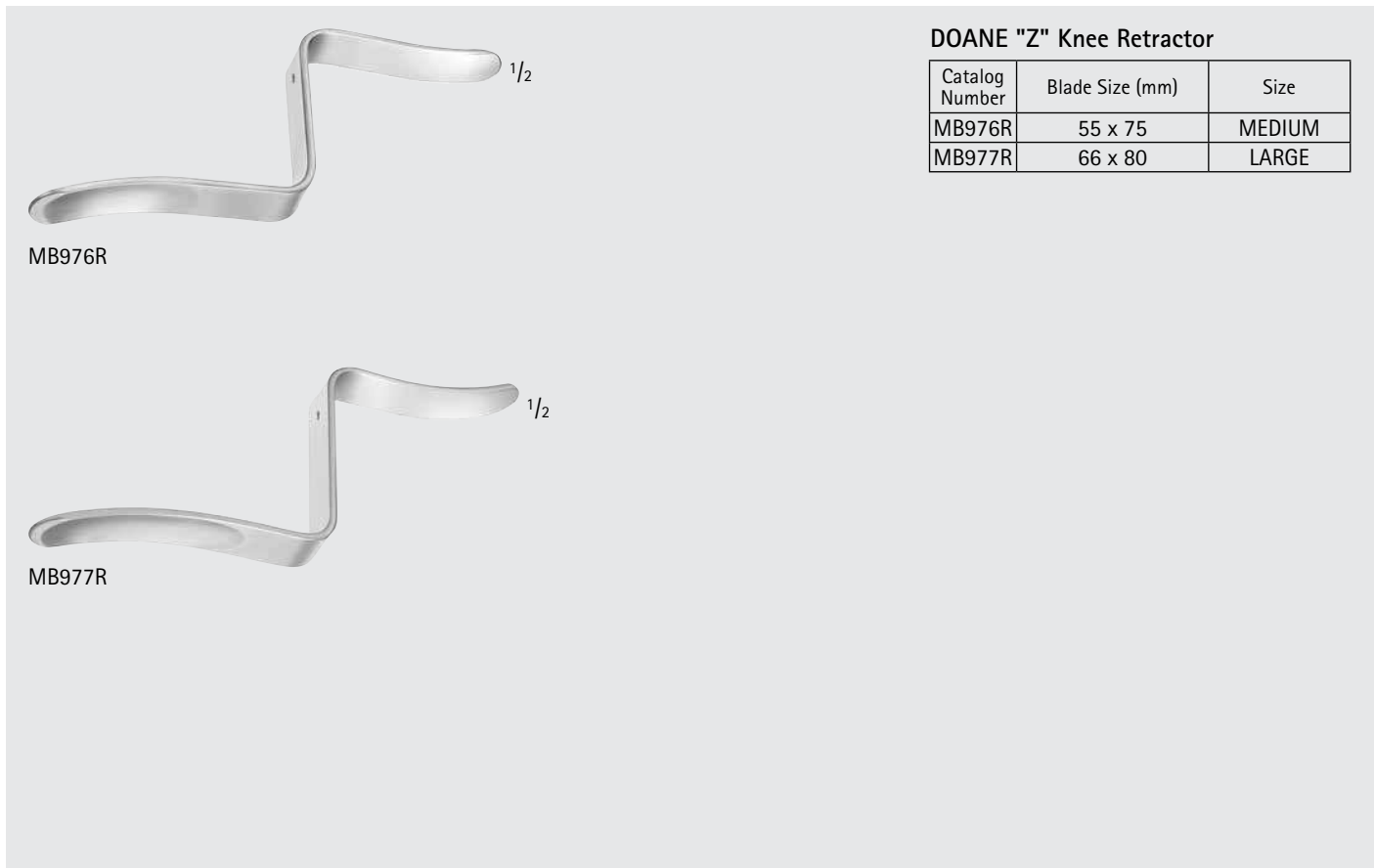

DOANE "Z" Knee Retractor

Catalog Number	Blade Size (mm)	Size
MB976R	55 x 75	MEDIUM
MB977R	66 x 80	LARGE

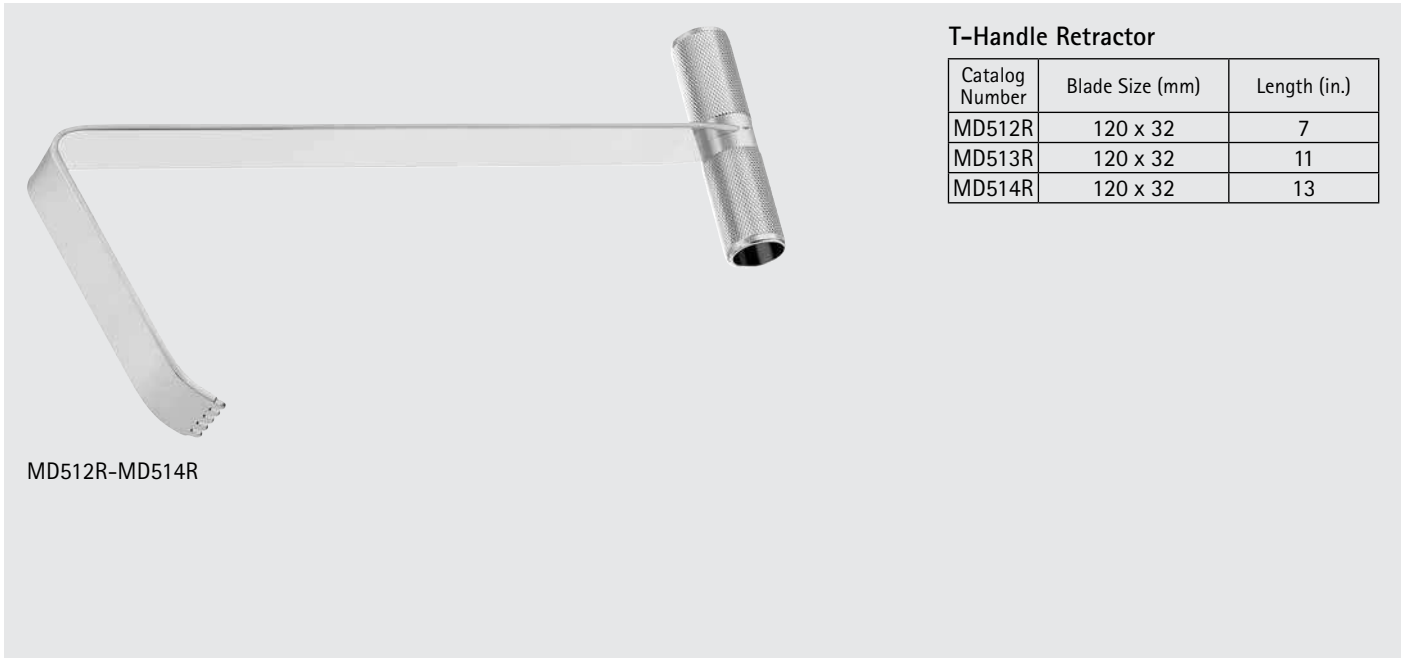

T-Handle Retractor

Catalog Number	Blade Size (mm)	Length (in.)
MD512R	120 x 32	7
MD513R	120 x 32	11
MD514R	120 x 32	13

MD512R-MD514R

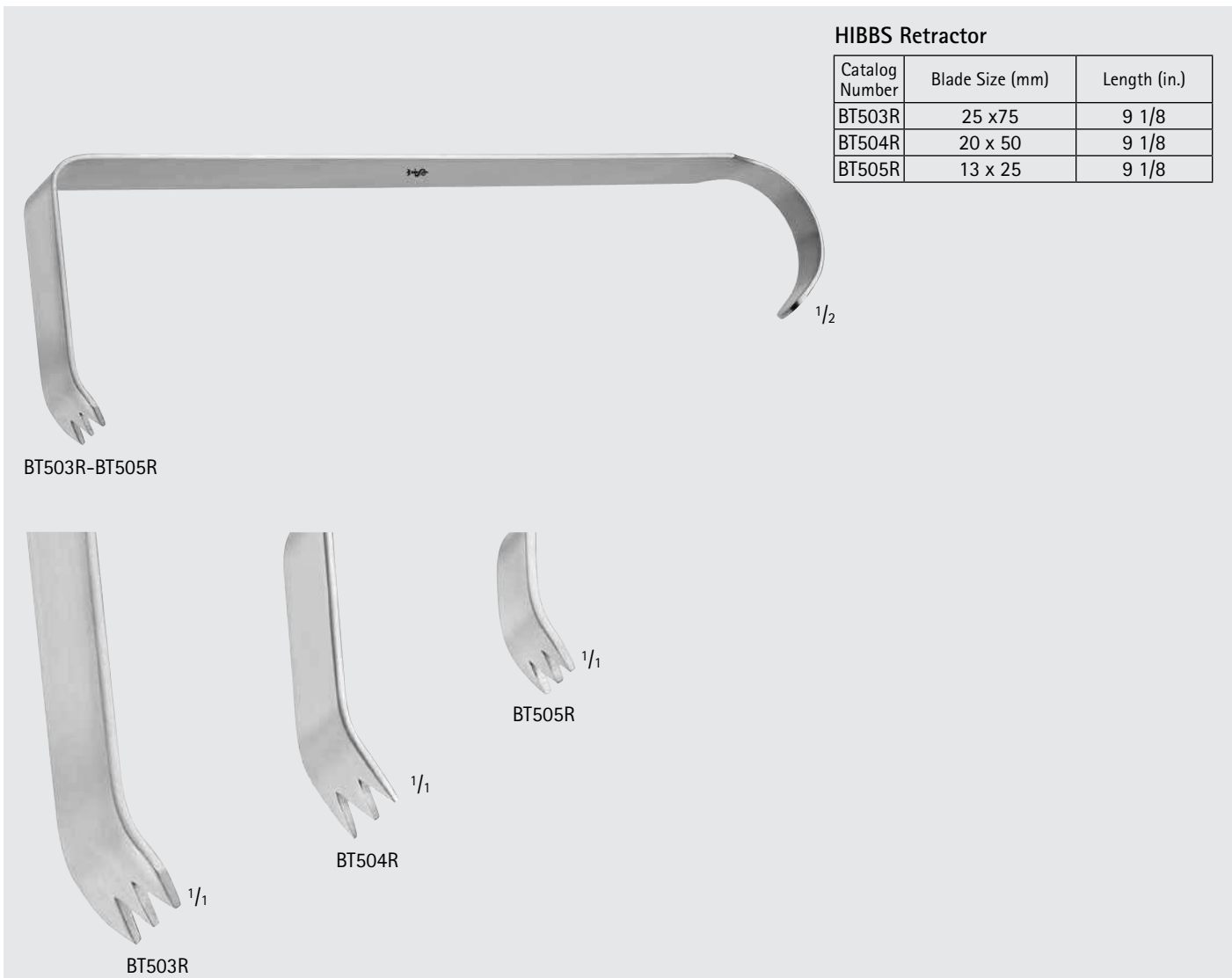

HIBBS Retractor

Catalog Number	Blade Size (mm)	Length (in.)
BT503R	25 x 75	9 1/8
BT504R	20 x 50	9 1/8
BT505R	13 x 25	9 1/8

BT503R-BT505R

BT503R

BT504R

BT505R



ORTHO
SPINE

Orthopedics/Spine

Retractors



BT501R-BT502R

TAYLOR Spinal Retractor

Catalog Number	Blade Size (mm)	Length (in.)
BT501R	30 x 70	7 1/4
BT502R	30 x 100	7 7/8



BT501R



BT502R

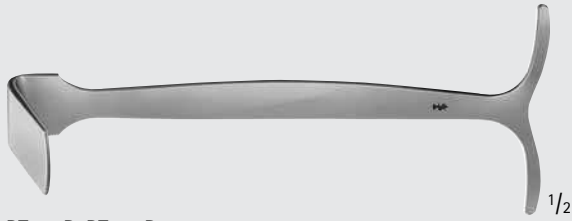

BT421R-BT425R

SMILLIE Retractor

Catalog Number	Blade Size (mm)	Length (in.)
BT421R	32 x 19	5 1/2
BT422R	48 x 19	5 1/2
BT423R	57 x 19	5 1/2
BT424R	52 x 13	5 1/2
BT425R	12 x 13	5 1/2

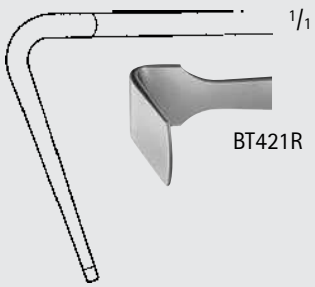

BT421R

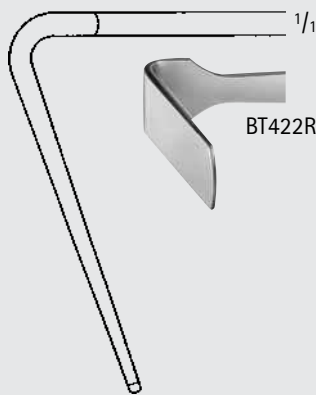

BT422R

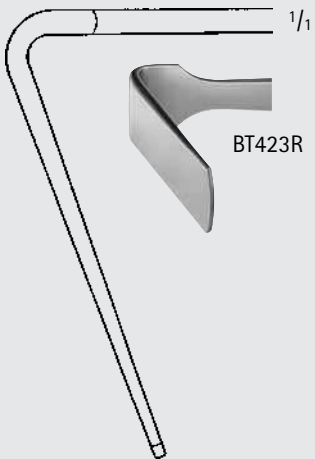

BT423R

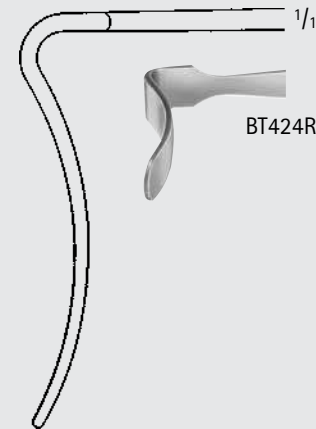

BT424R

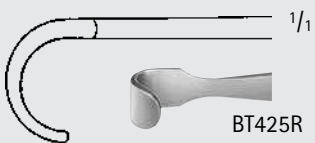

BT425R



MEYERDING Retractor

Catalog Number	Blade Size (mm)	Length (in.)
BT485R	52 x 16	9
BT486R	76 x 25	9
BT487R	89 x 50	10

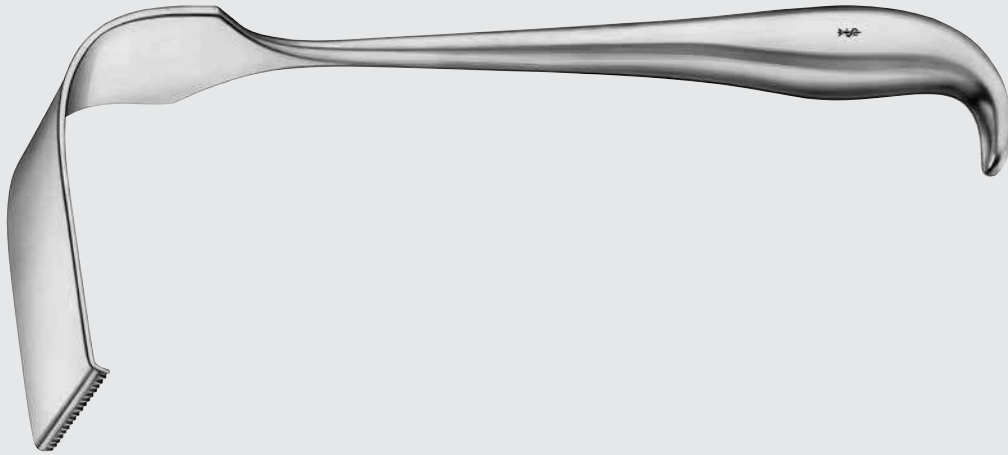

BT485R-BT487R

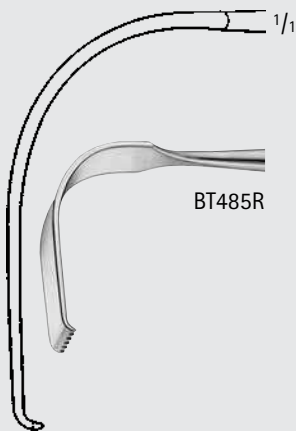

BT485R

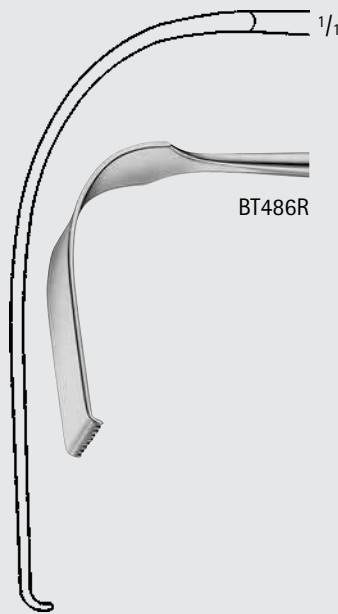

BT486R

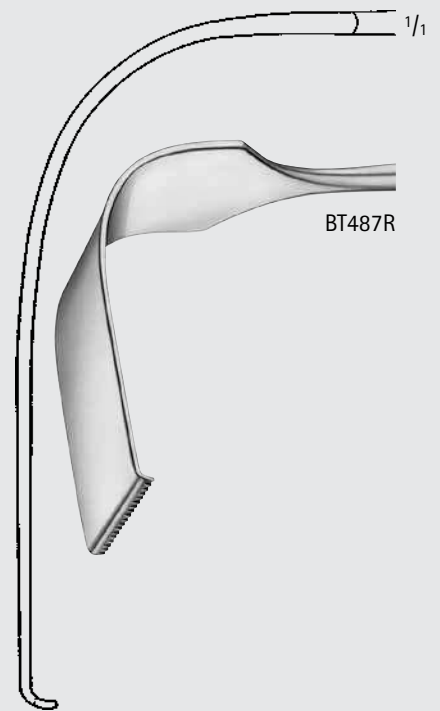

BT487R



AUFRANC Cobra Retractor

Catalog Number	Tip	Length (in.)
MB448R	SMOOTH, POINTED	10
MB514R	SMOOTH, BLUNT	10



1/2

MB448R-MB514R

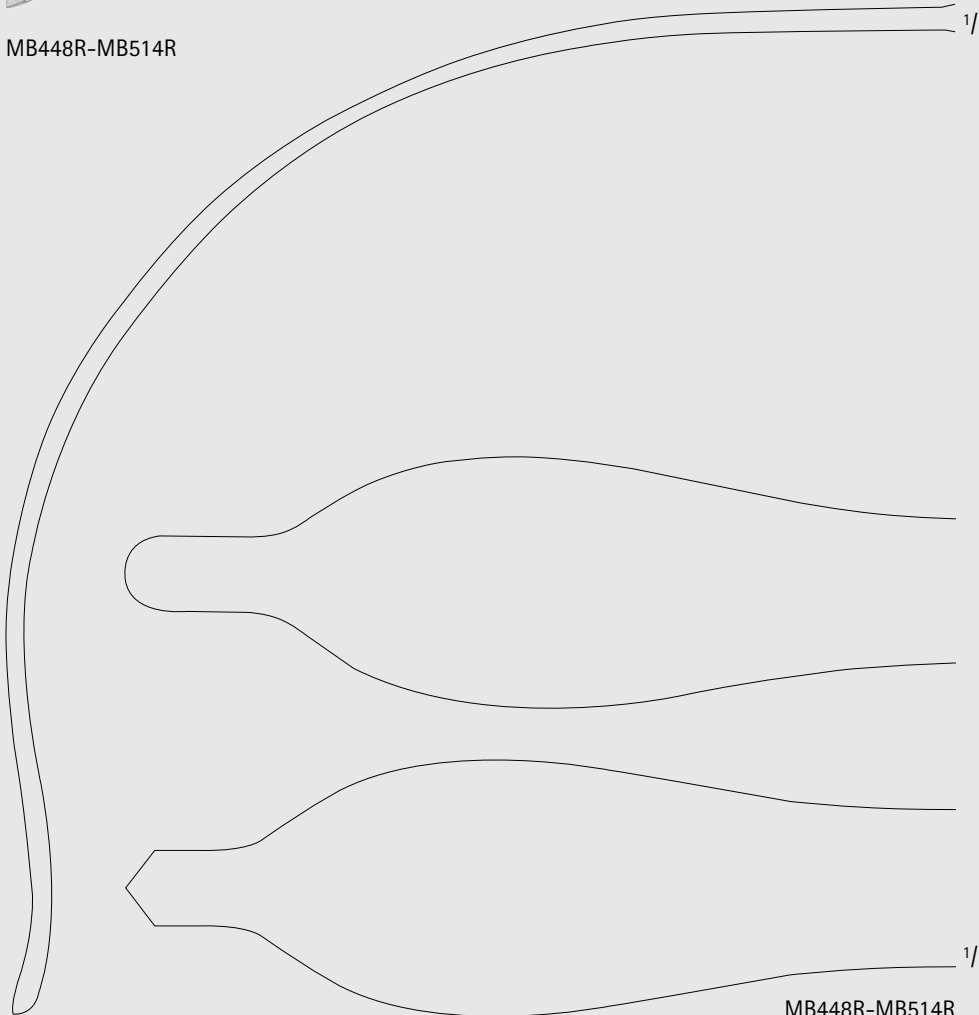

1/1

MB448R-MB514R



ORTHO
SPINE

INCHES



AUFRANC Cobra Retractor

Catalog Number	Tip	Length (in.)
MB379R	SERR, BLUNT	10

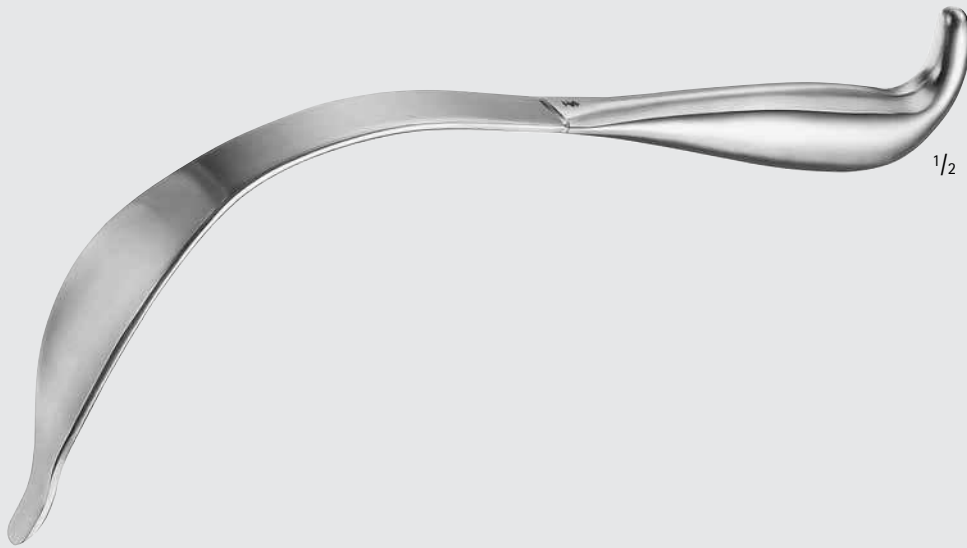

MB379R

1/2

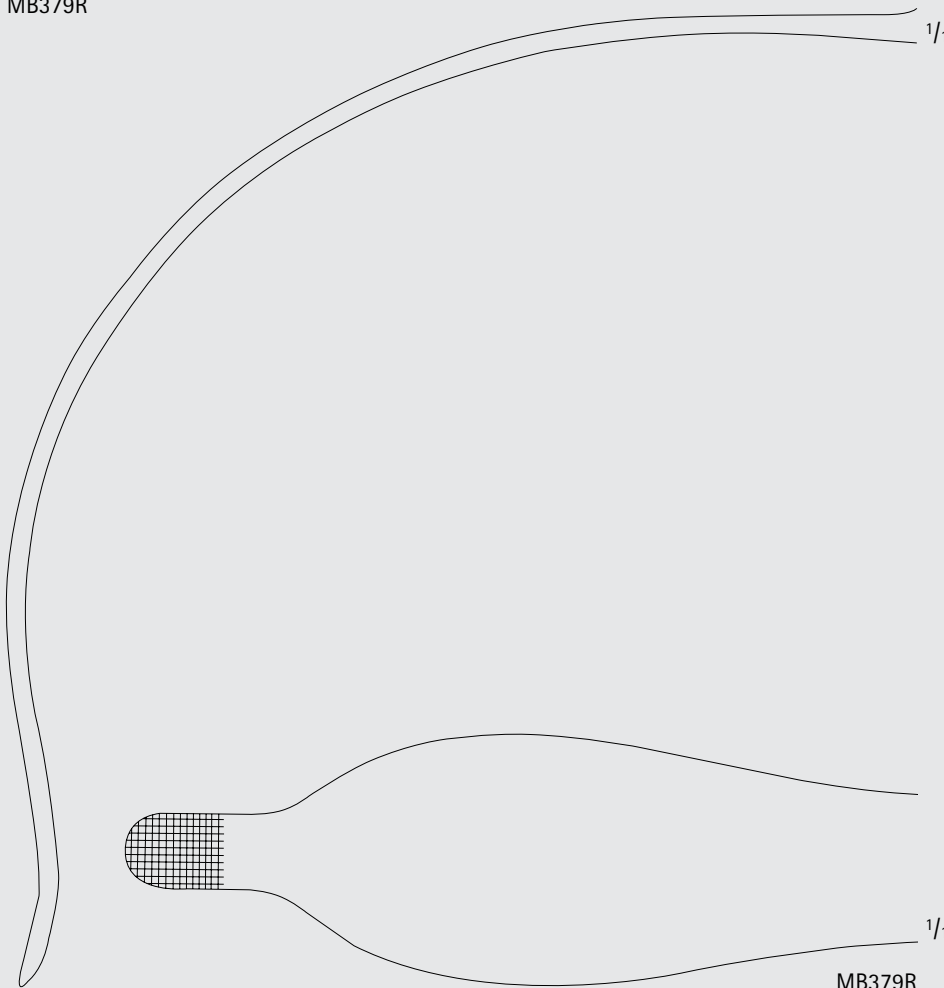

1/1

1/1

MB379R



MF058R-MF060R

**CLOWARD Style Cervical Retractor
W/ Lip**

Catalog Number	Width (mm)	Length (in.)
MF058R	18	7
MF059R	20	7
MF060R	23	7

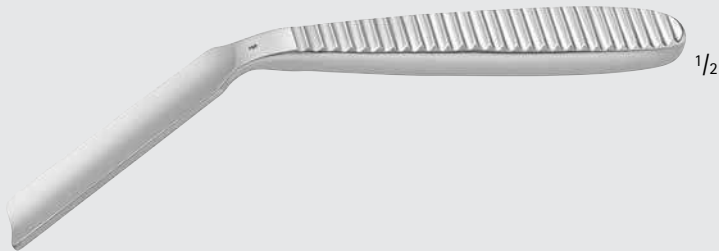

MN073R-MN075R

**CLOWARD Style Cervical Retractor
W/O Lip**

Catalog Number	Width (mm)	Length (in.)
MN073R	18	7
MN074R	20	7
MN075R	23	7



Orthopedics/Spine

Retractors



FK110R

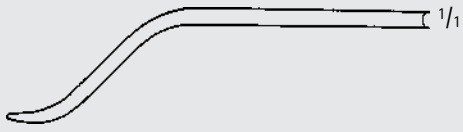

5.5 mm

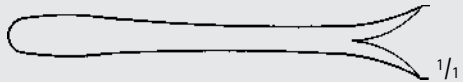

FK110R



FK111R

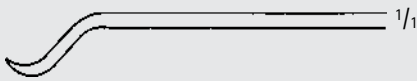

2.8 mm

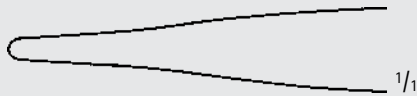

FK111R



FK113R

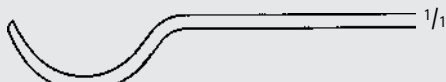

4.5 mm

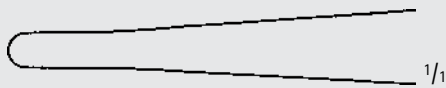

FK113R



FK114R

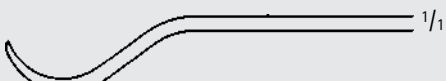

7 mm

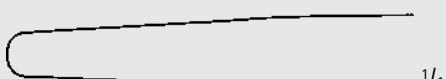

FK114R

HAYES Bone Retractor

Catalog Number	Blade Size (mm)	Length (in.)
FK110R	5.5	6 1/8
FK111R	2.8	5 1/2
FK113R	4.5	6
FK114R	7	6

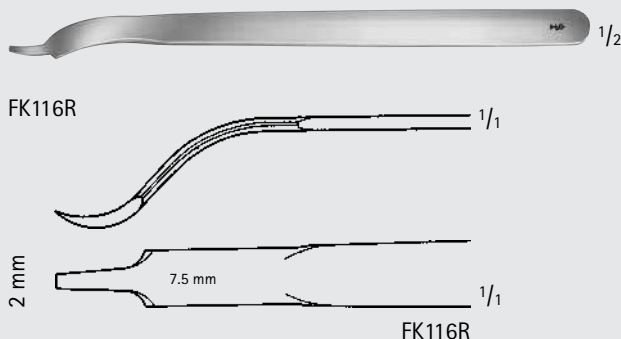

FK116R $\frac{1}{2}$

FK116R $\frac{1}{1}$

2 mm

7.5 mm

FK116R $\frac{1}{1}$

BUCK-GRAMCKO Bone Retractor

Catalog Number	Blade Size (mm)	Length (in.)
FK116R	2/7.5	6

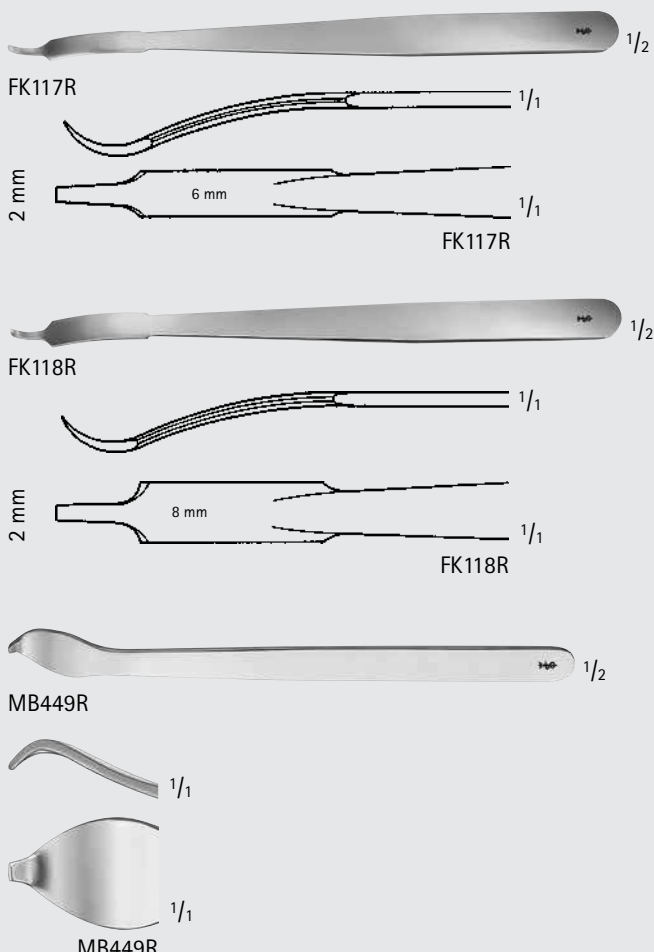

FK117R $\frac{1}{2}$

FK117R $\frac{1}{1}$

2 mm

6 mm

FK117R $\frac{1}{1}$

FK118R $\frac{1}{2}$

FK118R $\frac{1}{1}$

2 mm

8 mm

FK118R $\frac{1}{1}$

MB449R $\frac{1}{2}$

MB449R $\frac{1}{1}$

MB449R $\frac{1}{1}$

MB449R

HOHMANN Bone Retractor

Catalog Number	Blade Size (mm)	Length (in.)
FK117R	2/6	6 1/4
FK118R	2/8	6 1/4
MB449R	2/15	6

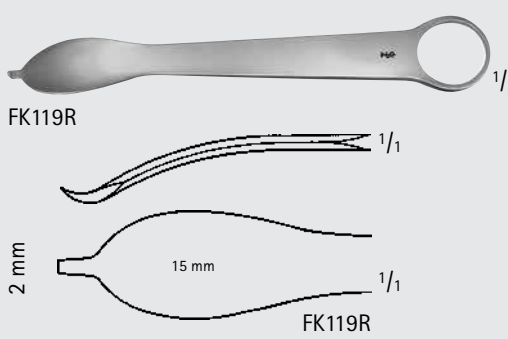

FK119R $\frac{1}{2}$

FK119R $\frac{1}{1}$

2 mm

15 mm

FK119R $\frac{1}{1}$

Baby HOHMANN Retractor

Catalog Number	Blade Size (mm)	Length (in.)
FK119R	2/15	5



ORTHO
SPINE

INCHES

Orthopedics/Spine

Retractors



FK170R

1/2

HOHMANN Bone Retractor

Catalog Number	Blade Size (mm)	Length (in.)
FK170R	9	8 3/4
FK166R	17	9 1/2

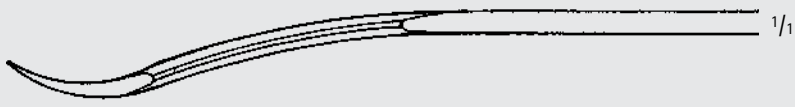

1/1

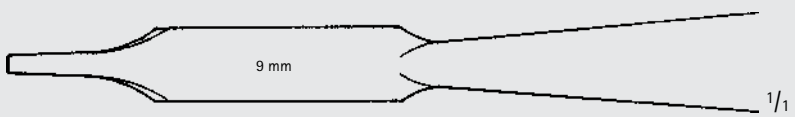

9 mm

1/1

FK170R

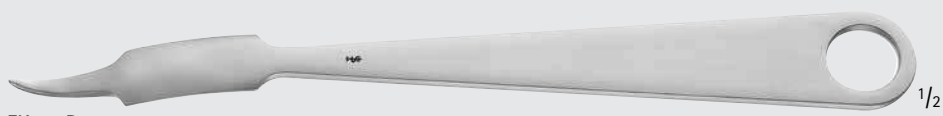

FK166R

1/2



1/1

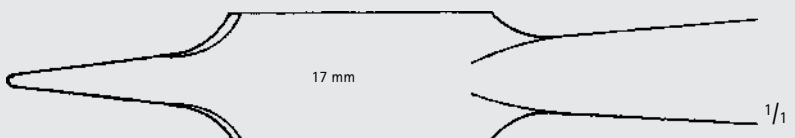

17 mm

1/1

FK166R

HOHMANN Bone Retractor (continued)

Catalog Number	Blade Size (mm)	Length (in.)
FK171R	18	9 1/2
FK176R	25	10 5/8



FK171R

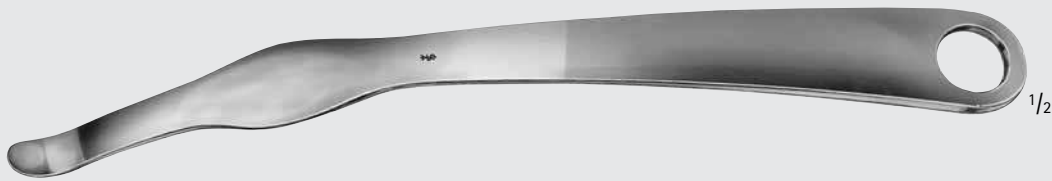
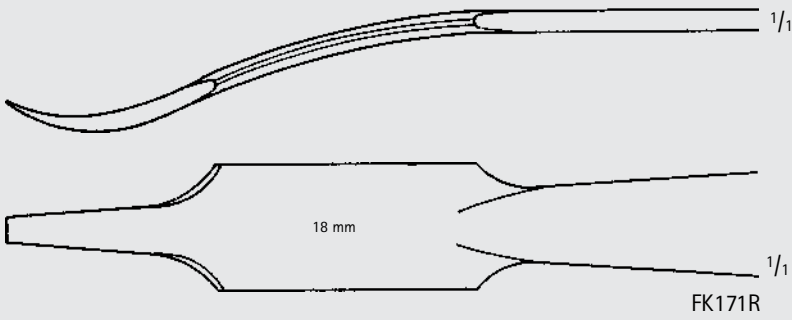

FK176R

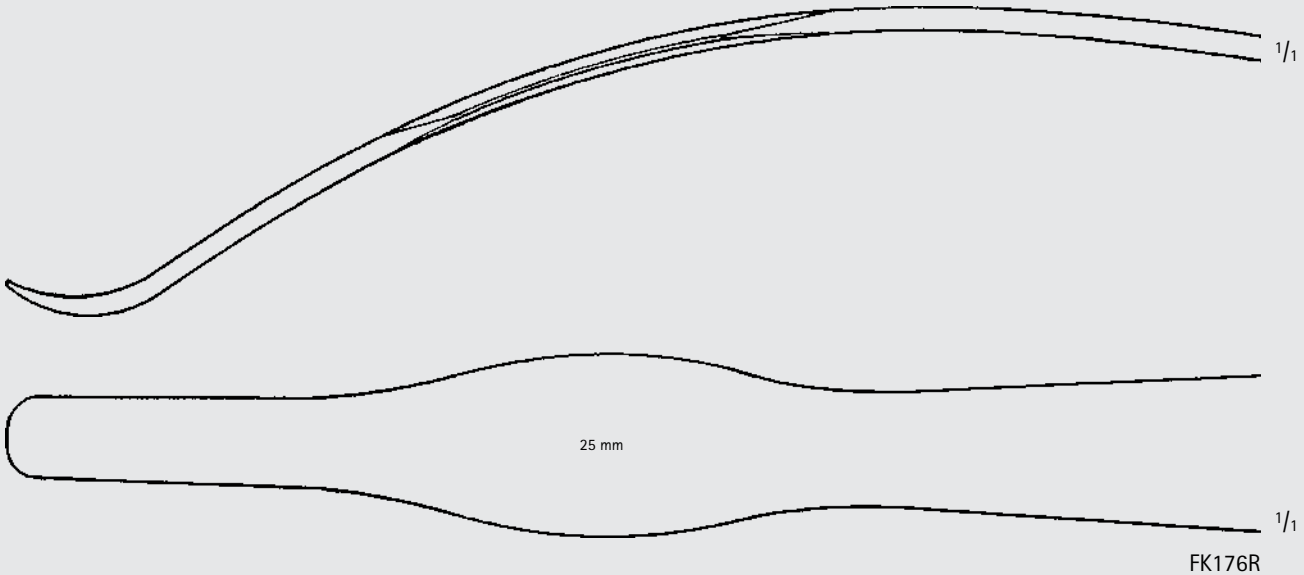



Orthopedics/Spine

Retractors

HOHMANN Bone Retractor (continued)

Catalog Number	Blade Size (mm)	Length (in.)
FK172R	24	10 1/4
FK173R	34	11 1/4



FK172R-FK173R

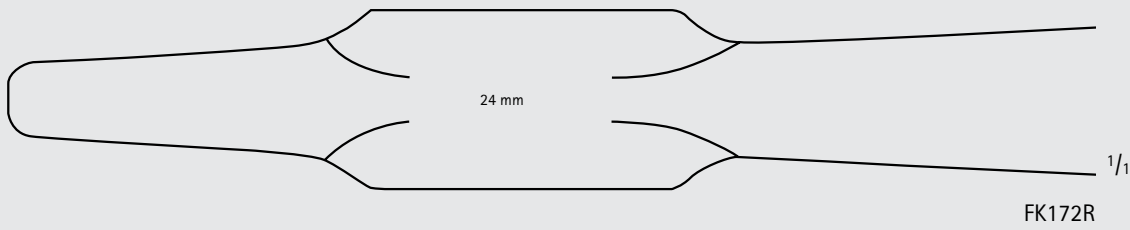

FK172R

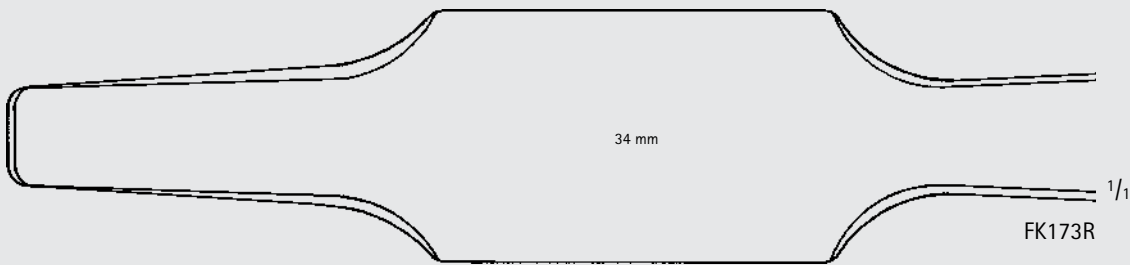
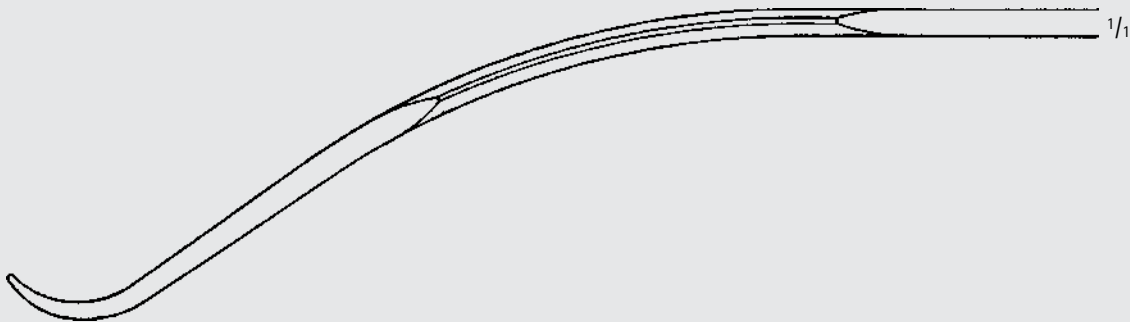

FK173R



LANGE-HOHMANN Bone Retractor

Catalog Number	Blade Size (mm)	Length (in.)
FK160R	24	9 3/4

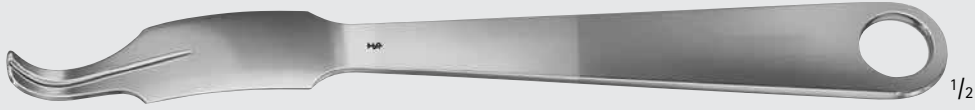

FK160R

1/2



1/1

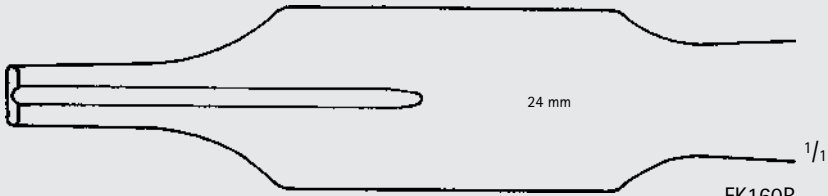

24 mm

1/1

FK160R



ORTHO
SPINE

INCHES

**LANGE-HOHMANN Bone Retractor
(continued)**

Catalog Number	Blade Size (mm)	Length (in.)
FK161R	30	10 1/2
FK162R	33	11



FK161R-FK162R

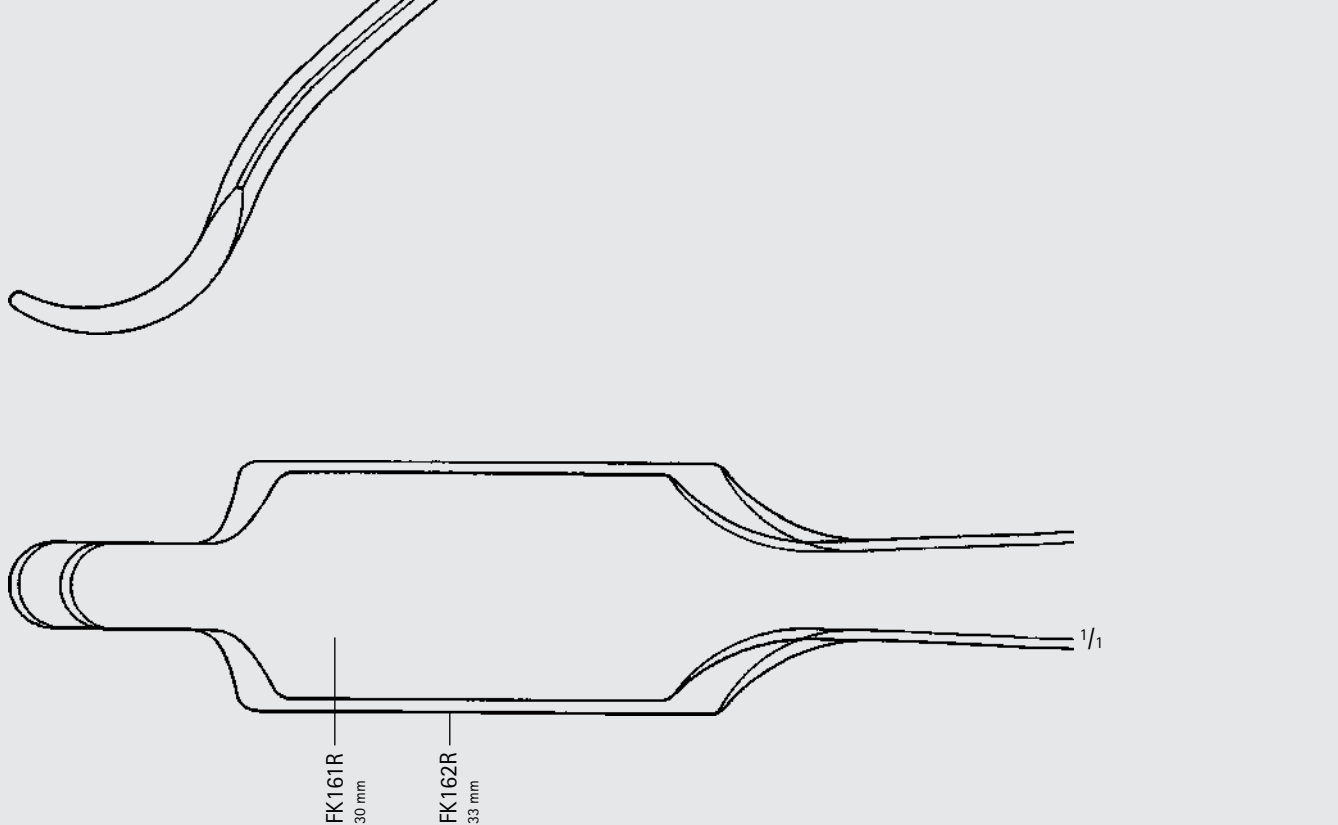
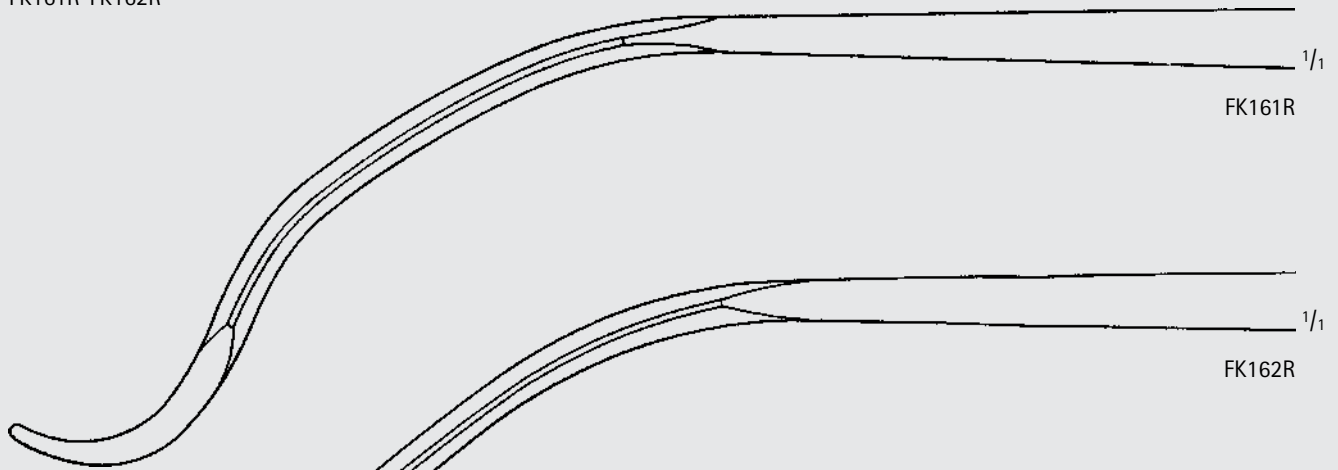

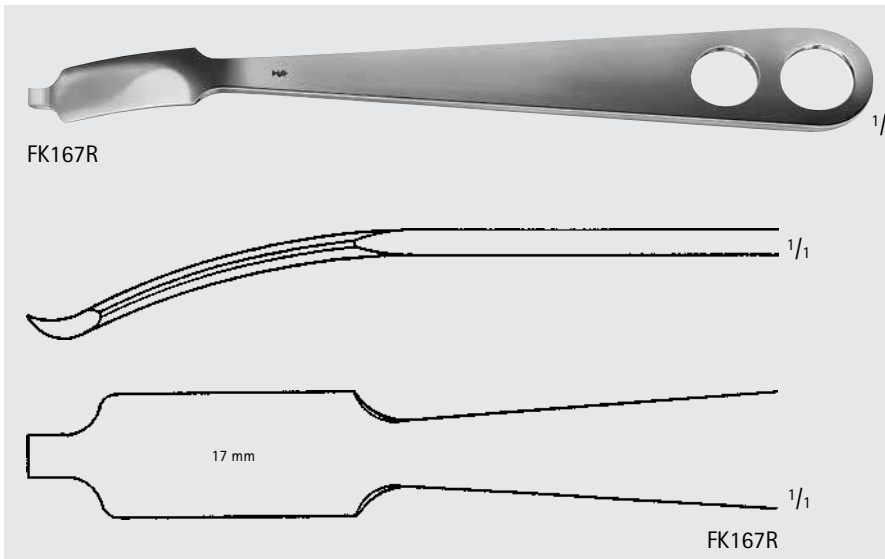

FK167R

17 mm

1/2

1/1

FK167R

HOHMANN (WAGNER) Humoral Head Retractor

Catalog Number	Blade Size (mm)	Length (in.)
FK167R	17	8 3/4

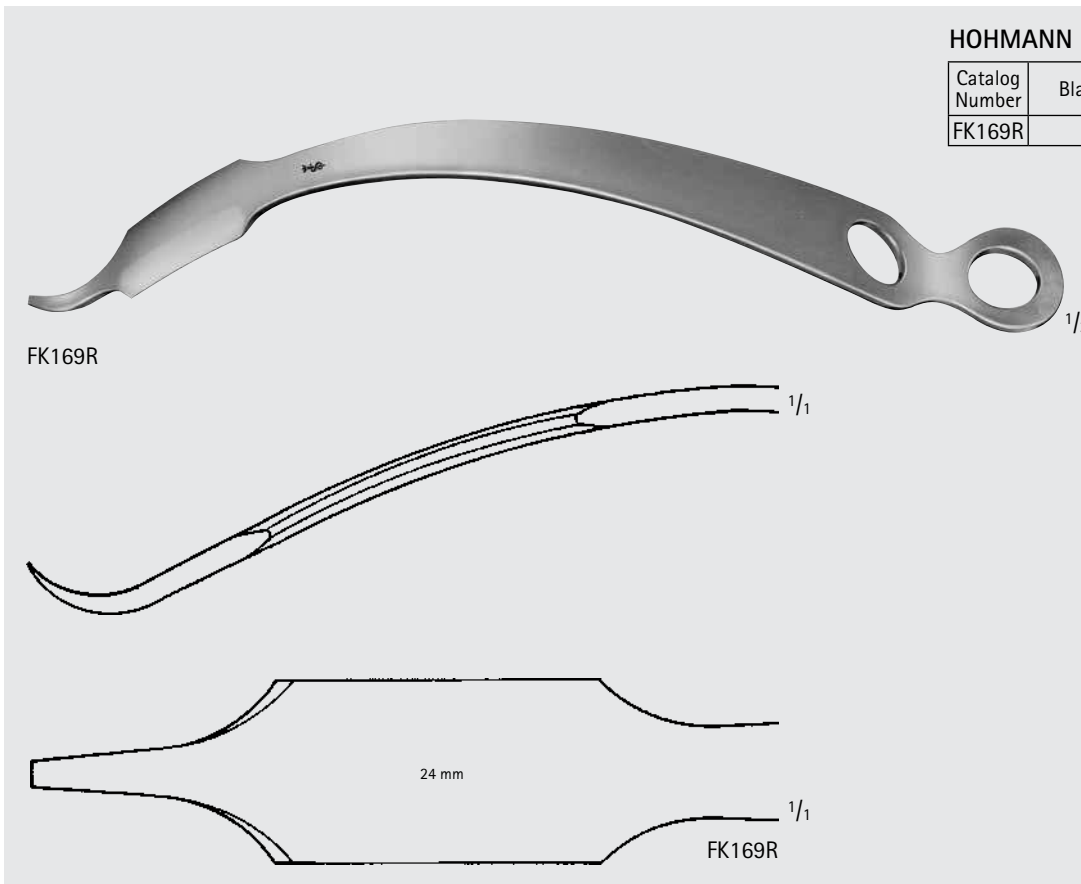

FK169R

24 mm

1/2

1/1

FK169R

HOHMANN (ALDINGER) Bone Retractor

Catalog Number	Blade Size (mm)	Length (in.)
FK169R	24	10 5/8



Orthopedics/Spine

Retractors



FK185R-FK187R

1/2

HOHMANN Bone Retractor

Catalog Number	Blade Size (mm)	Length (in.)
FK185R	8	8 3/4
FK186R	15	9 3/4
FK187R	22	11 3/4



1/1

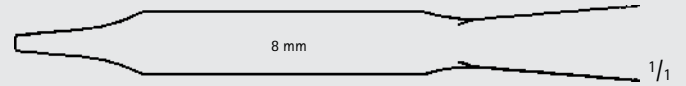

FK185R

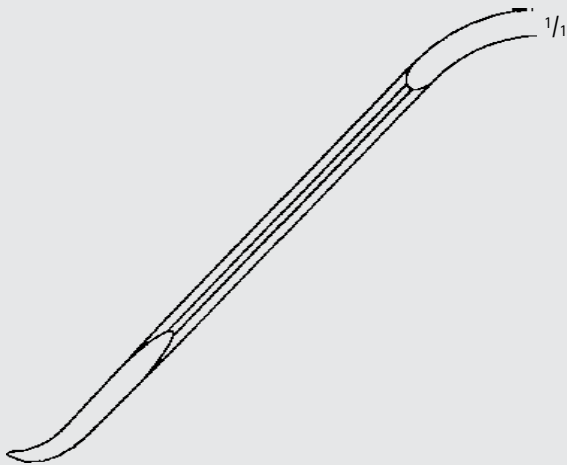

1/1



FK186R

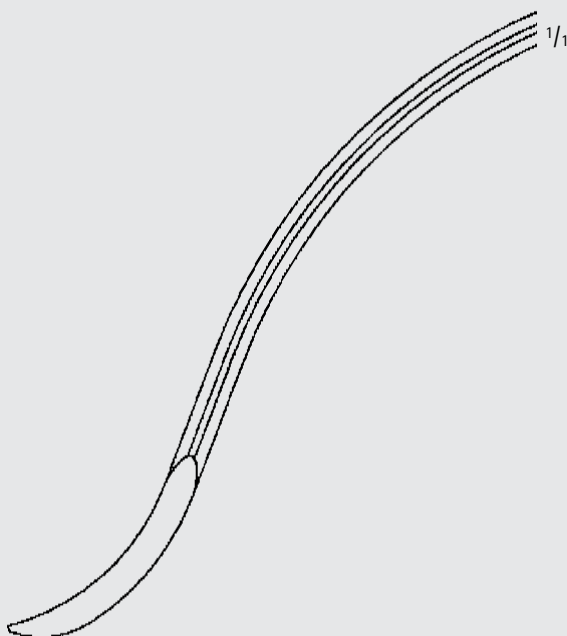

1/1

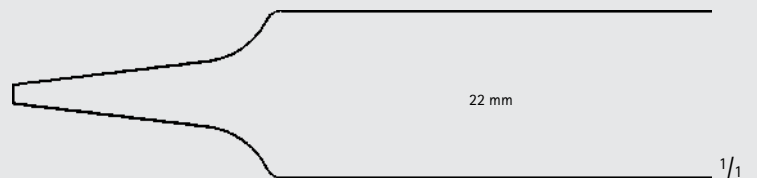

FK187R

HOHMANN Bone Retractor (continued)

Catalog Number	Blade Size (mm)	Length (in.)
FK188R	43	9



FK188R

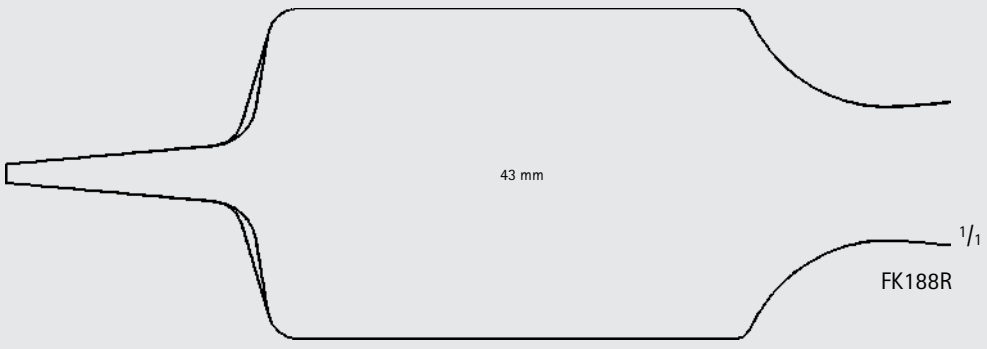
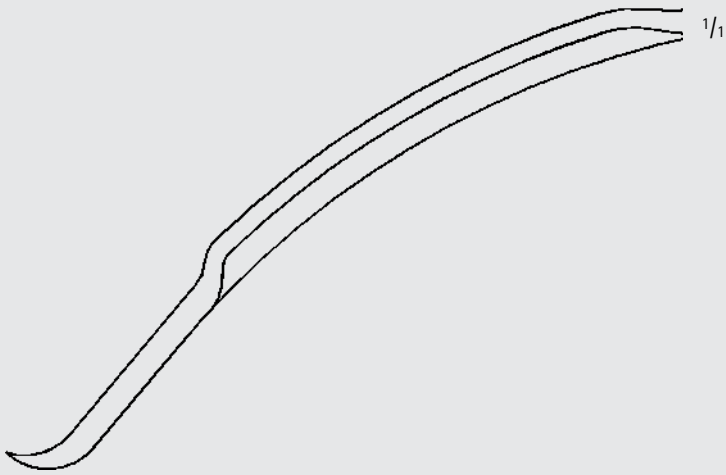

HOHMANN Bone Retractor (continued)

Catalog Number	Blade Size (mm)	Length (in.)
FK189R	40	11 1/2



FK189R

1/1

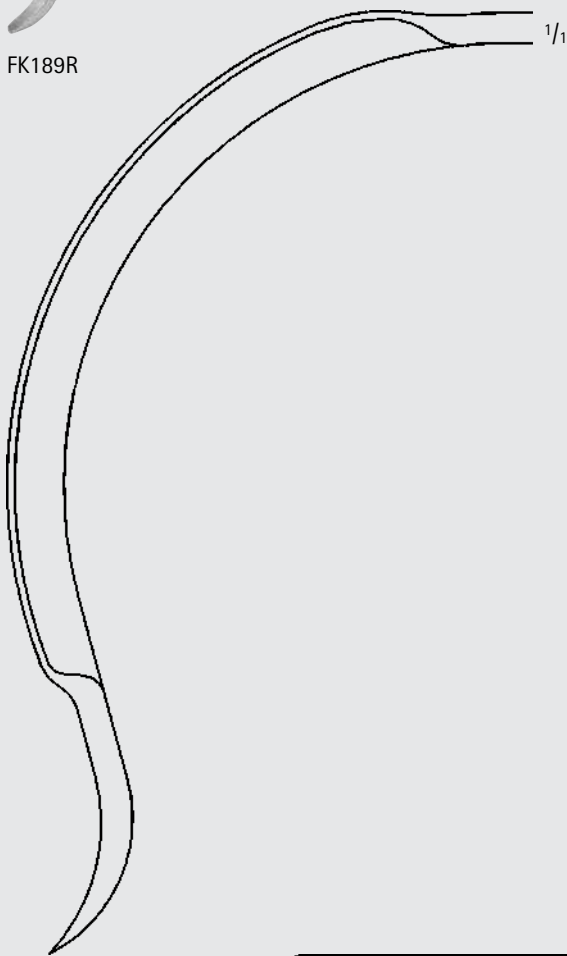

40 mm

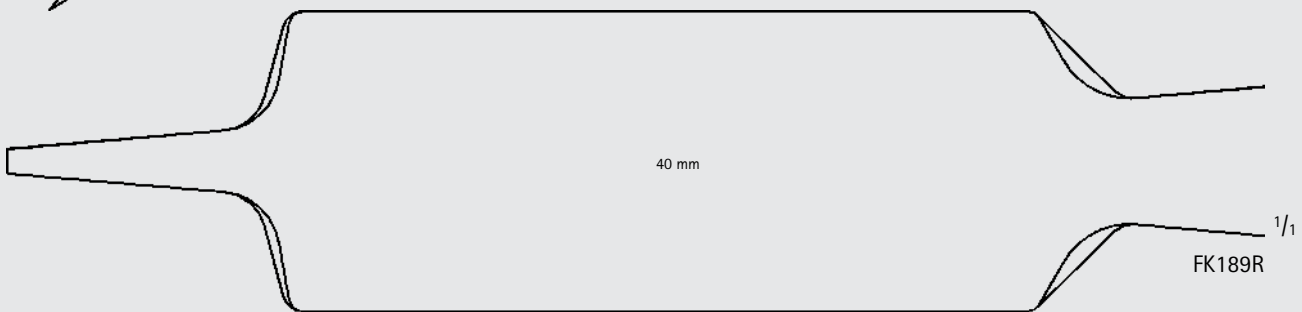

1/1
FK189R



**SCHUMACHER Modified WAGNER
Bone Retractor**

Catalog Number	Blade Size (mm)	Length (in.)
FK168R	37	14

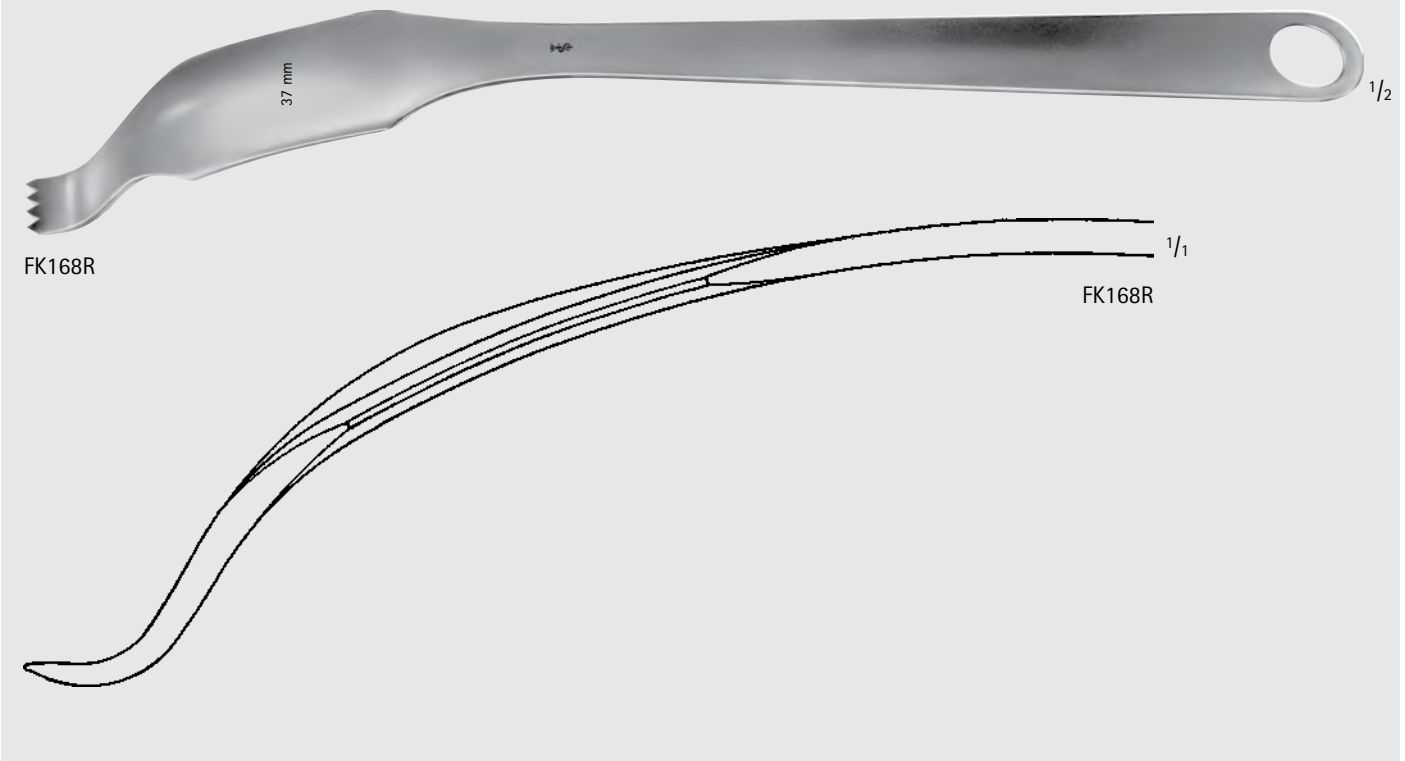

SCHUMACHER Bone Retractor

Catalog Number	Blade Size (mm)	Length (in.)
FK177R	35	11 1/2

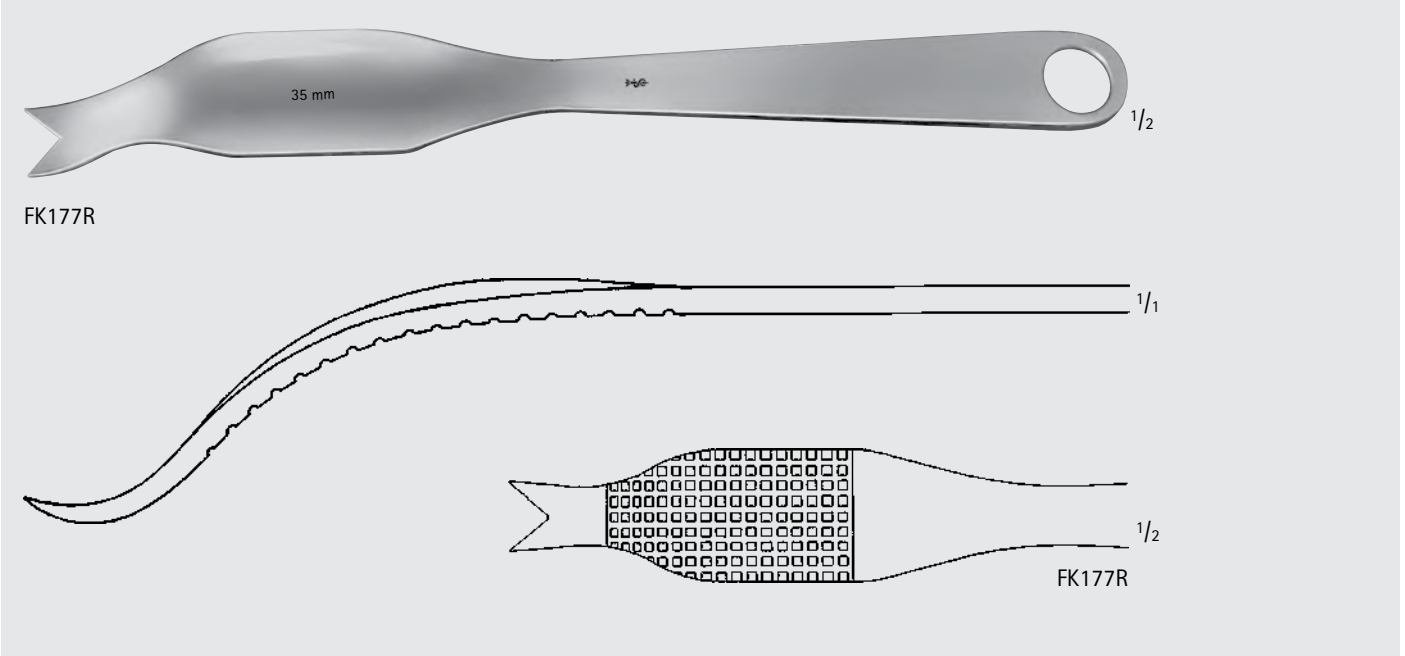

Orthopedics/Spine

Retractors

VERBRUGGE-MÜLLER Bone Retractor

Catalog Number	Blade Size (mm)	Length (in.)
FK174R	44	9 1/2
FK175R	65	10



FK174R-FK175R

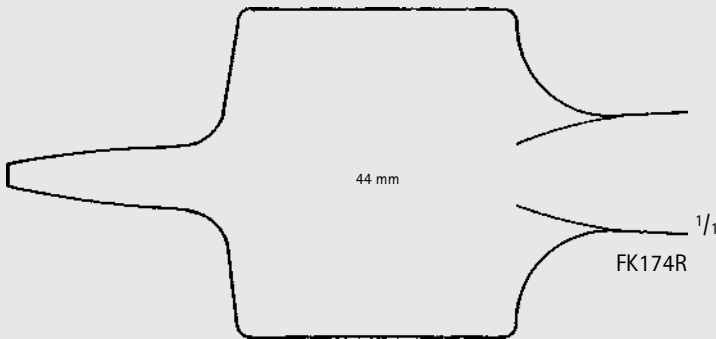
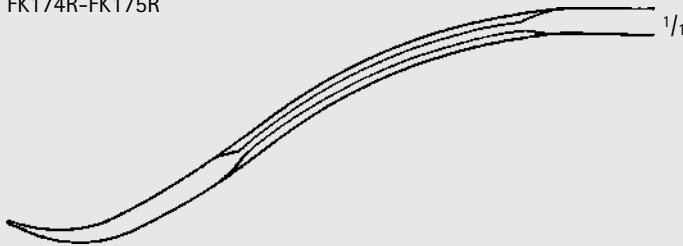

FK174R

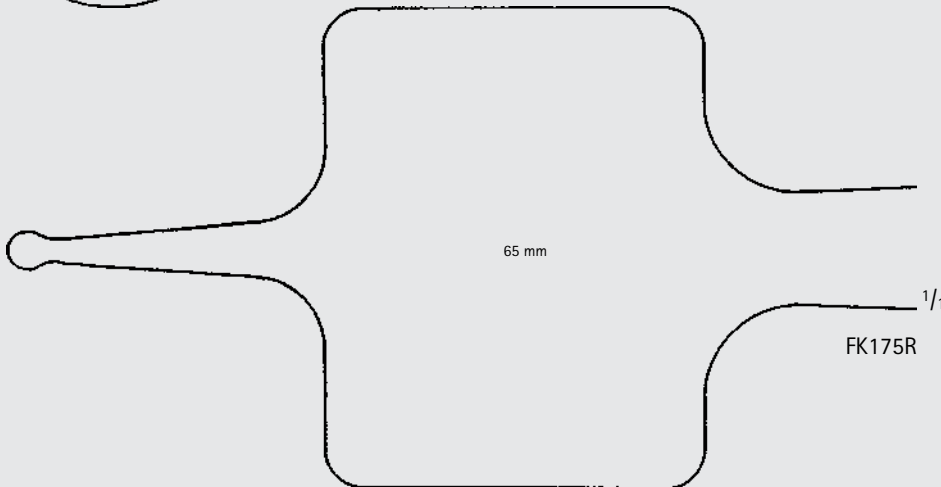
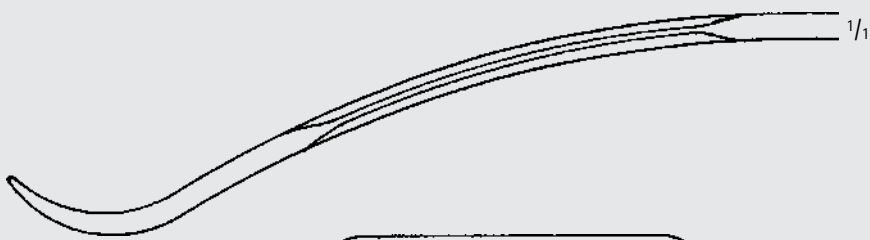

FK175R



BENNETT Bone Retractor

Catalog Number	Blade Size (mm)	Length (in.)
FK180R	65	9 1/2
MD563	44	9 1/2



FK180R, MD563

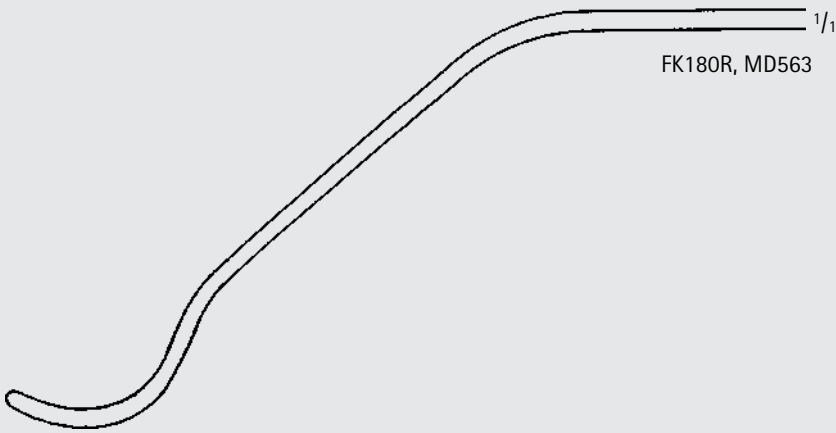

FK180R, MD563

MURPHY-LANE Bone Skid

Catalog Number	Blade Size (mm)	Length (in.)
FK193R	18 / 30	11 3/4



FK193R



FK193R





Bone Hook

Catalog Number	Tip	Blade End	Length (in.)
BT232R	SHARP	1 PRONG	9 5/8



BT232R

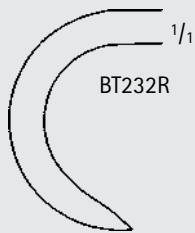

BT232R

KOCHER Bone Hook

Catalog Number	Tip	Blade End	Length (in.)
BT234R	SHARP	1 PRONG	8
BT238R	SHARP	1 PRONG	8 3/4
BT239R	BLUNT	1 PRONG	8 3/4



BT234R



BT234R



BT238R

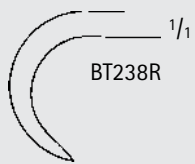

BT238R



BT239R

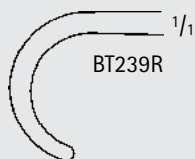

BT239R

VOLKMANN Bone Hook

Catalog Number	Tip	Blade End	Length (in.)
BT240R	SHARP	1 PRONG	8 3/4
BT241R	BLUNT	1 PRONG	8 3/4



BT240R

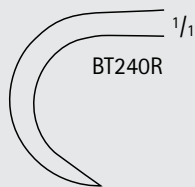

BT240R



BT241R

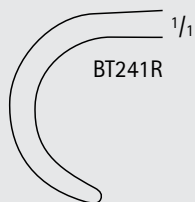

BT241R

Bone Hooks

Catalog Number	Tip	Diameter (mm)	Length (in.)
MB974R	SHARP	19	9
MB975R	BLUNT	19	9
MB418R	SHARP	30	9

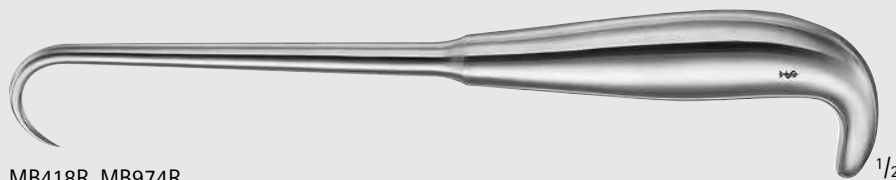

MB418R, MB974R

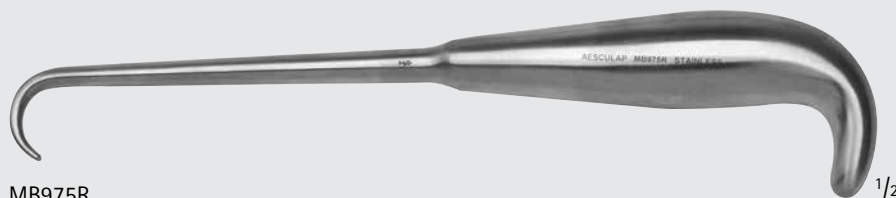

MB975R



MB975R



ORTHO
SPINE

Orthopedics/Spine

Retractors

ANDERSON-ADSON Retractor

Catalog Number	Tip	Blade End	Length (in.)
BV250R	SHARP	4 x 4 PRONGS	7 1/2

BV250R

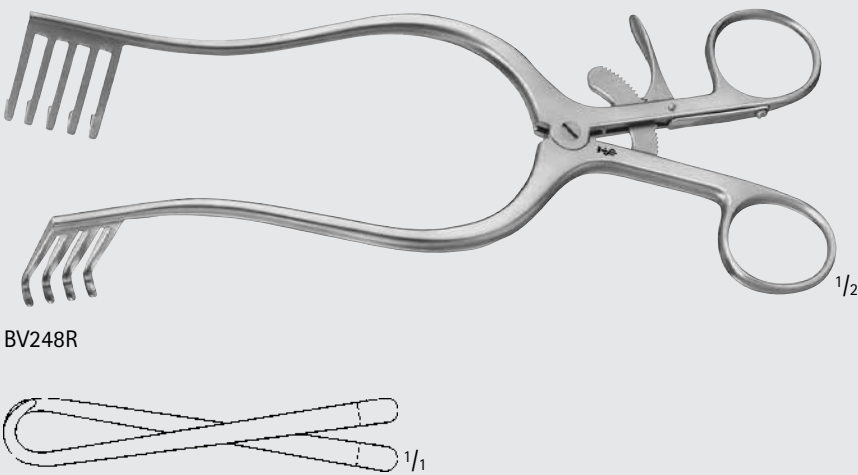

NORFOLK-NORWICH Retractor

Catalog Number	Tip	Blade End	Length (in.)
BV248R	BLUNT	4 x 5 PRONGS	8 3/4

BV248R

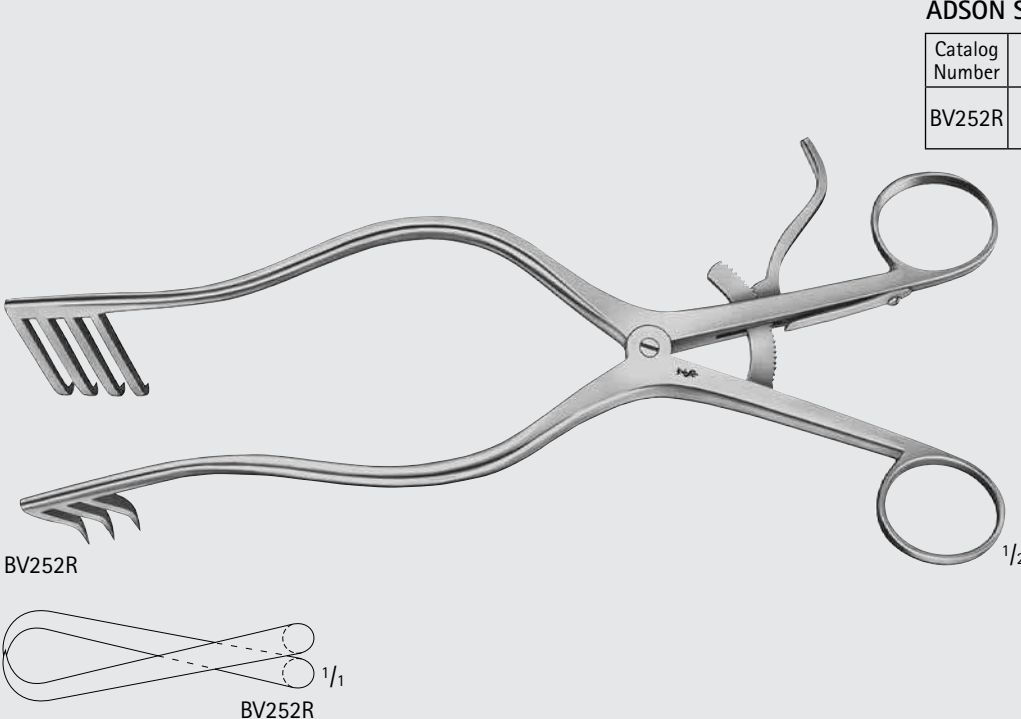

ADSON Self Retaining Retractor

Catalog Number	Tip	Blade End	Length (in.)
BV252R	SHARP	3 x 4 PRONGS	10 1/2

BV252R

Laminectomy Self Retaining Retractor

Catalog Number	Tip	Blade End	Length (in.)
BV254R	SHARP	6 x 6 PRONGS	11



BV254R

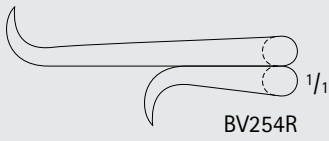

BV254R

ADSON Self Retaining Retractor,
Hinged

Catalog Number	Tip	Blade End	Length (in.)
BV251R	SEMI-S	4 x 4 PRONGS	8 1/2



BV251R

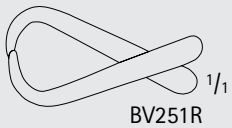

BV251R



Orthopedics/Spine

Retractors

HARVEY-JACKSON Retractor, Hinged

Catalog Number	Tip	Blade End	Length (in.)
BV258R	SHARP	3 x 3 PRONGS	11 3/4

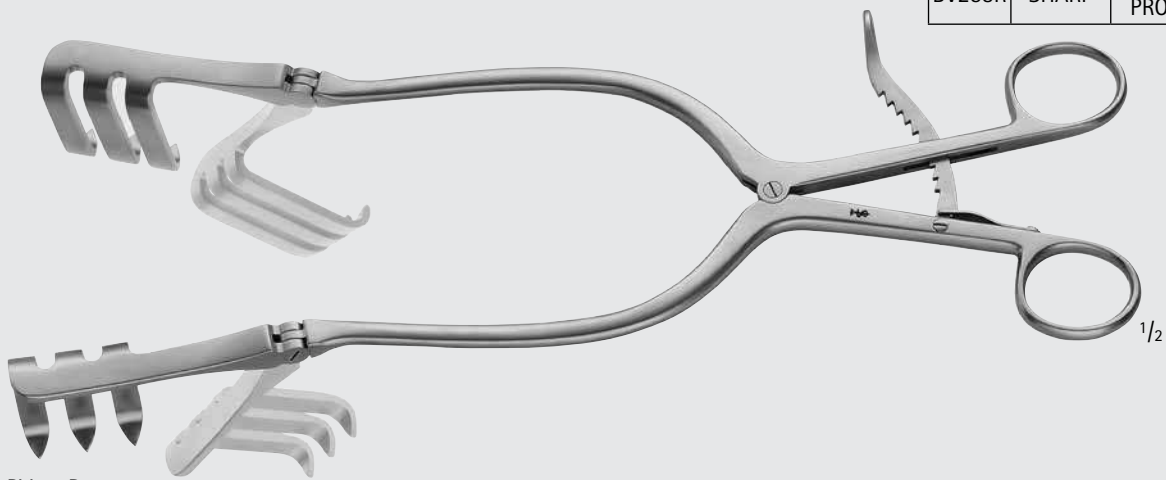

BV258R

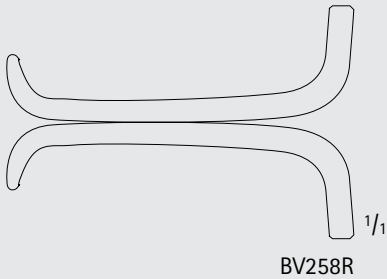

BV258R

BECKMANN-ADSON Retractor, Hinged

Catalog Number	Tip	Blade End	Length (in.)
BV271R	SEMI-S	4 x 4 PRONGS	12 1/4
BV272R	SHARP	4 x 4 PRONGS	12 1/4

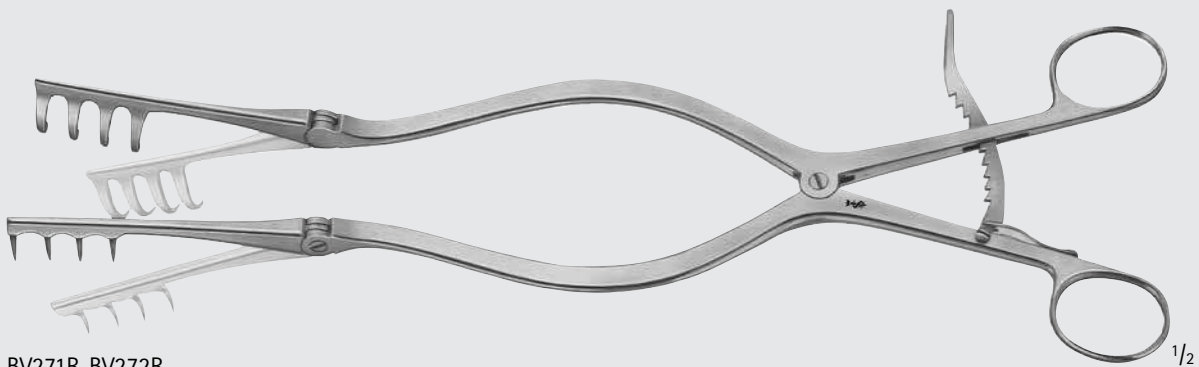

BV271R-BV272R

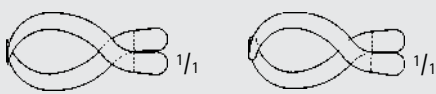

BV271R

BV272R



ADSON Retractor, Hinged

Catalog Number	Tip	Blade End	Length (in.)
BV273R	SEMI-S	5 x 4 PRONGS	12 1/2

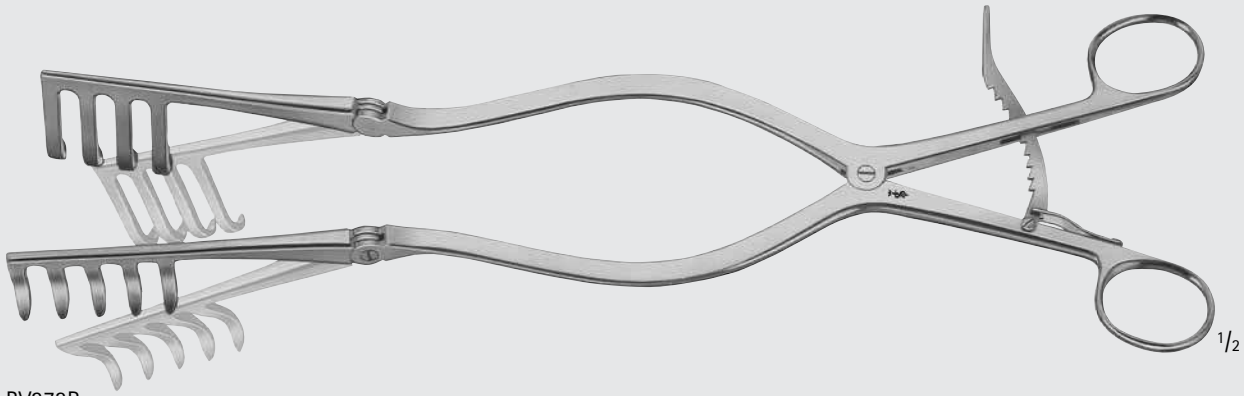

BV273R

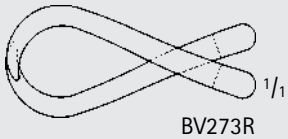

BV273R

BECKMANN Retractor, Hinged

Catalog Number	Tip	Blade End	Length (in.)
BV276R	SHARP	7 x 7 PRONGS	12 1/2

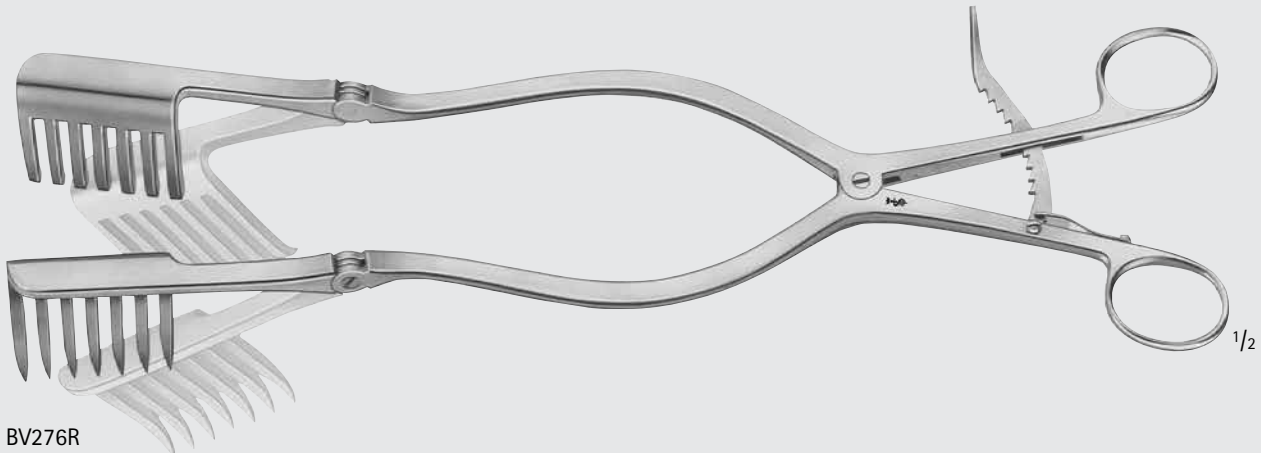

BV276R

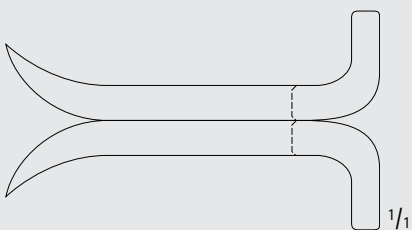

BV276R



ORTHO
SPINE

INCHES

Orthopedics/Spine

Retractors

BECKMANN Retractor, Hinged (continued)

Catalog Number	Tip	Blade End	Length (in.)
MG064R	SHARP	3 x 4 PRONGS	6 1/2
MG371R	BLUNT	3 x 4 PRONGS	6 1/4

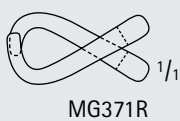
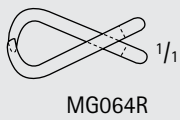
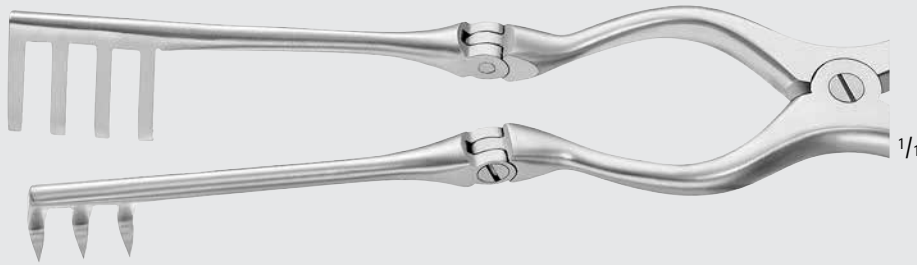
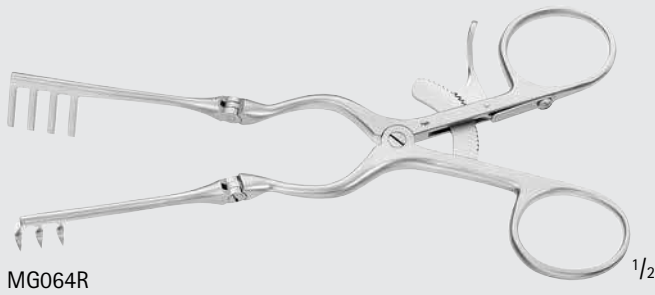

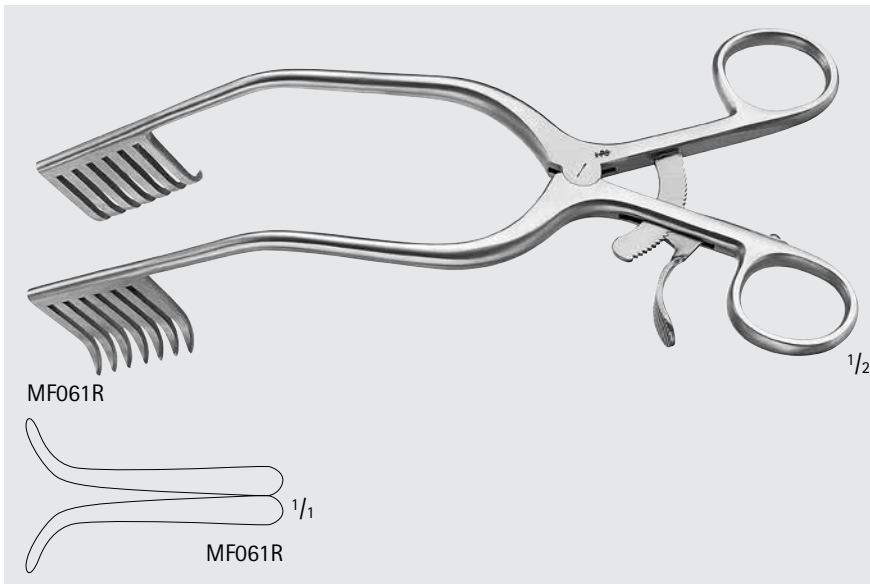

MISKIMON Cerebellum Retractor

Catalog Number	Tip	Blade End	Length (in.)
MF061R	SEMI-S	7 x 7 PRONGS	7 1/2

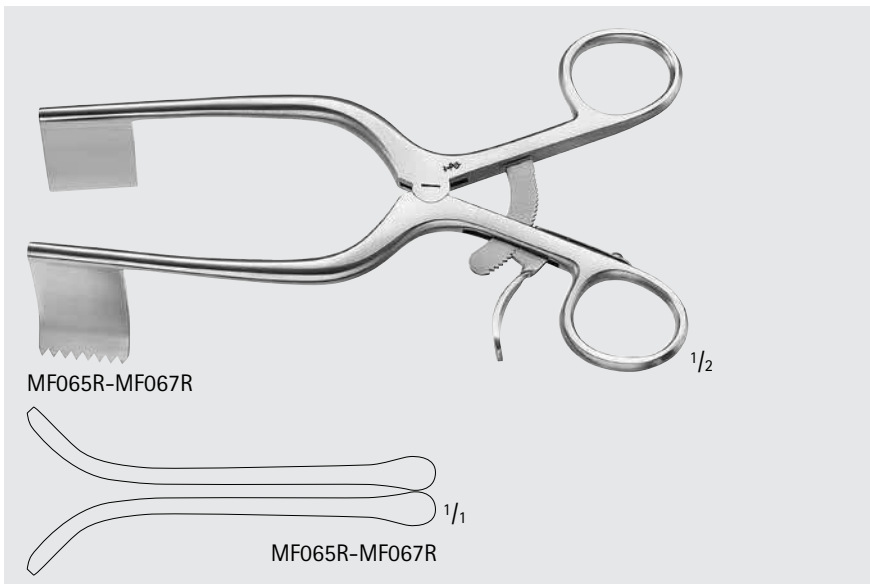

MEYERDING Retractor

Catalog Number	Blade Size (mm)	Length (in.)
MF065R	25 x 57	6 1/2
MF066R	25 x 51	6 1/2
MF067R	25 x 31	6 1/2

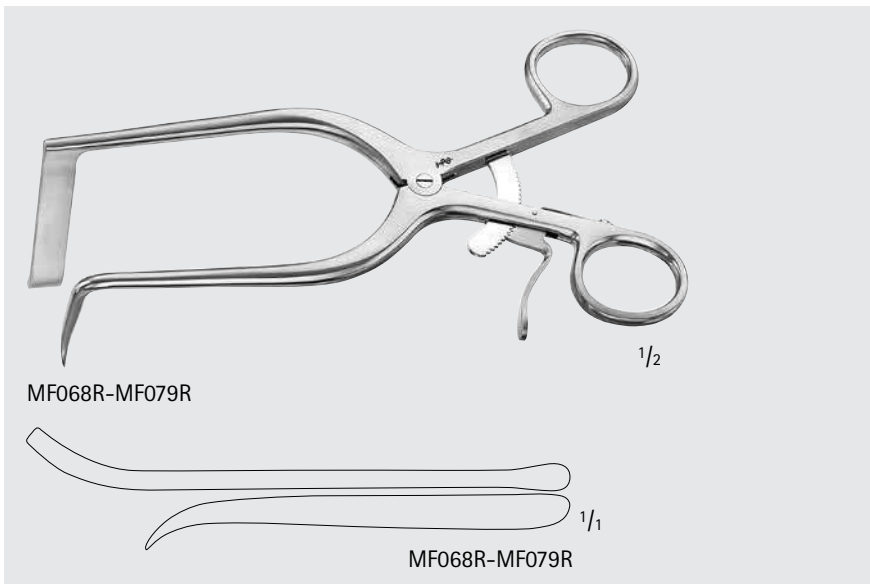

WILLIAMS Retractor

Catalog Number	Tip	Blade Size (mm)	Length (in.)
MF068R	BLADE LEFT	10 x 50	7
MF069R	BLADE RIGHT	10 x 50	7
MF070R	BLADE LEFT	10 x 60	7
MF071R	BLADE RIGHT	10 x 60	7
MF072R	BLADE LEFT	10 x 70	7
MF073R	BLADE RIGHT	10 x 70	7
MF074R	BLADE LEFT	20 x 50	7
MF075R	BLADE RIGHT	20 x 50	7
MF076R	BLADE LEFT	20 x 60	7
MF077R	BLADE RIGHT	20 x 60	7
MF078R	BLADE LEFT	20 x 70	7
MF079R	BLADE RIGHT	20 x 70	7



Orthopedics/Spine

Retractors



MF329R-MF332R

1/2

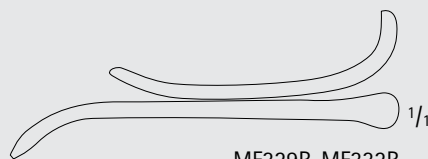

MF329R-MF332R

1/1

DUCKER Retractor

Catalog Number	Tip	Blade Size (mm)	Length (in.)
MF329R	HOOK LEFT	50 x 20	6 3/4
MF330R	HOOK RIGHT	50 x 20	6 3/4
MF331R	HOOK LEFT	70 x 20	6 3/4
MF332R	HOOK RIGHT	70 x 20	6 3/4

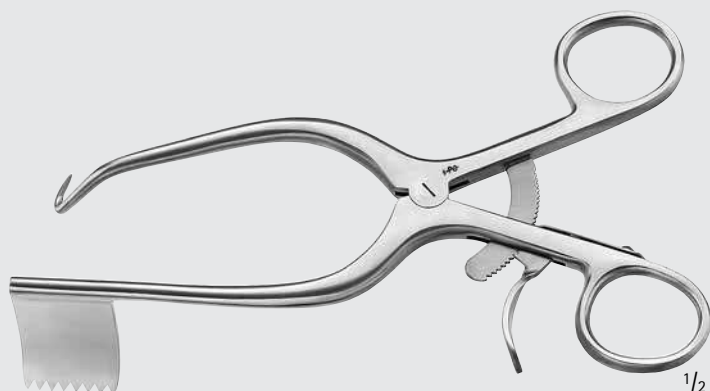

MF442R-MF443R

1/2

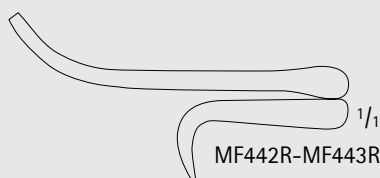

MF442R-MF443R

1/1

MARKHAM-MEYERDING Retractor

Catalog Number	Tip	Blade Size (mm)	Length (in.)
MF442R	BLADE RIGHT	46 x 26	7 1/2
MF443R	BLADE LEFT	46 x 26	7 1/2

Zelpi-Type Retractor, Deep Blade

Catalog Number	Tip	Depth (in.)
MD529R	ANG 45°	3
MD527R	ANG 90°	3
MD528R	ANG 90°	4
MD530R	ANG 90°	5

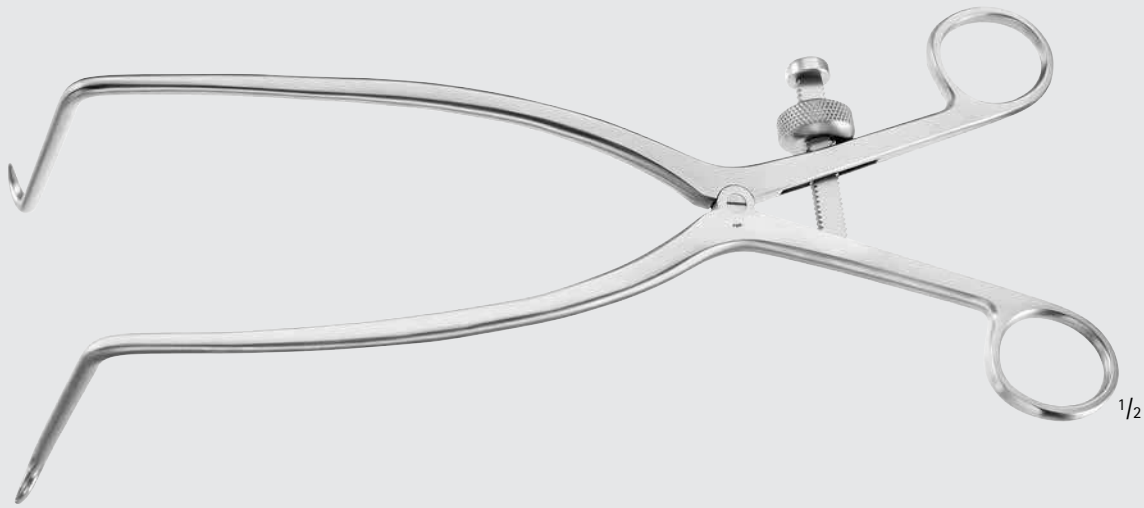

MD529R-MD530R

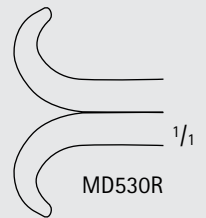
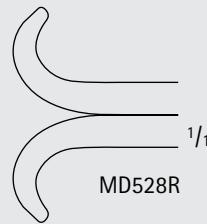
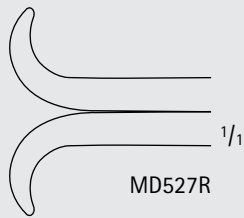
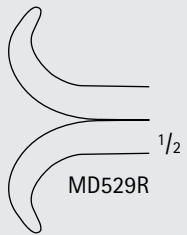

Orthopedics/Spine
Retractors and Spreaders



BV296R

1/2

CLOWARD Lamina Spreader

Catalog Number	Tip	Tip Size (mm)	Length (in.)
BV296R	SERR OUTER	5.0	6 1/8



BV299R

1/2

CLOWARD Lamina Spreader

Catalog Number	Tip	Tip Size (mm)	Length (in.)
BV299R	SERR	4.5	5 1/4

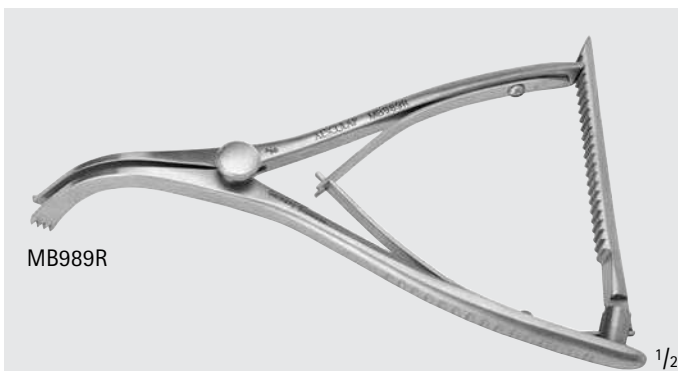

MB989R

1/2

INGE Lamina Spreader

Catalog Number	Tip	Length (in.)
MB989R	TOOTHED	6 1/2



INGE Lamina Spreader

Catalog Number	Tip	Tip Size (mm)	Length (in.)
BV297R	SERR	6.0	6 3/4

BV297R

1/2

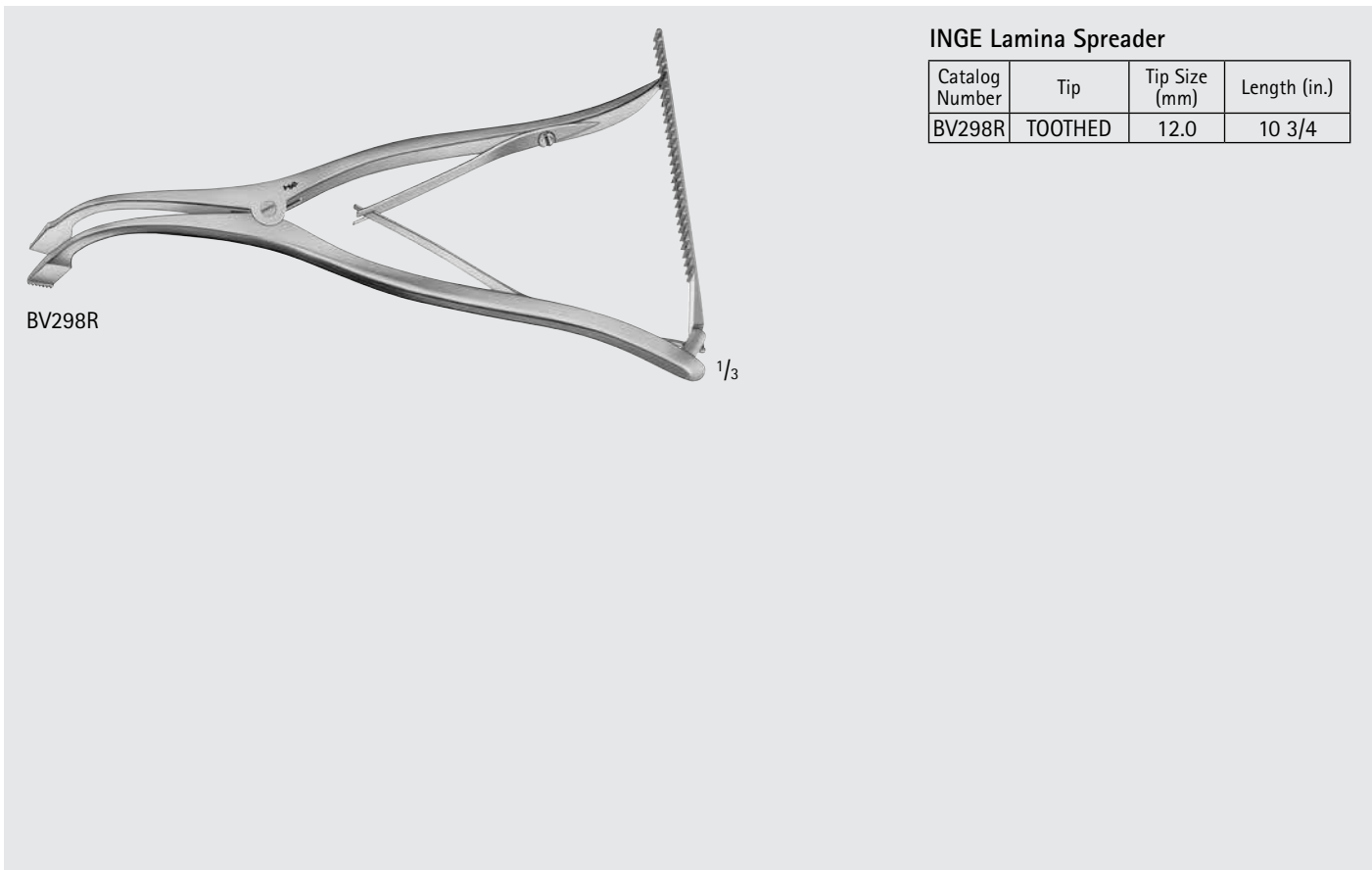

INGE Lamina Spreader

Catalog Number	Tip	Tip Size (mm)	Length (in.)
BV298R	TOOTHED	12.0	10 3/4

BV298R

1/3



ORTHO
SPINE

INCHES

Orthopedics/Spine

Retractors

Aesculap Ball Snap System on Spreader and Blades

Advantages:

- Blades are safely locked without additional fixation, preventing them from detaching when the instrument is passed to the surgeon. In addition, the smooth surface minimizes the risk of catching a suture.
- Blades can be quickly exchanged during the operation.
- Different retractor patterns can be combined and exchanged at random, which allows for optimum selection of the blade size according to surgical needs.

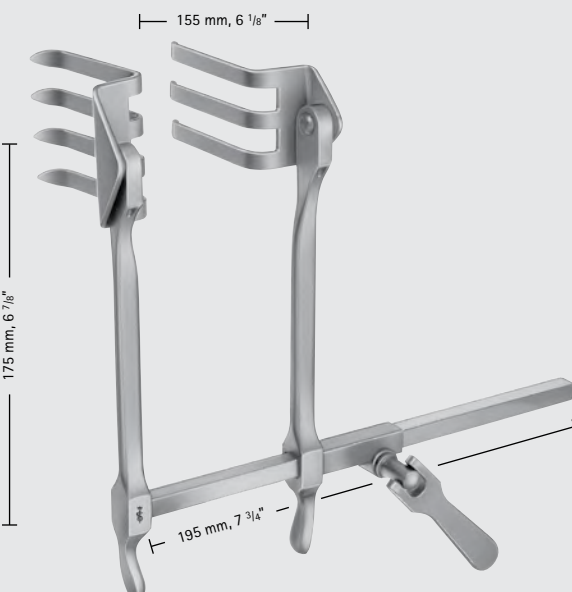

155 mm, 6 1/8"

175 mm, 6 7/8"

195 mm, 7 3/4"

SCOVILLE-RICHTER Laminectomy Retractor, Reversible

Catalog Number	Description
BV510R	COMPLETE

BV510R Includes:
 1 Retractor BV509R and
 1 Pair of blades BV516R
 The retractor bar and shanks rotate 180°

BV510R

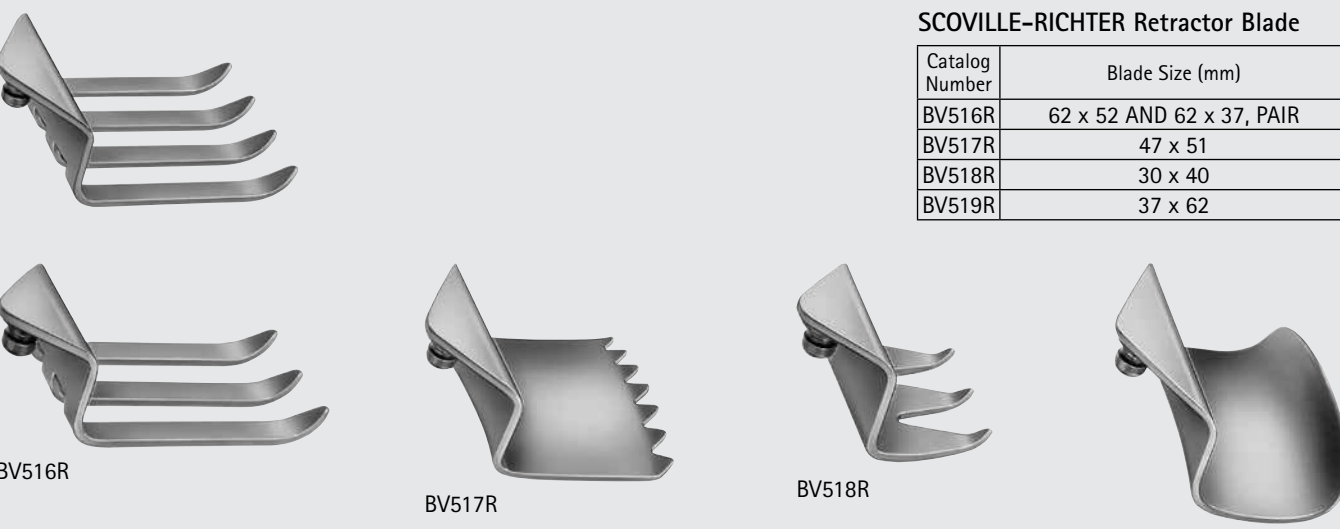

SCOVILLE-RICHTER Retractor Blade

Catalog Number	Blade Size (mm)
BV516R	62 x 52 AND 62 x 37, PAIR
BV517R	47 x 51
BV518R	30 x 40
BV519R	37 x 62

BV516R

BV517R

BV518R

BV519R

- Complete retraction system consisting of a retractor body, various blade configurations, and storage tray. Designed to enable less invasive spine procedures such as discectomies and decompressions.
 - Unique organization system enables easy storage and retrieval of desired blade.
 - Sturdy design provides rigid retraction even at large opening widths.
- All retractor components are titanium. Blade designs improve visualization and intra-operative imaging.

For more information see our brochure number DOC658.

MF393 Includes:

- 1 Hinged Titanium Retractor Frame MF365T
- 2 Wide Blades, 40 mm MF368T
- 2 Wide Blades, 50 mm MF369T
- 2 Wide Blades, 60 mm MF370T
- 2 Wide Blades, 70 mm MF371T
- 2 Narrow Blades, 40 mm MF375T
- 2 Narrow Blades, 50 mm MF376T
- 2 Narrow Blades, 60 mm MF377T
- 2 Narrow Blades, 70 mm MF378T
- 1 Storage Tray MF392
- 1 Hook Blade, 30 mm MF381T
- 1 Hook Blade, 40 mm MF382T
- 1 Hook Blade, 50 mm MF383T
- 1 Hook Blade, 60 mm MF384T
- 1 Toothed Blade, 30 mm MF387T
- 1 Toothed Blade, 40 mm MF388T
- 1 Toothed Blade, 50 mm MF389T
- 1 Toothed Blade, 60 mm MF390T

Spine Retractor System

Catalog Number
MF393

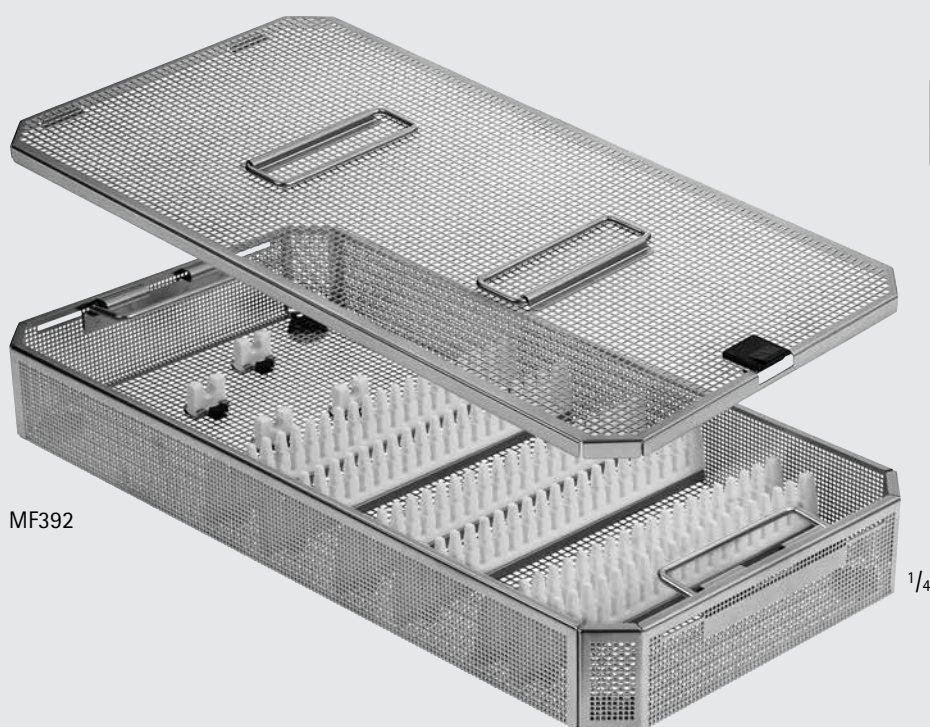

MF392

Storage Tray for Spine Retractor System

Catalog Number
MF392

The storage tray will fit into Aesculap's full size container for sterilization.

For more information about Aesculap's SterilContainter System see our brochure number DOC132.



Orthopedics/Spine

Retractors

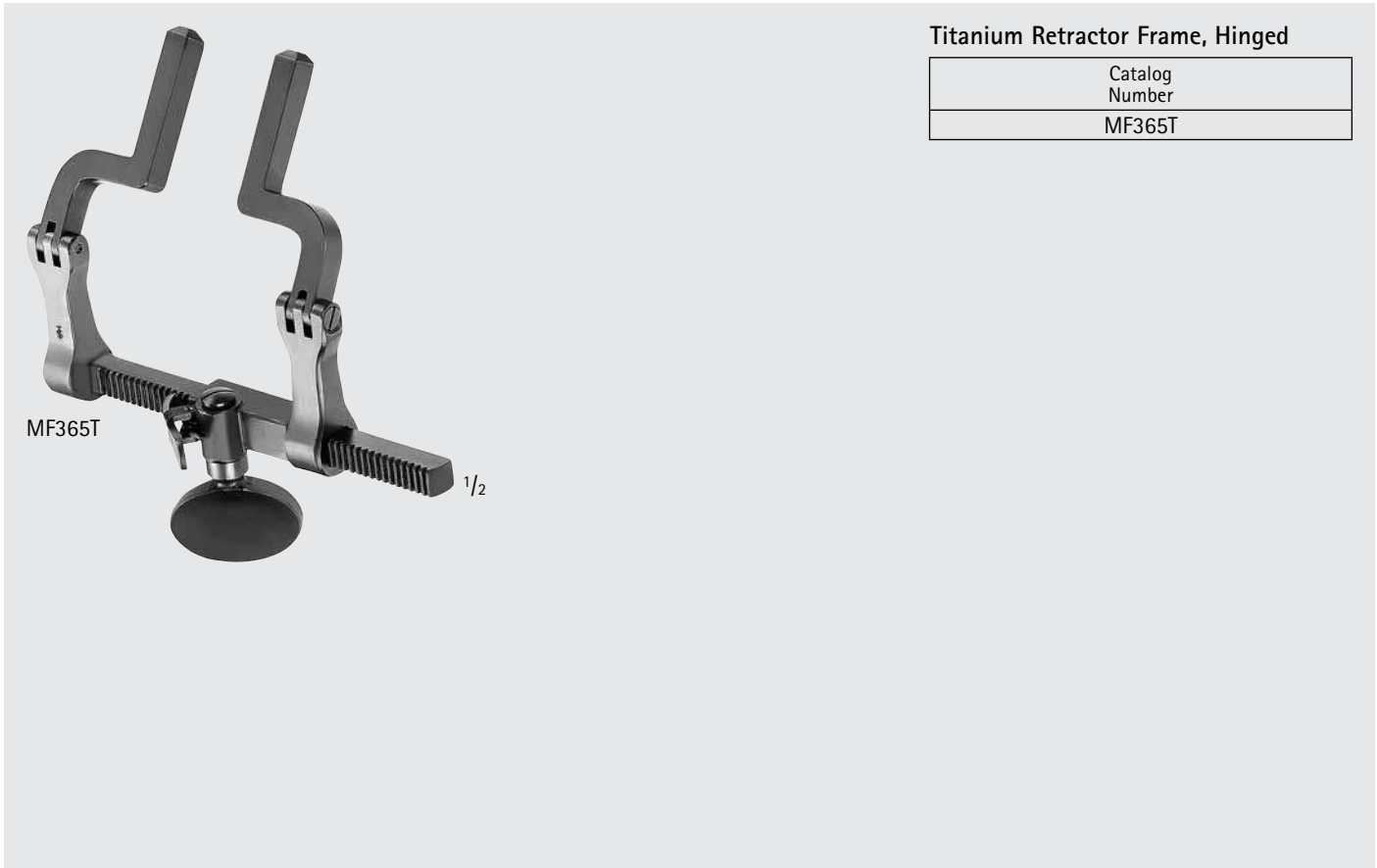

Titanium Retractor Frame, Hinged

Catalog Number
MF365T



Titanium Retractor Frame, Rigid

Catalog Number
MF366T



MF367T-MF373T

Titanium Retractor Blade, Wide

Catalog Number	Blade Size (mm)
MF367T	27 x 30
MF368T	27 x 40
MF369T	27 x 50
MF370T	27 x 60
MF371T	27 x 70
MF372T	27 x 80
MF373T	27 x 90



MF374T-MF380T

Titanium Retractor Blade, Narrow

Catalog Number	Blade Size (mm)
MF374T	20 x 30
MF375T	20 x 40
MF376T	20 x 50
MF377T	20 x 60
MF378T	20 x 70
MF379T	20 x 80
MF380T	20 x 90

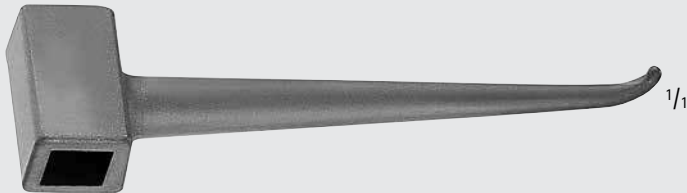

MF381T-MF386T

Titanium Retractor Hook

Catalog Number	Length (mm)
MF381T	30
MF382T	40
MF383T	50
MF384T	60
MF385T	70
MF386T	80



MF387T-MF391T

Titanium Toothed Blades

Catalog Number	Length (mm)
MF387T	30
MF388T	40
MF389T	50
MF390T	60
MF391T	70



ORTHO
SPINE

INCHES

CHARNLEY Initial Incision Retractor

Catalog Number	Description	Blade	Size	Blade Size (mm)
MB191R	SET COMPLETE	-	-	-
MB156R	INDIVIDUAL BLADE	SMALL	STANDARD DEPTH	25 x 38
MB177R	INDIVIDUAL BLADE	SMALL	MEDIUM DEPTH	25 x 75
MB192R	INDIVIDUAL BLADE	SMALL	LONG DEPTH	25 x 127
MB157R	INDIVIDUAL BLADE	LARGE	STANDARD DEPTH	25 x 44
MB178R	INDIVIDUAL BLADE	LARGE	MEDIUM DEPTH	25 x 75
MB193R	INDIVIDUAL BLADE	LARGE	LONG DEPTH	25 x 127
MG081R	WEIGHT AND CHAIN REPLACEMENT FOR MB191R	-	-	-

MB191R includes:

- 1 frame
- 1 small retractor blade (MB156R)
- 1 large retractor blade (MB157R)
- 1 weight w/ chain (3 lbs.)

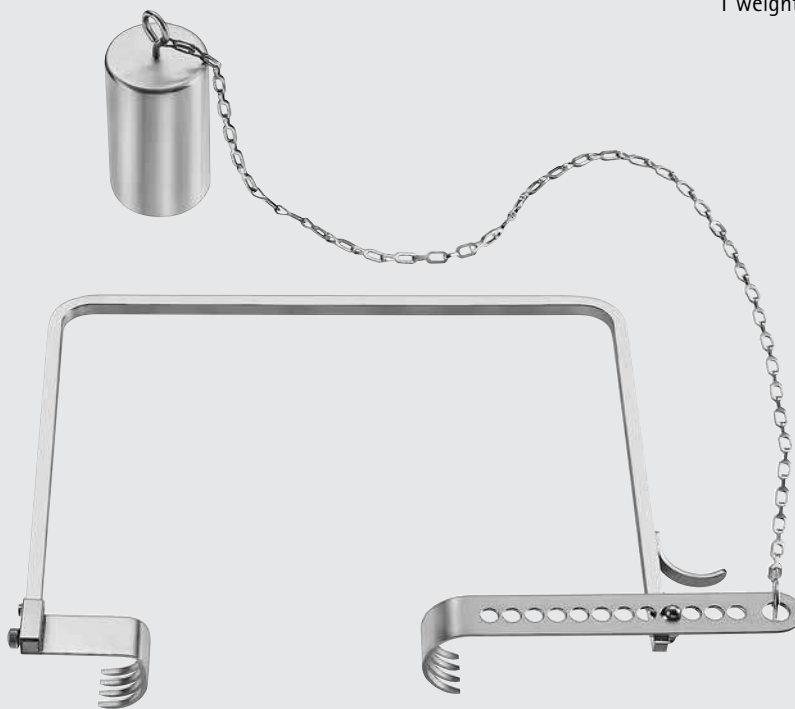

MB191R-MG081R





FK507R

Bone File/Rasp

Catalog Number	Tip Size (mm)	Length (in.)
FK507R	20	8 3/4

One Side File Cut
One Side Rasp Cut



FK507R

Bone File

Catalog Number	Tip Size (mm)	Length (in.)
FK511R	13	9 1/2
FK510R	20	11 5/8



FK511R

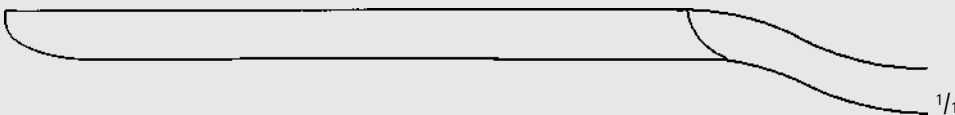

FK511R



FK510R



Orthopedics/Spine

Rasps



DUROGRIP™ TC FOMON Rasp, Double Ended

Catalog Number	Size	Teeth	Length (in.)
OL423R	3 + 4	16/20	8 1/4
OL425R	5 + 6	24/30	8 1/4
OL427R	7 + 8	36/44	8 1/4
OL429R	9 + 10	52/44	8 1/4

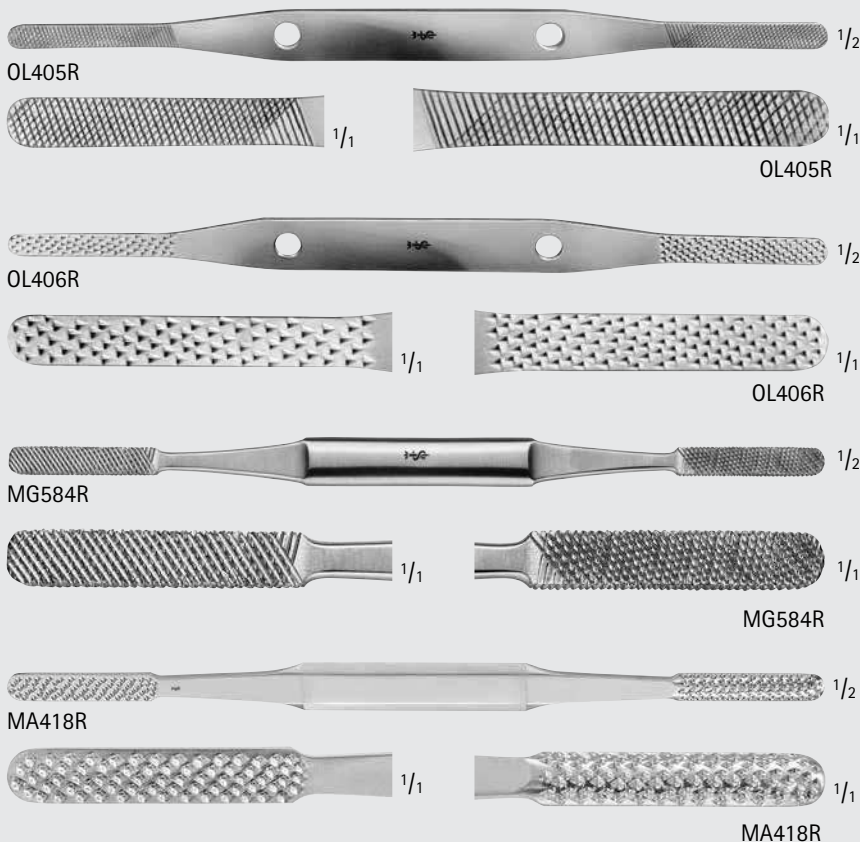
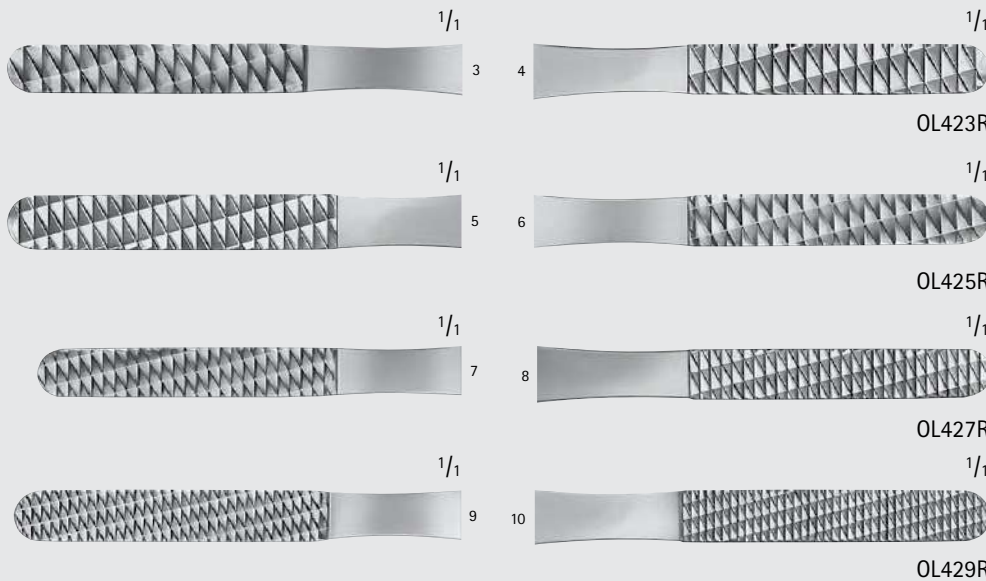

FOMON Bone Rasp, Double Ended

Catalog Number	Tip Size (mm)	Tip	Length (in.)
OL405R	6.5 / 7.5	X-SERR Fine/Coarse	8 1/2
OL406R	6.5 / 7.5	Fine/Coarse	8 1/2
MG584R	8/8	FLAT, CONVEX FINE, COARSE	8 1/2
MA418R	7.5 / 7.5	Coarse/ Xtra-Coarse	8 3/8

MALTZ Bone Rasp

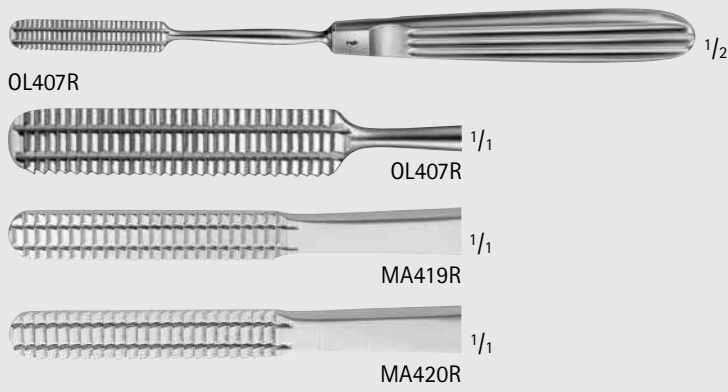

Catalog Number	Tip Size (mm)	Tip	Length (in.)
OL407R	9	DOWN-STROKE	6 1/2
MA419R	33	DOWN-STROKE	6 1/2
MA420R	33	UP STROKE	6 1/2

LEWIS Bone Rasp

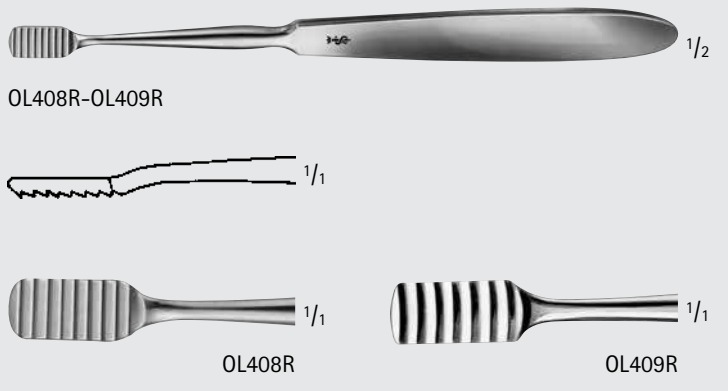

Catalog Number	Tip	Tip Size (mm)	Length (in.)
OL408R	FINE-SERR DOWN-STROKE	8	6 7/8
OL409R	COARSE-SERR DOWN-STROKE	8	6 7/8

Bone Raspatory

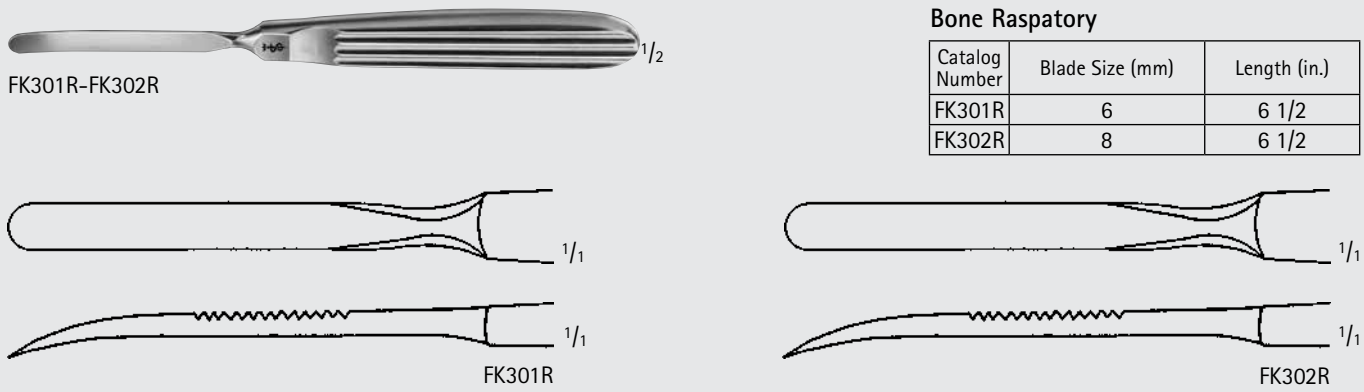

Catalog Number	Blade Size (mm)	Length (in.)
FK301R	6	6 1/2
FK302R	8	6 1/2

PUTTI Bone File, Double Ended

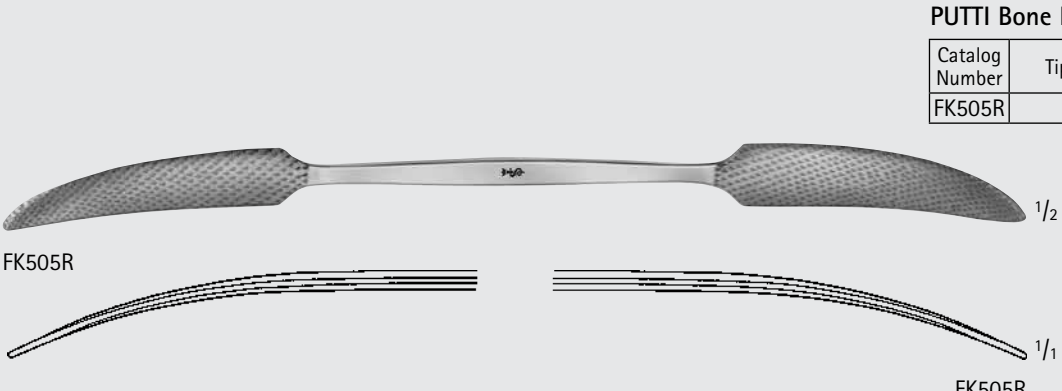

Catalog Number	Tip Size (mm)	Length (in.)
FK505R	18/20	10 5/8



Orthopedics/Spine

Elevators and Bone Levers



MB816R-MB817R

SAYRE Periosteal Elevator

Catalog Number	Tip	Length (in.)
MB816R	SHARP	6 3/4
MB817R	BLUNT	6 3/4

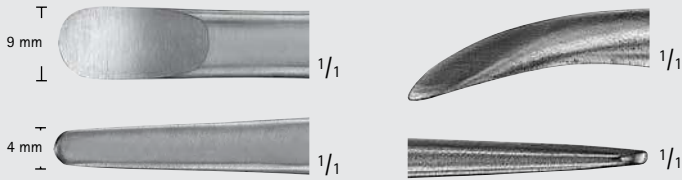

MB816R-MB817R



FK300R

WILLIGER Bone Elevator

Catalog Number	Blade Size (mm)	Length (in.)
FK300R	6	6 1/4



FK300R



FK306R-FK309R

ADSON Elevator

Catalog Number	Tip	Blade Size (mm)	Blade	Length (in.)
FK306R	SHARP	8	STR	6 3/4
FK308R	SEMI-S	7	STR	6 3/4
FK307R	BLUNT	7	CVD	6 3/4
FK309R	SHARP	7	CVD	6 3/4

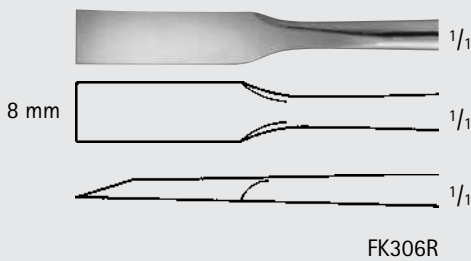

FK306R

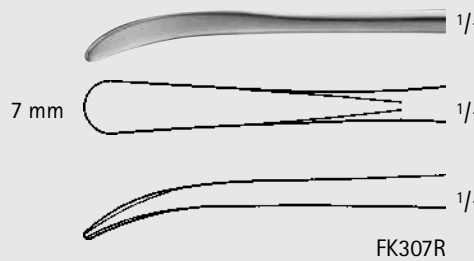

FK307R

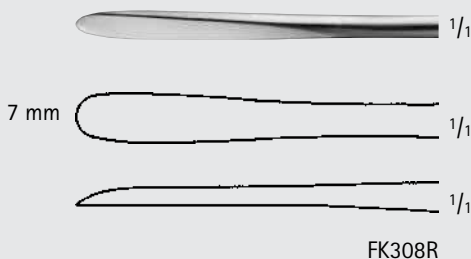

FK308R

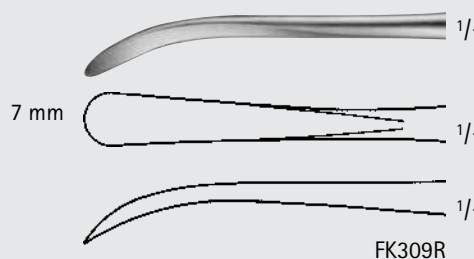

FK309R



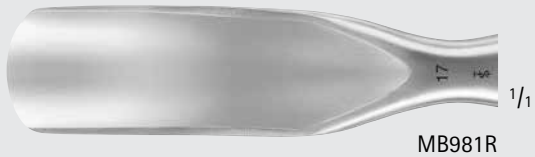
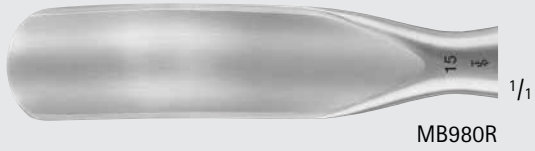

MCGLAMRY Metatarsal Elevators

Catalog Number	Blade Size (mm)	Length (in.)
MB978R	11	6 1/2
MB979R	13	6 1/2
MB980R	15	6 1/2
MB981R	17	6 1/2



Orthopedics/Spine

Elevators and Bone Levers



FK323R

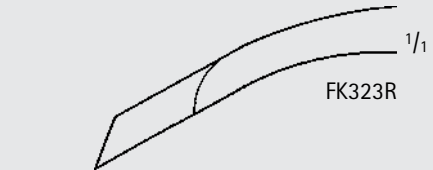
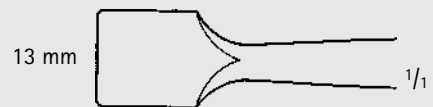

Elevator W/ PEEK Handle

Catalog Number	Tip	Blade Size (mm)	Blade	Length (in.)
FK323R	SHARP	13	CVD	6 7/8



FK324R

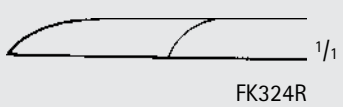

Elevator W/ PEEK Handle

Catalog Number	Tip	Blade Size (mm)	Blade	Length (in.)
FK324R	SHARP	14	STR	7 1/2



FK325R



Elevator W/ PEEK Handle

Catalog Number	Tip	Blade Size (mm)	Blade	Length (in.)
FK325R	SHARP	14	CVD	7

LANGENBECK Periosteal Elevator

Catalog Number	Blade Size (mm)	Blade	Length (in.)
FK360R	16	STR	7 1/2
MB279R	17	7 3/4	

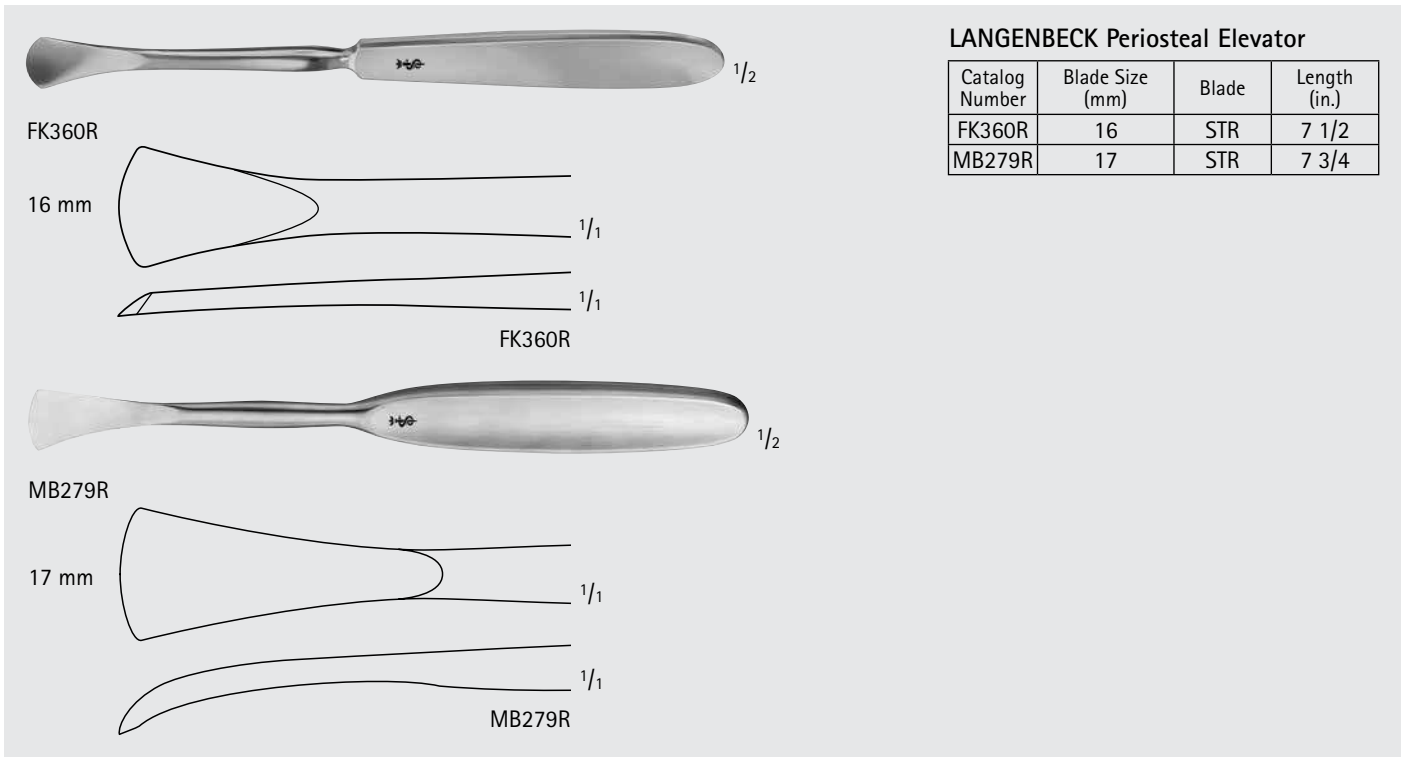

SEDILLOT Elevator

Catalog Number	Blade Size (mm)	Blade	Length (in.)
FK350R	18	STR	7 1/4
FK351R	15	CVD	8 1/2

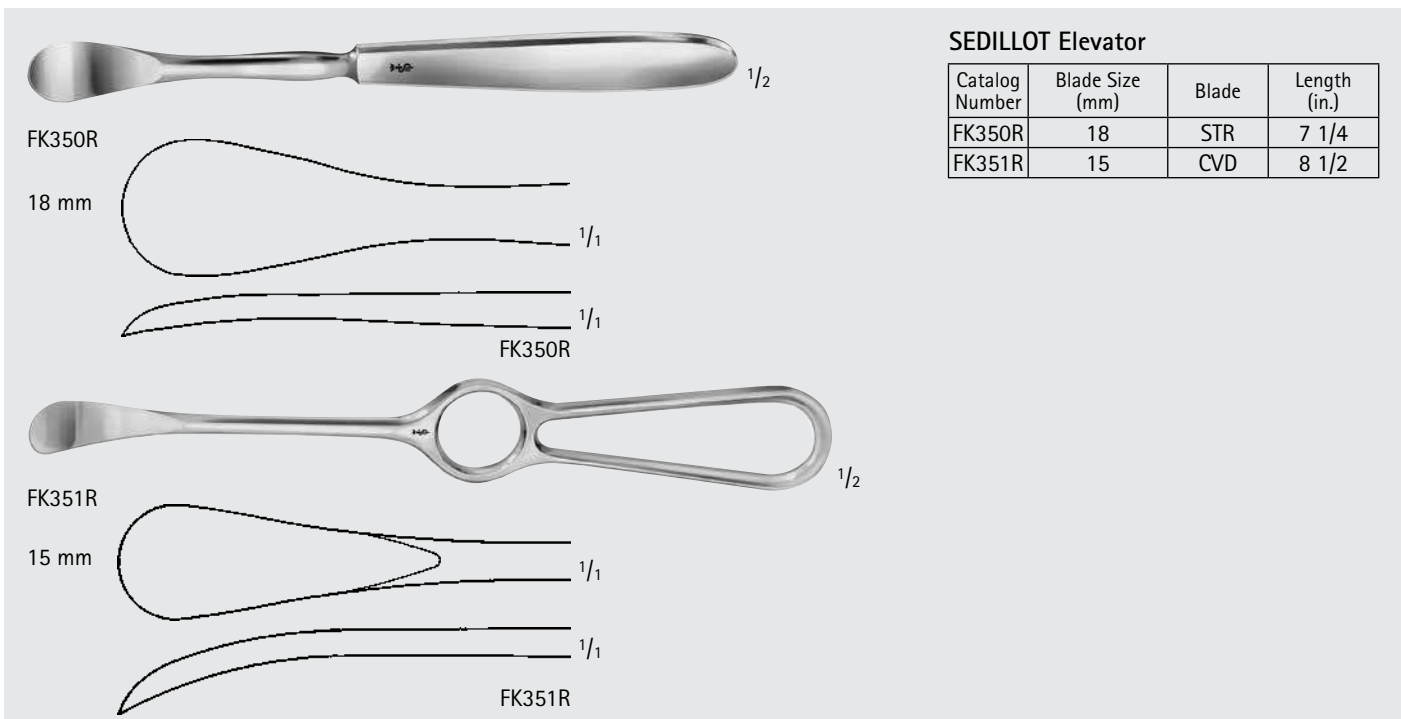

KEY Periosteal Elevator

Catalog Number	Blade Size (mm)	Length (in.)
MB536R	3.1	6 3/4

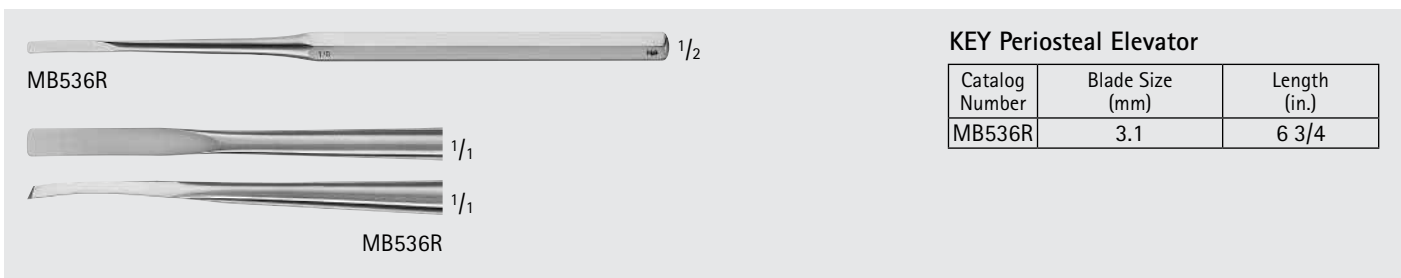

Orthopedics/Spine

Elevators and Bone Levers



FK410R-FK414R

KEY Elevator

Catalog Number	Blade Size (mm)	Blade	Length (in.)
FK410R	6.4	STR	7
FK411R	9.5	STR	7 1/2
FK412R	12.7	STR	7 1/2
FK413R	19	STR	7 7/8
FK414R	25.4	STR	8 1/4



MG024R

COBB Elevator, Round

Catalog Number	Blade Size (mm)	Blade	Length (in.)
MG024R	19	CVD	9 1/2

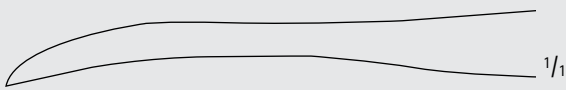
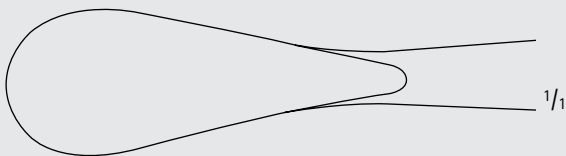

MG024R



COBB Elevator, Sharp

Catalog Number	Blade Size (mm)	Blade	Length (in.)
FK146R	10	CVD	11
FK147R	13	CVD	11
FK148R	19	CVD	11



FK146R-FK148R



10 mm

FK146R



13 mm

FK147R

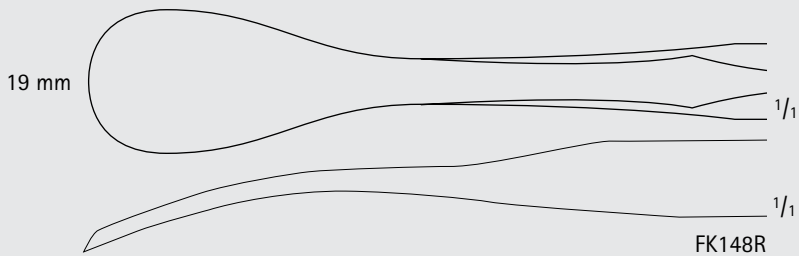

19 mm

FK148R

COBB Periosteal Elevator, Round

Catalog Number	Blade Size (mm)	Blade	Length (in.)
MB518R	7	CVD	12



MB518R



7 mm

1/11



1/11

MB518R



Orthopedics/Spine

Elevators and Bone Levers



COBB Elevator

Catalog Number	Blade Size (mm)	Blade	Length (in.)
MD645	10	ROUND	11
MD646	13	ROUND	11
MD647	19	ROUND	11
MD648	26	ROUND	11
MD649	32	ROUND	11



MD645-MD649

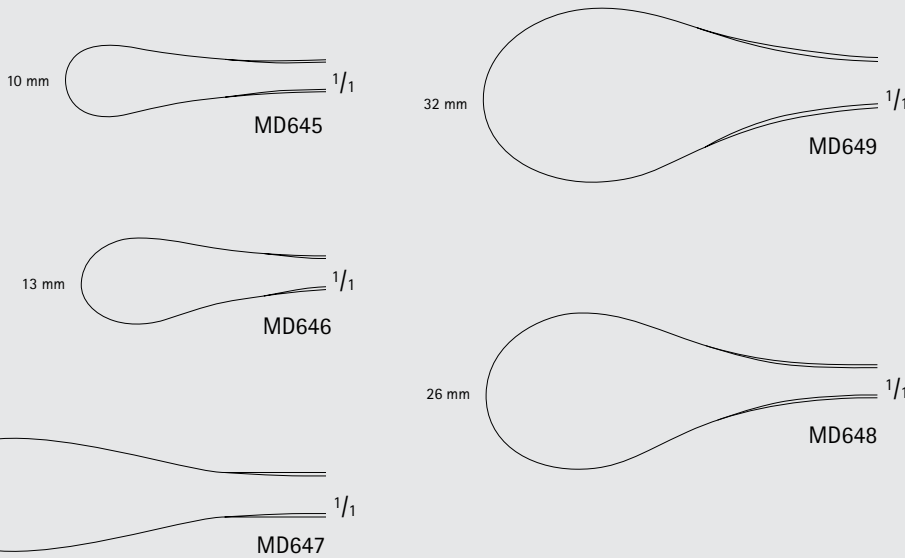

Elevator W/ PEEK Handle

Catalog Number	Blade Size (mm)	Blade	Length (in.)
FK348R	20	CVD	11 1/2



FK348R

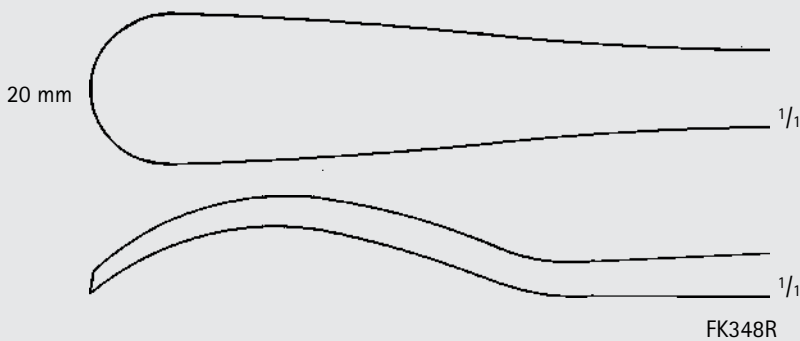

WAGNER Elevator W/ PEEK Handle

Catalog Number	Blade Size (mm)	Blade	Length (in.)
FK352R	8	CVD	13
FK353R	17	CVD	13



FK352R-FK353R

1/2

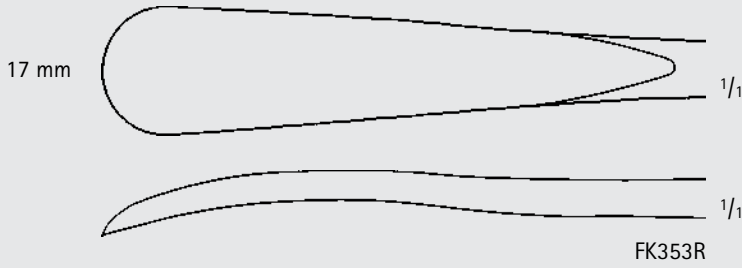
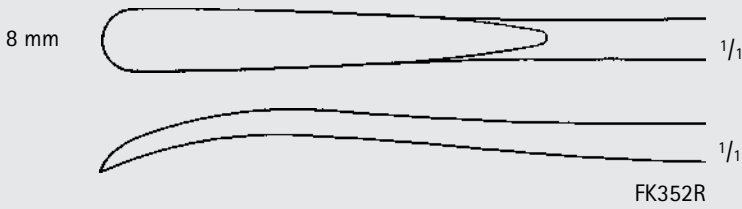

ORTHO
SPINE

INCHES

Orthopedics/Spine

Elevators and Bone Levers



MN001R-MN006R

1/3

Black Handled Elevator

Catalog Number	Tip Size (mm)	Handle	Length (in.)
MN001R	10	8 1/2	13 1/4
MN002R	15	8 1/2	13 1/4
MN003R	20	8 1/2	13 1/4
MN004R	25	8 1/2	13 1/4
MN005R	30	8 1/2	13 1/4
MN006R	35	8 1/2	13 1/4
MN007R	9	9	15
MN008R	13	9	15
MN009R	19	9	15
MN010R	25	9	15
MN011R	32	9	15

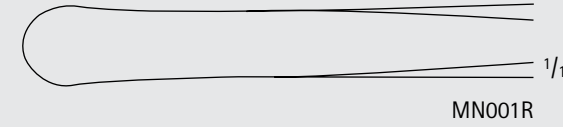

MN001R

1/1

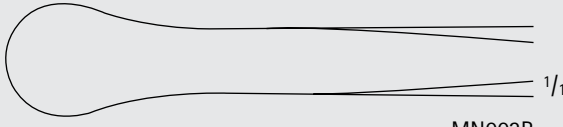

MN002R

1/1

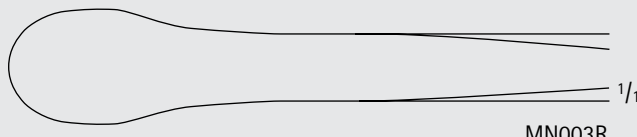

MN003R

1/1

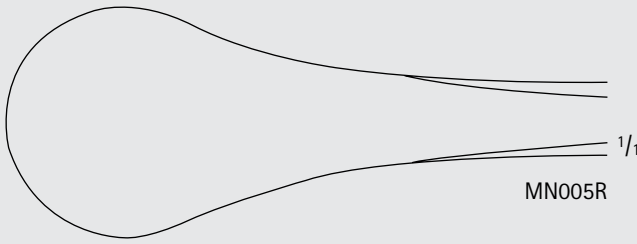

MN005R

1/1

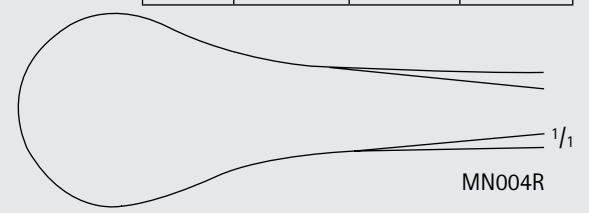

MN004R

1/1

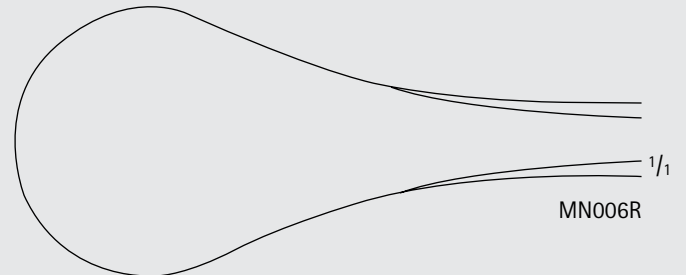

MN006R

1/1



MN007R-MN011R

1/3

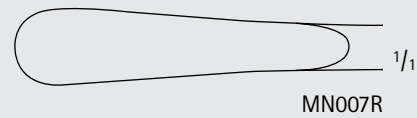

MN007R

1/1

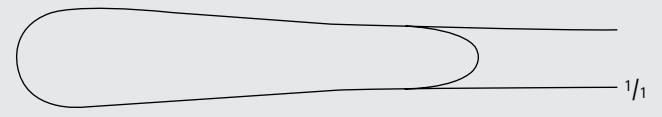

MN008R

1/1

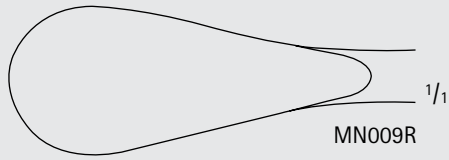

MN009R

1/1

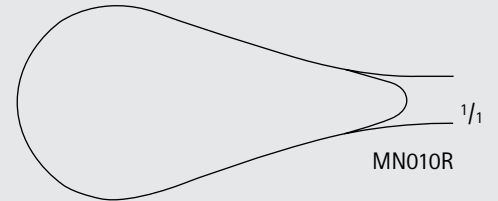

MN010R

1/1

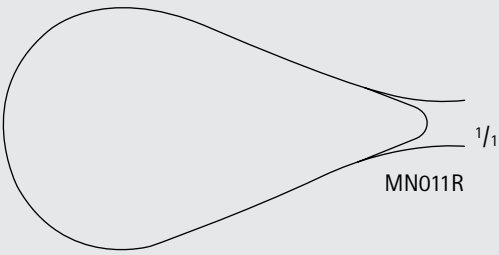

MN011R

1/1



FK120R

1/2



5 mm

1/1

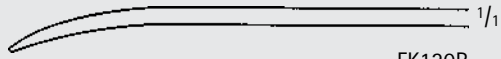

1/1

FK120R



FK121R

1/2



5.5 mm

1/1

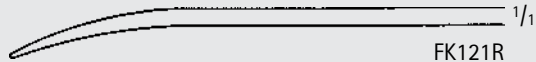

1/1

FK121R

WILLIGER Elevator

Catalog Number	Blade Size (mm)	Blade	Length (in.)
FK120R	5	CVD	6 1/2
FK121R	5.5	CVD	6 3/4



FK124R

1/2

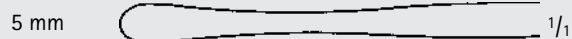

5 mm

1/1

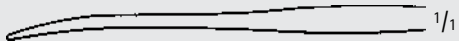

1/1

FK124R

SEBILEAU Elevator

Catalog Number	Blade Size (mm)	Blade	Length (in.)
FK124R	5	CVD	6 7/8



ORTHOSpine

INCHES

Orthopedics/Spine

Elevators and Bone Levers



LANGENBECK Elevator

Catalog Number	Blade Size (mm)	Blade	Length (in.)
FK130R	8	CVD	7 3/4
FK131R	10	CVD	7 3/4
FK139R	11	CVD	9

FK130R-FK131R

8 mm $\frac{1}{1}$ 10 mm $\frac{1}{1}$

FK130R FK131R

FK139R $\frac{1}{2}$

11 mm $\frac{1}{1}$ FK139R $\frac{1}{1}$

QUERVAIN Elevator, Joker

Catalog Number	Blade Size (mm)	Blade	Length (in.)
FK133R	6	CVD	7 3/4

FK133R $\frac{1}{2}$

6 mm $\frac{1}{1}$

FK133R $\frac{1}{1}$

LANE TRETHOWAN Bone Lever

Catalog Number	Blade	Length (in.)
FK135R	CVD	8 1/2

FK135R $\frac{1}{2}$

FK135R $\frac{1}{1}$

LANE Bone Lever

Catalog Number	Blade	Length (in.)
FK136R	CVD	10

FK136R $\frac{1}{2}$

FK136R $\frac{1}{1}$

CREGO Elevator

Catalog Number	Tip	Blade Size (mm)	Blade	Length (in.)
MB818R	BLUNT	6.5	CVD	8
MB819R	BLUNT	7.1	CVD	8
MB820R	BLUNT	14.6	CVD	8





MB818R-MB820R $\frac{1}{2}$

6.5 mm  $\frac{1}{1}$

 $\frac{1}{1}$
MB818R

7.1 mm  $\frac{1}{1}$

 $\frac{1}{1}$
MB819R

14.6 mm  $\frac{1}{1}$

 $\frac{1}{1}$
MB820R

BRISTOW Bone Lever

Catalog Number	Length (in.)
FK140R	5 3/4

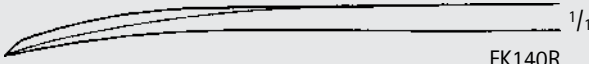

FK140R $\frac{1}{2}$

 $\frac{1}{1}$
FK140R



Orthopedics/Spine
Elevators and Bone Levers

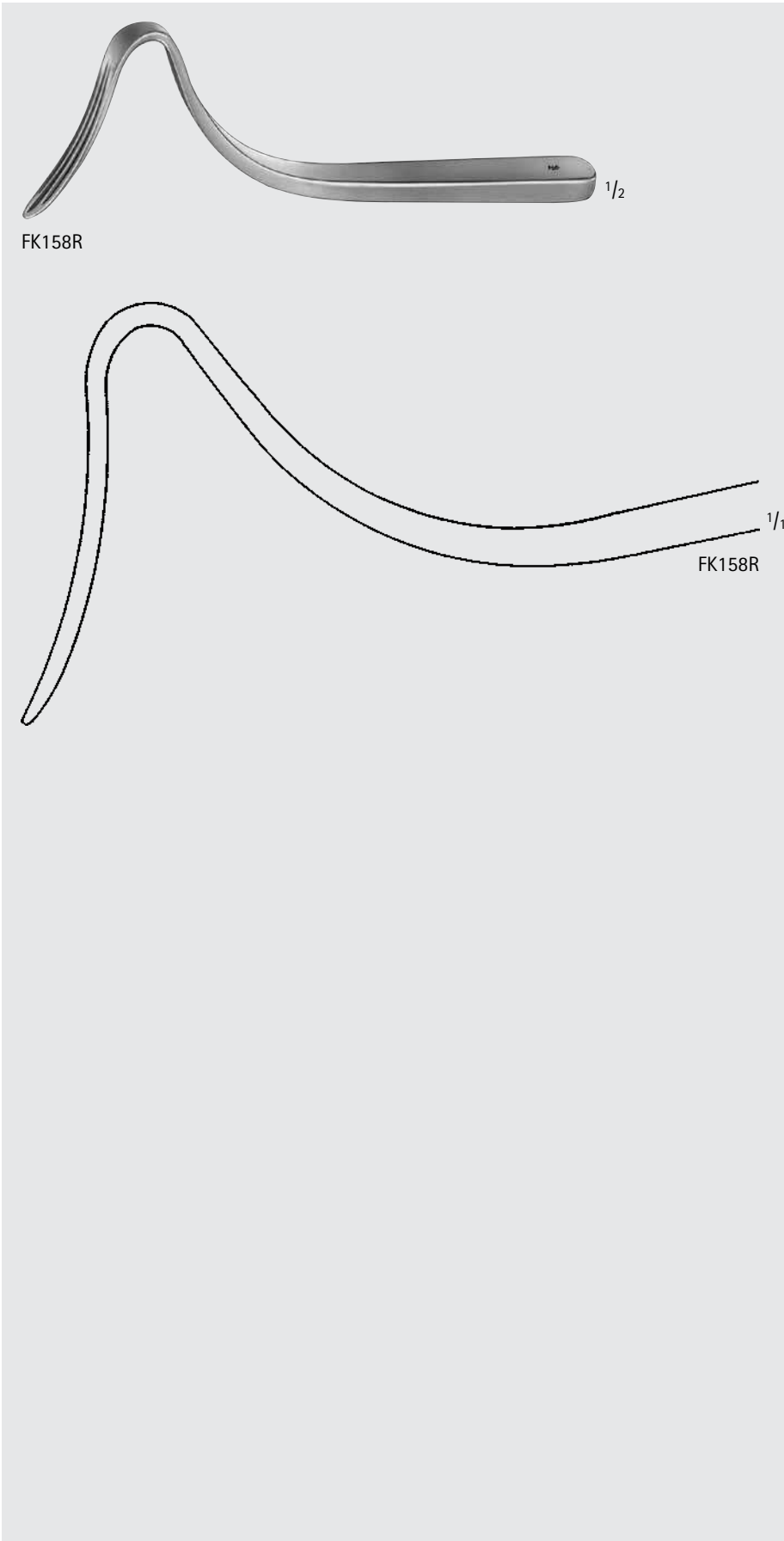

TAEGER Bone Lever F/ Angle Joint
Operations

Catalog Number	Blade Size (mm)	Blade	Length (in.)
FK158R	12	CVD	6 7/8

CHANDLER Bone Elevator

Catalog Number	Blade Size (mm)	Blade	Length (in.)
MB275R	14	SMALL	7 1/4
MB276R	19	MEDIUM	8
MB277R	25	LARGE	9 1/4
MB278R	30	EXTRA LARGE	10



MB275R-MB278R

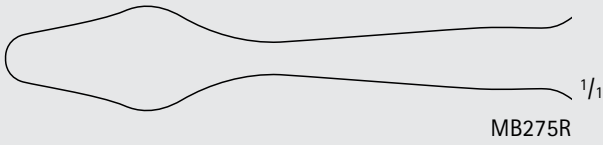

MB275R

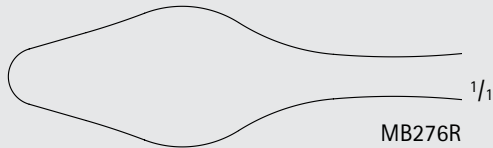

MB276R

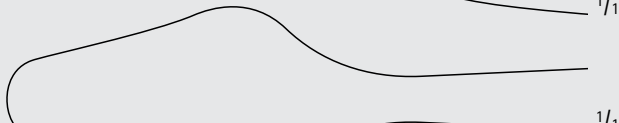

MB277R

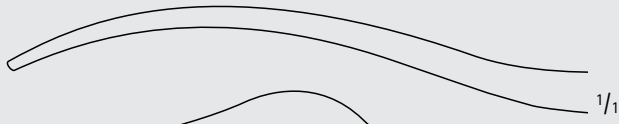

MB278R



Orthopedics/Spine

Chisels, Gouges and Osteotomes



HIBBS Chisel

Catalog Number	Tip Size (mm)	Blade	Length (in.)
MB850R	7	STR	9 1/2
MB991R	10	STR	9 1/2
MB851R	15	STR	9 1/2
MB852R	19	STR	9 1/2
MB853R	22	STR	9 1/2
MB854R	25	STR	9 1/2
MB855R	38	STR	9 1/2
MB856R	7	CVD	9 1/2
MB857R	9	CVD	9 1/2
MB992R	13	CVD	9 1/2
MB858R	15	CVD	9 1/2
MB859R	19	CVD	9 1/2
MB993R	22	CVD	9 1/2
MB994R	25	CVD	9 1/2
MB995R	32	CVD	9 1/2
MB996R	38	CVD	9 1/2



STILLE Chisel

Catalog Number	Tip Size (mm)	Length (in.)
FL503R	10	8
FL504R	12	8
FL505R	15	8
FL506R	20	8
FL507R	25	8

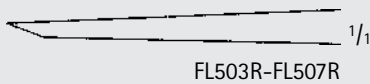

Chisel Handle F/ Interchangeable Blades

Catalog Number	Item
FL665R	HANDLE W/KEY
GB020R	REPLACEMENT KEY

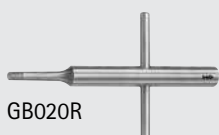

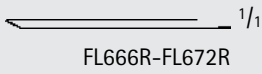

Chisel Blade, F/FL665R

Catalog Number	Tip Size (mm)	Tip Size (in.)	Working Length (mm)
FL666R	5	3/16	45
FL668R	10	3/8	45
FL670R	16	5/8	45
FL672R	25	1	45



FL682R

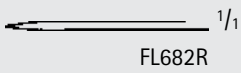

Osteotome Blade, F/FL665R

Catalog Number	Tip Size (mm)	Tip Size (in.)	Working Length (mm)
FL682R	25	1	78



FL685R-FL687R

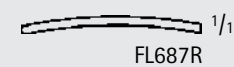
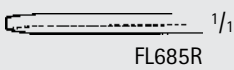
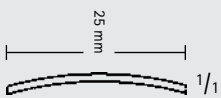

Concave Chisel Blade, F/FL665R

Catalog Number	Radius (mm)	Tip Size (mm)	Tip Size (in.)
FL685R	50	25	1
FL687R	70	25	1



ORTHO
SPINE

INCHES

Orthopedics/Spine

Chisels, Gouges and Osteotomes



Lamina Gouge W/ HARTPRESS Handle

Catalog Number	Tip Size (mm)	Tip Size (in.)	Length (in.)
FL437R	6	1/4	9 1/4
FL438R	8	5/16	9 1/4
FL439R	11	7/16	9 1/4
FL440R	16	5/8	9 1/4



FL437R-FL440R

1/2

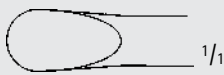

FL437R-FL440R

1/1

Chisel W/ PEEK Handle

Catalog Number	Tip Size (mm)	Tip Size (in.)	Length (in.)
FL430R	20	3/4	9 5/8



FL430R

1/2

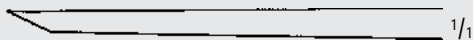

FL430R

1/1

LEXER-MINI Gouge W/ PEEK Handle

Catalog Number	Tip Size (mm)	Tip Size (in.)	Length (in.)
FL390R	4	5/32	7
FL391R	6	1/4	7
FL392R	8	5/16	7
FL393R	10	3/8	7
FL394R	12	1/2	7



FL390R-FL394R

1/2

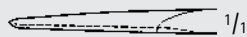

FL390R-FL394R

1/1

LEXER Gouge W/ PEEK Handle



FL411R-FL418R 1/2

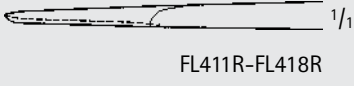

FL411R-FL418R 1/1

Catalog Number	Tip Size (mm)	Tip Size (in.)	Length (in.)
FL411R	5	3/16	8 7/8
FL412R	7	9/32	8 7/8
FL413R	10	3/8	8 7/8
FL415R	15	5/8	8 7/8
FL416R	20	3/4	8 7/8
FL417R	25	1	8 7/8
FL418R	30	1 3/16	8 7/8

Gouge, F/ Removing Broken Screws, W/ PEEK Handle



FL420R 1/2

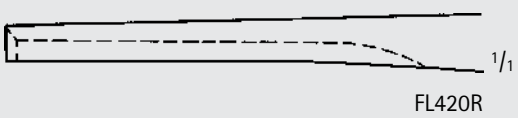

FL420R 1/1

Catalog Number	Tip Size (mm)	Tip Size (in.)	Length (in.)
FL420R	9	3/8	8 7/8

LEXER Spongiosa Gouge W/ PEEK Handle



FL423R 1/2

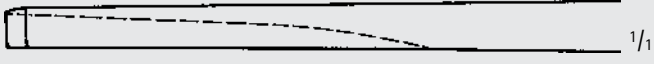

FL423R 1/1



FL423R 1/1



FL423R 1/1

Catalog Number	Tip Size (mm)	Tip Size (in.)	Length (in.)
FL423R	10	3/8	11



Orthopedics/Spine

Chisels, Gouges and Osteotomes



ZIELKE Gouge W/ PEEK Handle

Catalog Number	Tip Size (mm)	Tip Size (in.)	Length (in.)
FL701R	5.5	7/32	9
FL702R	9	3/8	9

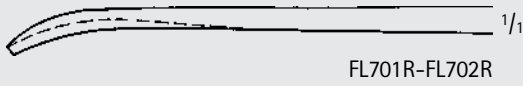

Spongiosa Gouge W/ PEEK Handle

Catalog Number	Tip Size (mm)	Tip Size (in.)	Blade	Length (in.)
FL441R	5	3/16	CVD	9 3/4
FL443R	10	3/8	CVD	9 3/4
FL445R	15	5/8	CVD	9 3/4

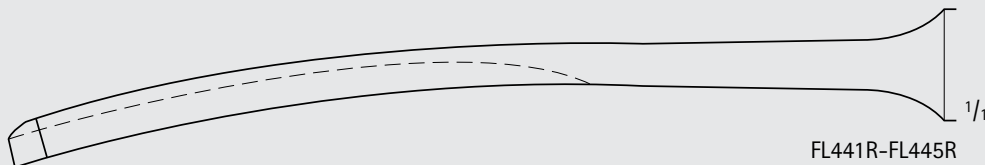

STILLE Gouge

Catalog Number	Tip Size (mm)	Tip Size (in.)	Length (in.)
FL573R	10	3/8	8
FL574R	12	1/2	8
FL575R	15	5/8	8
FL576R	20	3/4	8
FL577R	25	1	8

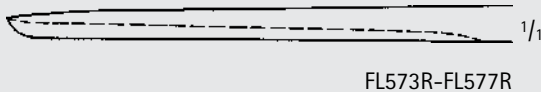

WAGNER Gouge W/ PEEK Handle

Catalog Number	Tip Size (mm)	Tip Size (in.)	Blade Shape	Length (in.)
ND120R	9	3/8	ANG FWD	13 3/8
ND121R	9	3/8	ANG BACK	13 3/8
ND122R	15	5/8	ANG FWD	13 3/8
ND123R	15	5/8	ANG BACK	13 3/8
ND124R	9	3/8	STR	13 3/8
ND125R	15	5/8	STR	13 3/8



ND120R-ND125R

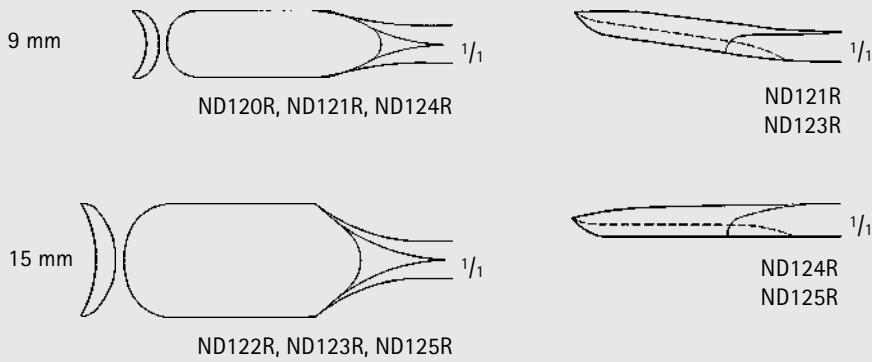

SMITH-PETERSON Gouge

Catalog Number	Tip	Tip Size (mm)	Length (in.)
MF465R	STR	6	8
MF466R	STR	10	8
MF467R	STR	13	8
MF468R	STR	16	8
MF469R	STR	19	8
MF470R	STR	25	8
MF471R	STR	32	8
MF472R	CVD	6	8
MF473R	CVD	10	8
MF474R	CVD	13	8
MF475R	CVD	16	8
MF476R	CVD	19	8
MF477R	CVD	25	8
MF478R	CVD	32	8



MF465R-MF478R



Orthopedics/Spine

Chisels, Gouges and Osteotomes



FL380R-FL384R

1/2



FL380R-FL384R

1/1

LEXER-MINI Osteotome W/ PEEK Handle

Catalog Number	Tip Size (mm)	Tip Size (in.)	Length (in.)
FL380R	4	5/32	7
FL381R	6	1/4	7
FL382R	8	5/16	7
FL383R	10	3/8	7
FL384R	12	1/2	7



FL401R-FL408R

1/2

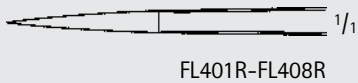

FL401R-FL408R

1/1

LEXER Osteotome W/ PEEK Handle

Catalog Number	Tip Size (mm)	Tip Size (in.)	Length (in.)
FL401R	5	3/16	8 7/8
FL402R	7	9/32	8 7/8
FL403R	10	3/8	8 7/8
FL405R	15	5/8	8 7/8
FL406R	20	3/4	8 7/8
FL407R	25	1	8 7/8
FL408R	30	1 3/16	8 7/8
ND108R	10	3/8	10 3/4
ND109R	15	5/8	10 3/4



ND108R-ND109R

1/2

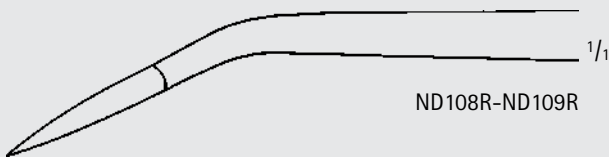

ND108R-ND109R

1/1

Chisel W/ PEEK Handle

Catalog Number	Tip Size (mm)	Tip Size (in.)	Length (in.)
ND105R	16	5/8	10 1/2



ND105R

1/2

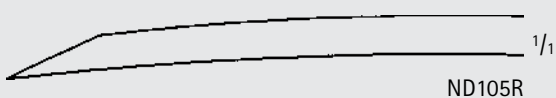

ND105R

1/1



COBB Gouge

Catalog Number	Blade	Length (in.)
MB707R	STR	11 1/2



MB707R



MB707R

Gouge, Double Curved, W/ HARTPRESS Handle

Catalog Number	Tip Size (mm)	Tip Size (in.)	Length (in.)
ND118R	25	1	11 1/4



ND118R



MB709R-MB715R



MB716R-MB723R

HIBBS Gouge

Catalog Number	Tip Size (mm)	Tip Size (in.)	Blade	Length (in.)
MB709R	16	5/8	STR	9 1/2
MB710R	19	3/4	STR	9 1/2
MB711R	22	7/8	STR	9 1/2
MB712R	25	1	STR	9 1/2
MB713R	28	1 1/8	STR	9 1/2
MB714R	32	1 1/4	STR	9 1/2
MB715R	38	1 1/2	STR	9 1/2
MB716R	6	1/4	CVD	9 1/2
MB717R	9	3/8	CVD	9 1/2
MB718R	13	1/2	CVD	9 1/2
MB719R	13	5/8	CVD	9 1/2
MB720R	19	3/4	CVD	9 1/2
MB721R	25	1	CVD	9 1/2
MB722R	28	1 1/8	CVD	9 1/2
MB723R	38	1 1/2	CVD	9 1/2



ORTHO
SPINE

INCHES

Orthopedics/Spine

Chisels, Gouges and Osteotomes



FL156R-FL170R

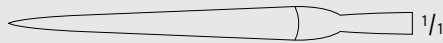

FL156R-FL160R

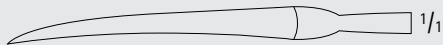

FL166R-FL170R

HOKE Osteotome

Catalog Number	Tip Size (mm)	Tip Size (in.)	Blade	Length (in.)
FL156R	3	1/8	STR	6 1/8
FL157R	6	1/4	STR	6 1/8
FL158R	10	3/8	STR	6 1/8
FL159R	13	1/2	STR	6 1/8
FL160R	16	5/8	STR	6 1/8
FL166R	3	1/8	CVD	6 1/8
FL167R	6	1/4	CVD	6 1/8
FL168R	10	3/8	CVD	6 1/8
FL169R	13	1/2	CVD	6 1/8
FL170R	16	5/8	CVD	6 1/8



FL512R-FL517R

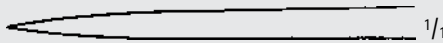

FL512R-FL517R



FL523R-FL527R

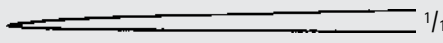

FL523R-FL527R



FL553R-FL557R



FL553R-FL557R

STILLE Osteotome

Catalog Number	Tip Size (mm)	Tip Size (in.)	Blade	Length (in.)
FL512R	8	5/16	STR, HVY	8
FL513R	10	3/8	STR, HVY	8
FL514R	12	1/2	STR, HVY	8
FL515R	15	5/8	STR, HVY	8
FL516R	20	3/4	STR, HVY	8
FL517R	25	1	STR, HVY	8
FL523R	10	3/8	STR	8
FL524R	12	1/2	STR	8
FL525R	15	5/8	STR	8
FL526R	20	3/4	STR	8
FL527R	25	1	STR	8
FL553R	10	3/8	CVD	8
FL554R	12	1/2	CVD	8
FL555R	15	5/8	CVD	8
FL556R	20	3/4	CVD	8
FL557R	25	1	CVD	8



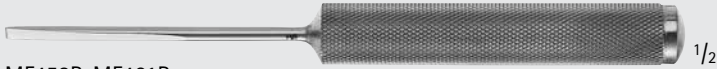

MF458R-MF461R 1/2

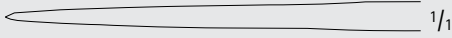

MF458R-MF461R 1/1

Gouge

Catalog Number	Tip Size (mm)	Tip	Length (in.)
MF458R	4	CVD	7
MF459R	4	STR	7
MF460R	6	CVD	7 1/2
MF461R	6	STR	7 1/2



MB657R-MB669R 1/2

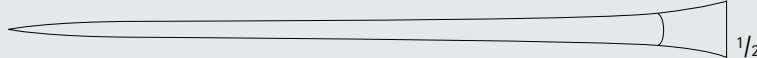

MB657R-MB662R 1/2

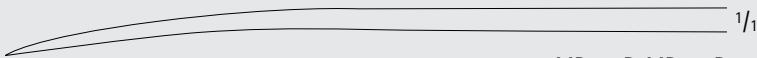

MB663R-MB669R 1/1

SMITH-PETERSON Osteotome

Catalog Number	Tip Size (mm)	Tip Size (in.)	Blade	Length (in.)
MB657R	7	9/32	STR	8
MB658R	11	7/16	STR	8
MB659R	14	9/16	STR	8
MB660R	17	21/32	STR	8
MB661R	19	3/4	STR	8
MB662R	25	1	STR	8
MB663R	6	1/4	CVD	8
MB664R	9.5	3/8	CVD	8
MB665R	13	1/2	CVD	8
MB666R	16	5/8	CVD	8
MB667R	19	3/4	CVD	8
MB668R	25	1	CVD	8
MB669R	32	1 1/4	CVD	8



MB675R-MB684R 1/2

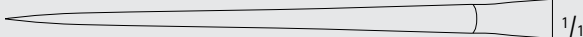

MB675R-MB684R 1/1



MB685R-MB694R 1/2

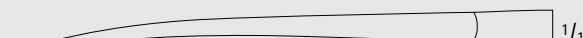

MB685R-MB694R 1/1

HIBBS Osteotome

Catalog Number	Tip Size (mm)	Tip Size (in.)	Blade	Length (in.)
MB675R	6	1/4	STR	9 5/8
MB676R	10	3/8	STR	9 5/8
MB677R	13	1/2	STR	9 5/8
MB678R	16	5/8	STR	9 5/8
MB679R	19	3/4	STR	9 5/8
MB680R	22	7/8	STR	9 5/8
MB681R	25	1	STR	9 5/8
MB682R	28	1 1/8	STR	9 5/8
MB683R	32	1 1/4	STR	9 5/8
MB684R	38	1 1/2	STR	9 5/8
MB685R	6	1/4	CVD	9 5/8
MB686R	10	3/8	CVD	9 5/8
MB687R	13	1/2	CVD	9 5/8
MB688R	16	5/8	CVD	9 5/8
MB689R	19	3/4	CVD	9 5/8
MB690R	22	7/8	CVD	9 5/8
MB691R	25	1	CVD	9 5/8
MB692R	28	1 1/8	CVD	9 5/8
MB693R	32	1 1/4	CVD	9 5/8
MB694R	38	1 1/2	CVD	9 5/8





Orthopedics/Spine

Chisels, Gouges and Osteotomes

COBB Osteotomes

Catalog Number	Tip Size (mm)	Blade	Length (in.)
MB084R	6	STR	11
MB085R	10	STR	11
MB742R	13	STR	11
MB087R	13	STR	11
MB088R	16	STR	11
MB089R	19	STR	11
MB090R	25	STR	11
MG030R	6	CVD	11
MG031R	10	CVD	11
MG032R	13	CVD	11
MG033R	16	CVD	11
MG036R	19	CVD	11
MG034R	25	CVD	11
MG035R	32	CVD	11

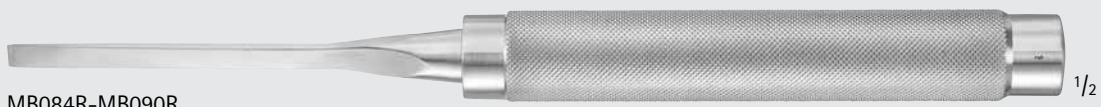

MB084R-MB090R

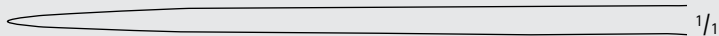

MB084R-MB090R



MG030R-MG035R

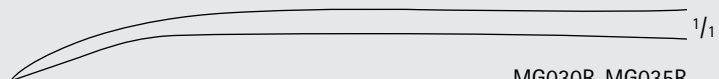

MG030R-MG035R



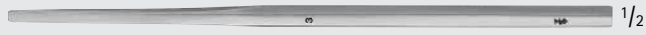

MB404R-MB373R



MB404R-MB373R

Osteotome W/ Hexagonal Handle

Catalog Number	Tip Size (mm)	Length (in.)
MB404R	2	6 1/4
MB405R	3	6 1/4
MB406R	4	6 1/4
MB407R	5	6 1/4
MB408R	6	6 1/4
MB409R	7	6 1/4
MB410R	8	6 1/4
MB411R	9	6 1/4
MB412R	10	6 1/4
MB413R	11	6 1/4
MB373R	12	6 1/4



MB398R-MB403R



MB398R-MB403R

CONVERSE Osteotome

Catalog Number	Tip Size (mm)	Length (in.)
MB398R	2	7
MB399R	4	7
MB400R	6	7
MB401R	8	7
MB402R	10	7
MB403R	12	7



MB388R-MB389R

RUBIN Osteotome, W/ Finger Grip

Catalog Number	Tip Size (mm)	Length (in.)
MB388R	10	6 1/2
MB389R	14	6 1/2

Orthopedics/Spine

Chisels, Gouges and Osteotomes



FL088R-MG049R

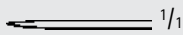

FL088R-MG049R



MG037R-MG044R

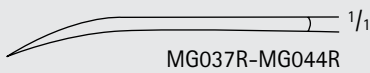

MG037R-MG044R

LAMBOTTE Osteotome

Catalog Number	Tip Size (mm)	Blade	Length (in.)
MG050R	SET OF 7	STR	-
FL088R	2	STR	5
FL101R	4	STR	5
FL102R	6	STR	5
FL104R	8	STR	5
FL106R	10	STR	5
FL108R	12	STR	5
MG046R	14	STR	5
FL109R	15	STR	5
MG047R	18	STR	5
MG048R	19	STR	5
MG049R	20	STR	5
MG037R	2	CVD	5
MG038R	4	CVD	5
MG039R	6	CVD	5
MG040R	8	CVD	5
MG041R	10	CVD	5
MG042R	12	CVD	5
MG043R	14	CVD	5
MG044R	15	CVD	5

LAMBOTTE MINI OSTEOTOME SET:

CONTAINS SEVEN MG050R STRAIGHT 5" OSTEOTOMES:

2MM, 4MM, 6MM, 8MM, 10MM, 12MM, 14MM PLUS Mallet (FL036R)

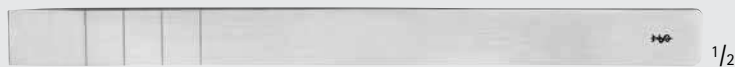

MB621R-MB628R

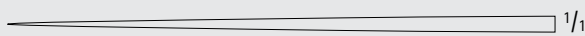

MB620R-MB628R

LAMBOTTE Osteotome with Calibrations

Catalog Number	Tip Size (mm)	Blade	Length (in.)
MB620R	COMPLETE SET	-	-
MB621R	4	STR	7 1/4
MB622R	6	STR	7 1/4
MB623R	7	STR	7 1/4
MB624R	8	STR	7 1/4
MB625R	10	STR	7 1/4
MB626R	12	STR	7 1/4
MB627R	16	STR	7 1/4
MB628R	22	STR	7 1/4

MB620R includes:

Osteotome MB621R-MB628R and Mallet MB629R





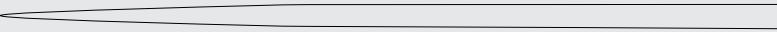

MB640R-MB646R 1/2



MB640R-MB646R 1/1



MB650R-MB656R 1/2



MB650R-MB656R 1/1

LAMBOTTE Osteotome

Catalog Number	Tip Size (mm)	Tip Size (in.)	Blade	Length (in.)
MB640R	COMPLETE SET		STR	
MB641R	6	1/4	STR	9
MB642R	13	1/2	STR	9
MB643R	19	3/4	STR	9
MB644R	25	1	STR	9
MB645R	32	1 1/4	STR	9
MB646R	38	1 1/2	STR	9
MB650R	COMPLETE SET		CVD	
MB651R	6	1/4	CVD	9
MB652R	13	1/2	CVD	9
MB653R	19	3/4	CVD	9
MB654R	25	1	CVD	9
MB655R	32	1 1/4	CVD	9
MB656R	38	1 1/2	CVD	9



FL650R-FL662R 1/2



FL650R-FL662R 1/1

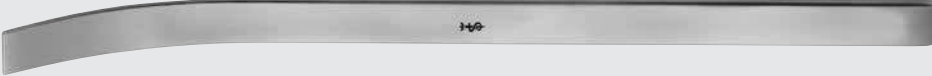

FL781R-FL790R 1/2



FL781R-FL790R 1/1

LAMBOTTE Osteotome

Catalog Number	Tip Size (mm)	Blade	Length (in.)
FL650R	4	STR	9 5/8
FL651R	8	STR	9 5/8
FL652R	10	STR	9 5/8
FL653R	13	STR	9 5/8
FL654R	15	STR	9 5/8
FL655R	18	STR	9 5/8
FL656R	20	STR	9 5/8
FL658R	25	STR	9 5/8
FL659R	30	STR	9 5/8
FL660R	38	STR	9 5/8
FL661R	44	STR	9 5/8
FL662R	50	STR	9 5/8
FL781R	8	CVD	9 5/8
FL783R	13	CVD	9 5/8
FL785R	18	CVD	9 5/8
FL788R	25	CVD	9 5/8
FL789R	30	CVD	9 5/8
FL790R	38	CVD	9 5/8



Orthopedics/Spine

Mallets



Mallet, PEEK

Catalog Number	Handle	Weight (gr)	Diameter (mm)	Length (in.)
FL010	HARTPRESS	230	42	9 3/4
FL011	HARTPRESS	315	50	9 3/4



Actual image color is blue

FL010-FL011

MEAD Mallet, Removable Discs, 180gr

Catalog Number	Description	Diameter (mm)	Length (in.)
FL035R	COMPLETE	20	7 1/2
FL034	SPARE DISCS, F/FL035R, 2/SET	20	

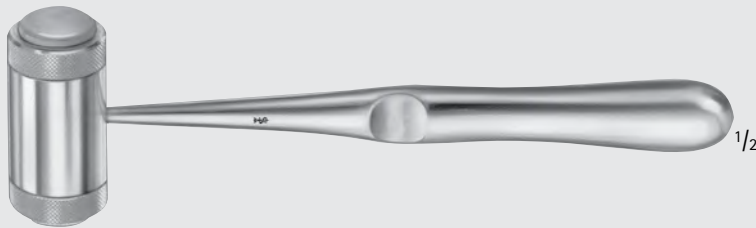

FL035R

Mallet W/ Removable Nylon Discs, 135gr

Catalog Number	Description	Diameter (mm)	Length (in.)
FL036R	COMPLETE	25	7 1/4
FL037	NYLON SPARE DISCS, F/FL036R, 2/SET	25	

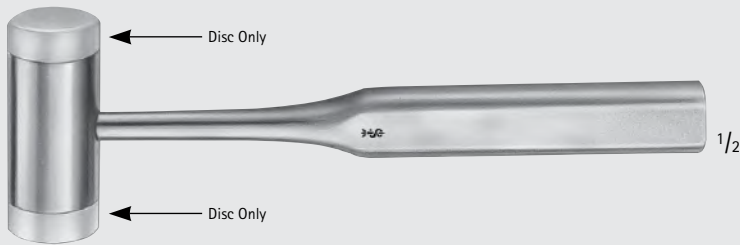

FL036R

Mallet, 226gr

Catalog Number	Description	Diameter (mm)	Length (in.)
MB629R	ONE SIDE NYLON, ONE SIDE METAL	26	7 1/4
MB629200	REPLACEMENT NYLON DISC FOR MB629R MALLET HEAD		



MB629R



DF114R

Mallet, 155gr

Catalog Number	Diameter (mm)	Length (in.)
DF114R	25	7 1/2



US142

Mallet, Copper

Catalog Number	Diameter (mm)	Length (in.)
US142	20	6 1/2

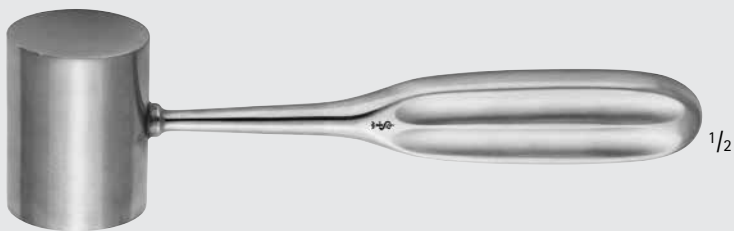

MG583R

KIRK Mallet, 560gr

Catalog Number	Diameter (mm)	Length (in.)
MG583R	35	7 1/4



ORTHO
SPINE

Orthopedics/Spine

Mallets



FL038R

COTTLE Mallet, Flat/Round, 235gr

Catalog Number	Diameter (mm)	Length (in.)
FL038R	30	7 1/4



FL044R

HAJEK Mallet, 140gr

Catalog Number	Diameter (mm)	Length (in.)
FL044R	27	8 3/4



FL055R

BERGMANN Mallet, 260gr

Catalog Number	Diameter (mm)	Length (in.)
FL055R	30	9 1/4

PEEK





42 mm

30 mm

FL059R

Mallet, 285gr, W/ Silicone Handle

Catalog Number	Diameter (mm)	Length (in.)
FL059R	30 / 42	9 1/2



FL060R

BERGMANN Mallet, 300gr, W/ Silicone Handle

Catalog Number	Diameter (mm)	Length (in.)
FL060R	45	9 5/8



MB630R

Orthopedic Mallet

Catalog Number	Diameter (mm)	Length (in.)
MB630R	30	7 1/4
MB631R	38	7 1/4

MB630R: 1 LB Weight (485gr)
 MB631R: 2 LB Weight (907gr)



Orthopedics/Spine

Mallets



WAGNER Mallet Set, 130gr, W/ Silicone Handle

Catalog Number	Diameter (mm)	Length (in.)
FL062	35	9 1/4

Set includes:
 1 PR Metal Discs FL064R
 1 PR Plastic Discs FL065
 1 Wrench FL062/206



FL062 1/2



FL064R

215 gr
1 Metal Disc, flat
1 Metal Disc, convex



FL065

30 gr
1 Plastic Disc, flat
1 Plastic Disc, convex

OMBREDANNE Mallet, 520gr, W/ Silicone Handle

Catalog Number	Diameter (mm)	Length (in.)
FL066R	40	9 1/2



FL066R 1/2

HEATH Copper Head Mallet, 725gr, W/ Silicone Handle

Catalog Number	Diameter (mm)	Length (in.)
FL068R	40	9 1/4



FL068R 1/2



MG095R

HEATH Mallet, 823gr

Catalog Number	Diameter (mm)	Size	Length (in.)
MG095R	40	1.8 lbs	7 1/4



FL090R

Bone Graft Tamper

Catalog Number	Diameter (mm)	Length (in.)
FL090R	12	7 7/8



FL090R



MB796R-MB800R



MB796R



MB798R



MB800R



MB801R



MB801R



MB802R



MB802R

Bone Tamp

Catalog Number	Diameter (mm)	Length (in.)
MB796R	2	6 1/4
MB798R	4	6 1/4
MB800R	6	6 1/4
MB801R	8	6 1/4
MB802R	10	6 1/4



FG093R-FG096R



FG093R



FG094R



FG095R



FG096R

SYPERT Spinal Impactor, W/ HART-PRESS Handle

Catalog Number	Tip Size (mm)	Length (in.)
FG093R	3 x 8	11 1/2
FG094R	4 x 10	11 1/2
FG095R	5 x 15	11 1/2
FG096R	6 x 20	11 1/2



ORTHO
SPINE

INCHES

Orthopedics/Spine

Bone Impactor

COBB Bone Impactor

Catalog Number	Tip Size (mm)	Length (in.)
MB545R	3 x 12	11 1/4



MB545R

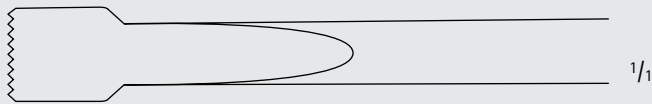

MB545R





RALKS Hand Drill, Cannulated

Catalog Number	Length (in.)
MG021R	6 1/4

MG021R



Orthopedics/Spine

Drills, Burrs and Reamers



CHAMPIONNIÈRE Bone Drill

Catalog Number	Length (in.)
FR110R	6 3/4

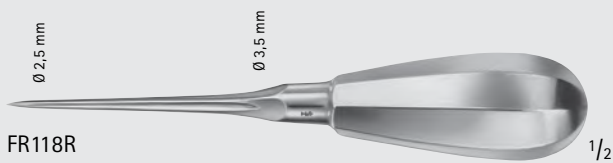

Awl/Reamer

Catalog Number	Length (in.)
FR118R	6

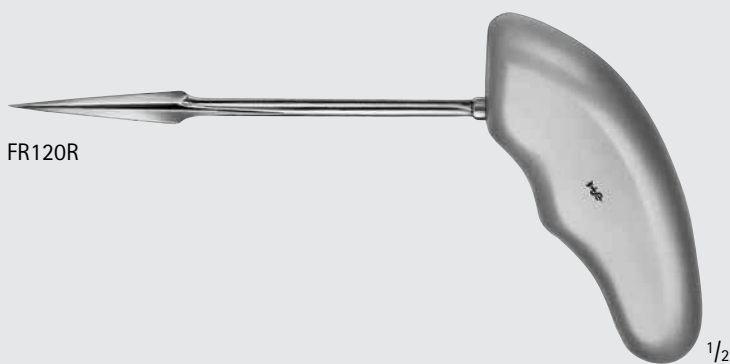

Reamer

Catalog Number	Length (in.)
FR120R	7





FR125R

PERTHES Reamer

Catalog Number	Length (in.)
FR125R	8 1/2



FR140R-FR141R

Bone Biopsy Trephine

Catalog Number	Diameter (mm)	Length (in.)
FR140R	3.9 / 5	6 1/4
FR141R	6.4 / 8	6 1/4



FR140R



FR141R



ORTHO
SPINE

INCHES

Orthopedics/Spine

Curettes



FK845R

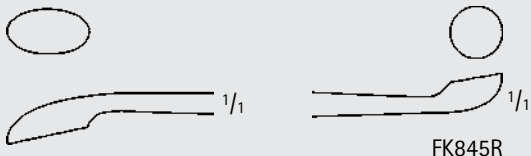

FK845R



FK846R

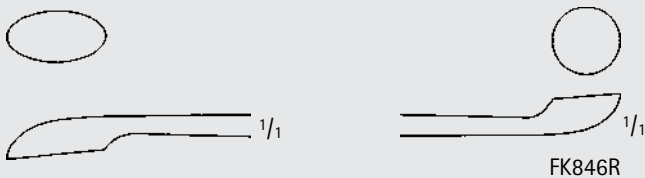

FK846R



FK848R

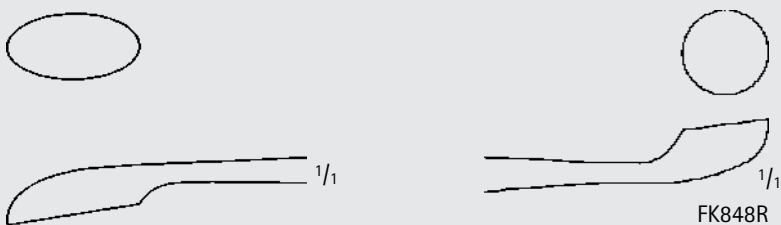

FK848R



FK850R

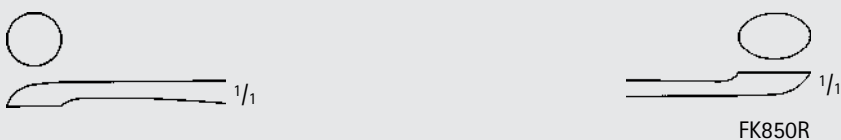

FK850R

Bone Curette, Double Ended

Catalog Number	Tip Size (mm)	Length (in.)
FK845R	6 / 7	5 1/8
FK846R	7 / 8	6 1/4
FK848R	8 / 11	7 7/8
FK850R	7 / 6	8 1/4



FK658R-FK659R

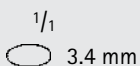

FK658R

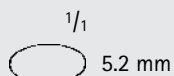

FK659R

WILLIGER Bone Curette

Catalog Number	Tip Size (#)	Tip Size (mm)	Length (in.)
FK658R	00	3.4	6 3/4
FK659R	1	5.2	6 3/4



BRUNS Curette, Round

Catalog Number	Tip Size (#)	Tip Size (mm)	Length (in.)
FK611R	000	3	6 1/2
FK612R	00	4	6 1/2
FK613R	0	5	6 1/2
FK614R	1	6	6 1/2
FK615R	2	8	6 1/2
FK616R	3	10	6 1/2
FK617R	4	12	6 1/2

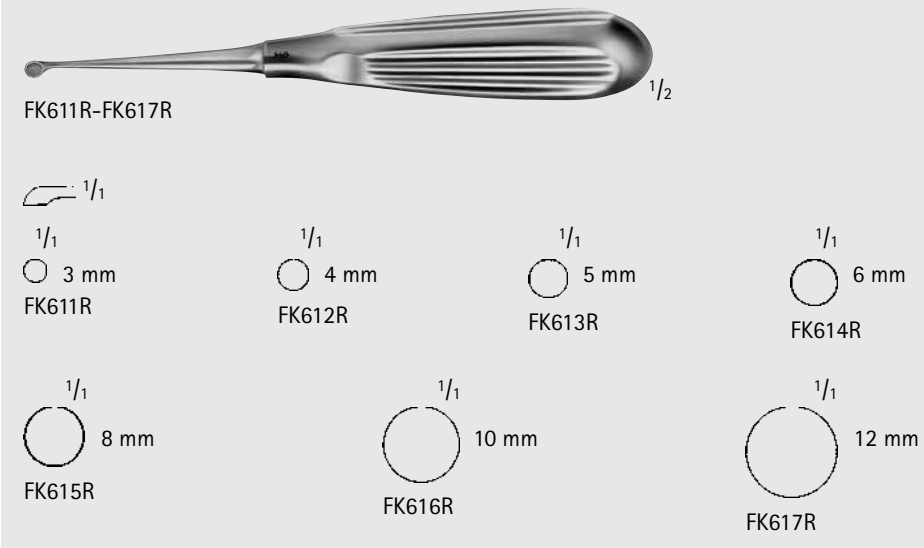

SCHEDE Curette

Catalog Number	Tip Size (#)	Tip Size (mm)	Length (in.)
FK621R	000	2.5	6 3/4
FK622R	00	3.4	6 3/4
FK623R	0	4.2	6 3/4
FK624R	1	5.2	6 3/4
FK625R	2	6.3	6 3/4
FK626R	3	7.4	6 3/4
FK627R	4	8.0	6 3/4

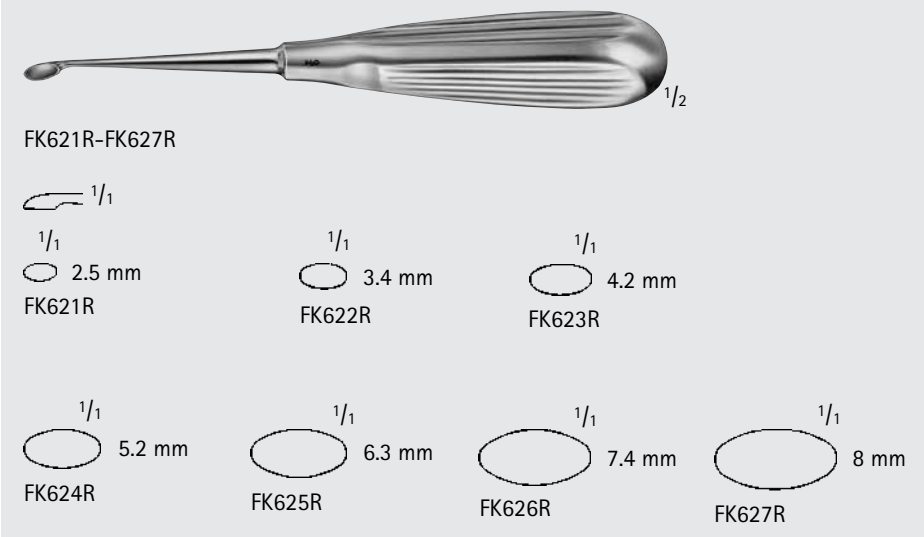

VOLKMANN Curette

Catalog Number	Tip Size (#)	Tip Size (mm)	Length (in.)
FK630R	0000	2.8	6 3/4
FK631R	000	3.6	6 3/4
FK632R	00	4.4	6 3/4
FK633R	0	5.2	6 3/4
FK634R	1	6.8	6 3/4
FK635R	2	8.5	6 3/4
FK636R	3	10.0	6 3/4
FK637R	4	11.5	6 3/4
FK638R	5	13.0	6 3/4
FK639R	6	14.5	6 3/4

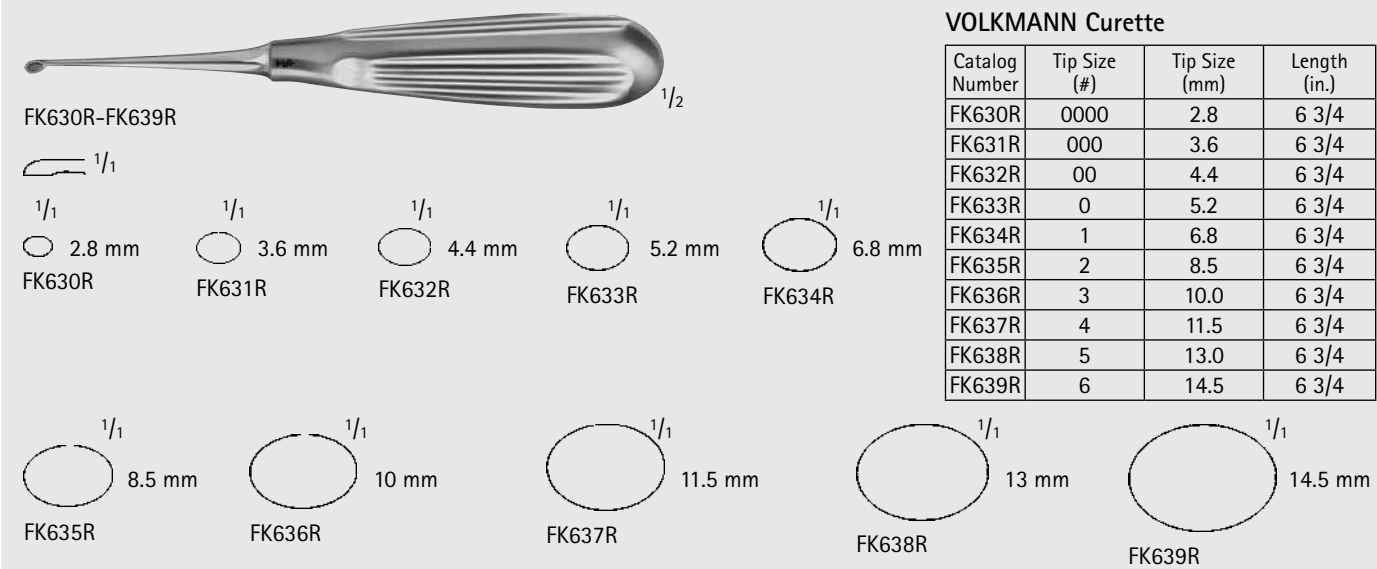

Orthopedics/Spine

Curettes



FK662R-FK665R

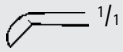

$\frac{1}{1}$
○ 2.8 mm
FK662R

$\frac{1}{1}$
○ 3.6 mm
FK663R

$\frac{1}{1}$
○ 4.4 mm
FK664R

$\frac{1}{1}$
○ 5.2 mm
FK665R

DAUBENSPECK Bone Curette

Catalog Number	Tip Size (#)	Tip Size (mm)	Length (in.)
FK662R	0000	2.8	7 7/8
FK663R	000	3.6	7 7/8
FK664R	00	4.4	7 7/8
FK665R	0	5.2	7 7/8



FK675R-FK679R

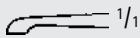

$\frac{1}{1}$
○ 1.8 mm
FK675R

$\frac{1}{1}$
○ 2.0 mm
FK676R

$\frac{1}{1}$
○ 2.4 mm
FK677R

LEMPERT Bone Curette

Catalog Number	Tip Size (mm)	Length (in.)
FK675R	1.8	8 1/2
FK676R	2.0	8 1/2
FK677R	2.4	8 1/2
FK678R	2.6	8 1/2
FK679R	2.8	8 1/2

$\frac{1}{1}$
○ 2.6 mm
FK678R

$\frac{1}{1}$
○ 2.8 mm
FK679R



MD565-MD567



$\frac{1}{1}$
MD565

EPSTEIN Spinal Curette

Catalog Number	Tip Size (mm)	Size (#)	Length (in.)
MD565	2.0	000	8
MD566	2.5	00	8
MD567	3.0	0	8

SCOVILLE Bone Curette

Catalog Number	Tip Size (#)	Tip Size (mm)	Tip	Length (in.)
FK702R	000	3.6	FWD STR	9 3/4
FK703R	00	4.4	FWD STR	9 3/4
FK704R	0	5.2	FWD STR	9 3/4
FK705R	1	6.8	FWD STR	9 3/4
FK712R	000	3.6	FWD ANG	9 3/4
FK713R	00	4.4	FWD ANG	9 3/4
FK714R	0	5.2	FWD ANG	9 3/4
FK715R	1	6.8	FWD ANG	9 3/4



FK702R-FK715R

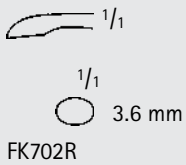

FK702R

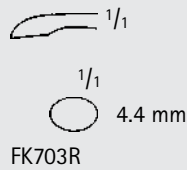

FK703R

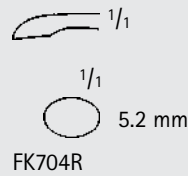

FK704R



FK705R

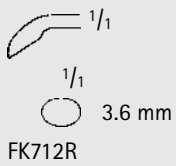

FK712R

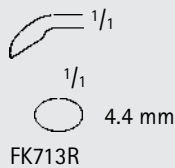

FK713R

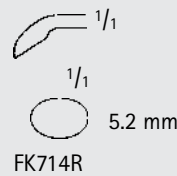

FK714R



FK715R

BUSHE Bone Curette

Catalog Number	Tip Size (mm)	Tip	Length (in.)
FK723R	3.0	REV ANG	9 3/4
FK724R	4.0	REV ANG	9 3/4
FK725R	5.0	REV ANG	9 3/4



FK723R-FK725R

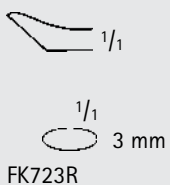

FK723R

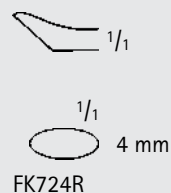

FK724R

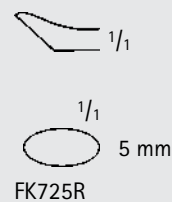

FK725R



INCHES

Orthopedics/Spine

Curettes

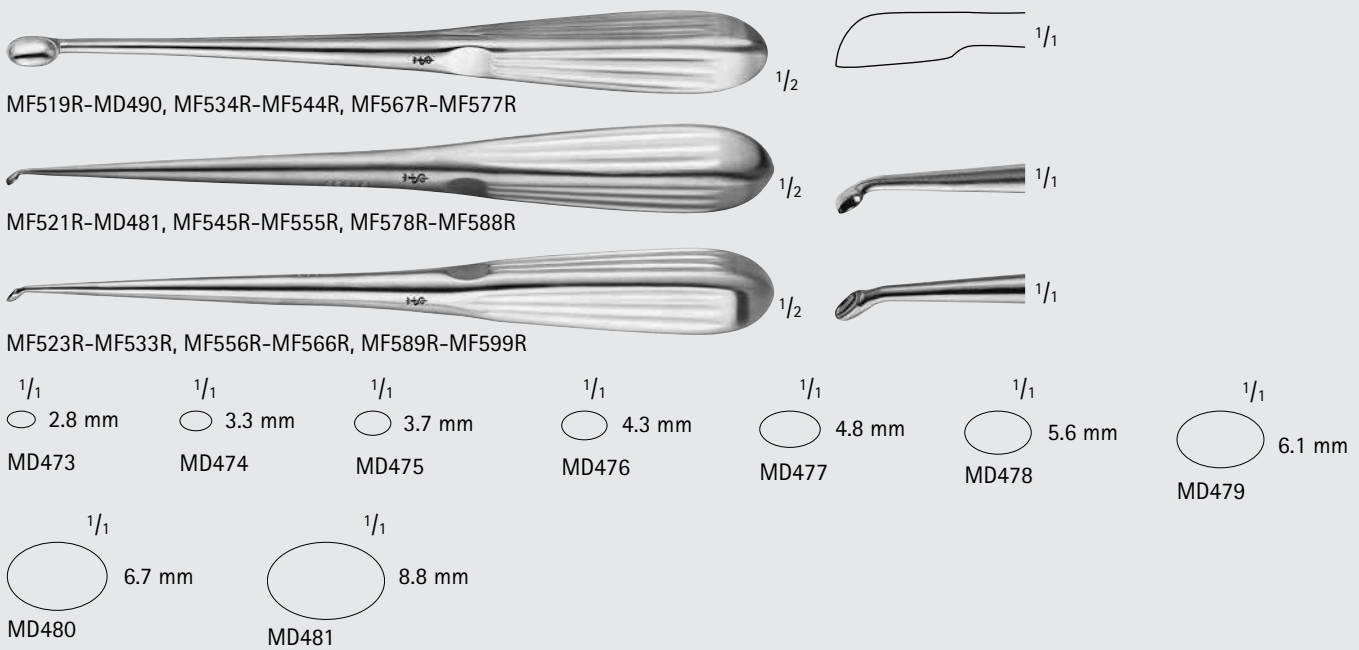

BRUNS Spinal Curette

Catalog Number	Tip Size (#)	Tip	Length (in.)	Catalog Number	Tip Size (#)	Tip	Length (in.)	Catalog Number	Tip Size (#)	Tip	Length (in.)
MF519R	00000	STR	8	MF534R	00000	STR	9	MF567R	00000	STR	12
MF520R	0000	STR	8	MF535R	0000	STR	9	MF568R	0000	STR	12
MD482	000	STR	8	MF536R	000	STR	9	MF569R	000	STR	12
MD483	00	STR	8	MF537R	00	STR	9	MF570R	00	STR	12
MD484	0	STR	8	MF538R	0	STR	9	MF571R	0	STR	12
MD485	1	STR	8	MF539R	1	STR	9	MF572R	1	STR	12
MD486	2	STR	8	MF540R	2	STR	9	MF573R	2	STR	12
MD487	3	STR	8	MF541R	3	STR	9	MF574R	3	STR	12
MD488	4	STR	8	MF542R	4	STR	9	MF575R	4	STR	12
MD489	5	STR	8	MF543R	5	STR	9	MF576R	5	STR	12
MD490	6	STR	8	MF544R	6	STR	9	MF577R	6	STR	12
MF521R	00000	FWD ANG	8	MF545R	00000	FWD ANG	9	MF578R	00000	FWD ANG	12
MF522R	0000	FWD ANG	8	MF546R	0000	FWD ANG	9	MF579R	0000	FWD ANG	12
MD473	000	FWD ANG	8	MF547R	000	FWD ANG	9	MF580R	000	FWD ANG	12
MD474	00	FWD ANG	8	MF548R	00	FWD ANG	9	MF581R	00	FWD ANG	12
MD475	0	FWD ANG	8	MF549R	0	FWD ANG	9	MF582R	0	FWD ANG	12
MD476	1	FWD ANG	8	MF550R	1	FWD ANG	9	MF583R	1	FWD ANG	12
MD477	2	FWD ANG	8	MF551R	2	FWD ANG	9	MF584R	2	FWD ANG	12
MD478	3	FWD ANG	8	MF552R	3	FWD ANG	9	MF585R	3	FWD ANG	12
MD479	4	FWD ANG	8	MF553R	4	FWD ANG	9	MF586R	4	FWD ANG	12
MD480	5	FWD ANG	8	MF554R	5	FWD ANG	9	MF587R	5	FWD ANG	12
MD481	6	FWD ANG	8	MF555R	6	FWD ANG	9	MF588R	6	FWD ANG	12
MF523R	00000	REV ANG	8	MF556R	00000	REV ANG	9	MF589R	00000	REV ANG	12
MF524R	0000	REV ANG	8	MF557R	0000	REV ANG	9	MF590R	0000	REV ANG	12
MF525R	000	REV ANG	8	MF558R	000	REV ANG	9	MF591R	000	REV ANG	12
MF526R	00	REV ANG	8	MF559R	00	REV ANG	9	MF592R	00	REV ANG	12
MF527R	0	REV ANG	8	MF560R	0	REV ANG	9	MF593R	0	REV ANG	12
MF528R	1	REV ANG	8	MF561R	1	REV ANG	9	MF594R	1	REV ANG	12
MF529R	2	REV ANG	8	MF562R	2	REV ANG	9	MF595R	2	REV ANG	12
MF530R	3	REV ANG	8	MF563R	3	REV ANG	9	MF596R	3	REV ANG	12
MF531R	4	REV ANG	8	MF564R	4	REV ANG	9	MF597R	4	REV ANG	12
MF532R	5	REV ANG	8	MF565R	5	REV ANG	9	MF598R	5	REV ANG	12
MF533R	6	REV ANG	8	MF566R	6	REV ANG	9	MF599R	6	REV ANG	12





MB872R-MB880R

BRUNS Curette

Catalog Number	Tip Size (#)	Tip Size (mm)	Tip	Length (in.)
MB872R	000	2.0	STR	9
MB873R	00	2.5	STR	9
MB874R	0	3.3	STR	9
MB875R	1	3.8	STR	9
MB876R	2	4.8	STR	9
MB877R	3	5.3	STR	9
MB878R	4	6.0	STR	9
MB879R	5	6.7	STR	9
MB880R	6	7.3	STR	9

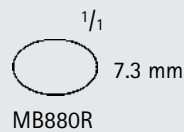
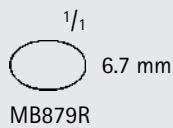
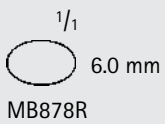
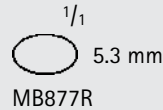
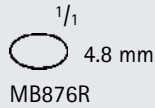
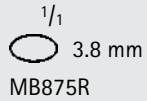
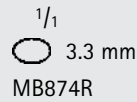
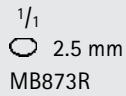
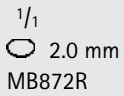

FK688R-FK690R

SIMON Bone Curette

Catalog Number	Tip Size (#)	Tip Size (mm)	Length (in.)
FK688R	000	3.6	9 1/4
FK689R	00	4.4	9 1/4
FK690R	0	5.2	9 1/4

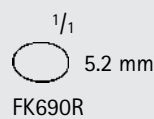
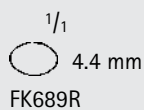
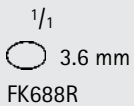
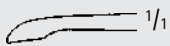

MB415R-MB417R

HIBBS Curette

Catalog Number	Tip	Length (in.)
MB415R	SMALL	8
MB416R	MEDIUM	8
MB417R	LARGE	8



Orthopedics/Spine

Curettes



Bone Curette, Long, W/ PEEK Handle

Catalog Number	Tip Size (#)	Tip Size (mm)	Length (in.)
FK666R	00	4.4	10 5/8
FK668R	1	6.8	10 5/8
FK670R	2	8.5	10 5/8
FK672R	3	10.0	10 5/8



FK666R-FK672R

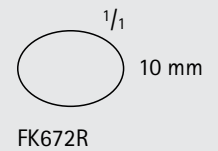
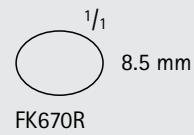
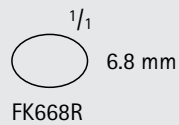
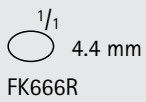
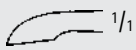

CASPAR Curette, W/ PEEK Handle

Catalog Number	Tip Size (#)	Tip Size (mm)	Blade	Length (in.)
FK773R	000	3.6	STR	8 3/4
FK774R	00	4.4	STR	8 3/4
FK775R	0	5.2	STR	8 3/4
FK783R	000	3.6	CVD	8 3/4
FK784R	00	4.4	CVD	8 3/4
FK785R	0	5.2	CVD	8 3/4



FK773R-FK775R

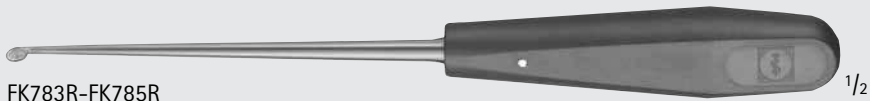
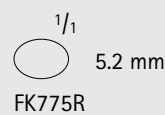
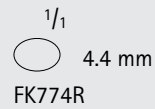
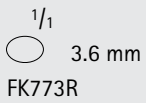
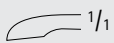

FK783R-FK785R

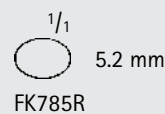
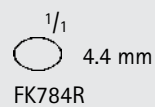
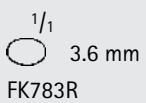
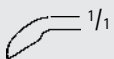

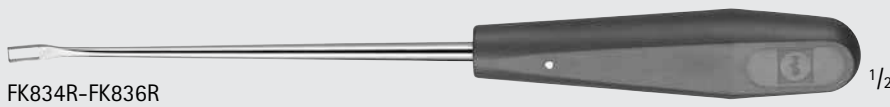

FK834R-FK836R

CASPAR Curette, W/ PEEK Handle

Catalog Number	Tip Size (mm)	Tip	Length (in.)
FK834R	4	SQUARE	8 3/4
FK835R	5	SQUARE	8 3/4
FK836R	6	SQUARE	8 3/4

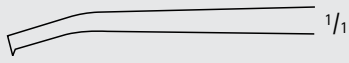

4 mm  1/1
FK834R

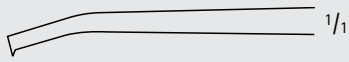

5 mm  1/1
FK835R

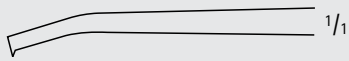

6 mm  1/1
FK836R



ORTHO
SPINE

INCHES

Orthopedics/Spine

Curettes



CASPAR Bone Curette, Toothed

Catalog Number	Tip Size (mm)	Tip	Length (in.)
FK854R	4.0	SQUARE	9 3/4
FK855R	5.0	SQUARE	9 3/4



FK854R-FK855R ^{1/2}

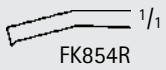

FK854R ^{1/1}

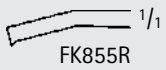

FK855R ^{1/1}

CASPAR Bone Curette, Toothed

Catalog Number	Tip Size (mm)	Tip	Length (in.)
FK863R	3.0	SQUARE, ANG	10 5/8
FK864R	4.0	SQUARE, ANG	10 5/8



FK863R-FK864R ^{1/2}

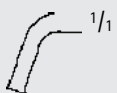

FK863R ^{1/1}

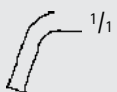

FK864R ^{1/1}

COBB Curette

Catalog Number	Tip Size (#)	Tip Size (mm)	Tip	Length (in.)
FK581R	000	2.0	STR	11
FK582R	00	2.5	STR	11
FK583R	0	3.0	STR	11
FK584R	1	3.5	STR	11
FK585R	2	4.5	STR	11
FK586R	3	5.5	STR	11
FK587R	4	7.5	STR	11
FK588R	5	8.5	STR	11
FK589R	6	10.0	STR	11
FK591R	000	2.0	ANG	11
FK592R	00	2.5	ANG	11
FK593R	0	3.0	ANG	11
FK594R	1	3.5	ANG	11
FK595R	2	4.5	ANG	11
FK596R	3	5.5	ANG	11
FK597R	4	7.5	ANG	11
FK598R	5	8.5	ANG	11
FK599R	6	10.0	ANG	11

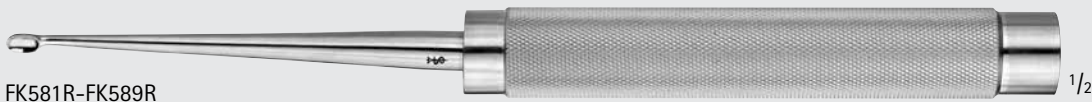

$\frac{1}{1}$
○ 2.0 mm
FK581R, FK591R

$\frac{1}{1}$
○ 2.5 mm
FK582R, FK592R

$\frac{1}{1}$
○ 3.0 mm
FK583R, FK593R

$\frac{1}{1}$
○ 3.5 mm
FK584R, FK594R

$\frac{1}{1}$
○ 4.5 mm
FK585R, FK595R

$\frac{1}{1}$
○ 5.5 mm
FK586R, FK596R

$\frac{1}{1}$
○ 7.5 mm
FK587R, FK597R

$\frac{1}{1}$
○ 8.5 mm
FK588R, FK598R

$\frac{1}{1}$
○ 10.0 mm
FK589R, FK599R



ORTHO
SPINE

INCHES

Colored Cervical Curette

Catalog Number	Tip Size (#)	Tip	Color	Length (in.)
MD216R	000000	STR	RED	10
MD217R	00000	STR	SILVER	10
MD218R	0000	STR	PURPLE	10
MD219R	000	STR	TURQUOISE	10
MD220R	00	STR	GOLD	10
MD221R	0	STR	GREEN	10
MD222R	1	STR	ORANGE	10
MD223R	2	STR	BLUE	10
MD224R	3	STR	GRAY	10
MD225R	4	STR	BLACK	10
MD226R	5	STR	BLACK	10
MD227R	6	STR	BLACK	10
MD234R	000000	ANG	RED	10
MD235R	00000	ANG	SILVER	10
MD236R	0000	ANG	PURPLE	10
MD237R	000	ANG	TURQUOISE	10
MD238R	00	ANG	GOLD	10
MD239R	0	ANG	GREEN	10
MD240R	1	ANG	ORANGE	10
MD241R	2	ANG	BLUE	10
MD242R	3	ANG	GRAY	10
MD243R	4	ANG	BLACK	10
MD244R	5	ANG	BLACK	10
MD245R	6	ANG	BLACK	10



MD216R-MD227R



MD216R-MD227R

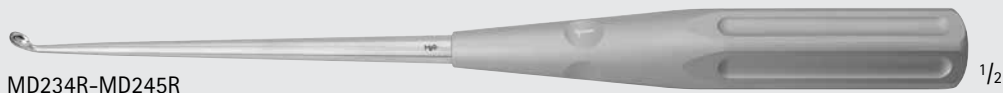

MD234R-MD245R



MD234R-MD245R



Colored Cervical Curette

Catalog Number	Tip Size (#)	Tip	Color	Length (in.)
MD309R	000000	REVERSE ANG	RED	10
MD310R	00000	REVERSE ANG	SILVER	10
MD311R	0000	REVERSE ANG	PURPLE	10
MD312R	000	REVERSE ANG	TURQUOISE	10
MD313R	00	REVERSE ANG	GOLD	10
MD314R	0	REVERSE ANG	GREEN	10
MD315R	1	REVERSE ANG	ORANGE	10
MD316R	2	REVERSE ANG	BLUE	10
MD317R	3	REVERSE ANG	GRAY	10
MD318R	4	REVERSE ANG	BLACK	10
MD319R	5	REVERSE ANG	BLACK	10
MD320R	6	REVERSE ANG	BLACK	10
MD383R	000000	ANG 90°	RED	10
MD384R	00000	ANG 90°	SILVER	10
MD385R	0000	ANG 90°	PURPLE	10
MD386R	000	ANG 90°	TURQUOISE	10
MD387R	00	ANG 90°	GOLD	10
MD388R	0	ANG 90°	GREEN	10
MD389R	1	ANG 90°	ORANGE	10
MD390R	2	ANG 90°	BLUE	10
MD391R	3	ANG 90°	GRAY	10
MD392R	4	ANG 90°	BLACK	10
MD393R	5	ANG 90°	BLACK	10
MD394R	6	ANG 90°	BLACK	10

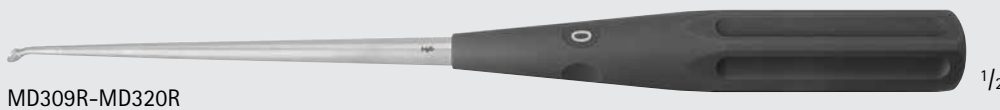

MD309R-MD320R



MD309R-MD320R

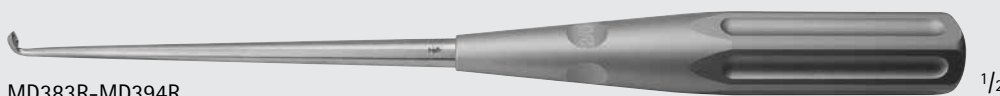

MD383R-MD394R



MD383R-MD394R



Colored Lumbar Curette

Catalog Number	Tip Size (#)	Tip	Color	Length (in.)
MD500R	000000	STR	RED	13 3/4
MD501R	00000	STR	SILVER	13 3/4
MD502R	0000	STR	PURPLE	13 3/4
MD503R	000	STR	TURQUOISE	13 3/4
MD504R	00	STR	GOLD	13 3/4
MD505R	0	STR	GREEN	13 3/4
MD506R	1	STR	ORANGE	13 3/4
MD507R	2	STR	BLUE	13 3/4
MD508R	3	STR	GRAY	13 3/4
MD509R	4	STR	BLACK	13 3/4
MD510R	5	STR	BLACK	13 3/4
MD511R	6	STR	BLACK	13 3/4
MD620R	000000	ANG	RED	13 3/4
MD621R	00000	ANG	SILVER	13 3/4
MD622R	0000	ANG	PURPLE	13 3/4
MD623R	000	ANG	TURQUOISE	13 3/4
MD624R	00	ANG	GOLD	13 3/4
MD625R	0	ANG	GREEN	13 3/4
MD626R	1	ANG	ORANGE	13 3/4
MD627R	2	ANG	BLUE	13 3/4
MD628R	3	ANG	GRAY	13 3/4
MD629R	4	ANG	BLACK	13 3/4
MD630R	5	ANG	BLACK	13 3/4
MD631R	6	ANG	BLACK	13 3/4
MD632R	000000	REVERSE ANG	RED	13 3/4
MD633R	00000	REVERSE ANG	SILVER	13 3/4
MD634R	0000	REVERSE ANG	PURPLE	13 3/4
MD635R	000	REVERSE ANG	TURQUOISE	13 3/4
MD636R	00	REVERSE ANG	GOLD	13 3/4
MD637R	0	REVERSE ANG	GREEN	13 3/4
MD638R	1	REVERSE ANG	ORANGE	13 3/4
MD639R	2	REVERSE ANG	BLUE	13 3/4
MD640R	3	REVERSE ANG	GRAY	13 3/4
MD641R	4	REVERSE ANG	BLACK	13 3/4
MD642R	5	REVERSE ANG	BLACK	13 3/4
MD643R	6	REVERSE ANG	BLACK	13 3/4

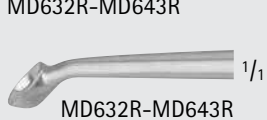

Bayonet Curette

Catalog Number	Tip	Tip Size (#)	Length (in.)
MD660R	STR	0	9
MD661R	STR	00	9
MD662R	STR	000	9
MD663R	STR	0000	9
MD664R	STR	00000	9
MD655R	REVERSE ANG UP	0	9
MD656R	REVERSE ANG UP	00	9
MD657R	REVERSE ANG UP	000	9
MD658R	REVERSE ANG UP	0000	9
MD659R	REVERSE ANG UP	00000	9
MD665R	REVERSE ANG DOWN	0	9
MD666R	REVERSE ANG DOWN	00	9
MD667R	REVERSE ANG DOWN	000	9
MD668R	REVERSE ANG DOWN	0000	9
MD669R	REVERSE ANG DOWN	00000	9

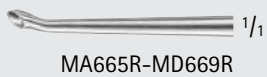
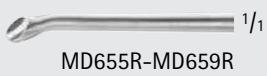

ORTHO
SPINE

INCHES

Black Handle Curette

Catalog Number	Tip	Tip Size (#)	Handle	Length (in.)
MN012R	STR	000	8 1/2	13 1/4
MN013R	STR	00	8 1/2	13 1/4
MN014R	STR	0	8 1/2	13 1/4
MN015R	STR	1	8 1/2	13 1/4
MN016R	STR	2	8 1/2	13 1/4
MN017R	STR	3	8 1/2	13 1/4
MN018R	STR	4	8 1/2	13 1/4
MN019R	STR	5	8 1/2	13 1/4
MN020R	STR	6	8 1/2	13 1/4
MN021R	STR	7	8 1/2	13 1/4
MN022R	ANG	000	8 1/2	13 1/4
MN023R	ANG	00	8 1/2	13 1/4
MN024R	ANG	0	8 1/2	13 1/4
MN025R	ANG	1	8 1/2	13 1/4
MN026R	ANG	2	8 1/2	13 1/4
MN027R	ANG	3	8 1/2	13 1/4
MN028R	ANG	4	8 1/2	13 1/4
MN029R	ANG	5	8 1/2	13 1/4
MN030R	ANG	6	8 1/2	13 1/4
MN031R	ANG	7	8 1/2	13 1/4
MN032R	REVERSE ANG	000	8 1/2	13 1/4
MN033R	REVERSE ANG	00	8 1/2	13 1/4
MN034R	REVERSE ANG	0	8 1/2	13 1/4
MN035R	REVERSE ANG	1	8 1/2	13 1/4
MN036R	REVERSE ANG	2	8 1/2	13 1/4
MN037R	REVERSE ANG	3	8 1/2	13 1/4
MN038R	REVERSE ANG	4	8 1/2	13 1/4
MN039R	REVERSE ANG	5	8 1/2	13 1/4
MN040R	REVERSE ANG	6	8 1/2	13 1/4
MN041R	REVERSE ANG	7	8 1/2	13 1/4



MN012R-MN021R



MN022R-MN031R



MN032R-MN041R



XL Black Handled Curette

Catalog Number	Tip	Tip Size (#)	Handle	Length (in.)
MN042R	STR	000	9	15
MN043R	STR	00	9	15
MN044R	STR	0	9	15
MN045R	STR	1	9	15
MN046R	STR	2	9	15
MN047R	STR	3	9	15
MN048R	STR	4	9	15
MN049R	STR	5	9	15
MN050R	STR	6	9	15
MN051R	STR	7	9	15
MN052R	ANG	000	9	15
MN053R	ANG	00	0	15
MN054R	ANG	0	0	15
MN055R	ANG	1	9	15
MN056R	ANG	2	9	15
MN057R	ANG	3	9	15
MN058R	ANG	4	9	15
MN059R	ANG	5	9	15
MN060R	ANG	6	9	15
MN061R	ANG	7	9	15
MN062R	REVERSE ANG	000	9	15
MN063R	REVERSE ANG	00	9	15
MN064R	REVERSE ANG	0	9	15
MN065R	REVERSE ANG	1	9	15
MN066R	REVERSE ANG	2	9	15
MN067R	REVERSE ANG	3	9	15
MN068R	REVERSE ANG	4	9	15
MN069R	REVERSE ANG	5	9	15
MN070R	REVERSE ANG	6	9	15
MN071R	REVERSE ANG	7	9	15



MN042R-MN051R



MN052R-MN061R



MN062R-MN071R



Orthopedics/Spine

Curettes and Microdissecting Instruments

Micro Profile Instruments

Catalog Number	Description	Tip Size (#)	Tip	Length (in.)
MN087R	DISSECTOR	3 MM	STR	10 1/4
MN088R	DISSECTOR	5 MM	STR	10 1/4
MN077R	CURETTE	1	ANG	10 1/4
MN079R	CURETTE	2	ANG	10 1/4
MN081R	CURETTE	3	ANG	10 1/4
MN083R	CURETTE	4	ANG	10 1/4
MN085R	CURETTE	5	ANG	10 1/4
MN078R	CURETTE	1	REV-ANG	10 1/4
MN080R	CURETTE	2	REV-ANG	10 1/4
MN082R	CURETTE	3	REV-ANG	10 1/4
MN084R	CURETTE	4	REV-ANG	10 1/4
MN086R	CURETTE	5	REV-ANG	10 1/4

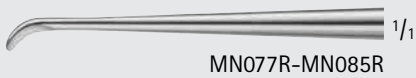

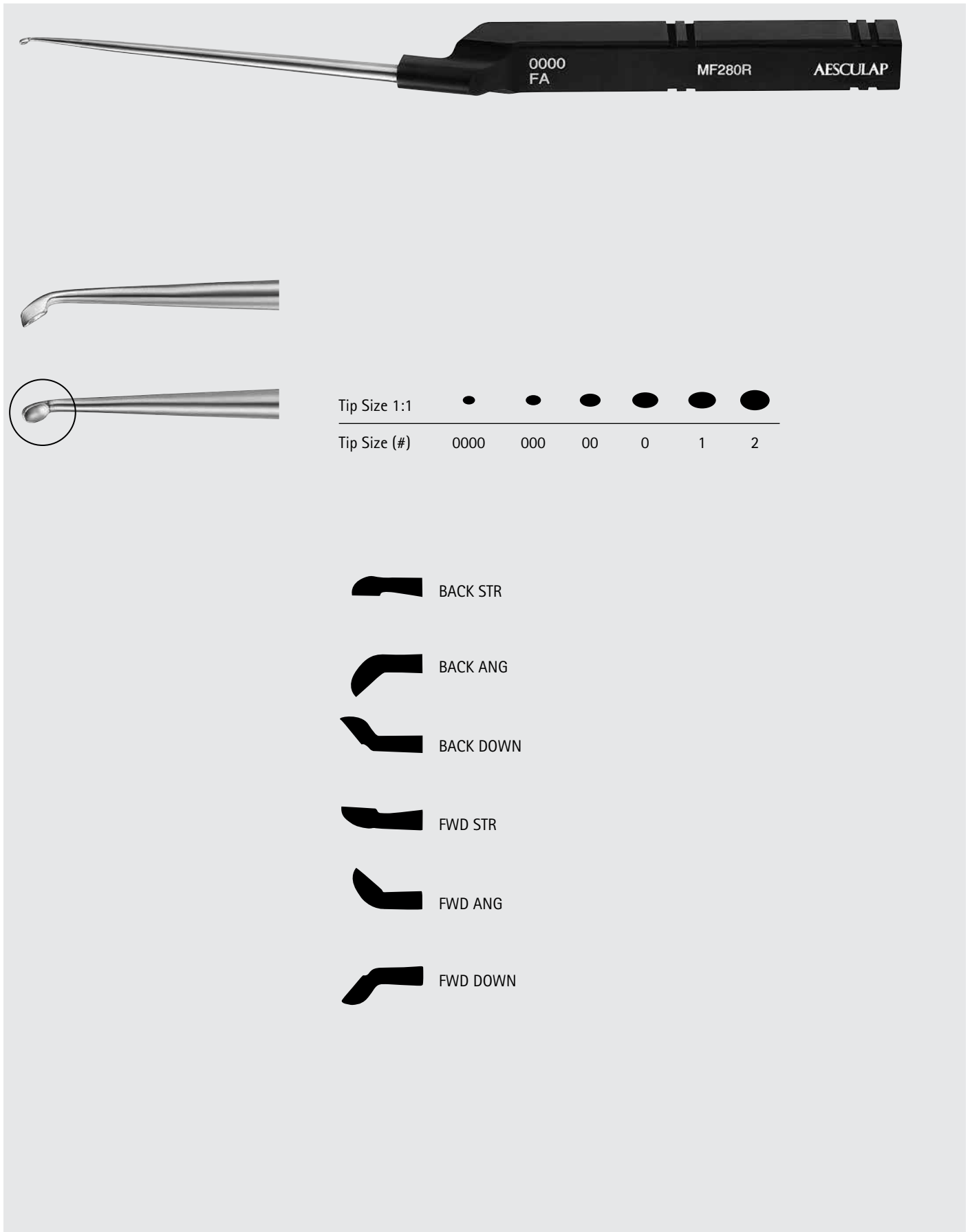

Orthopedics/Spine

Microdiscectomy Instruments

Microdiscectomy Cervical Instruments

Catalog Number	Tip Size (#)	Tip	Length (in.)
MF250	COMPLETE SET (Includes One Each of All Items Listed)		
MF251R	0	FWD STR	8 1/2
MF252R	00	FWD STR	8 1/2
MF253R	000	FWD STR	8 1/2
MF254R	0000	FWD STR	8 1/2
MF255R	Bone Cutter	FWD STR	8 1/2
MF256R	0	FWD ANG	8 1/2
MF257R	00	FWD ANG	8 1/2
MF258R	000	FWD ANG	8 1/2
MF259R	0000	FWD ANG	8 1/2
MF260R	Bone Cutter	FWD ANG	8 1/2
MF261R	0	BACK STR	8 1/2
MF262R	00	BACK STR	8 1/2
MF263R	000	BACK STR	8 1/2
MF264R	0000	BACK STR	8 1/2
MF265R	Bone Cutter	BACK STR	8 1/2
MF266R	0	BACK ANG	8 1/2
MF267R	00	BACK ANG	8 1/2
MF268R	000	BACK ANG	8 1/2
MF269R	0000	BACK ANG	8 1/2
MF270R	Bone Cutter	BACK ANG	8 1/2
MF321R		MICRO NERVE HOOK	8 1/2
MF322R		ULTRA MICRO NERVE HOOK	8 1/2
MF323R		BONE WAXER	8 1/2
MF320	Case - 12 Instruments (Set includes 2 cases)		

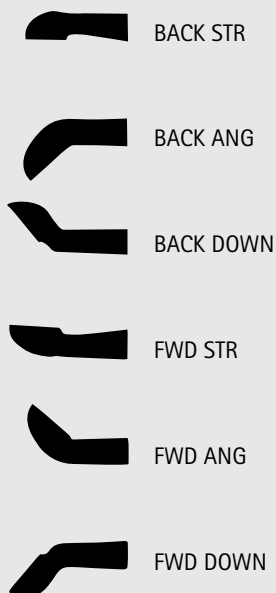

Microdiscectomy Cervical Long Instruments

Catalog Number	Tip Size (#)	Tip	Length (in.)
MF271	COMPLETE SET (Includes One Each of All Items Listed)		
MF272R	0	FWD STR	9 1/2
MF273R	00	FWD STR	9 1/2
MF274R	000	FWD STR	9 1/2
MF275R	0000	FWD STR	9 1/2
MF276R	Bone Cutter	FWD STR	9 1/2
MF277R	0	FWD ANG	9 1/2
MF278R	00	FWD ANG	9 1/2
MF279R	000	FWD ANG	9 1/2
MF280R	0000	FWD ANG	9 1/2
MF281R	Bone Cutter	FWD ANG	9 1/2
MF282R	0	BACK STR	9 1/2
MF283R	00	BACK STR	9 1/2
MF284R	000	BACK STR	9 1/2
MF285R	0000	BACK STR	9 1/2
MF286R	Bone Cutter	BACK STR	9 1/2
MF287R	0	BACK ANG	9 1/2
MF288R	00	BACK ANG	9 1/2
MF289R	000	BACK ANG	9 1/2
MF290R	0000	BACK ANG	9 1/2
MF291R	Bone Cutter	BACK ANG	9 1/2
MF292R		NERVE HOOK	9 1/2
MF293R		ULTRA MICRO NERVE HOOK	9 1/2
MF294R			9 1/2
MF320	Case - 12 Instruments (Set includes 2 cases)		

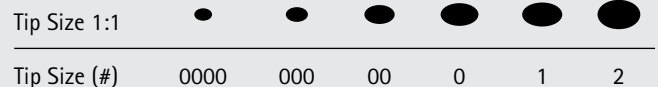

ORTHO SPINE

Microdiscectomy Lumbar Instruments

Catalog Number	Tip Size (#)	Tip	Length (in.)
MF295	COMPLETE SET (Includes One Each of All Items Listed)		
MF296R	0	FWD STR	9 1/2
MF297R	1	FWD STR	9 1/2
MF298R	2	FWD STR	9 1/2
MF299R	0	FWD ANG	9 1/2
MF300R	1	FWD ANG	9 1/2
MF301R	2	FWD ANG	9 1/2
MF302R	0	FWD DOWN	9 1/2
MF303R	1	FWD DOWN	9 1/2
MF304R	2	FWD DOWN	9 1/2
MF305R	0	BACK STR	9 1/2
MF306R	1	BACK STR	9 1/2
MF307R	2	BACK STR	9 1/2
MF308R	0	BACK ANG	9 1/2
MF309R	1	BACK ANG	9 1/2
MF310R	2	BACK ANG	9 1/2
MF311R	0	BACK DOWN	9 1/2
MF312R	1	BACK DOWN	9 1/2
MF313R	2	BACK DOWN	9 1/2
MF314R		#1 PENFIELD	9 1/2
MF315R		#2 PENFIELD	9 1/2
MF316R		NERVE HOOK	9 1/2
MF317R		#4 PENFIELD	9 1/2
MF318R		BONE WAXER	9 1/2
MF319R		SPINE PROBE	9 1/2
MF320	Case - 12 Instruments (Set includes 2 cases)		

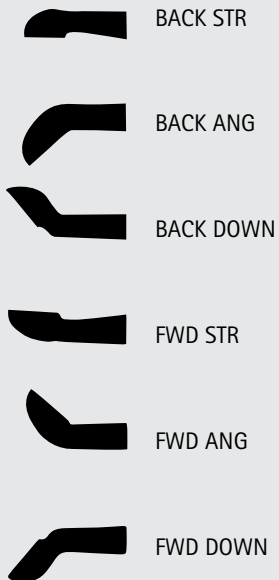

Tip Size 1:1

Tip Size (#)

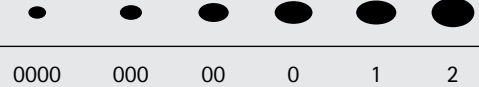

Orthopedics/Spine
Microdiscectomy Instruments

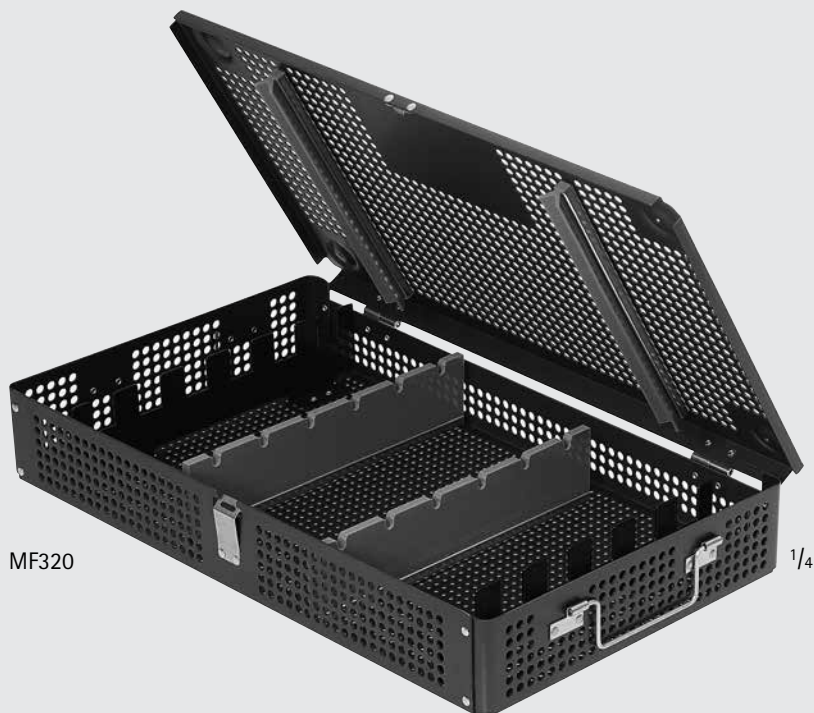

MF320

1/4

Storage Case for Microdiscectomy
Instruments

Catalog Number
MF320



FB141R-FB143R



FB141R



FB142R



FB143R

LEMMON Intima Dissector

Catalog Number	Tip	Length (in.)
FB141R	SLIGHT-CVD	6 1/2
FB142R	CVD	6 1/2
FB143R	HEAVY-CVD	6 1/2

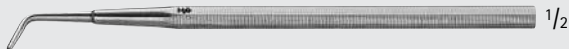

MB456R



MB456R

BUNNELL Dissecting Probe

Catalog Number	Tip	Length (in.)
MB456R	ANG	5 1/2

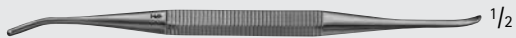

FK292R-FK293R

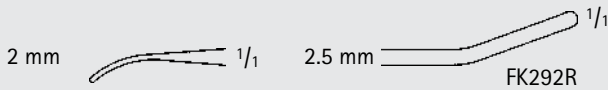

2 mm

1/1

2.5 mm

FK292R

1/1

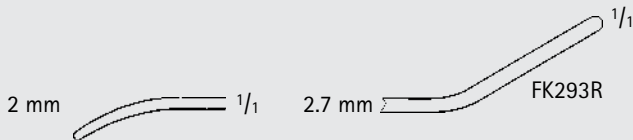

2 mm

1/1

2.7 mm

FK293R

1/1

WATSON-CHEYNE Dissector, Double Ended

Catalog Number	Blade Size (mm)	Length (in.)
FK292R	2 / 2.5	5 1/8
FK293R	2 / 2.7	7 1/2



ORTHO
SPINE

INCHES

Orthopedics/Spine

Rongeurs

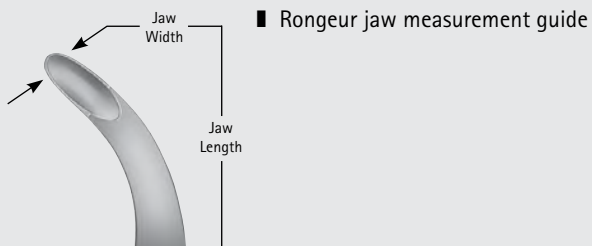

STELLBRINK Synovectomy Rongeur

Catalog Number	Jaw Size (mm)	Jaw	Length (in.)
FO399R	2.0 x 39.5	SLIGHT-CVD	6 7/8
FO400R	2 x 33	CVD	6 3/4



Synovectomy Rongeur

Catalog Number	Jaw Size (mm)	Jaw	Length (in.)
FO599R	1.8 x 24	CVD	5 1/8



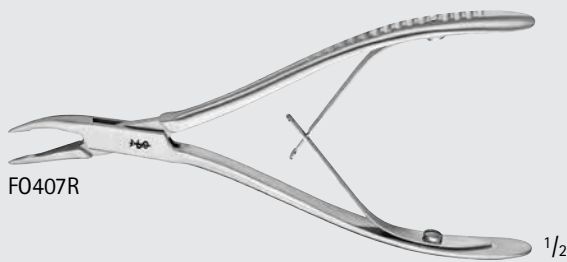
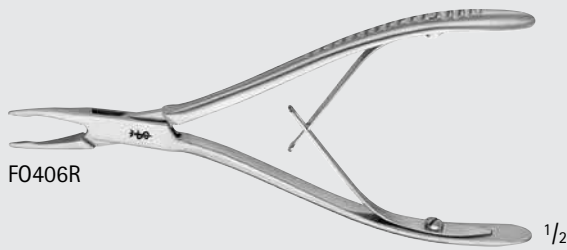

FRIEDMANN Micro Rongeur

Catalog Number	Jaw Size (mm)	Jaw	Length (in.)
FO406R	1.3 x 19	STR	5 1/2
FO407R	1.3 x 20	CVD	5 1/2

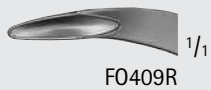
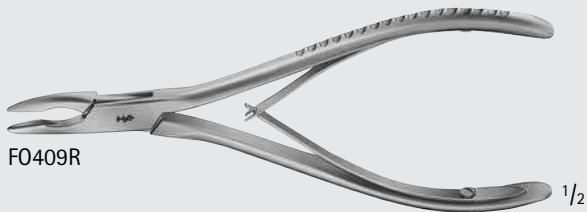

LUER-FRIEDMANN Bone Rongeur

Catalog Number	Jaw Size (mm)	Jaw	Length (in.)
FO409R	2.2 x 22	CVD	5 3/4

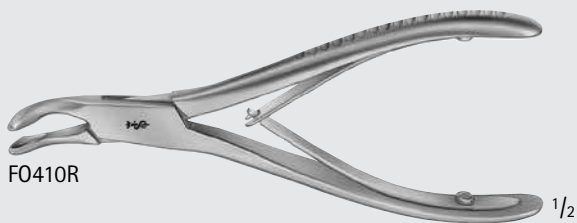

Bone Rongeur

Catalog Number	Jaw Size (mm)	Jaw	Length (in.)
FO410R	3.8 x 19	CVD	5 1/2



Orthopedics/Spine

Rongeurs

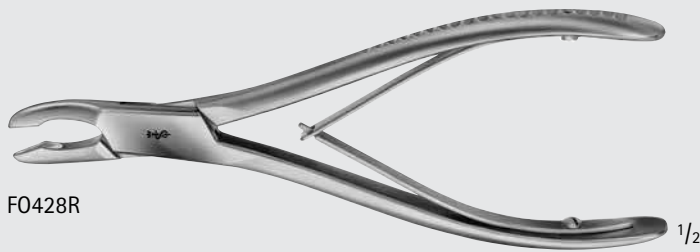

FO428R



FO428R

HAKANSSON Bone Rongeur

Catalog Number	Jaw Size (mm)	Jaw	Length (in.)
FO428R	4.5 x 24	CVD	6 3/4

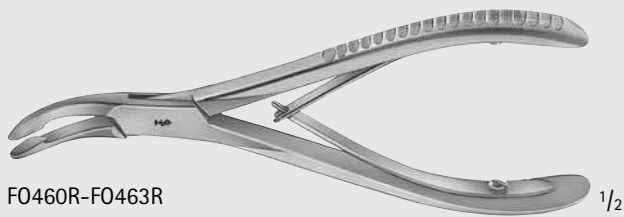

FO460R-FO463R



FO460R



FO462R



FO411R



FO412R

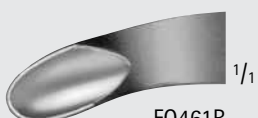

FO461R



FO463R

LUER Bone Rongeur

Catalog Number	Jaw Size (mm)	Jaw	Length (in.)
FO460R	7.5 x 25	STR	6 7/8
FO462R	9.5 x 33	STR	7
FO411R	4.2 x 20	CVD	6
FO412R	4.2 x 26	STRONG CVD	6 1/8
FO461R	7.5 x 24.5	CVD	6 7/8
FO463R	9.0 x 30	CVD	7

BLUMENTHAL Bone Rongeur

Catalog Number	Jaw Size (mm)	Jaw	Length (in.)
FO415R	3.5 x 25	30° CVD	6 1/8
FO416R	3.5 x 22	45° CVD	6



JANSEN Bone Rongeur

Catalog Number	Jaw Size (mm)	Jaw	Length (in.)
FO430R	4.2 x 35	STR	6 7/8
FO432R	4.5 x 30	CVD	6 7/8
FO442R	3.8 x 37	ANG	7 1/2

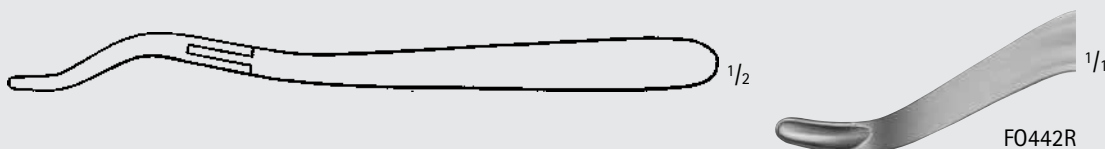
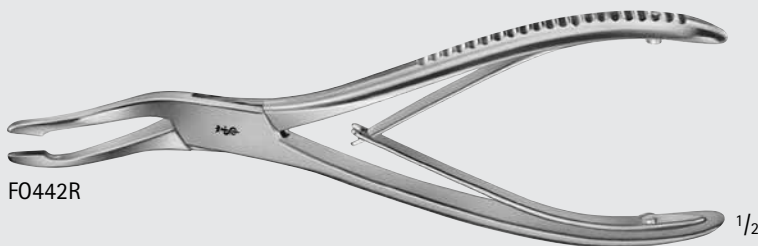

ORTHO
SPINE

Orthopedics/Spine

Rongeurs





FO440R 1/2



FO440R 1/1

ALEXANDER Bone Rongeur

Catalog Number	Jaw Size (mm)	Jaw	Length (in.)
FO440R	3.2 x 27	ANG	5 1/2

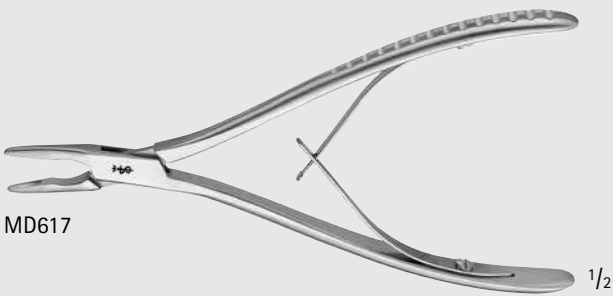

MD617 1/2



MD617 1/1

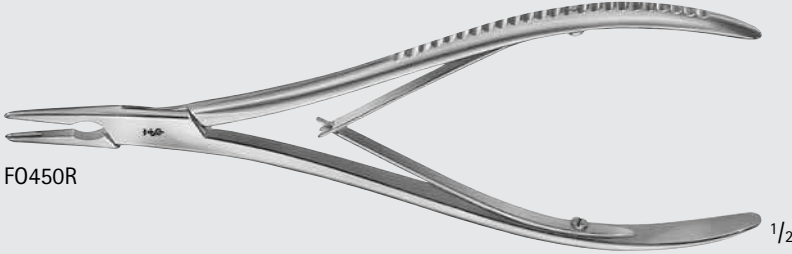

FO450R 1/2



FO450R 1/1

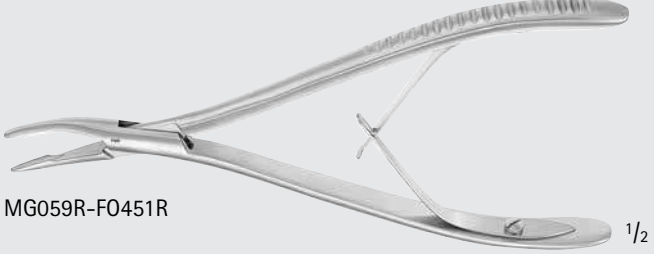

MG059R-FO451R 1/2



MG059R 1/1



FO451R 1/1

LEMPERT Bone Rongeur

Catalog Number	Jaw Size (mm)	Jaw	Length (in.)
MD617	2.0 x 23	DEL, STR	6 1/2
FO450R	2.2 x 27	STR	7 7/8
MG059R	2.5 x 30	CVD	6 1/4
FO451R	2.2 x 27	CVD	7 7/8

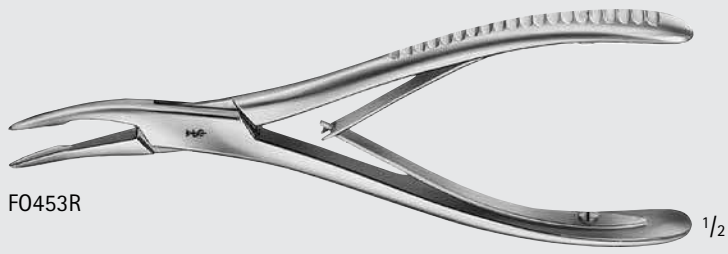

FO453R $\frac{1}{2}$



FO453R $\frac{1}{1}$

BEYER Bone Rongeur

Catalog Number	Jaw Size (mm)	Jaw	Length (in.)
FO453R	3.2 x 32	CVD	7

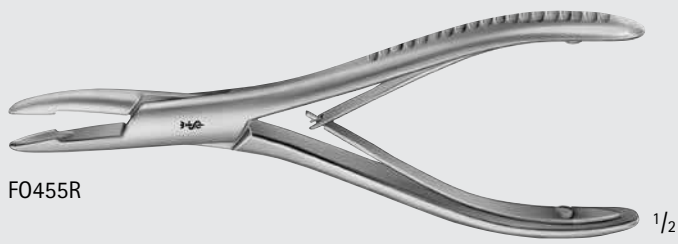

FO455R $\frac{1}{2}$

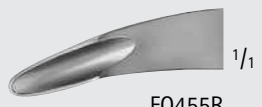

FO455R $\frac{1}{1}$

MEAD Bone Rongeur

Catalog Number	Jaw Size (mm)	Jaw	Length (in.)
FO455R	3.5 x 30	CVD	6 $\frac{1}{2}$

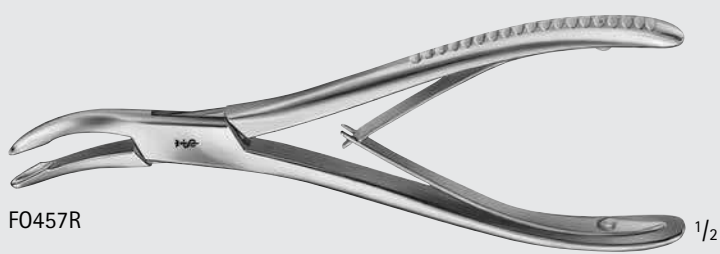

FO457R $\frac{1}{2}$



FO457R $\frac{1}{1}$

BANE-HARTMANN Bone Rongeur

Catalog Number	Jaw Size (mm)	Jaw	Length (in.)
FO457R	4.0 x 32	CVD	6 $\frac{7}{8}$



Orthopedics/Spine

Rongeurs

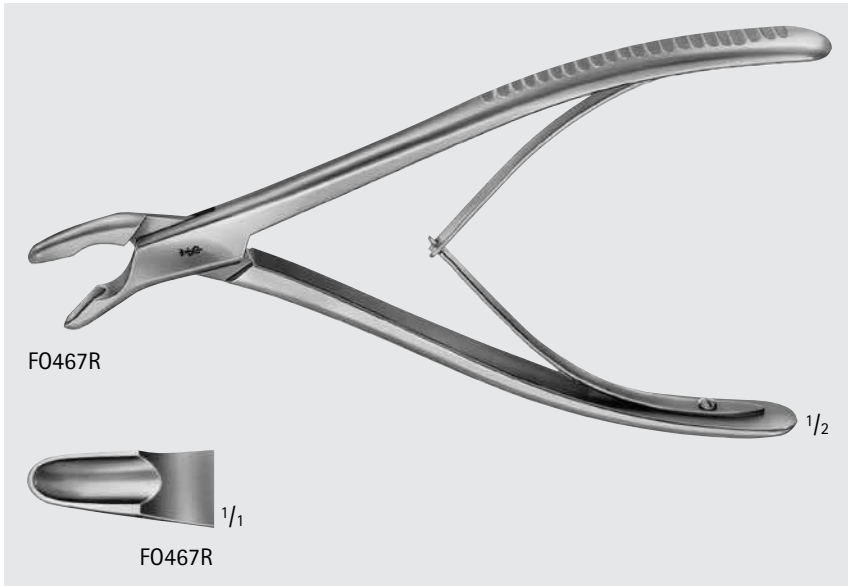
TROTTER Bone Rongeur

Catalog Number	Jaw Size (mm)	Jaw	Length (in.)
FO467R	6.5 x 24	CVD	8

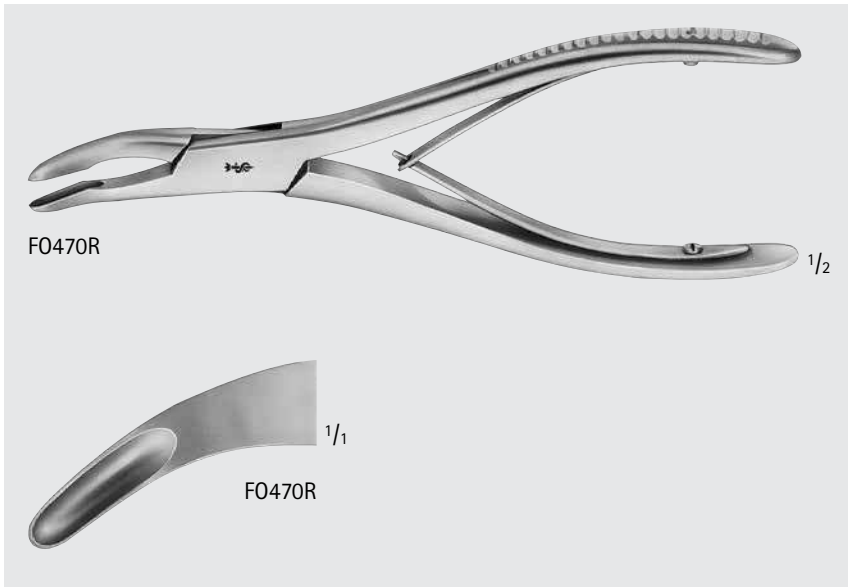

OLIVECRONA Bone Rongeur

Catalog Number	Jaw Size (mm)	Jaw	Length (in.)
FO470R	5.0 x 36.5	CVD	8



GULEKE Bone Rongeur

Catalog Number	Jaw Size (mm)	Jaw	Length (in.)
FO472R	6.5 x 27	CVD	8

PENNYBACKER Bone Rongeur

Catalog Number	Jaw Size (mm)	Jaw	Length (in.)
FO475R	4.0 x 26	STR	8

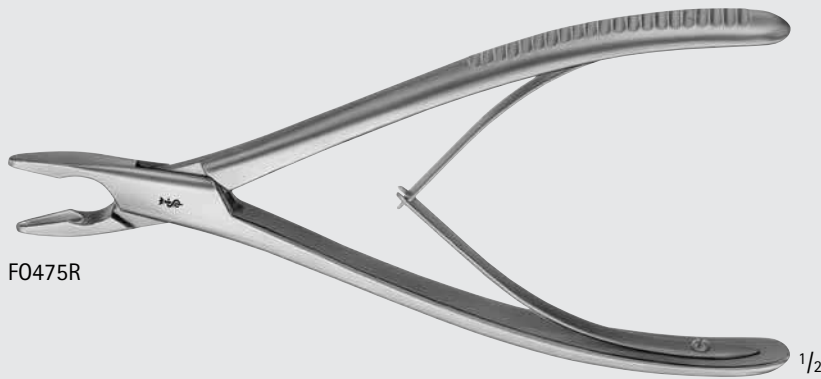

FO475R

1/2



1/1

FO475R

ADSON Cranial Rongeur

Catalog Number	Jaw Size (mm)	Jaw	Length (in.)
MD615	21.0 x 31.5	STR	7 7/8

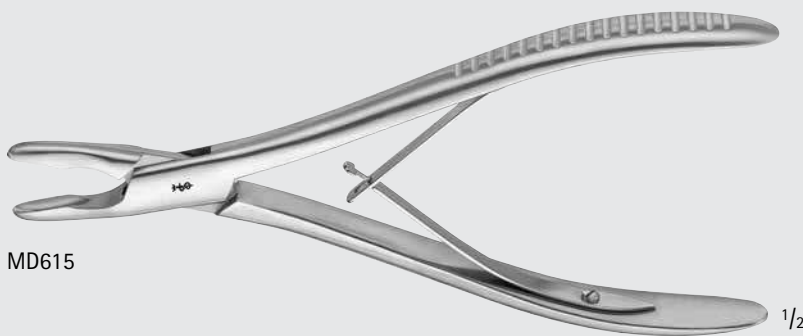

MD615

1/2



1/1

MD615

KLEINERT-KUTZ Rongeur, Double Action

Catalog Number	Jaw Size (mm)	Jaw	Length (in.)
MG060R	3.0 x 15.0	SLIGHT, CVD	6 1/8

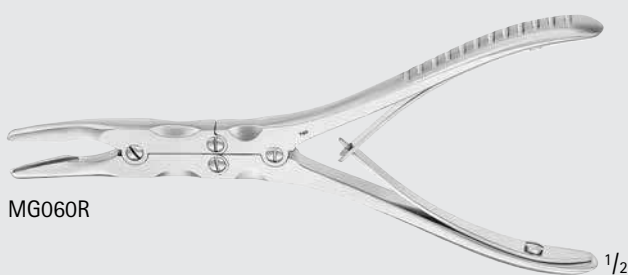

MG060R

1/2



1/1

MG060R



ORTHO
SPINE

INCHES

Orthopedics/Spine

Rongeurs

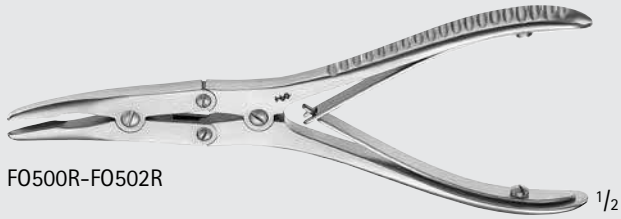

FO500R-FO502R

1/2



FO500R

1/1



FO502R

1/1

BOEHLER Bone Rongeur, Double Action

Catalog Number	Jaw Size (mm)	Jaw	Jaw End	Length (in.)
FO500R	3.0 x 27.0	CVD	NARR	6 1/8
FO502R	3.5 x 30.0	CVD	WIDE	6 1/8



FO514R

1/2

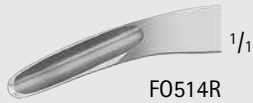

FO514R

1/1

BEYER Bone Rongeur, Double Action

Catalog Number	Jaw Size (mm)	Jaw	Length (in.)
FO514R	4.0 x 30.0	CVD	7



FO511R

1/2

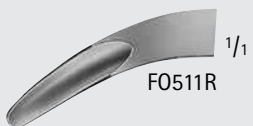

FO511R

1/1

MAYFIELD Bone Rongeur, Double Action

Catalog Number	Jaw Size (mm)	Jaw	Length (in.)
FO511R	3.5 x 23	CVD	6 7/8

ZAUFAL-JANSEN Bone Rongeur, Double Action

Catalog Number	Jaw Size (mm)	Jaw	Length (in.)
FO515R	4.5 x 29.0	CVD	7

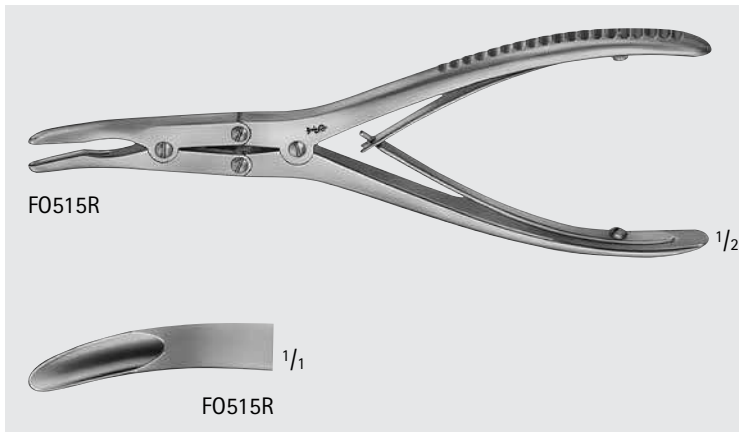

RUSKIN Bone Rongeur, Double Action

Catalog Number	Jaw Size (mm)	Jaw	Length (in.)
MG056R	2	STR, MINI	6 1/4
MG057R	2	CVD, MINI	6 1/4
MG058R	3	CVD, MINI	6 1/4
FO518R	5	CVD	7 1/2
MG579R	6	CVD	7 1/4

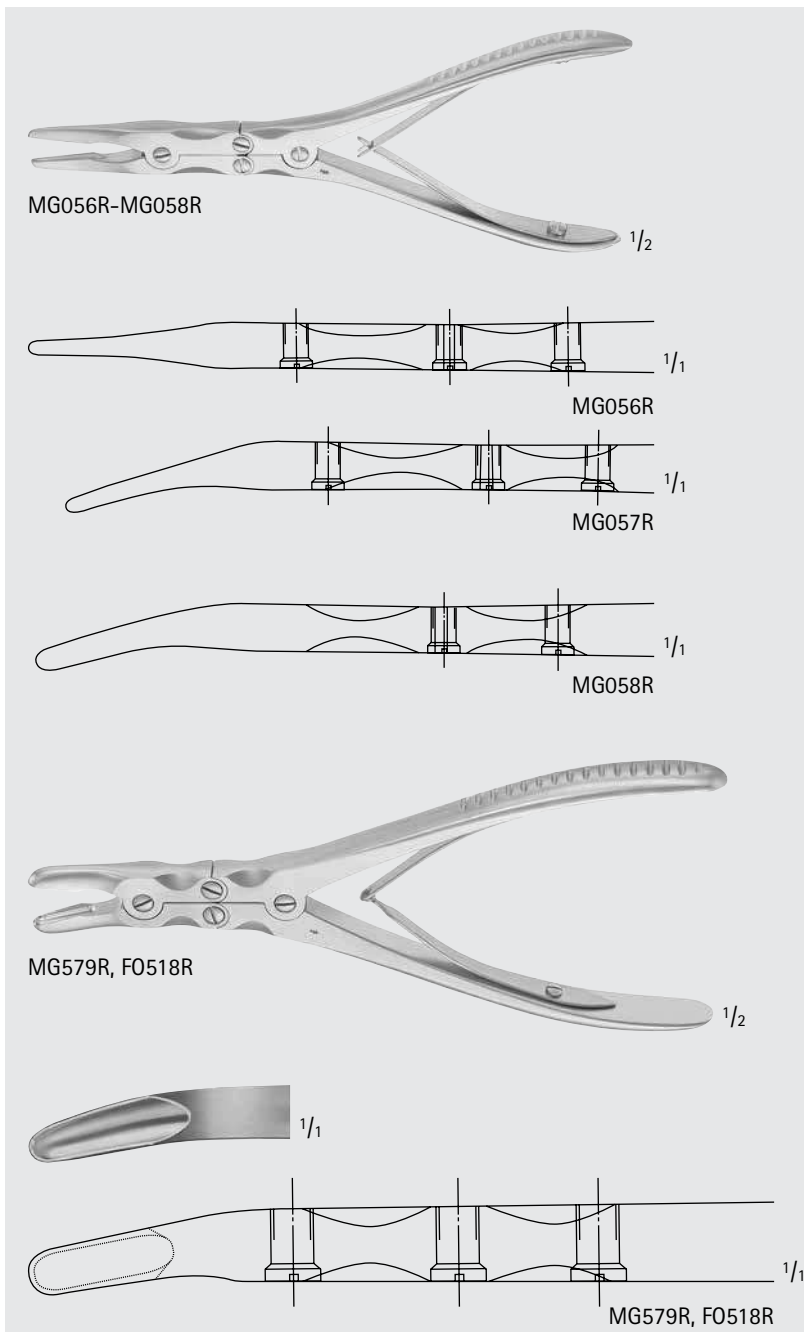

Orthopedics/Spine

Rongeurs

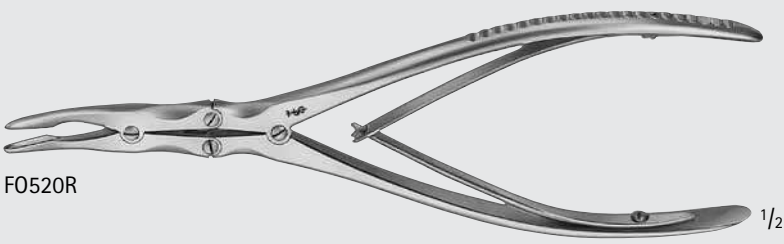
MARQUARDT Bone Rongeur, Double Action

Catalog Number	Jaw Size (mm)	Jaw	Length (in.)
F0520R	3.5 x 15.5	CVD	7 7/8

F0520R $\frac{1}{2}$



F0520R $\frac{1}{1}$

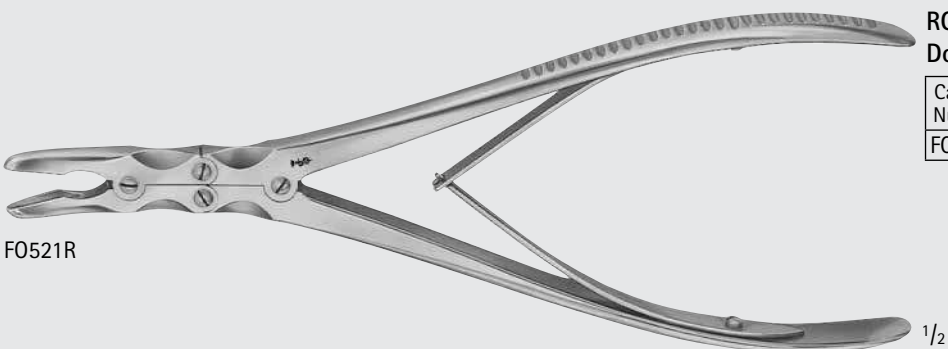

ROETTGEN-RUSKIN Bone Rongeur, Double Action

Catalog Number	Jaw Size (mm)	Jaw	Length (in.)
F0521R	6.3 x 30	CVD	9 1/2

F0521R $\frac{1}{2}$



F0521R $\frac{1}{1}$



SMITH-PETERSON Rongeur

Catalog Number	Jaw Size (mm)	Jaw	Length (in.)
MG577R	3	STR	9 1/2

MG577R $\frac{1}{2}$



MG577R $\frac{1}{1}$

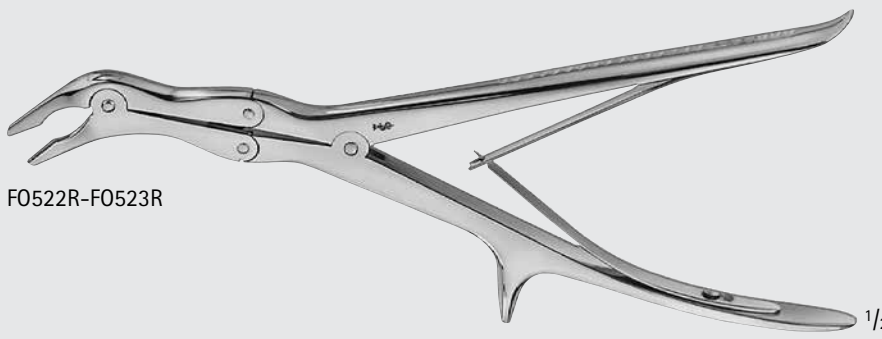

F0522R-F0523R

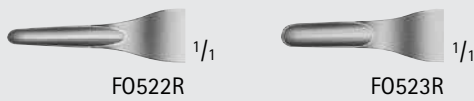

ECHLIN Bone Rongeur, Double Action, Duckbill

Catalog Number	Jaw Size (mm)	Jaw	Length (in.)
F0522R	2 x 10	ANG	9
F0523R	3 x 10	ANG	9

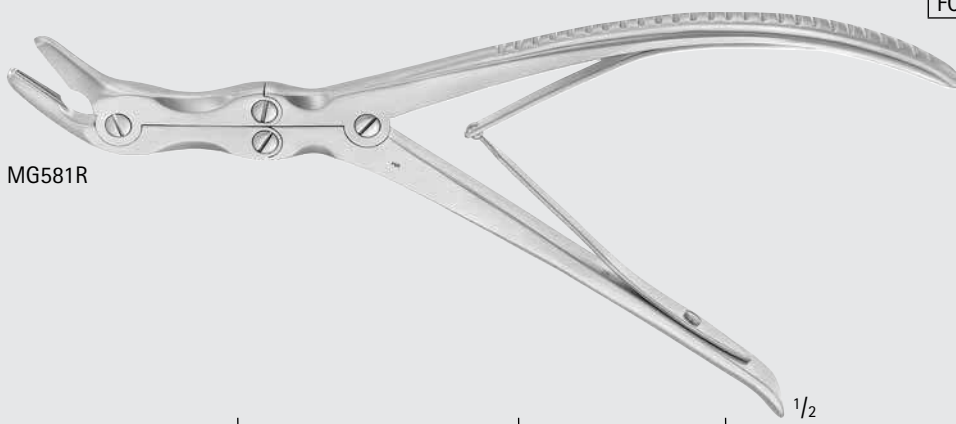

MG581R

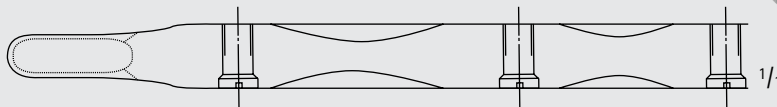

MG581R



F0526R-F0527R

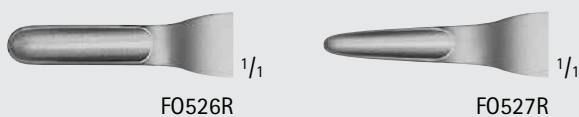

LEKSELL Bone Rongeur, Double Action, Duckbill

Catalog Number	Jaw Size (mm)	Jaw	Length (in.)
MG581R	5	FULL CVD	9
F0526R	5 x 16	ANG	9 5/8
F0527R	3 x 16	ANG	9 5/8



Orthopedics/Spine

Rongeurs

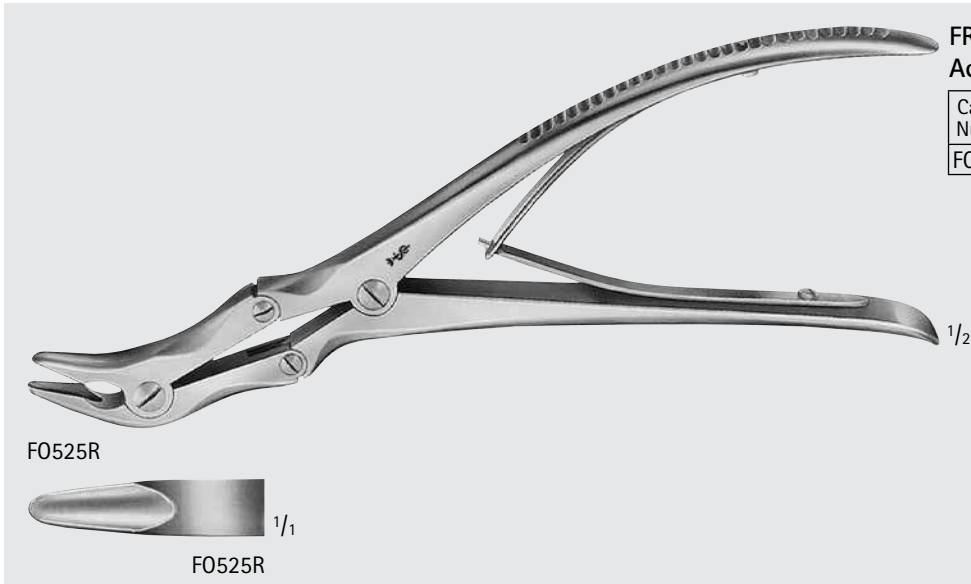

FRYKHOLM Bone Rongeur, Double Action

Catalog Number	Jaw Size (mm)	Jaw	Length (in.)
F0525R	4.5 x 25	ANG	9 1/2

F0525R

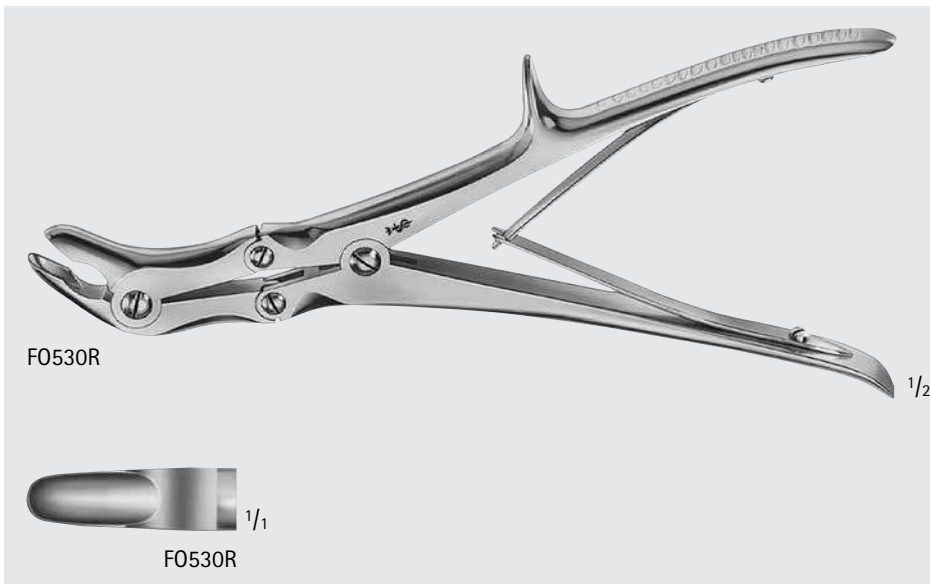

STILLE Bone Rongeur, Double Action, Duckbill

Catalog Number	Jaw Size (mm)	Jaw	Length (in.)
F0530R	7.0 x 25	ANG	9

F0530R

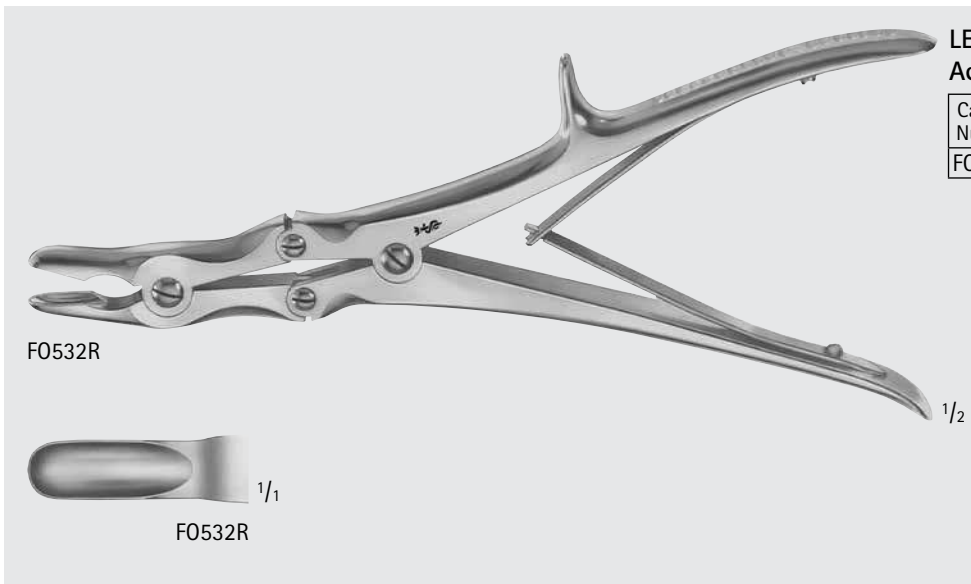
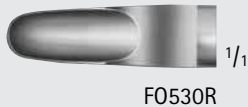

LEKSELL-STILLE Bone Rongeur, Double Action, Duckbill

Catalog Number	Jaw Size (mm)	Jaw	Length (in.)
F0532R	7.5 x 29.5	ANG	9 1/2

F0532R



SYPERT Bone Rongeur, Double Action

Catalog Number	Jaw Size (mm)	Jaw	Length (in.)
FG052R	8.0 x 35.0	ANG	14 1/4

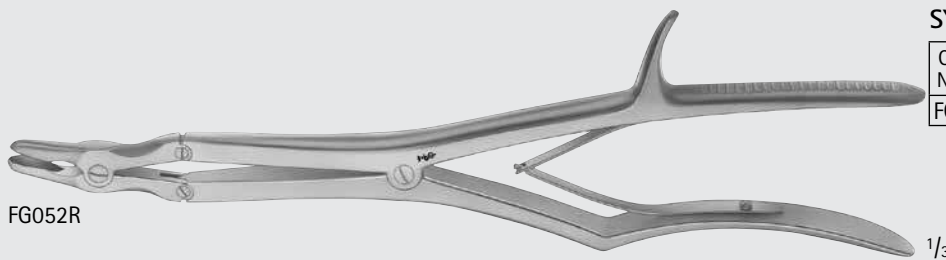

FG052R

1/3



1/1

FG052R

STILLE-RUSKIN Bone Rongeur, Double Action

Catalog Number	Jaw Size (mm)	Jaw	Length (in.)
FO534R	8.0 x 34.0	CVD	9 1/2

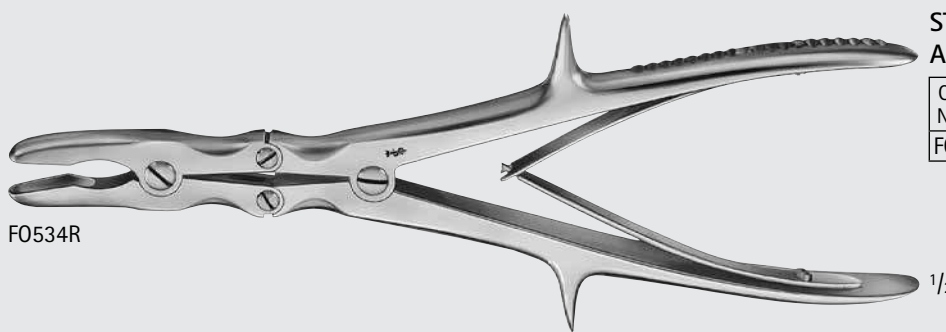

FO534R

1/2



1/1

FO534R

SAUERBRUCH-CORYLLOS Rongeur, Double Action

Catalog Number	Length (in.)
FO570R	12 1/4
FO572R	12 1/4



FO570R-FO572R

1/3



1/1

FO570R

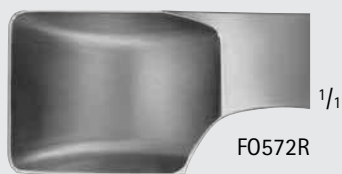

1/1

FO572R



ORTHO
SPINE

INCHES

Orthopedics/Spine

Rongeurs

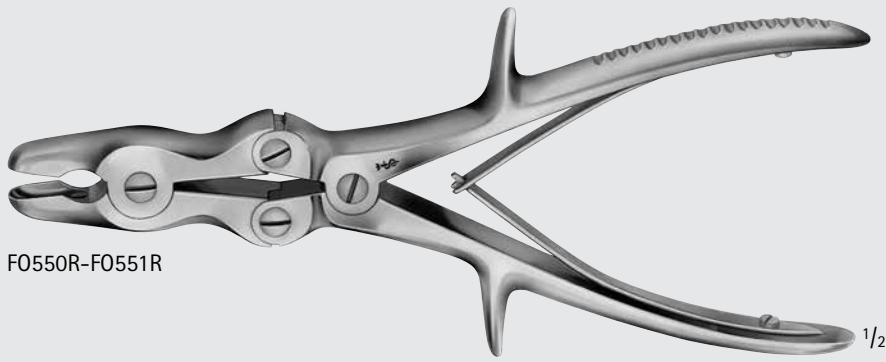

F0550R-F0551R

LUER-STILLE Bone Rongeur, Double Action

Catalog Number	Jaw Size (mm)	Jaw	Length (in.)
F0550R	10.5 x 27.5	STR	8 7/8
F0551R	10 x 26.5	CVD	8 7/8



F0550R



F0551R

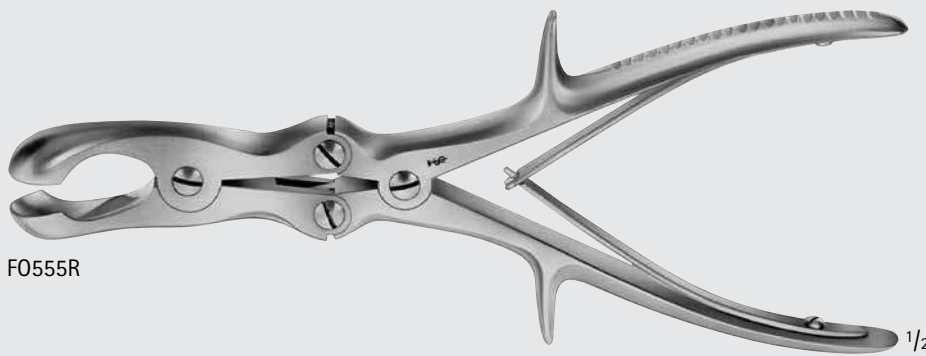

F0555R

SEMB Bone Rongeur, Double Action

Catalog Number	Jaw Size (mm)	Jaw	Length (in.)
F0555R	16.5 x 38.5	CVD	9 1/2

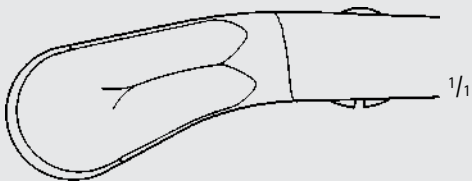

1/1



1/1

F0555R



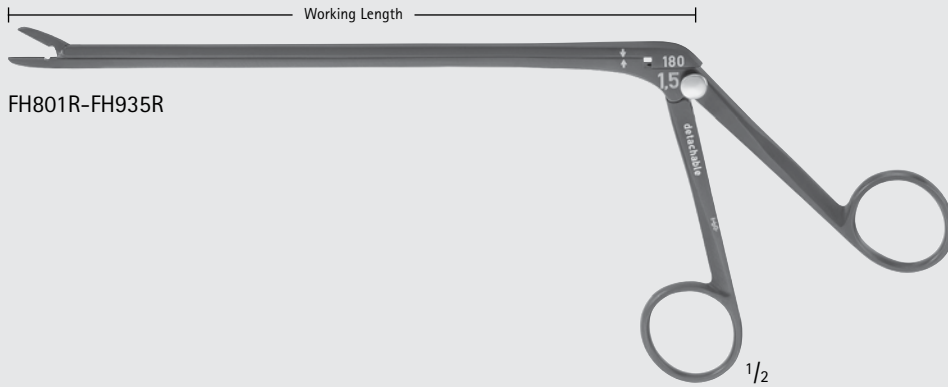

Noir Detachable Rongeurs

Working Length (in.)	Jaw	Jaw	1.5 mm	2.0 mm	3.0 mm	4.0 mm	5.0 mm
6		STR	FH801B	FH802B	FH803B	FH804B	FH805B
6		UP	FH901B	FH902B	FH903B	FH904B	FH905B
7		STR	FH811B	FH812B	FH813B	FH814B	FH815B
7		UP	FH911B	FH912B	FH913B	FH914B	FH915B
7 7/8		STR	FH821B	FH822B	FH823B	FH824B	FH825B
7 7/8		UP	FH921B	FH922B	FH923B	FH924B	FH925B
9		STR	FH891B	FH892B	FH893B	FH894B	FH895B
9		UP	FH931B	FH932B	FH933B	FH934B	FH935B
11		STR	-	-	FH837B	FH838B	FH839B

Orthopedics/Spine

Noir™ Rongeurs



Noir Detachable Rongeur

Working Length (in.)	Jaw	Jaw	1.5 mm	2.0 mm	3.0 mm	4.0 mm	5.0 mm
6		STR	FH851B	FH852B	FH853B	FH854B	FH855B
7		UP	FH951B	FH952B	FH953B	FH954B	FH955B
7		STR	FH861B	FH862B	FH863B	FH864B	FH865B
7		UP	FH961B	FH962B	FH963B	FH964B	FH965B
7 7/8		STR	FH871B	FH872B	FH873B	FH874B	FH875B
7 7/8		UP	FH971B	FH972B	FH973B	FH974B	FH975B
9		STR	FH881B	FH882B	FH883B	FH884B	FH885B
9		UP	FH981B	FH982B	FH983B	FH984B	FH985B
11		STR	-	-	FH847B	FH848B	FH849B



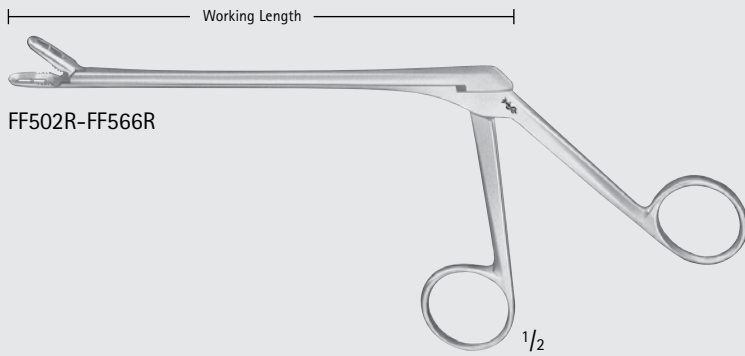



FF502R-FF566R

 1/1
FF502R, FF532R, FF562R

 1/1
FF503R, FF533R, FF563R

 1/1
FF504R, FF534R, FF564R

 1/1
FF535R, FF565R

 1/1
FF536R, FF566R

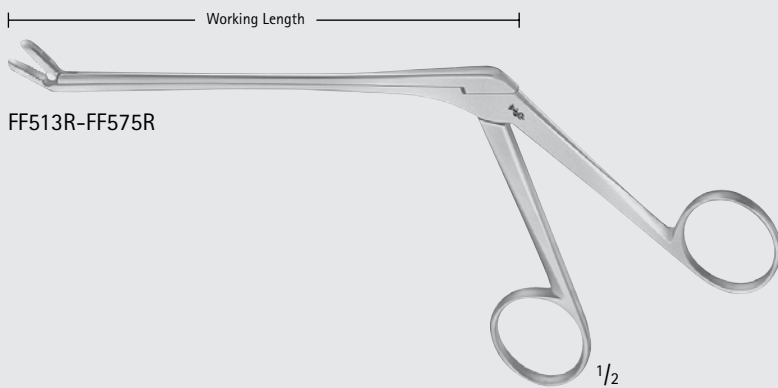

FF513R-FF575R

 1/1
FF513R, FF543R, FF573R

 1/1
FF514R, FF544R, FF574R

 1/1
FF545R, FF575R

CASPAR Rongeur W/ Teeth

Catalog Number	Jaw Size (mm)	Jaw	Working Length (in.)
FF502R	2 x 12	STR	5 1/2
FF532R	2 x 12	STR	6 1/4
FF562R	2 x 12	STR	7 1/4
FF503R	3 x 12	STR	5 1/2
FF533R	3 x 12	STR	6 1/4
FF563R	3 x 12	STR	7 1/4
FF504R	4 x 14	STR	5 1/2
FF534R	4 x 14	STR	6 1/4
FF564R	4 x 14	STR	7 1/4
FF535R	5 x 14	STR	6 1/4
FF565R	5 x 14	STR	7 1/4
FF536R	6 x 16	STR	6 1/4
FF566R	6 x 16	STR	7 1/4
FF513R	3 x 12	UP	5 1/2
FF543R	3 x 12	UP	6 1/4
FF573R	3 x 12	UP	7 1/4
FF514R	4 x 14	UP	5 1/2
FF544R	4 x 14	UP	6 1/4
FF574R	4 x 14	UP	7 1/4
FF545R	5 x 14	UP	6 1/4
FF575R	5 x 14	UP	7 1/4



Orthopedics/Spine

Rongeurs

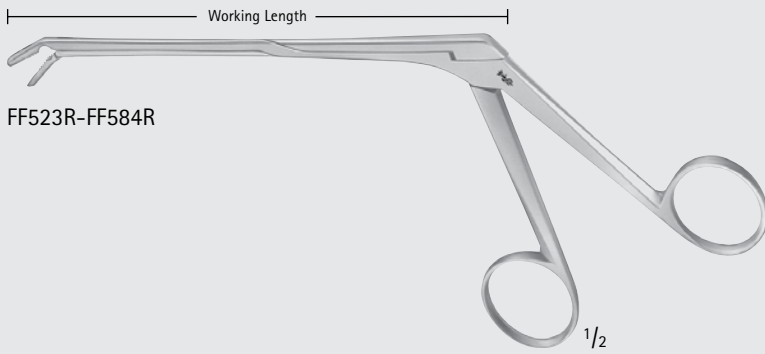

FF523R-FF584R



FF523R, FF553R, FF583R



FF524R, FF554R, FF584R

CASPAR Rongeur W/ Teeth (continued)

Catalog Number	Jaw Size (mm)	Jaw	Working Length (in.)
FF523R	3 x 12	DOWN	5 1/2
FF553R	3 x 12	DOWN	6 1/4
FF583R	3 x 12	DOWN	7 1/4
FF524R	4 x 14	DOWN	5 1/2
FF554R	4 x 14	DOWN	6 1/4
FF584R	4 x 14	DOWN	7 1/4

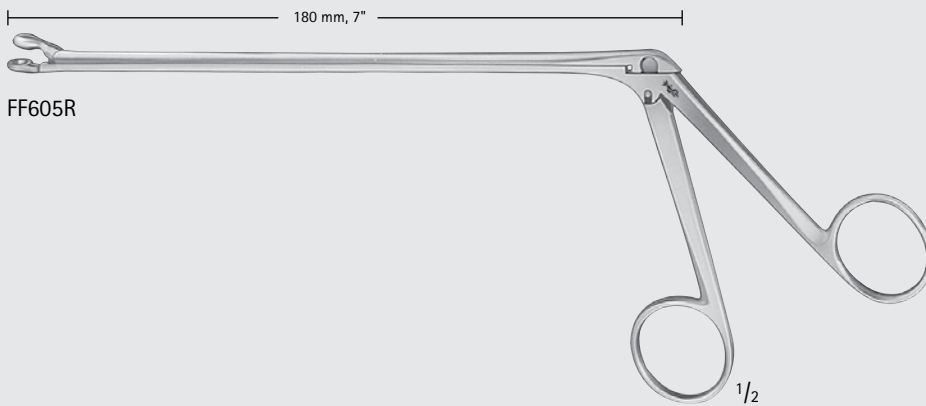

FF605R

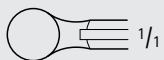

FF605R

OLDBERG Rongeur

Catalog Number	Diameter (mm)	Working Length (in.)
FF605R	7.0	7



195 mm, 7 1/2"

FF599R-FF600R

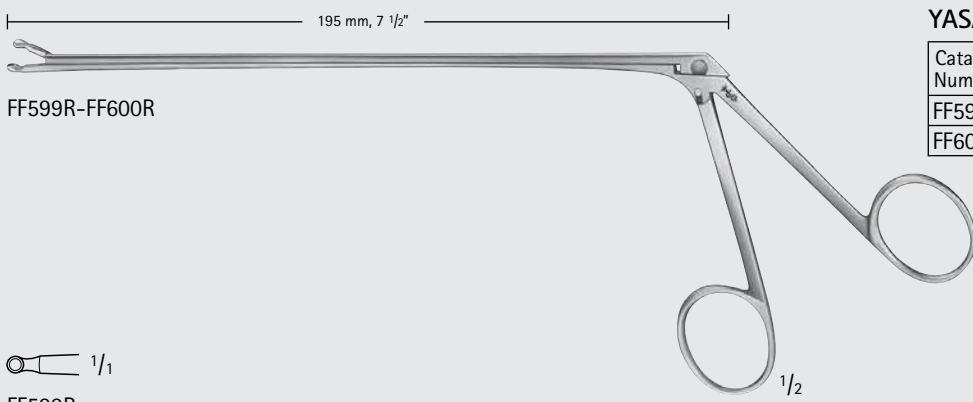

1/1
FF599R

1/1
FF600R

YASARGIL Rongeur

Catalog Number	Diameter (mm)	Working Length (in.)
FF599R	2.2	7 1/2
FF600R	3.5	7 1/2

140 mm, 5 1/2"

FF765R

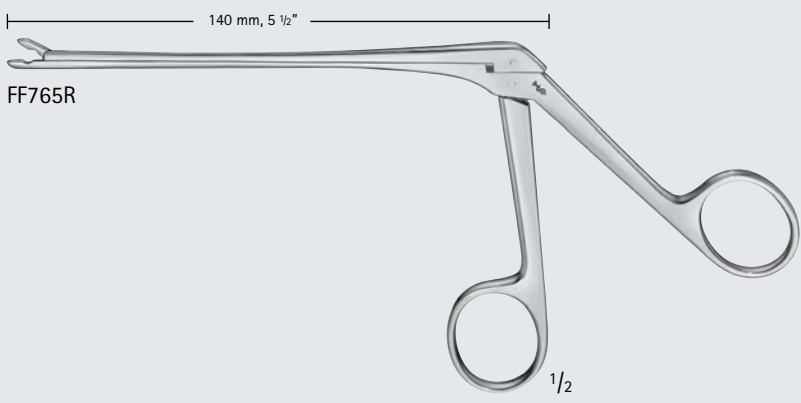

1/1
FF765R

BECK Rongeur

Catalog Number	Jaw Size (mm)	Working Length (in.)
FF765R	2 x 10	5 1/8

210 mm, 8 1/4"

FF808R

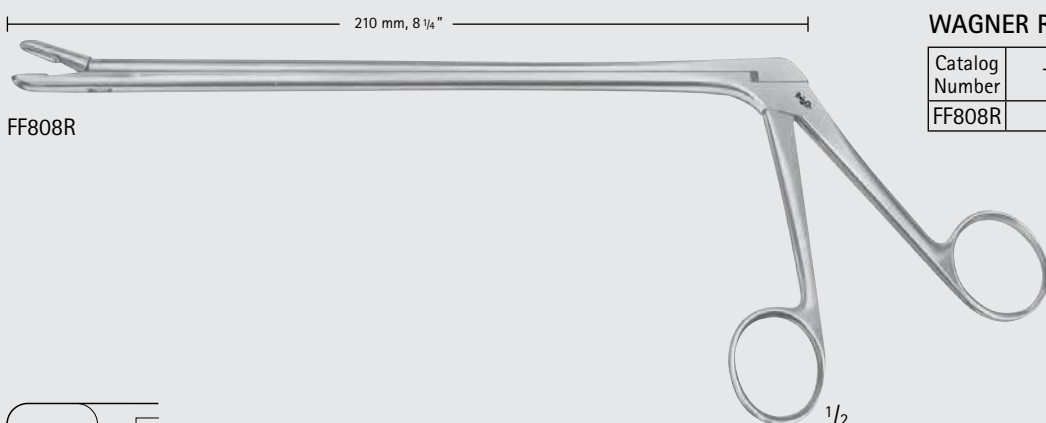

1/1
FF808R

WAGNER Rongeur

Catalog Number	Jaw Size (mm)	Working Length (in.)
FF808R	5.5	8 1/4



ORTHO
SPINE

INCHES

CUSHING Rongeur

Catalog Number	Jaw Size (mm)	Jaw	Style	Working Length (in.)
MD537R	1.5 x 10	STR	STANDARD	7
MN090R	1.5 x 10	STR	DELICATE	9
FF803R	2 x 10	STR	-	7
MN093R	2 x 10	STR	STANDARD	9
MN096R	2 x 10	STR	STANDARD	11
MN099R	2 x 10	STR	STANDARD	12
MD538R	1.5 x 10	UP	STANDARD	7
MD618	2 x 10	UP	-	7
MN091R	1.5 x 10	UP	DELICATE	9
MN094R	2 x 10	UP	STANDARD	9
MN097R	2 x 10	UP	STANDARD	11
MN100R	2 x 10	UP	STANDARD	12
MD539R	1.5 x 10	DOWN	STANDARD	7
MN092R	1.5 x 10	DOWN	DELICATE	9
MD619	2 x 10	DOWN	-	7
MN095R	2 x 10	DOWN	STANDARD	9
MN098R	2 x 10	DOWN	STANDARD	11
MN101R	2 x 10	DOWN	STANDARD	12

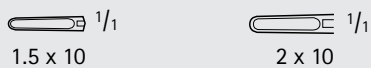
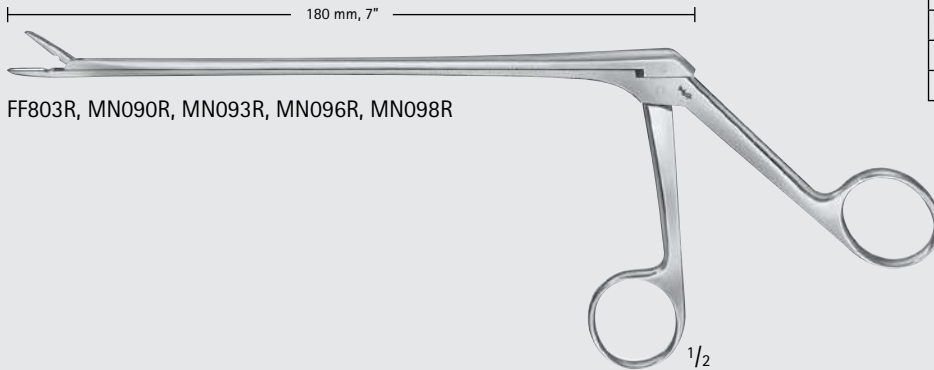

LOVE-GRUENWALD Rongeur

Catalog Number	Jaw Size (mm)	Jaw	Working Length (in.)
FF805R	3 x 10	STR	7
MN102R	3 x 10	STR	9
MN105R	3 x 10	STR	11
MN108R	3 x 10	STR	12
MF446R	2 x 10	UP	5
FF806R	3 x 10	UP	7
MN103R	3 x 10	UP	9
MN106R	3 x 10	UP	11
MN109R	3 x 10	UP	12
MF447R	2 x 10	DOWN	5
FF810R	3 x 10	DOWN	7
MN104R	3 x 10	DOWN	9
MN107R	3 x 10	DOWN	11
MN110R	3 x 10	DOWN	12

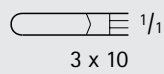
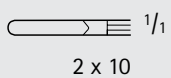
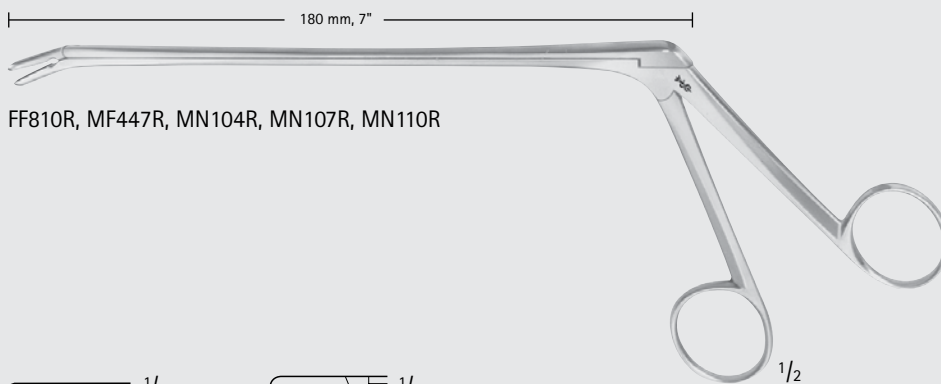
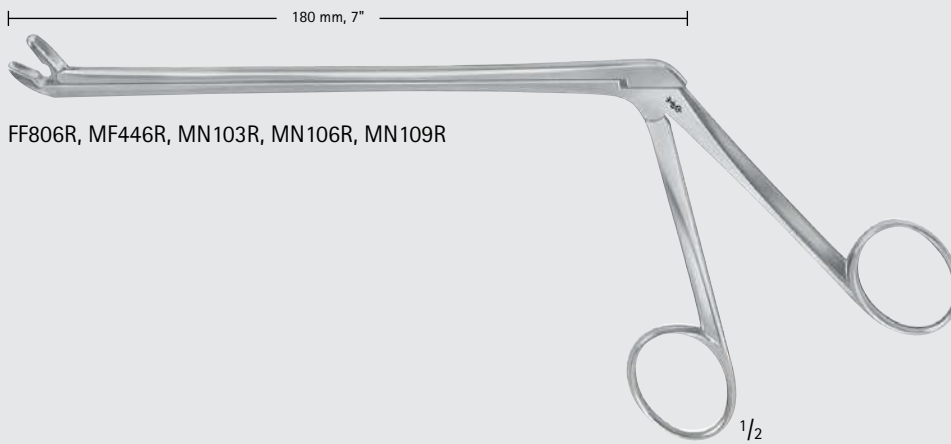
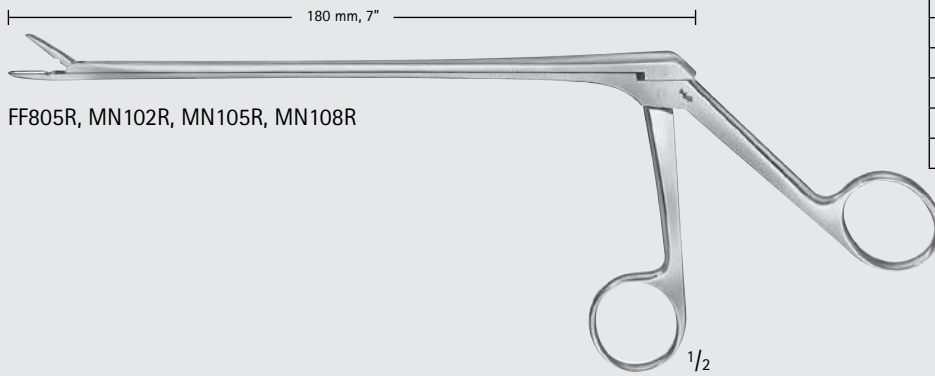

ORTHO
SPINE

Orthopedics/Spine

Rongeurs

SPURLING Rongeur

Catalog Number	Jaw Size (mm)	Jaw	Working Length (in.)
FF807R	4 x 10	STR	7
MN111R	4 x 10	STR	9
MN114R	4 x 10	STR	11
MN117R	4 x 10	STR	12
FF814R	4 x 10	UP	7
MN112R	4 x 10	UP	9
MN115R	4 x 10	UP	11
MN118R	4 x 10	UP	12
FF811R	4 x 10	DOWN	7
MN113R	4 x 10	DOWN	9
MN116R	4 x 10	DOWN	11
MN119R	4 x 10	DOWN	12

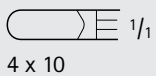
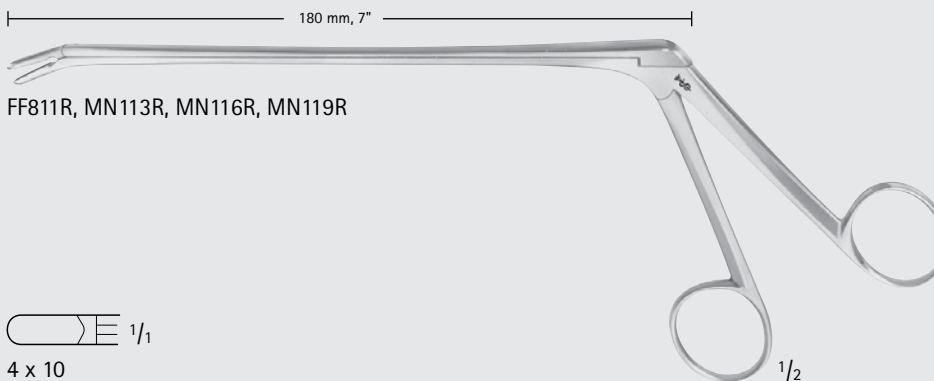
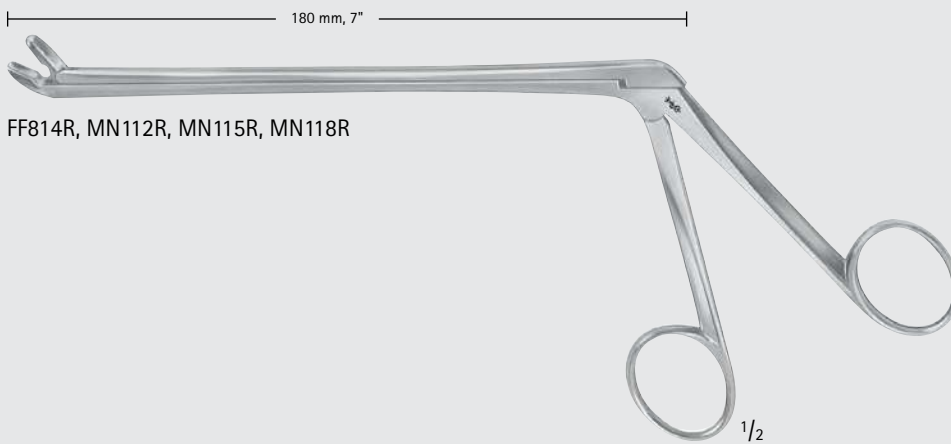
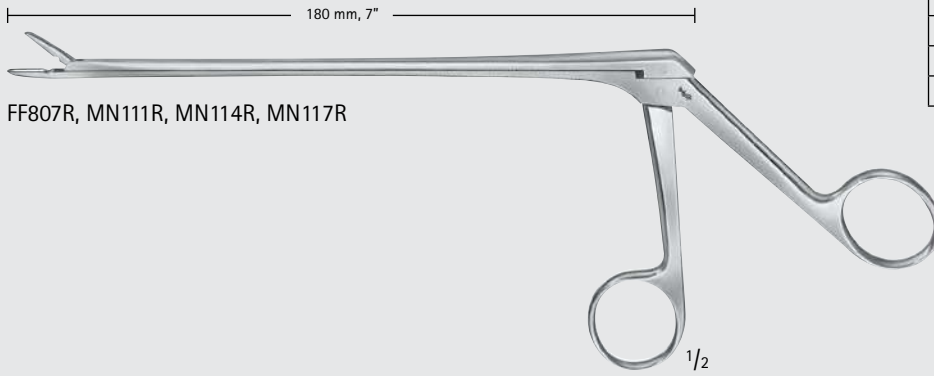

IVD Rongeur

Catalog Number	Jaw Size (mm)	Jaw	Working Length (in.)
MN120R	5 x 10	STR	9
MN123R	5 x 10	STR	11
MN126R	5 x 10	STR	12
MN121R	5 x 10	UP	9
MN124R	5 x 10	UP	11
MN127R	5 x 10	UP	12
MN122R	5 x 10	DOWN	9
MN125R	5 x 10	DOWN	11
MN128R	5 x 10	DOWN	12

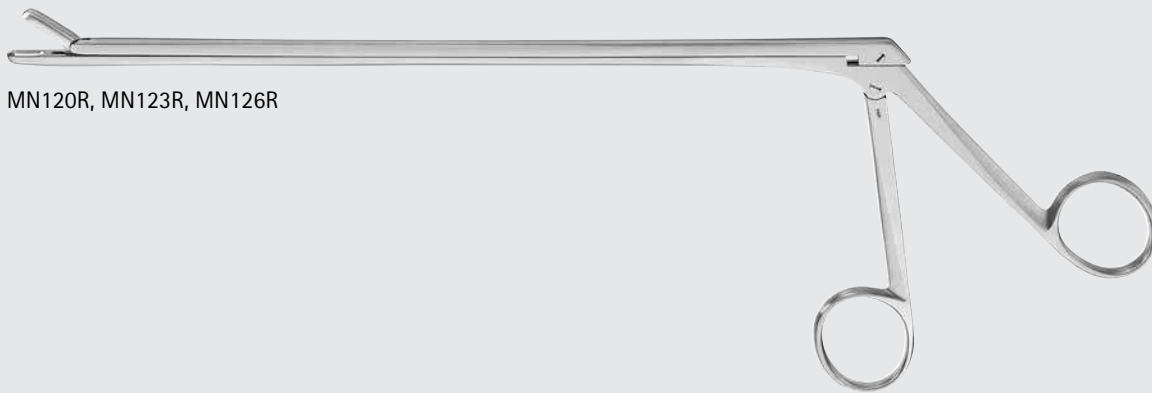

MN120R, MN123R, MN126R

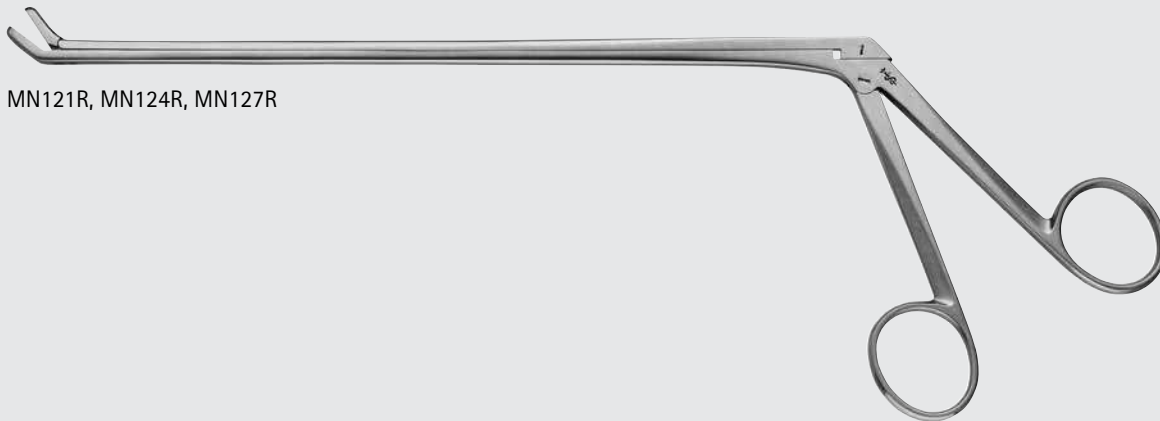

MN121R, MN124R, MN127R



MN122R, MN125R, MN128R

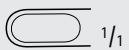

MN120R, MN123R, MN126R

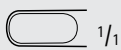

MN121R, MN124R, MN127R



MN122R, MN125R, MN128R



Orthopedics/Spine

Rongeurs

WAGNER Rongeur

Catalog Number	Jaw Size (mm)	Working Length (in.)
FF818R	5.5	7 7/8

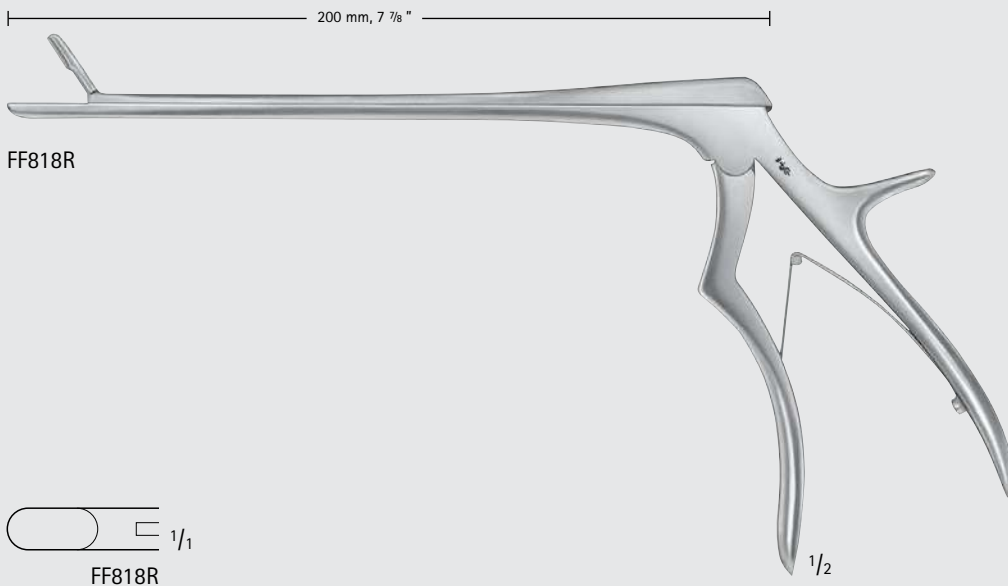

ORTHO
SPINE

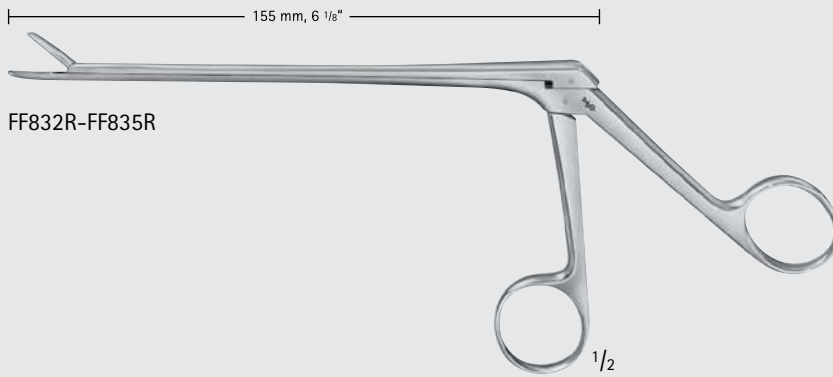

FF832R-FF835R

CASPAR Rongeur

Catalog Number	Jaw Size (mm)	Jaw	Working Length (in.)
FF832R	2.0	STR	6 1/8
FF833R	3.0	STR	6 1/8
FF834R	4.0	STR	6 1/8
FF835R	5.0	STR	6 1/8
FF842R	2.0	UP	6 1/8
FF843R	3.0	UP	6 1/8
FF844R	4.0	UP	6 1/8
FF852R	2.0	DOWN	6 1/8
FF853R	3.0	DOWN	6 1/8
FF854R	4.0	DOWN	6 1/8

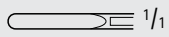

FF832R, FF842R, FF852R

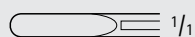

FF833R, FF843R, FF853R

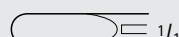

FF834R, FF844R, FF854R

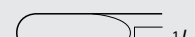

FF835R

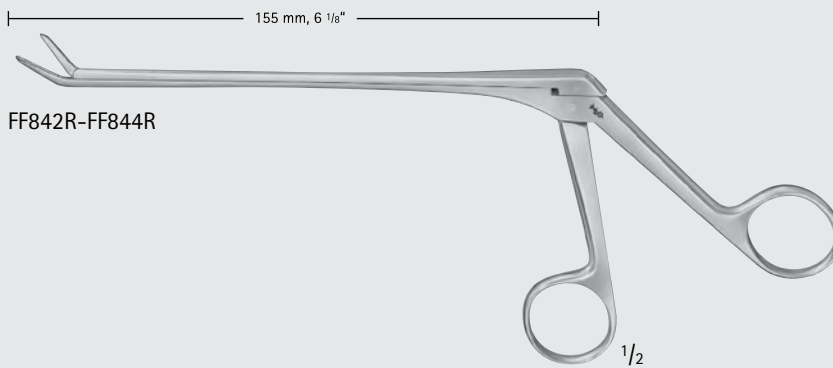

FF842R-FF844R

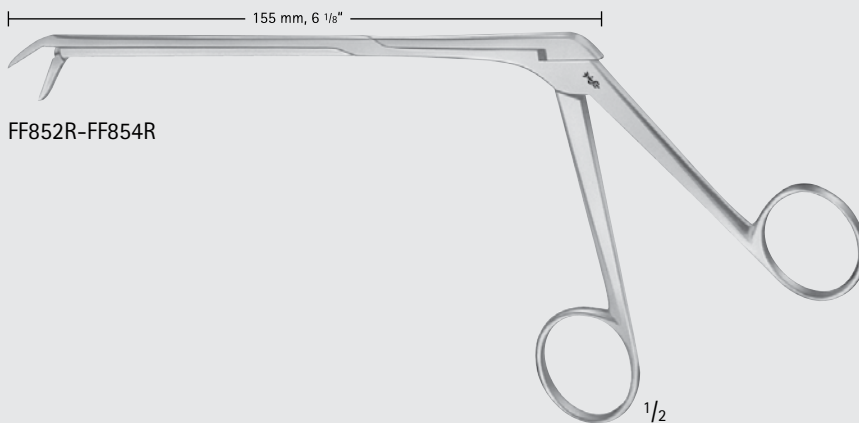

FF852R-FF854R



INCHES

Orthopedics/Spine

Rongeurs



180 mm, 7"

FF856R-FF857R

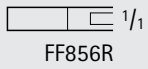

FF856R

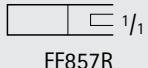

FF857R

1/2

CASPAR Heavy Rongeur, F/ Removal of Hard Disc Pathology

Catalog Number	Jaw Size (mm)	Jaw	Working Length (in.)
FF856R	3.0	STR	7
FF857R	4.0	STR	7

SYPERT Rongeur

Catalog Number	Jaw Size (mm)	Jaw	Working Length (in.)
FG057R	5 x 20	UP	10 1/4

260 mm, 10 1/4"

FG057R



FG057R

1/2

KRAEMER Grasping Forceps, W/ Catch

Catalog Number	Working Length (in.)
FO820R	6

150 mm, 6"

FO820R

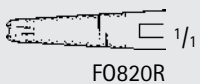

FO820R

1/2

PEAPOD Disc Rongeur

Catalog Number	Jaw Size (mm)	Jaw	Working Length (in.)
MF054R	2 x 6	UP	5 1/2
MF456R	3 x 6	UP	5 1/4
MF457R	4 x 6	UP	5 1/4

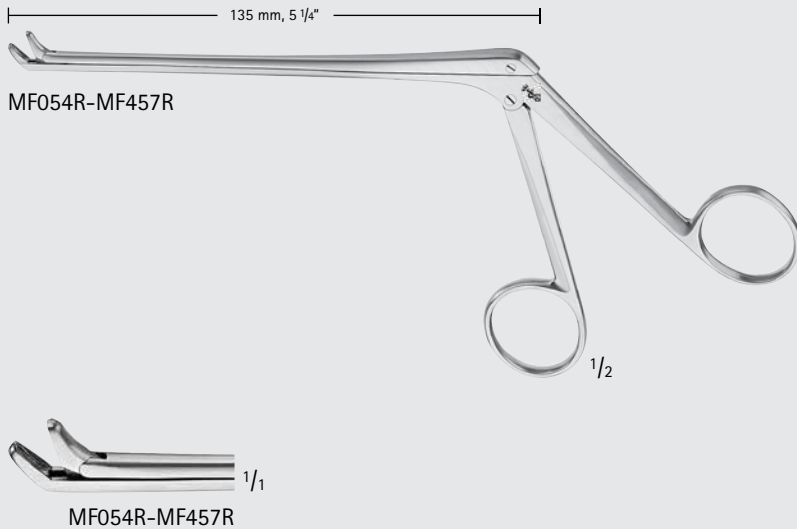

DECKER Rongeur

Catalog Number	Jaw Size (mm)	Jaw	Working Length (in.)
MF055R	2 x 6	STR	6
MF462R	2 x 6	UP	6
MF463R	2 x 6	DOWN	6

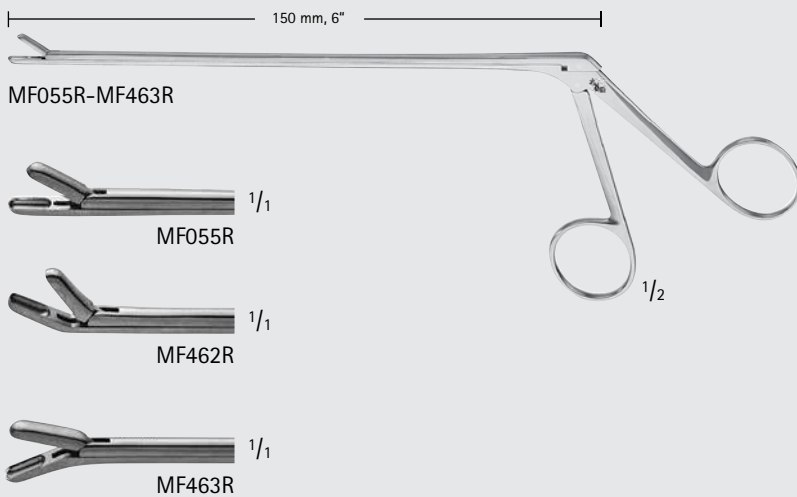

STEVENSON Grasping Forceps

Catalog Number	Jaw Size (mm)	Jaw	Working Length (in.)
MF411R	6.0	STR	5 1/8

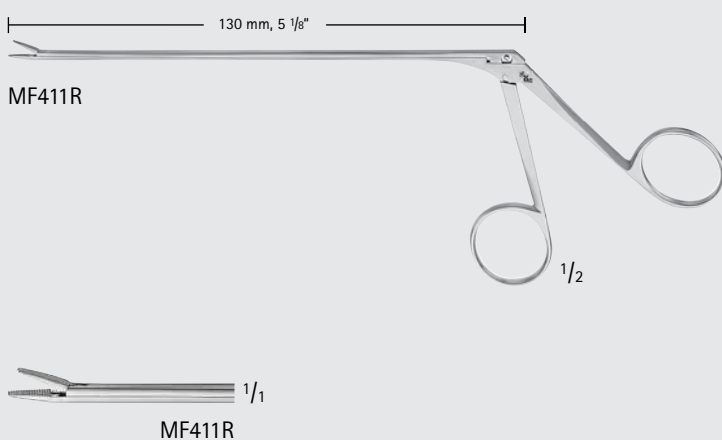

ORTHO
SPINE

INCHES

Orthopedics/Spine

Rongeurs

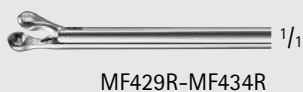
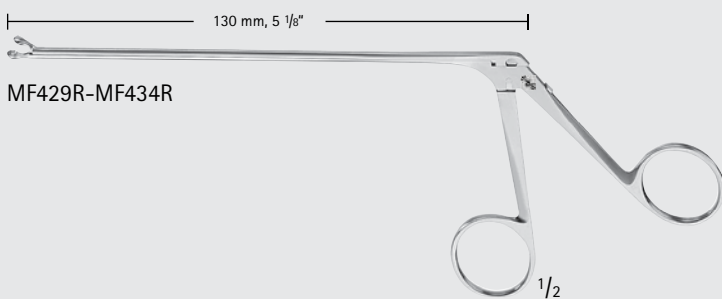

Rhoton Style Cup Forceps

Catalog Number	Jaw Size (mm)	Jaw	Working Length (in.)
MF429R	0.5	STR	5 1/8
MF432R	1.0	STR	5 1/8
MF435R	2.0	STR	5 1/8
MF436R	3.0	STR	5 1/8
MF437R	4.0	STR	5 1/8
MF438R	5.0	STR	5 1/8
MF430R	0.5	RIGHT	5 1/8
MF433R	1.0	RIGHT	5 1/8
MF431R	0.5	LEFT	5 1/8
MF434R	1.0	LEFT	5 1/8

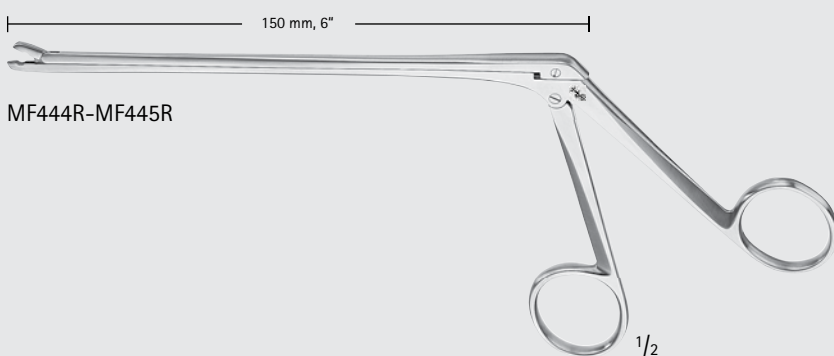

SELVERSTONE Rongeur

Catalog Number	Jaw Size (mm)	Jaw	Working Length (in.)
MF444R	2 x 3	STR	6
MF445R	2 x 5	STR	6

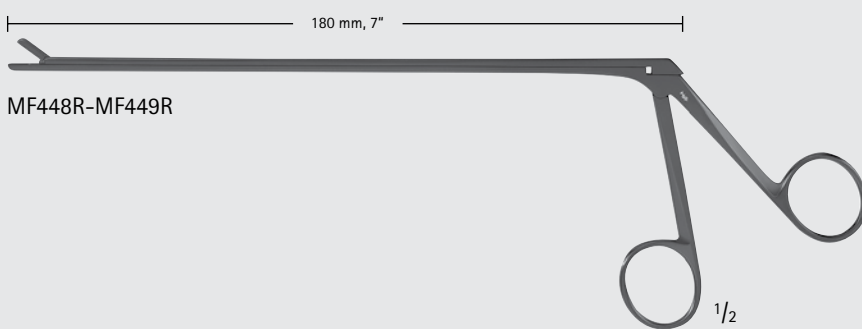

Black Coated Micro Pituitary Rongeur

Catalog Number	Jaw Size (mm)	Jaw	Working Length (in.)
MF448R	2 x 6	STR	7
MF449R	2 x 6	UP	7



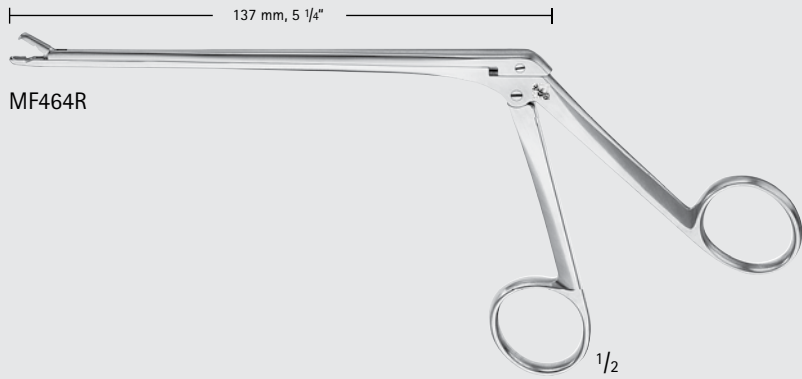

MF464R

WILLIAMS Discectomy Forceps

Catalog Number	Jaw Size (mm)	Jaw	Working Length (in.)
MF464R	2 x 6	STR	5 1/4



MF464R

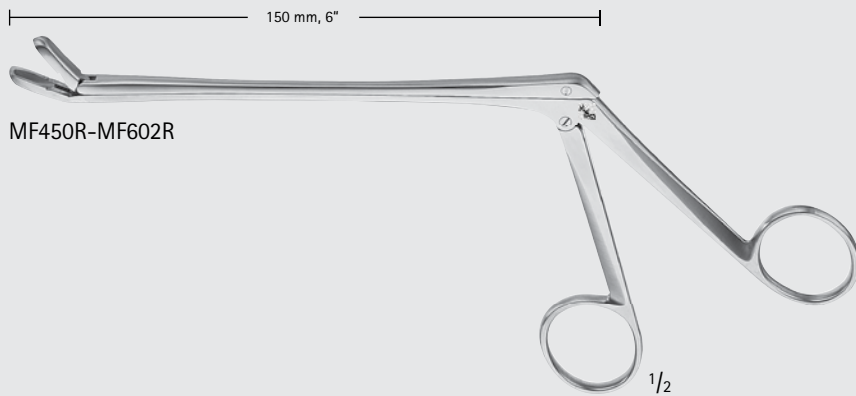

MF450R-MF602R

CLOWARD Style Rongeur

Catalog Number	Jaw Size (mm)	Jaw	Working Length (in.)
MF450R	6 x 10	STR	5 1/4
MF600R	6 x 10	STR	6
MF451R	6 x 10	UP	5 1/4
MF601R	6 x 10	UP	6
MF452R	6 x 10	DOWN	5 1/4
MF602R	6 x 10	DOWN	6



MF450R-MF602R



Orthopedics/Spine
Kerrison Bone Punches

SYPERT Kerrison Bone Punch

Catalog Number	Jaw Size (mm)	Tip	Working Length (in.)
FG055R	5.5	40° UP	9 3/4

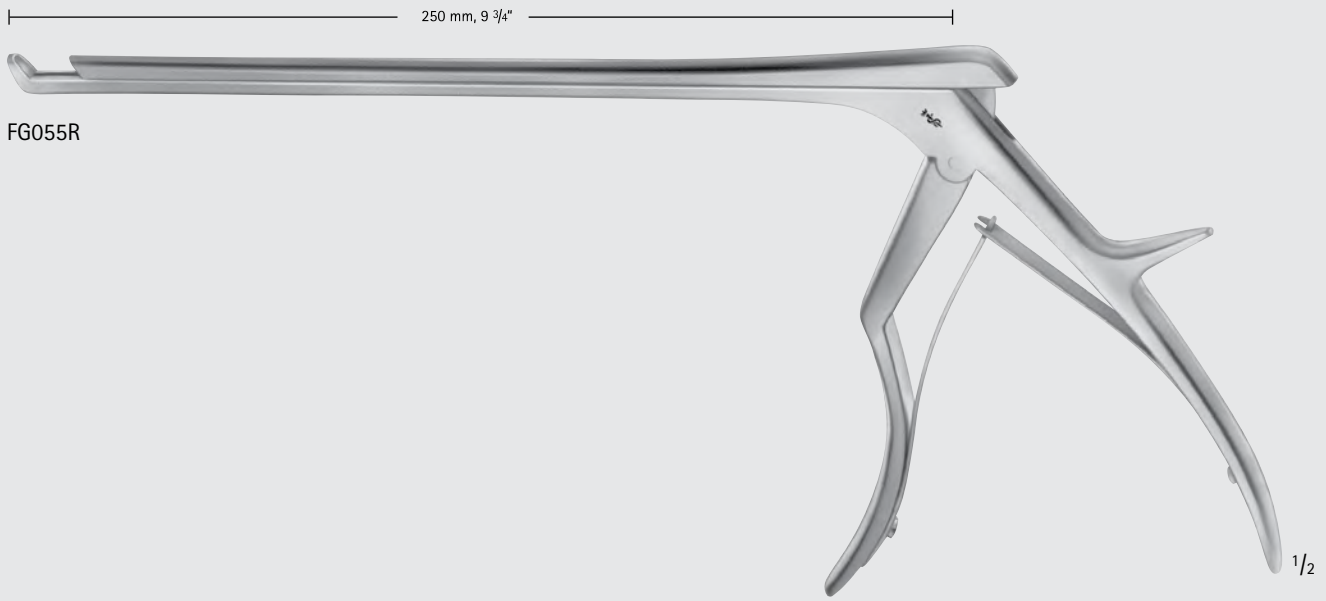

Three Primary Styles

- Non Detachable, silver
- Detachable, silver
- Detachable, ceramic NOIR coating

For more information see our brochure DOC400.

Complete Size and Footplate Range

- Regular and thin footplates
- 7", 8", 9", 11" lengths
- 1-6 mm bite sizes
- 15 mm Laminectomy jaw length
- 40° and 90° up and down jaw positions

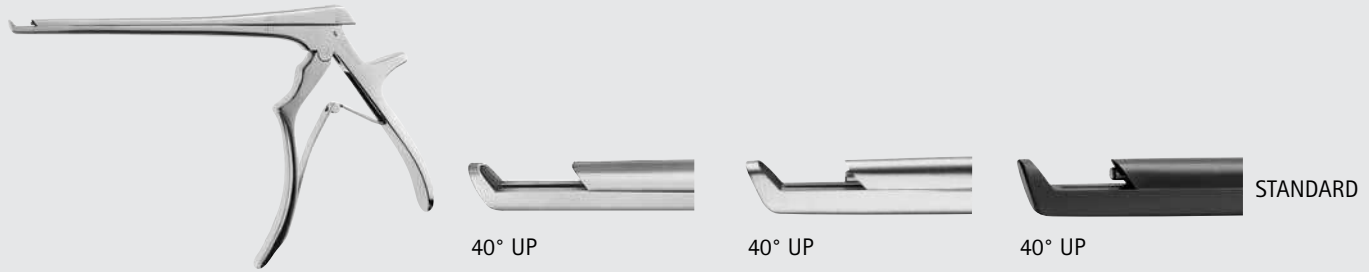

Working Length (in.)	Jaw Size (mm)	Footplate	Non Detachable, Silver	Ejector	Detachable, Silver	Ejector	Detachable, NOIR Coating	Ejector
7	1.0	STANDARD	FF715R	-	FK900R	-	FK900B	-
7	1.5	STANDARD	FF638R	-	FK911R	-	FK911B	-
7	2.0	STANDARD	FF717R	-	FK901R	✓	FK901B	✓
7	2.5	STANDARD	FF639R	-	FK912R	✓	FK912B	✓
7	3.0	STANDARD	FF720R	-	FK902R	✓	FK902B	✓
7	4.0	STANDARD	FF724R	-	FK903R	✓	FK903B	✓
7	5.0	STANDARD	FF722R	-	FK904R	✓	FK904B	✓
7	6.0	STANDARD	FF726R	-	FK905R	✓	FK905B	✓
7 7/8	1.0	STANDARD	FF691R	-	FK960R	-	FK960B	-
7 7/8	1.5	STANDARD	FF649R	-	FK966R	-	FK966B	-
7 7/8	2.0	STANDARD	FF737R	-	FK913R	✓	FK913B	✓
7 7/8	2.5	STANDARD	FF657R	-	FK967R	✓	FK967B	✓
7 7/8	3.0	STANDARD	FF738R	-	FK914R	✓	FK914B	✓
7 7/8	4.0	STANDARD	FF727R	-	FK915R	✓	FK915B	✓
7 7/8	5.0	STANDARD	FF728R	-	FK916R	✓	FK916B	✓
7 7/8	6.0	STANDARD	FF729R	-	FK917R	✓	FK917B	✓
9	1.0	STANDARD	FF674R	-	FK918R	-	FK918B	-
9	2.0	STANDARD	FF682R	-	FK919R	✓	FK919B	✓
9	3.0	STANDARD	FF683R	-	FK920R	✓	FK920B	✓
9	4.0	STANDARD	FF684R	-	FK921R	✓	FK921B	✓
9	5.0	STANDARD	FF685R	-	FK922R	✓	FK922B	✓
11	1.0	STANDARD	FF696R	-	FK981R	-	FK981B	-
11	2.0	STANDARD	FF686R	-	FK986R	✓	FK986B	✓
11	3.0	STANDARD	FF687R	-	FK987R	✓	FK987B	✓
11	4.0	STANDARD	FF688R	-	FK988R	✓	FK988B	✓
11	5.0	STANDARD	FF689R	-	FK989R	✓	FK989B	✓
11	6.0	STANDARD	FF690R	-	-	-	-	-

Orthopedics/Spine

Kerrison Bone Punches

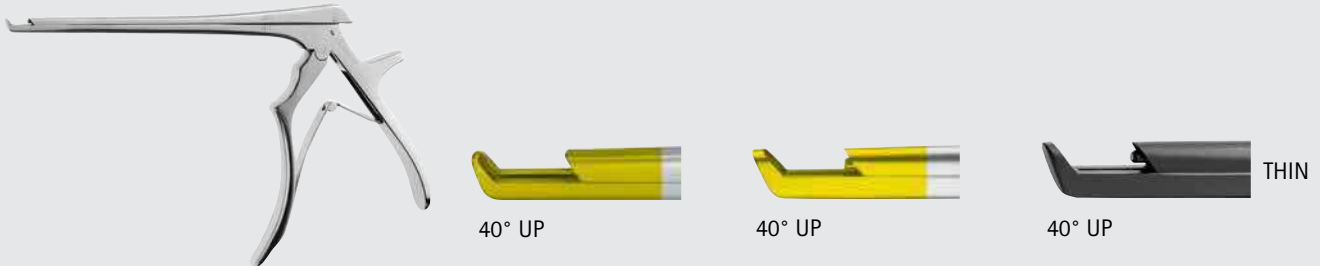

Working Length (in.)	Jaw Size (mm)	Footplate	Non Detachable, Silver	Ejector	Detachable, Silver	Ejector	Detachable, NOIR Coating	Ejector
7	1.0	THIN	FF771R	-	FK906R	-	FK906B	-
7	1.5	THIN	FF645R	-	FK923R	-	FK923B	-
7	2.0	THIN	FF772R	-	FK907R	✓	FK907B	✓
7	2.5	THIN	FF646R	-	FK924R	✓	FK924B	✓
7	3.0	THIN	FF773R	-	FK908R	✓	FK908B	✓
7	4.0	THIN	FF769R	-	FK909R	✓	FK909B	✓
7	5.0	THIN	FF770R	-	FK910R	✓	FK910B	✓
7 7/8	1.0	THIN	FF661R	-	FK961R	-	FK961B	-
7 7/8	1.5	THIN	FF658R	-	FK968R	-	FK968B	-
7 7/8	2.0	THIN	FF662R	-	FK962R	✓	FK962B	✓
7 7/8	2.5	THIN	FF659R	-	FK969R	✓	FK969B	✓
7 7/8	3.0	THIN	FF663R	-	FK963R	✓	FK963B	✓
7 7/8	4.0	THIN	FF664R	-	FK964R	✓	FK964B	✓
7 7/8	5.0	THIN	FF665R	-	FK965R	✓	FK965B	✓
9	1.0	THIN	FF734R	-	FK929R	-	FK929B	-
9	2.0	THIN	FF746R	-	FK925R	✓	FK925B	✓
9	3.0	THIN	FF747R	-	FK926R	✓	FK926B	✓
9	4.0	THIN	FF748R	-	FK927R	✓	FK927B	✓
9	5.0	THIN	FF749R	-	FK928R	✓	FK928B	✓
11	1.0	THIN	FF673R	-	FK980R	-	FK980B	-
11	2.0	THIN	FF666R	-	FK976R	✓	FK976B	✓
11	3.0	THIN	FF667R	-	FK977R	✓	FK977B	✓
11	4.0	THIN	FF668R	-	FK978R	✓	FK978B	✓
11	5.0	THIN	FF669R	-	FK979R	✓	FK979B	✓





40° UP



40° UP



40° UP

STANDARD

Working Length (in.)	Jaw Size (mm)	Jaw Opening (mm)	Footplate	Non Detachable, Silver	Ejector	Detachable, Silver	Ejector	Detachable, NOIR Coating	Ejector
7	2.0	15	STANDARD	FF677R	-	FK971R	✓	FK971B	✓
7	3.0	15	STANDARD	FF678R	-	FK972R	✓	FK972B	✓
7	4.0	15	STANDARD	FF679R	-	FK973R	✓	FK973B	✓
7	5.0	15	STANDARD	FF680R	-	FK974R	✓	FK974B	✓
7	6.0	15	STANDARD	-	-	FK975R	✓	FK975B	✓

7 7/8	2.0	15	STANDARD	FF660R	-	FK970R	✓	FK970B	✓
7 7/8	3.0	15	STANDARD	FF739R	-	FK982R	✓	FK982B	✓
7 7/8	4.0	15	STANDARD	FF745R	-	FK983R	✓	FK983B	✓
7 7/8	5.0	15	STANDARD	FF751R	-	FK984R	✓	FK984B	✓
7 7/8	6.0	15	STANDARD	FF753R	-	FK985R	✓	FK985B	✓



STANDARD

90° UP

Working Length (in.)	Jaw Size (mm)	Jaw Opening (mm)	Non Detachable, Silver	Ejector
7	3	15	FF136R	-
7	4	15	FF137R	-
7	5	15	FF138R	-

8	3	15	FF086R	-
8	4	15	FF087R	-
8	5	15	FF088R	-



Orthopedics/Spine

Kerrison Bone Punches

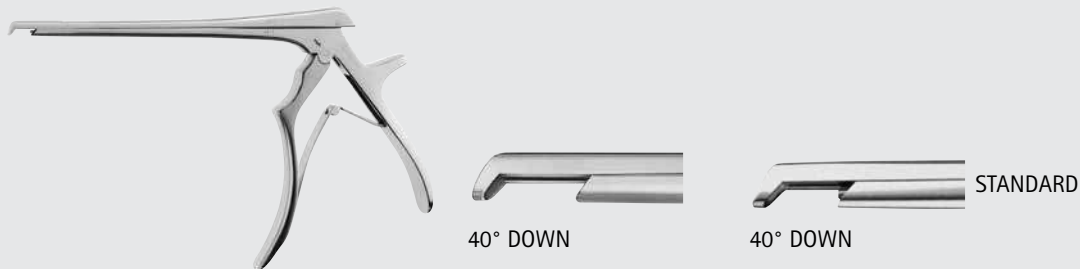

Working Length (in.)	Jaw Size (mm)	Footplate	Non Detachable, Silver	Ejector	Detachable, Silver	Ejector
7	1.0	STANDARD	FF711R	-	FK930R	-
7	2.0	STANDARD	FF712R	-	FK931R	✓
7	3.0	STANDARD	FF713R	-	FK932R	✓
7	4.0	STANDARD	FF714R	-	FK933R	✓
7	5.0	STANDARD	FF725R	-	FK934R	✓

9	2.0	STANDARD	FF692R	-	FK943R	✓
9	3.0	STANDARD	FF693R	-	FK944R	✓
9	4.0	STANDARD	FF694R	-	FK945R	✓
9	5.0	STANDARD	FF695R	-	FK946R	✓



Working Length (in.)	jaw Size (mm)	Footplate	Non Detachable, Silver	Ejector	Detachable, Silver	Ejector
7	1.0	THIN	FF781R	-	FK936R	-
7	2.0	THIN	FF782R	-	FK937R	✓
7	3.0	THIN	FF783R	-	FK938R	✓
7	4.0	THIN	FF784R	-	FK939R	✓
7	5.0	THIN	FF785R	-	FK940R	✓





Working Length (in.)	Jaw Size (mm)	Footplate	Non Detachable, Silver	Ejector	Detachable, Silver	Ejector	Detachable NOIR Coating	Ejector
7	1.0	STANDARD	FF716R	-	FK948R	-	FK948B	-
7	2.0	STANDARD	FF718R	-	FK949R	-	FK949B	✓
7	3.0	STANDARD	FF750R	-	FK950R	✓	FK950B	✓
7	4.0	STANDARD	FF752R	-	FK951R	✓	FK951B	✓
7	5.0	STANDARD	FF754R	-	FK952R	✓	FK952B	✓
7	6.0	STANDARD	FF755R	-	FK953R	✓	FK953B	✓

8	1.0	STANDARD	FF025R	-
8	2.0	STANDARD	FF026R	-
8	3.0	STANDARD	FF027R	-
8	4.0	STANDARD	FF028R	-
8	5.0	STANDARD	FF029R	-



Working Length (in.)	Jaw Size (mm)	Footplate	Non Detachable, Silver	Ejector
7	1	THIN	FF115R	-
7	2	THIN	FF116R	-
7	3	THIN	FF117R	-
7	4	THIN	FF118R	-
7	5	THIN	FF119R	-

8	2	THIN	FF077R	-
8	3	THIN	FF078R	-
8	4	THIN	FF079R	-
8	5	THIN	FF080R	-



ORTHO
SPINE

INCHES

Orthopedics/Spine

Kerrison Bone Punches

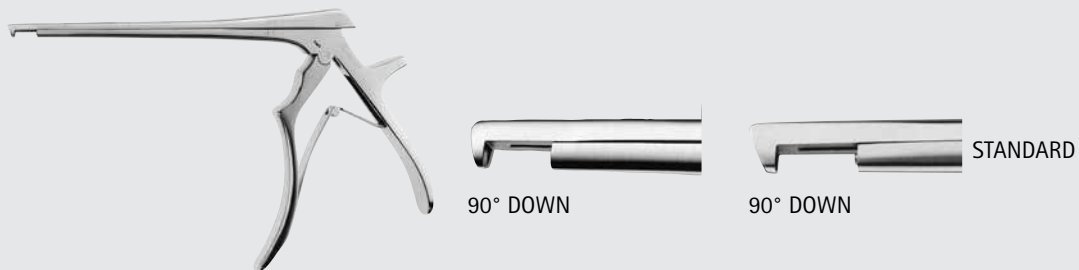

Working Length (in.)	Jaw Size (mm)	Footplate	Non Detachable, Silver	Ejector	Detachable, Silver	Ejector
7	1.0	STANDARD	FF741R	-	FK954R	-
7	2.0	STANDARD	FF719R	-	FK955R	-
7	3.0	STANDARD	FF721R	-	FK956R	✓
7	4.0	STANDARD	FF742R	-	FK957R	✓
7	5.0	STANDARD	FF723R	-	FK958R	✓
7	6.0	STANDARD	FF743R	-		

8	2	STANDARD	FF828R	-
8	3	STANDARD	FF829R	-
8	4	STANDARD	FF830R	-
8	5	STANDARD	FF831R	-
8	6	STANDARD	FF841R	-



Working Length (in.)	Jaw Size (mm)	Footplate	Non Detachable, Silver	Ejector
7	1.0	THIN	MF136R	-
7	2.0	THIN	FF816R	-
7	3.0	THIN	FF817R	-
7	4.0	THIN	FF819R	-
7	5.0	THIN	FF821R	-

8	1.0	THIN	FF809R	-
8	2.0	THIN	FF812R	-
8	3.0	THIN	FF813R	-
8	5.0	THIN	FF815R	-



Foraminotomy Kerrison

- Non Detachable design
- Upward curve allows for easier bone removal, providing improved access to the underside of the foramen

KERRISON Foraminotomy Bone Punch

Catalog Number	Jaw Size (mm)	Jaw Opening (mm)	Working Length (in.)
FF466R	2.0	10	7 7/8
FF467R	3.0	10	7 7/8
FF468R	4.0	10	7 7/8
FF469R	5.0	10	7 7/8

FF466R-FF469R

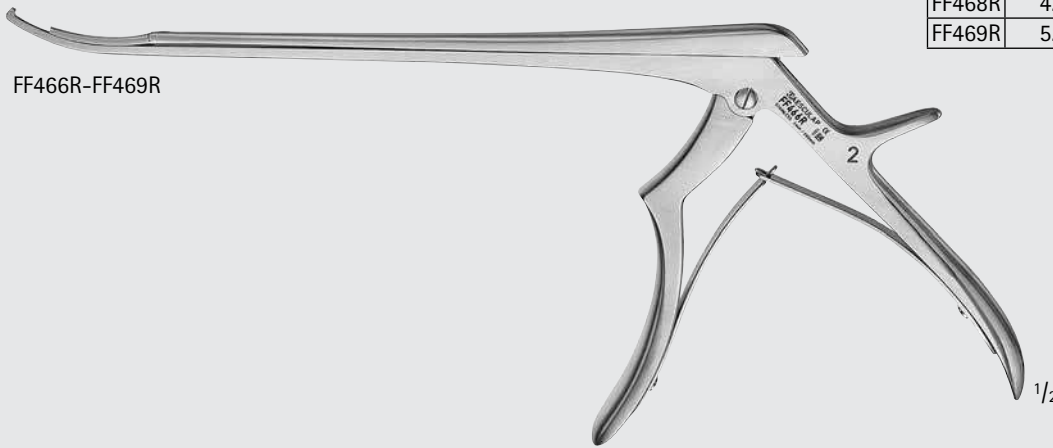

Bayonet-Shaped Kerrison bone punch

- Non Detachable design
- Bayonet shape allows better view over the KERRISON and increased visibility of surgical site
- Easily used through a retractor tube for MIS procedures

KERRISON Bayonet-Shaped Bone Punch, 40° upbiting

Catalog Number	Jaw Size (mm)	Jaw Opening (mm)	Working Length (in.)
FF496R	2.0	10	9 1/2
FF497R	3.0	10	9 1/2
FF498R	4.0	10	9 1/2
FF499R	5.0	10	9 1/2

FF496R-FF499R



Orthopedics/Spine

KAIRison® Pneumatic Bone Punch

KAIRison Pneumatic Bone Punch

- Easy handling
- Reduces physical effort required
- Relieves strain on hands and joints
- Less risk of reduced motor skills through fatigue
- Innovative safety mechanism
- Short learning curve
- Excellent balance
- Suitable for right- or left-handed use
- Reliable; does not jam
- Ergonomic design

For more information see our brochure DOC763.

KAIRison Pneumatic Bone Punch

Catalog Number	Jaw Size (mm)	Jaw Opening (mm)	Footplate	Ejector	Total Length (in.)
FK882R	2.0	12	STANDARD	✓	9 1/4
FK883R	3.0	12	STANDARD	✓	9 1/4
FK884R	4.0	12	STANDARD	✓	9 1/4
FK885R	5.0	12	STANDARD	✓	9 1/4
FK886R	6.0	12	STANDARD	✓	9 1/4
FK892R	2.0	12	STANDARD	✓	11 1/4
FK893R	3.0	12	STANDARD	✓	11 1/4
FK894R	4.0	12	STANDARD	✓	11 1/4
FK895R	5.0	12	STANDARD	✓	11 1/4
FK896R	6.0	12	STANDARD	✓	11 1/4

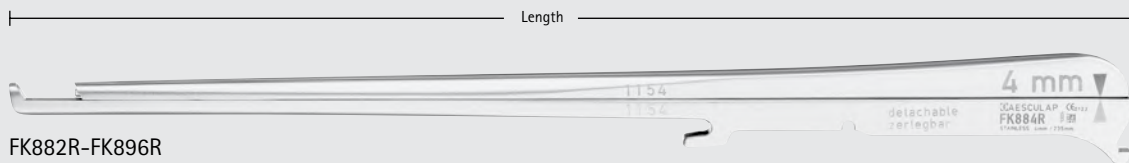

FK882R-FK896R

Width (mm) 2.0 3.0 4.0 5.0 6.0



FK899R

KAIRison Pneumatic Punch Handle

Catalog Number
FK899R

Punch Bracket For Pressure Reducer



FK898R-FK898214

KAIRison Pressure Reducer

Catalog Number	Description
FK898R	PRESSURE REDUCER
FK887R	BRACKET FOR PRESSURE REDUCER
FK898215	RUBBER CAP, SMALL
FK898214	RUBBER CAP, LARGE

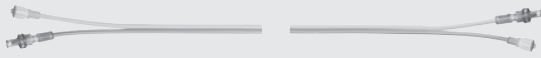

FK888SU

Disposable Tubes for KAIRison
Pneumatic Punch

Catalog Number	Packaging
FK888SU	PAK = Package of 10

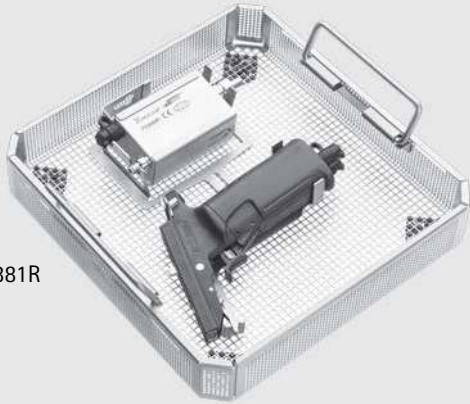

FK881R

Storage Rack for KAIRison Handle and
Pressure Reducer

Catalog Number
FK881R

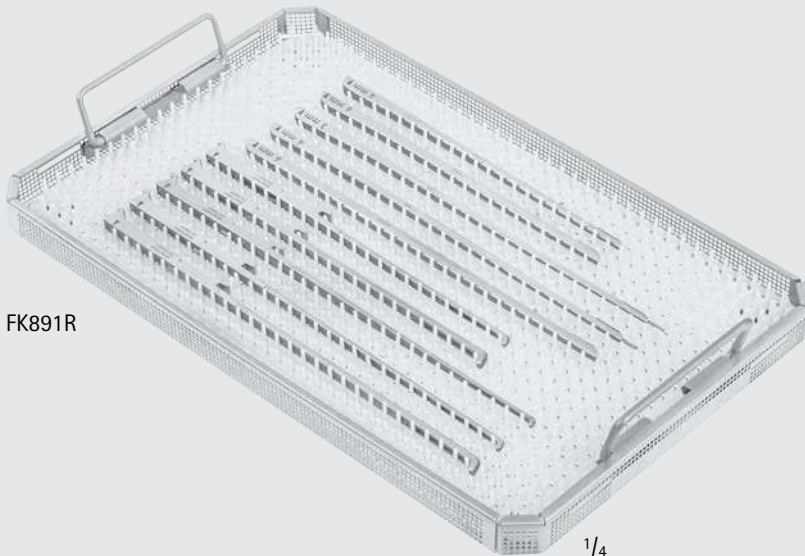

FK891R

Storage Rack for KAIRison Shafts

Catalog Number
FK891R



GA468R

Pneumatic Hose with Aesculap-
Schrader Connection

Catalog Number	Length (m)
GA468R	5



Orthopedics/Spine

Bone Cutters



FO601R-FO602R

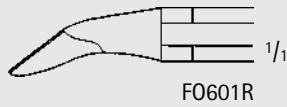

FO601R



FO602R

Bone Cutting Forceps

Catalog Number	Jaw	Length (in.)
FO601R	UP	5 1/8
FO602R	UP	6 3/4



FO604R

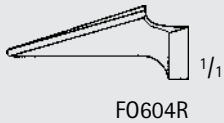

FO604R

STAMM Bone Cutting Forceps

Catalog Number	Length (in.)
FO604R	6



FO612R

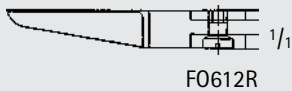

FO612R

Bone Cutting Forceps, Double Action

Catalog Number	Jaw	Length (in.)
FO612R	STR	6 3/4

LISTON Bone Cutting Forceps

Catalog Number	Jaw	Length (in.)
F0620R	STR, Single Action	5 1/2
F0622R	STR, Single Action	6 3/4
F0624R	STR, Single Action	7 7/8
F0626R	STR, Single Action	8 3/4
F0632R	ANG, Single Action	6 3/4
F0634R	ANG, Single Action	7 7/8
F0636R	ANG, Single Action	8 3/4
F0645R	CVD, Double Action	9 1/2
F0646R	STR, Double Action	11
F0647R	CVD, Double Action	11

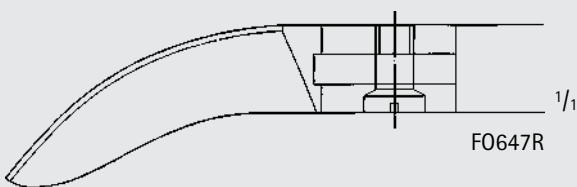
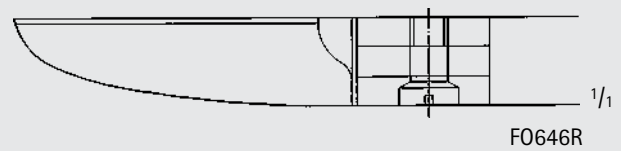
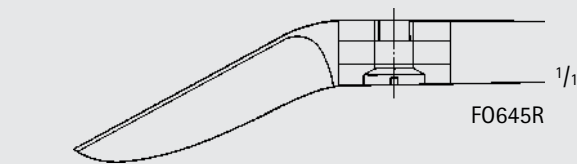
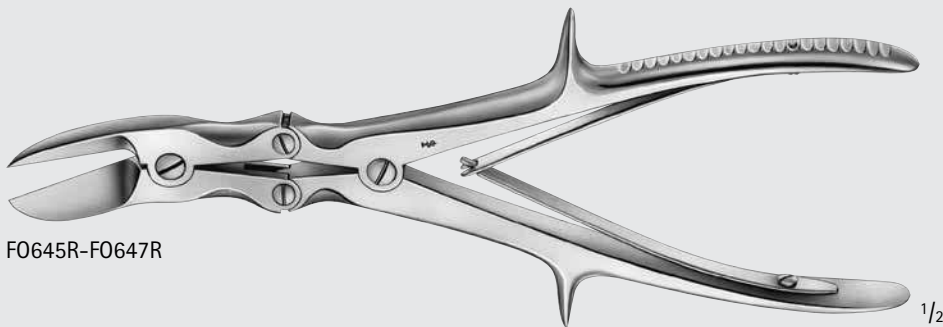
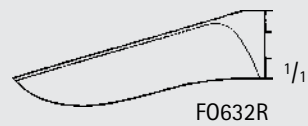
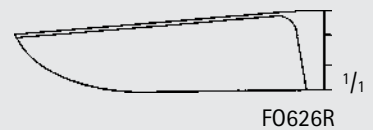
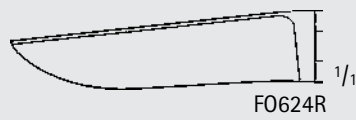
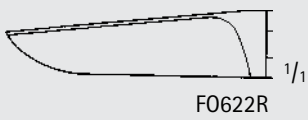
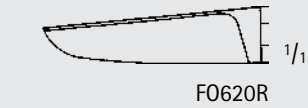

Orthopedics/Spine

Bone Cutters



FO610R-FO611R

1/2

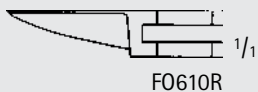

FO610R

1/1

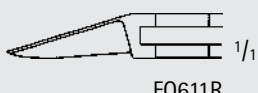

FO611R

1/1

BOEHLER Bone Cutting Forceps, Double Action

Catalog Number	Jaw	Length (in.)
FO610R	STR	5 3/4
FO611R	ANG	5 3/4



FO614R

1/2

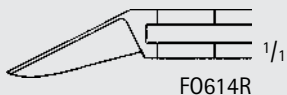

FO614R

1/1

MCINDOE Bone Cutting Forceps, Double Action

Catalog Number	Jaw	Length (in.)
FO614R	ANG	6 7/8



FO640R-FO641R

1/2

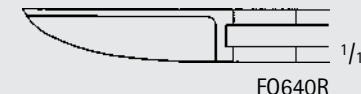

FO640R

1/1

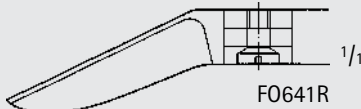

FO641R

1/1

RUSKIN-LISTON Bone Cutting Forceps, Double Action

Catalog Number	Jaw	Length (in.)
FO640R	STR	7 1/2
FO641R	ANG	7 1/2



ORTHO
SPINE

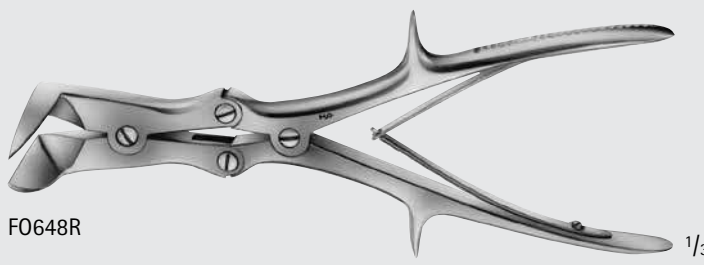

F0648R 1/3

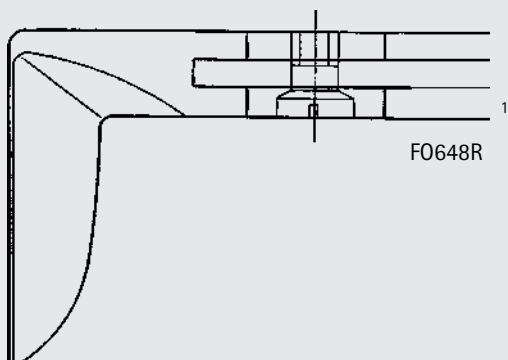

F0648R 1/1

LISTON-STILLE Bone Cutting Forceps, 90° Angle

Catalog Number	Length (in.)
F0648R	10 1/2

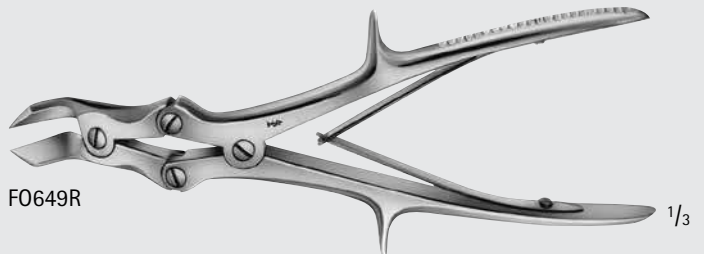

F0649R 1/3

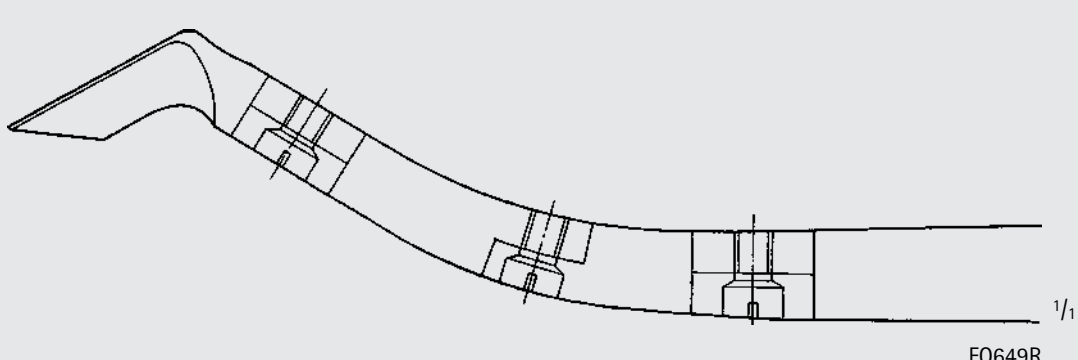

F0649R 1/1

LISTON-KEY-HORSLEY Bone Cutting Forceps, Angled

Catalog Number	Length (in.)
F0649R	10

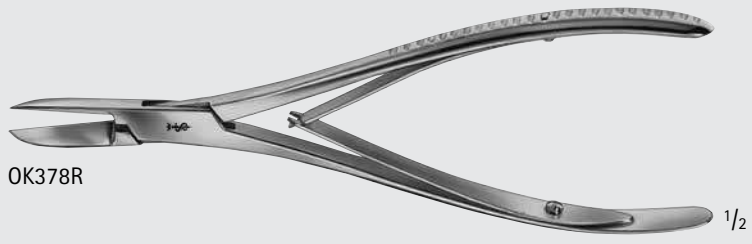

OK378R 1/2

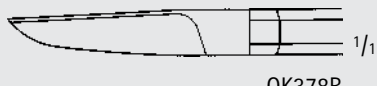

OK378R 1/1

KAZANJIAN Bone Cutting Forceps, Straight

Catalog Number	Length (in.)
OK378R	7 1/4



Orthopedics/Spine

Rulers, Calipers and Gauges



AA847R

Caliper for Inner Diameter and Outer Diameter

Catalog Number	Measuring Range	Length (in.)
AA847R	UP TO 100MM	5 1/8
AA846R	UP TO 150MM	9



AA846R

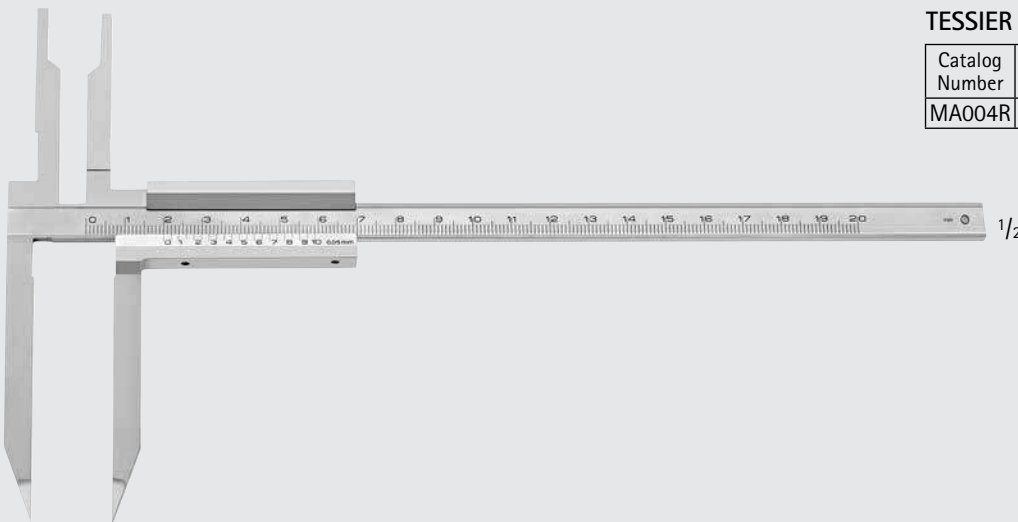

MA004R

TESSIER Type Caliper

Catalog Number	Length (in.)
MA004R	10 1/4

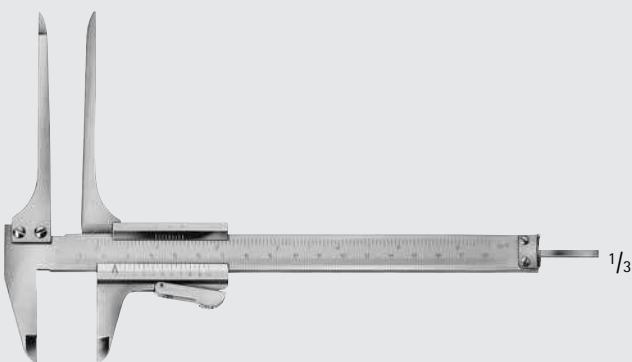

AA845R

CASPAR Neuro Caliper F/ Bone Graft

Catalog Number	Length (in.)
AA845R	8 7/8





MB983R

TOWNLEY Femur Caliper

Catalog Number	Length (in.)
MB983R	4



AA804R-AA806R

Steel Ruler, Graduated In Millimeters and Inches

Catalog Number	Length (in.)
AA804R	6
AA805R	11 3/4
AA806R	19 3/4

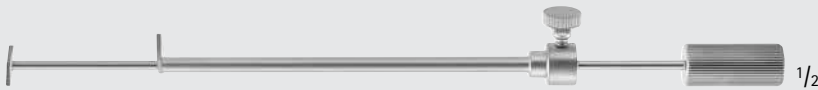

MD531R

CLOWARD Style Depth Gauges

Catalog Number	Size	Length (in.)
MD531R	LARGE	8

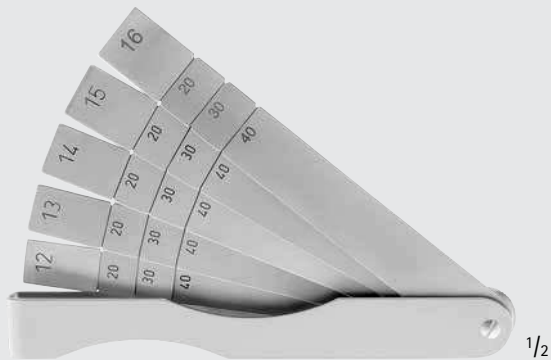

MD534R

CLOWARD Spanner Gauges

Catalog Number	Length (in.)
MD534R	5





Manufacturing Unit -

***115-A Waryana Industrial Complex, Leather Complex Road,
Jalandhar Punjab, 144021***



Sales Office -

***Plot No. 581- Kakrola Housing Complex, Near Metro Pillar 802,
Dwarka Mor, Delhi, 110078***



Our Certifications -

***UDYAM , ISO 13485, WHO-GMP, ISO 9001:2015, CE , ROHS,
FDA , MD-42, MD-5***

CONTACT US:



+91- 98141-81255, +91- 98142-62255



www.alisprofessional.com



info@royalinternational.org