



## Obstetrics/Gynecology

Scissors .....	1202 - 1211
Needle Holders .....	1212
Forceps .....	1213 - 1250
Clamps .....	1251 - 1260
Retractors .....	1261 - 1262
Vaginal Retractors and Specula .....	1263 - 1281
Endospecula .....	1282
Dilators and Probes .....	1283 - 1287
Curettes .....	1288 - 1294
Accessories .....	1295

# Obstetrics/Gynecology

## Scissors

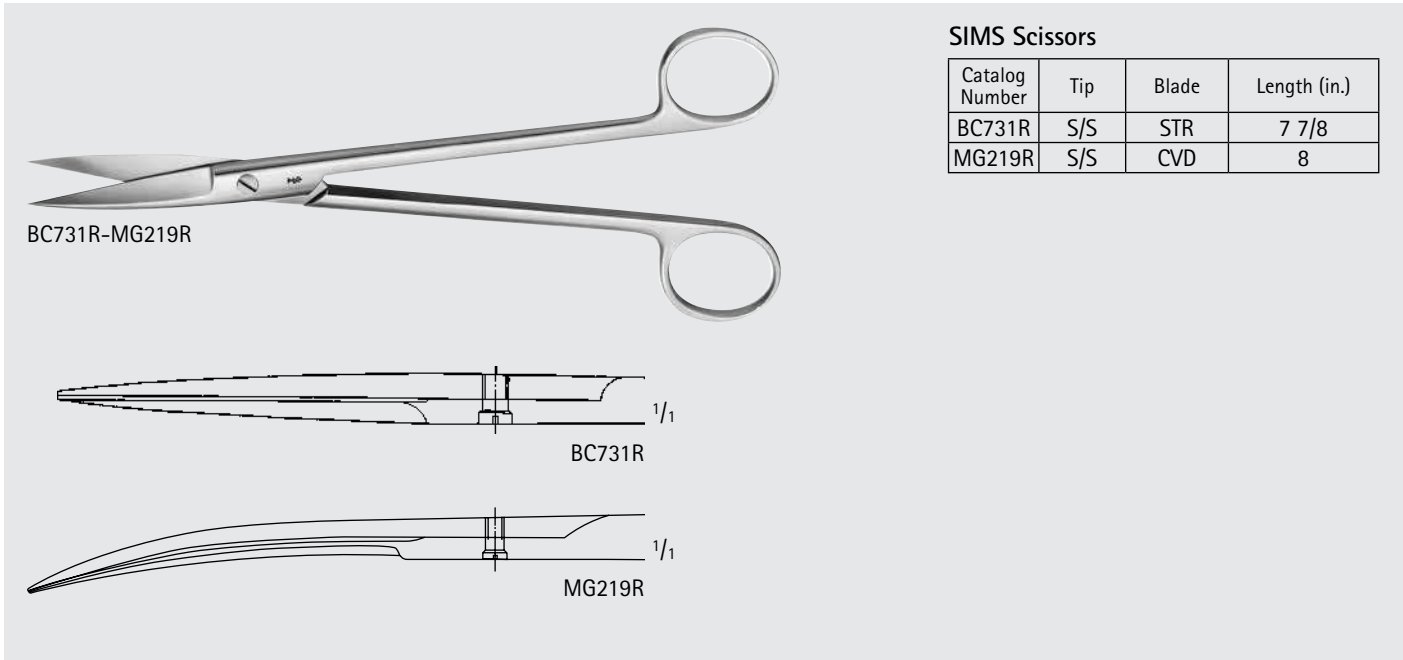
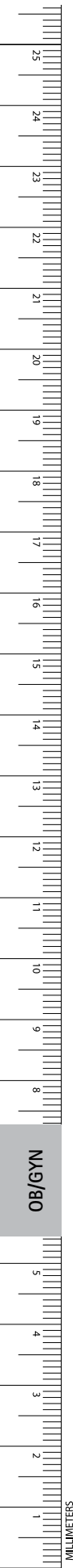

### SIMS Scissors

Catalog Number	Tip	Blade	Length (in.)
BC731R	S/S	STR	7 7/8
MG219R	S/S	CVD	8

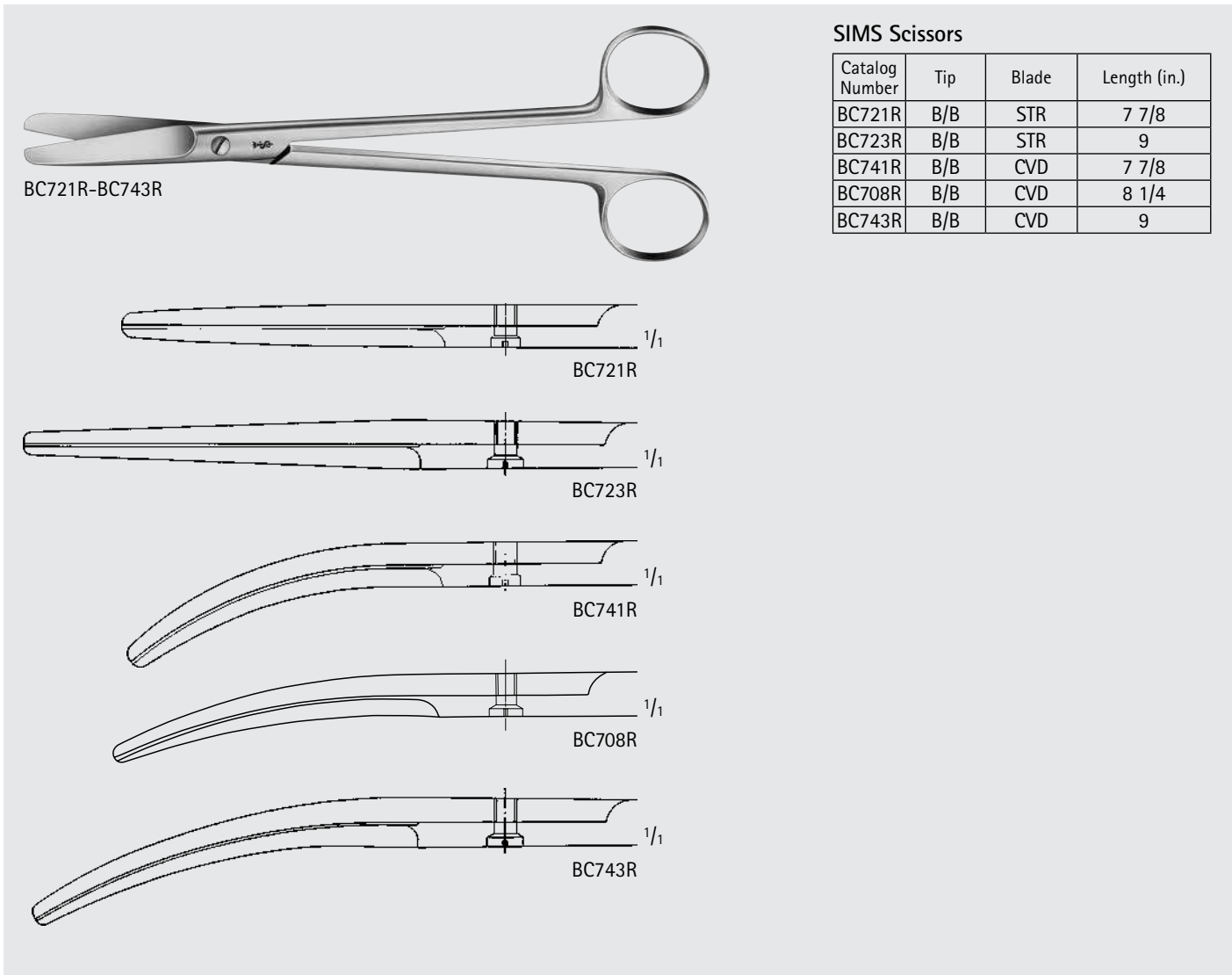

### SIMS Scissors

Catalog Number	Tip	Blade	Length (in.)
BC721R	B/B	STR	7 7/8
BC723R	B/B	STR	9
BC741R	B/B	CVD	7 7/8
BC708R	B/B	CVD	8 1/4
BC743R	B/B	CVD	9

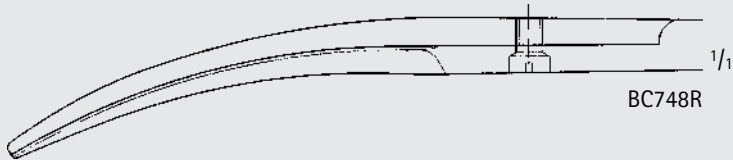
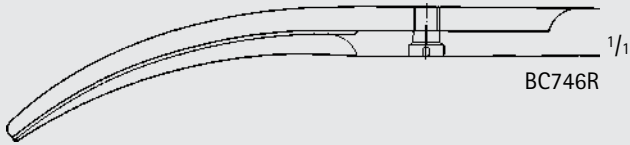
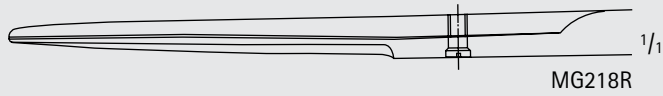
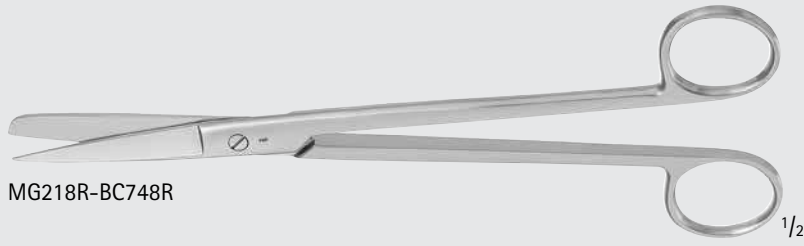

SIMS Scissors (continued)

Catalog Number	Tip	Blade	Length (in.)
MG218R	S/B	STR	8
BC746R	S/B	CVD	7 7/8
BC748R	S/B	CVD	9

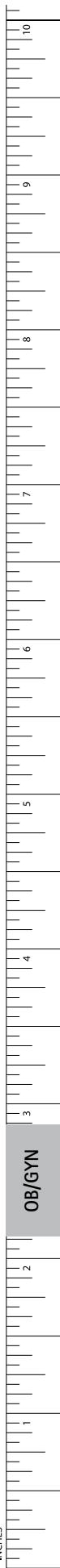

# Obstetrics/Gynecology

## Scissors

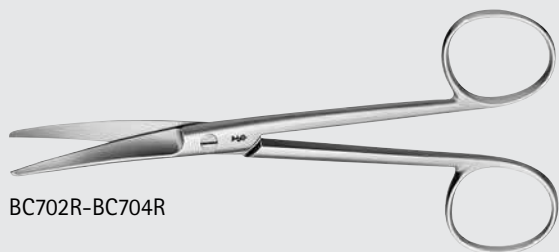

BC702R-BC704R

### WERTHEIM Scissors

Catalog Number	Tip	Blade	Length (in.)
BC702R	B/B	CVD	5 3/4
BC703R	B/B	CVD	7 7/8
BC704R	B/B	CVD	9

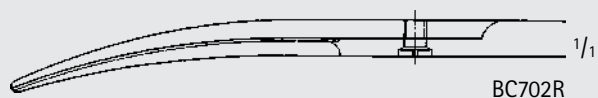

BC702R

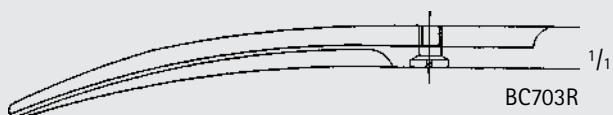

BC703R

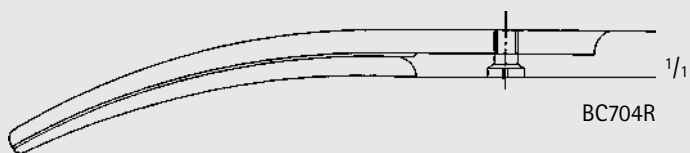

BC704R



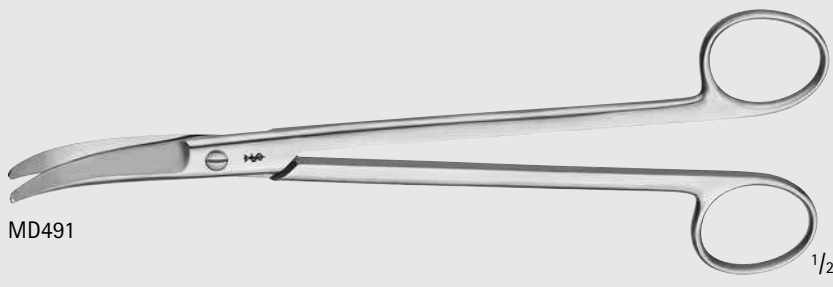

MD491 1/2



MD491 1/1

**JORGENSEN Scissors**

Catalog Number	Tip	Blade	Length (in.)
MD491	B/B	CVD	8 3/4

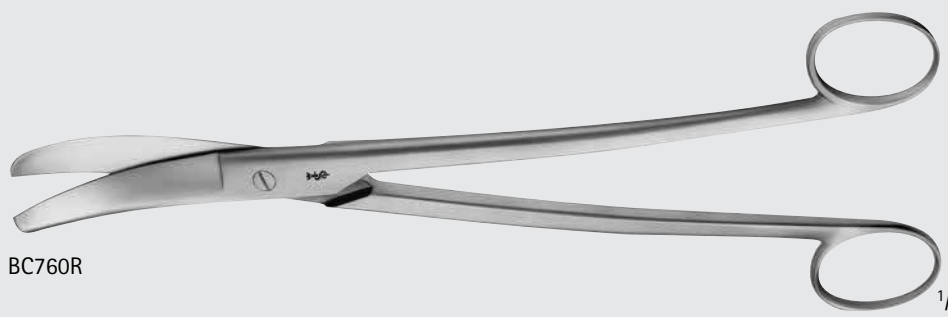

BC760R 1/2

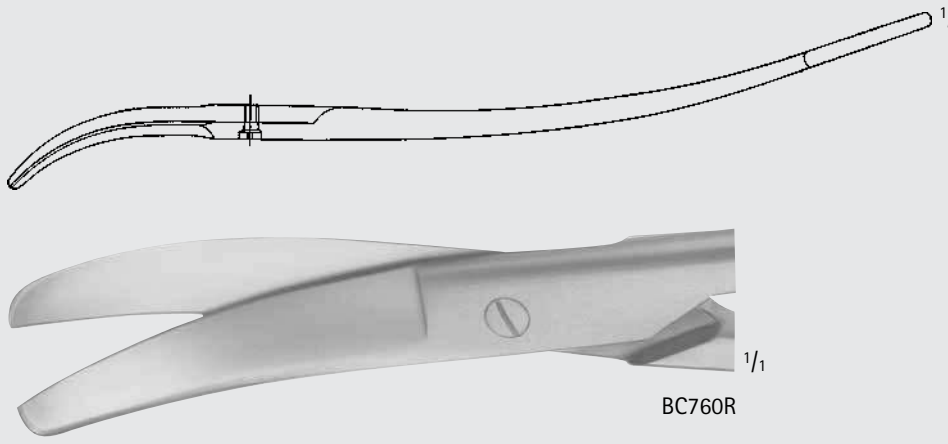

BC760R 1/1

**SIEBOLD Uterine Scissors**

Catalog Number	Tip	Blade	Length (in.)
BC760R	B/B	CVD	9 5/8



# Obstetrics/Gynecology

## Scissors

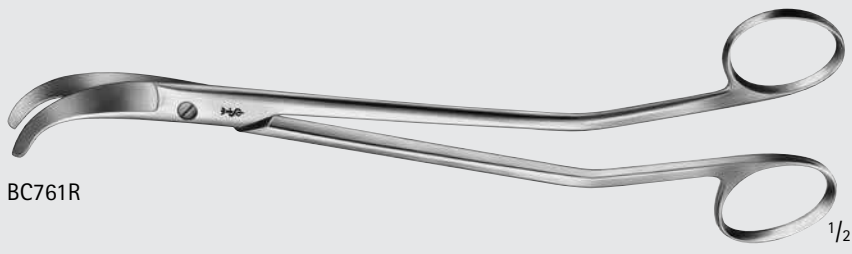
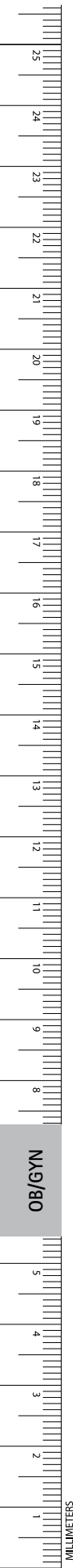

BC761R

1/2



BC761R

1/2

### BOZEMANN Uterine Scissors

Catalog Number	Tip	Blade	Length (in.)
BC761R	B/B	CVD	8 3/4

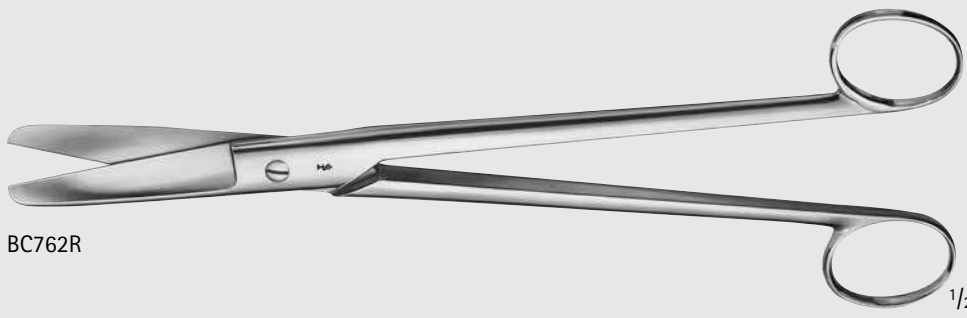

BC762R

1/2



BC762R

1/1

### SIMS-SIEBOLD Uterine Scissors

Catalog Number	Tip	Blade	Length (in.)
BC762R	B/B	STR	9 3/4

OB/GYN

**DUROTIP TC MAYO Dissecting Scissors**

Catalog Number	Tip	Blade	Length (in.)
BC558R	B/B	STR	9
MG215R	B/B	STR	14
BC559R	B/B	CVD	9
MB726R	B/B	CVD	14

BC558R-BC559R, MB726R, MG215R

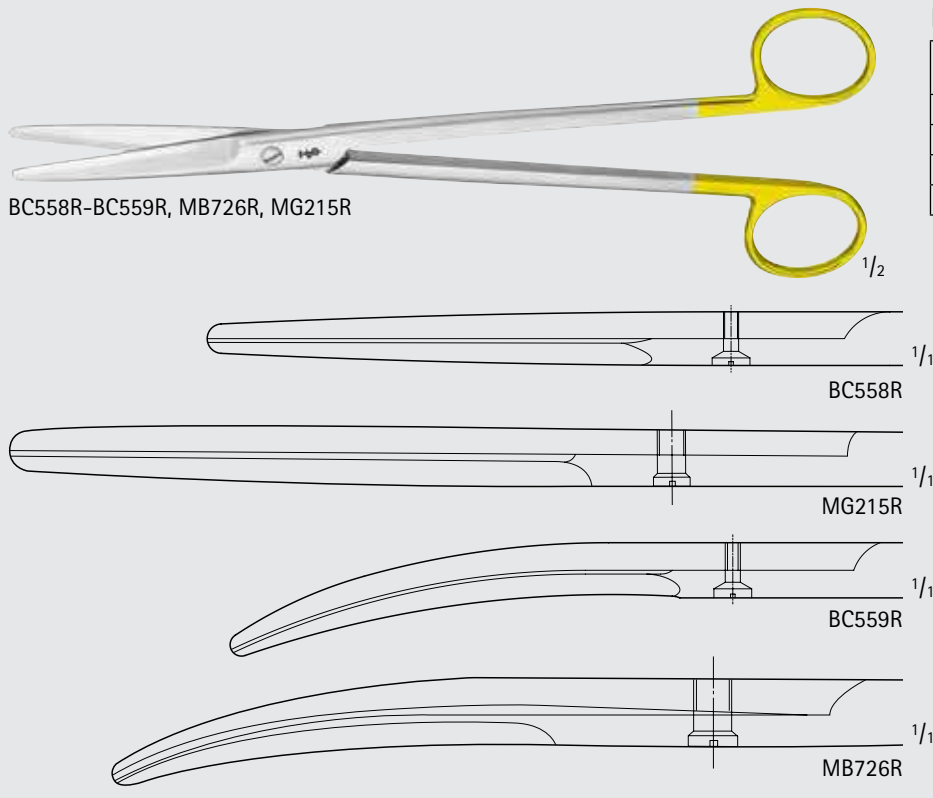

**DUROTIP TC SIMS Uterine Scissors**

Catalog Number	Tip	Blade	Length (in.)
BC290R	B/B	CVD	7 7/8
BC291R	B/B	CVD	9

BC290R-BC291R

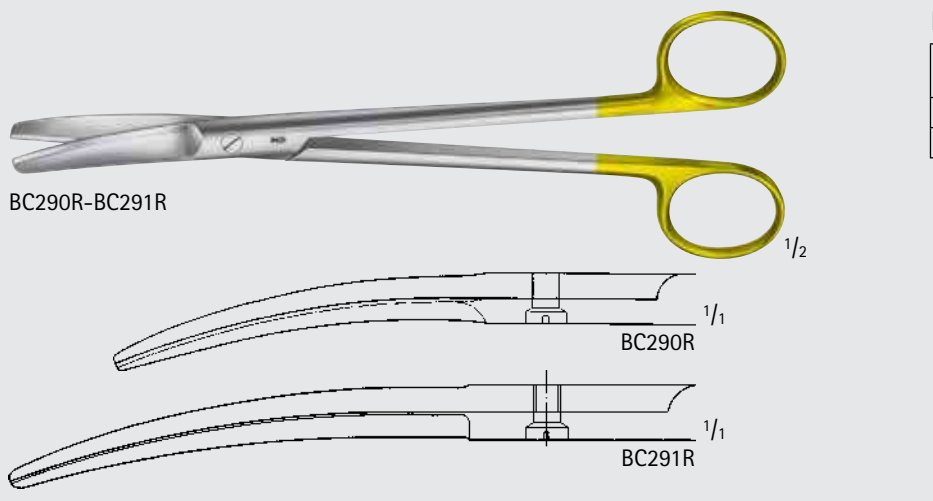

**DUROTIP TC WERTHEIM Scissors**

Catalog Number	Length (in.)
BC293R	9

BC293R

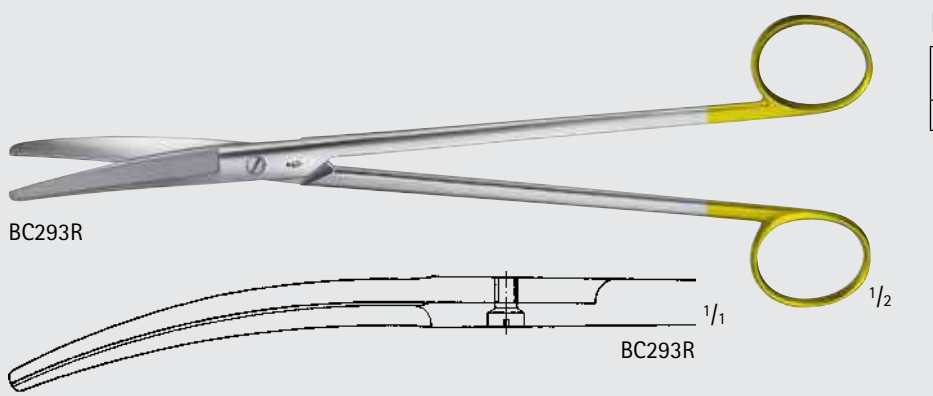

OB/GYN

INCHES

# Obstetrics/Gynecology

## DUROTIP™ TC Scissors

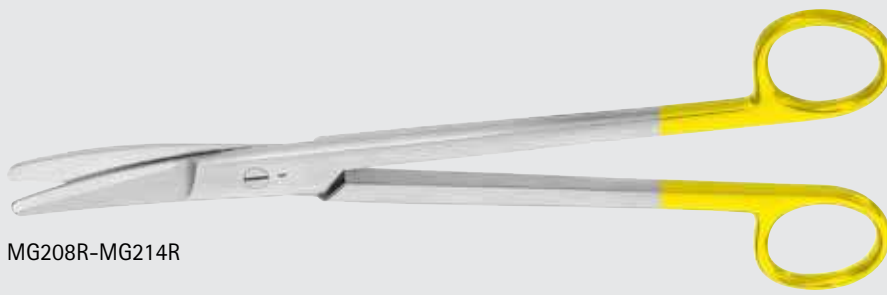

MG208R-MG214R

### DUROTIP TC Uterine Scissors

Catalog Number	Tip	Length (in.)
MG208R	SLIGHT CVD	9
MG209R	STRONG CVD	9
MG210R	ANG	9
MG211R	ANG	10 1/2
MG212R	SLIGHT CVD	11 3/4
MG213R	STRONG CVD	11 3/4
MG214R	ANG	11 3/4

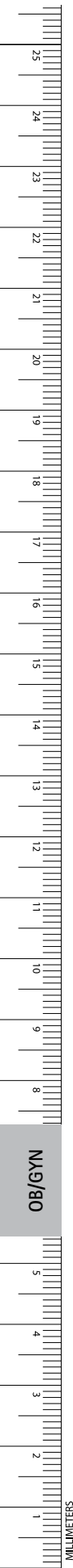
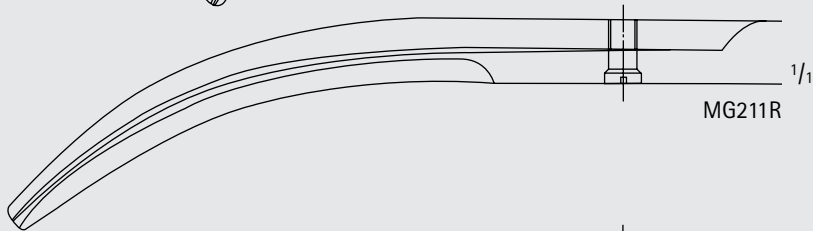
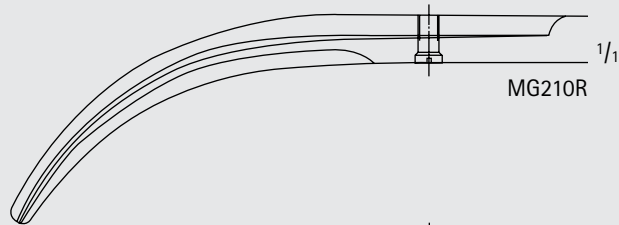
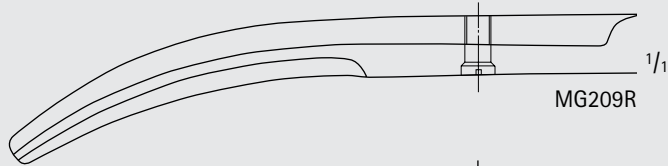
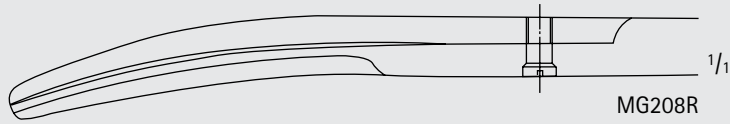

OB/GYN





**Wavecut**

Wavecut scissors have one serrated cutting edge to help prevent tissue from slipping. The W after the item number indicates the scissors are the wavecut style, e.g. BC211W.



BC290W-BC291W

**DUROTIP TC SIMS Uterine Wavecut Scissors**

Catalog Number	Tip	Blade	Length (in.)
BC290W	B/B	CVD	7 7/8
BC291W	B/B	CVD	9

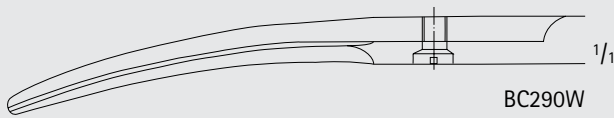

BC290W

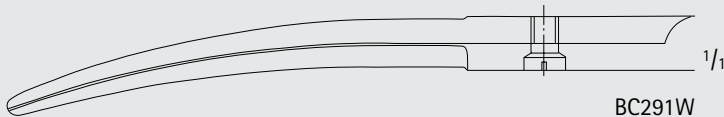

BC291W

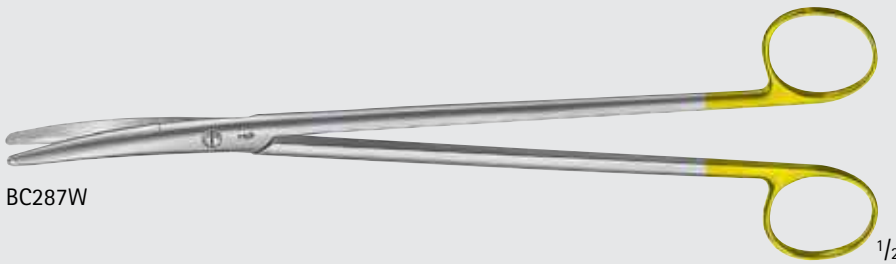

BC287W

**DUROTIP TC METZENBAUM Wavecut Dissecting Scissors, Heavy**

Catalog Number	Tip	Blade	Length (in.)
BC287W	B/B	CVD	9

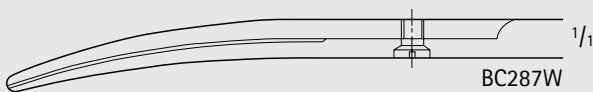

BC287W

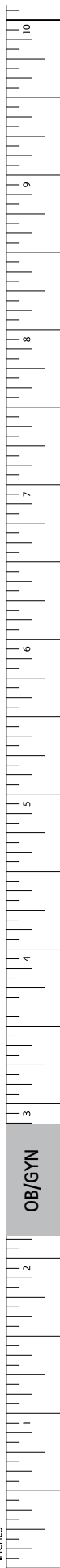

INCHES

OB/GYN

# Obstetrics/Gynecology

## Scissors

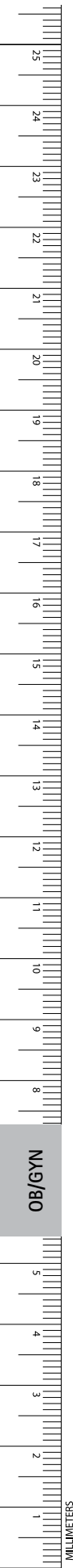

BC796R-BC797R

### Umbilical Cord Scissors

Catalog Number	Tip	Blade	Length (in.)
BC796R	B/B	LAT-CVD	5 1/4
BC797R	B/B	LAT-CVD	6 1/4

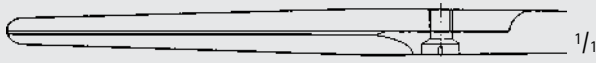
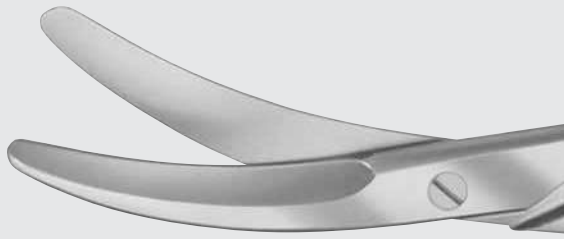

BC796R

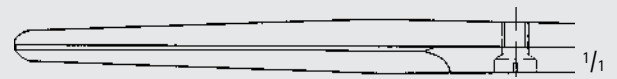

BC797R



ET152R

1/2

### Umbilical Cord Scissors

Catalog Number	Length (in.)
ET152R	4 1/8

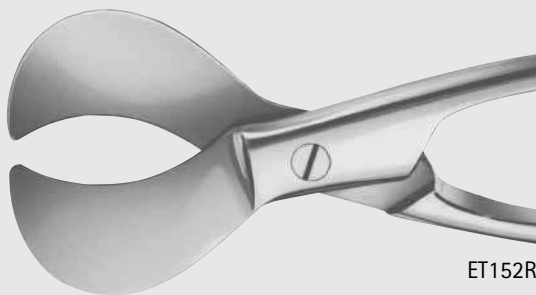

ET152R

1/1

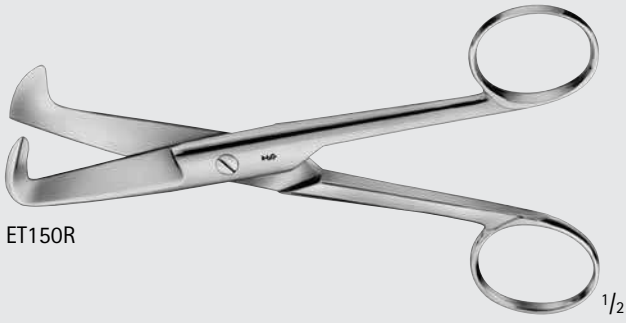

**SCHUHMACHER Umbilical Cord Scissors**

Catalog Number	Length (in.)
ET150R	6 1/8

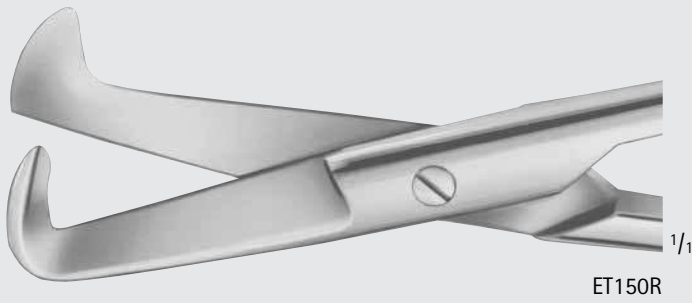

**BRAUN-STADLER Episiotomy Scissors**



Catalog Number	Blade	Length (in.)
ET140R	SERR	5 3/4
ET141R	SERR	7 7/8

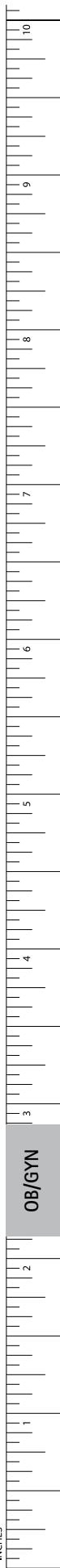
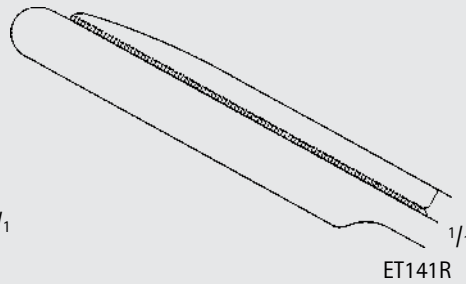
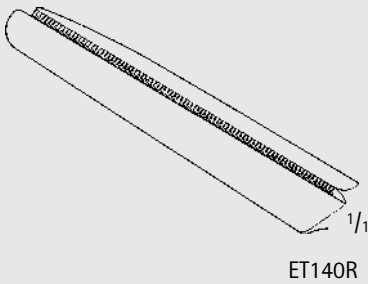

# Obstetrics/Gynecology

## Needle Holders

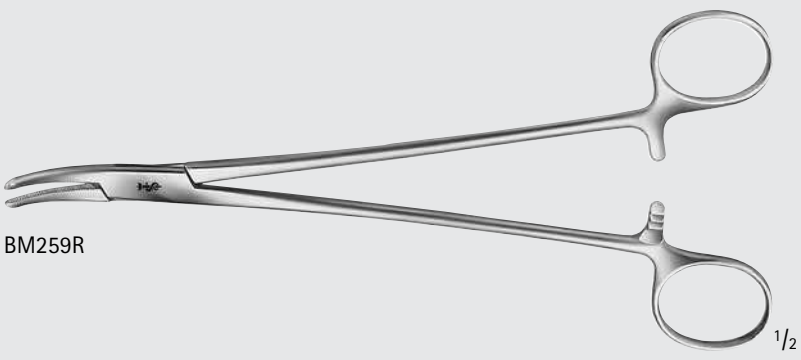
BM259R 1/2

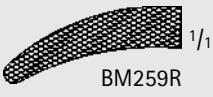

BM259R 1/1

Catalog Number	Tip	Jaw	Length (in.)
BM259R	CVD	SERR	7 7/8

Aesculap features Needle Holders with Tungsten Carbide (TC) inserts. A smooth jaw and three different serration patterns are available, depending on the size of the suture needle.

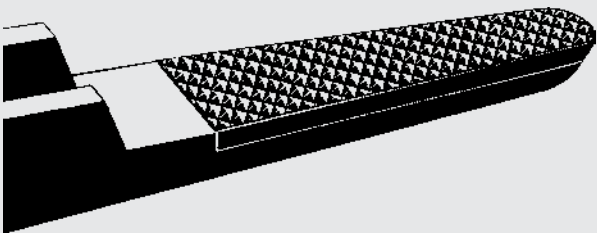





smooth



0.2  
(16,000 teeth/in.<sup>2</sup>)



0.4  
(4,000 teeth/in.<sup>2</sup>)



0.5  
(2,500 teeth/in.<sup>2</sup>)

We recommend carbide inserts as follows:

<u>Jaw Surface</u>	<u>Suture Material</u>
Smooth	9/0 - 11/0
0.2 mm pitch of serration	6/0 - 10/0
0.4 mm pitch of serration	4/0 - 6/0
0.5 mm pitch of serration	up to 3/0

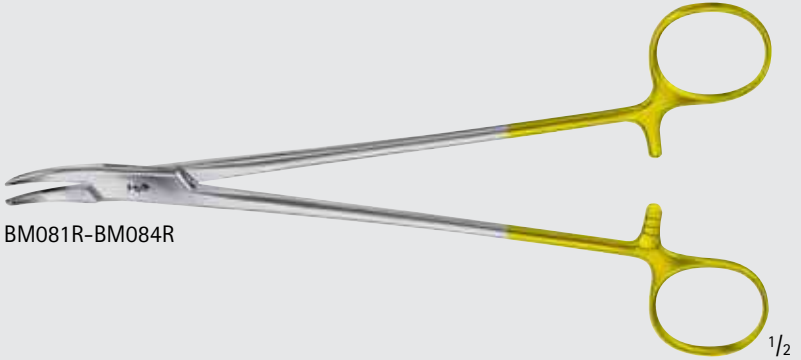

BM081R-BM084R 1/2

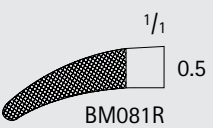

BM081R 1/1

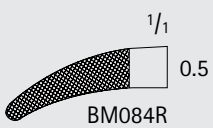

BM084R 1/1

Catalog Number	Tip	Jaw	Length (in.)
BM081R	CVD	SERR	7 7/8
BM084R	CVD	SERR	10 1/4

**MAIER Forceps**

Catalog Number	Jaw	Length (in.)
BF056R	STR	10 1/2
BF057R	CVD	10 1/2

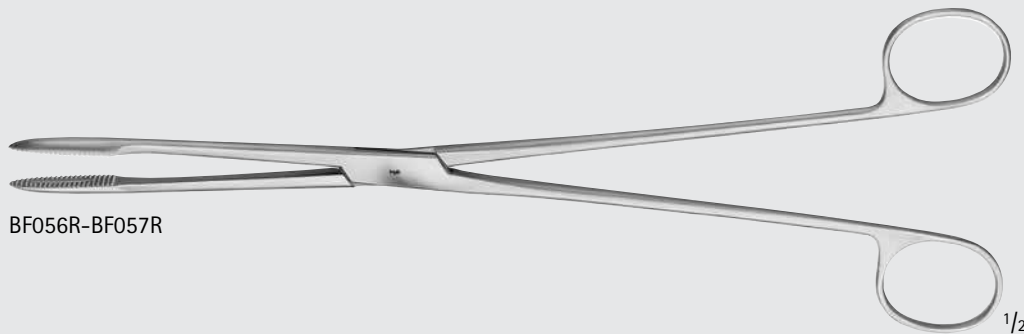

BF056R-BF057R



BF056R

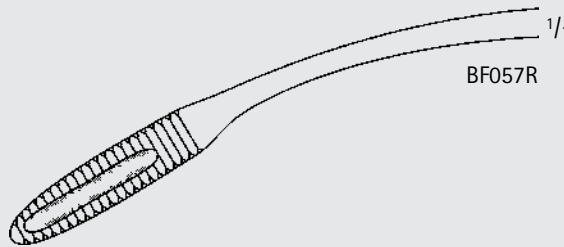

BF057R

**MAIER Forceps, W/ Ratchet**

Catalog Number	Jaw	Length (in.)
BF058R	STR	10 1/4
BF059R	CVD	10 1/4



BF058R-BF059R

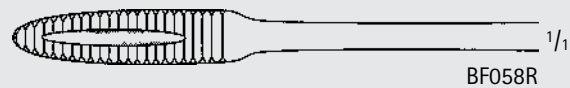

BF058R

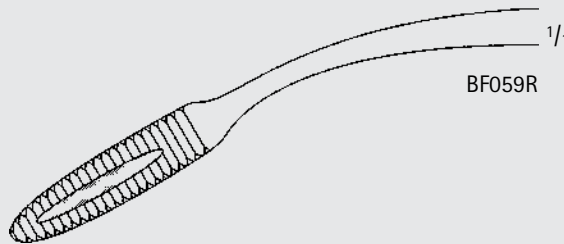

BF059R

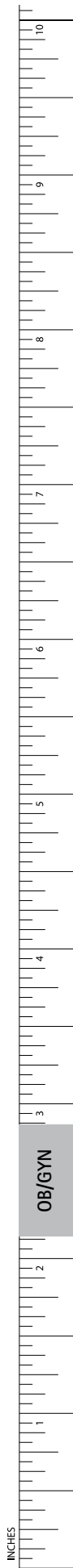

# Obstetrics/Gynecology

## Tenaculum and Sponge Forceps

### SIMS-MAIER Sponge Forceps, W/ Ratchet

Catalog Number	Jaw	Length (in.)
BF076R	STR	11
BF077R	CVD	11

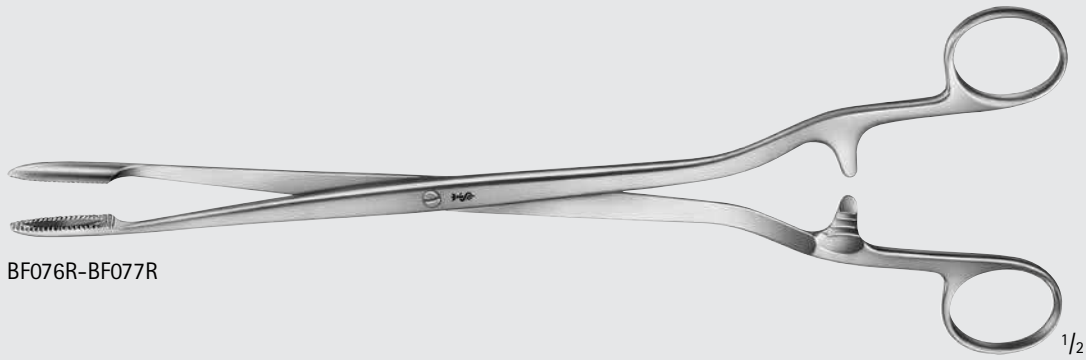

BF076R-BF077R

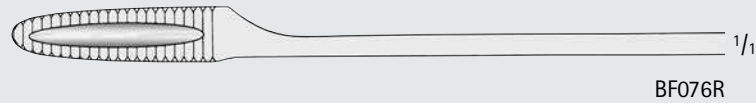

BF076R

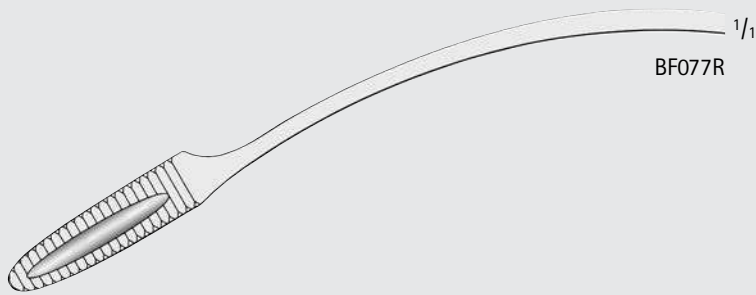

BF077R

### PELKMANN Forceps

Catalog Number	Tip	Jaw	Length (in.)
EO060R	SERR	STR	10 1/4
EO061R	SERR	CVD	10 1/4



EO060R-EO061R

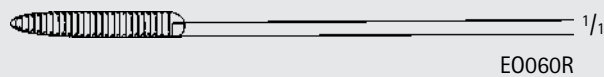

EO060R

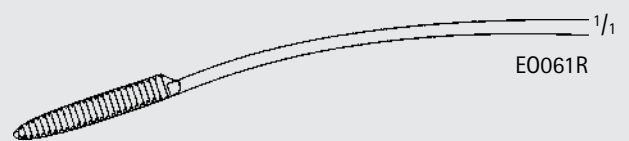

EO061R



OB/GYN

**BOZEMANN Forceps**

Catalog Number	Shaft	Jaw	Length (in.)
E0080R	STR	SERR	10 1/4
E0075R	S-CVD	SMOOTH	9 3/4
E0082R	S-CVD	SERR	9 3/4
E0077R	S-CVD	W/ GROOVE	10



E0080R



E0080R

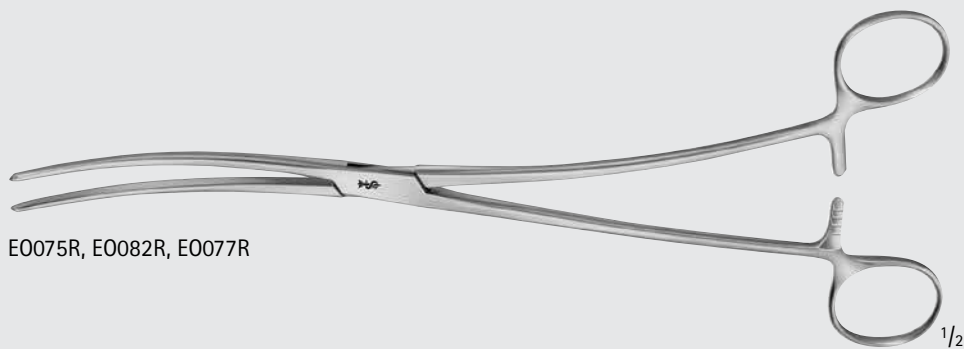

E0075R, E0082R, E0077R



E0075R, E0082R, E0077R

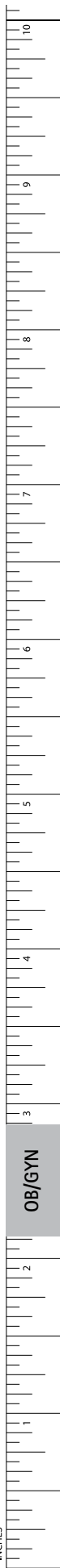

# Obstetrics/Gynecology

## Tenaculum and Sponge Forceps

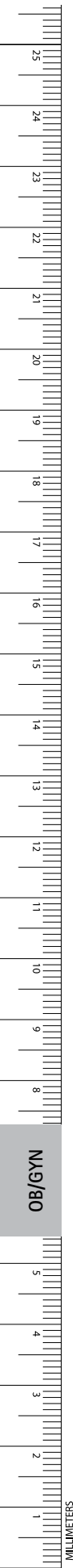

### BOZEMANN-DOUGLAS Forceps

Catalog Number	Tip	Length (in.)
EO085R	SERR	10 1/4

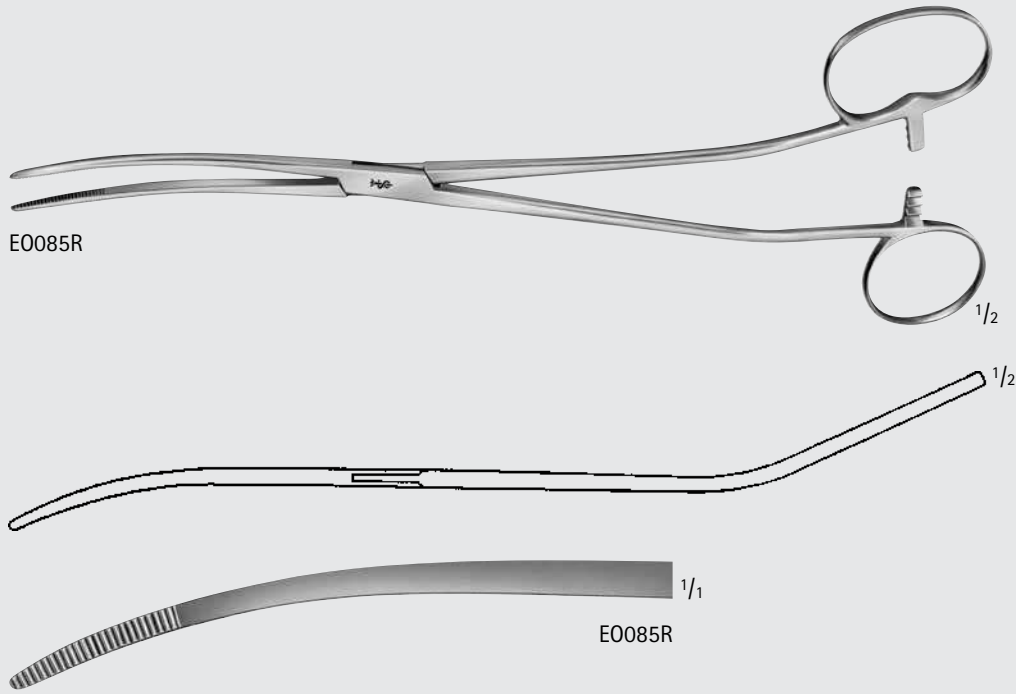

### ADAIR Uterine Forceps

Catalog Number	Teeth	Length (in.)
EO106R	1 x 1	7 1/2

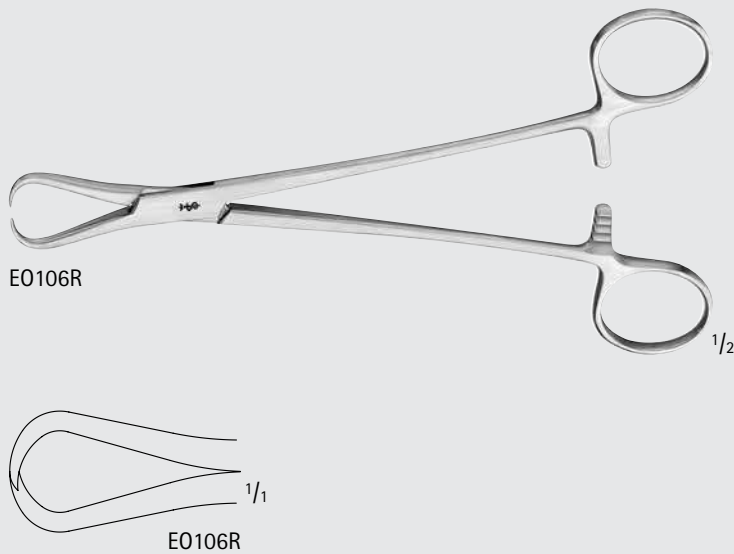



**POZZI Tenaculum Forceps,  
Standard**

Catalog Number	Teeth	Length (in.)
EO105R	1 x 1	6 7/8

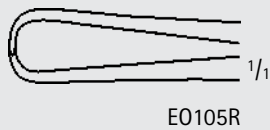
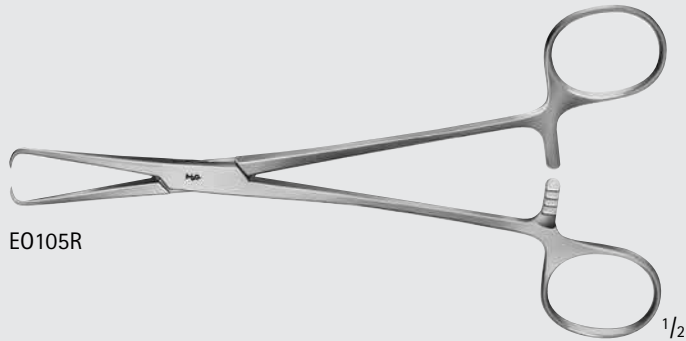

**BARRETT Uterine Tenaculum Forceps**

Catalog Number	Teeth	Length (in.)
MG200R	1 x 1	7

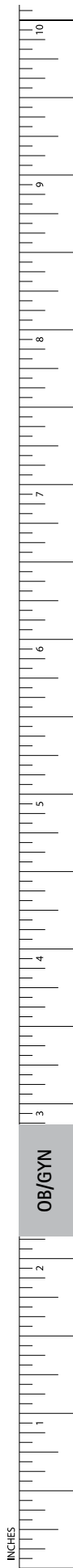
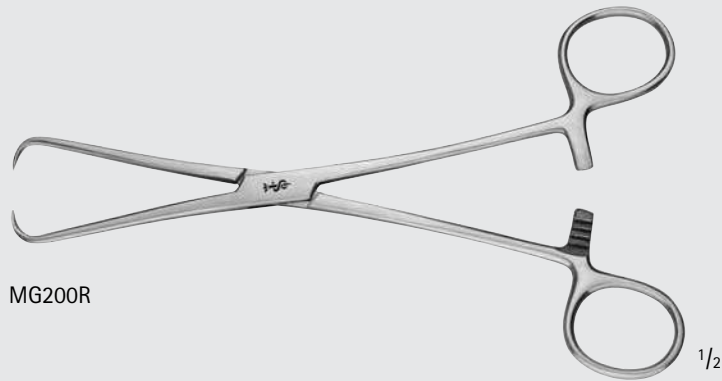

# Obstetrics/Gynecology

## Tenaculum and Sponge Forceps

### BRAUN Tenaculum Forceps

Catalog Number	Teeth	Length (in.)
EO108R	1 x 1	9 3/4

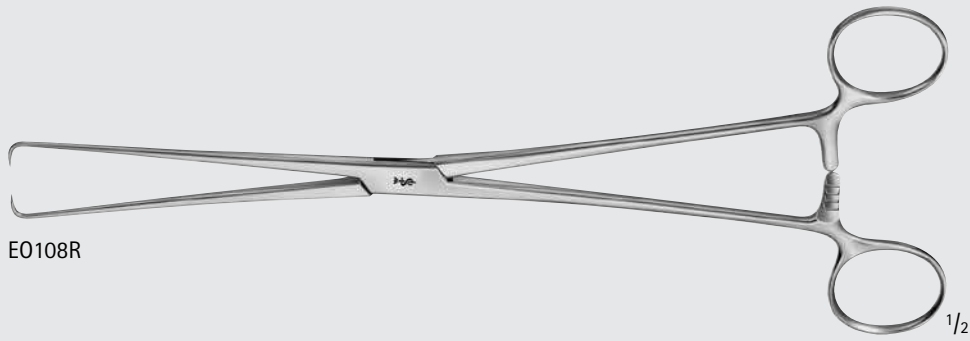

EO108R

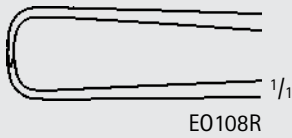

EO108R

### SCHROEDER Tenaculum Forceps

Catalog Number	Shaft	Teeth	Length (in.)
EO110R	STR	1 x 1	9 3/4

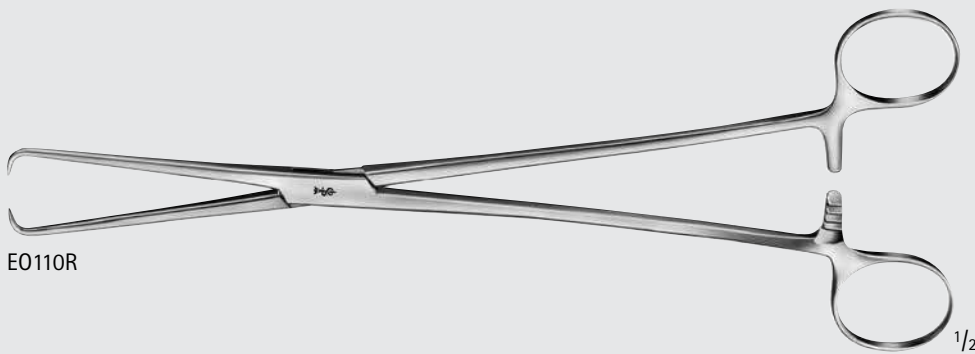

EO110R

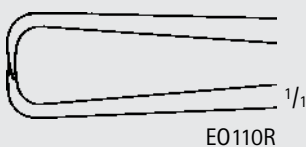

EO110R

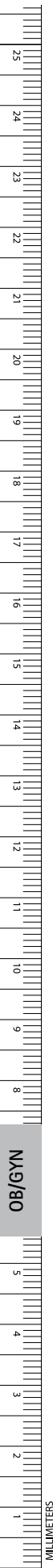

SCHROEDER Tenaculum Forceps

Catalog Number	Shaft	Teeth	Length (in.)
E0150R	STR	2 x 2	9 3/4
E0151R	CVD	2 x 2	9 3/4
E0163R	STR	3 x 3	10 5/8

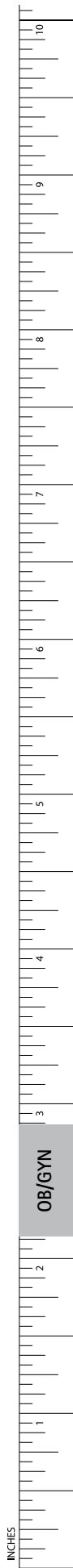
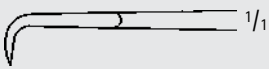
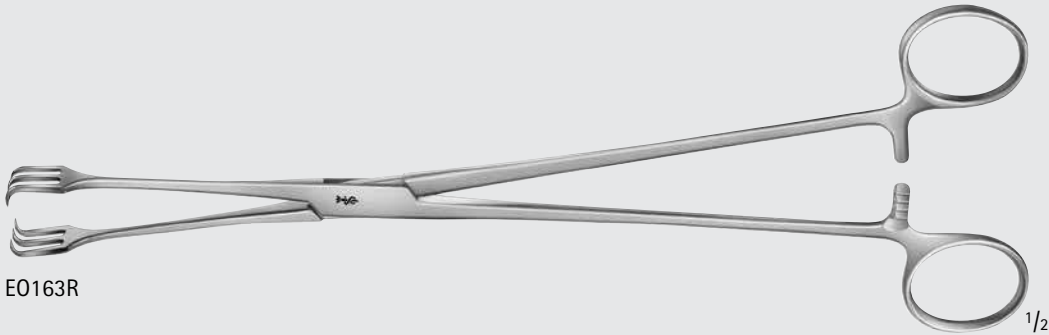
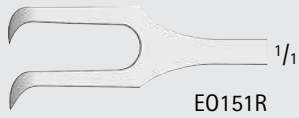
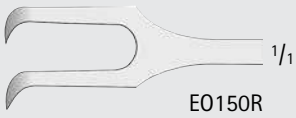
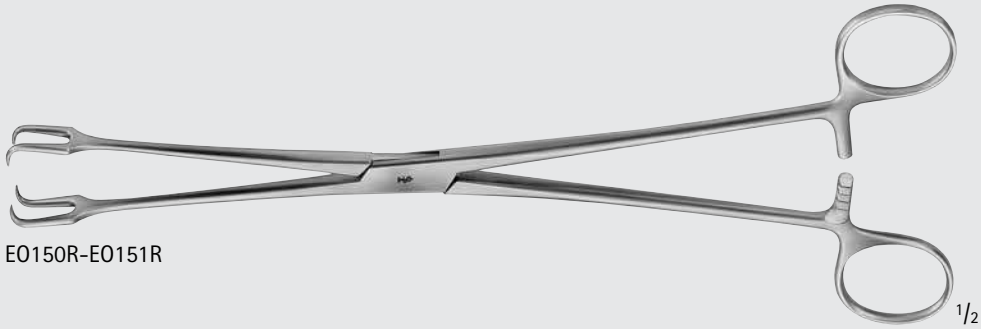

# Obstetrics/Gynecology

## Tenaculum and Sponge Forceps

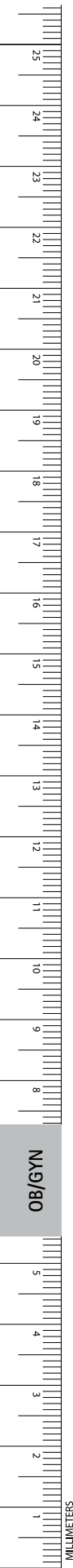

### POZZI Tenaculum Forceps, Heavy

Catalog Number	Teeth	Length (in.)
E0125R	1 x 1	10

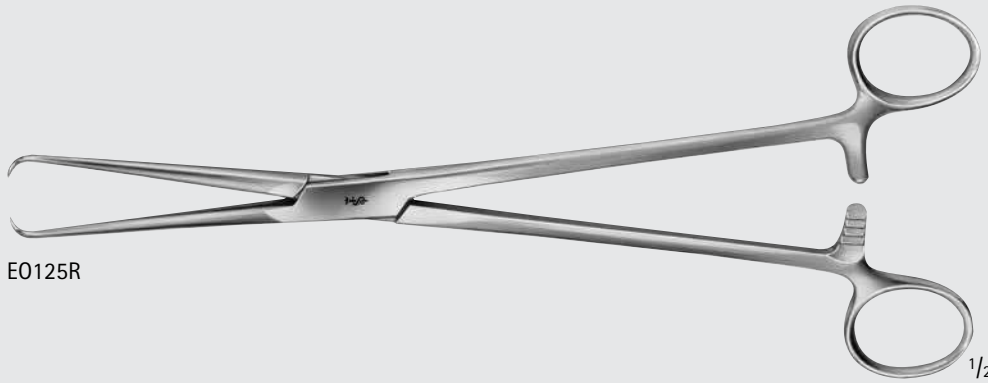

E0125R

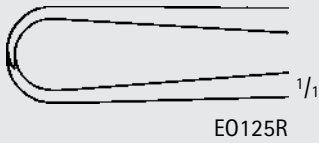

E0125R

### DUPLAY Tenaculum Forceps, Delicate

Catalog Number	Teeth	Length (in.)
E0130R	1 x 1	9 3/4

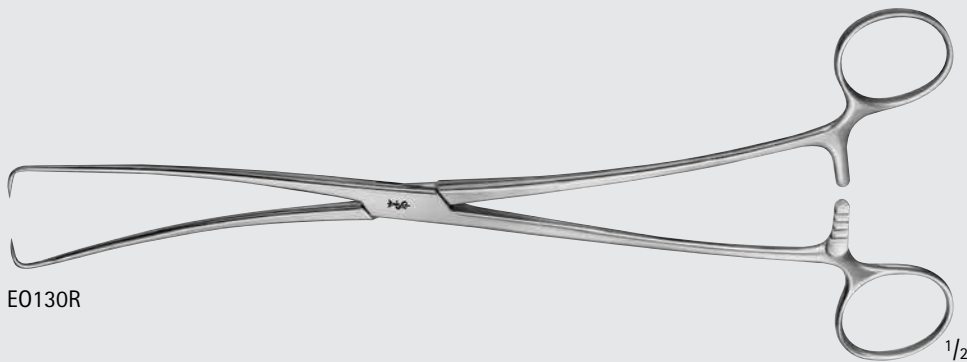

E0130R

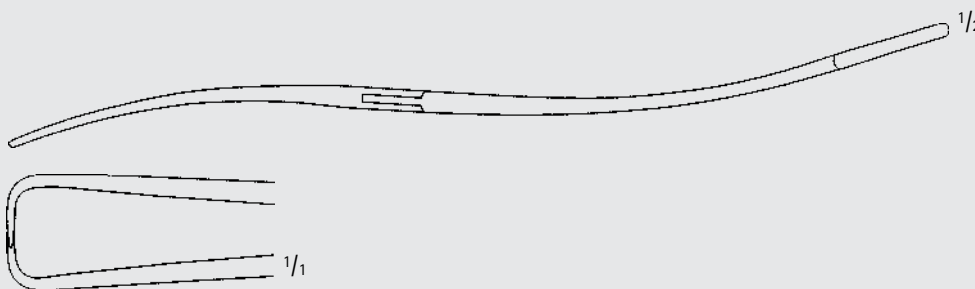

E0130R

**ABEL Tenaculum Forceps**

Catalog Number	Teeth	Length (in.)
EO140R	1 x 1	11

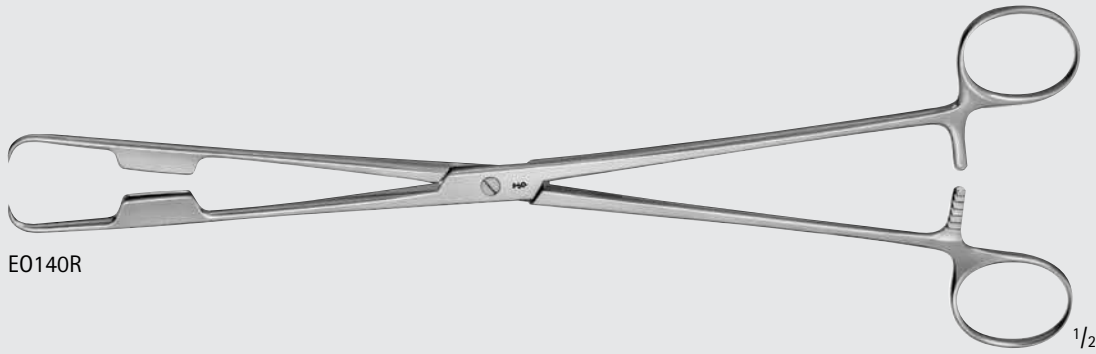

EO140R

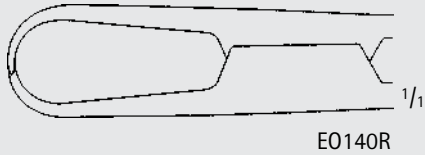

EO140R

**HENROTIN Uterine Vulsellum Forceps**

Catalog Number	Teeth	Length (in.)
MG202R	2 x 3	8 1/4

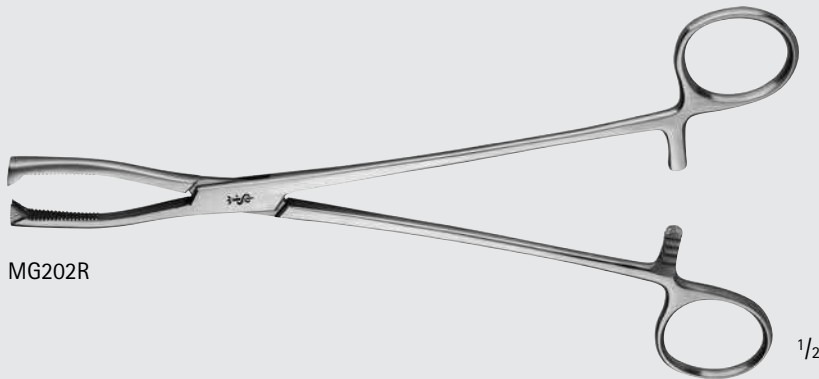

MG202R

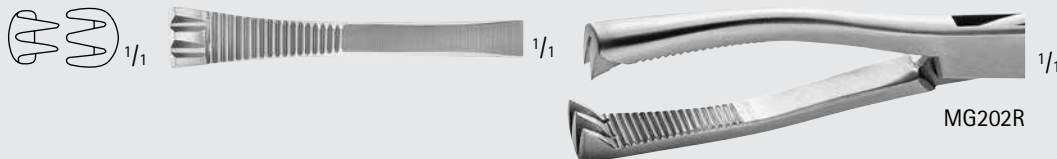

MG202R

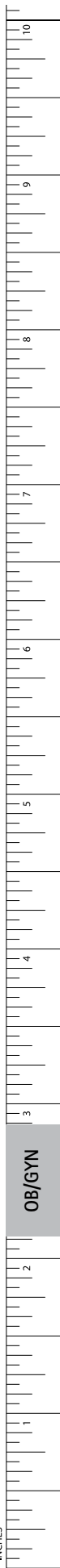

OB/GYN

INCHES

# Obstetrics/Gynecology

## Tenaculum and Sponge Forceps

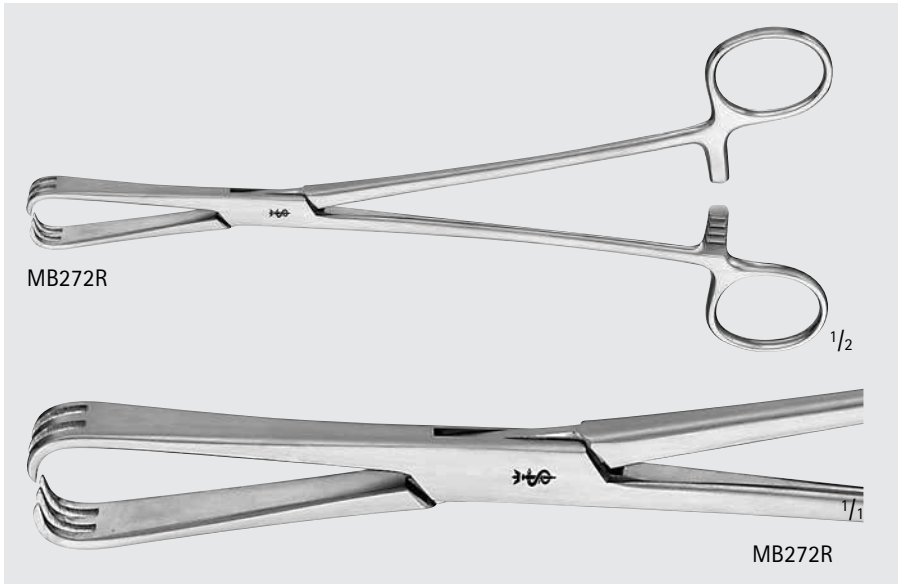
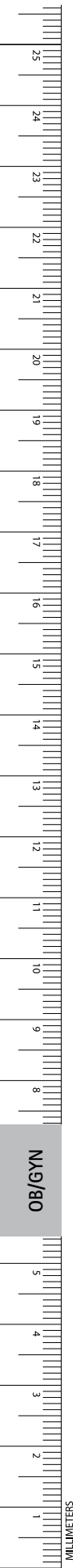

### GORDON Uterine Vulsellum Forceps

Catalog Number	Teeth	Length (in.)
MB272R	3 x 3	8 3/4

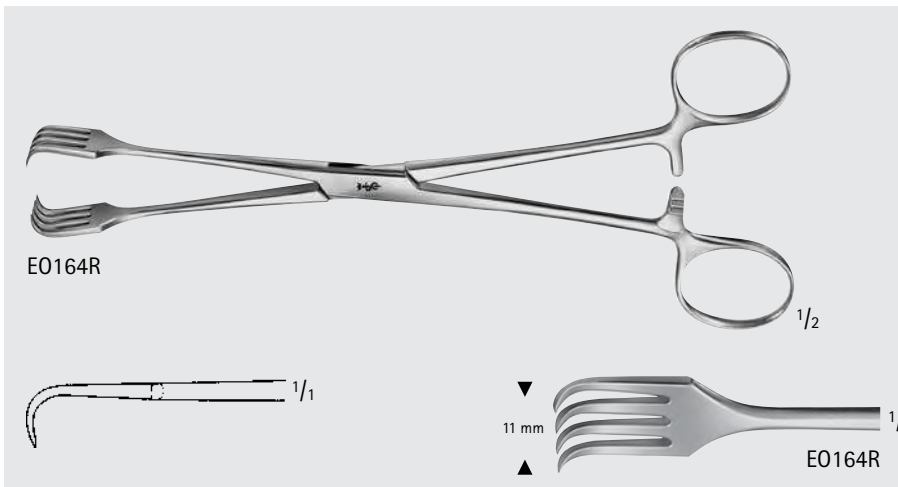

### CZERNY Uterine Tenaculum Forceps

Catalog Number	Teeth	Length (in.)
EO164R	4 x 4	7 7/8

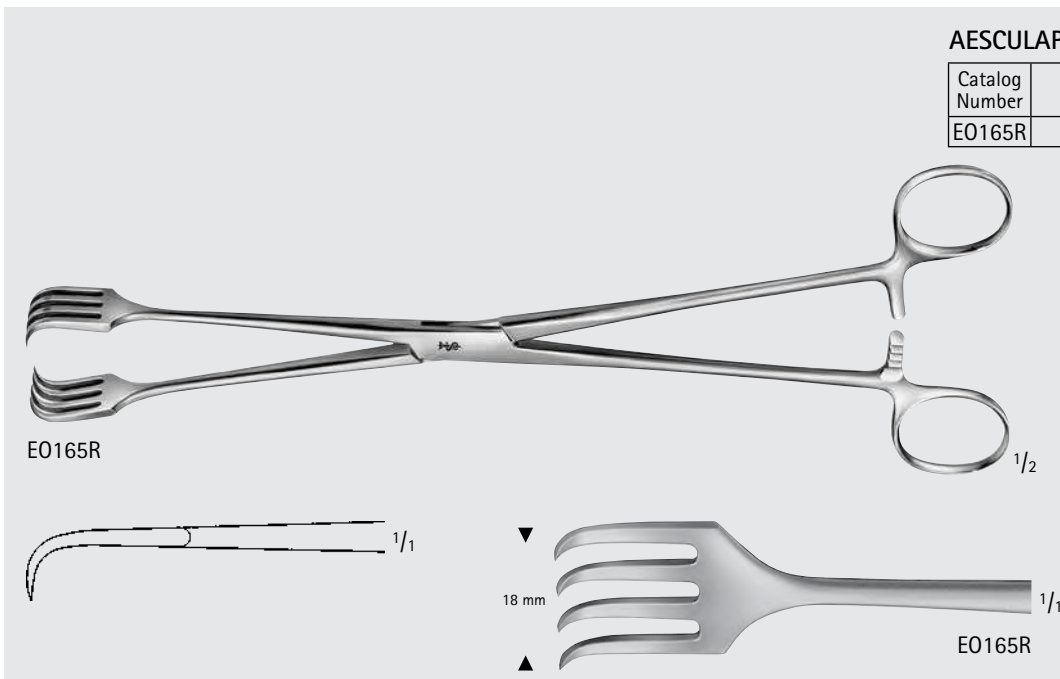

### AESCULAP-PRATT Tenaculum Forceps

Catalog Number	Teeth	Length (in.)
EO165R	4 x 4	10 1/4

**PRATT Tenaculum Forceps**

Catalog Number	Teeth	Length (in.)
EO166R	4 x 4	10 5/8

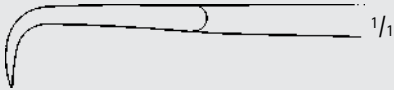

**TEALE Tenaculum Forceps**

Catalog Number	Teeth	Length (in.)
MG184R	3 x 4	9 5/8
EO180R	3 x 4	10

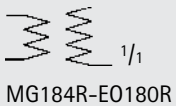
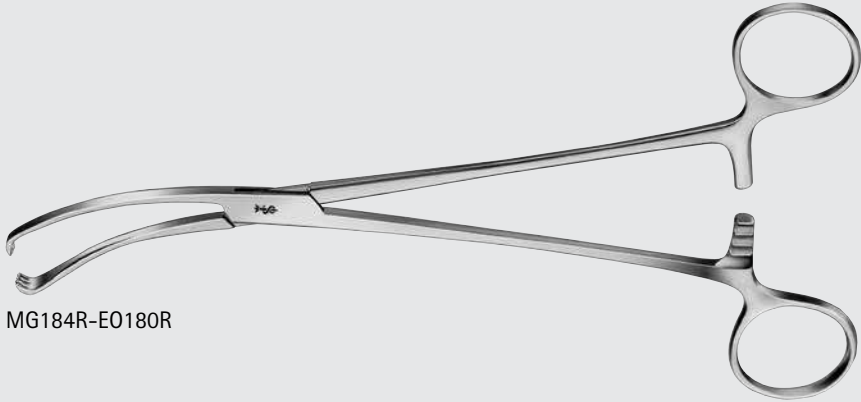

# Obstetrics/Gynecology

## Tenaculum and Sponge Forceps

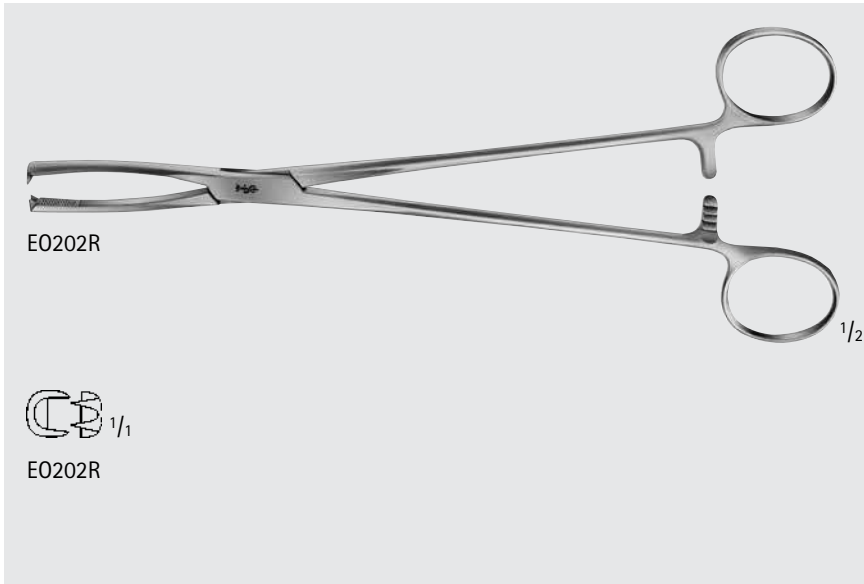
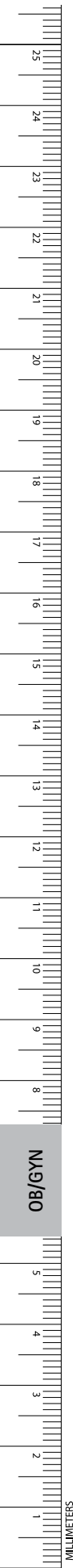

**JACOBS Vulsellum Forceps**

Catalog Number	Teeth	Length (in.)
EO202R	2 x 2	8 1/2

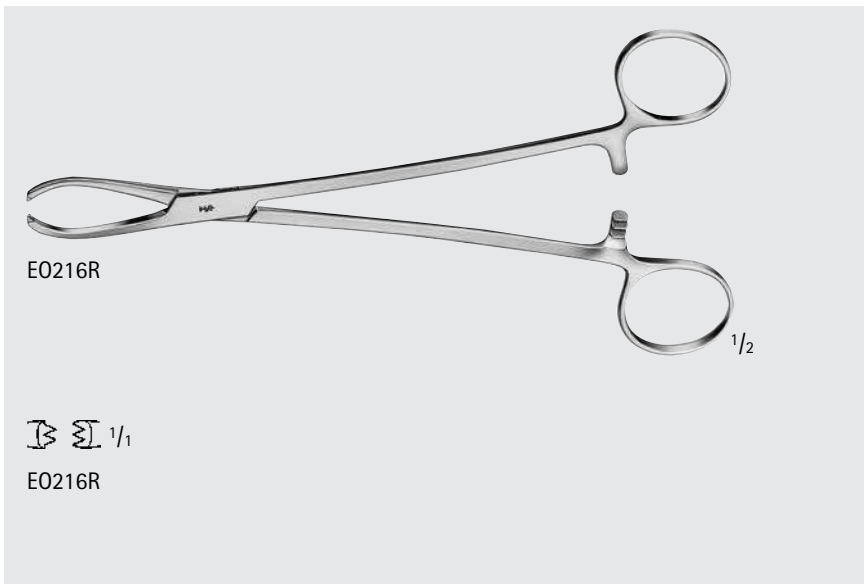

**LITTLEWOOD Tenaculum Forceps**

Catalog Number	Teeth	Length (in.)
EO216R	2 x 3	7 1/4

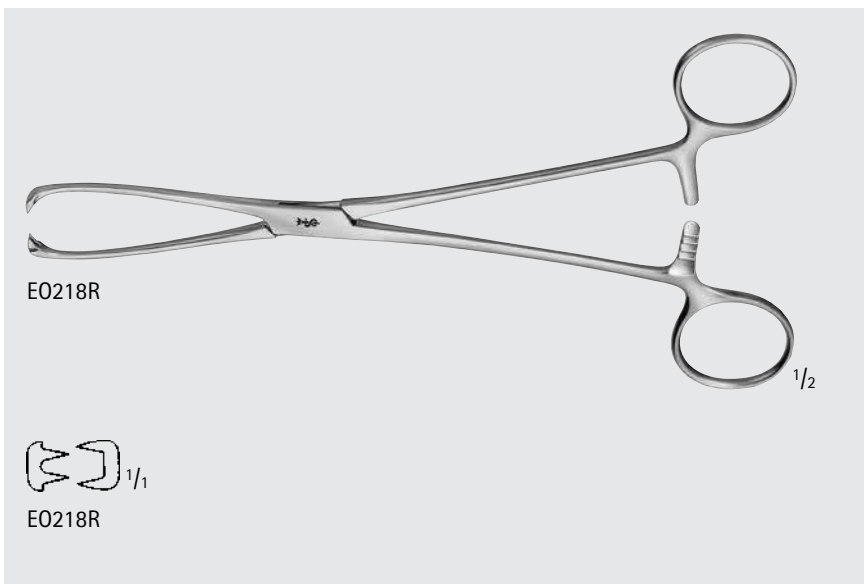

**MUSEUX Tenaculum Forceps, Small**

Catalog Number	Teeth	Length (in.)
EO218R	2 x 2	7 7/8



MUSEUX Tenaculum Forceps

Catalog Number	Jaw	Length (in.)
E0220R	STR	9 1/2
E0221R	STR	9 1/2
E0222R	STR	9 1/2

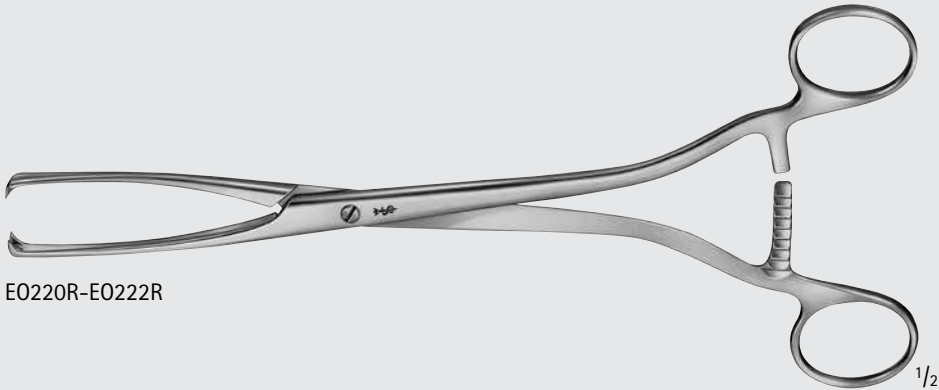

E0220R-E0222R

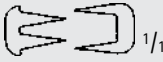

E0220R

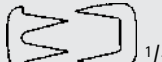

E0221R

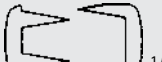

E0222R

MUSEUX Tenaculum Forceps

Catalog Number	Jaw	Length (in.)
E0225R	CVD	9 1/2

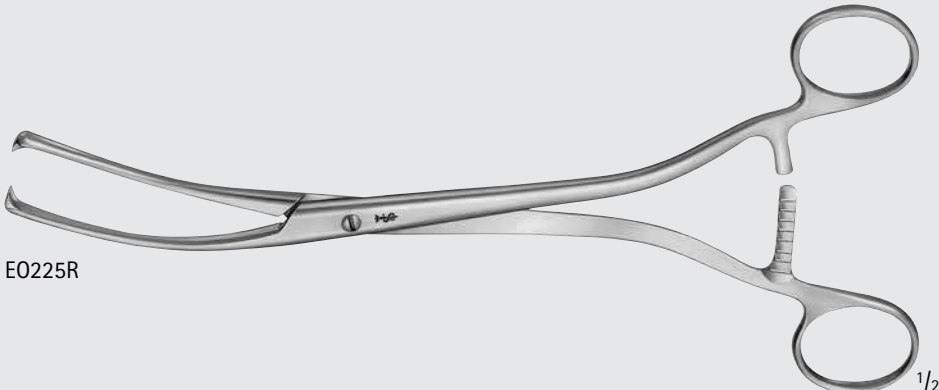

E0225R

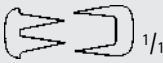

E0225R

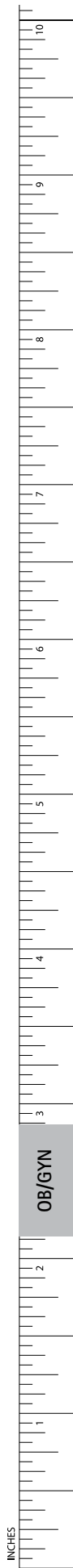

# Obstetrics/Gynecology

## Tenaculum and Sponge Forceps

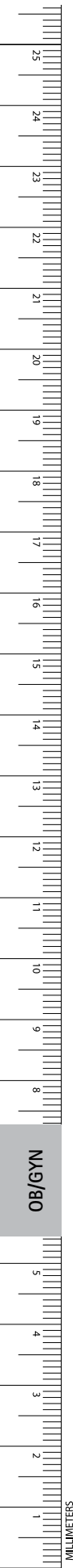

### MUSEUX Tenaculum Forceps

Catalog Number	Jaw	Size	Length (in.)
E0240R	STR	LARGE	10 1/2
E0242R	STR	X-LARGE	10 1/2

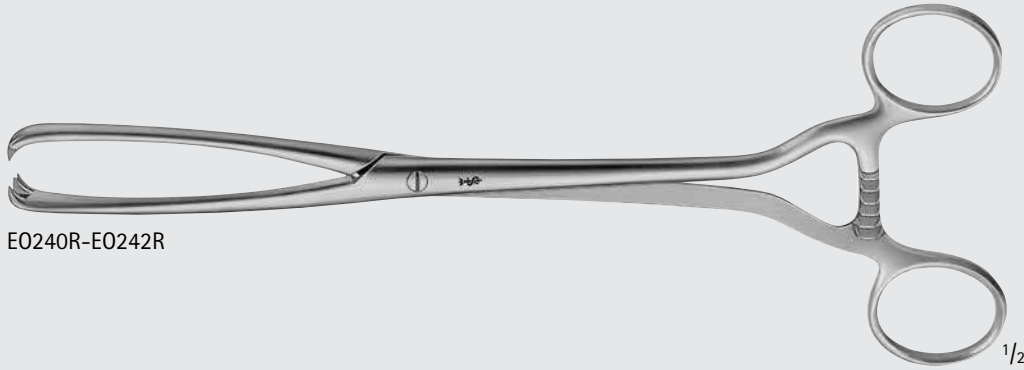

E0240R-E0242R

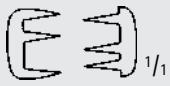

E0240R

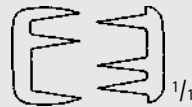

E0242R

### FLETCHER-VAN DOREN Uterine Polyp, Sponge Holding Forceps

Catalog Number	Length (in.)
MB273R	9 1/2

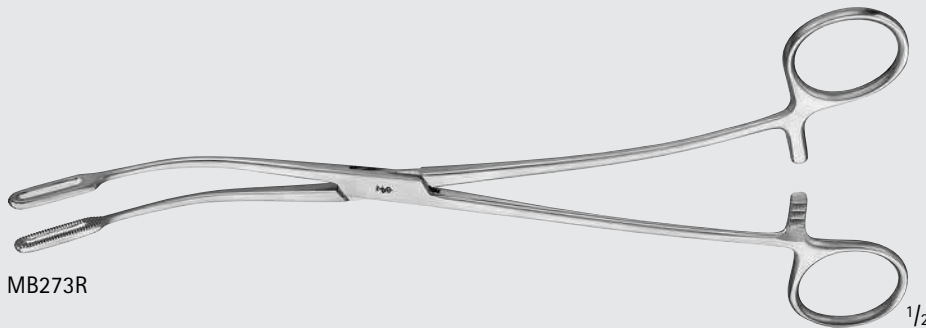

MB273R



MB273R

**FLETCHER Sponge Forceps**

Catalog Number	Tip	Length (in.)
MG193R	STR	9 3/4

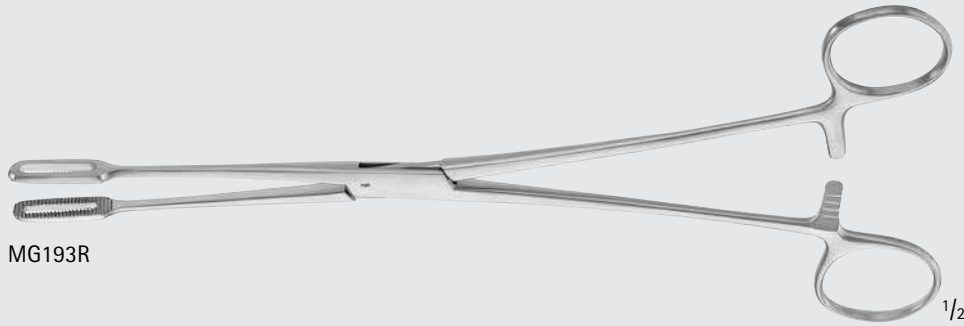

**OVERSTREET Endometrial Polyp Forceps**

Catalog Number	Jaw	Length (in.)
MG195R	HOLLOW, FENESTRATED	9 1/4

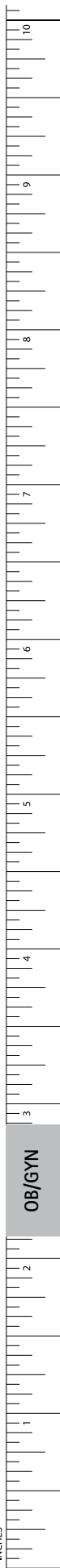
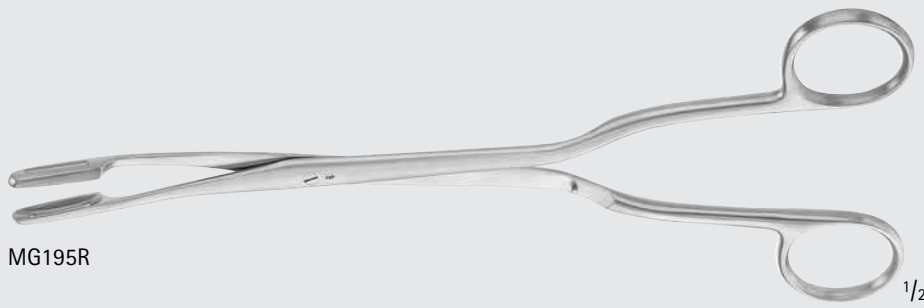

INCHES

OB/GYN

# Obstetrics/Gynecology

## Polyp Forceps

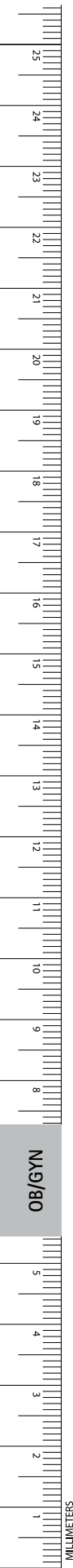

### HEYWOOD-SMITH Polyp Forceps

Catalog Number	Length (in.)
E0310R	9 3/4



E0310R

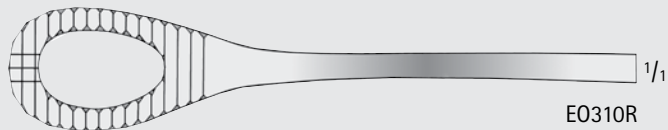

E0310R

### NOTO Polyp Forceps

Catalog Number	Length (in.)
E0315R	11

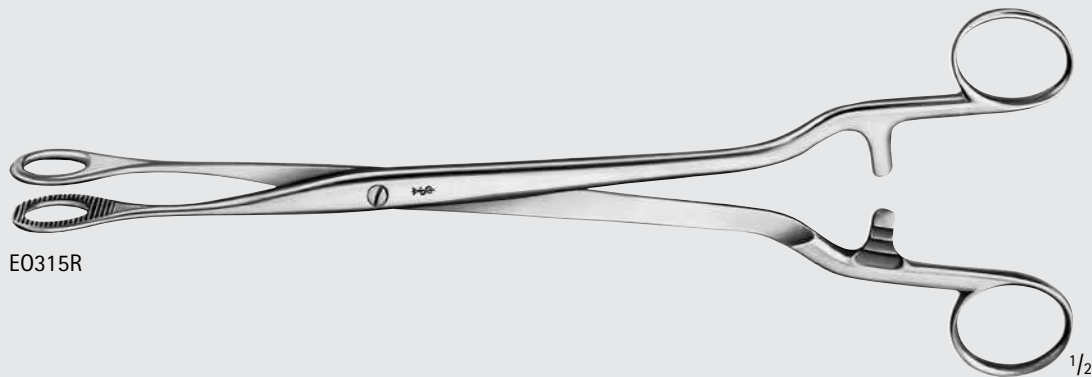

E0315R

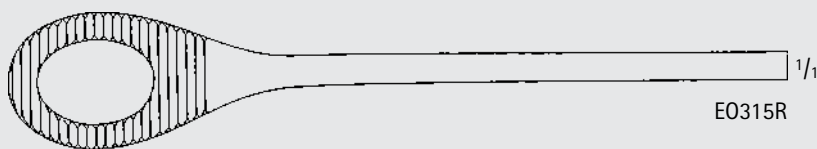

E0315R

**DOYEN Ovum Forceps**

Catalog Number	Length (in.)
E0332R	7 1/4

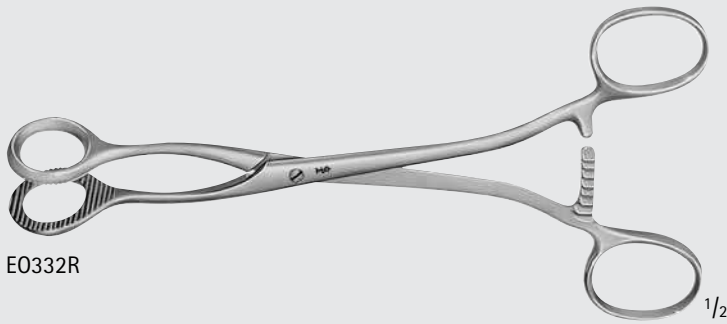

E0332R

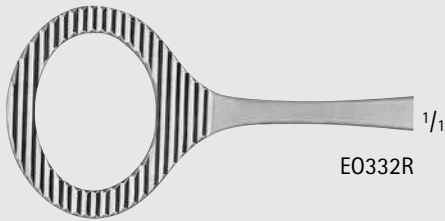

E0332R

**Atraumatic Ovum Forceps**

Catalog Number	Tip	Length (in.)
E0338R	SMALL	9 3/4

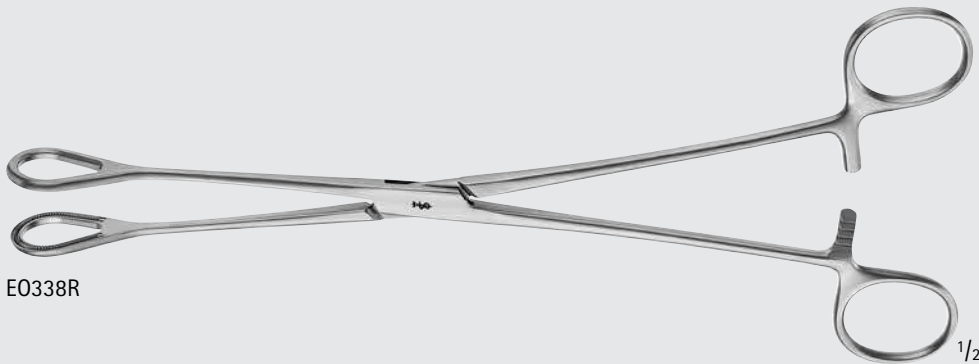

E0338R



E0338R

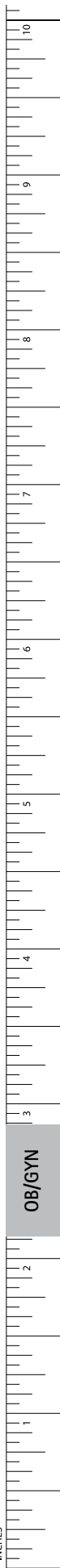

OB/GYN

INCHES

# Obstetrics/Gynecology

## Uterine Elevating Forceps

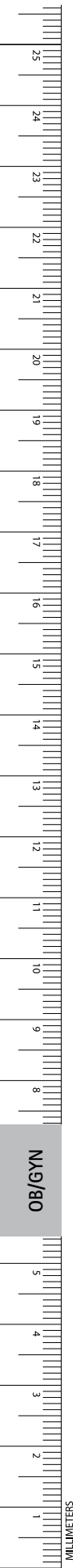

### DARTIGUES Elevating Forceps

Catalog Number	Length (in.)
EO407R	10

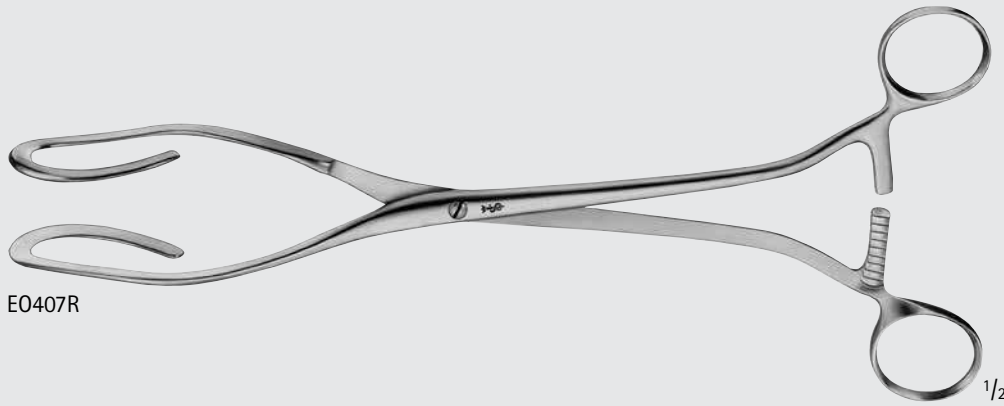

EO407R

1/2

### SOMER Uterine Elevating Forceps

Catalog Number	Length (in.)
EO415R	9 1/4

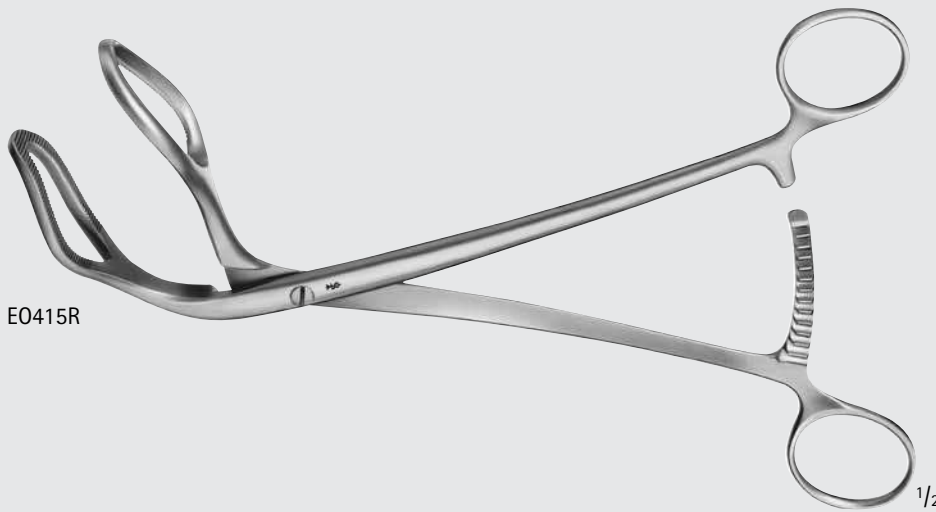

EO415R

1/2

**COLLIN Uterine Elevating Forceps**

Catalog Number	Length (in.)
EO405R	11 1/4

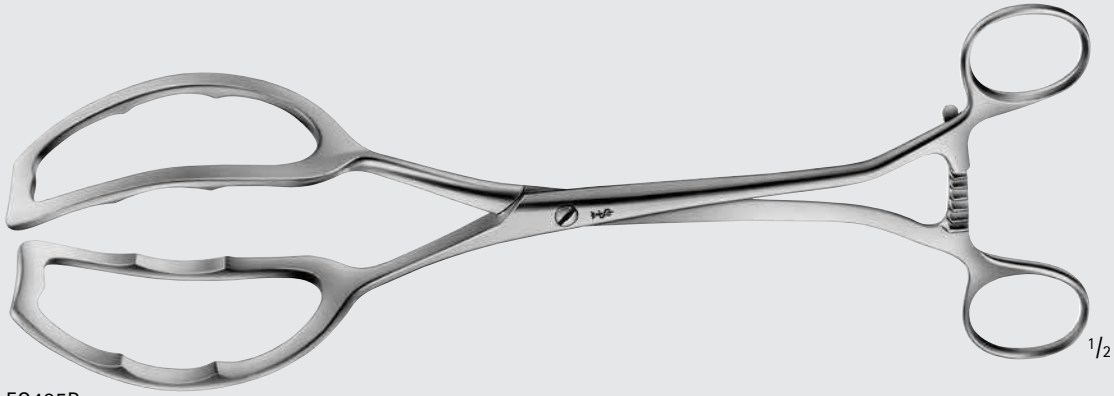

EO405R

**COLLIN Uterine Elevating Forceps, Movable Jaw**

Catalog Number	Blade	Length (in.)
EO420R	STR	10 1/2

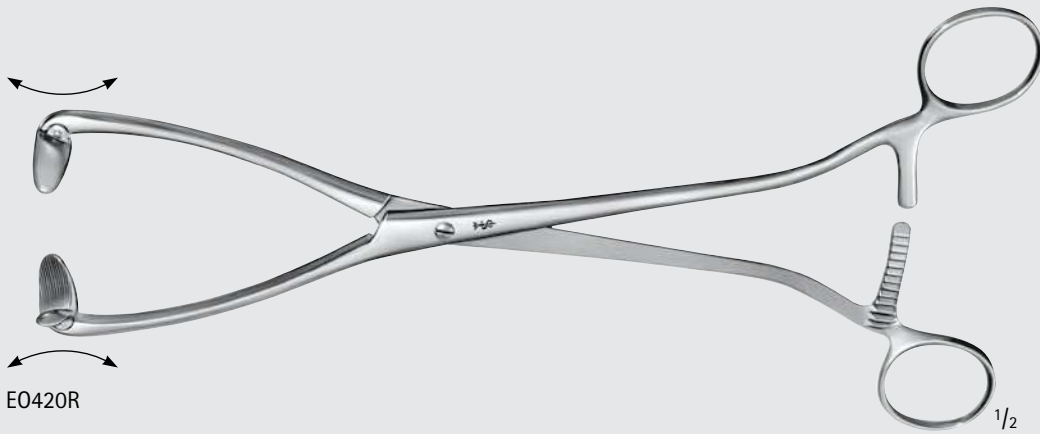

EO420R

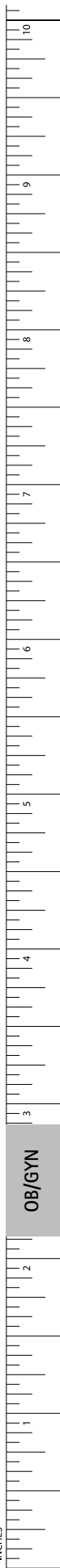

# Obstetrics/Gynecology

## Uterine Elevating and Membrane Forceps

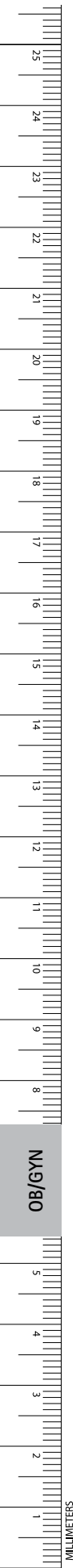

### HULKA-KENNWICK Uterine Elevating Forceps

Catalog Number	Length (in.)
E0422R	10 3/4

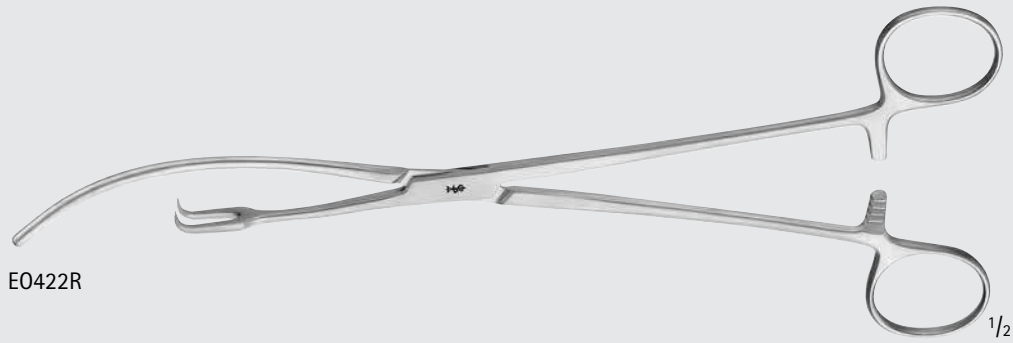

E0422R

1/2



E0422R

1/1

### IOWA Membrane Puncturing Forceps

Catalog Number	Length (in.)
MG189R	10

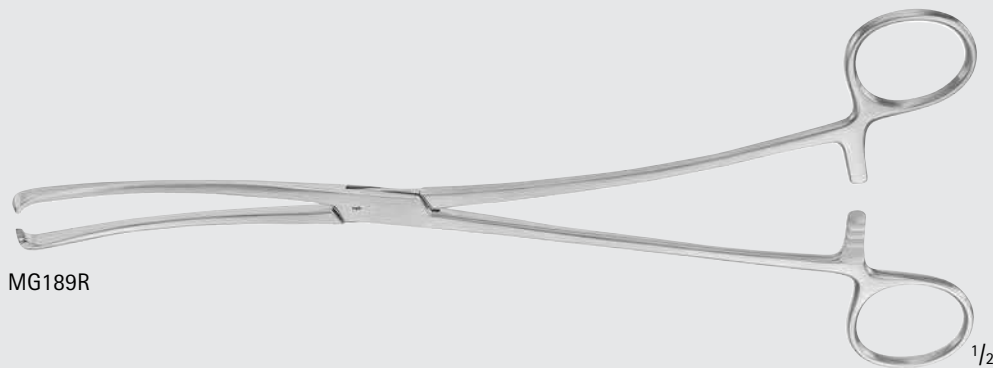

MG189R

1/2



MG189R

1/1



DOYEN Myoma Screw

Catalog Number	Length (in.)
E0433R	6
E0435R	7 1/2

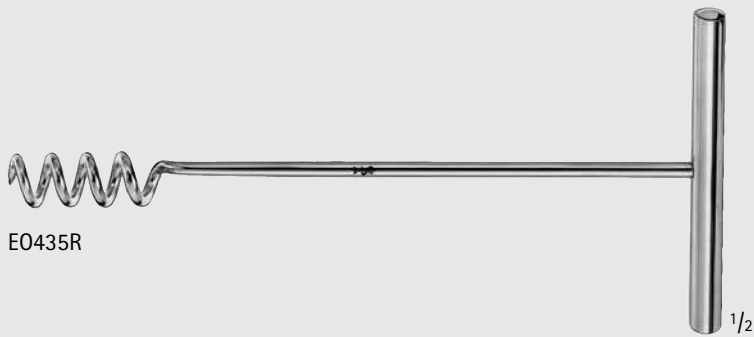

# Obstetrics/Gynecology

## Obstetrical Forceps

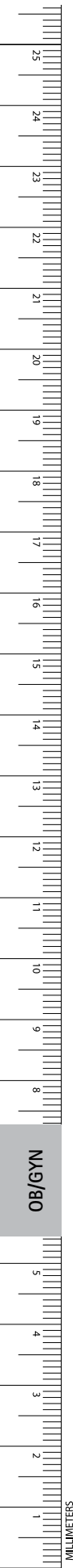

### NAEGELE Obstetrical Forceps

Catalog Number	Length (in.)
ET205R	14

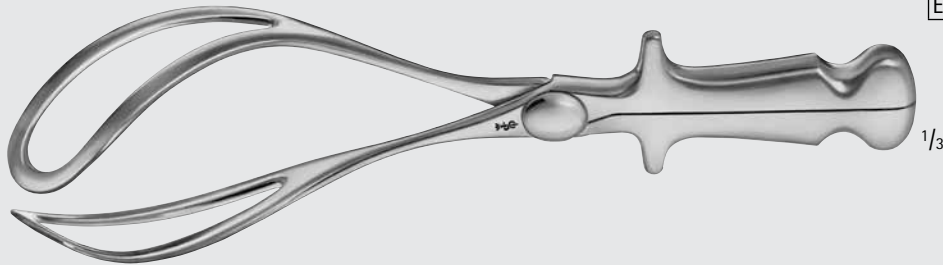

ET205R

### KIELLAND Obstetrical Forceps

Catalog Number	Length (in.)
ET210R	16 1/2

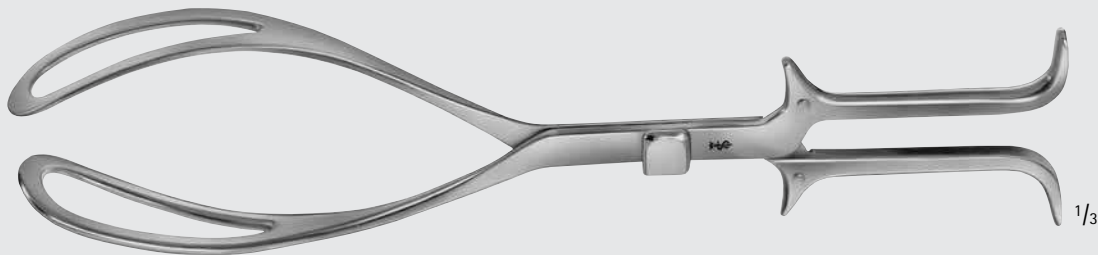

ET210R

### SIMPSON-BRAUN Obstetrical Forceps

Catalog Number	Length (in.)
ET220R	12
ET221R	13 3/4

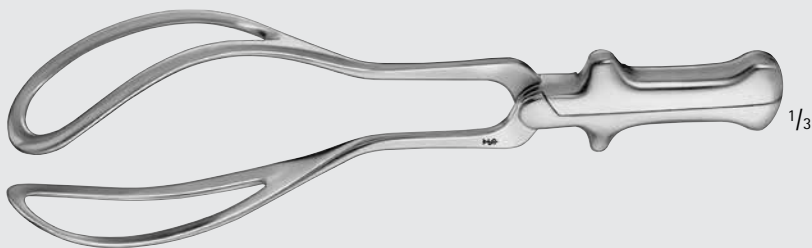

ET220R



ET221R

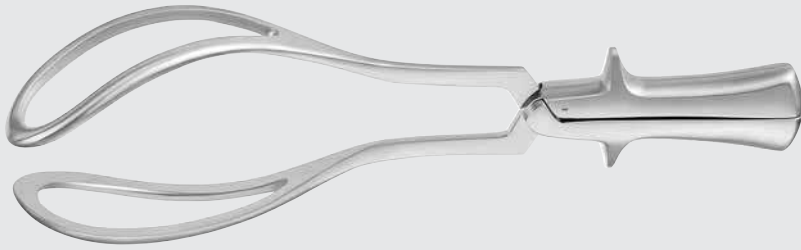

**DE LEE Obstetrical Forceps**

Catalog Number	Length (in.)
MG190R	12
MG185R	14

MG190R-MG185R



**ELLIOTT Obstetrical Forceps**

Catalog Number	Length (in.)
MG191R	15

MG191R

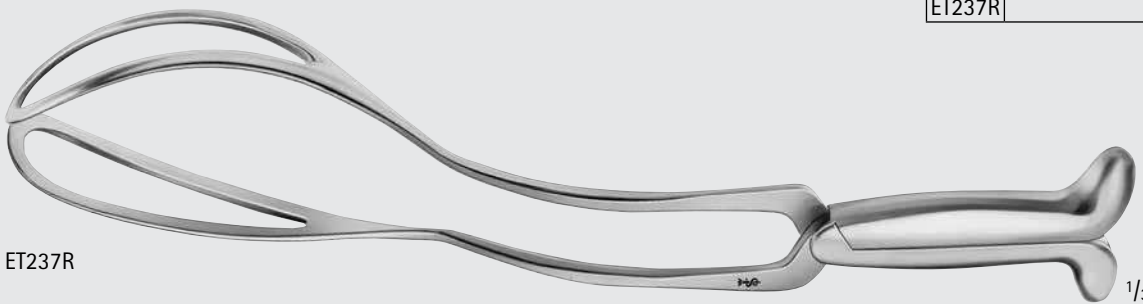

**PIPER Obstetrical Forceps, F/ Breach**

Catalog Number	Length (in.)
ET237R	17 1/2

ET237R



OB/GYN

INCHES

# Obstetrics/Gynecology

## Obstetrical Forceps



ET245R

### SIMPSON C-Section Forceps

Catalog Number	Length (in.)
ET245R	9 1/4

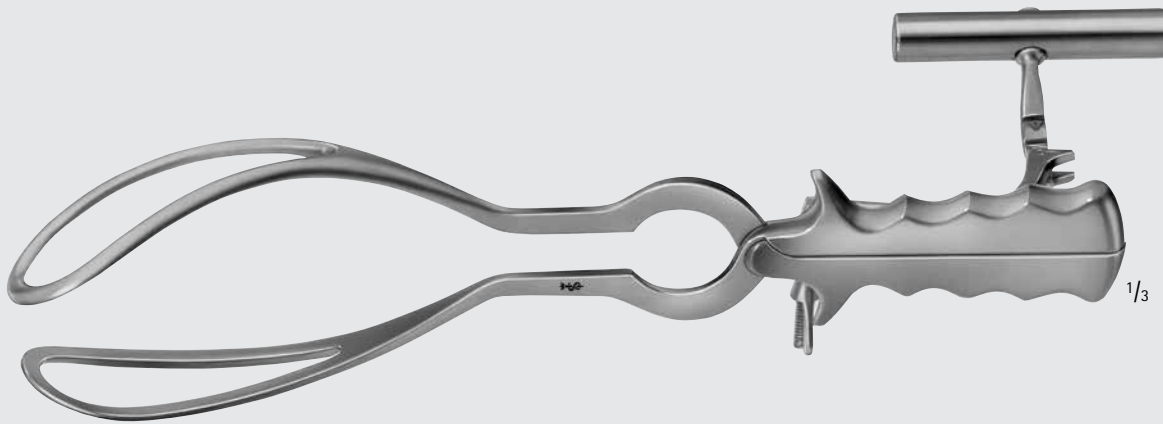

ET255R

### BARNES-NEVILLE Obstetrical Forceps, With Traction Handle

Catalog Number	Length (in.)
ET255R	17 1/8

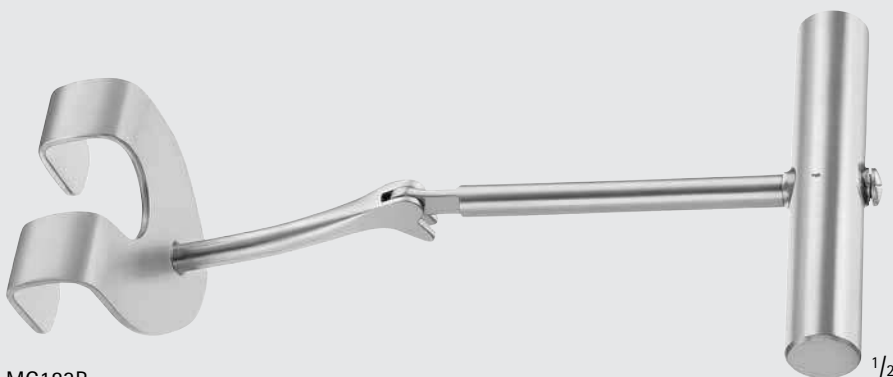

MG183R

### BILL Traction Handle

Catalog Number	Description
MG183R	FOR USE W/ STANDARD OB FORCEPS

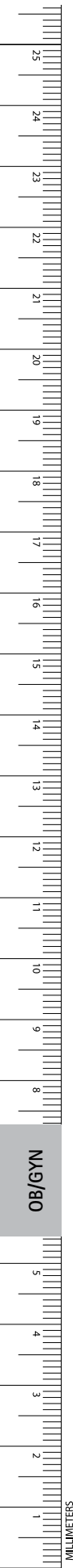

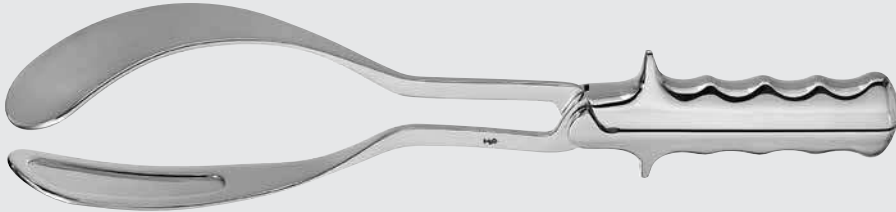

1/3

MB298R

**LUIKART-SIMPSON Obstetrical Forceps**

Catalog Number	Length (in.)
MB298R	14



1/3

MB299R

**LUIKART-MCLANE Obstetrical Forceps**

Catalog Number	Length (in.)
MB299R	15 1/2



1/3

MB069R

**LUIKART-KIELLAND Obstetrical Forceps**

Catalog Number	Length (in.)
MB069R	15 1/2



# Obstetrics/Gynecology

## Obstetrical Forceps and Head Extractor

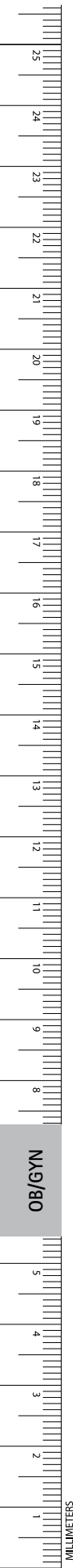

### LUIKHART Obstetrical Forceps

Catalog Number	Length (in.)
MG186R	16

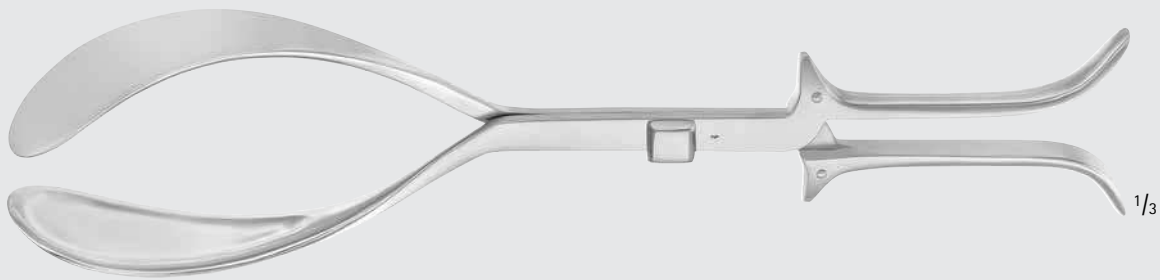

MG186R

### MCLANE-TUCKER Obstetrical Forceps

Catalog Number	Length (in.)
MG192R	16 1/4



MG192R

### MURLESS Head Extractor

Catalog Number	Length (in.)
MG492R	10

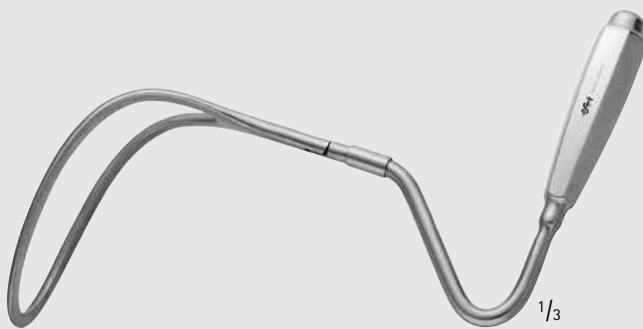

MG492R

**SELLHEIM Obstetric Lever**

Catalog Number	Blade	Length (in.)
ET270R	OPEN	11 3/4

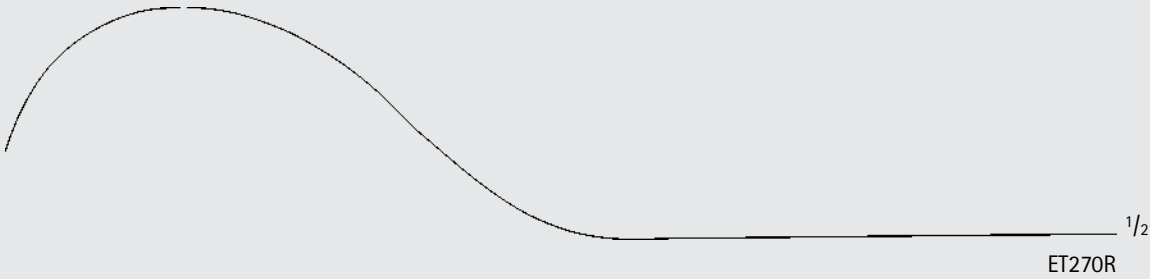

**GREEN-ARMYTAGE Forceps, F/ C-Section**

Catalog Number	Length (in.)
ET269R	8 3/4

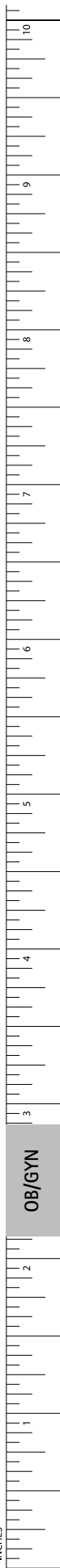

# Obstetrics/Gynecology

## Placenta and Ovum Forceps

### BARRETT Placenta Forceps

Catalog Number	Blade	Length (in.)
MG201R	FENESTRATED	10

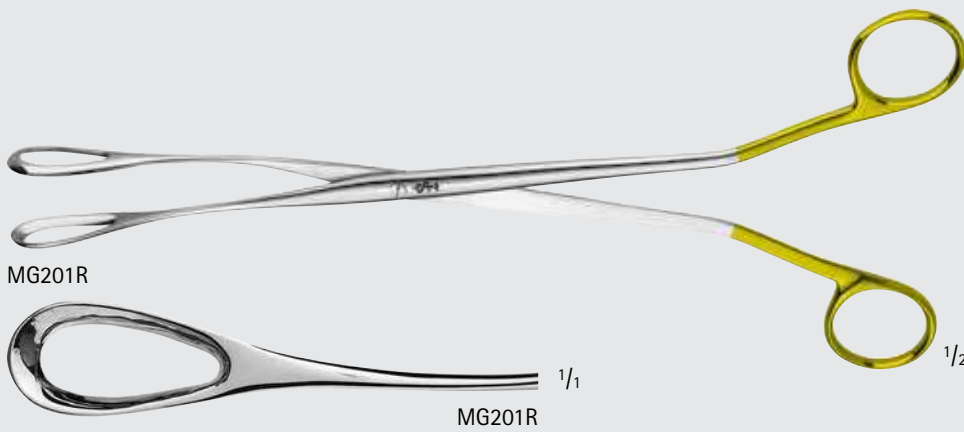

### BIERER Ovum Forceps

Catalog Number	Jaw (mm)	Ratchet	Length (in.)
MG466R	16	NO	11
MG467R	16	YES	11
MG468R	19	NO	11
MG469R	19	YES	11

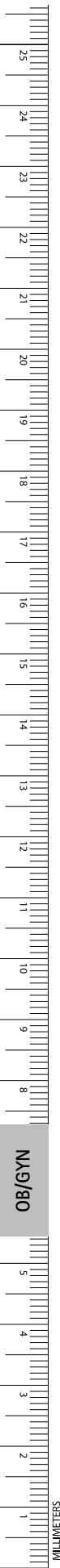
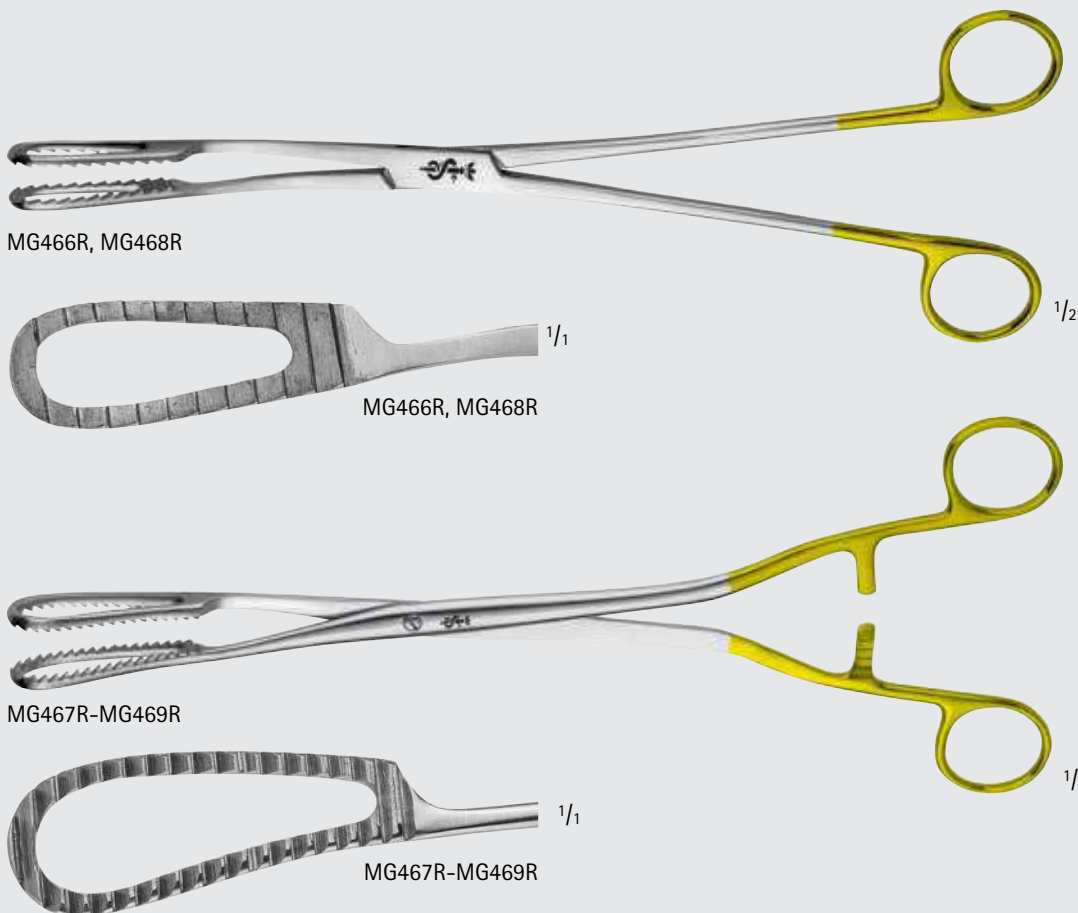

OB/GYN



WINTER Placenta and Ovum Forceps,  
W/O Ratchet

Catalog Number	Size (#)	Jaw	Length (in.)
ET301R	1	STR	11 1/2
ET302R	2	STR	11 1/2

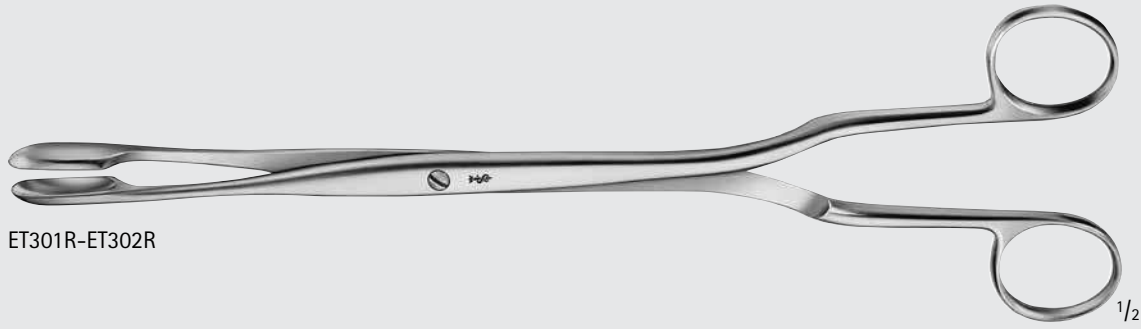

ET301R-ET302R



ET301R



ET302R



Obstetrics/Gynecology  
Placenta and Ovum Forceps

WINTER Placenta and Ovum Forceps,  
W/O Ratchet (continued)

Catalog Number	Size (#)	Jaw	Length (in.)
ET306R	1	CVD	11 1/2
ET307R	2	CVD	11 1/2
ET308R	3	CVD	11 1/2

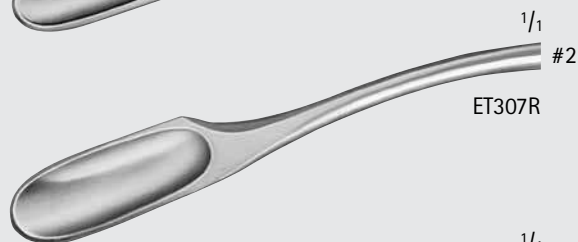
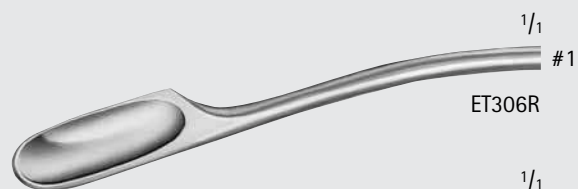

WINTER Placenta and Ovum Forceps,  
W/ Ratchet

Catalog Number	Size (#)	Jaw	Length (in.)
ET315R	2	CVD	11 1/2
ET316R	3	CVD	11 1/2

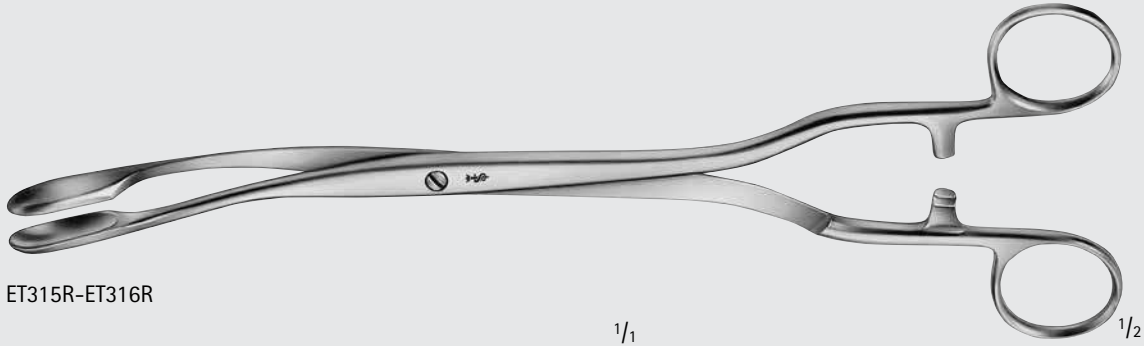

ET315R-ET316R

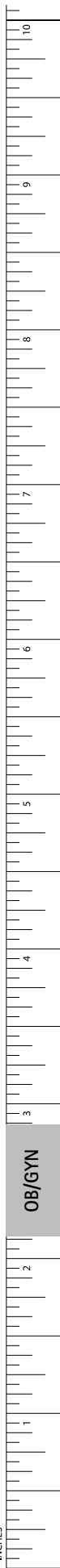
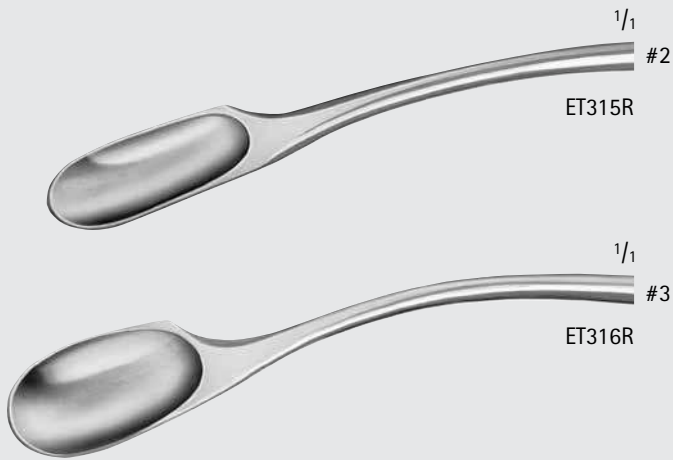

OB/GYN

INCHES

Obstetrics/Gynecology  
Placenta and Ovum Forceps

SAENGER Placenta and Ovum Forceps,  
W/ Ratchet

Catalog Number	Jaw	Length (in.)
ET326R	STR	10 3/4
ET327R	CVD	10 1/2
ET325R	CVD	11 1/4

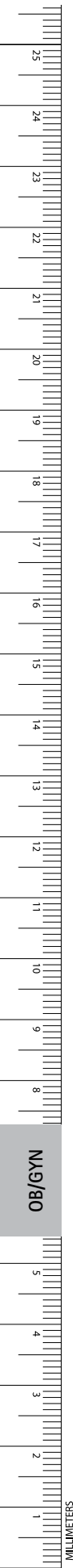
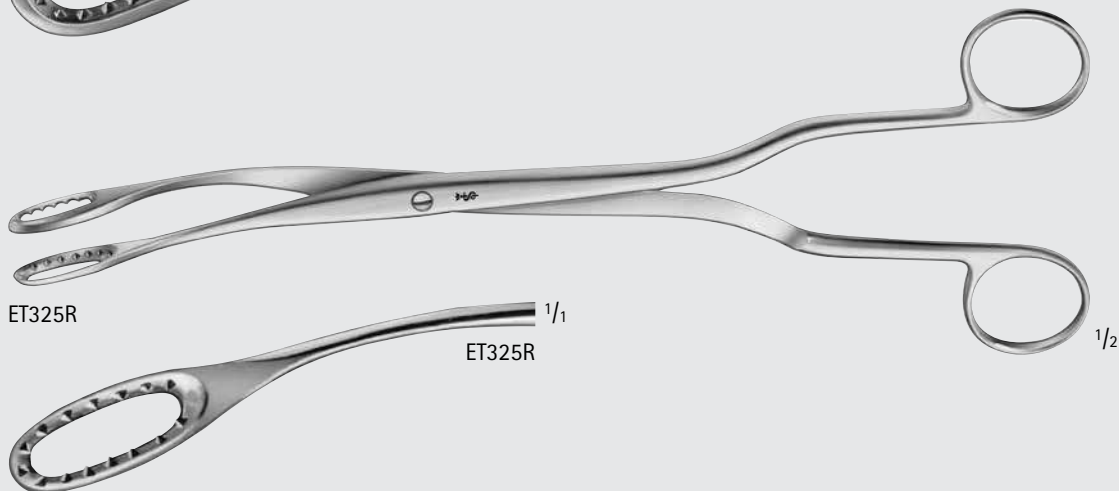
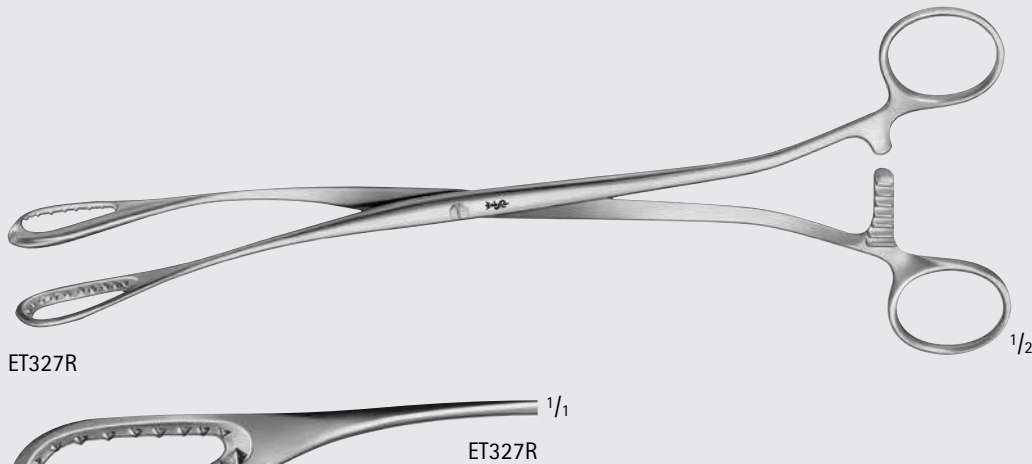
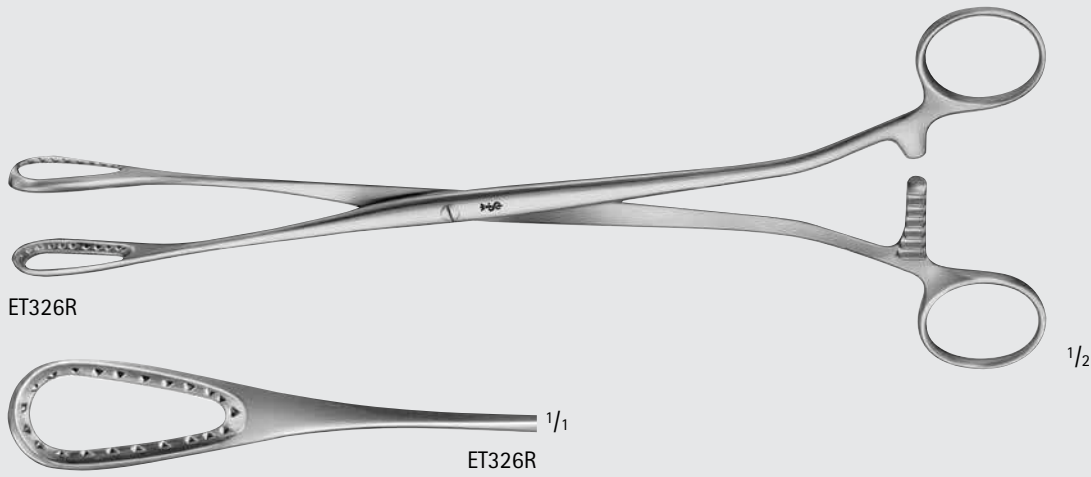

MCCLINTOCK Placenta and Ovum Forceps

Catalog Number	Length (in.)
ET329R	9 1/2



ET329R

1/2



1/1

ET329R

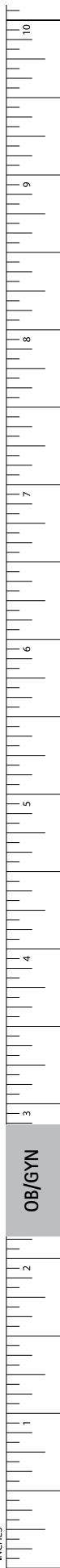

OB/GYN

INCHES

# Obstetrics/Gynecology

## Biopsy Forceps

THOMS-GAYLOR Biopsy Forceps,  
S-Shape

Catalog Number	Length (in.)
ER050R	9 1/2

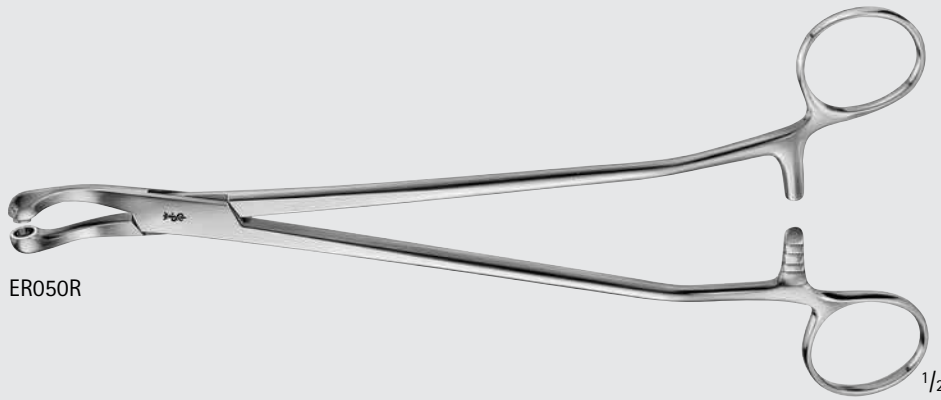

ER050R

1/2



ER050R

1/1



1/1

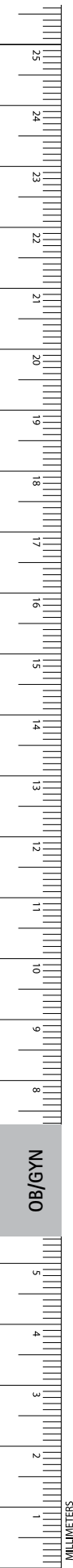

**SCHUMACHER Biopsy Forceps, S-Shape**

Catalog Number	Tip	Length (in.)
ER061R	SMALL	9 1/2
ER062R	LARGE	9 1/2

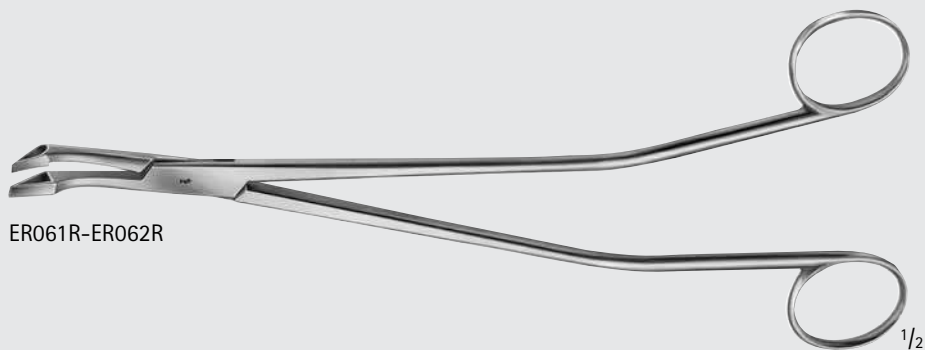

ER061R



ER062R

**SCHUMACHER Biopsy Rongeur**

Catalog Number	Tip	Length (in.)
ER063R	SMALL	9 1/2
ER064R	LARGE	9 1/2

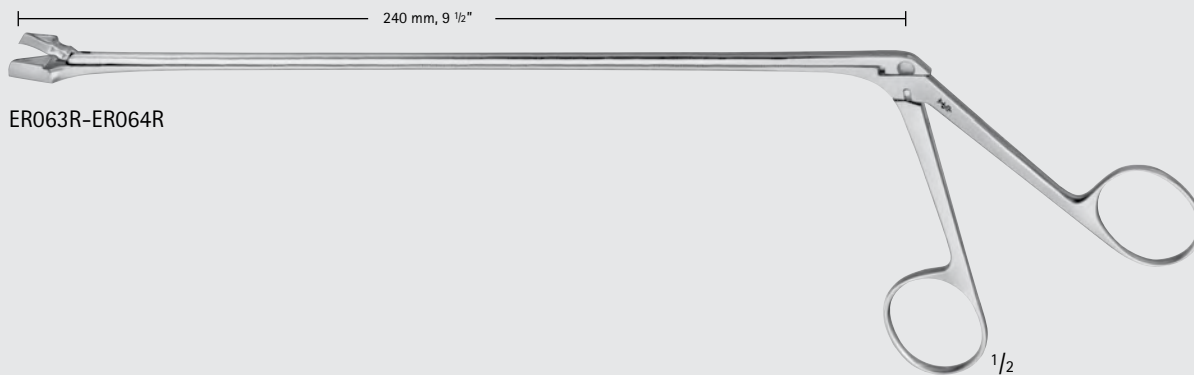

ER063R



ER064R

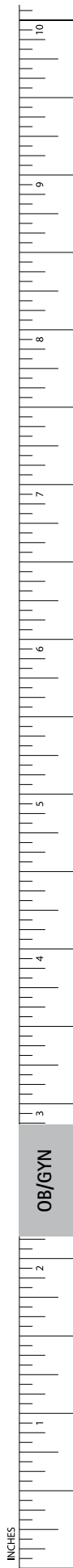

# Obstetrics/Gynecology

## Biopsy Forceps

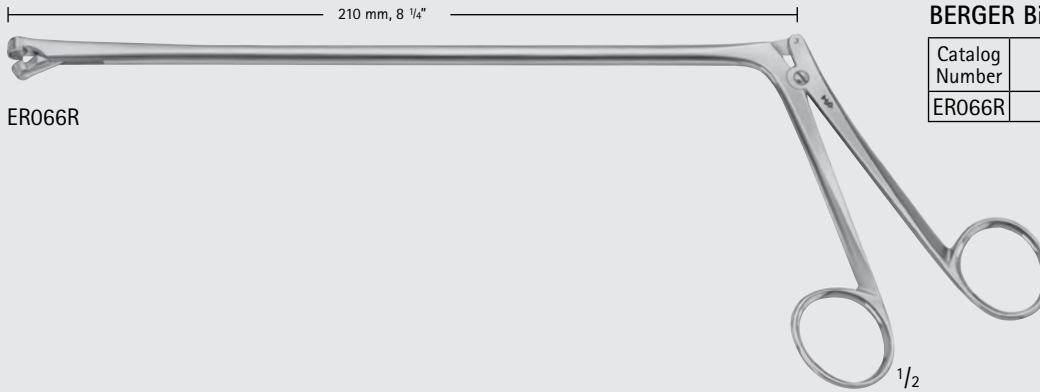
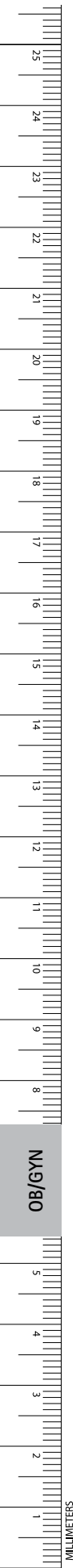

**BERGER Biopsy Forceps**

Catalog Number	Length (in.)
ER066R	8 1/4

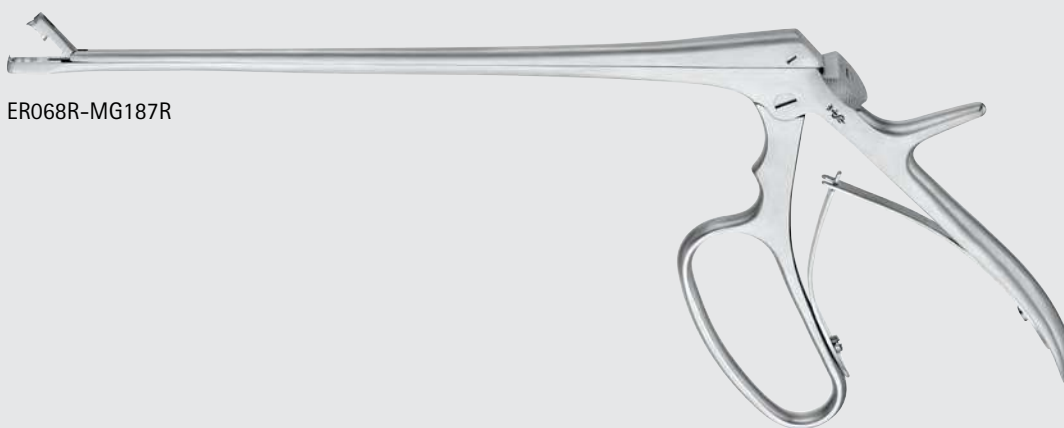

**TISCHLER Cervical Biopsy Punch Forceps**

Catalog Number	Jaw Size (mm)	Working Length (in.)
ER068R	5 x 6 x 3	8 1/4
MG187R	7 x 3	11





**TISCHLER Biopsy Alligator Forceps**

Catalog Number	Jaw	Jaw Size (mm)	Length (in.)
MG076R	OBLONG CUP SINGLE TOOTH	7 x 3	9 3/4



MG076R



MG076R

**KEVORKIAN-YOUNGE Biopsy Forceps**

Catalog Number	Jaw Size (mm)	Working Length (in.)
ER080R	8.5 x 3.5	10

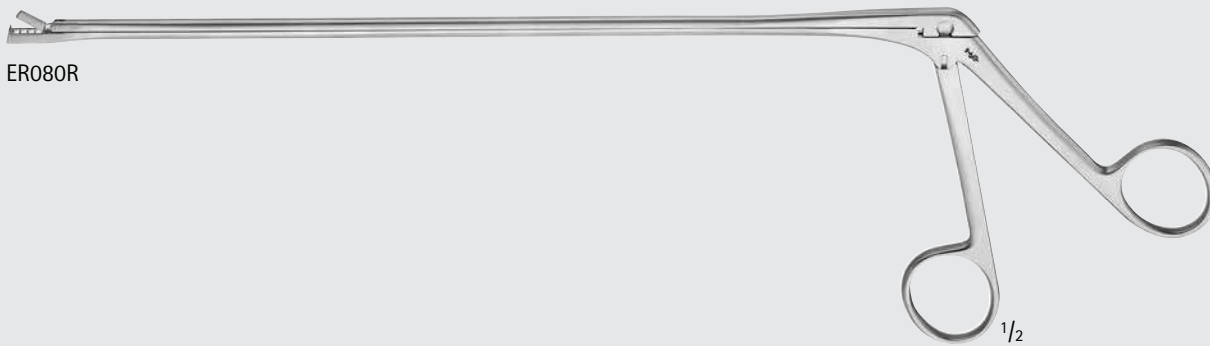

ER080R



ER080R

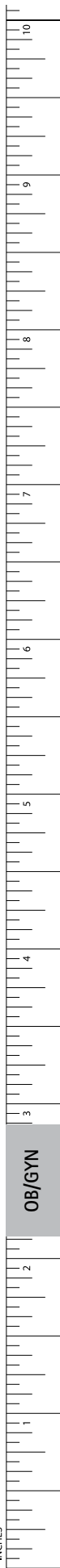

OB/GYN

INCHES

# Obstetrics/Gynecology

## Biopsy Forceps

### WITTNER Biopsy Forceps

Catalog Number	Jaw	Jaw Size (mm)	Working Length (in.)
MG194R	STR. JAWS W/ TEETH	4 x 8	9

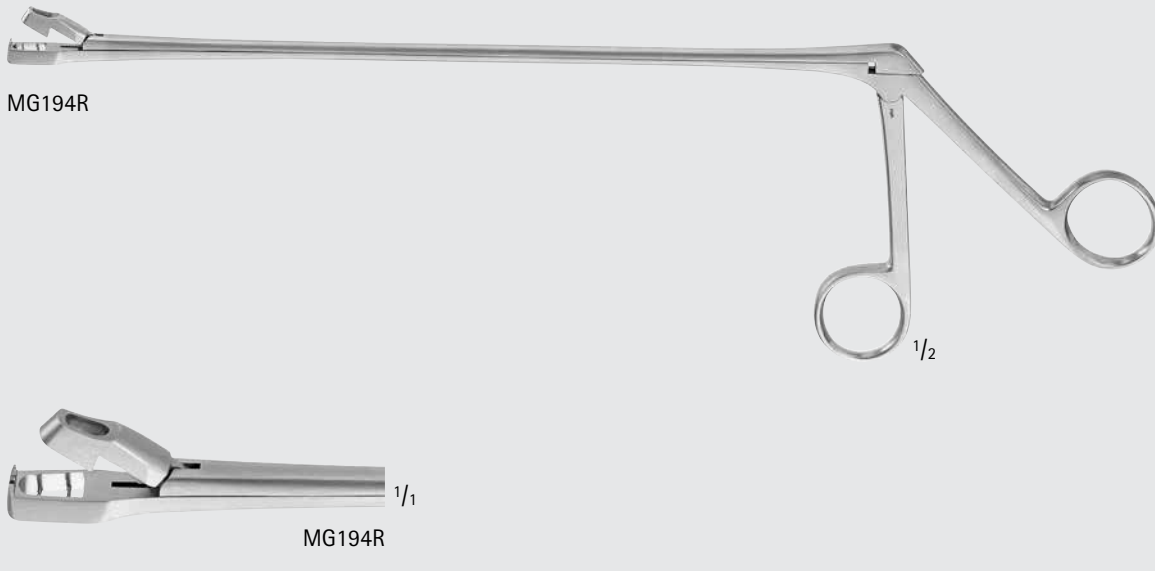

### EPPENDORF Biopsy Forceps

Catalog Number	Jaw Size (mm)	Working Length (in.)
ER070R	8 x 4	8

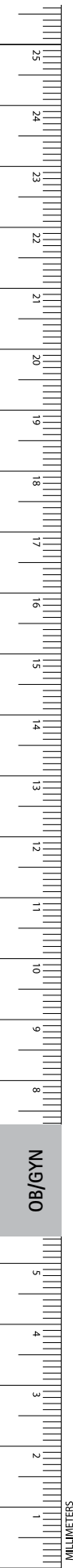
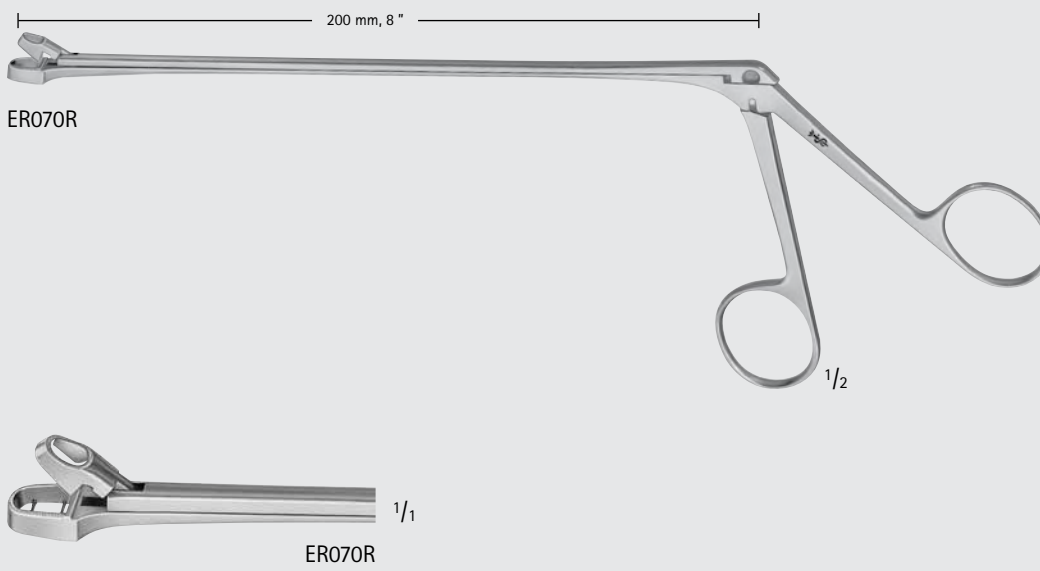

**PHANEUF Hysterectomy Forceps**

Catalog Number	Jaw	Length (in.)
BJ500R	STR	8 1/4
BJ501R	ANG	8

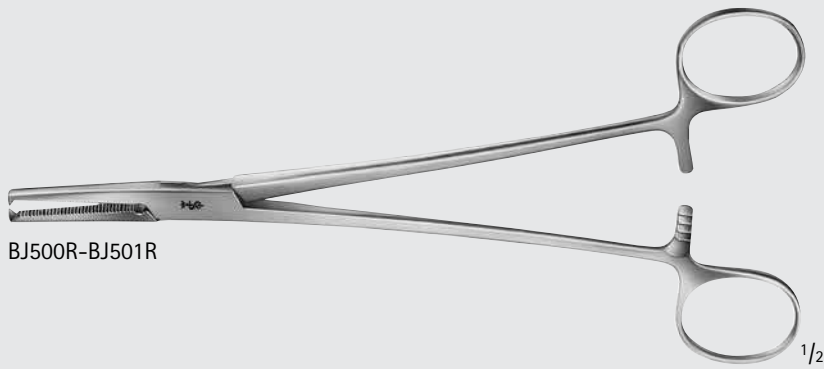

BJ500R-BJ501R



**HOLZBACH Hysterectomy Forceps**

Catalog Number	Jaw	Length (in.)
BJ510R	STR	9 5/8
BJ511R	CVD	9 5/8

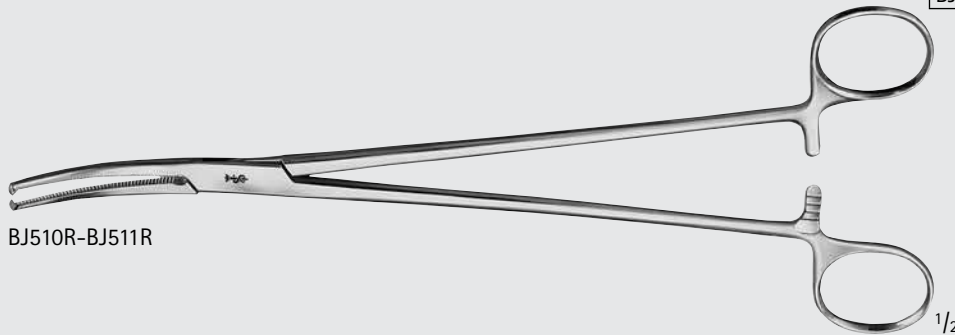

BJ510R-BJ511R



**HEANEY-REZEK Hysterectomy Forceps**

Catalog Number	Jaw	Length (in.)
BJ524R	STR	8 1/4

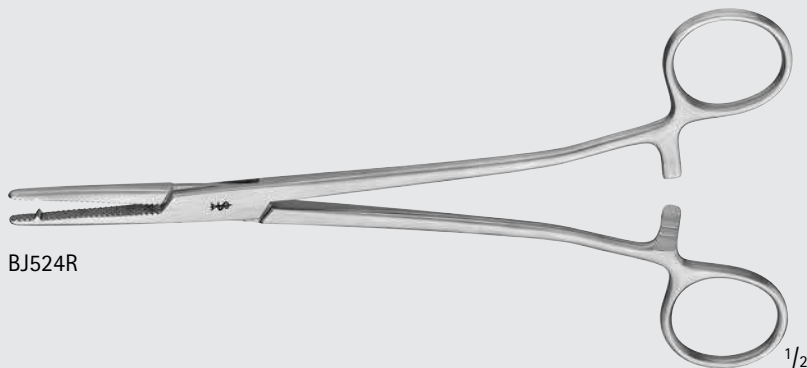

BJ524R

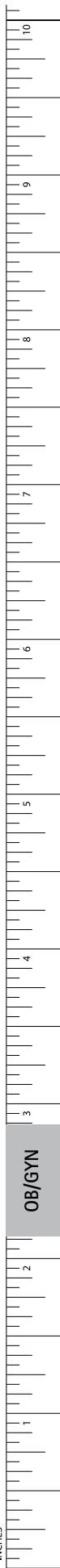

OB/GYN

INCHES

# Obstetrics/Gynecology

## Clamps

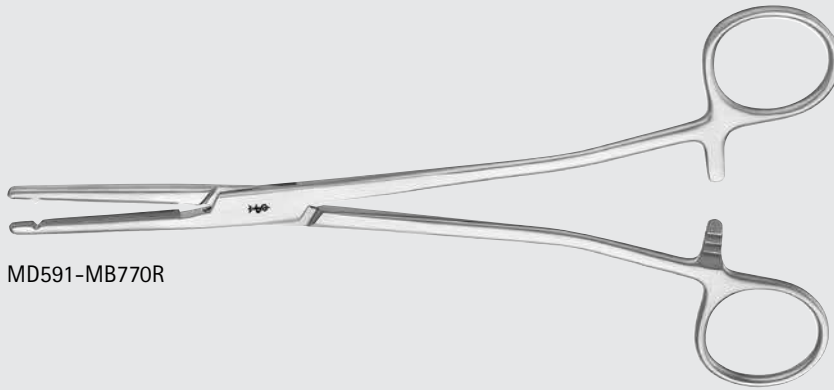

MD591-MB770R

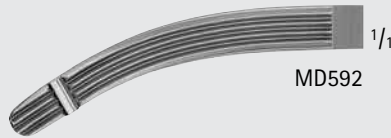

### HEANEY-BALLENTINE Hysterectomy Forceps, Longitudinal Grooves

Catalog Number	Jaw	Length (in.)
MD591	STR	8 1/2
MB757R	STR	10 1/2
MB754R	STR	12
MB771R	STR	14
MD592	CVD	8 1/2
MB749R	CVD	10 1/2
MB753R	CVD	12
MB770R	CVD	14

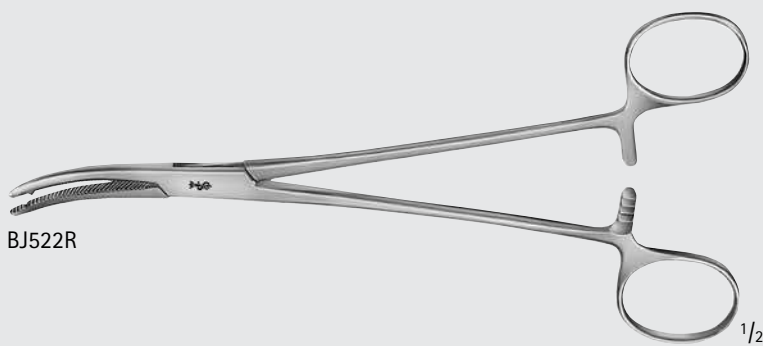

BJ522R

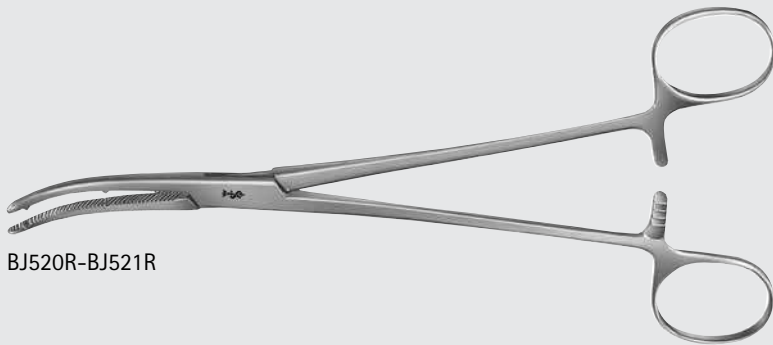
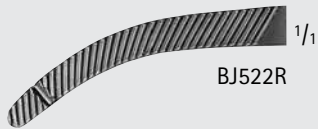

BJ520R-BJ521R

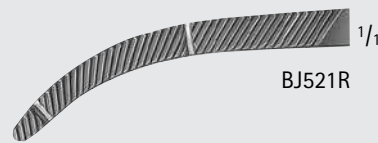
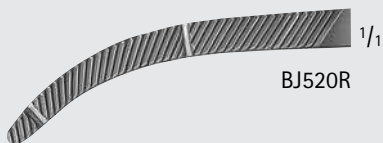

### HEANEY Hysterectomy Forceps

Catalog Number	Jaw	Teeth	Length (in.)
BJ522R	CVD	1	7 3/4
BJ520R	CVD	2	8
BJ521R	CVD	2	9 3/4

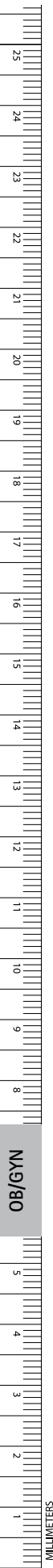

OB/GYN

**HEANEY Hysterectomy Forceps (continued)**

Catalog Number	Jaw	Teeth	Length (in.)
MB906R	STR	2	12
MB907R	CVD	2	12

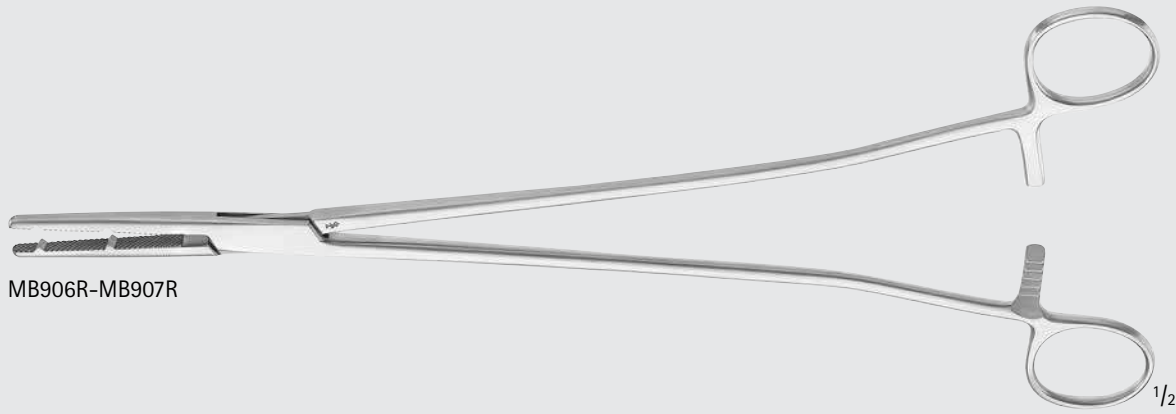

MB906R-MB907R



MB906R



MB907R

**HEANEY Hysterectomy Forceps, Heavy**

Catalog Number	Jaw	Length (in.)
MB797R	CVD	8 1/4

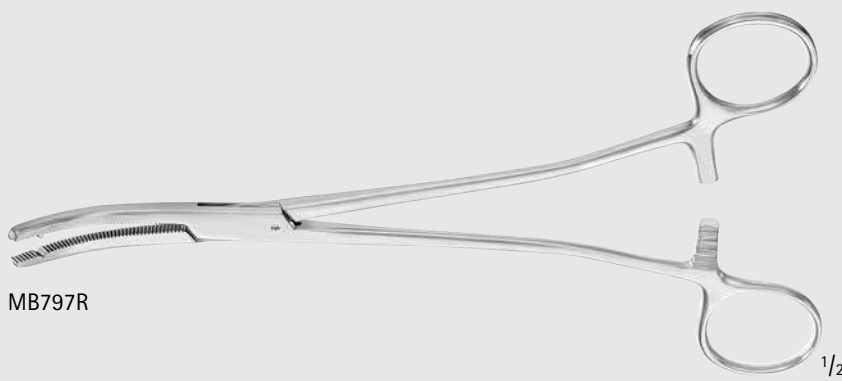

MB797R

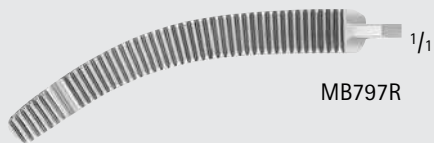

MB797R

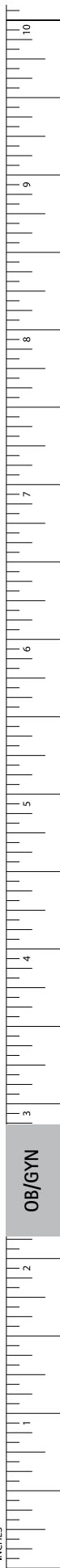

# Obstetrics/Gynecology

## Clamps

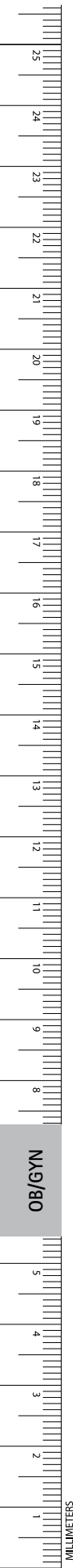
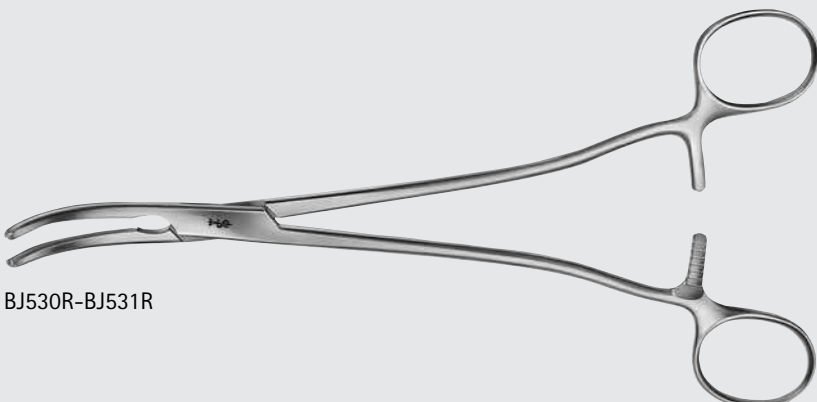
**HEANEY Hysterectomy Forceps, W/O Teeth**

Catalog Number	Jaw	Length (in.)
BJ530R	STR	8 7/8
BJ532R	CVD	8 1/2
BJ531R	CVD	8 3/4

BJ530R-BJ531R



BJ530R 1/1

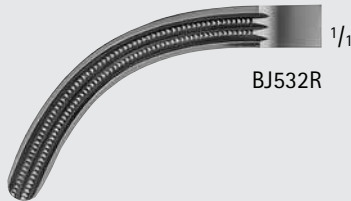

BJ532R 1/1



BJ531R 1/1

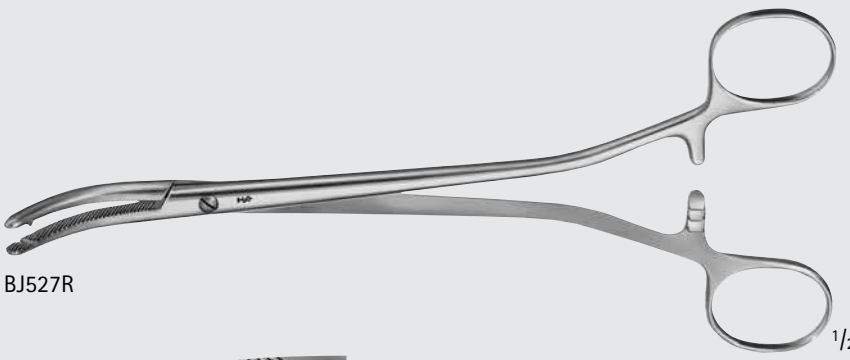

**WIENER Hysterectomy Forceps, W/ Grooves**

Catalog Number	Tip	Jaw	Length (in.)
BJ527R	SMOOTH	CVD	9 1/2

BJ527R

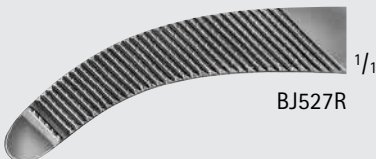

BJ527R 1/1

1/2

**WERTHEIM Atraumatic Parametrium Clamp**

Catalog Number	Jaw	Length (in.)
BJ550R	STR	9 3/4
BJ551R	SLT-CVD	9 5/8
BJ552R	CVD	9 1/2
BJ553R	UP-CVD	8 3/4

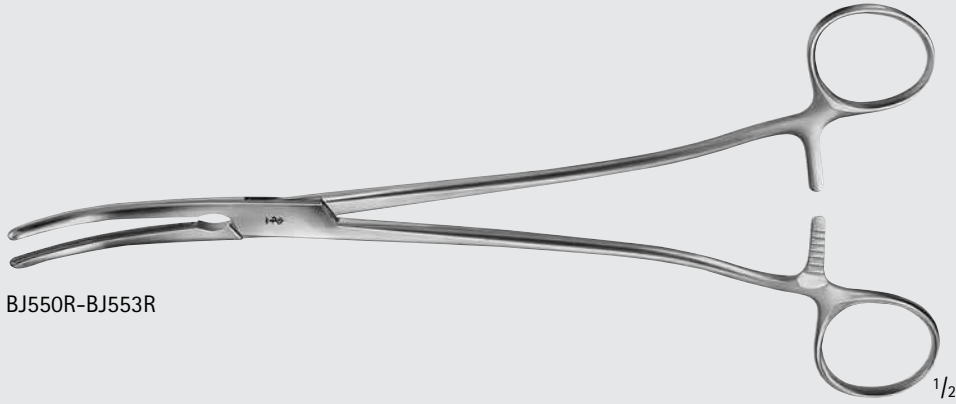

BJ550R-BJ553R



BJ550R

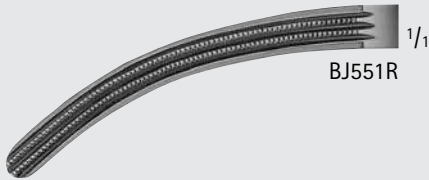

BJ551R



BJ552R

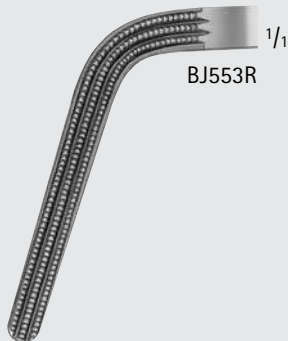

BJ553R

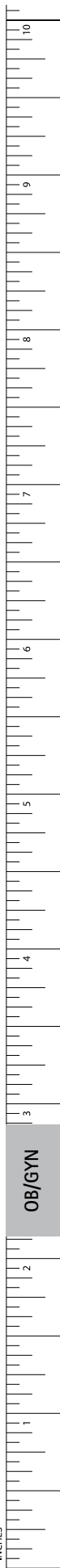

# Obstetrics/Gynecology

## Clamps

### WERTHEIM Parametrium Clamp

Catalog Number	Jaw	Length (in.)
BJ576R	CVD	10 1/4

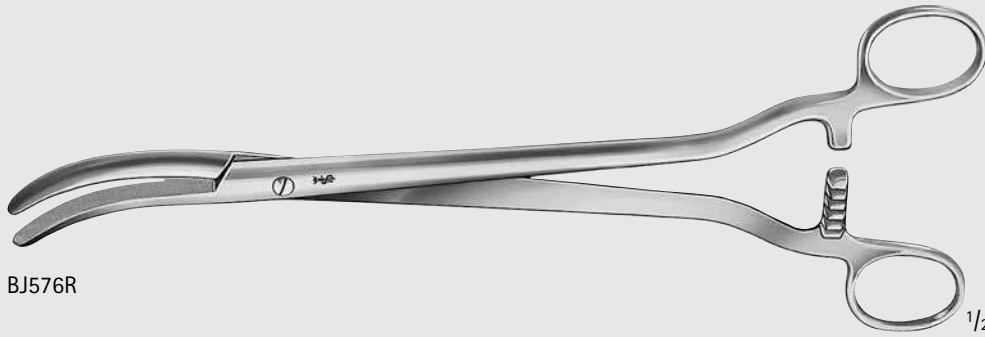

BJ576R

1/2

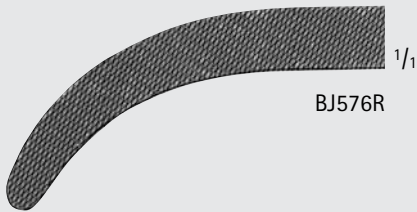

BJ576R

1/1

### WERTHEIM Hysterectomy Forceps

Catalog Number	Jaw	Length (in.)
BJ574R	CVD	10

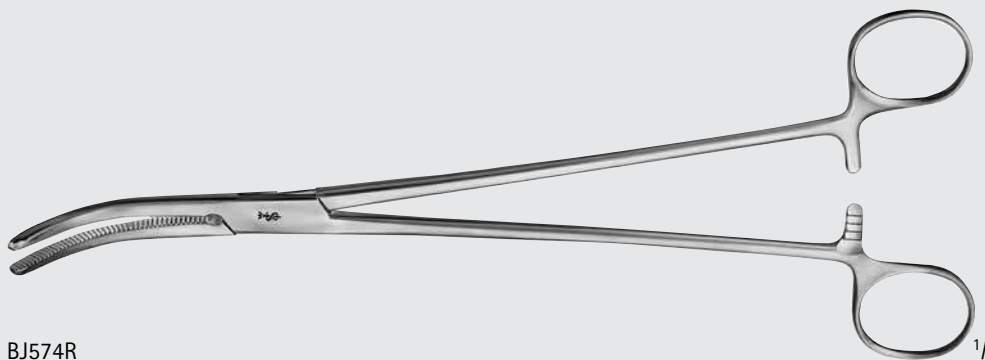

BJ574R

1/2



BJ574R

1/1

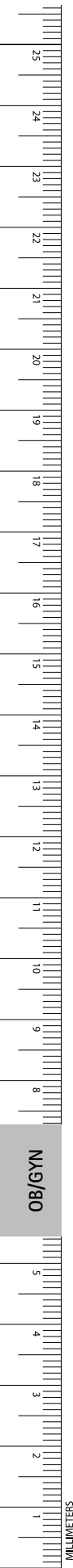



WERTHEIM-CULLEN Clamp

Catalog Number	Jaw	Length (in.)
BJ579R	RIGHT-ANG	8 1/2

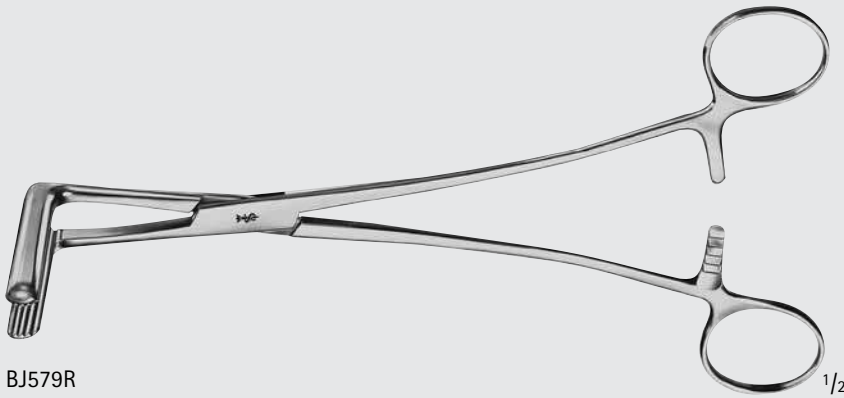

BJ579R

1/2



BJ579R

1/1

WERTHEIM Atraumatic Clamp

Catalog Number	Jaw	Length (in.)
BJ581R	RIGHT-ANG	9 3/4

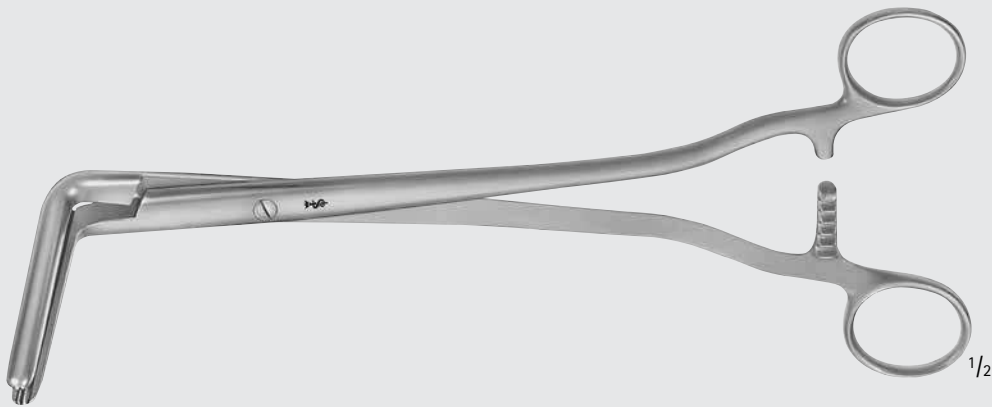

BJ581R

1/2

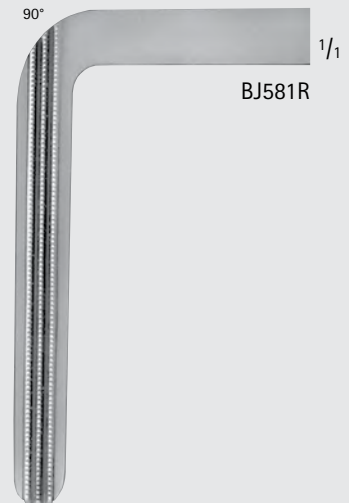

BJ581R

1/1



# Obstetrics/Gynecology

## Clamps

### GLASSMAN Anterior Resection Clamp

Catalog Number	Jaw	Jaw Length (mm)	Length (in.)
MB931R	90°, SERR	25	9 3/4
MB130R	90°, SERR	50	9 3/4
MB932R	90°, SERR	75	10

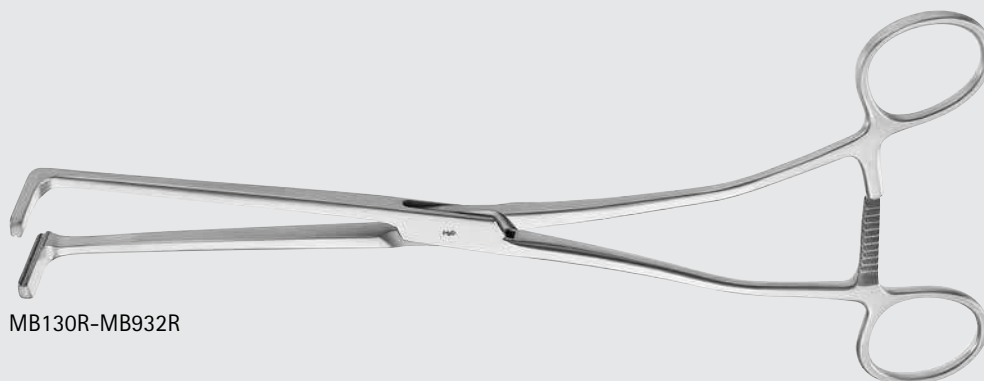

MB130R-MB932R

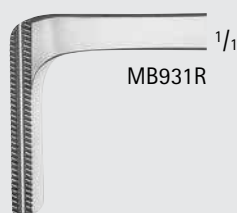

MB931R

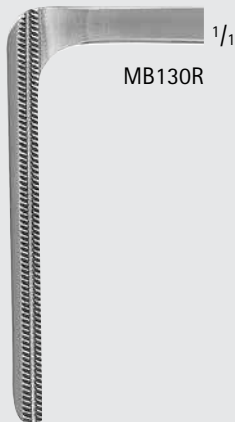

MB130R

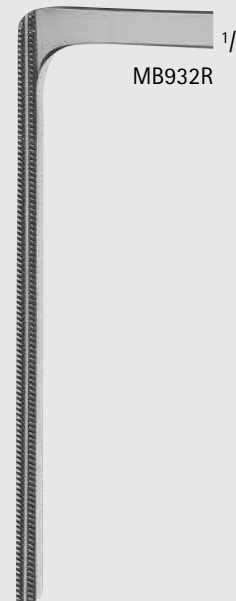

MB932R

### MASTERSON Uterine Clamp

Catalog Number	Jaw	Length (in.)
MG198R	STR	8 1/2
MG199R	CVD	8 1/2

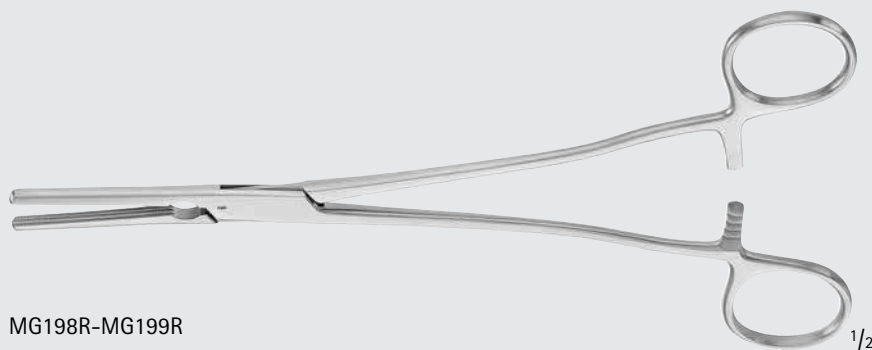

MG198R-MG199R



MG198R



MG199R

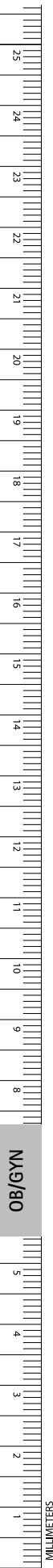

Z-Type Hysterectomy Clamp

Catalog Number	Jaw	Handle	Length (in.)
MG203R	STR	STR	8 1/2
MG204R	SLIGHT-CVD	STR	8 1/2
MG205R	CVD	STR	8 1/2
MG206R	ANG	STR	8 1/2
MB352R	STR	STR	9 1/2
MB353R	SLIGHT-CVD	STR	9 1/2
MB354R	CVD	STR	9 1/2
MB355R	ANG	STR	9 1/2
MB786R	STR	ANG	9 1/2
MB787R	SLIGHT-CVD	ANG	9 1/2
MB788R	CVD	ANG	9 1/2
MB789R	ANG	ANG	9 1/2
MB187R	STR	STR	12
MB188R	SLIGHT-CVD	STR	12
MB183R	CVD	STR	12
MB184R	ANG	STR	12
MB790R	STR	ANG	12
MB792R	SLIGHT-CVD	ANG	12
MB793R	CVD	ANG	12
MB794R	ANG	ANG	12



MG203R-MB206R, MB352R-MB355R, MB183R-MB188R

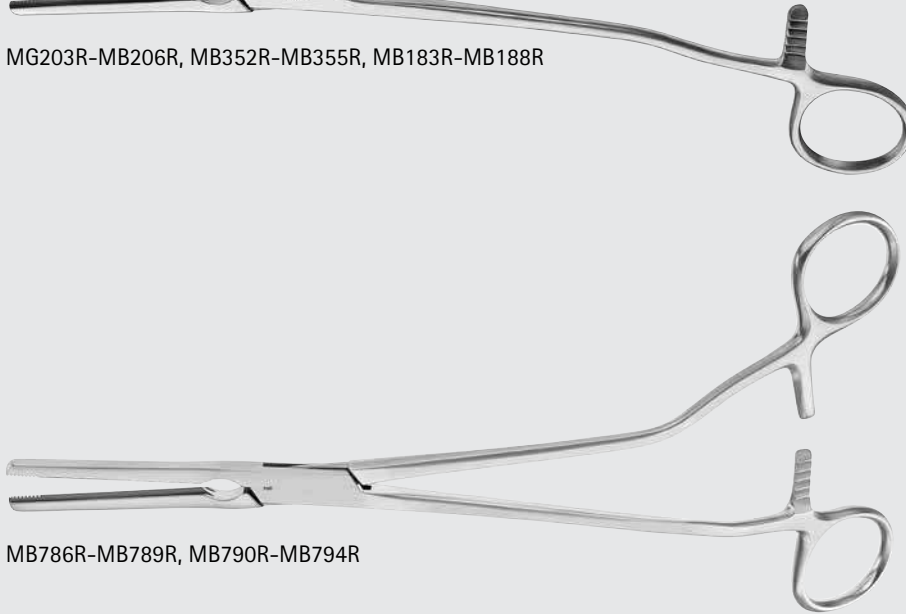

MB786R-MB789R, MB790R-MB794R



MG203R, MB352R, MB786R, MB187R, MB790R

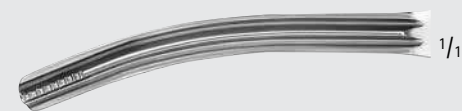

MG204R, MB353R, MB787R, MB188R, MB792R



MG205R, MB354R, MB788R, MB183R, MB793R



MG206R, MB355R, MB789R, MB184R, MB794R

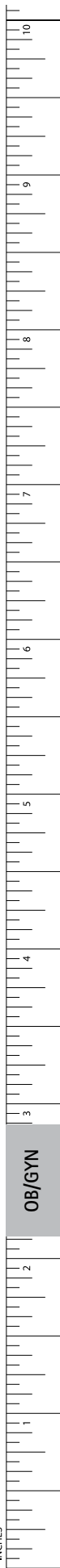

# Obstetrics/Gynecology

## Clamps

### Z-Type Hysterectomy Clamp (continued)

Catalog Number	Jaw	Handle	Length (in.)
MB185R	STR	STR	14
MB186R	SLT-CVD	STR	14
MB987R	CVD	STR	14
MB988R	ANG	STR	14

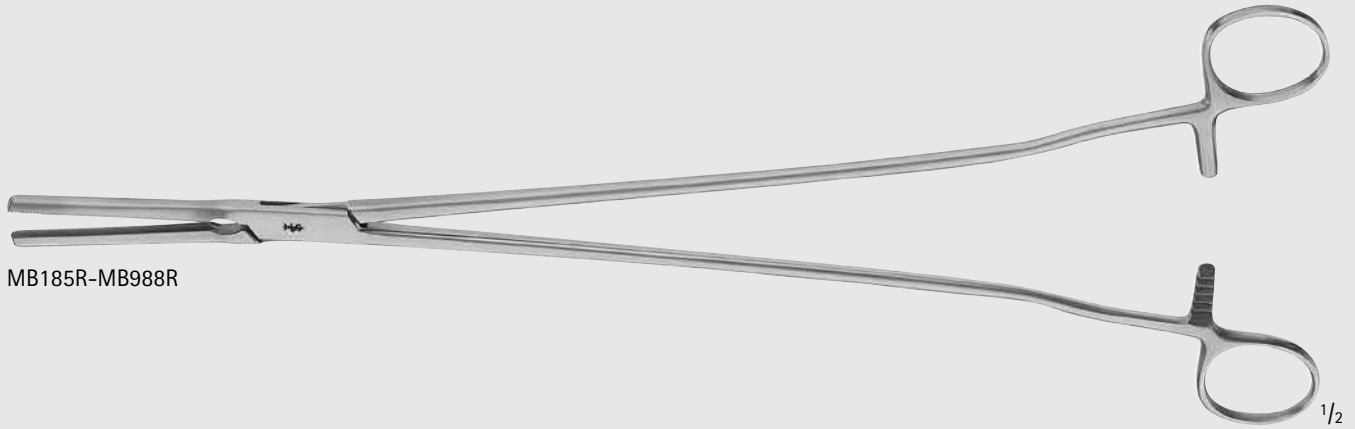

MB185R



MB186R



MB987R

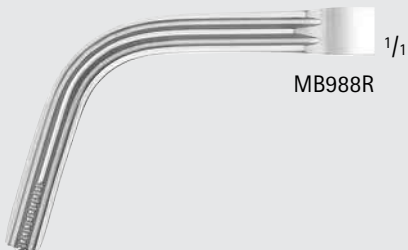

MB988R

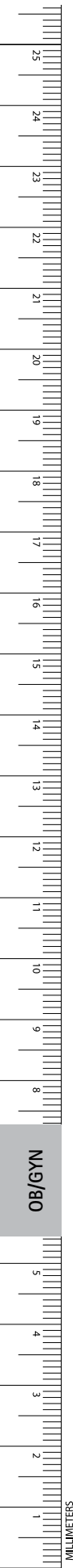

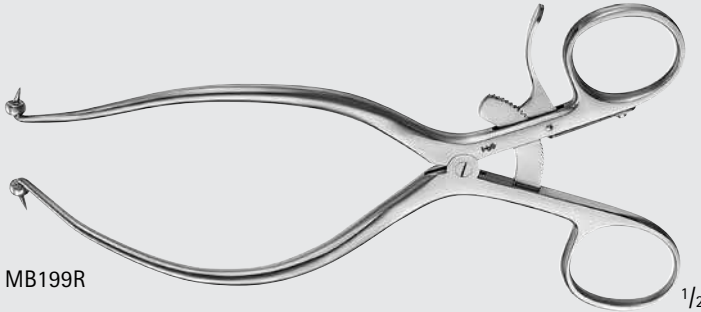

MB199R 1/2



MB199R 1/1

Catalog Number	Length (in.)
MB199R	7

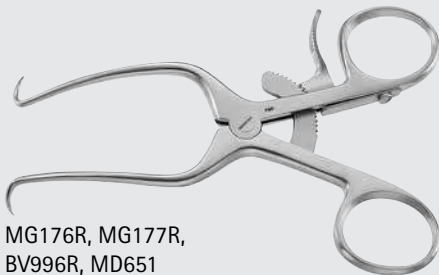

MG176R, MG177R,  
BV996R, MD651

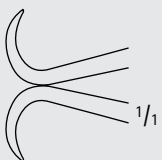

MG176R 1/1

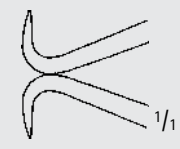

BV996R 1/1

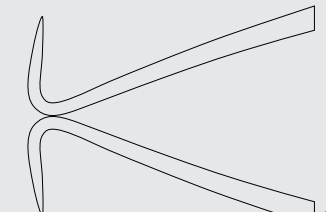

MD651 1/1



MG177R 1/1

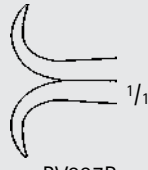

BV997R 1/1



BV997R 1/2

Catalog Number	Tip	Length (in.)
MG176R	SHARP	3 1/2
BV996R	SHARP	5 1/4
BV997R	SHARP	6 7/8
MD651	SHARP	7 1/4
MG177R	BLUNT	4 1/2



MB267R

Catalog Number	Length (in.)
MB267R	7 1/2



# Obstetrics/Gynecology

## Retractors

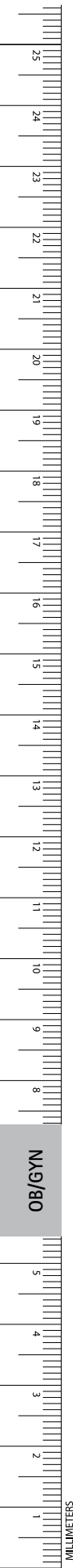

MB068R

### DELEE Universal Retractor

Catalog Number	Length (in.)
MB068R	9 1/2



US100-US100202

### O' SULLIVAN-O' CONNOR Retractor

Catalog Number	Description	Blade Size (mm)
US100	COMPLETE	185 x 143
US100201	SMALL BLADE	80 x 149
US100202	LARGE BLADE	155 x 110

US100 Includes:

- 1 Retractor US100200
- 2 Blades US100201 and
- 1 Blade US100202



US100201



US100202



**COLLIN Vaginal Specula**

Catalog Number	Blade Size (mm)
ELO11R	95/85 x 18

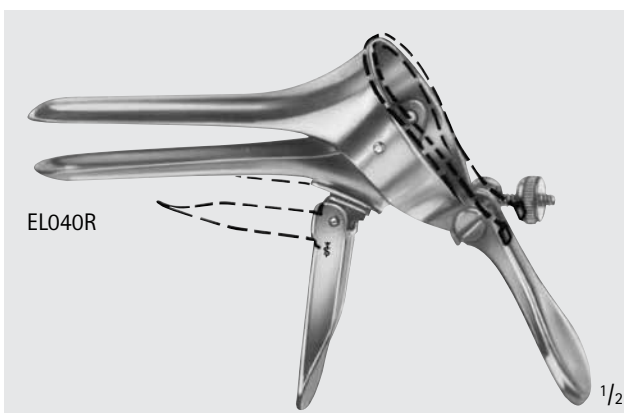

**CUSCO Vaginal Specula**

Catalog Number	Blade Size (mm)
ELO40R	75 x 17

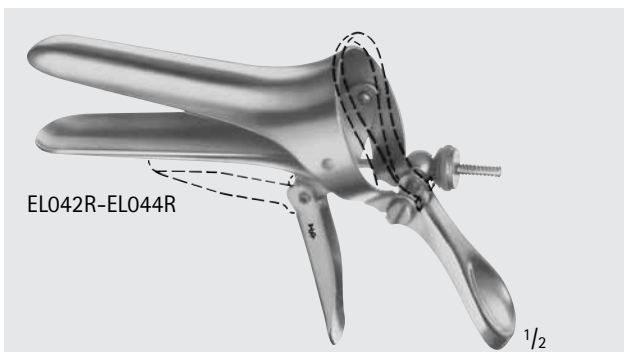

**CUSCO Vaginal Specula**

Catalog Number	Blade Size (mm)
ELO42R	80 x 32
ELO43R	90 x 36
ELO44R	110 x 37

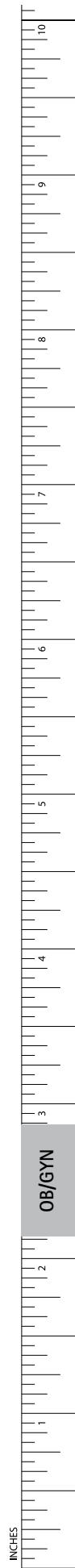

INCHES

OB/GYN

# Obstetrics/Gynecology

## Vaginal Retractors and Specula

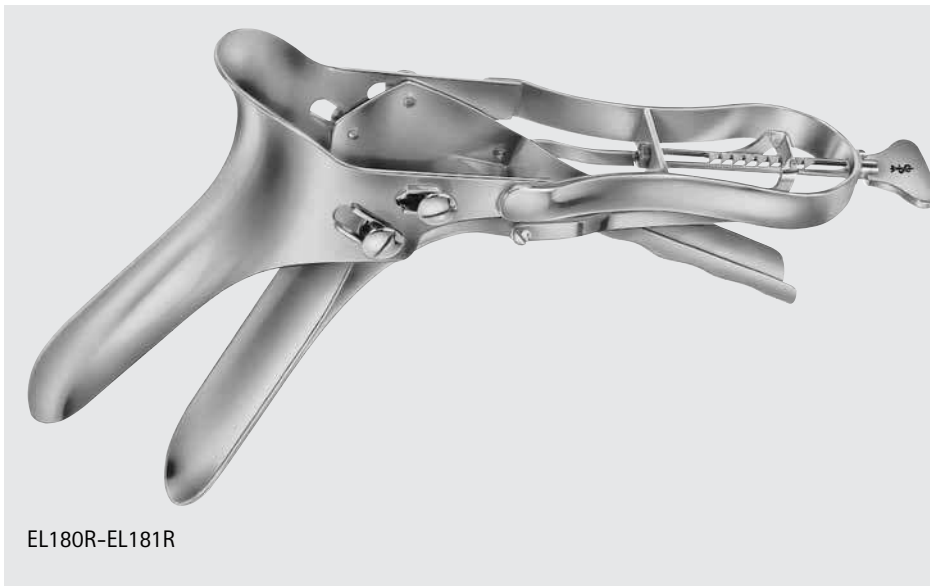
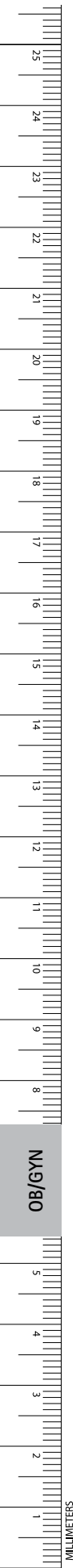

**SEYFFERT Vaginal Specula**

Catalog Number	Blade Size (mm)	Length (in.)
EL180R	100 x 17	9
EL181R	110 x 33	9

1/2

EL180R-EL181R

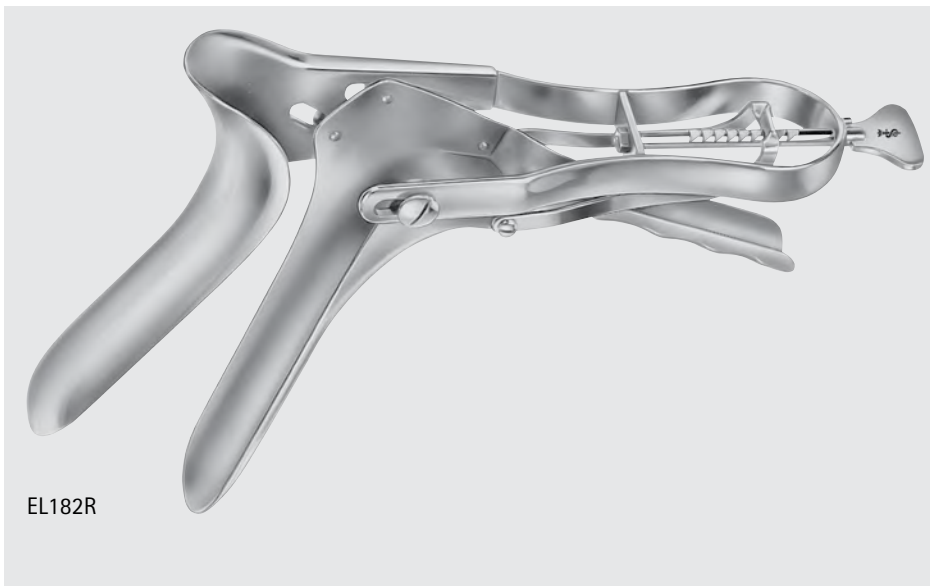

**SEYFFERT Speculum, 1 Side Open**

Catalog Number	Blade Size (mm)	Length (in.)
EL182R	110 x 33	9

1/2

EL182R



**SEMM Vaginal Specula, 45° Angle**

Catalog Number	Blade Size (mm)	Length (in.)
EL183R	90 x 14	7

1/2

EL183R





MB066R-EL193R

**PEDERSON Vaginal Speculum**

Catalog Number	Blade Size (mm)
MB066R	75 x 12.7
EL192R	100 x 22
MG156R	115 x 16
EL193R	120 x 25

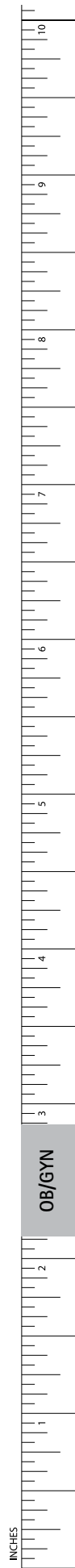

# Obstetrics/Gynecology

## Vaginal Retractors and Specula



MB067R

**PEDERSON Vaginal Speculum, Large, Insulated Coating, W/ Evacuation Vent**

Catalog Number	Blade Size (mm)
MB067R	120 x 25



EL194R-MG159R

**GRAVES Vaginal Speculum**

Catalog Number	Blade Size (mm)
EL194R	75 x 20
EL195R	95 x 30
EL196R	105 x 33
MG159R	125 x 40
MB841R	102 x 34 W/ SIDE OPENING

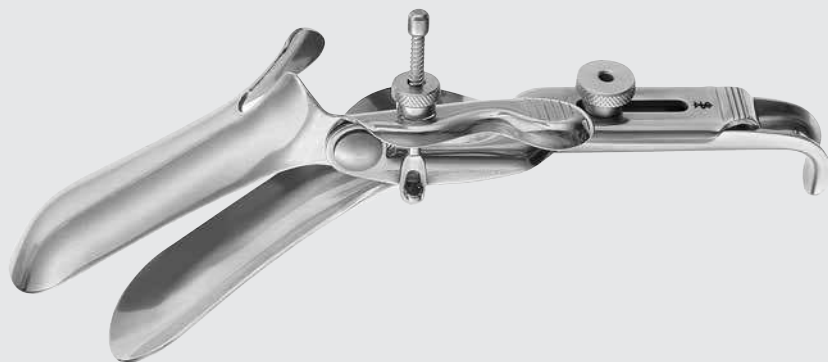

MB841R

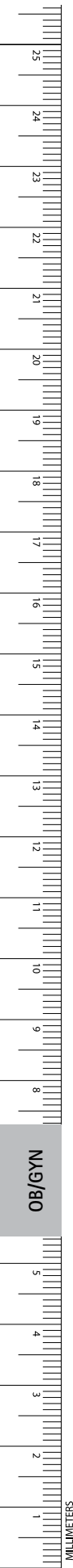

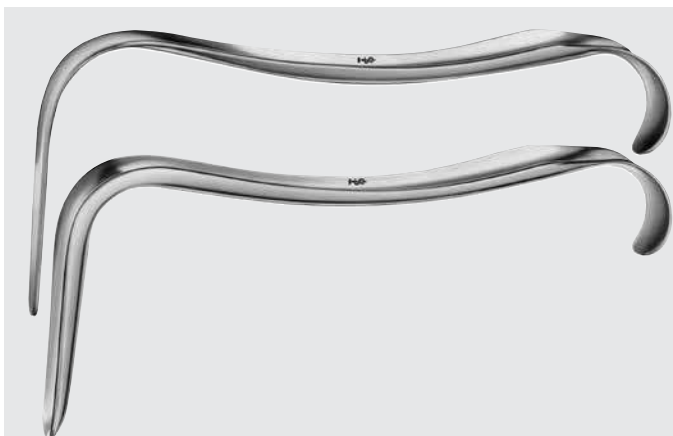

EL420R-EL428R

**KRISTELLER Vaginal Speculum, Set of 2 each**

Catalog Number	Blade Size (mm)	Length (in.)
EL420R	70 x 15	6 3/4
EL421R	70 x 27	6 7/8
EL422R	75 x 30	6 7/8
EL423R	90 x 36	6 7/8
EL426R	110 x 20	8 3/4
EL425R	110 x 27	8 3/4
EL427R	110 x 30	8 3/4
EL428R	110 x 36	8 3/4

Each blade size comes as a set of 2 - with one upper and one lower blade

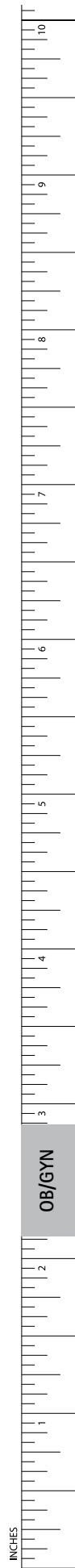

# Obstetrics/Gynecology

## Vaginal Retractors and Specula



EL450R-EL458R

### KRISTELLER Vaginal Specula Upper Blades

Catalog Number	Blade Size (mm)	Length (in.)
EL450R	75 x 10	6 7/8
EL451R	75 x 23	7
EL452R	80 x 25	7
EL453R	100 x 32	7 1/4
EL454R	115 x 14	8 1/2
EL455R	115 x 23	8 1/2
EL457R	115 x 26	8 3/4
EL458R	120 x 30	8 7/8



EL450R



EL451R



EL452R



EL453R



EL454R



EL455R



EL457R



EL458R



OB/GYN

**KRISTELLER Vaginal Specula Lower Blades**

Catalog Number	Blade Size (mm)	Length (in.)
EL440R	70 x 15	6 7/8
EL441R	70 x 27	7
EL442R	75 x 30	7
EL443R	90 x 36	7 1/4
EL444R	110 x 18	8 1/2
EL445R	110 x 27	8 1/2
EL446R	110 x 20	8 3/4
EL447R	110 x 30	8 3/4
EL448R	110 x 36	8 7/8



EL440R-EL448R



EL440R



EL441R



EL442R



EL443R



EL444R



EL445R



EL446R

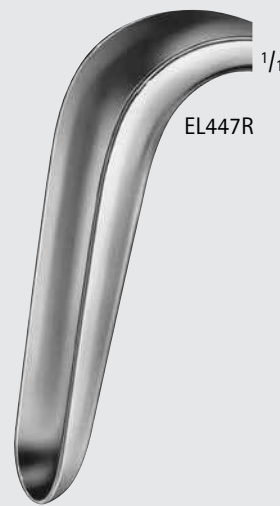

EL447R



EL448R



# Obstetrics/Gynecology

## Vaginal Retractors and Specula

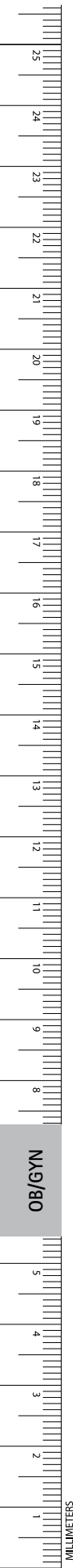

**KALLMORGEN Vaginal Specula Set of 2**

Catalog Number	Blade Size (mm)	Length (in.)
EL480R	75 x 39	6 3/4



**KALLMORGEN Vaginal Specula Set of 2**

Catalog Number	Blade Size (mm)	Length (in.)
EL481R	95 x 39	7 7/8



**SIMS Vaginal Retractor**

Catalog Number	Blade Size (mm)
MB759R	70 x 25
MB760R	76 x 32
MB761R	89 x 38

MB759R-MB761R



**SIMS Vaginal Speculum, Double Ended**

Catalog Number	Blade Size (mm)	Length (in.)
MG158R	69 x 25 / 70 x 30	5
EL407R	70 x 26 / 75 x 30	5
EL408R	75 x 30 / 80 x 35	6
EL409R	80 x 36 / 90 x 40	6 7/8

MG158R-EL409R

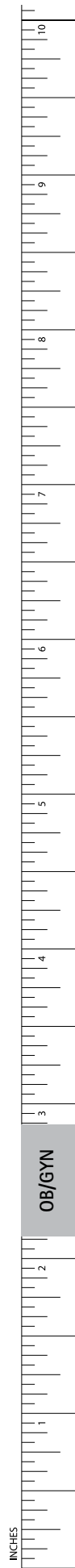

# Obstetrics/Gynecology

## Vaginal Retractors and Specula

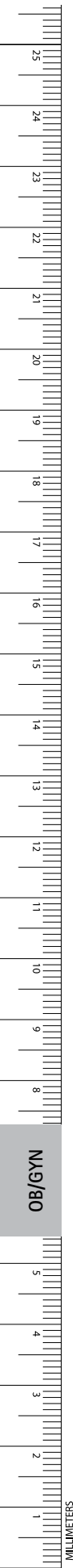

EL578R-EL579R

### JACKSON Vaginal Speculum Lower Blade

Catalog Number	Blade	Blade Size (mm)	Length (in.)
EL578R	SLIGHT-CONCAVE	89 x 38	6 7/8
EL579R	SLIGHT-CONCAVE	102 x 38	6 7/8



EL578R



EL579R



EL581R, MB764R-MB765R

### EASTMAN Vaginal Retractor

Catalog Number	Blade Size (mm)	Length (in.)
MB764R	75 x 40	6 7/8
EL581R	89 x 38	6 7/8
MB765R	100 x 40	6 7/8





EL865R



MB762R-MB763R

**HEANEY Retractor**

Catalog Number	Blade Size (mm)	Length (in.)
MB762R	45 x 25	6 3/4
MB763R	73 x 29	6 3/4
EL865R	83 x 29	6 3/4

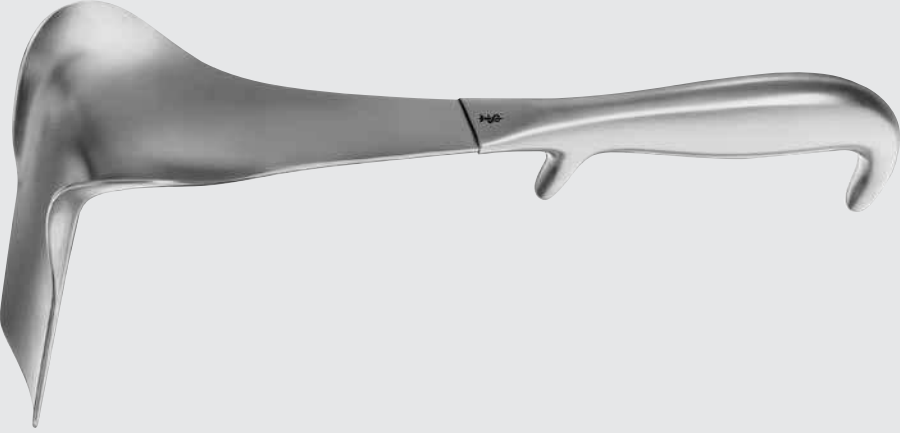

EL627R-EL629R



EL627R



EL628R



EL629R

**DOYEN Vaginal Speculum**

Catalog Number	Blade Size (mm)	Length (in.)
EL627R	60 x 45	9 1/4
EL628R	90 x 45	9 1/4
EL629R	112 x 45	9 1/4





# Obstetrics/Gynecology

## Vaginal Retractors and Specula

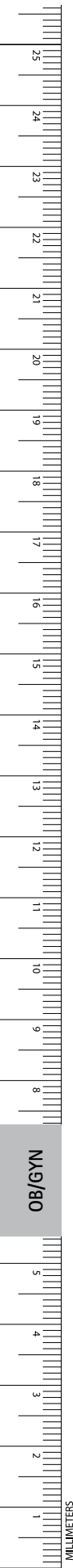

### DOYEN Vaginal Speculum

Catalog Number	Blade Size (mm)	Length (in.)
EL631R	60 x 35	9 1/2
EL632R	90 x 35	9 1/2
EL633R	120 x 35	9 1/2
EL634R	60 x 45	9 1/2
EL635R	90 x 45	9 1/2
EL636R	120 x 45	9 1/2
EL637R	60 x 60	9 1/2
EL638R	90 x 60	9 1/2
EL639R	120 x 60	9 1/2
EL642R	160 x 45	9 1/2
EL644R	160 x 60	9 1/2

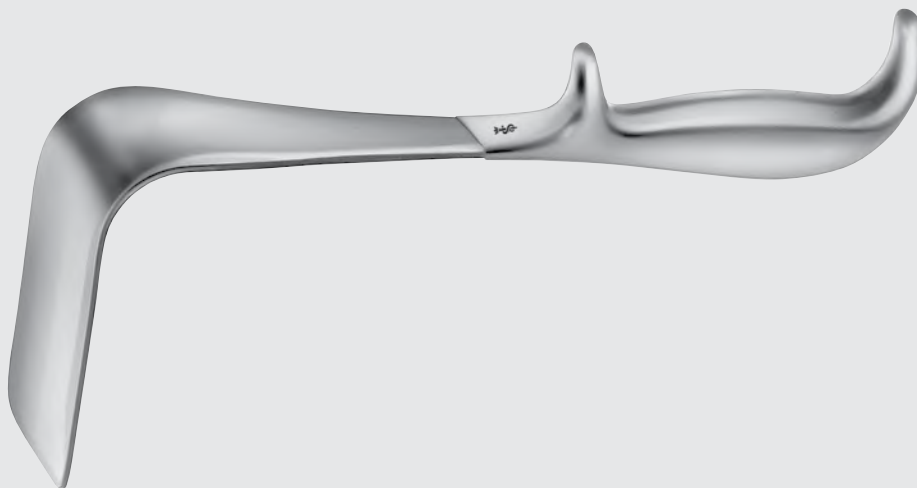

EL631R-EL644R

### BREISKY Vaginal Speculum

Catalog Number	Blade Size (mm)	Length (in.)
EL703R	100 x 20	11 3/4
EL704R	100 x 25	11 3/4
EL705R	100 x 30	11 3/4
EL707R	100 x 35	11 3/4
EL708R	100 x 40	11 3/4
EL693R	130 x 20	12 1/2
EL694R	130 x 25	12 1/2
EL695R	130 x 30	12 1/2
EL697R	130 x 35	12 1/2
EL698R	130 x 40	12 1/2
EL700R	160 x 40	13 3/4
EL702R	180 x 40	13 3/4



EL700R-EL708R, EL693R-EL698R



AUVARD Speculum, W/ Detachable Weight

Catalog Number	Blade Size (mm)	Length (in.)
EL736R	65 x 38-28	9

Weight:  
Speculum, only: 0.3 lbs.  
Weight, only: 1.7 lbs.

EL736R

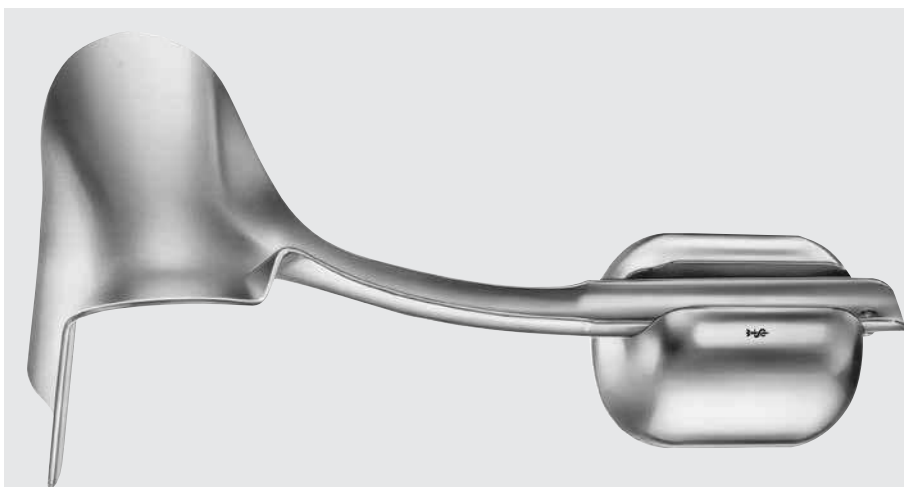

AUVARD Speculum, W/ Detachable Weight

Catalog Number	Blade Size (mm)	Length (in.)
EL738R	75 x 42-40	9
EL739R	105 x 43-40	9

EL738R-EL739R

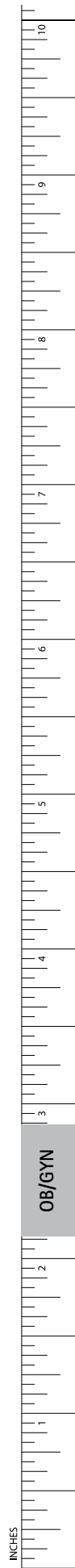

# Obstetrics/Gynecology

## Vaginal Retractors and Specula

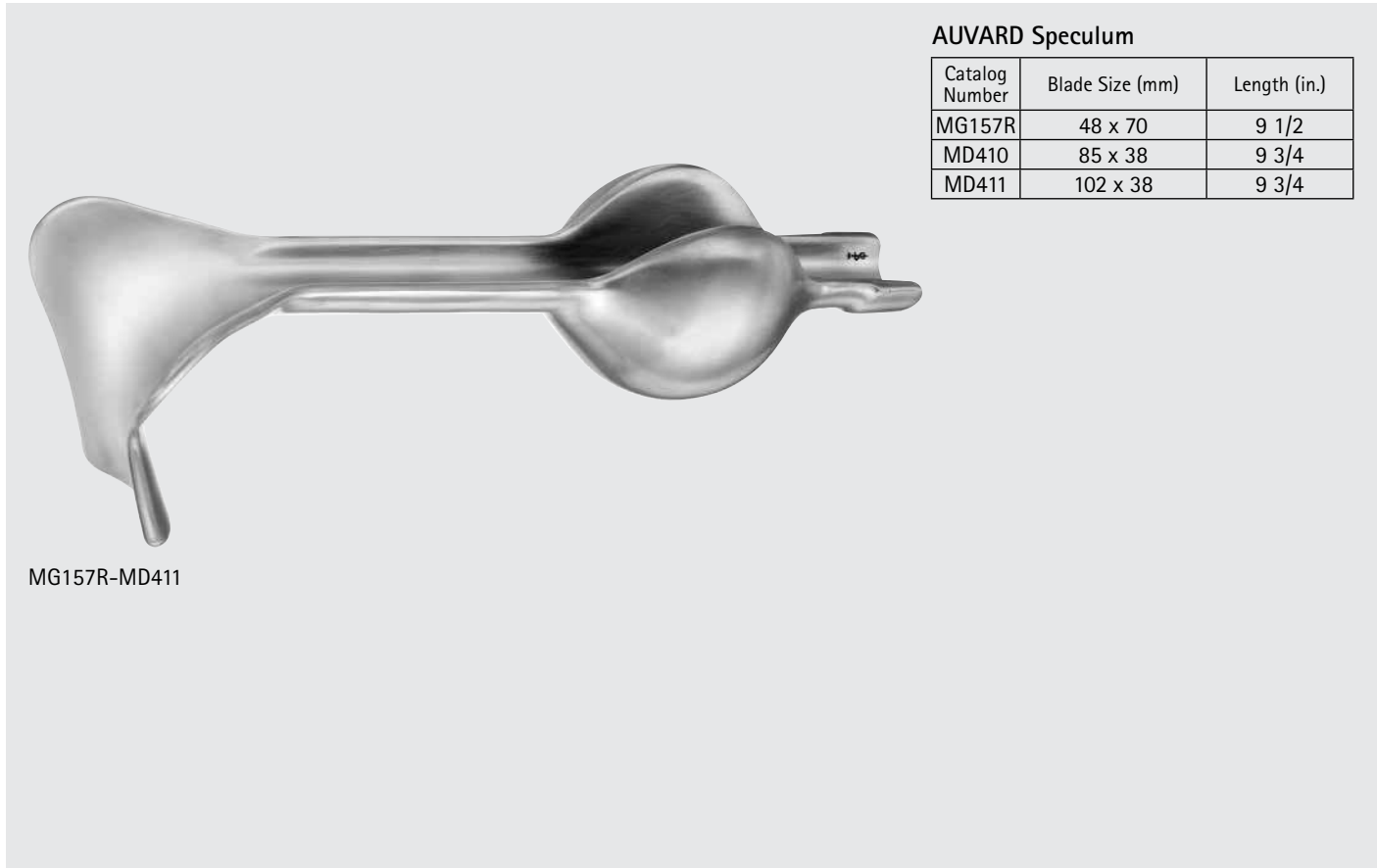
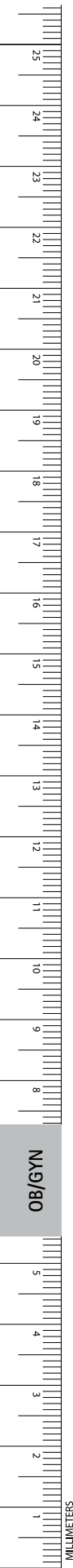

MG157R-MD411

### AUVARD Speculum

Catalog Number	Blade Size (mm)	Length (in.)
MG157R	48 x 70	9 1/2
MD410	85 x 38	9 3/4
MD411	102 x 38	9 3/4

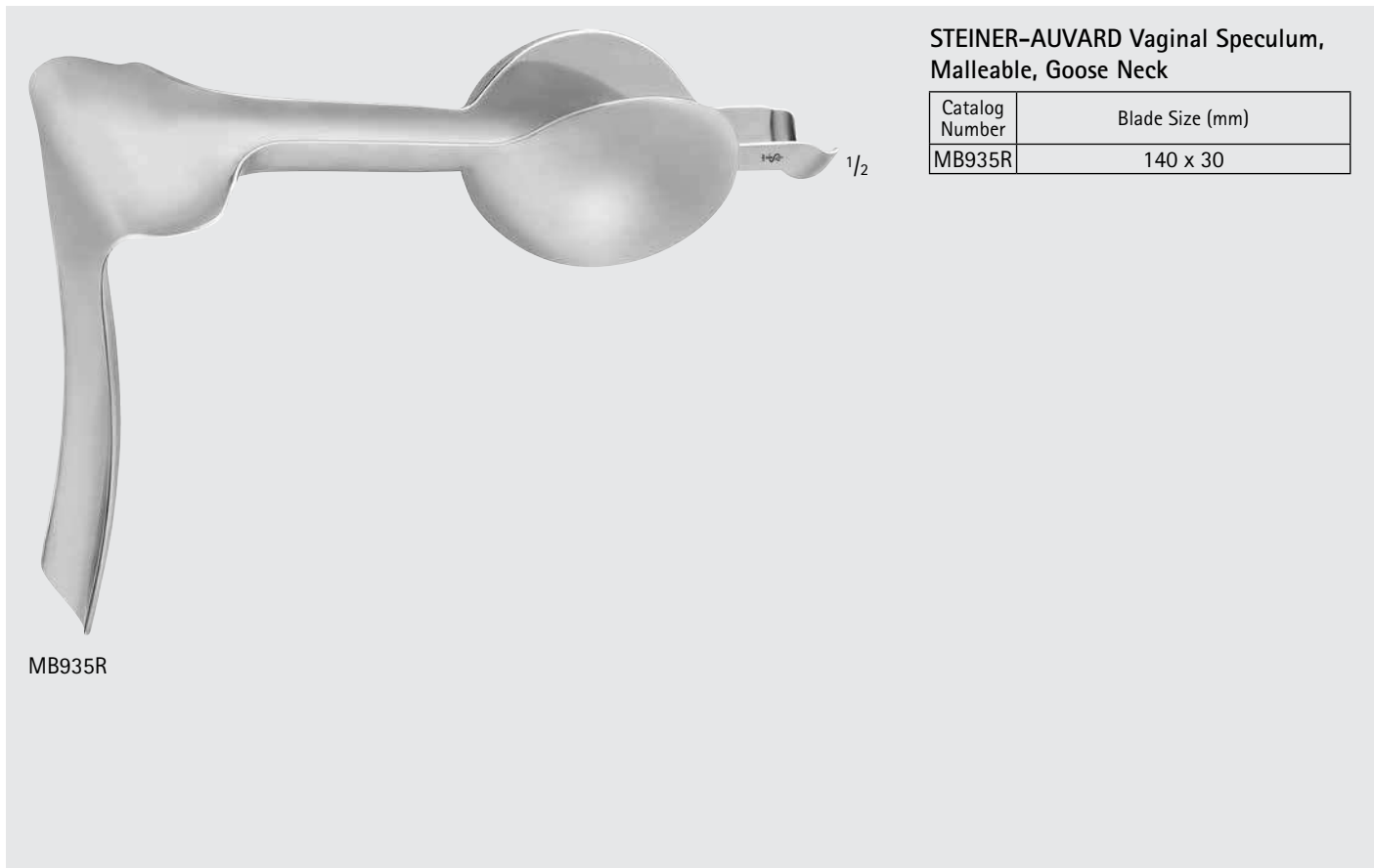

MB935R

### STEINER-AUVARD Vaginal Speculum, Malleable, Goose Neck

Catalog Number	Blade Size (mm)
MB935R	140 x 30



**DOYEN Lateral Speculum**

Catalog Number	Blade Size (mm)	Length (in.)
EL859R	60 x 30	9
EL860R	80 x 30	9 3/4

EL859R-EL860R

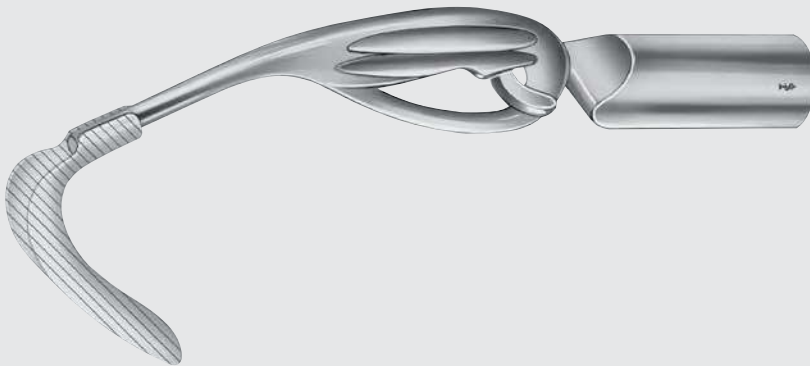

**SCHERBACK Vaginal Speculum Set**

Catalog Number	Description	Blade Size (mm)
EL740R	SET COMPLETE	-
EL741R	BLADE	80 x 30
EL742R	BLADE	85 x 35
EL743R	BLADE	85 x 40
EL744R	BLADE	55 x 40
EL745R	BLADE	70 x 45
EL746R	HANDLE	-
EL747R	WEIGHT	-

EL740R-EL747R

EL740R Includes:  
1 Handle EL746R  
1 Weight EL747R  
4 Blades of each  
EL741R-EL744R

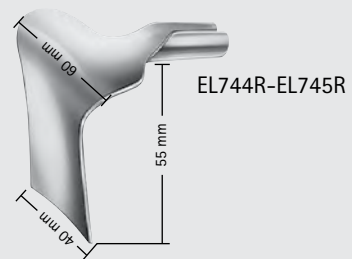

# Obstetrics/Gynecology

## Vaginal Retractors and Specula

**TUEBINGER Vaginal Retractor**

Catalog Number	Blade Size (mm)	Length (in.)
EL868R	95 x 20	10 1/2

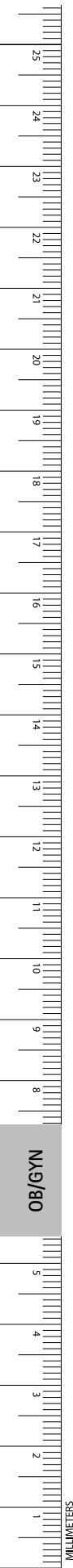
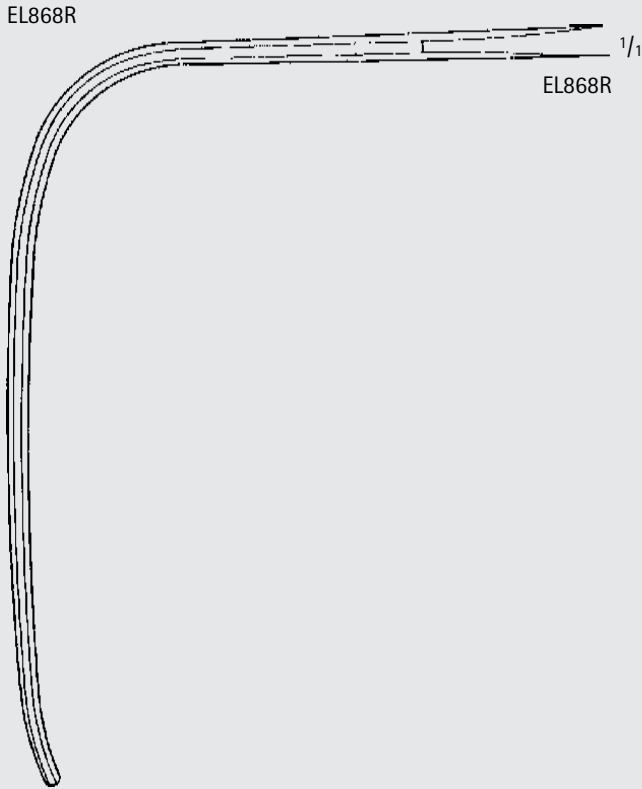
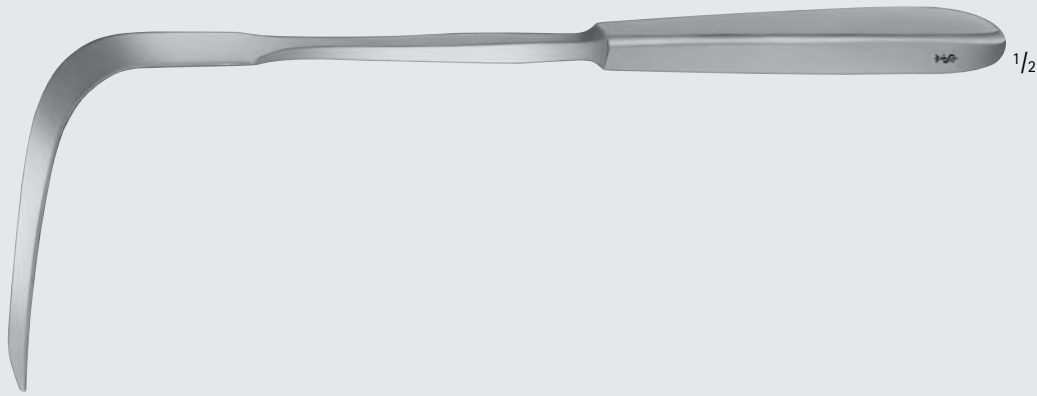

**GLENNER Retractor**

Catalog Number	Blade Size (mm)	Length (in.)
MG175R	135 x 25	10 5/8



MG175R

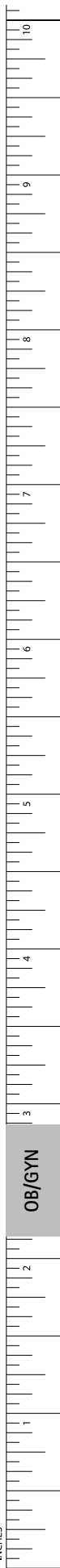

# Obstetrics/Gynecology

## Vaginal Retractors and Specula

MARTIN Vaginal Retractor

Catalog Number	Blade Size (mm)	Length (in.)
EL870R	105 x 27	9 3/4

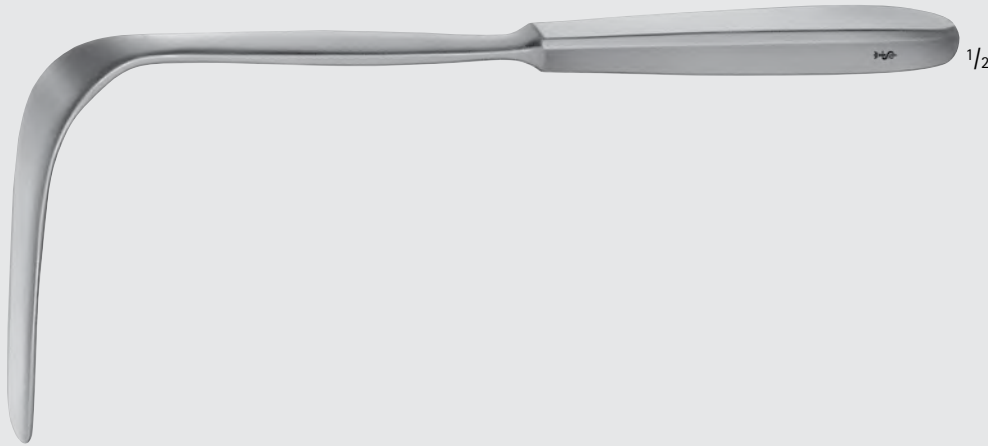

EL870R

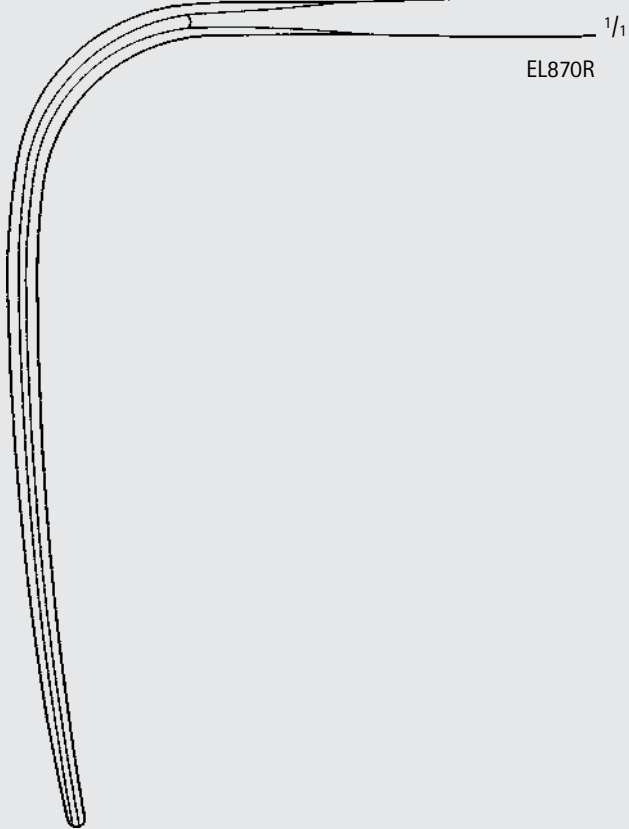

EL870R

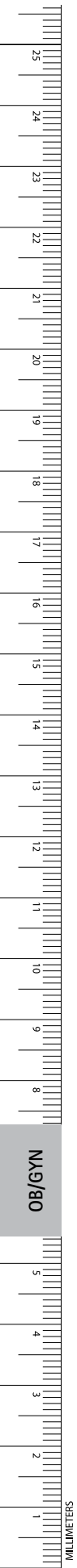



SIMON Vaginal Retractor

Catalog Number	Blade Size (mm)	Length (in.)
EL872R	115 x 22	10 3/4
EL873R	115 x 27	10 3/4

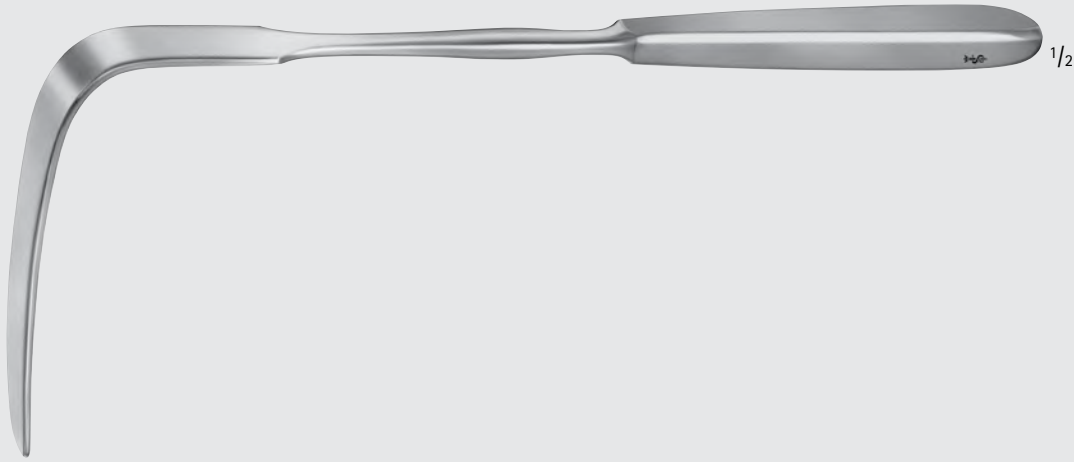

EL872R-EL872R

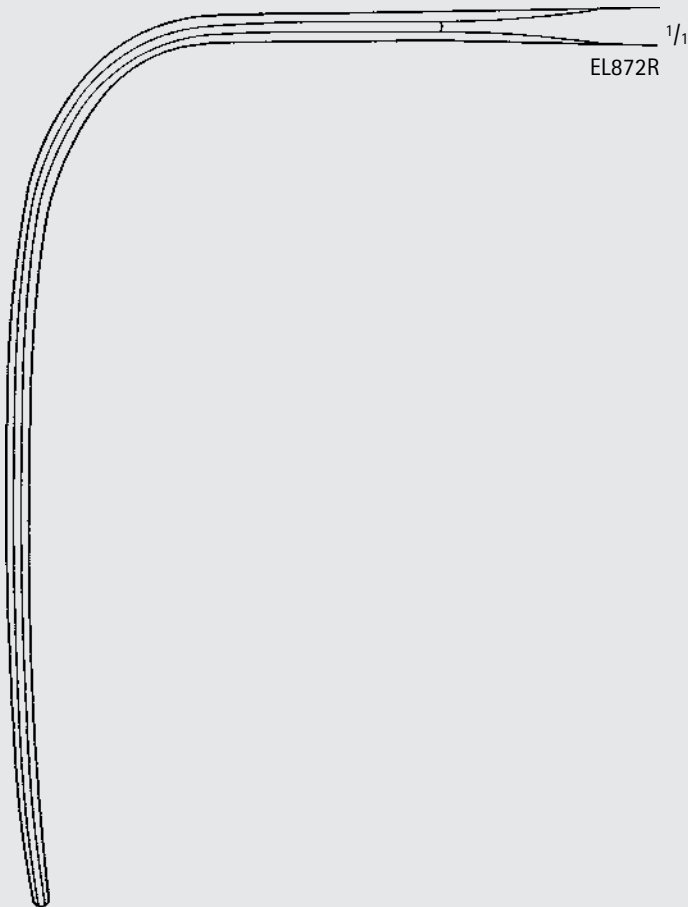

EL872R

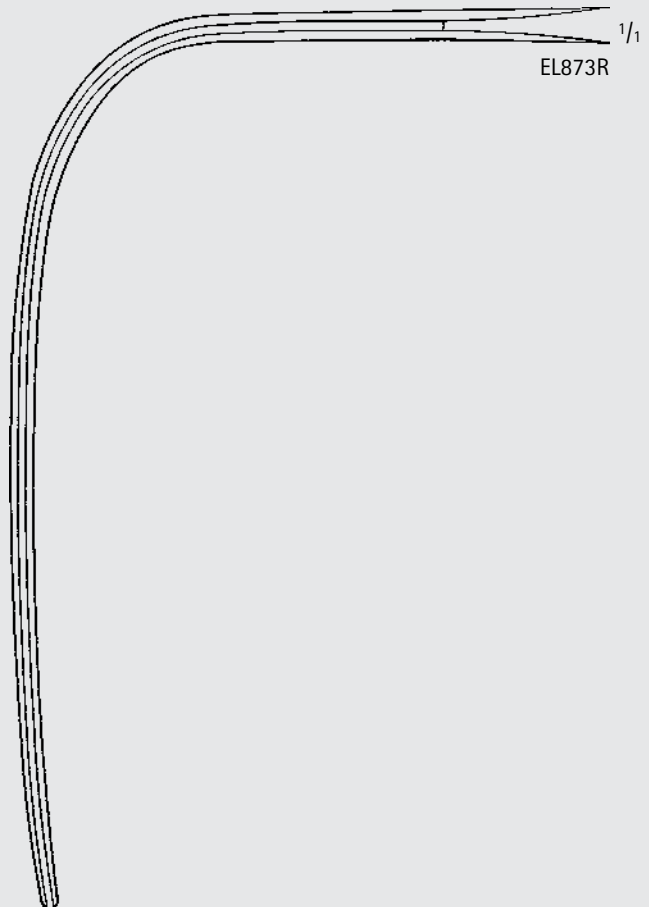

EL873R

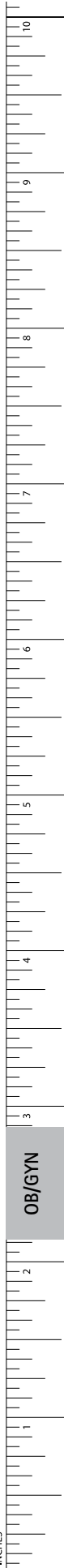

INCHES

OB/GYN

# Obstetrics/Gynecology

## Endospecula

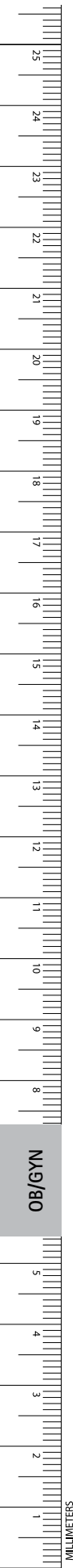

### KOGAN Endospeculum

Catalog Number	Length (in.)
EM710R	9 1/2

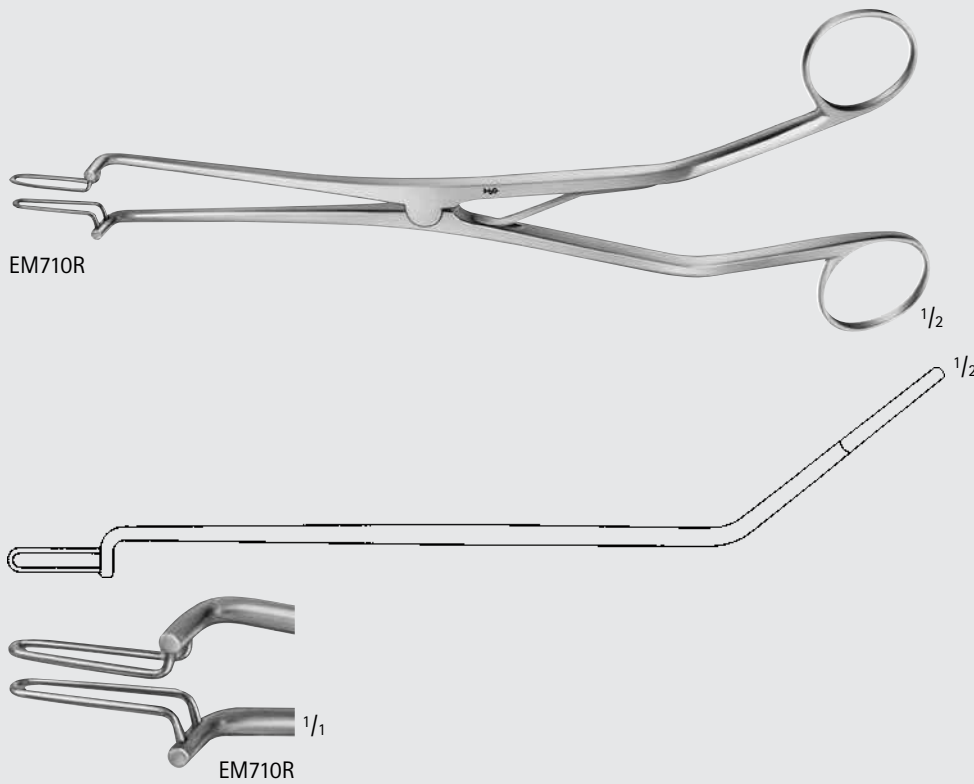

### KOGAN Cervix/Urethra Endospeculum, W/ Scale, Ratcheted

Catalog Number	Length (in.)
EM711R	9 1/2

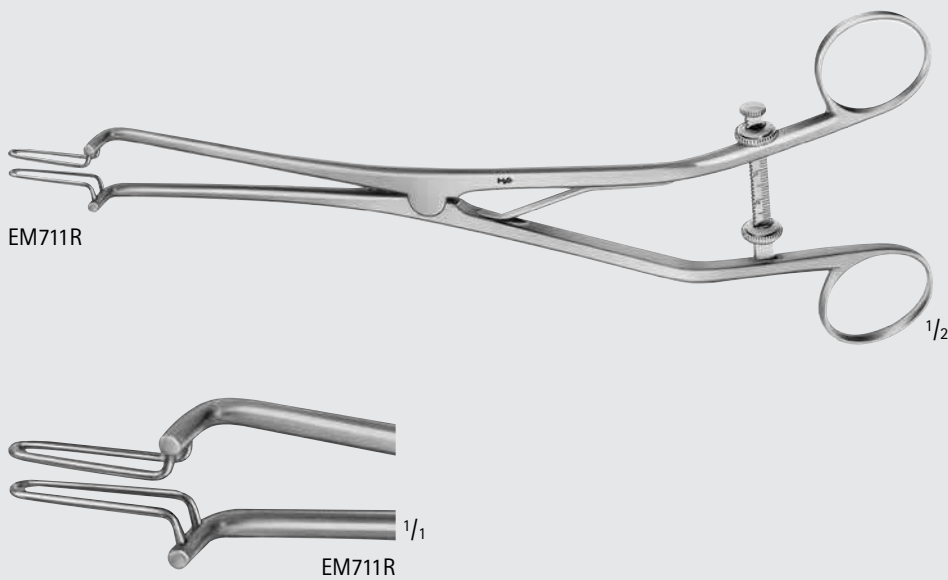



EM101R-EM147R

**HEGAR Dilator, Single Ended**

Catalog Number	Tip Size (mm)	Length (in.)
EM101R	1	7 1/4
EM102R	2	7 1/4
EM103R	3	7 1/4
EM104R	4	7 1/4
EM105R	5	7 1/4
EM106R	6	7 1/4
EM107R	7	7 1/4
EM108R	8	7 1/4
EM109R	9	7 1/4
EM110R	10	7 1/4
EM111R	11	7 1/4
EM112R	12	7 1/4
EM113R	13	7 1/4
EM114R	14	7 1/4
EM115R	15	7 1/4
EM116R	16	7 1/4
EM117R	17	7 1/4
EM118R	18	7 1/4
EM119R	19	7 1/4
EM120R	20	7 1/4
EM121R	21	7 1/4
EM122R	22	7 1/4
EM123R	23	7 1/4
EM124R	24	7 1/4
EM125R	25	7 1/4
EM126R	26	7 1/4
EM131R	1.5	7 1/4
EM132R	2.5	7 1/4
EM133R	3.5	7 1/4
EM134R	4.5	7 1/4
EM135R	5.5	7 1/4
EM136R	6.5	7 1/4
EM137R	7.5	7 1/4
EM138R	8.5	7 1/4
EM139R	9.5	7 1/4
EM140R	10.5	7 1/4
EM141R	11.5	7 1/4
EM142R	12.5	7 1/4
EM143R	13.5	7 1/4
EM144R	14.5	7 1/4
EM145R	15.5	7 1/4
EM146R	16.5	7 1/4
EM147R	17.5	7 1/4



# Obstetrics/Gynecology

## Dilators and Probes



EM193R-EM194R

### HEGAR Dilator Set, Single Ended

Catalog Number	Item
EM193R	SET W/ 14 DILATORS, 4-17 mm
EM194R	SET W/ 26 DILATORS, 1-26 mm

**EM193R Includes:**

EM097R Rack for Dilators 4-12 mm

EM098R Rack for Dilators 13-17 mm

JG161R Metal Case: 200 x 100 x 35 mm

**Includes Dilators:**

EM104R-EM117R

**EM194R Includes:**

EM099R Rack for Dilators 1-17 mm

EM100R Rack for Dilators 18-26 mm

JG170R Metal Case: 330 x 220 x 80 mm

**Includes Dilators:**

EM101R-EM126R



EM231R-EM244R

### HEGAR Uterine Dilator, Double Ended

Catalog Number	Tip Size (mm)	Length (in.)
EM244R	SET OF 8	-
EM231R	1/2	7 3/4
EM232R	3/4	7 3/4
EM233R	5/6	7 3/4
EM234R	7/8	7 3/4
EM235R	9/10	7 3/4
EM236R	11/12	7 3/4
EM237R	13/14	7 3/4
EM238R	15/16	7 3/4
EM239R	17/18	7 3/4

**Set Includes:**

EM232R-EM239R



OB/GYN

**HEGAR Uterine Dilator, Slight Curved, Double Ended**

Catalog Number	Tip Size (mm)	Length (in.)
MG270R	SET OF 8	-
MG251R	1/2	8
MG252R	3/4	8
MG253R	5/6	8
MG254R	7/8	8
MG255R	9/10	8
MG256R	11/12	8
MG257R	13/14	8
MG258R	15/16	8
MG259R	17/18	8

MG270R Set of 8 includes MG252R-MG259R



MG270R-MG259R

**PRATT Uterine Dilator**

Catalog Number	Tip Size (FR)	Length (in.)
EM270R	COMPLETE SET	-
EM271R	13/15	11 1/2
EM272R	17/19	11 1/2
EM273R	21/23	11 1/2
EM274R	25/27	11 1/2
EM275R	29/31	11 1/2
EM276R	33/35	11 1/2
EM277R	37/39	11 1/2
EM278R	41/43	11 1/2

EM270R Set of 8 includes EM271R-EM278R



EM270R-EM278R

**HANK Dilator, French Scale**

Catalog Number	Tip Size (FR)	Length (in.)
MD593R	COMPLETE SET	10
MD579R	9/10	10
MD594	11/12	10
MD595	13/14	10
MD596	15/16	10
MD597	17/18	10
MD598	19/20	10

MD593R Set of 6 includes MD579R, MD594-MD598



MD593R-MD598



# Obstetrics/Gynecology

## Dilators and Probes

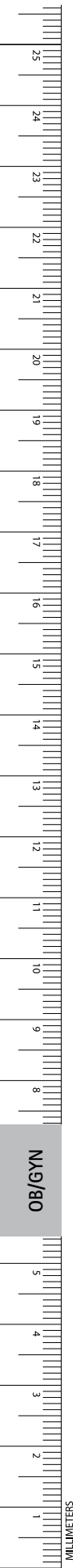

### HANK Dilator, American Scale

Catalog Number	Tip Size (mm)	Length (in.)
MD070R	COMPLETE SET	-
MD064R	9/10	10 3/4
MD065R	11/12	10 3/4
MD066R	13/14	10 3/4
MD067R	15/16	10 3/4
MD068R	17/18	10 3/4
MD069R	19/20	10 3/4

MD070R Set of 6 includes MD064R-MD069R



MD070R-MD069R

### SIMS Uterine Probe, Graduated (cm)

Catalog Number	Tip	Tip Size (mm)	Blade	Length (in.)
EO010R	RGD	4	CVD	13
EO012R	MALL	4	CVD	13

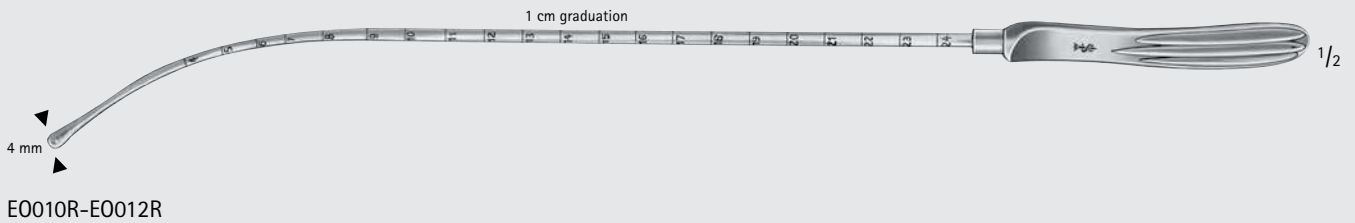

EO010R-EO012R

### MARTIN Uterine Probe, Graduated (cm)

Catalog Number	Blade	Length (in.)
EO015R	CVD	11 3/4

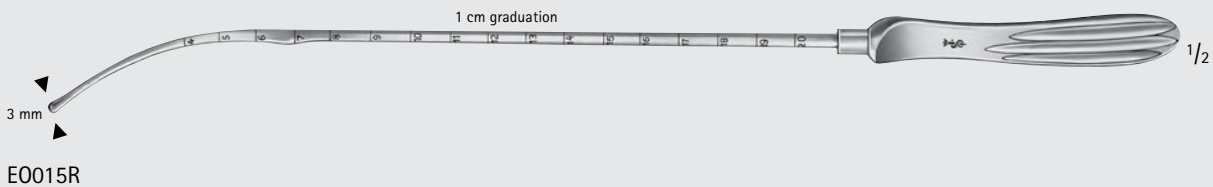

EO015R

OB/GYN

MILLIMETERS

**VALLEIX Uterine Probe,  
Graduated (cm), W/ Slider**

Catalog Number	Tip Size (mm)	Blade	Length (in.)
E0016R	4	CVD	9 3/4

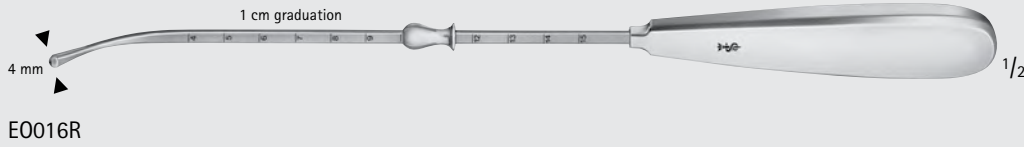

**SIMPSON Uterine Probe,  
Graduated (cm)**

Catalog Number	Tip	Tip Size (mm)	Blade	Length (in.)
E0020	MALL	4	CVD	12 1/4

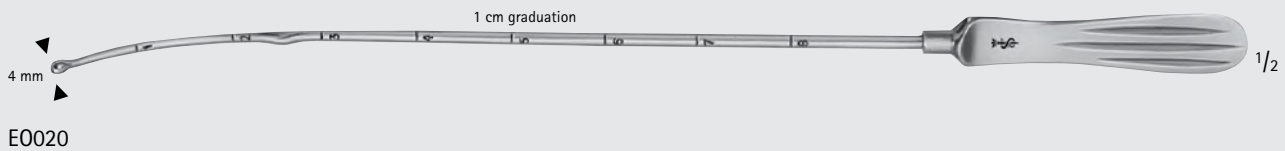

**BRAUN Uterine Depressor, Double  
Ended**

Catalog Number	Blade Size (mm)	Length (in.)
E0030R	24/28	10 5/8

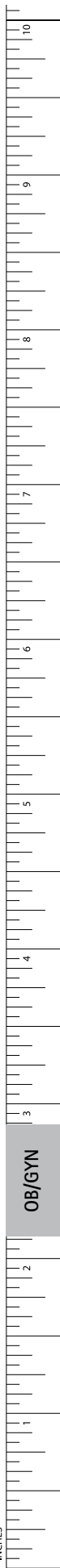

# Obstetrics/Gynecology

## Curettes

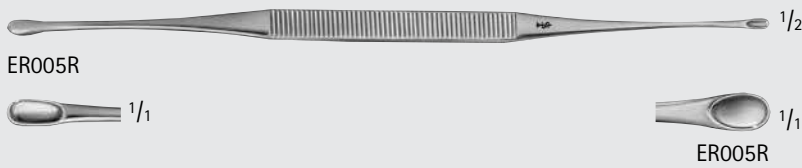

**ASCH Uterine Secretion Scoop, Malleable, Double Ended**

Catalog Number	Length (in.)
ER005R	7 7/8

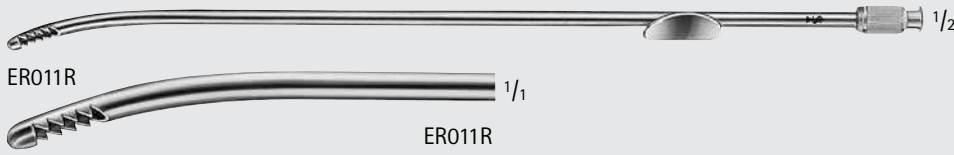

**NOVAK Endometrial Biopsy Suction Curette**

Catalog Number	Length (in.)
ER011R	9 1/2

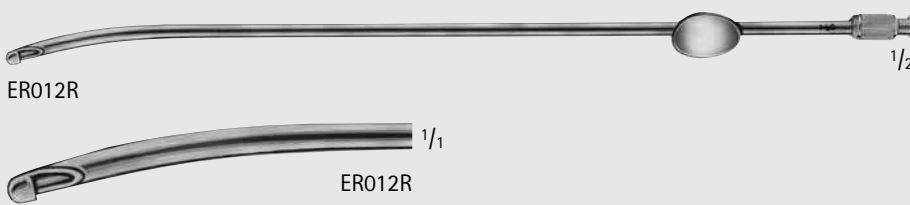

**RANDALL Endometrial Suction and Biopsy Curette**

Catalog Number	Length (in.)
ER012R	9 1/2

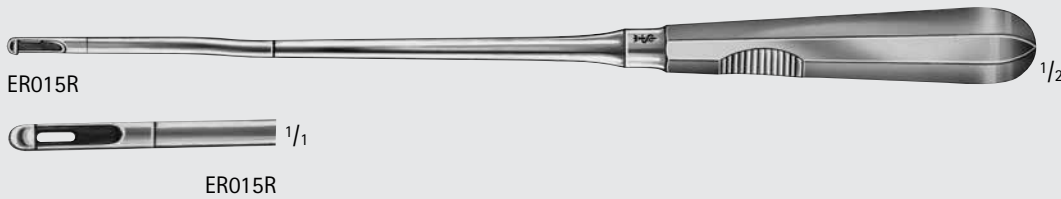

**BERLIN Endometrial Biopsy Curette**

Catalog Number	Tip Size (mm)	Length (in.)
ER015R	3.5	10 5/8

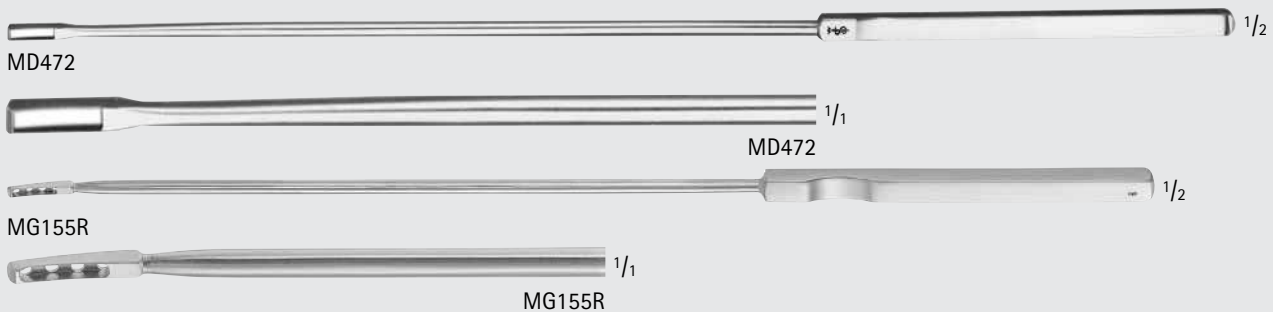

**KEVORKIAN-YOUNGE Biopsy Curette**

Catalog Number	Tip	Description	Length (in.)
MD472	SLIGHT-CVD	W/O Basket	13
MG155R	SLIGHT-CVD	W/ Basket	12 1/4



OB/GYN



RECAMIER Uterine Curette

Catalog Number	Tip Size (#)	Tip Size (mm)	Tip	Length (in.)
ER219R	00	4.5	SHARP	11 3/4
ER220R	0	7.5	SHARP	11 3/4
ER221R	1	8.5	SHARP	11 3/4
ER222R	2	10.5	SHARP	11 3/4
ER223R	3	12.0	SHARP	11 3/4
ER224R	4	14.0	SHARP	11 3/4
ER225R	5	15.0	SHARP	11 3/4
ER226R	6	16.5	SHARP	11 3/4
ER227R	7	18.0	SHARP	11 3/4
ER228R	8	19.5	SHARP	11 3/4
ER229R	9	21.5	SHARP	11 3/4
ER230R	10	23.5	SHARP	11 3/4
ER241R	1	8.5	SHARP/MALL	11 3/4
ER242R	2	10.5	SHARP/MALL	11 3/4
ER243R	3	12.0	SHARP/MALL	11 3/4
ER244R	4	14.0	SHARP/MALL	11 3/4
ER245R	5	15.0	SHARP/MALL	11 3/4
ER246R	6	16.5	SHARP/MALL	11 3/4
ER247R	7	18.0	SHARP/MALL	11 3/4
ER248R	8	19.5	SHARP/MALL	11 3/4
ER320R	0	7.5	BLUNT	11 3/4
ER321R	1	8.5	BLUNT	11 3/4
ER322R	2	10.5	BLUNT	11 3/4
ER323R	3	12.0	BLUNT	11 3/4
ER324R	4	14.0	BLUNT	11 3/4
ER325R	5	15.0	BLUNT	11 3/4
ER326R	6	16.5	BLUNT	11 3/4
ER327R	7	18.0	BLUNT	11 3/4
ER328R	8	19.5	BLUNT	11 3/4
ER329R	9	21.5	BLUNT	11 3/4
ER330R	10	23.5	BLUNT	11 3/4
ER611R	1	34.5	BLUNT	14 1/4
ER612R	2	39.5	BLUNT	14 1/4

ER219R-ER330R

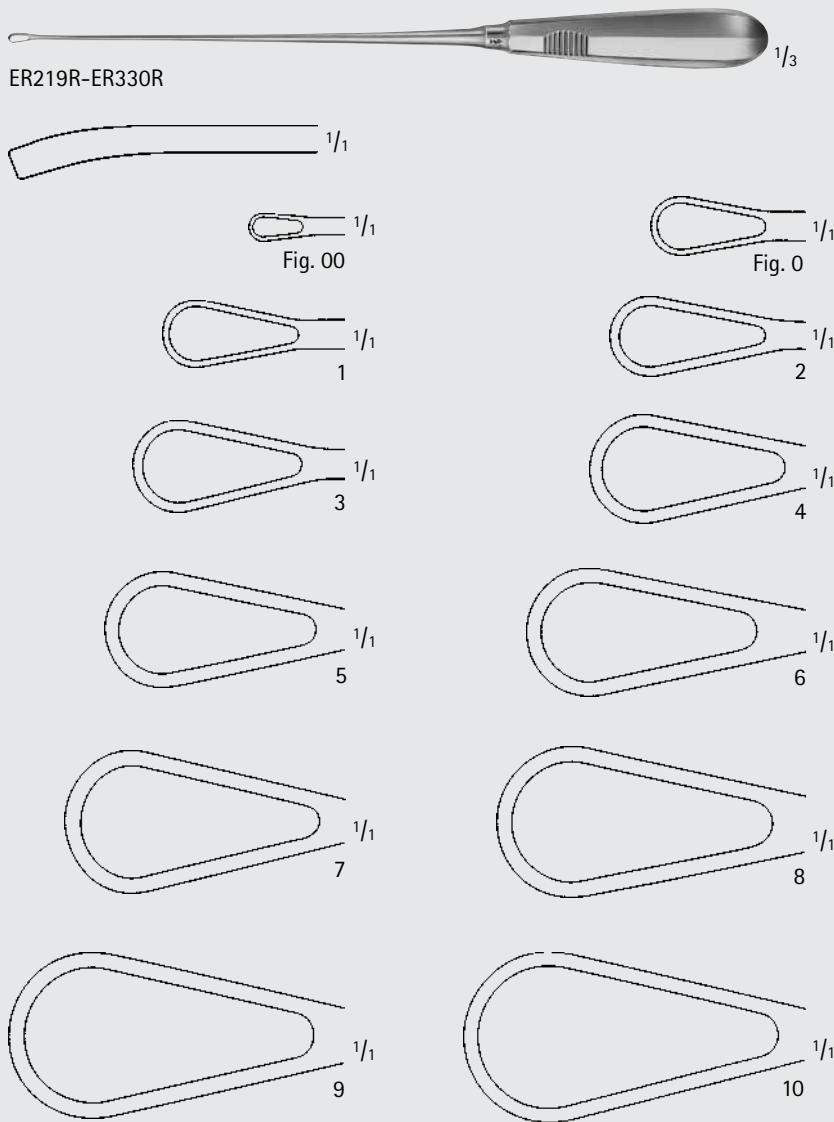

ER611R-ER612R

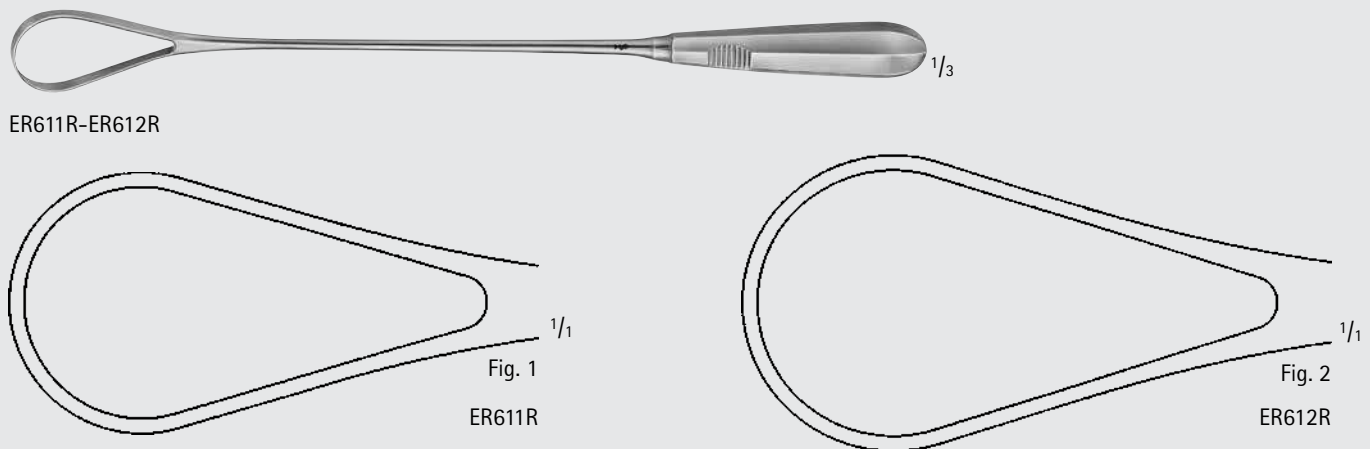

OB/GYN

INCHES

### SIMS Uterine Curette

Catalog Number	Tip Size (#)	Tip Size (mm)	Tip	Length (in.)
ER401R	1	7.5	SHARP	10
ER402R	2	8.5	SHARP	10
ER403R	3	10.5	SHARP	10
ER404R	4	12.0	SHARP	10
ER405R	5	14.0	SHARP	10
ER406R	6	15.0	SHARP	10
ER411R	1	7.5	SHARP/MALL	10
ER412R	2	8.5	SHARP/MALL	10
ER413R	3	10.5	SHARP/MALL	10
ER414R	4	12.0	SHARP/MALL	10
ER415R	5	14.0	SHARP/MALL	10
ER416R	6	15.0	SHARP/MALL	10
ER421R	1	7.5	BLUNT	10
ER422R	2	8.5	BLUNT	10
ER423R	3	10.5	BLUNT	10
ER424R	4	12.0	BLUNT	10
ER425R	5	14.0	BLUNT	10
ER426R	6	15.0	BLUNT	10
MG140R	000	4.5	SHARP/MALL	11
MG141R	00	5.6	SHARP/MALL	11
MG142R	0	6.2	SHARP/MALL	11
MG143R	1	7.3	SHARP/MALL	11
MG144R	2	8.5	SHARP/MALL	11
MG145R	3	9.4	SHARP/MALL	11
MG146R	4	10.6	SHARP/MALL	11
MG147R	5	11.5	SHARP/MALL	11
MG148R	6	12.6	SHARP/MALL	11



ER401R-MG148R

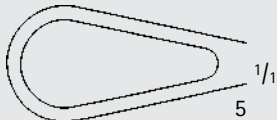
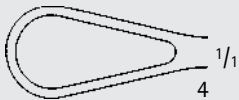
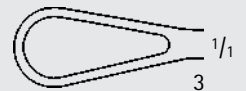
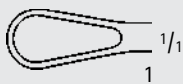
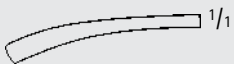

ER401R-ER426R

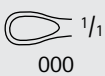

MG140R-MG148R

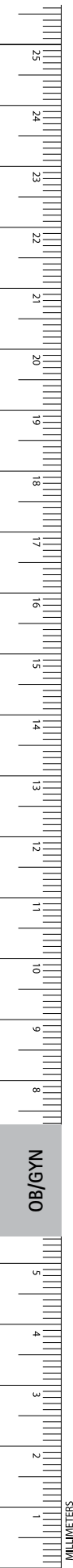

**BUMM Uterine Curette, Blunt  
Malleable**

Catalog Number	Tip Size (#)	Tip Size (mm)	Length (in.)
ER520R	0	16.0	11 1/2
ER521R	1	18.0	11 1/2
ER522R	2	19.5	11 1/2
ER523R	3	21.5	11 1/2
ER524R	4	23.5	11 1/2
ER525R	5	26.0	11 1/2
ER526R	6	28.5	11 1/2



ER520R-ER526R

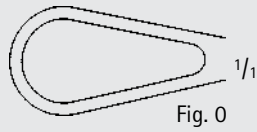

Fig. 0

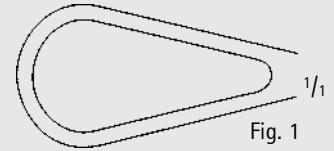
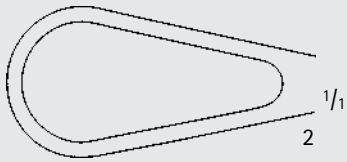
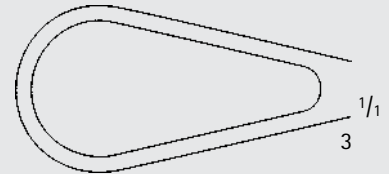

Fig. 1



2



3

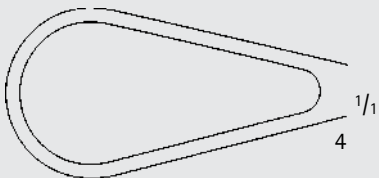

4

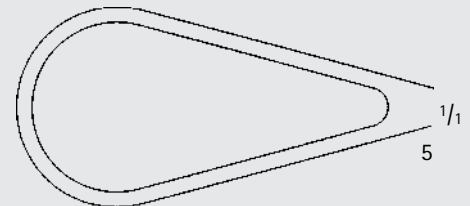

5

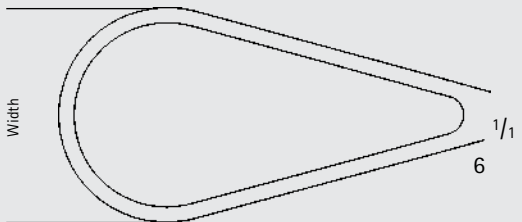

6

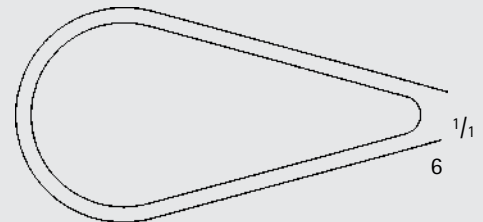

6



# Obstetrics/Gynecology

## Curettes

### SIMS THOMAS Uterine Curette, Blunt/Malleable

Catalog Number	Tip Size (#)	Tip Size (mm)	Length (in.)
MG149R	0	6.0	11
ER211R	1	8.5	11
ER212R	2	10.5	11
ER213R	3	12.0	11
ER214R	4	14.0	11
ER215R	5	15.0	11
ER216R	6	16.5	11



MG149R-ER216R

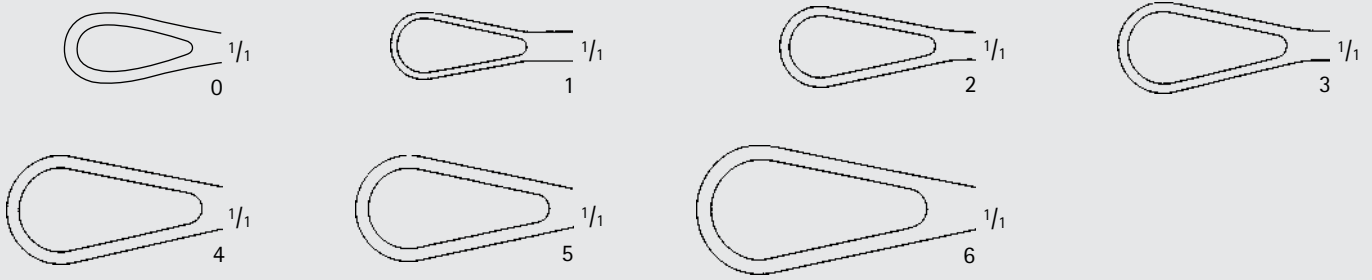

### KELLY-GRAY Uterine Curette

Catalog Number	Tip Size (#)	Tip Size (mm)	Length (in.)
MB375R	1	5.0	9 1/2
MB376R	2	6.0	9 1/2
MB377R	3	7.5	9 1/2
MB378R	4	8.5	9 1/2



MB375R-MB378R



MB375R



MB376R



MB377R



MB378R



OB/GYN

**HEANEY Uterine Curette, Malleable**

Catalog Number	Tip	Length (in.)
ER025R	TOOTHED	9 1/2



ER025R



ER025R

**COLLIN Uterine Curette, Rigid**

Catalog Number	Tip	Length (in.)
ER580R	TOOTHED	11 3/4



ER580R



ER580R

**BLAKE Uterine Curette, Double Ended**

Catalog Number	Tip	Length (in.)
ER585R	SHARP/BLUNT	10 3/4



ER585R

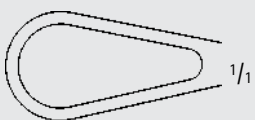

1/1

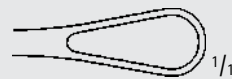

ER585R

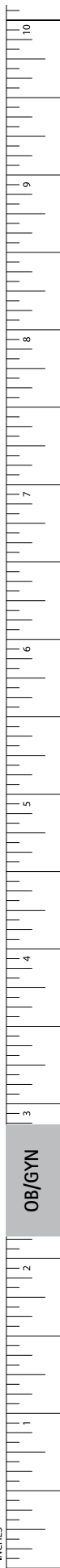

OB/GYN

INCHES

# Obstetrics/Gynecology

## Curettes

### BUMM Uterine Curette

Catalog Number	Tip Size (#)	Tip Size (mm)	Tip	Length (in.)
ER621R	1	23.5	SHARP/MALL	12 1/4
ER623R	3	28.5	SHARP/MALL	12 1/4
ER626R	1	23.5	BLUNT/MALL	12 1/4
ER627R	2	26.0	BLUNT/MALL	12 1/4
ER628R	3	28.5	BLUNT/MALL	12 1/4



ER621R-ER628R

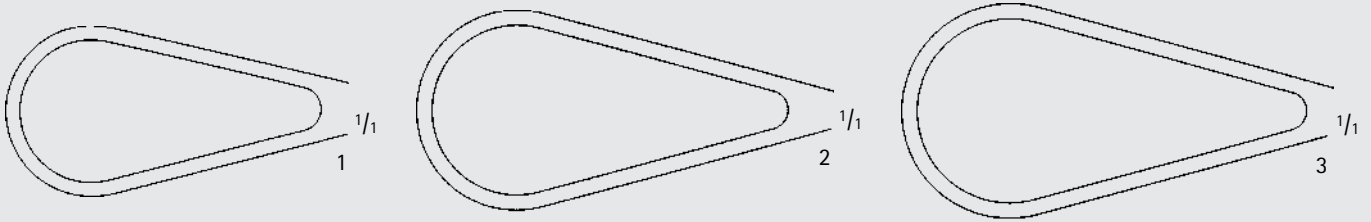

### WALLICH Placenta/Ovum Scoop

Catalog Number	Tip	Length (in.)
ER602R	CVD	16 3/4



ER602R



ER602R

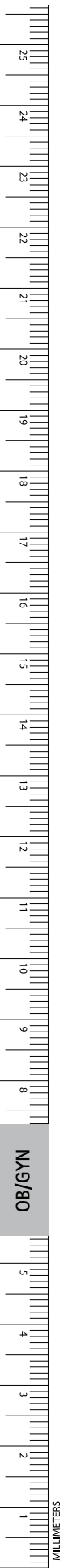

OB/GYN

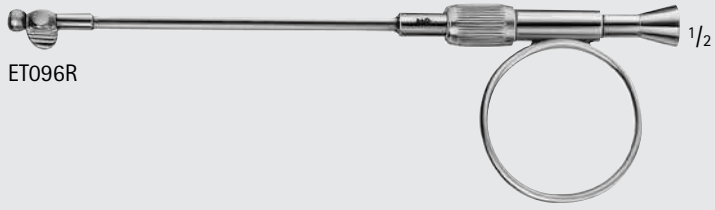

ET096R



SR580R

**Guide Sheath, IOWA Trumpet**

Catalog Number	Tip Size (mm)	Description	Length (in.)
ET096R	—	—	6 7/8
SR580R	1 x 185	INJECTION NEEDLE, LUER-LOCK HUB	—

**Uterine Cannula W/ 2 Cones**

Catalog Number	Length (in.)
ER876	13 3/4

- Cones:  
1 ER876201 (small)  
1 ER876202 (large)



ER876

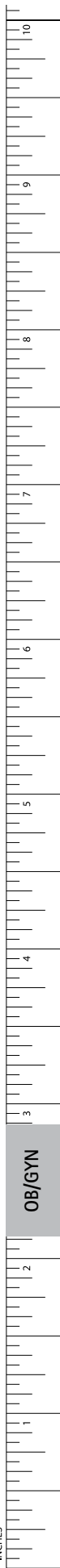



## *Manufacturing Unit -*

***115-A Waryana Industrial Complex, Leather Complex Road,  
Jalandhar Punjab, 144021***



## *Sales Office -*

***Plot No. 581- Kakrola Housing Complex, Near Metro Pillar 802,  
Dwarka Mor, Delhi, 110078***



## *Our Certifications -*

***UDYAM , ISO 13485, WHO-GMP, ISO 9001:2015, CE , ROHS,  
FDA , MD-42, MD-5***

### CONTACT US:



+91- 98141-81255, +91- 98142-62255



[www.alisprofessional.com](http://www.alisprofessional.com)



[info@royalinternational.org](mailto:info@royalinternational.org)