



General Surgery

Scissors	2 - 52
Needle Holders and Cases	53 - 76
Ligature Needles	77 - 78
Forceps and Clamps	79 - 189
Skin Hooks	190 - 192
Retractors	193 - 254
Universal Ring Retractor System	255 - 271
Self Retaining Retractors	272 - 283
Rectal Specula Instruments	284 - 291
Probes, Dilators and Scoops	292 - 299
Scalpel Blades and Handles	300 - 307
Amputation and Autopsy Instruments	308 - 310
Suction Instruments	311 - 322
Rulers, Calipers and Accessories	323 - 324
Metal Bowls and Cups	325

General Surgery

Scissors

GENERAL SURGERY

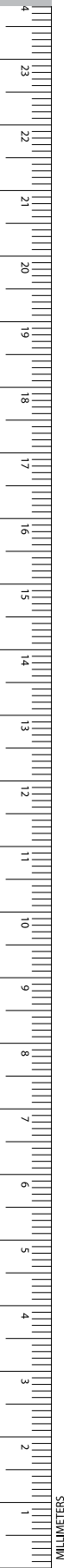

BC374R-BC474R

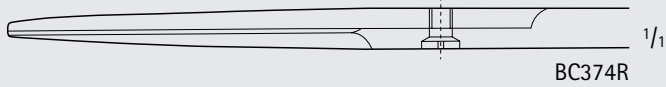

BC374R

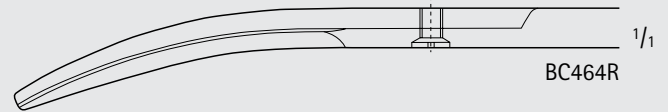

BC464R

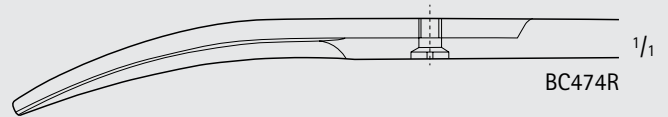

BC474R

DEAVER Suture Scissors

Catalog Number	Tip	Blade	Length (in.)
BC374R	S/B	STR	5 3/4
BC474R	S/B	CVD	5 3/4
BC464R	B/B	CVD	5 3/4



BC130R-BC131R

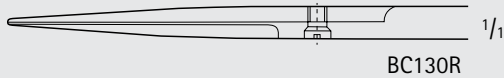

BC130R

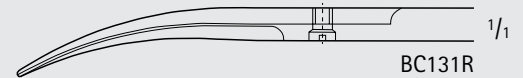

BC131R



BC341R-BC346R

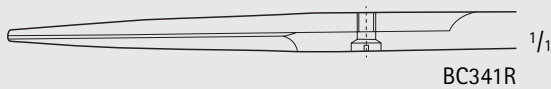

BC341R

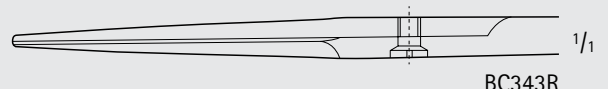

BC343R

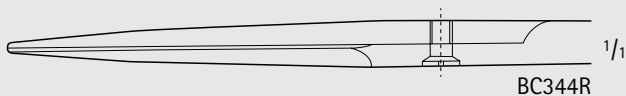

BC344R

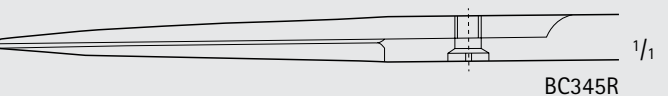

BC345R

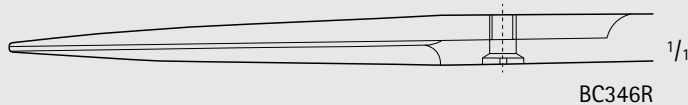

BC346R

Suture Scissors

Catalog Number	Tip	Blade	Length (in.)
BC130R	S/S	STR	4 3/4
BC341R	S/S	STR	4 1/2
BC343R	S/S	STR	5 1/8
BC344R	S/S	STR	5 3/4
BC345R	S/S	STR	6
BC346R	S/S	STR	6 1/2
BC131R	S/S	CVD	4 3/4



BC441R-BC445R

Suture Scissors

Catalog Number	Tip	Blade	Length (in.)
BC441R	S/S	CVD	4 1/2
BC443R	S/S	CVD	5 1/8
BC444R	S/S	CVD	5 3/4
BC445R	S/S	CVD	6

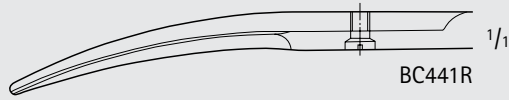

BC441R

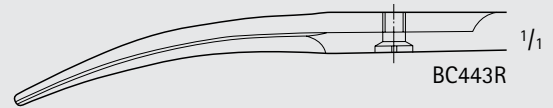

BC443R

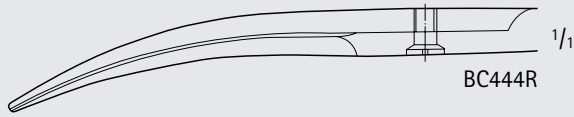

BC444R

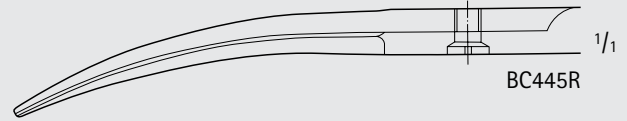

BC445R



BC303R-BC304R

Suture Scissors

Catalog Number	Tip	Blade	Length (in.)
BC303R	S/B	DEL, STR	5 1/8
BC304R	S/B	DEL, STR	5 3/4

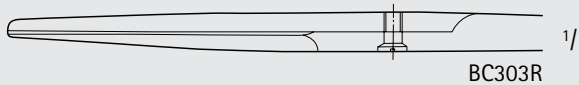

BC303R

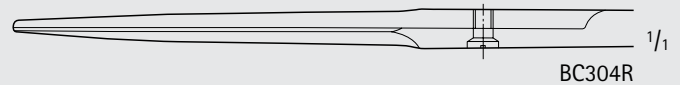

BC304R



BC496R

Scissors

Catalog Number	Tip	Blade	Length (in.)
BC496R	S/B	STR/1-SERR	5 1/8

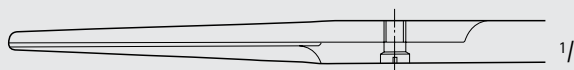

BC496R

General Surgery

Scissors

GENERAL SURGERY

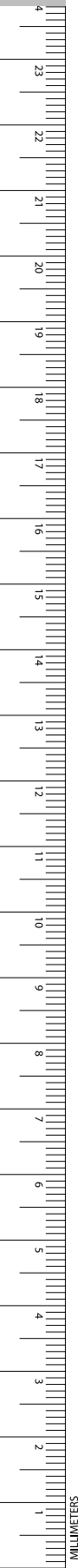

BC320R-BC330R

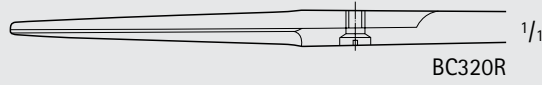

BC320R

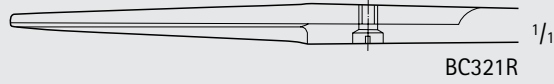

BC321R

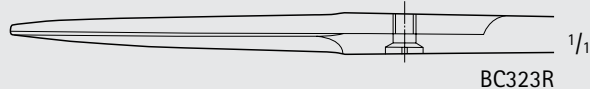

BC323R

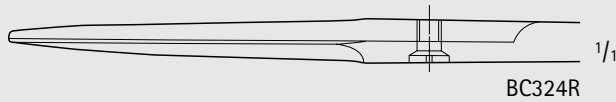

BC324R



BC325R

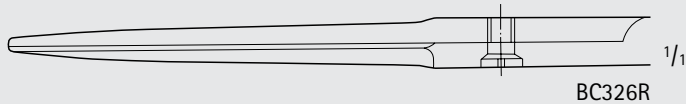

BC326R

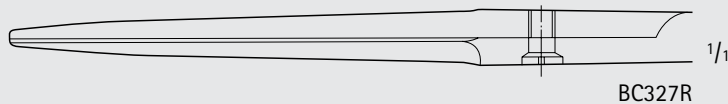

BC327R

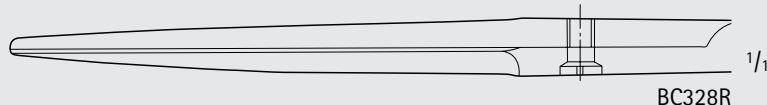

BC328R

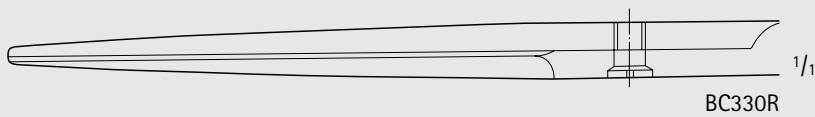

BC330R

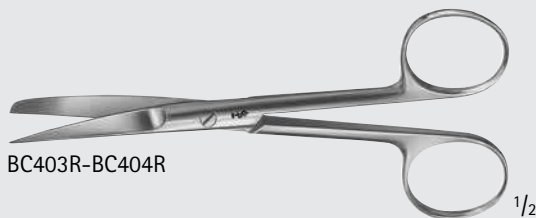

BC403R-BC404R

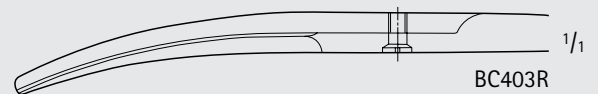

BC403R

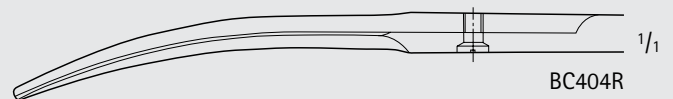

BC404R

Suture Scissors

Catalog Number	Tip	Blade	Length (in.)
BC320R	S/B	STR	4 1/8
BC321R	S/B	STR	4 1/2
BC323R	S/B	STR	5 1/8
BC324R	S/B	STR	5 3/4
BC325R	S/B	STR	6
BC326R	S/B	STR	6 1/2
BC327R	S/B	STR	6 7/8
BC328R	S/B	STR	7 1/4
BC330R	S/B	STR	7 7/8
BC403R	S/B	CVD	5 1/8
BC404R	S/B	CVD	5 3/4



BC421R-BC428R

Suture Scissors

Catalog Number	Tip	Blade	Length (in.)
BC421R	S/B	CVD	4 1/2
BC423R	S/B	CVD	5 1/8
BC424R	S/B	CVD	5 3/4
BC425R	S/B	CVD	6
BC426R	S/B	CVD	6 1/2
BC428R	S/B	CVD	7 1/4

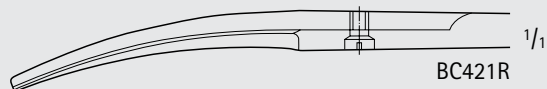

BC421R

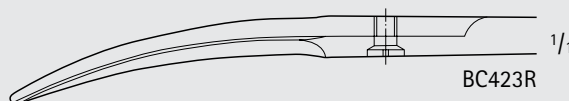

BC423R

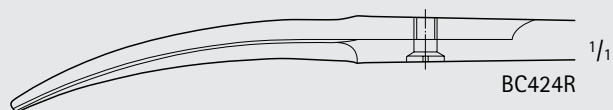

BC424R

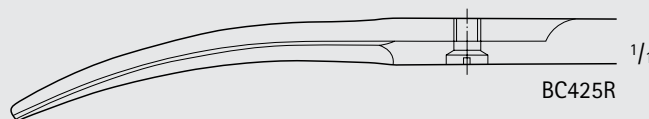

BC425R



BC426R

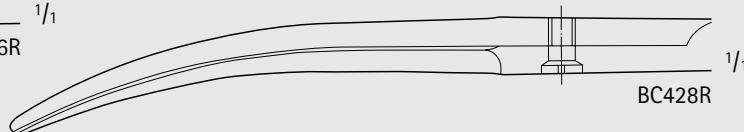

BC428R



BC135R

1/2

Suture Scissors

Catalog Number	Tip	Blade	Length (in.)
BC135R	B/B	CVD, DEL	4 3/4

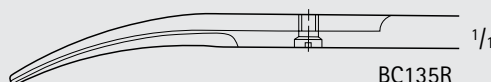

BC135R

1/1

General Surgery

Scissors

GENERAL SURGERY



BC313R-BC317R

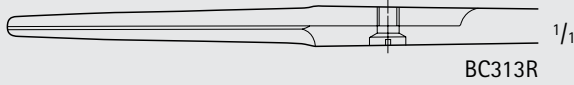

BC313R

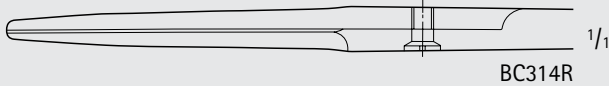

BC314R

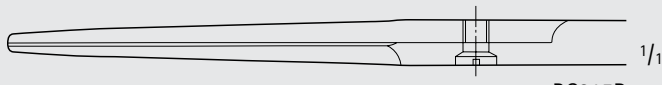

BC315R

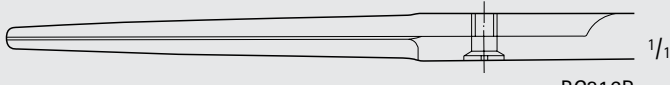

BC316R

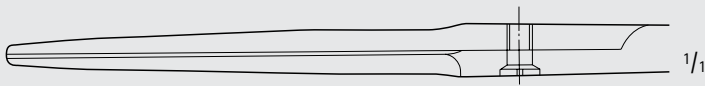

BC317R



BC411R-BC417R

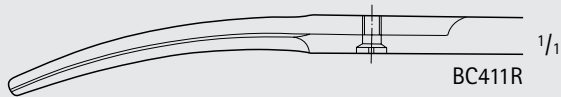

BC411R

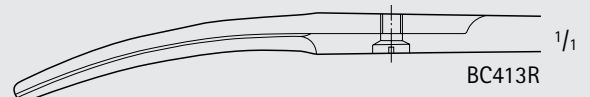

BC413R

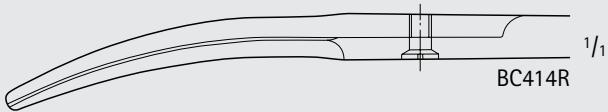

BC414R

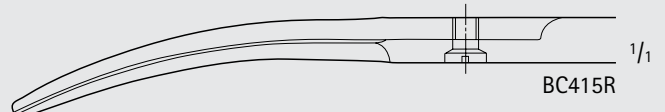

BC415R

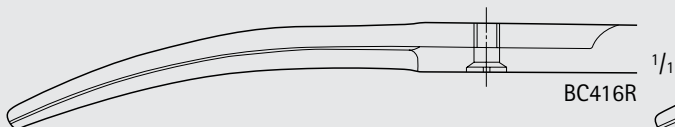

BC416R

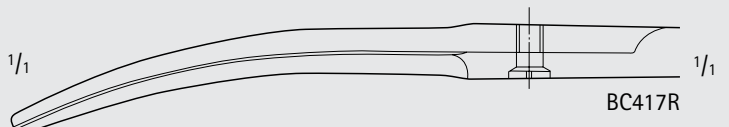

BC417R

COOPER Suture Scissors

Catalog Number	Tip	Blade	Length (in.)
BC313R	B/B	STR	5 1/8
BC314R	B/B	STR	5 3/4
BC315R	B/B	STR	6
BC316R	B/B	STR	6 1/2
BC317R	B/B	STR	6 7/8
BC411R	B/B	CVD	4 1/2
BC413R	B/B	CVD	5 1/8
BC414R	B/B	CVD	5 3/4
BC415R	B/B	CVD	6
BC416R	B/B	CVD	6 1/2
BC417R	B/B	CVD	6 7/8



LITTAUER Ligature Scissors

Catalog Number	Tip	Blade	Length (in.)
BC803R	B/1-NOTCH	STR	5 1/4

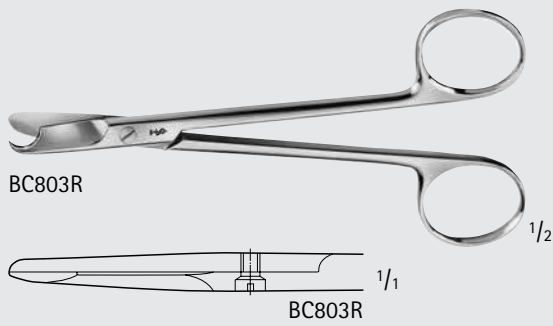

NORTHBENT Ligature Scissors

Catalog Number	Tip	Blade	Length (in.)
BC805R	B/1-NOTCH	LAT-CVD	4 3/4

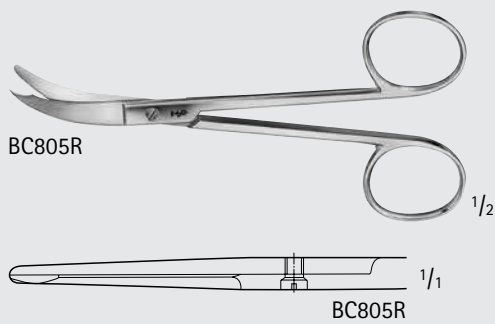

SPENCER Suture Scissors

Catalog Number	Tip	Blade	Length (in.)
BC801R	B/1-NOTCH	STR	3 1/2
BC802R	B/1-NOTCH	STR	4 1/2

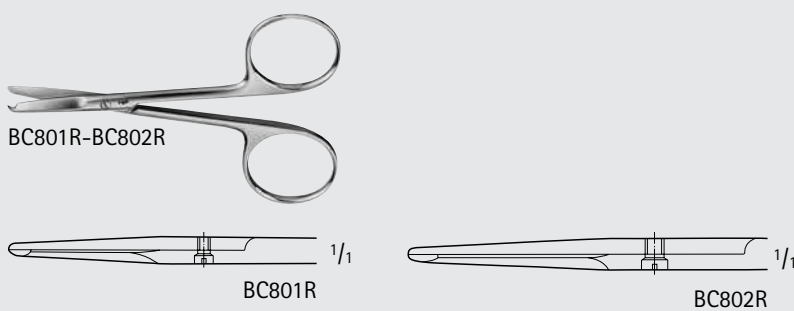

KNOWLES Bandage Scissors

Catalog Number	Tip	Blade	Length (in.)
BC846R	1-PROBE-POINT	STR	5 3/4
BC847R	1-PROBE-POINT	LAT-ANG	5 1/2

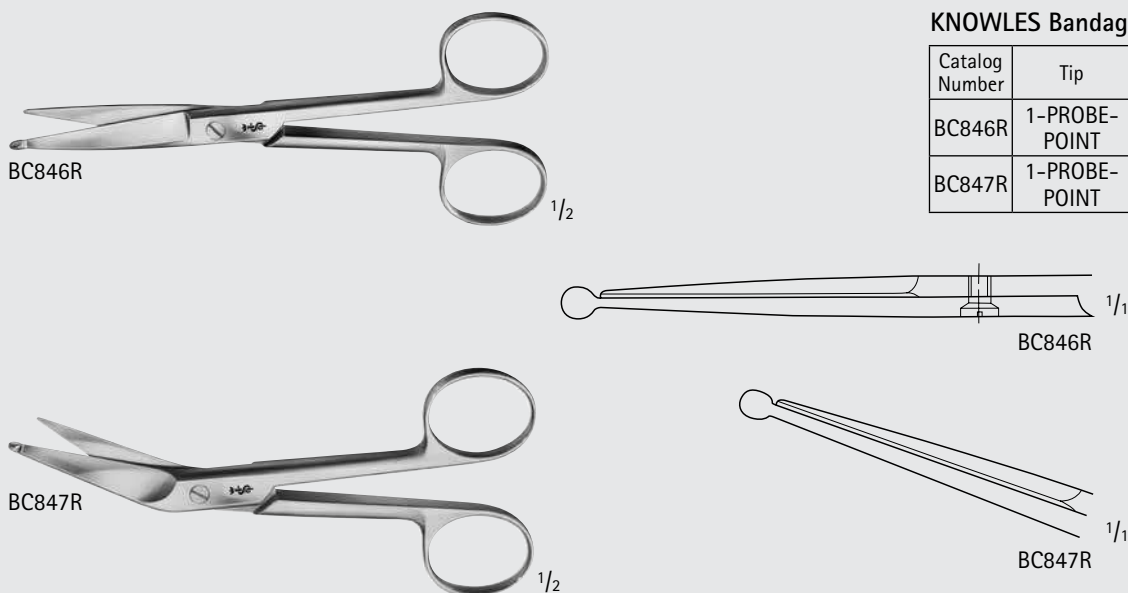

General Surgery

Scissors

GENERAL SURGERY

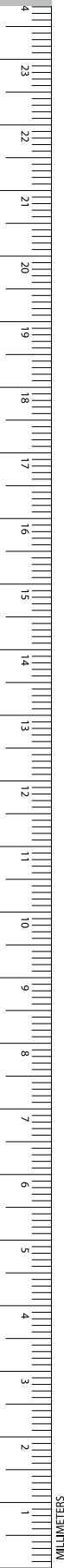

BC848R-BC863R

LISTER Bandage Scissors

Catalog Number	Blade	Length (in.)
BC848R	LONG	6 1/8
BC849R	LONG	7
BC860R	STANDARD	4 1/2
BC861R	STANDARD	5 1/2
BC862R	STANDARD	7
BC863R	STANDARD	7 7/8

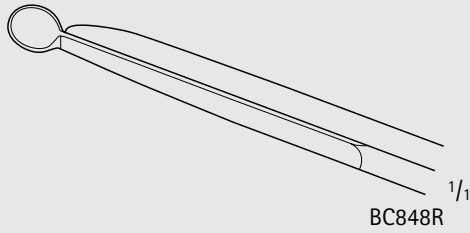

BC848R

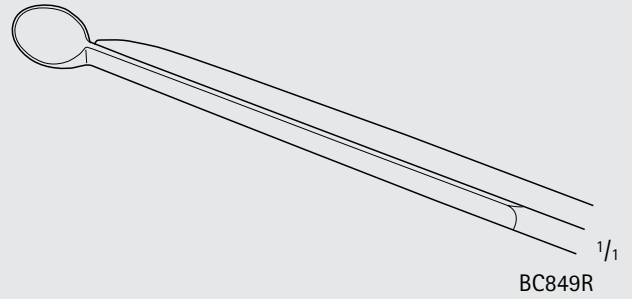

BC849R

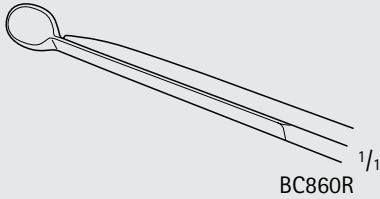

BC860R

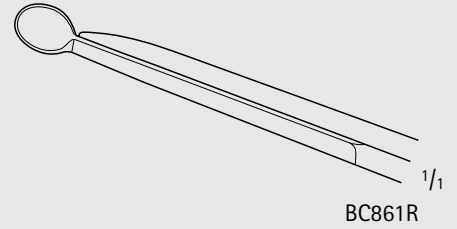

BC861R

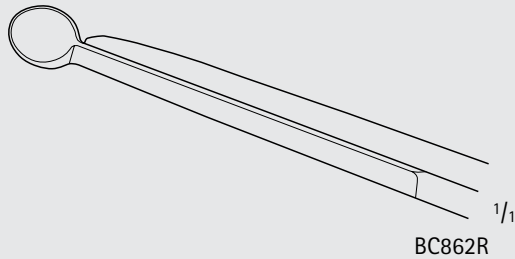

BC862R

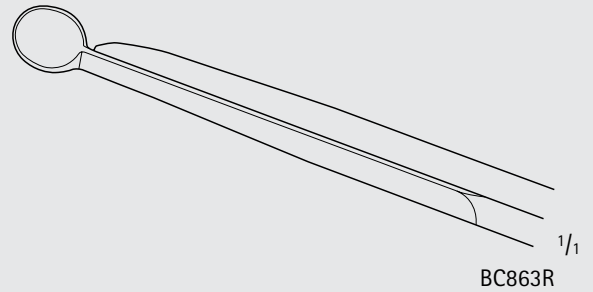

BC863R



MG379R



MG379R

LISTER Bandage Scissors, Gold Handle

Catalog Number	Length (in.)
MG379R	5 1/2

LISTER Bandage Scissors, W/ One Large Ring

Catalog Number	Length (in.)
MB223	8

MB223



LISTER Bandage Scissors, Serrated

Catalog Number	Length (in.)
MB146R	3 1/2
BC876R	6 1/4

BC876R, MB146R

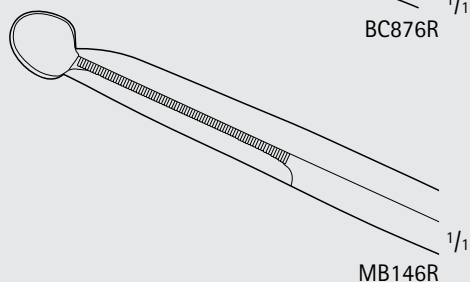
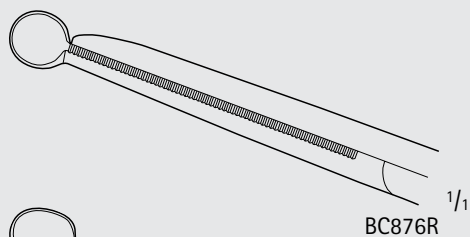

General Surgery

Scissors

GENERAL SURGERY



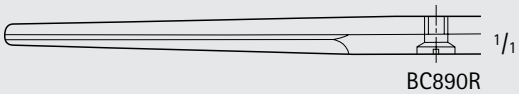

BC890R $\frac{1}{2}$



BC890R $\frac{1}{1}$

Catalog Number	Tip	Blade	Handle Color	Length (in.)
BC890R	B/B	STR	RED	5 3/4



BC885R-BC979R $\frac{1}{2}$

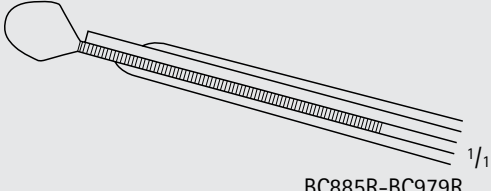

BC885R-BC979R $\frac{1}{1}$

Catalog Number	Handle Color	Length (in.)
BC885R	BLACK	5 3/4
BC970R	RED	5 3/4
BC971R	BLUE	5 3/4
BC973R	YELLOW	5 3/4
BC975R	ORANGE	5 3/4
BC977R	PINK	5 3/4
BC978R	LIGHT GREEN	5 3/4
BC979R	VIOLET	5 3/4



BC881R-BC989R $\frac{1}{2}$

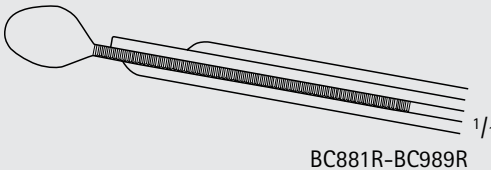

BC881R-BC989R $\frac{1}{1}$

Catalog Number	Handle Color	Length (in.)
BC881R	BLACK	7
BC980R	RED	7
BC981R	BLUE	7
BC983R	YELLOW	7
BC985R	ORANGE	7
BC987R	PINK	7
BC988R	LIGHT GREEN	7
BC989R	VIOLET	7

STILLE Dissecting Scissors, Round Blades

Catalog Number	Tip	Blade	Length (in.)
BC580R	B/B	STR	6
BC581R	B/B	CVD	6

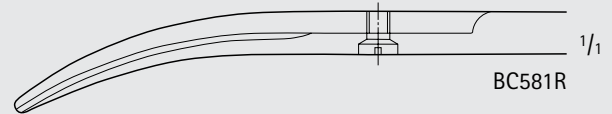
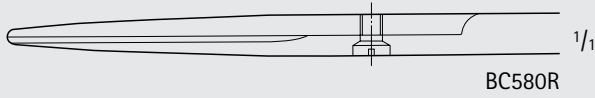

MAYO Dissecting Scissors, Round Blade

Catalog Number	Tip	Blade	Length (in.)
BC584R	B/B	STR	6 1/2
BC585R	B/B	STR	7 7/8
BC587R	B/B	CVD	6 1/2
BC588R	B/B	CVD	7 7/8
BC589R	B/B	CVD	8 1/4

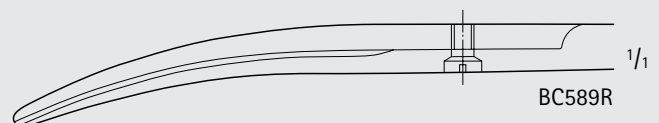
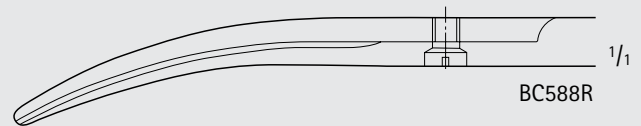
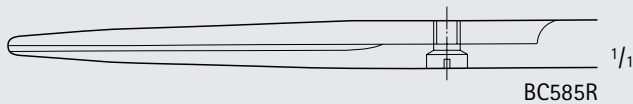
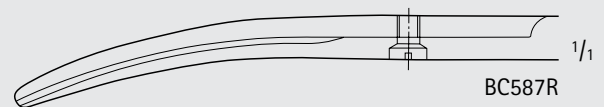
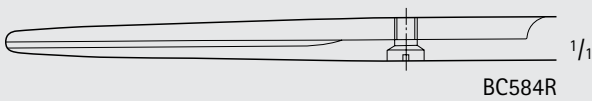

General Surgery

Scissors

GENERAL SURGERY

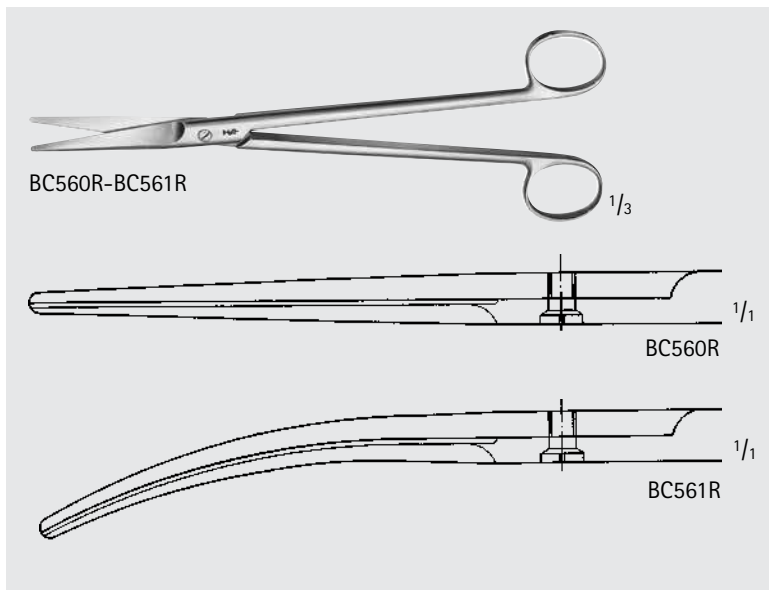
BC560R-BC561R $\frac{1}{3}$

BC560R $\frac{1}{1}$

BC561R $\frac{1}{1}$

MAYO-HARRINGTON Dissecting Scissors

Catalog Number	Tip	Blade	Length (in.)
BC560R	B/B	STR	9
BC561R	B/B	CVD	9

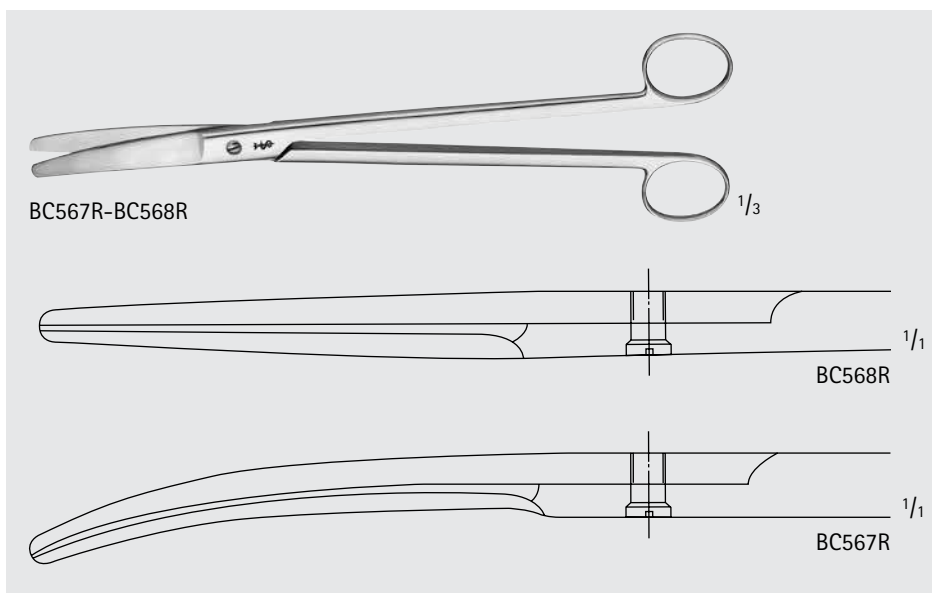

BC567R-BC568R $\frac{1}{3}$

BC568R $\frac{1}{1}$

BC567R $\frac{1}{1}$

MAYO-HARRINGTON Dissecting Scissors

Catalog Number	Tip	Blade	Length (in.)
BC568R	B/B	STR	11
BC567R	B/B	CVD	11

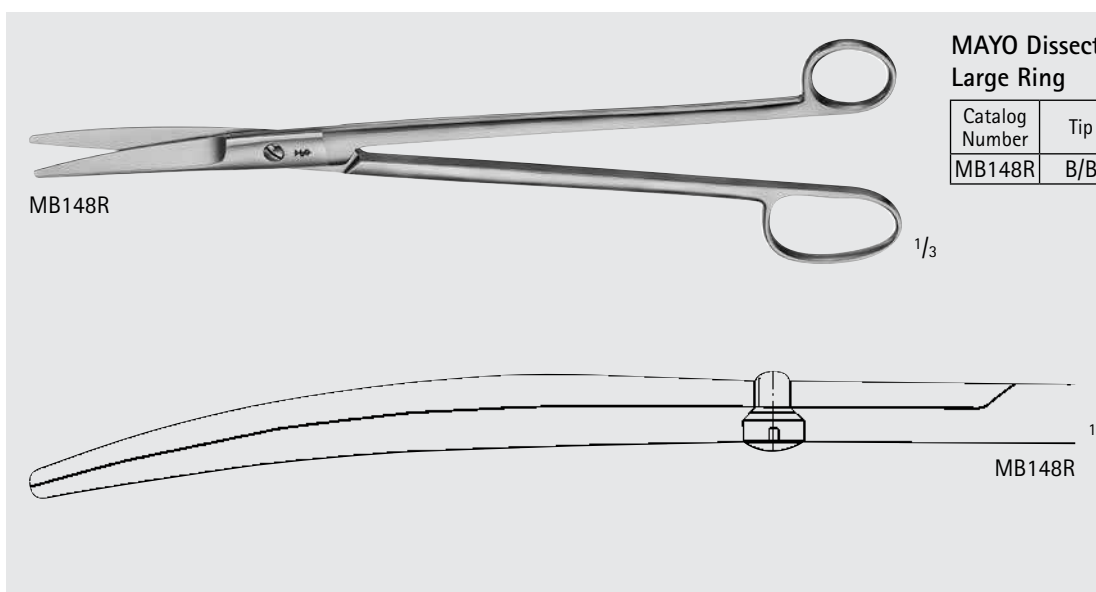

MB148R $\frac{1}{3}$

MB148R $\frac{1}{1}$

MAYO Dissecting Scissors, W/ One Large Ring

Catalog Number	Tip	Blade	Length (in.)
MB148R	B/B	HEAVY	14



BC544R-BC557R

MAYO Dissecting Scissors, Beveled Blade

Catalog Number	Tip	Blade	Length (in.)
BC544R	B/B	STR	5 1/2
BC545R	B/B	STR	6 1/8
BC547R	B/B	STR	6 3/4
BC562R	B/B	STR	7 1/2
BC564R	B/B	STR	8 1/2
BC554R	B/B	CVD	5 1/2
BC555R	B/B	CVD	6 1/8
BC557R	B/B	CVD	6 3/4
BC563R	B/B	CVD	7 1/2
BC565R	B/B	CVD	8 1/2

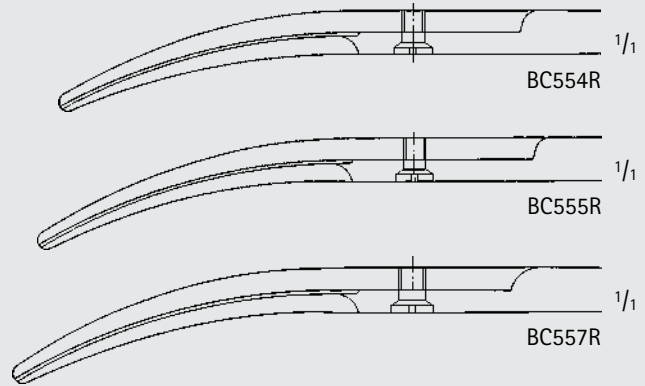
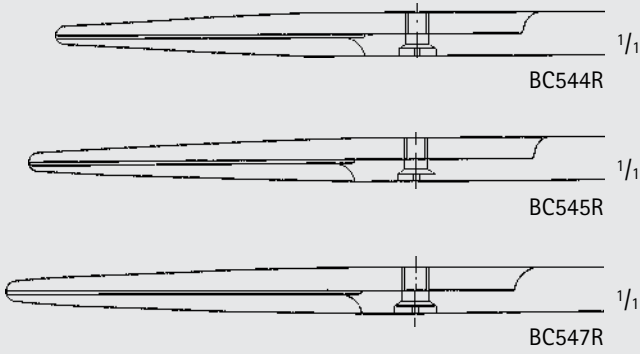

BC562R-BC565R

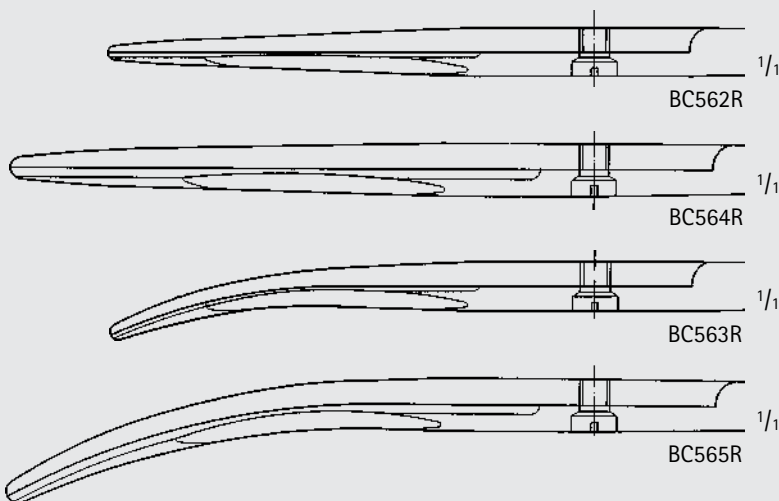

INCHES

General Surgery

Scissors

GENERAL SURGERY

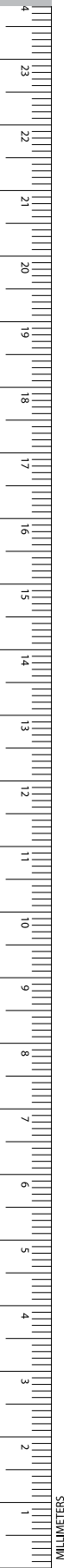
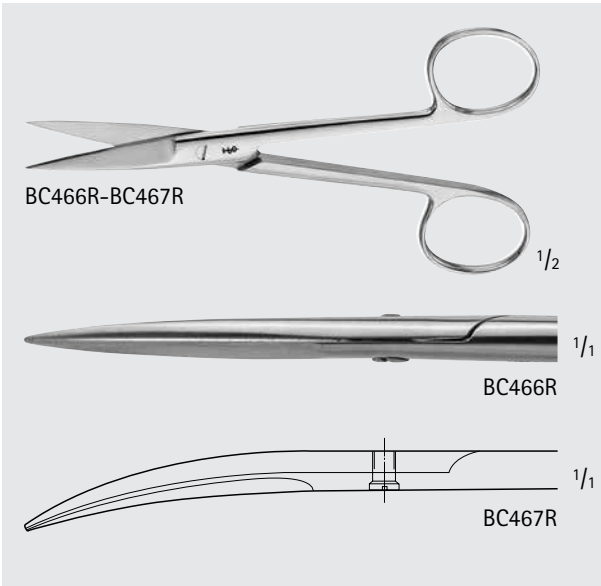
MAYO Operating Scissors

Catalog Number	Tip	Blade	Length (in.)
BC466R	S/S	STR	5 1/2
BC467R	S/S	CVD	5 1/2

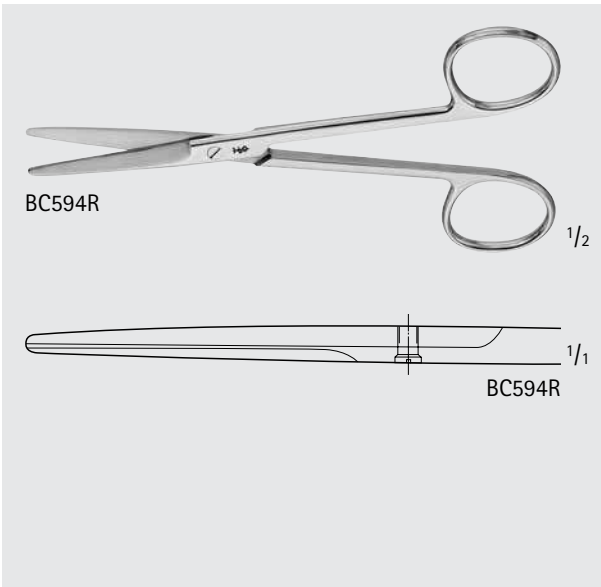

MAYO Dissecting Scissors, Delicate

Catalog Number	Tip	Blade	Length (in.)
BC594R	B/B	STR	5 1/2

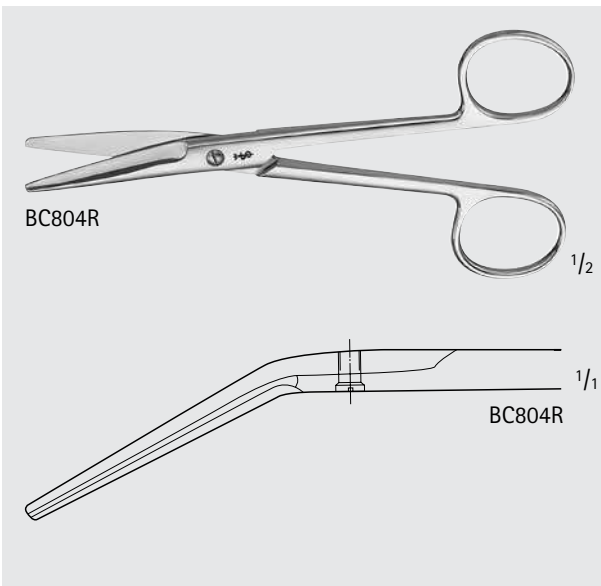

NEW'S Suture Scissors

Catalog Number	Tip	Blade	Length (in.)
BC804R	B/B	ANG	5 1/2



Suture Scissors

Catalog Number	Tip	Blade	Length (in.)
BC806R	B/B	STR	4 1/2



BC806R

1/2

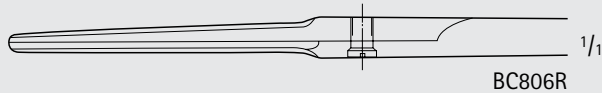

BC806R

1/1

LEXER Dissecting Scissors, Delicate

Catalog Number	Tip	Blade	Length (in.)
BC590R	B/B	STR	6 1/2
BC591R	B/B	CVD	6 1/2

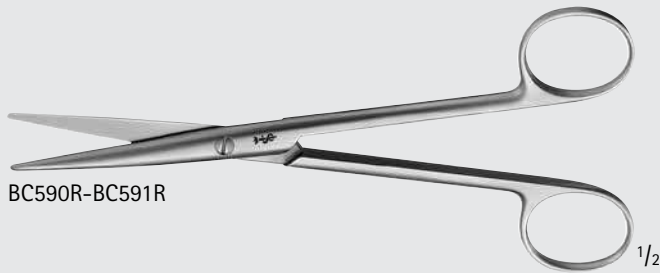

BC590R-BC591R

1/2

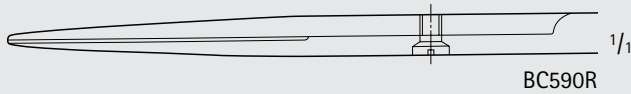

BC590R

1/1

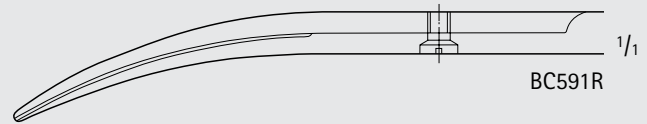

BC591R

1/1

MAYO-LEXER Dissecting Scissors

Catalog Number	Tip	Blade	Length (in.)
BC592R	B/B	CVD	6 1/2

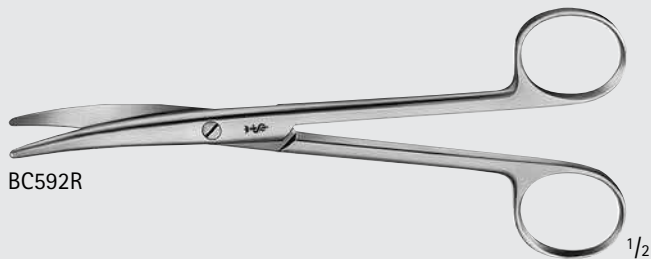

BC592R

1/2

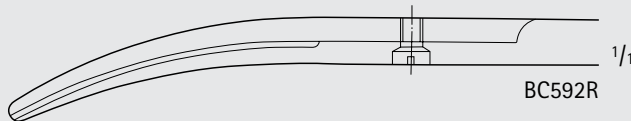

BC592R

1/1

MAYO-SIMS Dissecting Scissors

Catalog Number	Tip	Blade	Length (in.)
MB149R	B/B	STR	7 3/4

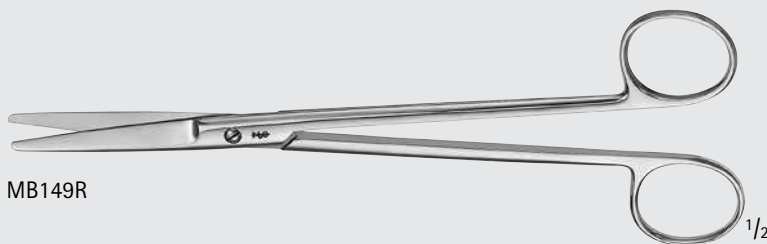

MB149R

1/2



MB149R

1/1

General Surgery

Scissors

GENERAL SURGERY

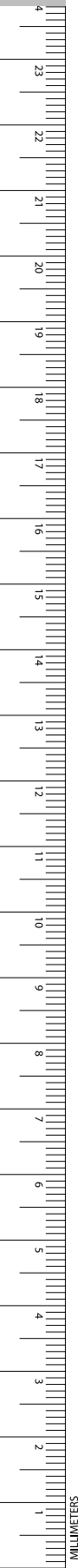

MAYO–NOBLE Dissecting Scissors, Broad Blade



BC566R-BC569R 1/2

Catalog Number	Tip	Blade	Length (in.)
BC566R	B/B	STR	6 3/4
BC569R	B/B	CVD	6 3/4

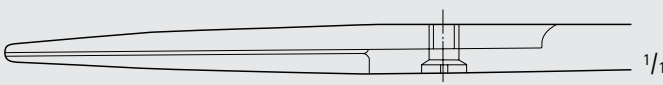

BC566R 1/1

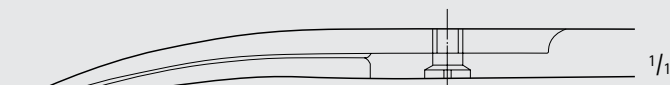

BC569R 1/1

MAYO–STILLE Dissecting Scissors, Beveled Blade



BC576R-BC579R

Catalog Number	Tip	Blade	Length (in.)
BC576R	B/B	STR	5 1/2
BC578R	B/B	STR	6 1/2
BC577R	B/B	CVD	5 1/2
BC579R	B/B	CVD	6 1/2

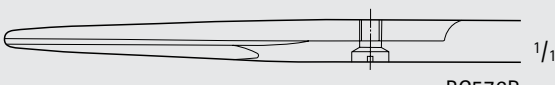

BC576R 1/1

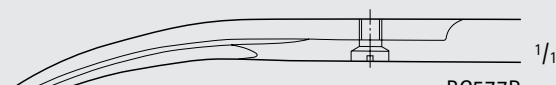

BC577R 1/1

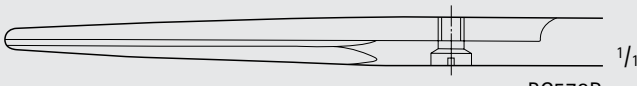

BC578R 1/1

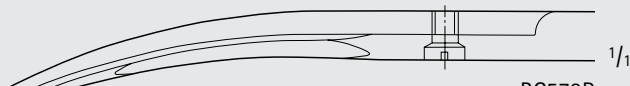

BC579R 1/1

MAYO–STILLE Dissecting Scissors, Flat Blade



BC570R-BC575R

Catalog Number	Tip	Blade	Length (in.)
BC570R	B/B	STR	5 1/2
BC572R	B/B	STR	6 3/4
BC573R	B/B	CVD	5 1/2
BC575R	B/B	CVD	6 3/4

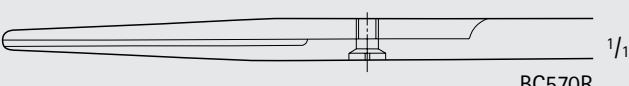

BC570R 1/1

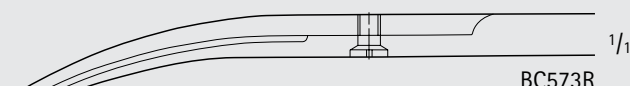

BC573R 1/1

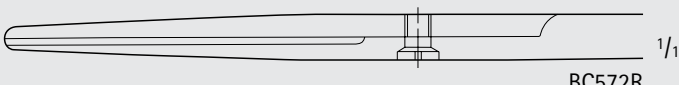

BC572R 1/1

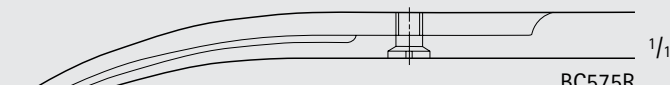

BC575R 1/1



TOENNIS Dissecting Scissors

Catalog Number	Tip	Blade	Length (in.)
BC633R	B/B	X-DEL, STR	7
BC634R	B/B	DEL, STR	7
BC635R	B/B	DEL, CVD	7

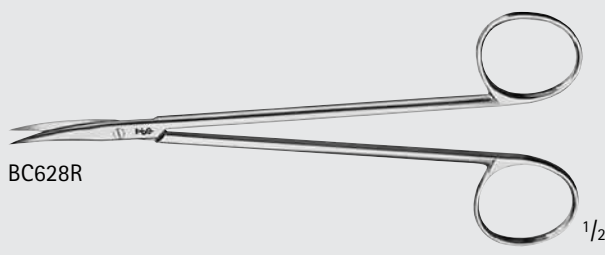
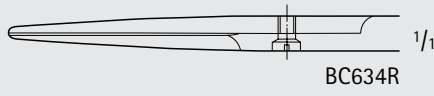
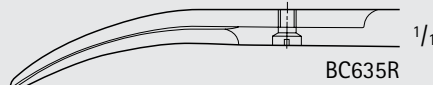
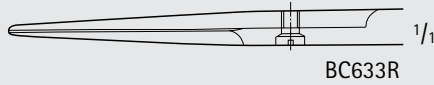
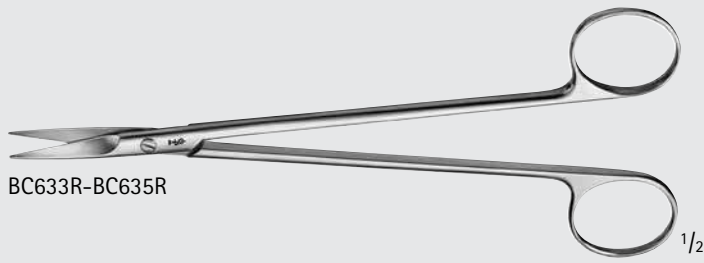

Nerve Dissecting Scissors

Catalog Number	Tip	Blade	Length (in.)
BC628R	S/S	CVD	6

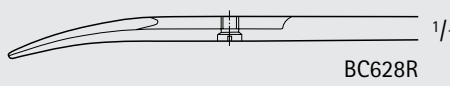

TOENNIS-ADSON Dissecting Scissors

Catalog Number	Tip	Blade	Length (in.)
BC630R	X-DEL	CVD	6 7/8
BC631R	DEL	CVD	6 7/8

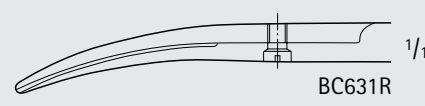
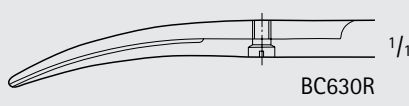
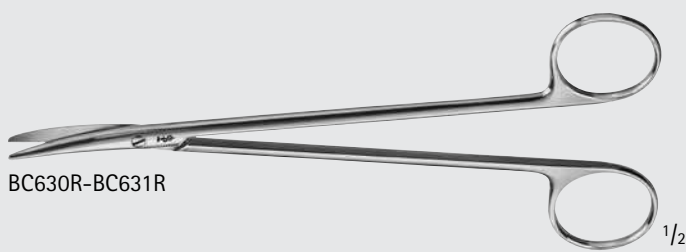

General Surgery

Scissors

GENERAL SURGERY

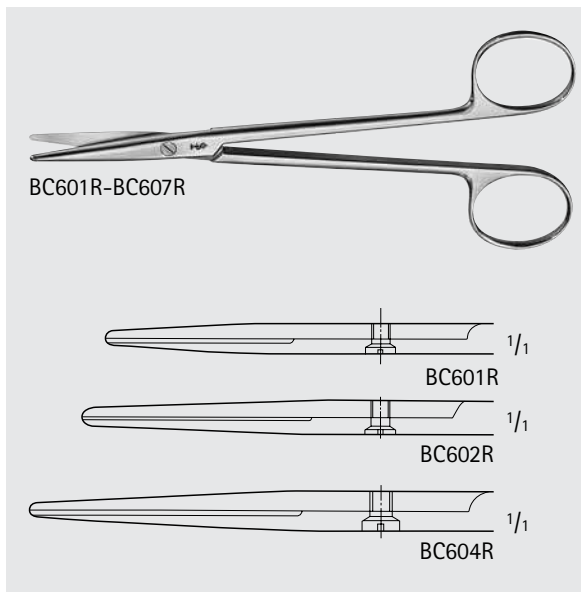

METZENBAUM Dissecting Scissors

Catalog Number	Tip	Blade	Length (in.)
BC601R	B/B	STR	5 3/4
BC602R	B/B	STR	7
BC604R	B/B	STR	7 7/8
BC605R	B/B	CVD	5 3/4
BC606R	B/B	CVD	7
BC607R	B/B	CVD	7 7/8

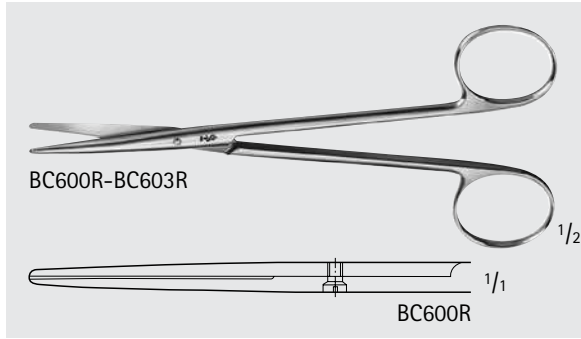
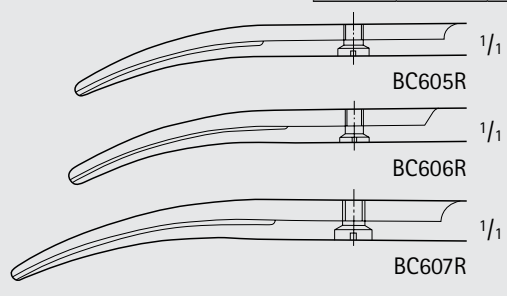

Baby METZENBAUM Dissecting Scissors, Delicate

Catalog Number	Tip	Blade	Length (in.)
BC600R	B/B	STR	5 3/4
BC603R	B/B	CVD	5 3/4

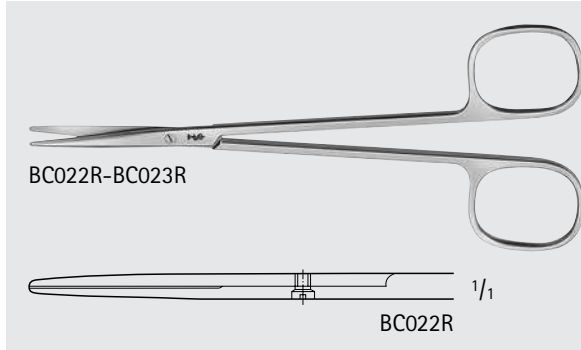
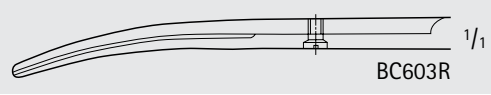

Baby METZENBAUM Dissecting Scissors

Catalog Number	Tip	Blade	Length (in.)
BC022R	B/B	STR	5 3/4
BC023R	B/B	CVD	5 3/4

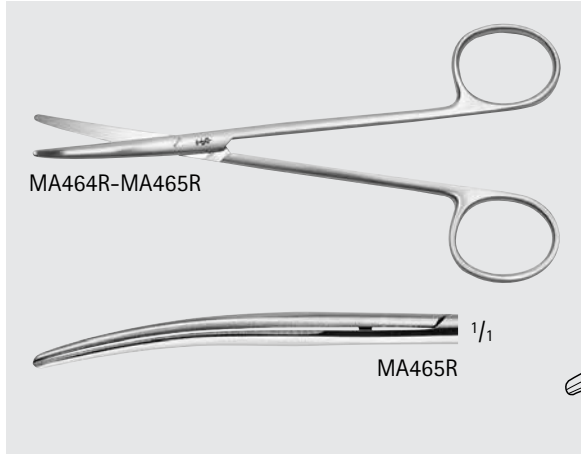

METZENBAUM Scissors, Delicate

Catalog Number	Tip	Blade	Length (in.)
MA464R	B/B	CVD	5 1/2
MA465R	B/B	CVD	8

NELSON-METZENBAUM Dissecting Scissors

Catalog Number	Tip	Blade	Length (in.)
BC611R	B/B	STR	9
BC612R	B/B	STR	9 3/4
BC613R	B/B	STR	11 1/4
BC614R	B/B	STR	12
BC615R	B/B	CVD	9
BC616R	B/B	CVD	9 3/4
BC618R	B/B	CVD	11 1/4
BC619R	B/B	CVD	12
MB926R	B/B	CVD	16

BC611R-BC619R, MB926R

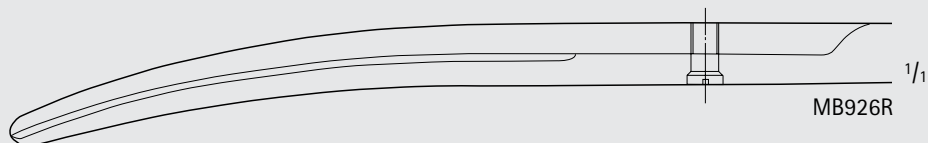
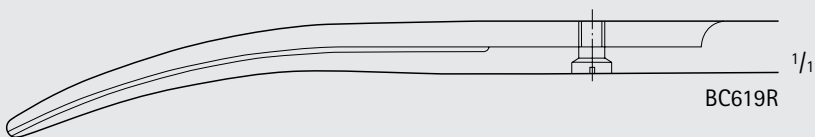
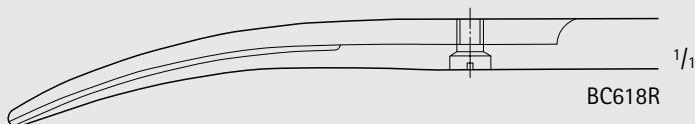
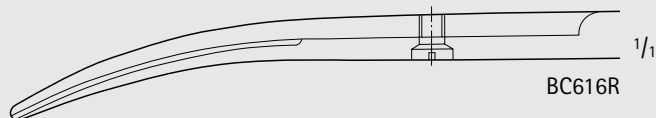
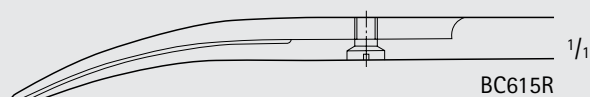
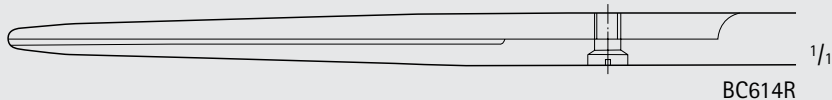
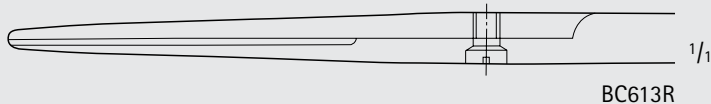
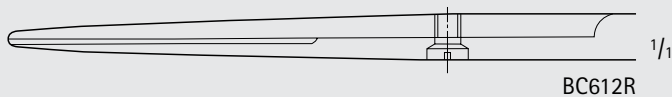
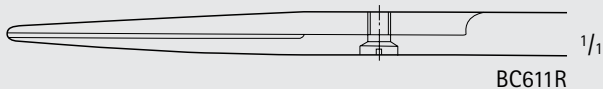
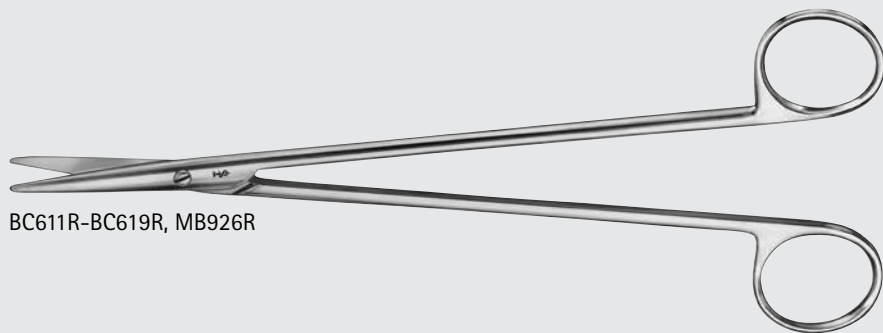

General Surgery

Scissors

GENERAL SURGERY

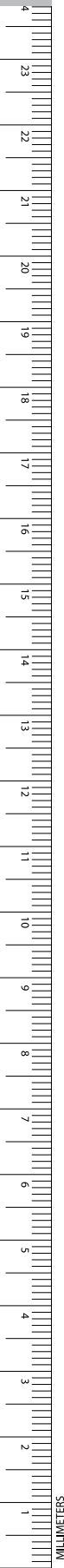

NELSON-METZENBAUM Dissecting Scissors, Delicate

Catalog Number	Tip	Blade	Length (in.)
BC625R	B/B	CVD	13 3/4

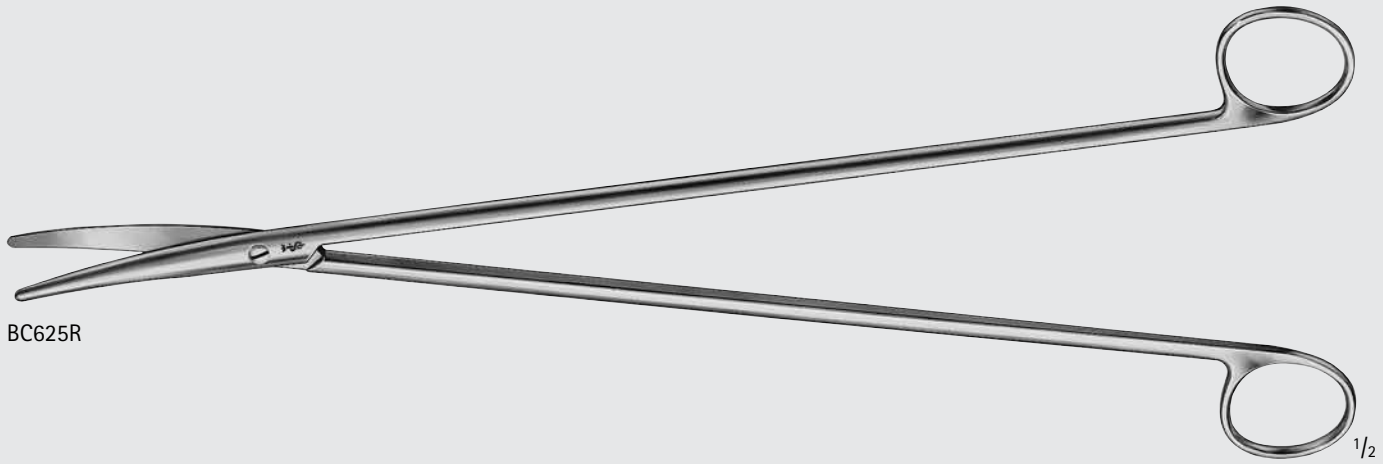

BC625R



BC625R

WELLER Dissecting Scissors

Catalog Number	Tip	Blade	Length (in.)
BC620R	B/B	HEAVY-CVD	11

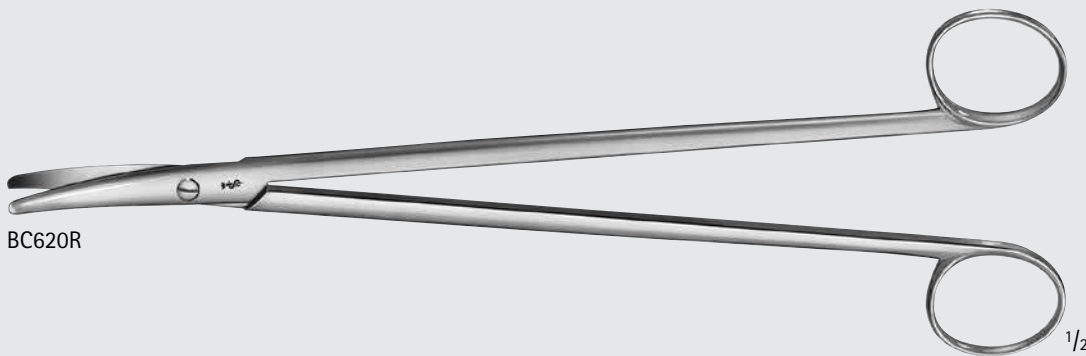

BC620R

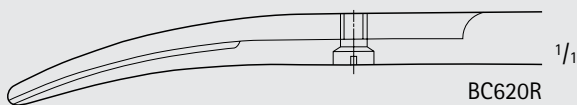

BC620R

Abdominal Scissors

Catalog Number	Tip	Blade	Length (in.)
BC774R	B/B	STR	7

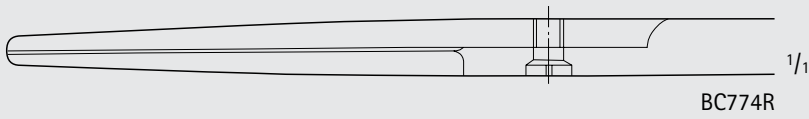

Rectal Scissors

Catalog Number	Tip	Blade	Length (in.)
BC617R	B/B	HEAVY-CVD	12 3/4

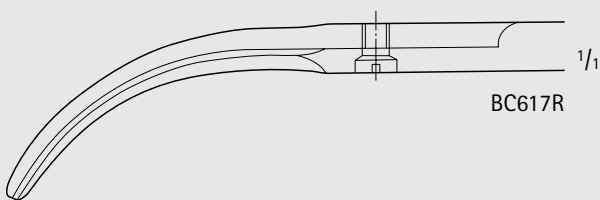
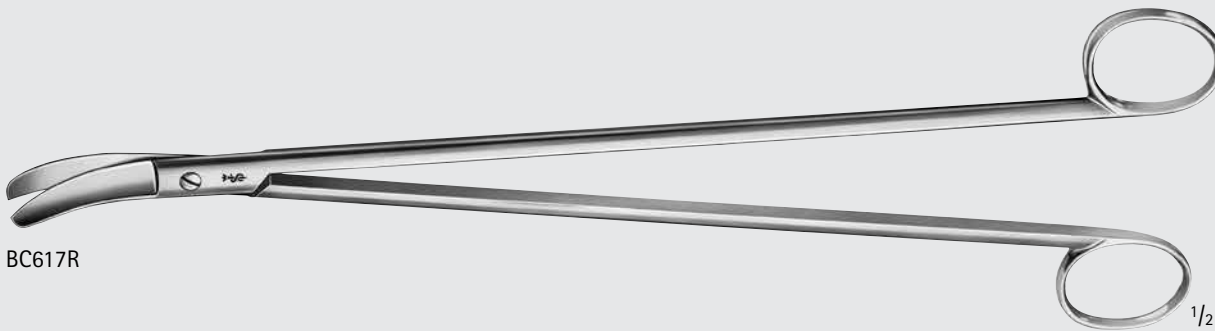

General Surgery

Scissors

GENERAL SURGERY

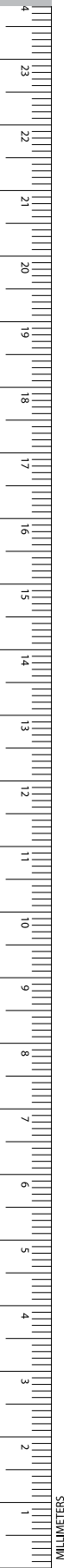

LLOYD-DAVIES Rectal Scissors

Catalog Number	Tip	Blade	Length (in.)
BC621R	B/B	CVD	10 5/8

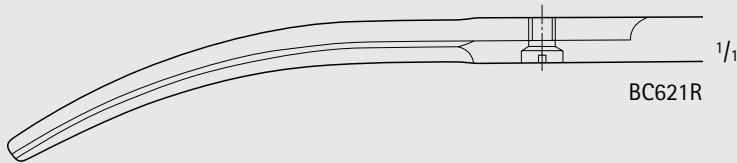
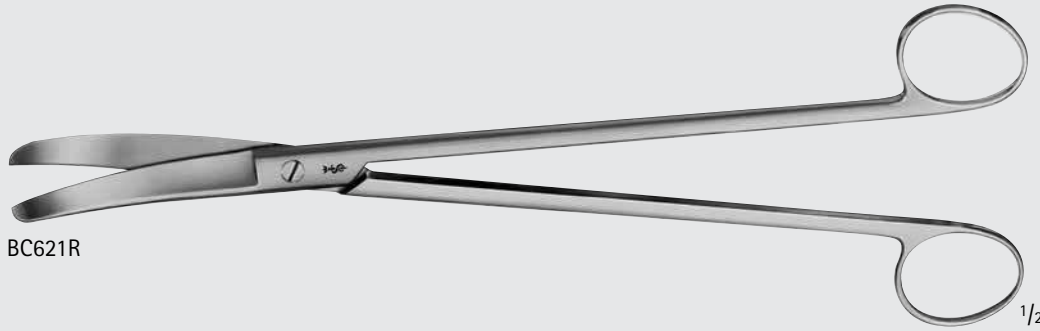

STELZNER Rectal Scissors

Catalog Number	Tip	Blade	Length (in.)
BC622R	B/B	STR	12 1/4
BC623R	B/B	CVD	12 1/4

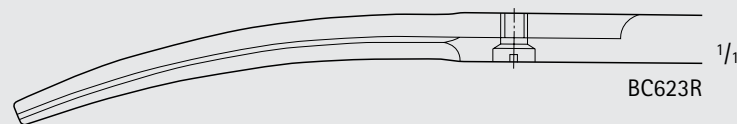
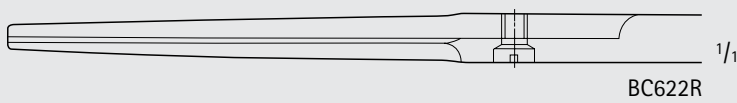
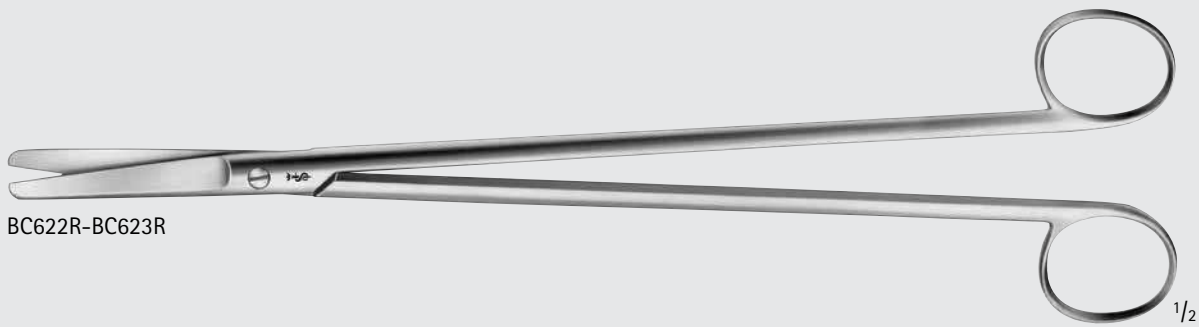

MUELLER Rectal Scissors

Catalog Number	Tip	Blade	Length (in.)
BC627R	B/B	CVD	12 3/4

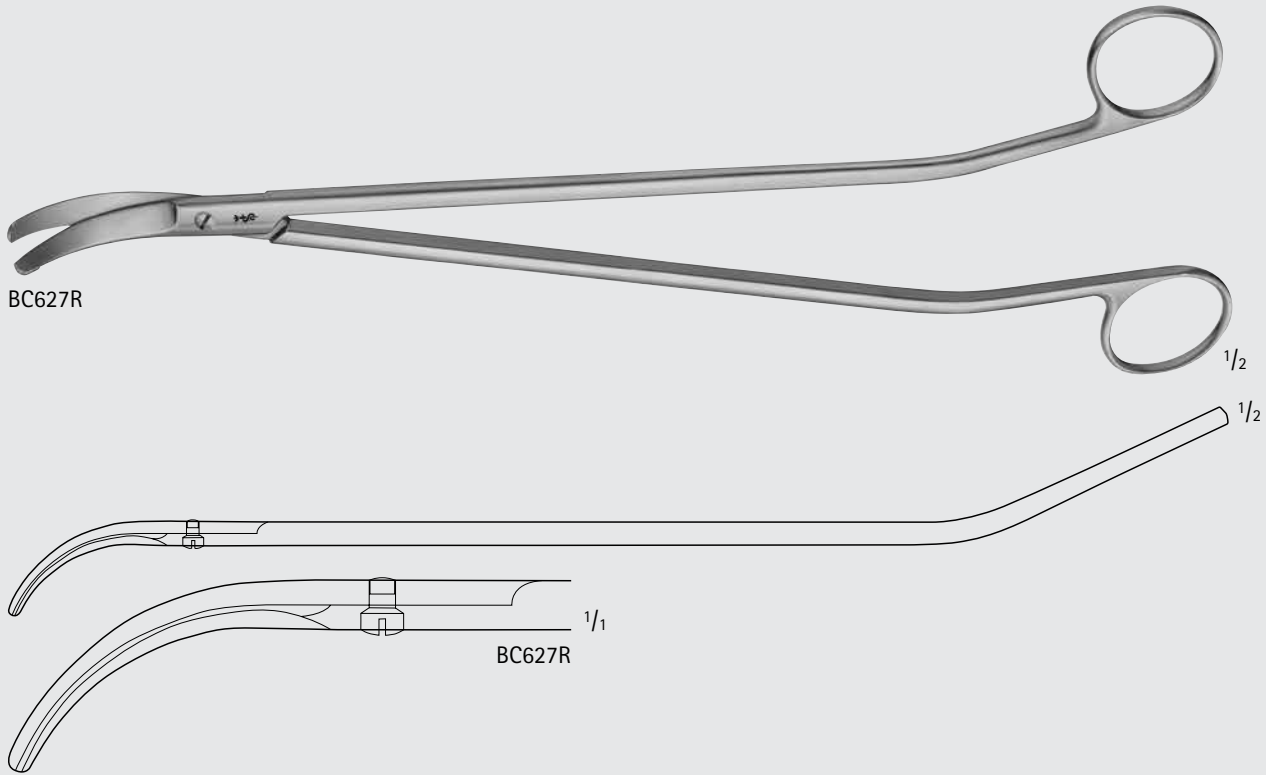

HARVEY Wire Scissors

Catalog Number	Tip	Blade	Length (in.)
BC815R	B/B	SERR	5

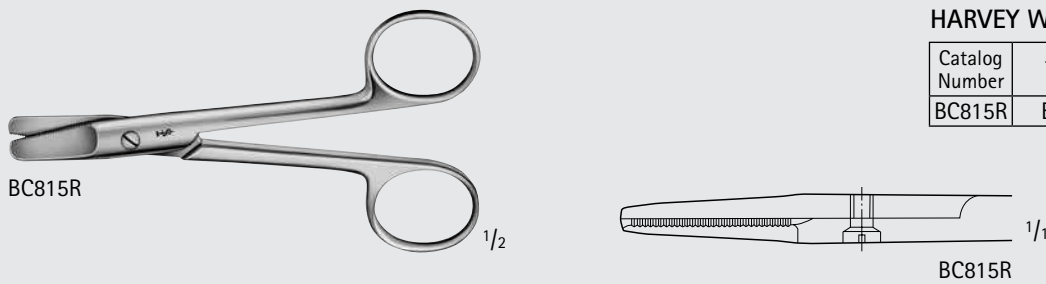

Wire Cutting Scissors

Catalog Number	For Wire Size	Length (in.)
DP551R	SOFT, UP TO 1.2MM AND HARD, UP TO 0.6 MM	4 3/4

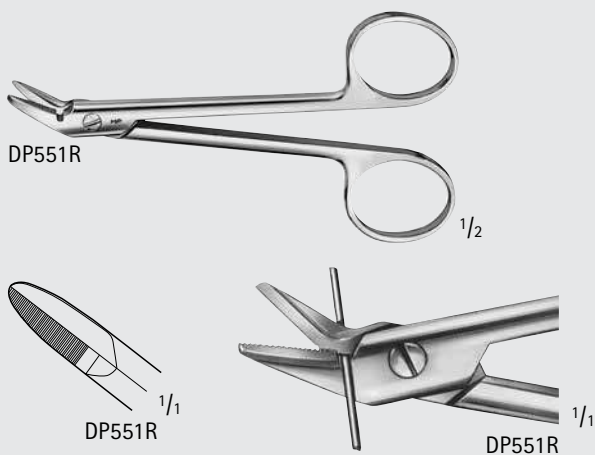

General Surgery

Delicate Scissors

GENERAL SURGERY

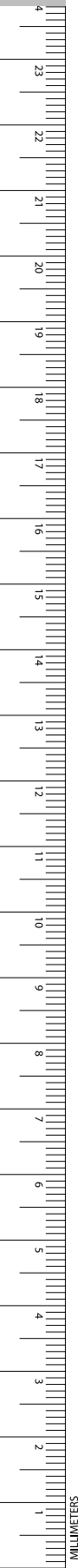

BC064R-BC065R

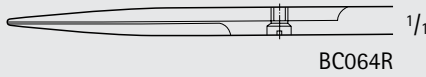

BC064R

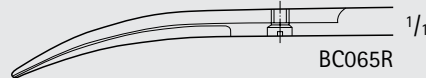

BC065R

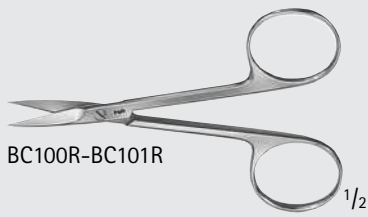

BC100R-BC101R

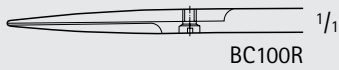

BC100R

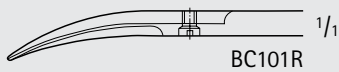

BC101R

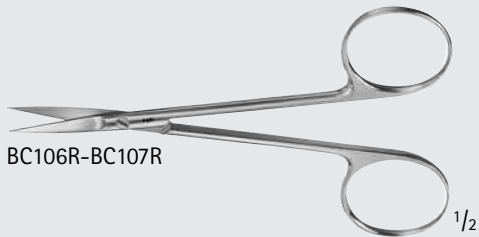

BC106R-BC107R

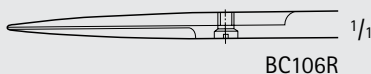

BC106R

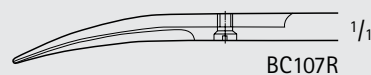

BC107R



BC110R-BC117R

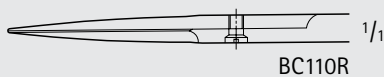

BC110R

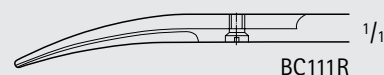

BC111R

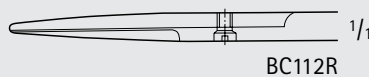

BC112R

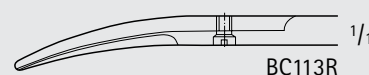

BC113R

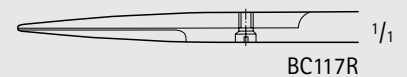

BC117R



BC117R

Iris Scissors

Catalog Number	Tip	Blade	Length (in.)
BC100R	S/S	STR	3 1/2
BC110R	S/S	STR	4 1/4
BC106R	S/S	STR	4 1/2
BC064R	S/S	STR	4 3/4
BC101R	S/S	CVD	3 1/2
BC111R	S/S	CVD	4 1/4
BC107R	S/S	CVD	4 1/2
BC065R	S/S	CVD	4 3/4
BC112R	S/B	STR	4 1/4
BC113R	S/B	CVD	4 1/4
BC117R	S/S	LAT-ANG	4 1/4

REYNOLDS-JAMESON Tenotomy Scissors

Catalog Number	Tip	Blade	Handle	Length (in.)
BC015R	B/B	CVD	SQUARE	5 1/2

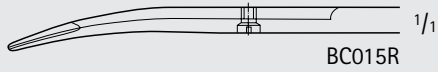
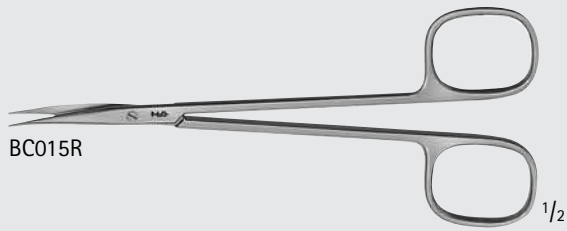

Strabismus Scissors

Catalog Number	Tip	Blade	Length (in.)
BC164R	B/B	STR	4 1/2
BC165R	B/B	CVD	4 1/2

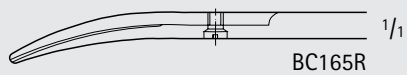
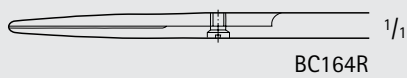

General Surgery

Delicate Scissors

GENERAL
SURGERY

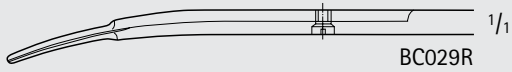
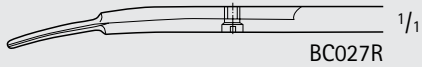
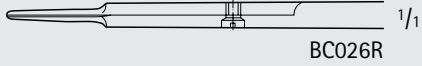
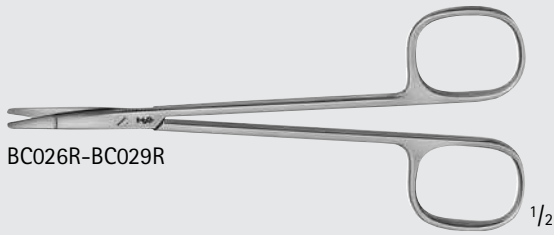

RAGNELL Dissecting Scissors

Catalog Number	Tip	Blade	Length (in.)
BC026R	B/B	STR	5 1/4
BC027R	B/B	CVD	5 1/4
BC029R	B/B	CVD	6

CHADWICK Scissors, Delicate

Catalog Number	Tip	Blade	Length (in.)
BC153R	S/S	CVD	4 1/2

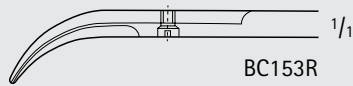
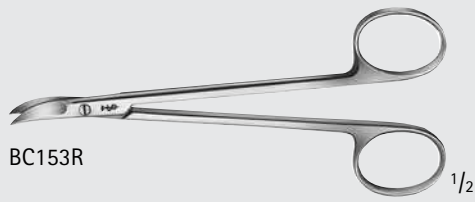

LA GRANGE Scissors

Catalog Number	Tip	Blade	Length (in.)
BC154R	S/S	1-SERR	4 1/4

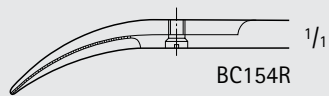

KELLY Scissors

Catalog Number	Tip	Blade	Length (in.)
BC160R	S/S	STR	6 7/8
BC161R	S/S	CVD	6 7/8

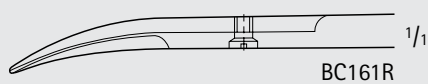
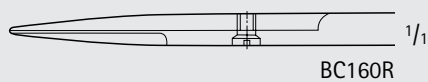
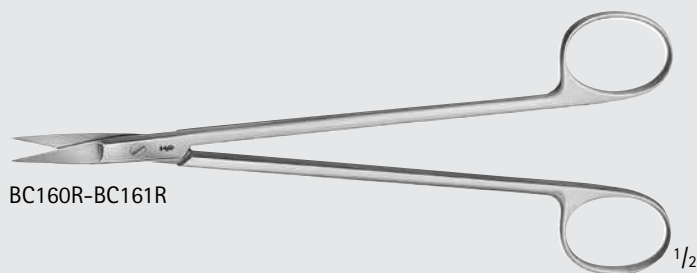

General Surgery

Delicate Scissors

GENERAL SURGERY



MG220R

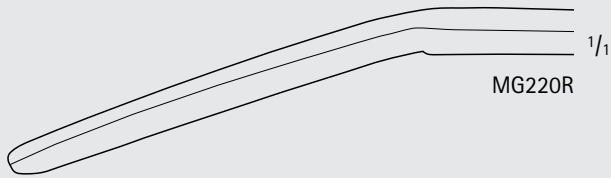

MG220R

ROCHESTER-FERGUSON Scissors

Catalog Number	Tip	Blade	Length (in.)
MG220R	B/B	ANG FLAT	7

DUROTIP Tungsten Carbide Scissors

- Excellent cutting accuracy
- Long working life
- Gold-plated rings

DUROTIP TC Suture Scissors

Catalog Number	Tip	Blade	Length (in.)
BC228R	S/S	STR	5 3/4
BC224R	S/B	STR	5 3/4
BC234R	S/B	CVD	5 3/4



BC228R

1/2

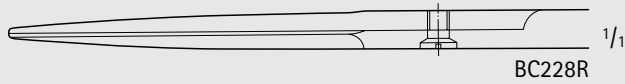

BC228R

1/1



BC224R-BC234R

1/2

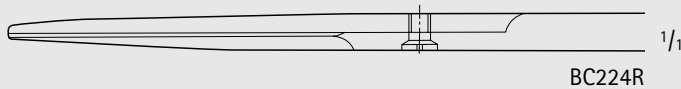

BC224R

1/1

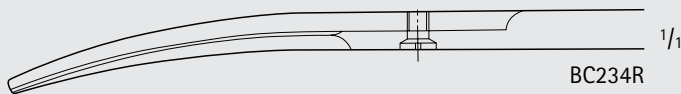

BC234R

1/1

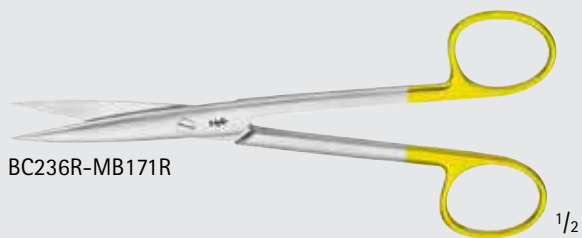

BC236R-MB171R

1/2

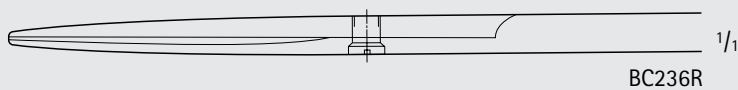

BC236R

1/1



MB171R

1/1

DUROTIP TC Operating Scissors

Catalog Number	Tip	Blade	Length (in.)
BC236R	S/S	STR	5 3/4
MB171R	S/S	CVD	5 3/4



General Surgery
DUROTIP™ TC Scissors

GENERAL SURGERY

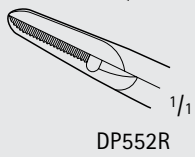
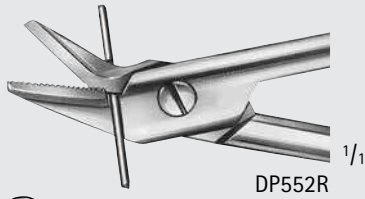
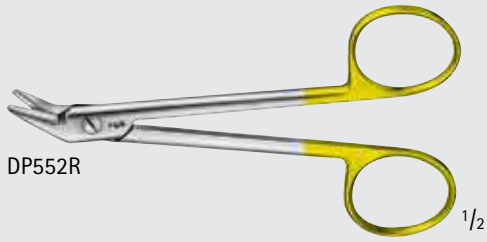
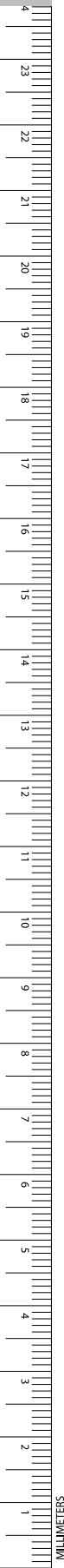

DUROTIP TC Wire Cutting Scissors

Catalog Number	Blade	For Wire Size	Length (in.)
DP552R	1-SERR	SOFT, UP TO 1.2 MM AND HARD, UP TO 0.8 MM	4 3/4

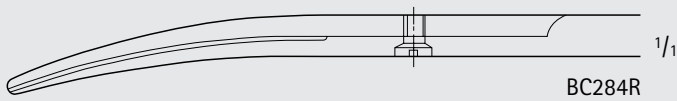
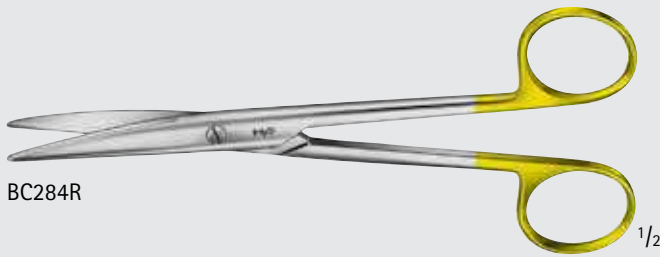

DUROTIP TC MAYO-LEXER Dissecting Scissors, Round Blades

Catalog Number	Tip	Blade	Length (in.)
BC284R	B/B	CVD	6 1/2



BC240R-BC243R

DUROTIP TC MAYO Dissecting Scissors, Round Blades

Catalog Number	Tip	Blade	Length (in.)
BC240R	B/B	STR	5 1/2
BC242R	B/B	STR	6 3/4
BC241R	B/B	CVD	5 1/2
BC243R	B/B	CVD	6 3/4

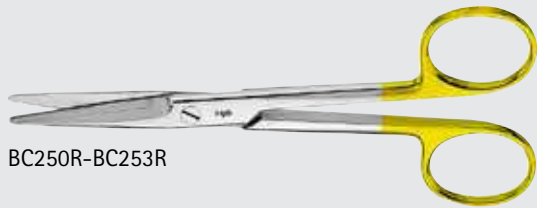
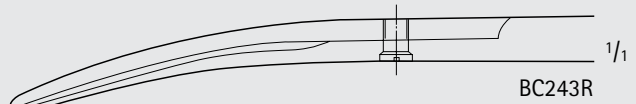
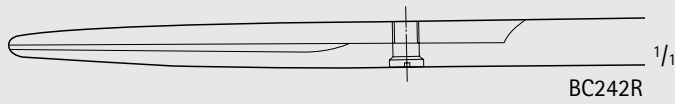
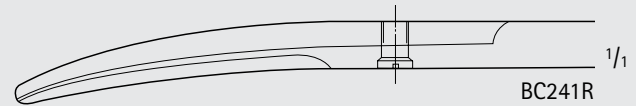
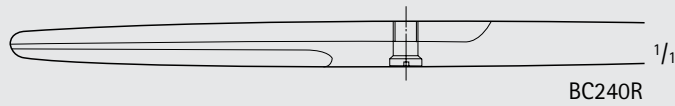

BC250R-BC253R

DUROTIP TC MAYO Dissecting Scissors, Beveled Blades

Catalog Number	Tip	Blade	Length (in.)
BC250R	B/B	STR	5 1/2
BC252R	B/B	STR	6 3/4
BC251R	B/B	CVD	5 1/2
BC253R	B/B	CVD	6 3/4

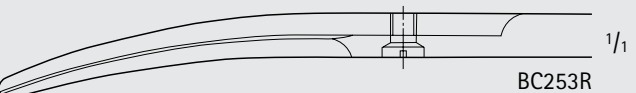
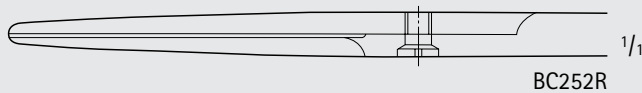
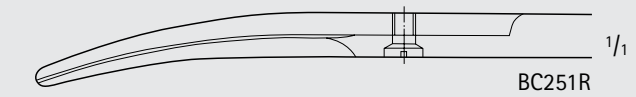
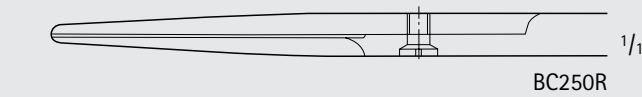

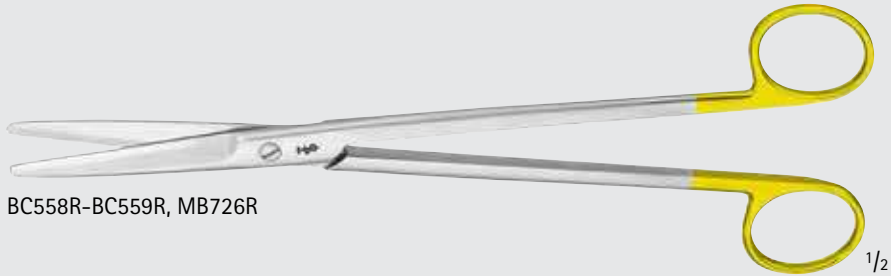

BC558R-BC559R, MB726R

DUROTIP TC MAYO Dissecting Scissors

Catalog Number	Tip	Blade	Length (in.)
BC558R	B/B	STR	9
MG215R	B/B	STR	14
BC559R	B/B	CVD	9
MB726R	B/B	CVD	14

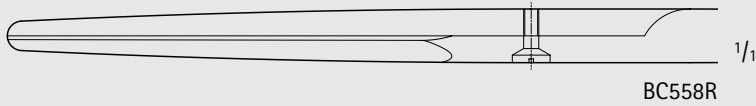

BC558R

1/1

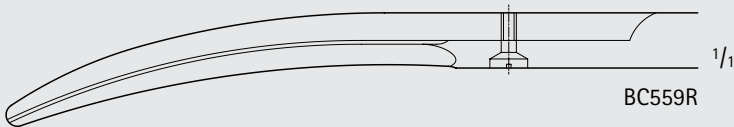

BC559R

1/1

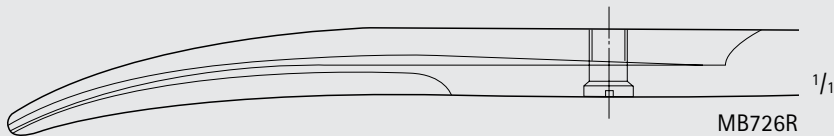

MB726R

1/1

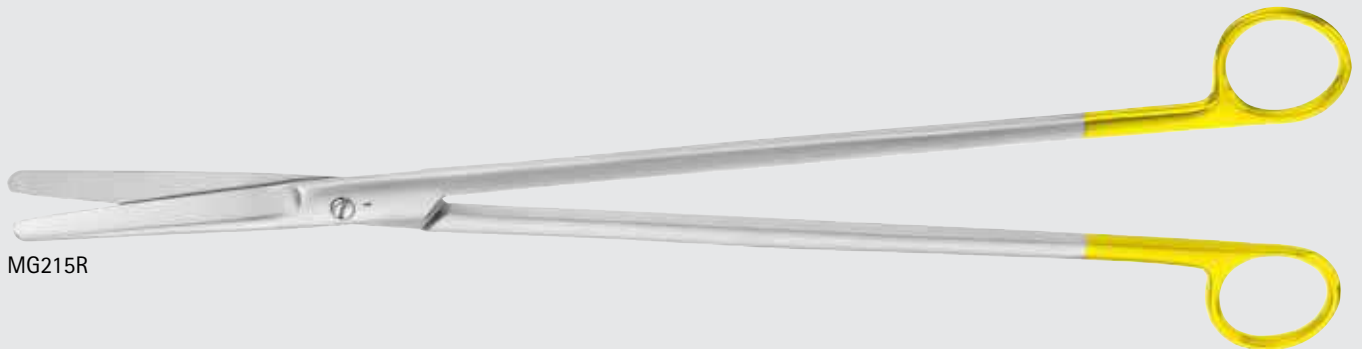

MG215R

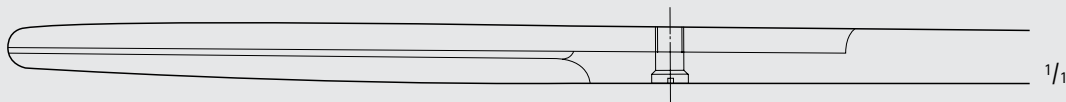

MG215R

1/1

DUROTIP TC METZENBAUM Dissecting Scissors, Delicate

Catalog Number	Tip	Blade	Length (in.)
MB205R	S/S	STR	9 1/4
MB207R	S/S	CVD	5 3/4
MD496	S/S	CVD	7
MB206R	S/S	CVD	9 1/4

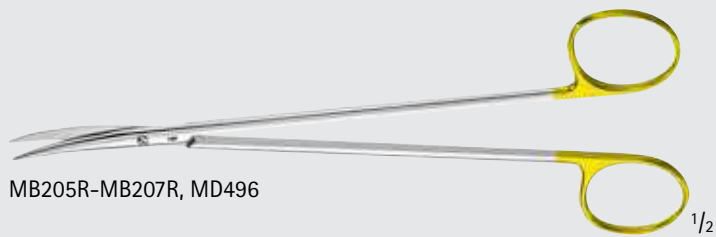

MB205R-MB207R, MD496

1/2



MB205R

1/1



MB207R

1/1



MD496

1/1

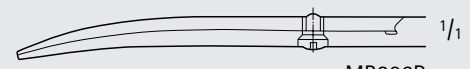

MB206R

1/1



BC260R-BC265R

DUROTIP TC METZENBAUM Dissecting Scissors

Catalog Number	Tip	Blade	Length (in.)
BC260R	B/B	STR	5 3/4
BC262R	B/B	STR	7
BC261R	B/B	CVD	5 3/4
BC263R	B/B	CVD	7
BC265R	B/B	CVD	7 7/8



BC260R

1/1

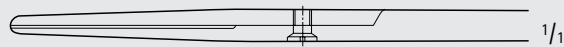

BC262R

1/1

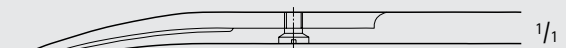

BC261R

1/1

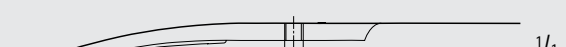

BC263R

1/1



BC265R



1/1



INCHES

General Surgery
DUROTIP™ TC Scissors

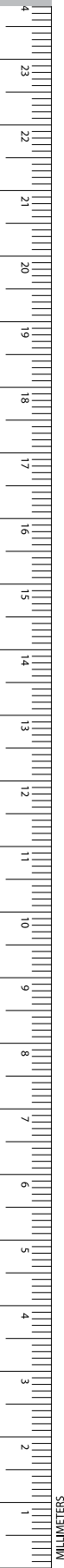
GENERAL SURGERY

BC287R

1/2

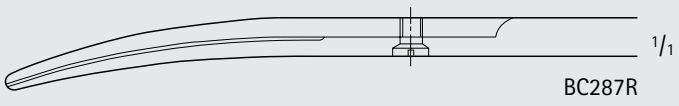

1/1
BC287R

Catalog Number	Tip	Blade	Length (in.)
BC287R	B/B	CVD	9

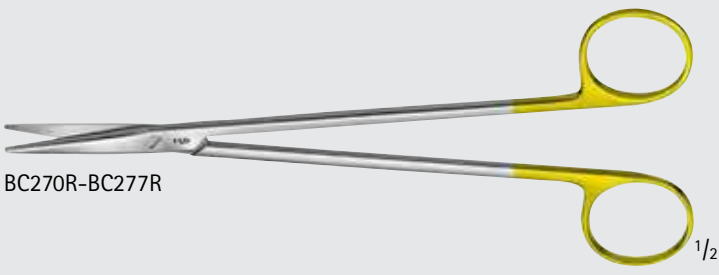

BC270R-BC277R

1/2

Catalog Number	Tip	Blade	Length (in.)
BC270R	B/B	STR	7
BC274R	B/B	STR	7 7/8
BC276R	B/B	STR	9
BC271R	B/B	CVD	7
BC275R	B/B	CVD	7 7/8
BC277R	B/B	CVD	9

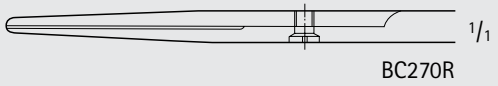

1/1
BC270R

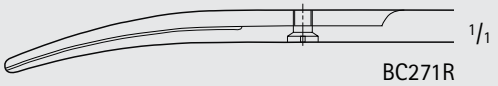

1/1
BC271R

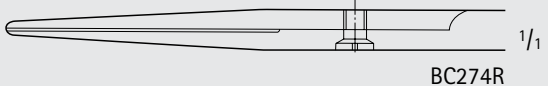

1/1
BC274R

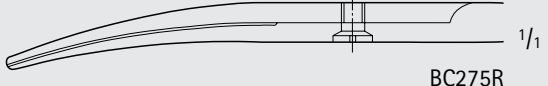

1/1
BC275R

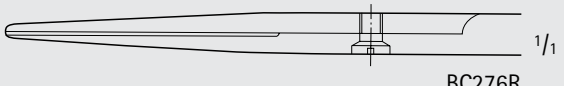

1/1
BC276R

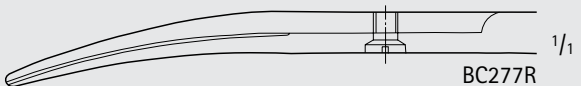

1/1
BC277R

DUROTIP TC Baby METZENBAUM Dissecting Scissors, Delicate

BC258R-BC259R



Catalog Number	Tip	Blade	Length (in.)
BC258R	B/B	STR	5 3/4
BC259R	B/B	CVD	5 3/4

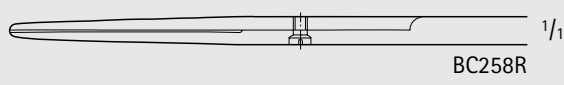
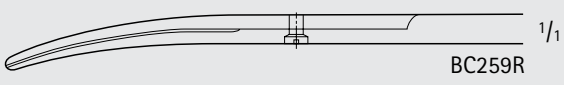

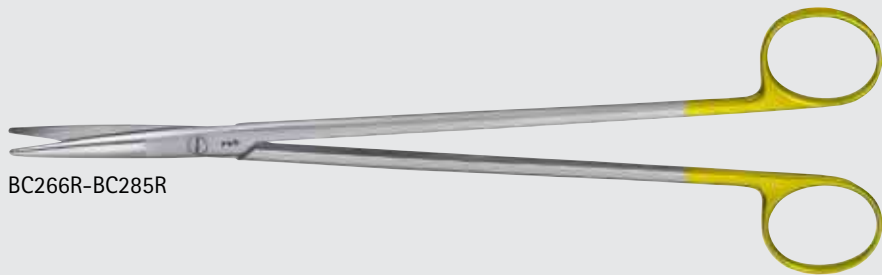

DUROTIP TC NELSON-METZENBAUM Dissecting Scissors

BC266R-BC285R

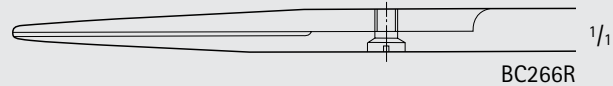
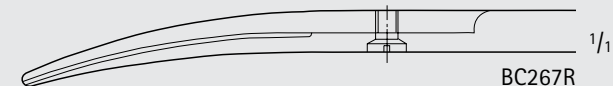
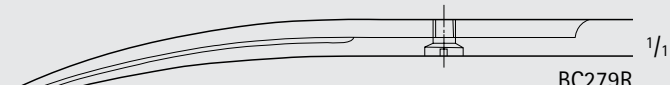
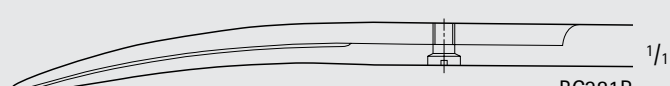
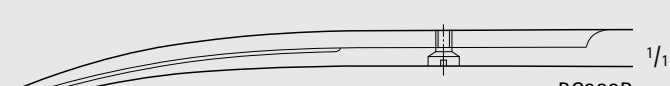
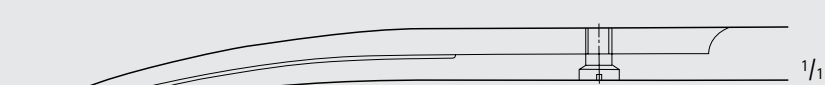
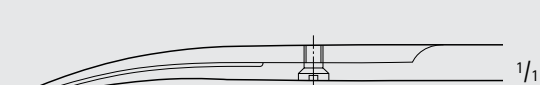

Catalog Number	Tip	Blade	Length (in.)
BC266R	B/B	STR	9
BC267R	B/B	CVD	9
BC279R	B/B	CVD	10 1/4
BC281R	B/B	CVD	11
BC282R	B/B	CVD	11 1/4
BC289R	B/B	CVD	11 3/4
BC285R	B/B	CVD	13 3/4



General Surgery
DUROTIP™ TC Scissors

GENERAL SURGERY

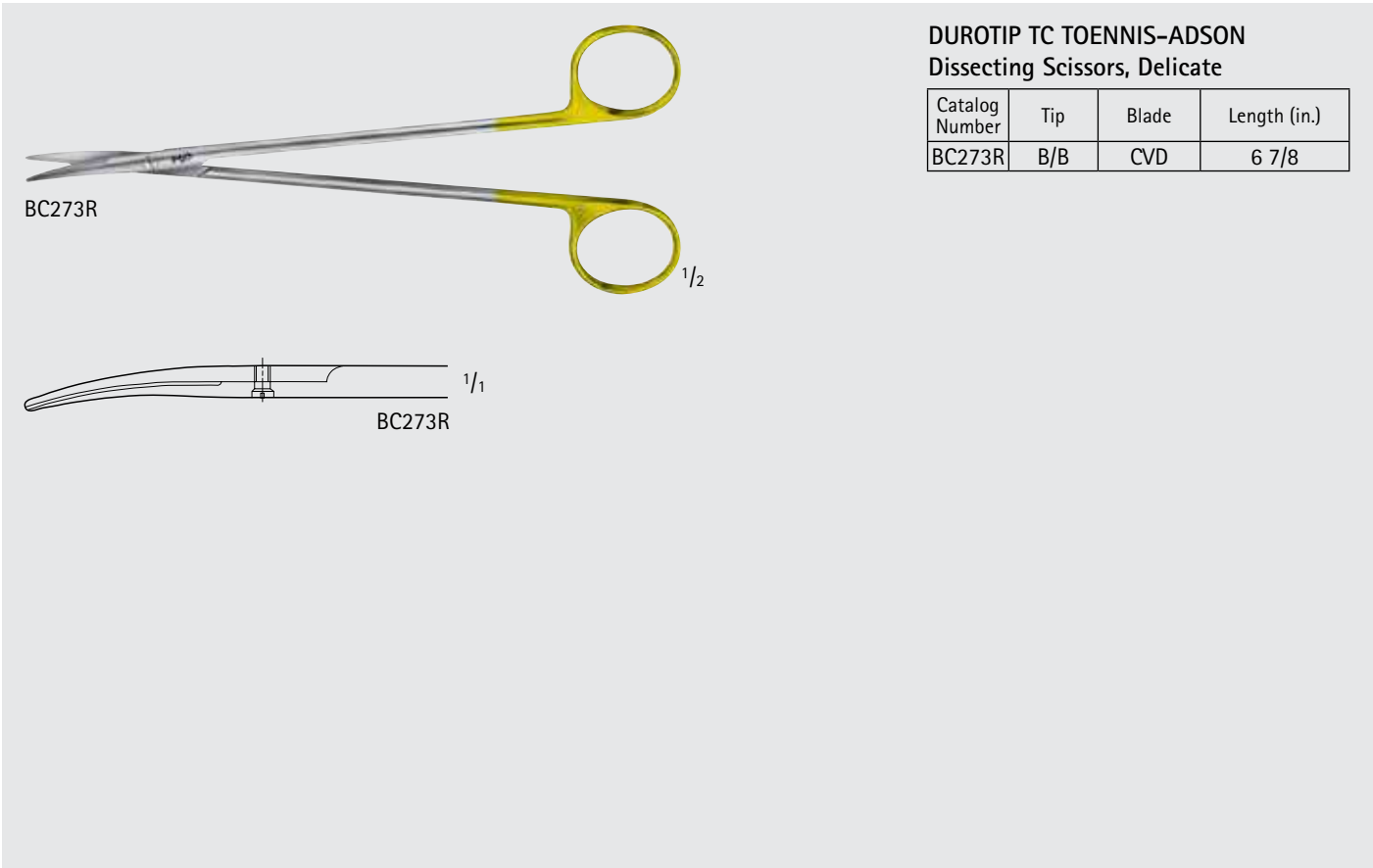
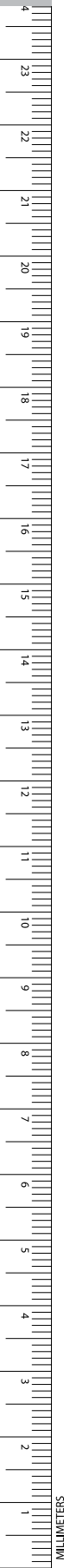

DUROTIP TC TOENNIS-ADSON
Dissecting Scissors, Delicate

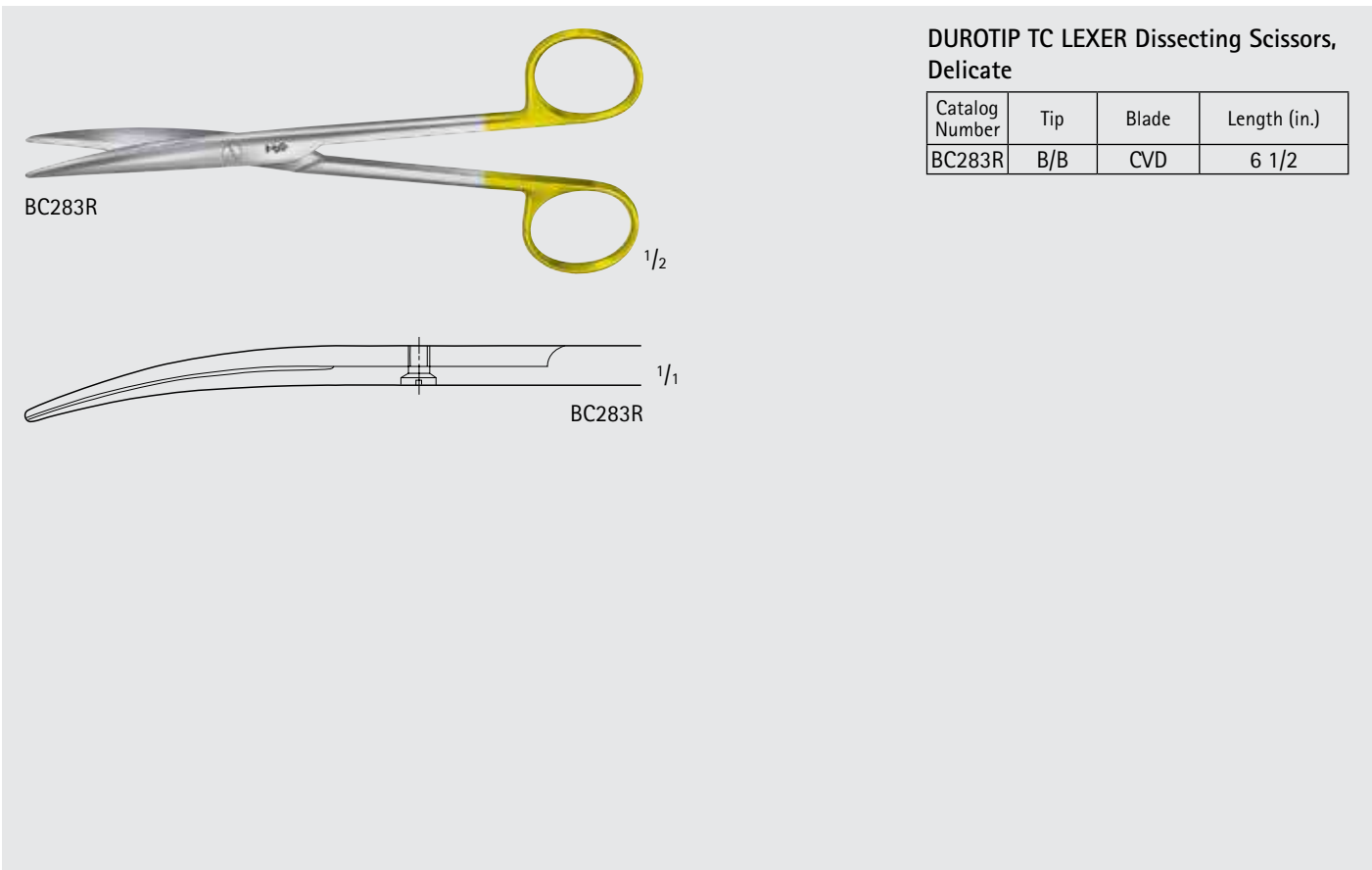
Catalog Number	Tip	Blade	Length (in.)
BC273R	B/B	CVD	6 7/8



DUROTIP TC LEXER Dissecting Scissors, Delicate

Catalog Number	Tip	Blade	Length (in.)
BC283R	B/B	CVD	6 1/2



Wavecut

- Wavecut scissors have one serrated cutting edge to prevent tissue from slipping. The W after the item number indicates the scissors are the wavecut style, e.g. BC211W.



DUROTIP TC MAYO Wavecut Dissecting Scissors, Beveled Blades

Catalog Number	Tip	Blade	Length (in.)
BC253W	B/B	CVD	6 3/4

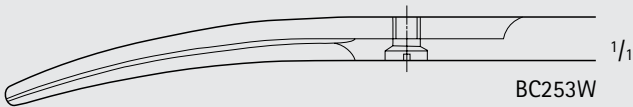

DUROTIP TC Baby METZENBAUM Wavecut Dissecting Scissors, Delicate

Catalog Number	Tip	Blade	Length (in.)
BC259W	B/B	CVD	5 3/4

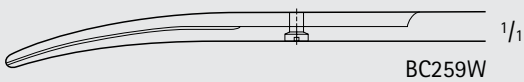

General Surgery
DUROTIP™ TC Scissors

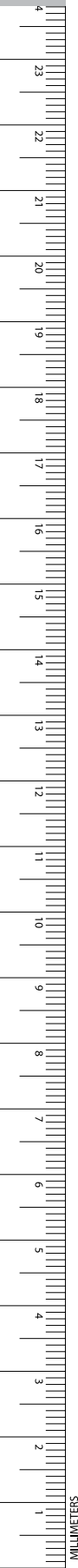

DUROTIP TC METZENBAUM Wavecut Dissecting Scissors

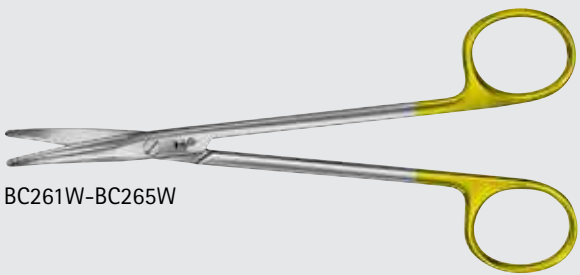

BC261W-BC265W

Catalog Number	Tip	Blade	Length (in.)
BC261W	B/B	CVD	5 3/4
BC263W	B/B	CVD	7
BC265W	B/B	CVD	7 7/8

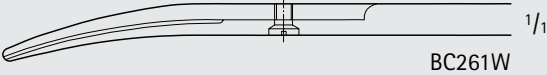

BC261W 1/1

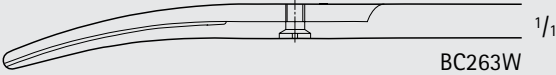

BC263W 1/1

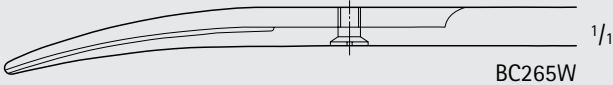

BC265W 1/1

DUROTIP TC METZENBAUM Wavecut Dissecting Scissors, Delicate

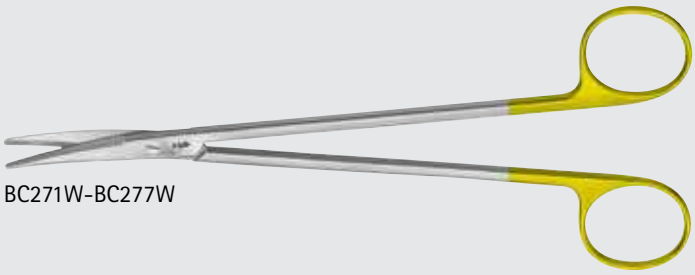

BC271W-BC277W

Catalog Number	Tip	Blade	Length (in.)
BC271W	B/B	CVD	7
BC275W	B/B	CVD	7 7/8
BC277W	B/B	CVD	9

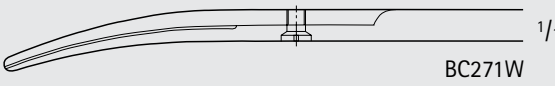

BC271W 1/1

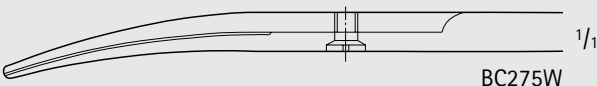

BC275W 1/1

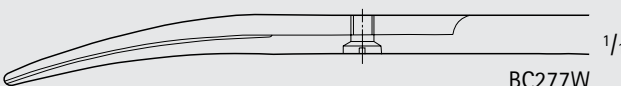

BC277W 1/1

DUROTIP TC METZENBAUM Wavecut Dissecting Scissors, Heavy

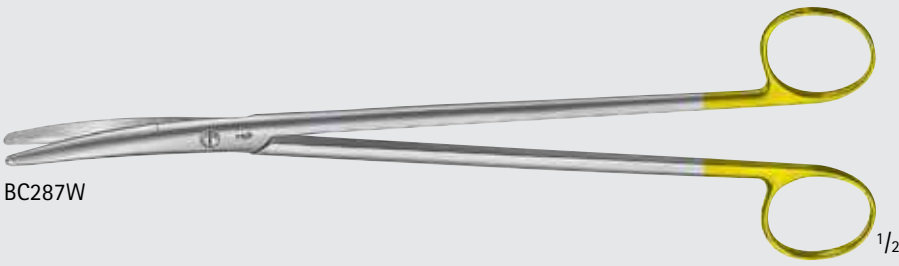

BC287W

Catalog Number	Tip	Blade	Length (in.)
BC287W	B/B	CVD	9

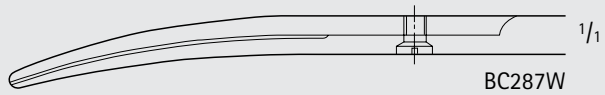

BC287W 1/1

DUROTIP TC TOENNIS-ADSON Wavecut Dissecting Scissors

Catalog Number	Tip	Blade	Length (in.)
BC273W	B/B	CVD	6 7/8

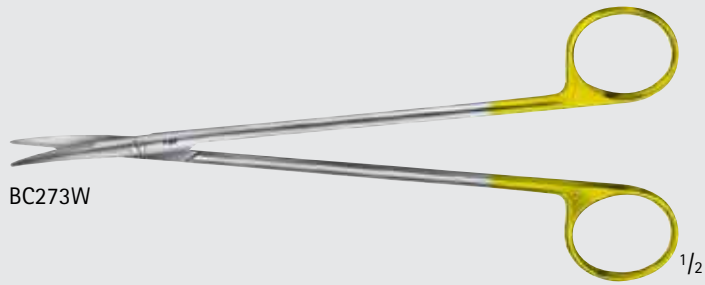

BC273W

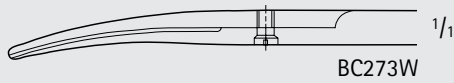

BC273W

DUROTIP TC NELSON-METZENBAUM Wavecut Dissecting Scissors

Catalog Number	Tip	Blade	Length (in.)
BC267W	B/B	CVD	9
BC279W	B/B	CVD	10 1/4
BC281W	B/B	CVD	11

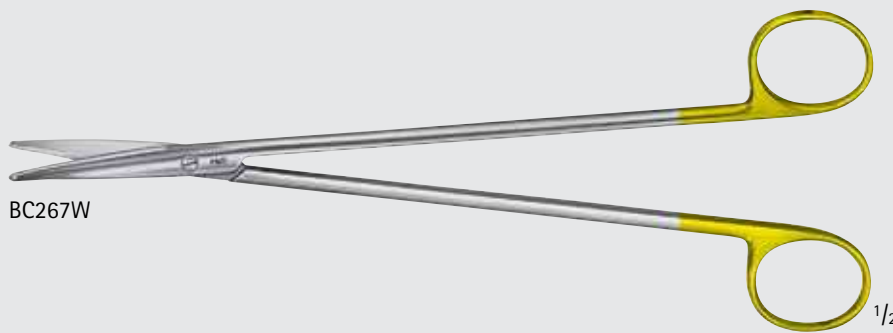

BC267W

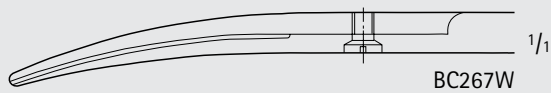

BC267W

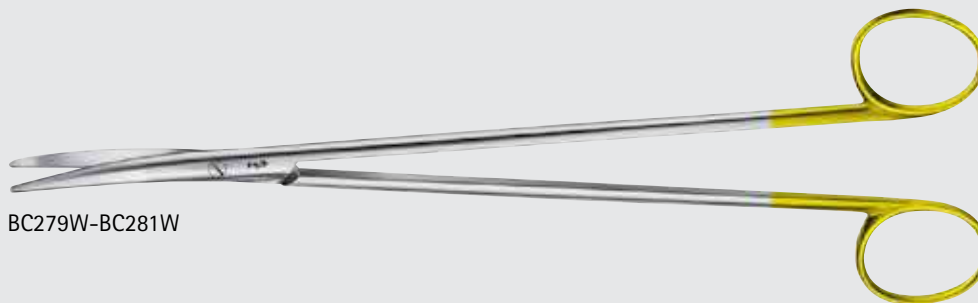

BC279W-BC281W

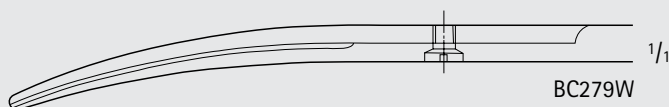

BC279W

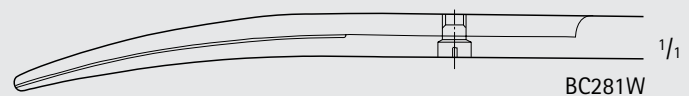

BC281W



INCHES

General Surgery
DUROTIP™ TC Scissors

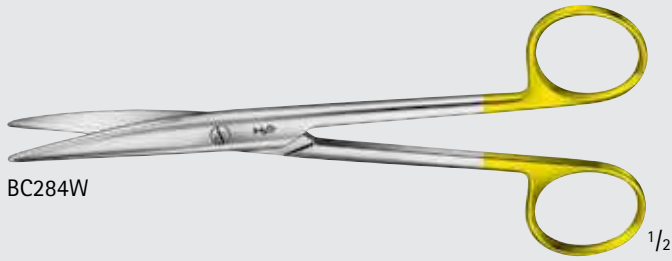

BC284W

1/2

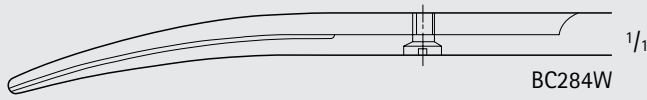

BC284W

1/1

DUROTIP TC MAYO-LEXER Wavecut Scissors

Catalog Number	Tip	Blade	Length (in.)
BC284W	B/B	CVD	6 1/2

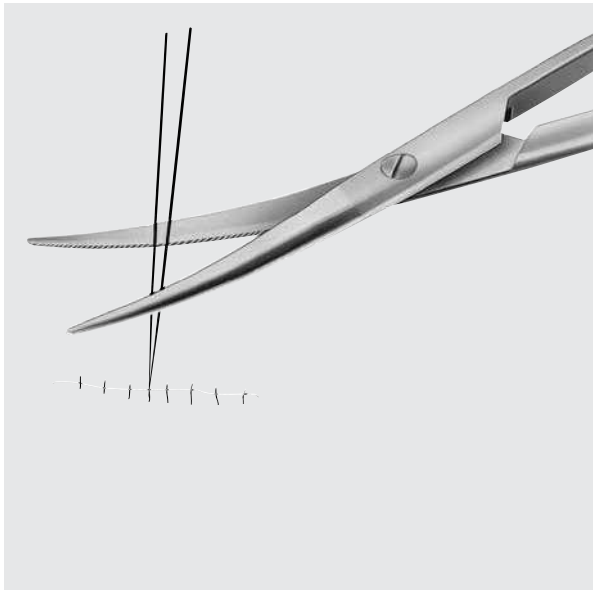

DUROTIP TC Ligature Scissors

- Carbide inserts guarantee permanent sharp cutting edge (also in the distal area of the blades).
- Wavecut prevents suture materials from slipping.
- Identified by 1 gold-plated ring.



BC294W-BC298W

DUROTIP TC Ligature Wavecut Scissors

Catalog Number	Tip	Blade	Length (in.)
BC294W	B/B	CVD	5 3/4
BC295W	B/B	CVD	7
BC296W	B/B	CVD	9
BC297W	B/B	CVD	10 1/4
BC298W	B/B	CVD	13 3/4

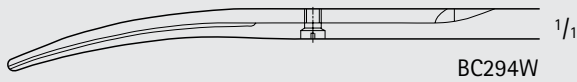

BC294W

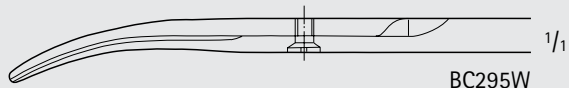

BC295W

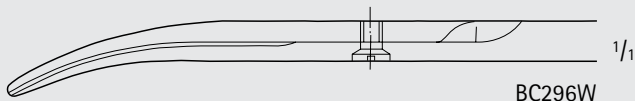

BC296W

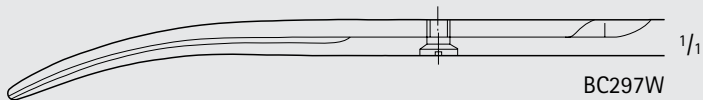

BC297W

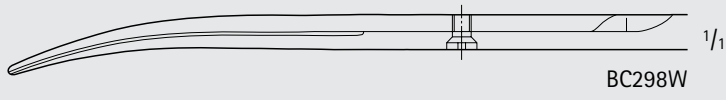

BC298W



General Surgery

SuperCut Scissors

SuperCut Scissors

Your everyday black handle scissors

- **Microtome Edge**
 - Razor sharp cutting edge facilitates gentle cutting with minimal force
- **Wavecut Blade**
 - Prevents tissue from slipping out during the cutting process

For more information about SuperCut Scissors see brochure number **DOC821**.



BC900R-BC901R

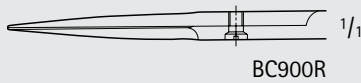

BC900R

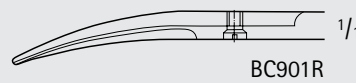

BC901R

Iris SuperCut Scissors, Delicate

Catalog Number	Tip	Blade	Length (in.)
BC900R	S/S	STR	4 1/4
BC901R	S/S	CVD	4 1/4



BC903R

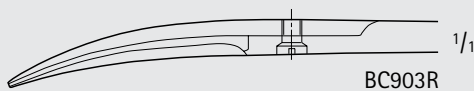

BC903R

SuperCut Plastic Standard Scissors

Catalog Number	Tip	Blade	Length (in.)
BC903R	S/S	CVD	5



BC904R-BC905R

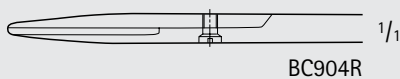

BC904R

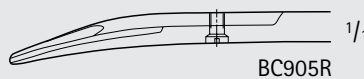

BC905R

STEVENS SuperCut Scissors

Catalog Number	Tip	Tip Size (mm)	Blade	Length (in.)
BC904R	B/B	12	STR	4 1/8
BC905R	B/B	12	CVD	4 1/8

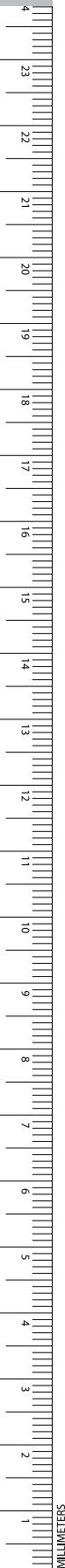

STEVENS SuperCut Scissors (continued)

Catalog Number	Tip	Tip Size (mm)	Blade	Length (in.)
BC906R	B/B	13	STR	4 1/4
BC907R	B/B	13	CVD	4 1/4

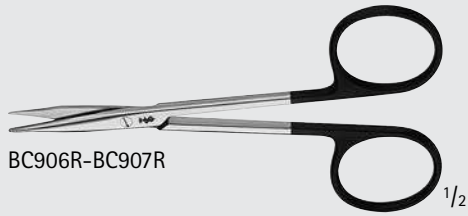

BC906R-BC907R

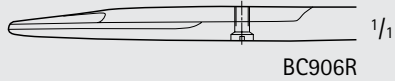

BC906R

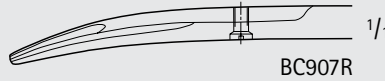

BC907R

GOLDMANN-FOX SuperCut Scissors

Catalog Number	Tip	Blade	Length (in.)
BC909R	S/S	CVD	5 1/8



BC909R



BC909R



INCHES

General Surgery

SuperCut Scissors

GENERAL SURGERY

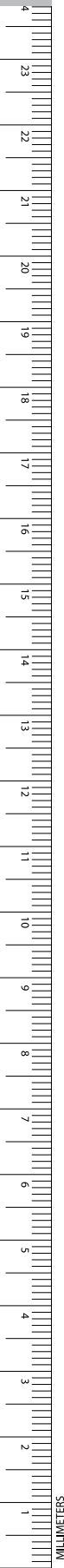

JAMESON SuperCut Scissors, Delicate

Catalog Number	Tip	Blade	Length (in.)
BC911R	B/B	CVD	5 1/8
BC915R	B/B	CVD	6
BC919R	B/B	CVD	7

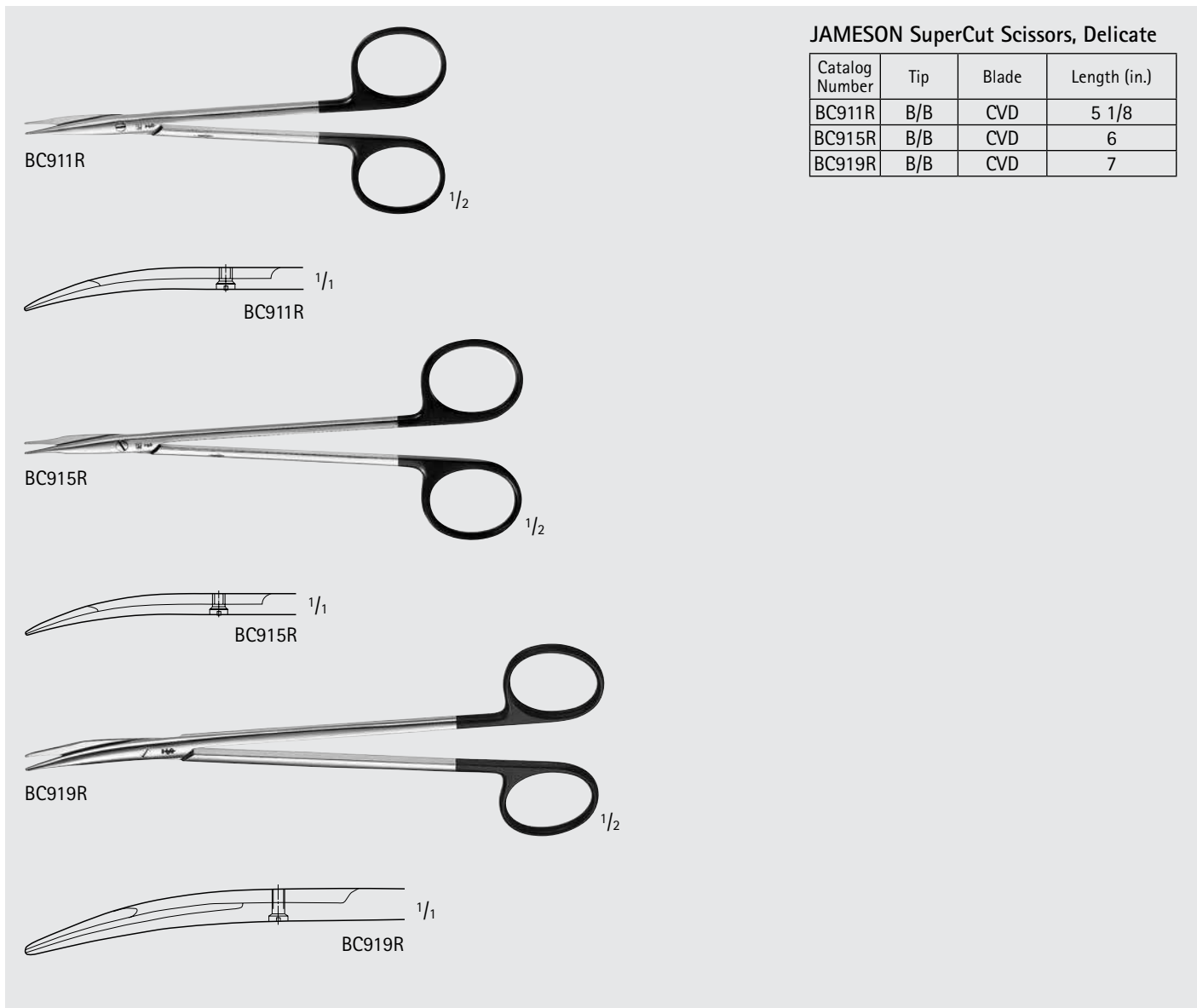

BC911R $1/2$

BC911R $1/1$

BC915R $1/2$

BC915R $1/1$

BC919R $1/2$

BC919R $1/1$

JOSEPH SuperCut Scissors, Delicate

Catalog Number	Tip	Blade	Length (in.)
BC916R	S/S	STR	6
BC917R	S/S	CVD	6

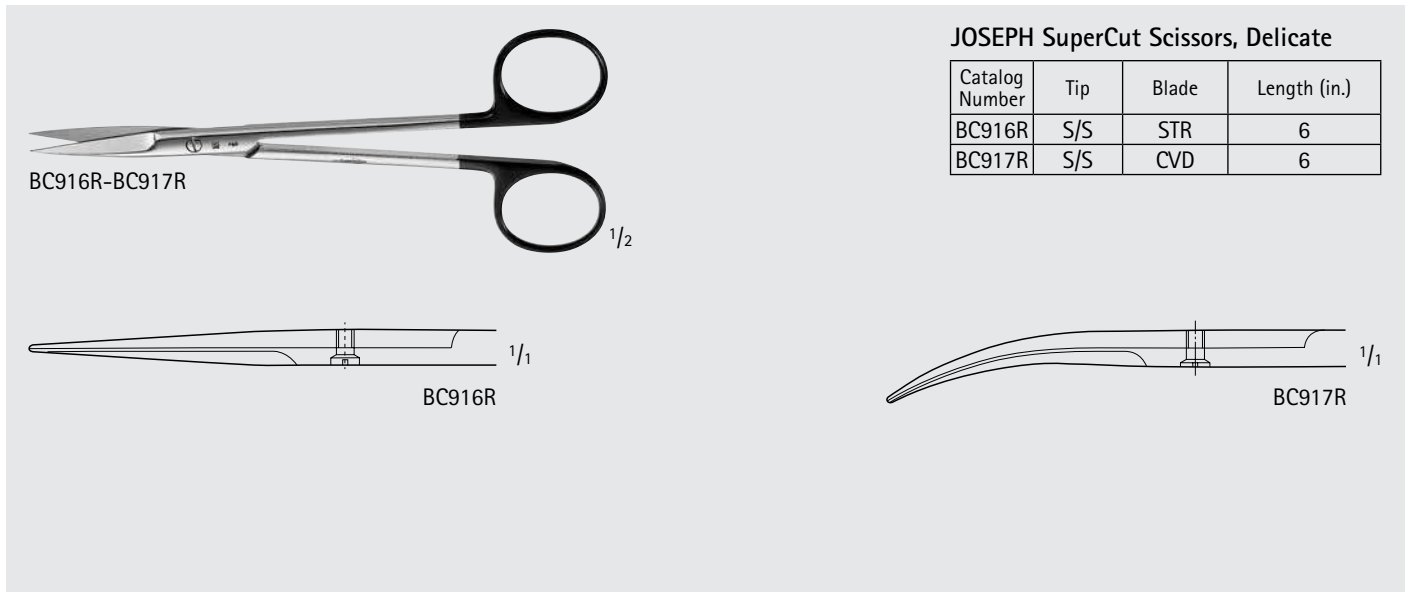

BC916R-BC917R $1/2$

BC916R $1/1$

BC917R $1/1$

GORNEY SuperCut Scissors, Delicate

Catalog Number	Tip	Blade	Length (in.)
BC920R	B/B	STR	7 3/4
BC921R	B/B	CVD	7 3/4

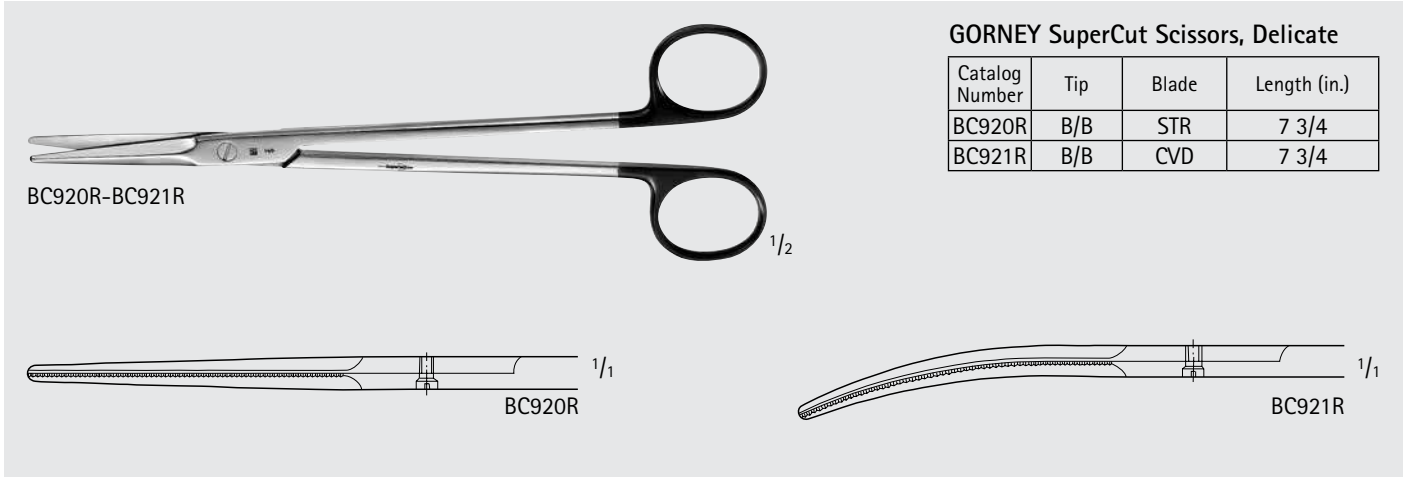

BC920R-BC921R

BC920R

BC921R

KAYE SuperCut Facelift Scissors, Delicate

Catalog Number	Tip	Blade	Length (in.)
BC933R	B/B	CVD	7 3/4

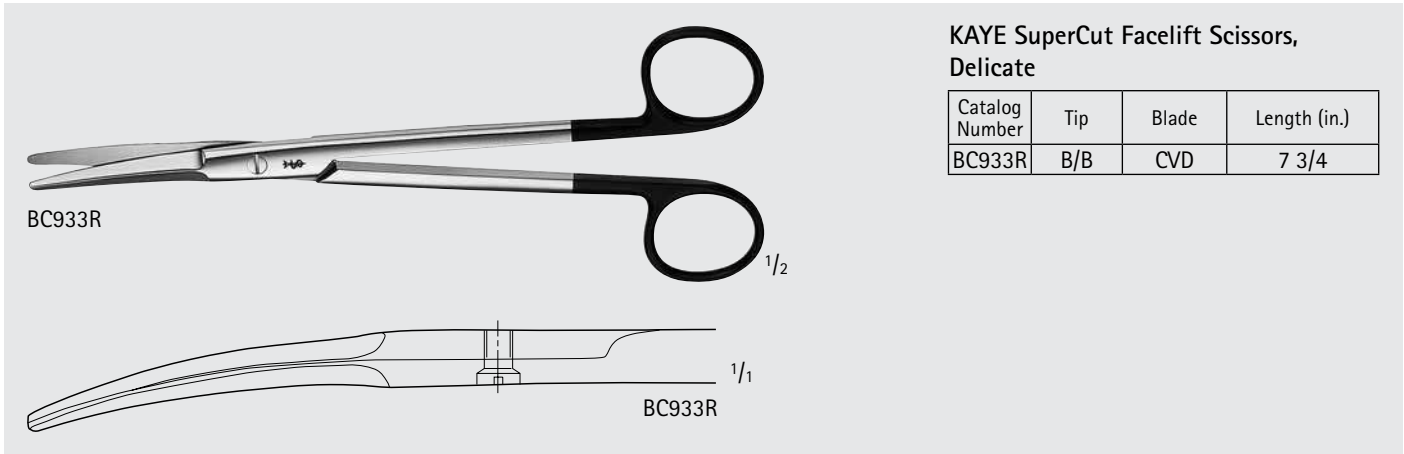

BC933R

BC933R

MAYO SuperCut Scissors, Delicate

Catalog Number	Tip	Blade	Length (in.)
BC926R	B/B	STR, BEVELED	5 3/4
BC927R	B/B	CVD, BEVELED	5 3/4
BC924R	B/B	STR, ROUND	6 1/2
BC925R	B/B	CVD, ROUND	6 1/2

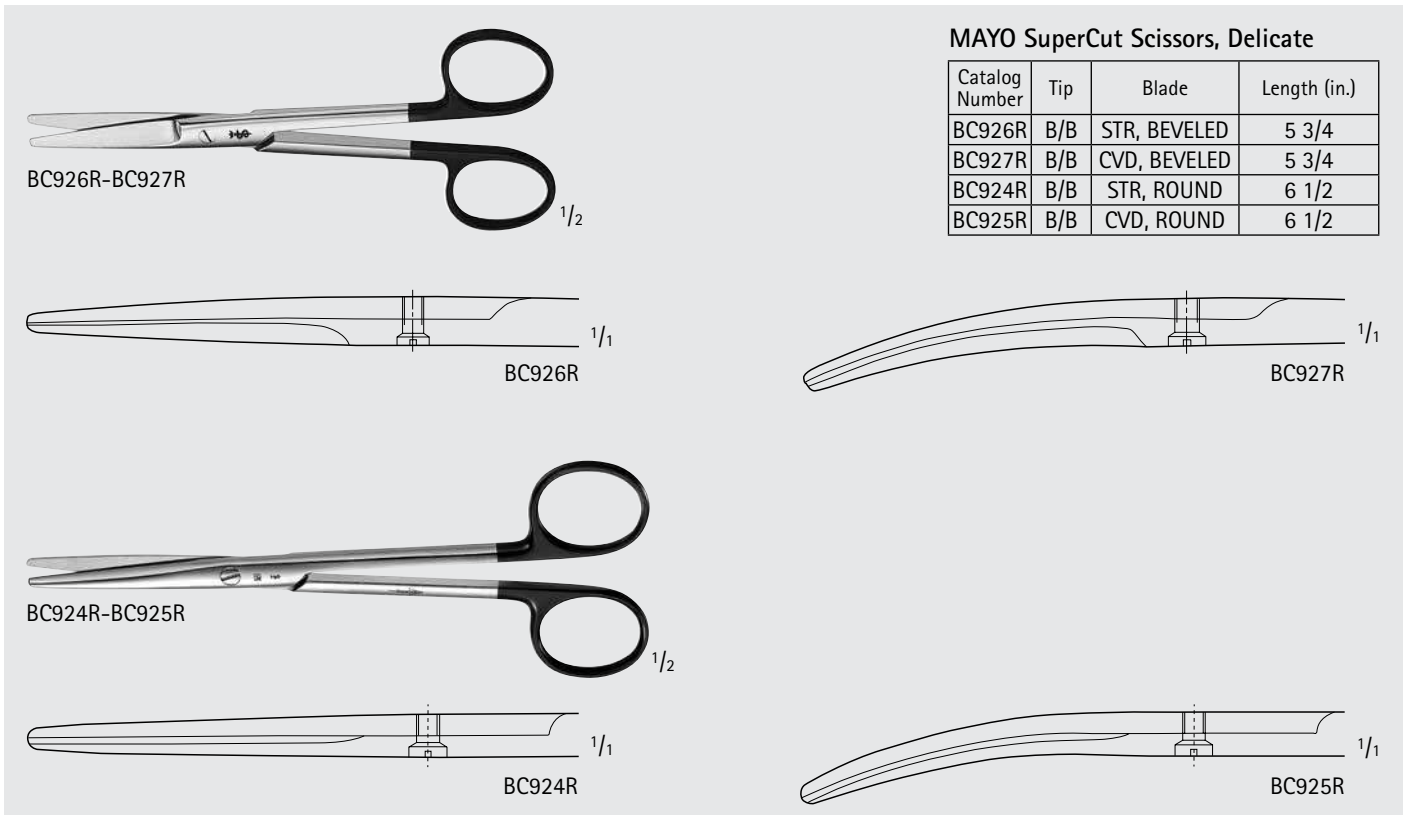

BC926R-BC927R

BC926R

BC927R

BC924R-BC925R

BC924R

BC925R



General Surgery

SuperCut Scissors

MAYO SuperCut Scissors, Beveled

Catalog Number	Tip	Blade	Length (in.)
MG216R	B/B	STR	9
BC922R	B/B	STR	10
BC938R	B/B	STR	12
MG087R	B/B	CVD	9
BC929R	B/B	CVD	11

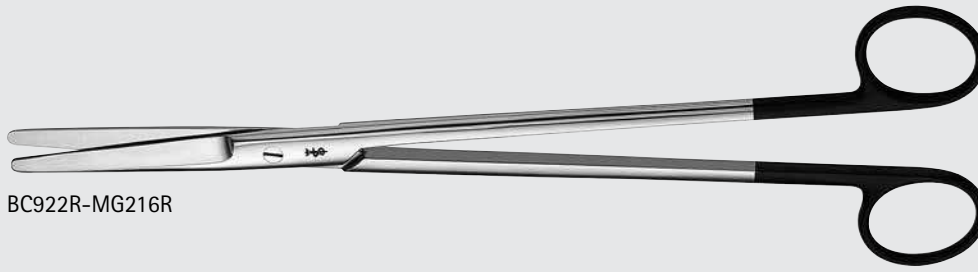

BC922R-MG216R

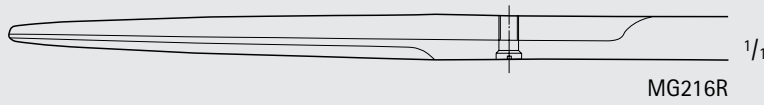

MG216R

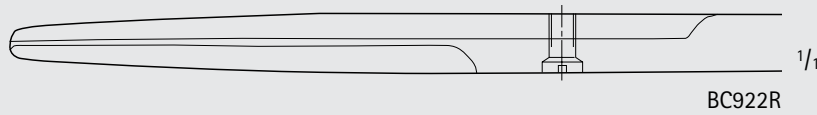

BC922R

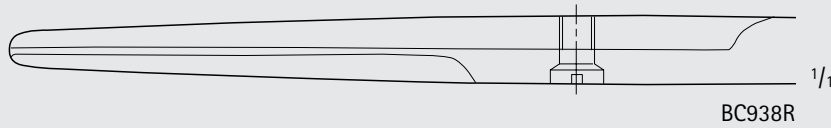

BC938R

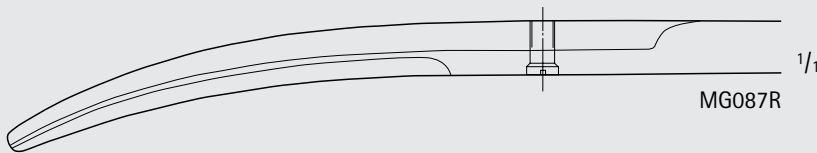

MG087R

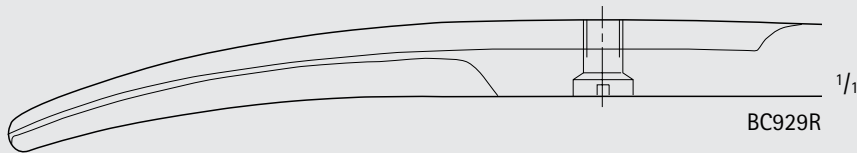

BC929R

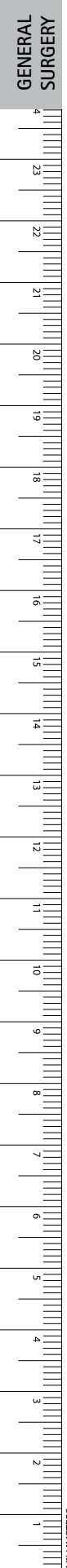



BC930R-BC931R

Baby METZENBAUM SuperCut Scissors, Delicate

Catalog Number	Tip	Blade	Length (in.)
BC930R	B/B	STR	4 1/2
BC931R	B/B	CVD	4 1/2

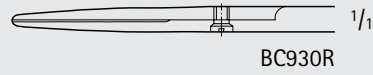

BC930R

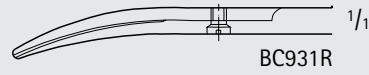

BC931R

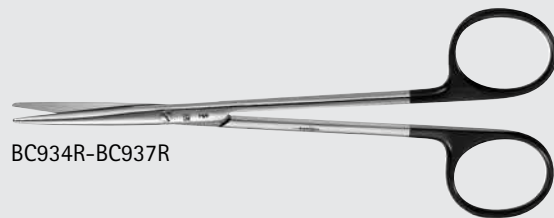

BC934R-BC937R

METZENBAUM SuperCut Scissors, Delicate

Catalog Number	Tip	Blade	Length (in.)
BC934R	B/B	STR	5 3/4
BC936R	B/B	STR	7
BC935R	B/B	CVD	5 3/4
BC937R	B/B	CVD	7

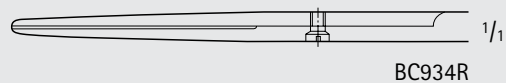

BC934R

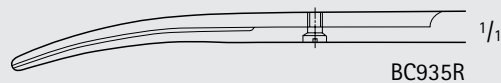

BC935R

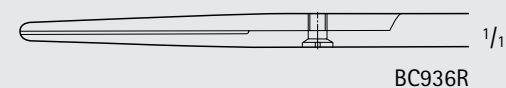

BC936R

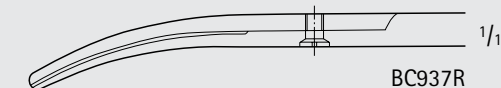

BC937R



INCHES

General Surgery

SuperCut Scissors

GENERAL SURGERY

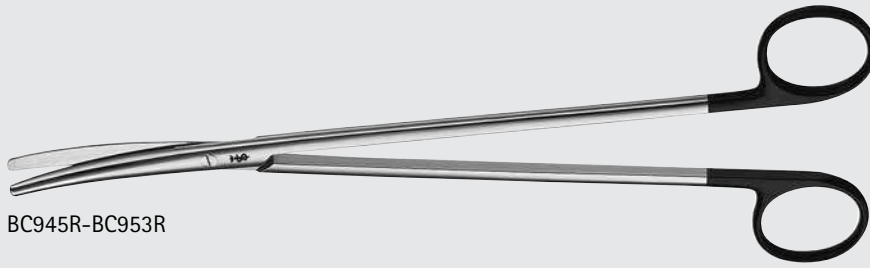
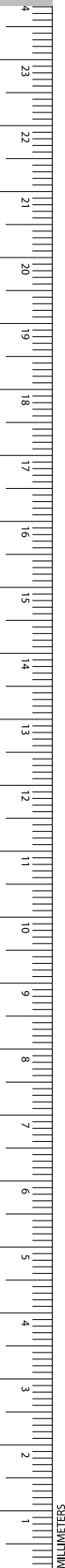

BC945R-BC953R

METZENBAUM SuperCut Scissors, Delicate

Catalog Number	Tip	Blade	Length (in.)
BC945R	B/B	CVD	9
BC947R	B/B	CVD	10 1/4
BC949R	B/B	CVD	11 1/4
BC951R	B/B	CVD	11 3/4
BC953R	B/B	CVD	14

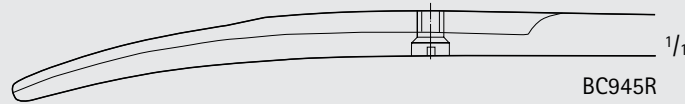

BC945R

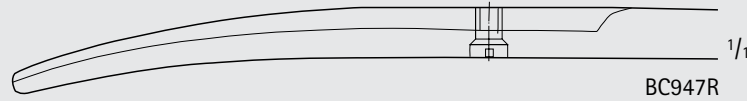

BC947R

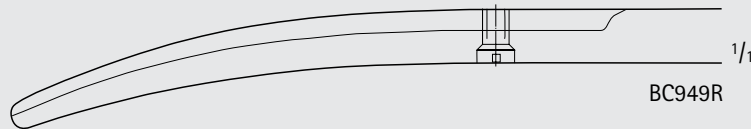

BC949R

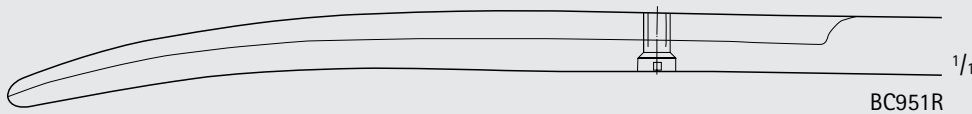

BC951R

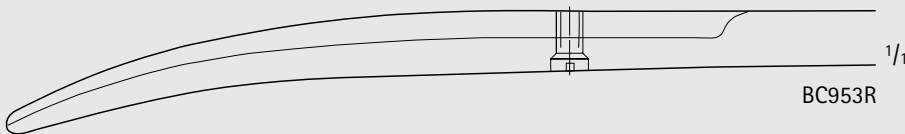

BC953R

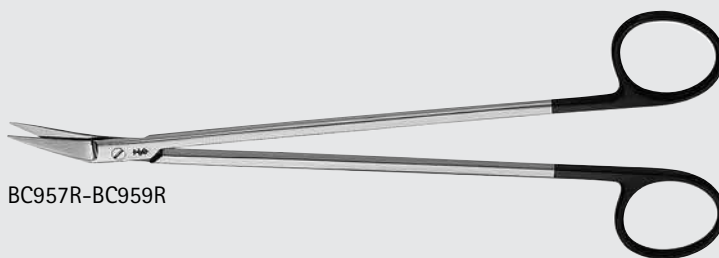

BC957R-BC959R

POTTS-SMITH SuperCut Scissors

Catalog Number	Tip	Blade Angle	Blade Size (mm)	Length (in.)
BC957R	B/B	25°	22	7 1/2
BC958R	B/B	45°	20	7 1/4
BC959R	B/B	60°	19	7



BC957R



BC958R



BC959R

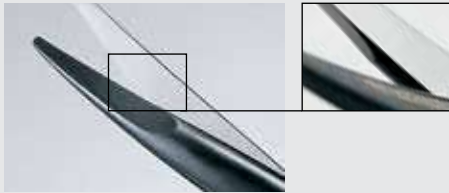

Microtome Edge

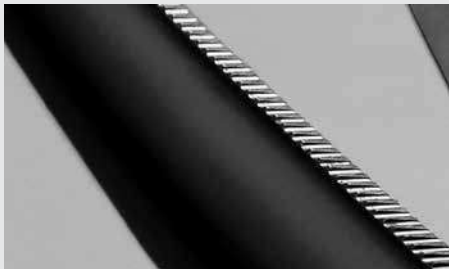

Wavecut

Noir Supreme Cut Scissors

- **Noir**
The combination of the renowned Aesculap Tungsten Carbide technology with the Aesculap Noir coating results in an extremely high surface hardness and therefore high wear resistance in daily hospital use.
- **Microtome edge**
The extremely sharp cutting edge of the scissors blade facilitates gentle cutting of tissue with minimal use of force.
- **Wavecut** prevents tissue from slipping out during the cutting process.
- The WB after the item number indicates the Noir scissors are the wavecut style, e.g. BC211WB.

For more information about Noir Supreme Cut Scissors see our brochure number DOC637.



BC252B-BC253WB

1/2



BC252B

1/1



BC253B, BC253WB

1/1

Noir MAYO Dissecting Scissors

Catalog Number	Tip	Blade	Length (in.)
BC252B	B/B	STR	6 3/4
BC253B	B/B	CVD	6 3/4
BC253WB	B/B	CVD	6 3/4



BC284B-BC284WB

1/2



BC284B-BC284WB

1/1

Noir MAYO-LEXER Dissecting Scissors

Catalog Number	Tip	Blade	Length (in.)
BC284B	B/B	CVD	6 1/2
BC284WB	B/B	CVD	6 1/2



General Surgery

Noir™ Supreme Cut Scissors

GENERAL SURGERY

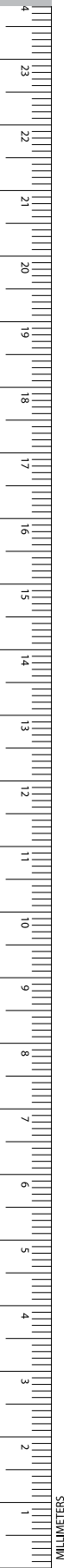



BC283B-BC283WB 1/2



BC283B-BC283WB 1/1

Noir LEXER Dissecting Scissors

Catalog Number	Tip	Blade	Length (in.)
BC283B	B/B	DEL, CVD	6 1/2
BC283WB	B/B	DEL, CVD	6 1/2



BC210B-BC211WB 1/2



BC210B 1/1



BC211B, BC211WB 1/1

Noir Iris Dissecting Scissors

Catalog Number	Tip	Blade	Length (in.)
BC210B	S/S	STR	4 1/4
BC211B	S/S	CVD	4 1/4
BC211WB	S/S	CVD	4 1/4



BC273B-BC273WB 1/2



BC273B-BC273WB 1/1

Noir TOENNIS-ADSON Dissecting Scissors

Catalog Number	Tip	Blade	Length (in.)
BC273B	B/B	DEL, CVD	6 7/8
BC273WB	B/B	DEL, CVD	6 7/8

Noir METZENBAUM Dissecting Scissors

Catalog Number	Tip	Blade	Length (in.)
BC261B	B/B	CVD	5 3/4
BC261WB	B/B	CVD	5 3/4
BC263B	B/B	CVD	7
BC263WB	B/B	CVD	7
BC271B	B/B	DEL, CVD	7
BC271WB	B/B	DEL, CVD	7
BC265B	B/B	CVD	7 7/8
BC265WB	B/B	CVD	7 7/8
BC275B	B/B	DEL, CVD	7 7/8
BC275WB	B/B	DEL, CVD	7 7/8
BC267B	B/B	CVD	9
BC267WB	B/B	CVD	9
BC277B	B/B	DEL, CVD	9
BC277WB	B/B	DEL, CVD	9

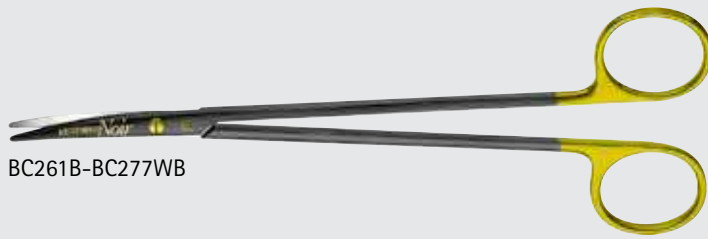

BC261B-BC277WB



BC261B, BC261WB

1/1



BC263B, BC263WB

1/1



BC271B, BC271WB

1/1



BC265B, BC265WB

1/1



BC275B, BC275WB

1/1



BC267B, BC267WB

1/1



BC277B, BC277WB

1/1



INCHES

General Surgery

Noir™ Supreme Cut Scissors

Noir NELSON-METZENBAUM Dissecting Scissors

Catalog Number	Tip	Blade	Length (in.)
BC279B	B/B	DEL, CVD	10 1/4
BC279WB	B/B	DEL, CVD	10 1/4
BC281B	B/B	DEL, CVD	11
BC281WB	B/B	DEL, CVD	11



BC279B-BC281WB



BC279B, BC279WB



BC281B, BC281WB

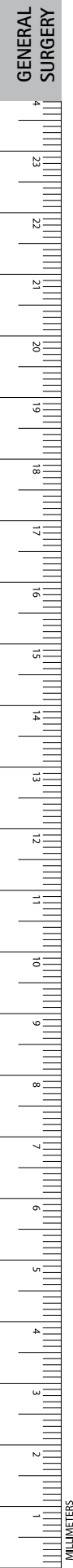



CONVERSE Needle Holder

Catalog Number	Jaw	Length (in.)
BM200R	LONG SERR	5 1/8

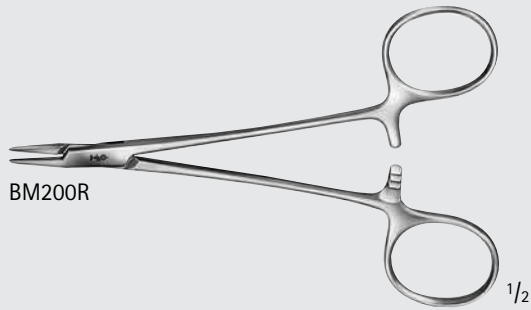

BM200R

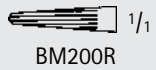

BM200R

HALSEY Needle Holder

Catalog Number	Tip	Jaw	Length (in.)
BM201R	DEL	SMOOTH	5 1/8
BM205R	DEL	X-SERR	5 1/8

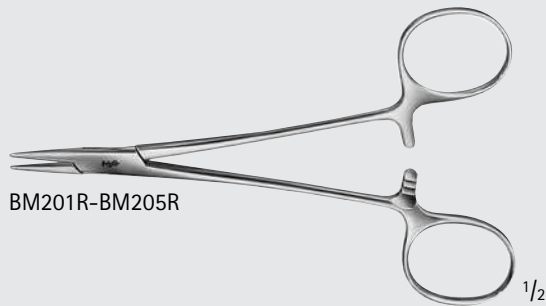

BM201R-BM205R

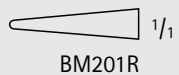

BM201R



BM205R

WEBSTER Needle Holder

Catalog Number	Jaw	Length (in.)
BM202R	SMOOTH	5

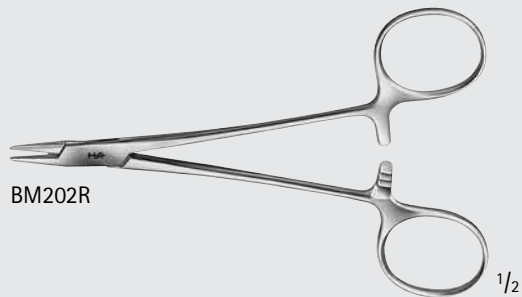

BM202R

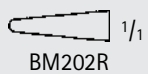

BM202R

DERF Needle Holder

Catalog Number	Jaw	Length (in.)
BM204R	SERR	5

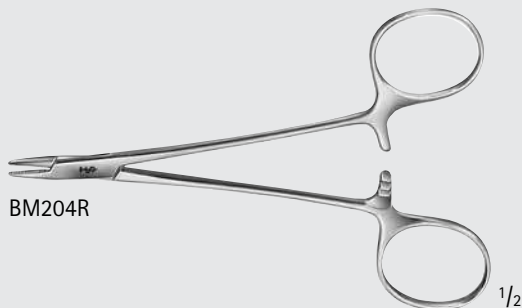

BM204R



BM204R

General Surgery

Needle Holders

GENERAL SURGERY

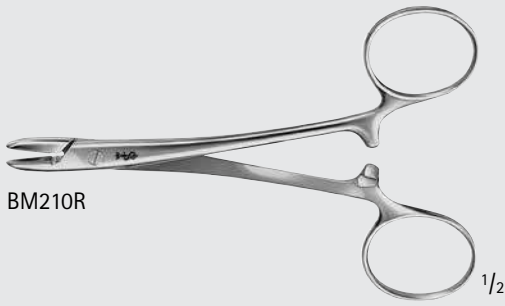
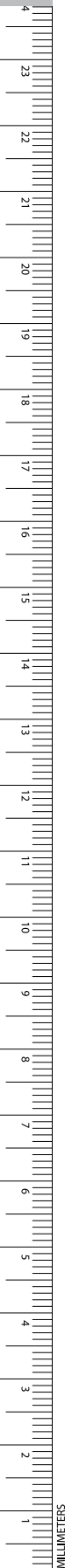

BM210R

1/2



BM210R

1/1

DOYEN Needle Holder

Catalog Number	Jaw	Length (in.)
BM210R	X-SERR	5

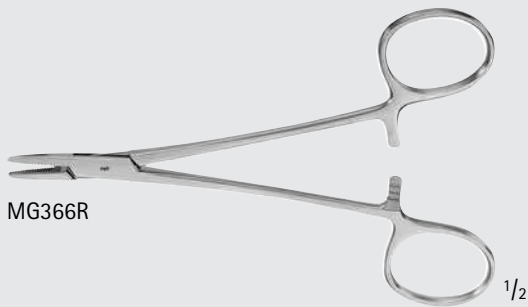

MG366R

1/2



MG366R

1/1

COLLIER Needle Holder, Fenestrated

Catalog Number	Jaw	Length (in.)
MG366R	SERR	5

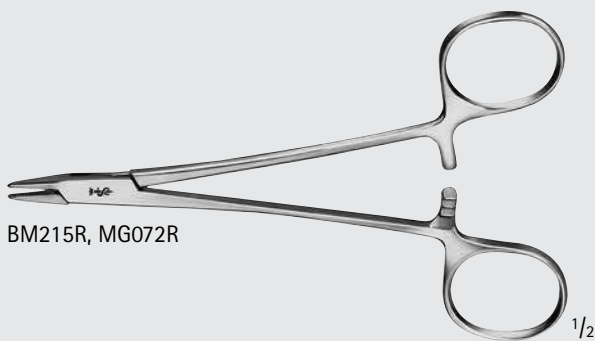

BM215R, MG072R

1/2



MG072R

1/1



BM215R

1/1

BAUMGARTNER Needle Holder

Catalog Number	Jaw	Length (in.)
MG072R	SERR, GROOVED	5 1/4
BM215R	X-SERR	5 3/4



CRILE-WOOD Needle Holder

Catalog Number	Jaw	Length (in.)
BM218R	X-SERR	6
BM220R	X-SERR	6 1/4

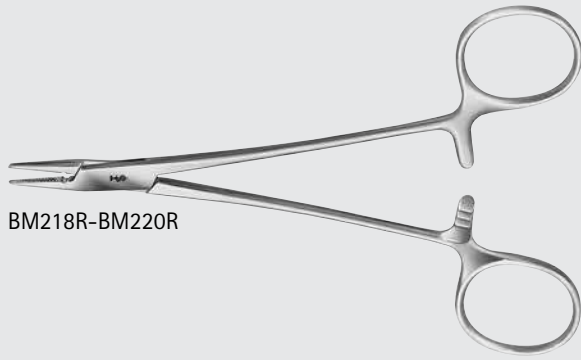

BM218R-BM220R

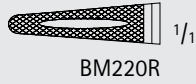
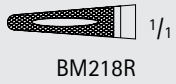

CRILE-MURRAY Needle Holder

Catalog Number	Jaw	Length (in.)
BM219R	SERR	6

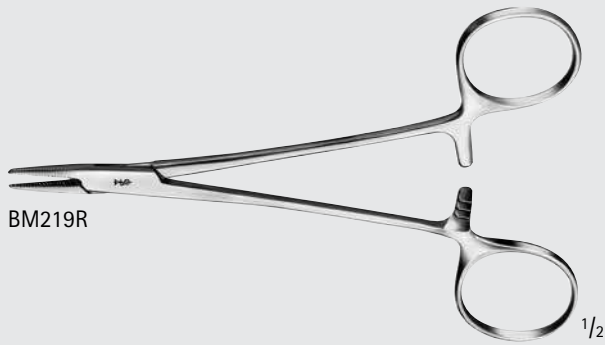

BM219R



ADSON Needle Holder, Fenestrated

Catalog Number	Jaw	Length (in.)
BM224R	SERR	7

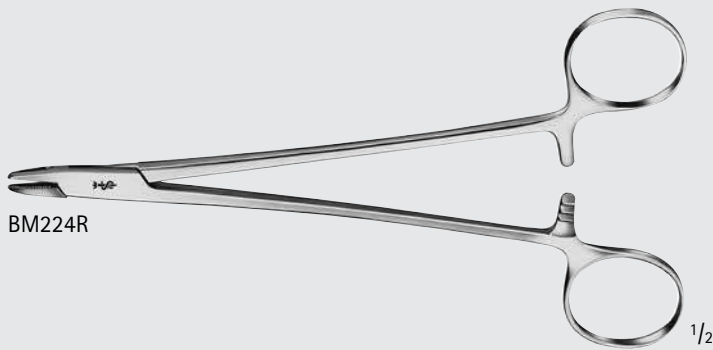

BM224R

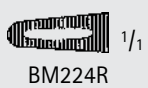

General Surgery

Needle Holders

GENERAL SURGERY

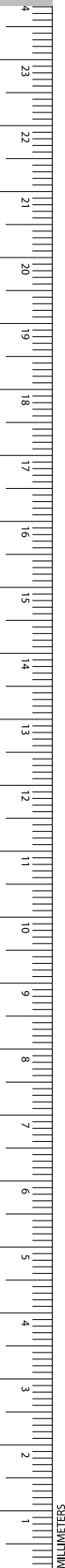

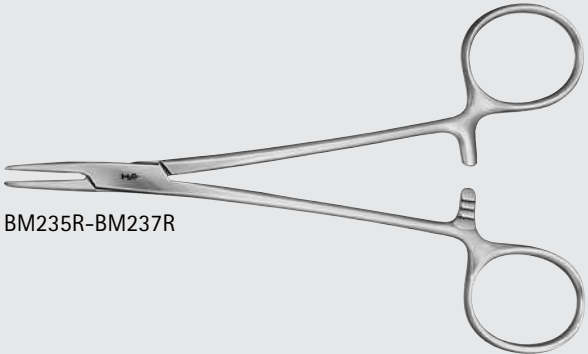

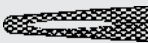

BM235R-BM237R

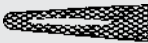

BM235R 1/1



BM236R 1/1



BM237R 1/1

MAYO-HEGAR Needle Holder

Catalog Number	Jaw	Length (in.)
BM235R	X-SERR	6
BM236R	X-SERR	7 1/4
BM237R	X-SERR	7 7/8

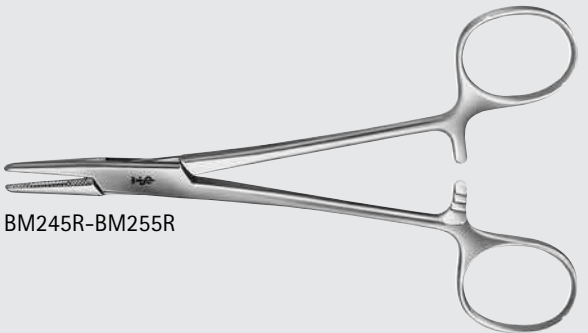

BM245R-BM255R



BM245R 1/1



BM247R 1/1



BM249R 1/1



BM255R 1/1

HEGAR Needle Holder

Catalog Number	Tip	Jaw	Length (in.)
BM245R	HEAVY	X-SERR	6
BM247R	HEAVY	X-SERR	6 7/8
BM249R	HEAVY	X-SERR	8
BM255R	HEAVY	X-SERR	8

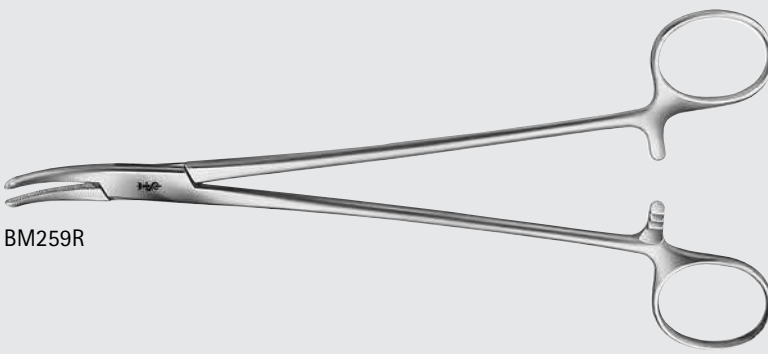

BM259R

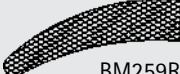

BM259R 1/1

HEANEY Needle Holder

Catalog Number	Tip	Jaw	Length (in.)
BM259R	CVD	SERR	7 7/8



JAMESON Needle Holder

Catalog Number	Tip	Jaw	Length (in.)
BM270R	DEL	X-SERR	9

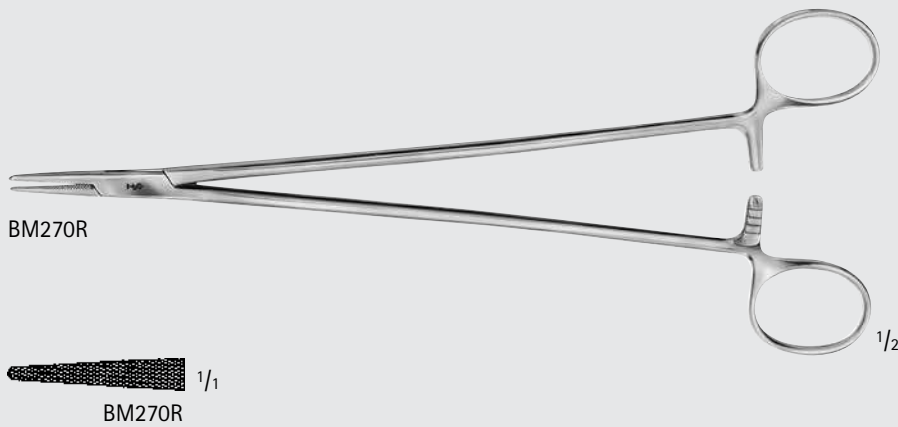

WANGENSTEEN Needle Holder

Catalog Number	Jaw	Length (in.)
BM272R	X-SERR	10 3/4

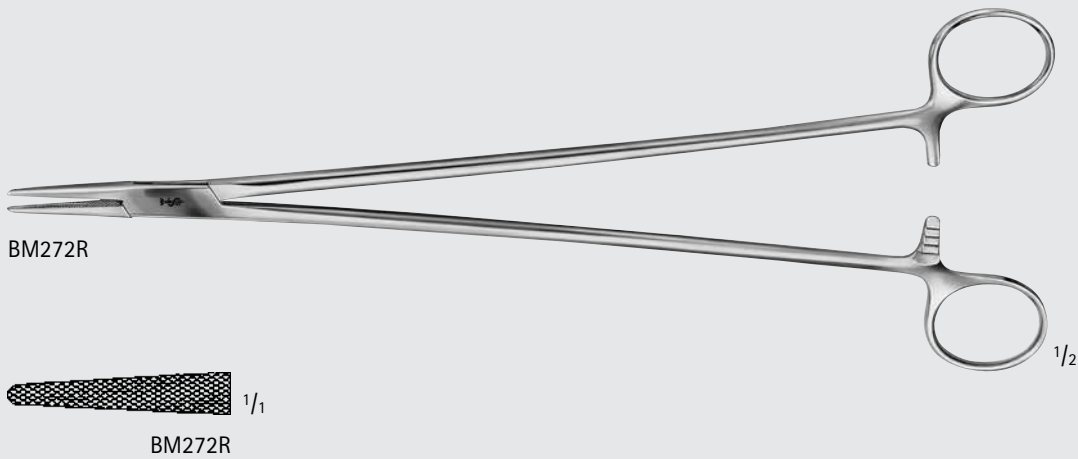

MASSON Needle Holder

Catalog Number	Jaw	Length (in.)
BM275R	X-SERR	10 1/2

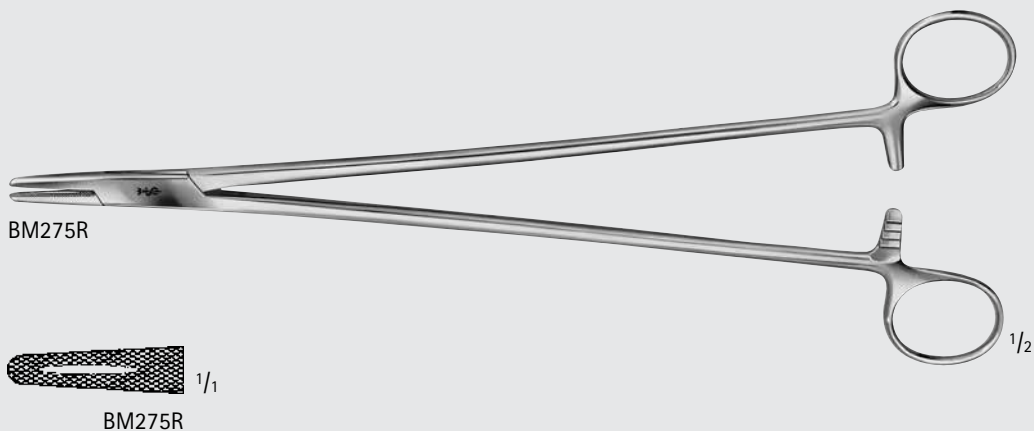

General Surgery

Needle Holders

GENERAL SURGERY

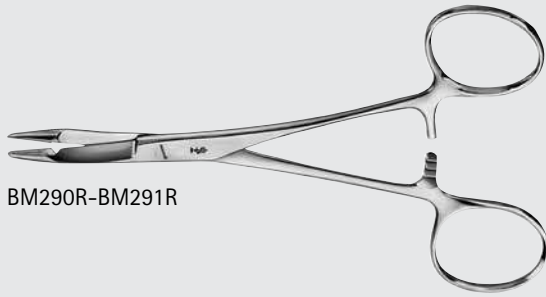
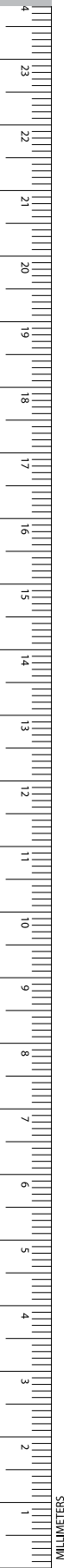

BM290R-BM291R

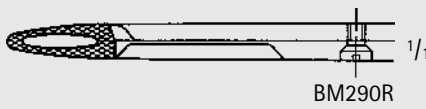
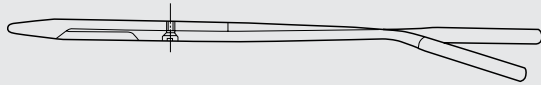

BM290R



BM291R

HEGAR-OLSEN Needle Holder/Scissors

Catalog Number	Jaw	Length (in.)
BM290R	SERR	5 1/2
BM291R	SERR	7 1/4



BM299R

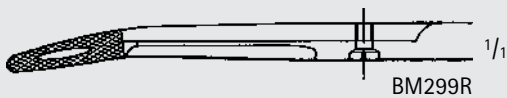
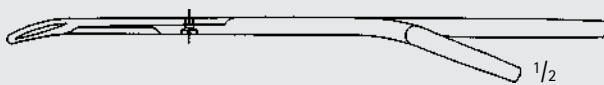

BM299R

GILLIES Needle Holder/Scissors

Catalog Number	Jaw	Length (in.)
BM299R	SERR	6 1/4

Aesculap features Needle Holders with Tungsten Carbide (TC) inserts. A smooth jaw and three different serration patterns are available, depending on the size of the suture needle.

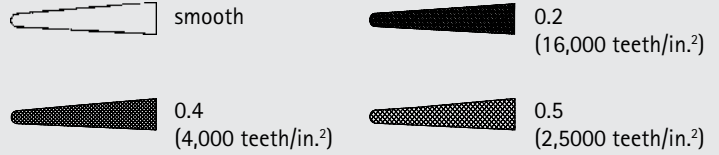
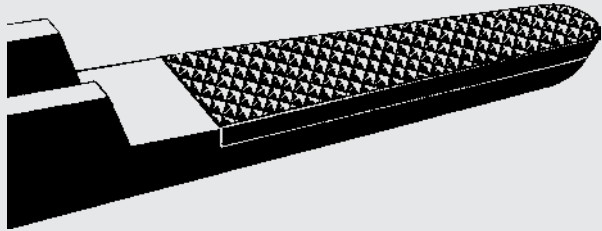

We recommend carbide inserts as follows:

Jaw Surface	Suture Material
Smooth	9/0 - 11/0
0.2 mm pitch of serration	6/0 - 10/0
0.4 mm pitch of serration	4/0 - 6/0
0.5 mm pitch of serration	up to 3/0



BM320R

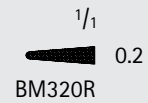

**DUROGRIP TC HELLBERG-KUPKA
Needle Holder W/ Ergonomic Handle**

Catalog Number	Jaw	Length (in.)
BM320R	SERR	8 1/4

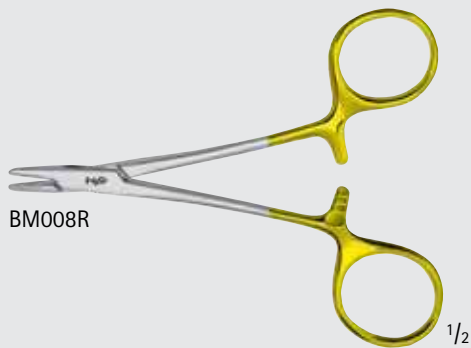

BM008R

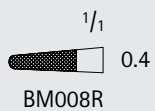

DUROGRIP TC DERF Needle Holder

Catalog Number	Jaw	Length (in.)
BM008R	SERR	4 3/4



General Surgery

DUROGRIP™ TC Needle Holders

GENERAL SURGERY

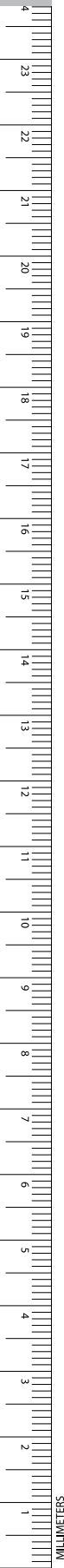

BM009R

1/2

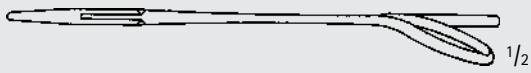

1/2



BM009R

DUROGRIP TC MASING Needle Holder

Catalog Number	Jaw	Length (in.)
BM009R	SERR	5 1/8

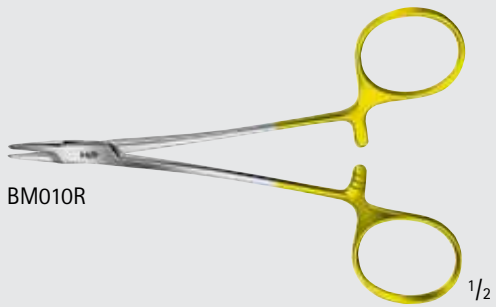

BM010R

1/2

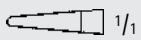

BM010R



BM012R

1/2



BM012R

DUROGRIP TC HALSEY Needle Holder

Catalog Number	Jaw	Length (in.)
BM010R	SMOOTH	4 3/4
BM012R	SERR	5 1/8

DUROGRIP TC CONVERSE Needle Holder

Catalog Number	Jaw	Length (in.)
BM011R	SERR	5 1/8



BM011R

1/2

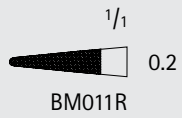

BM011R

DUROGRIP TC WEBSTER Needle Holder

Catalog Number	Jaw	Length (in.)
BM014R	SMOOTH	5 1/8
BM024R	SERR	5 1/8

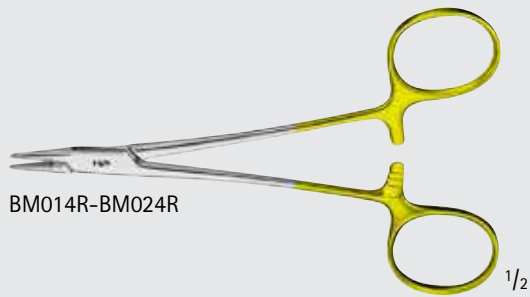

BM014R-BM024R

1/2

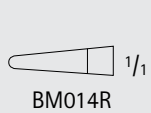

BM014R

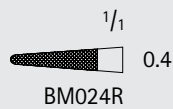

BM024R

DUROGRIP TC BAUMGARTNER Needle Holder

Catalog Number	Jaw	Length (in.)
BM015R	SERR	5 3/4

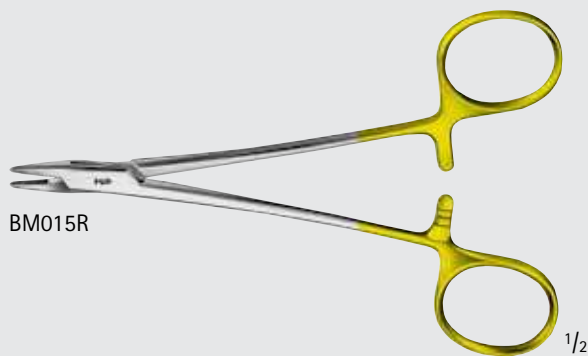

BM015R

1/2

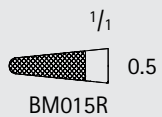

BM015R



INCHES

General Surgery

DUROGRIP™ TC Needle Holders

GENERAL SURGERY

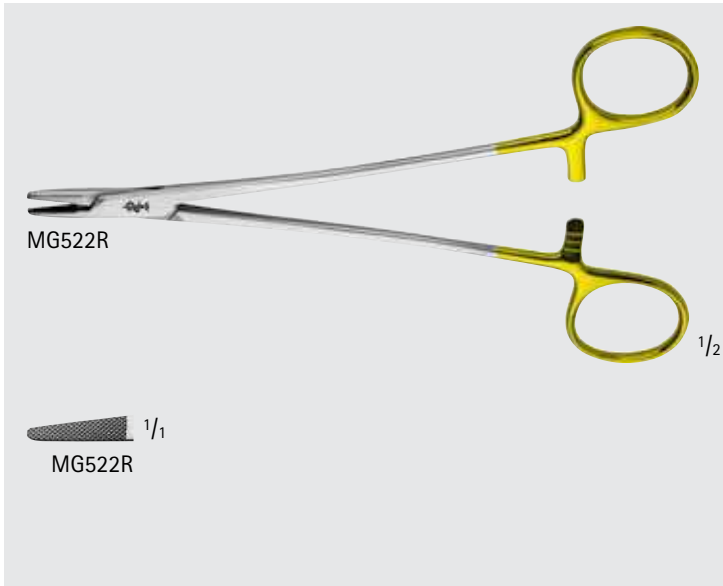

DUROGRIP TC NEW ORLEANS Needle Holder

Catalog Number	Jaw	Length (in.)
MG522R	SERR	7

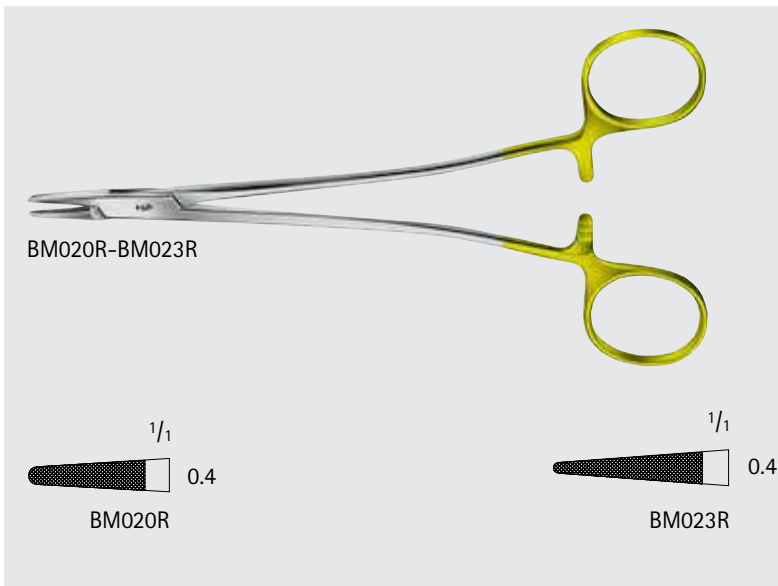

DUROGRIP TC SAROT Needle Holder

Catalog Number	Jaw	Length (in.)
BM020R	SERR	7
BM023R	SERR	10 1/4

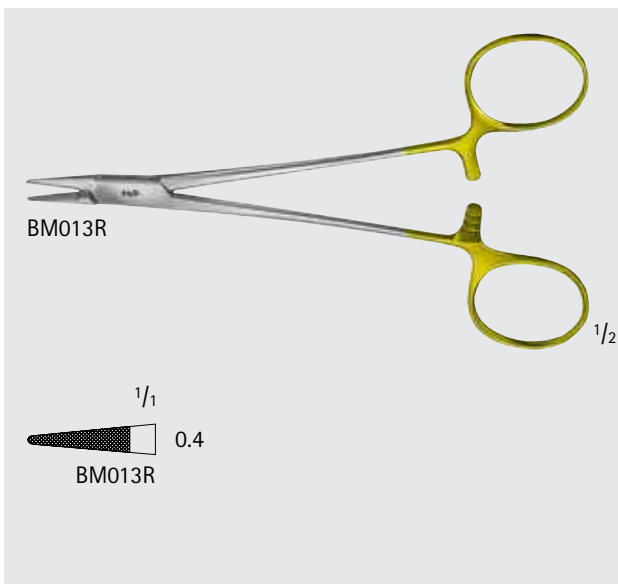

DUROGRIP TC Baby CRILE-WOOD Needle Holder

Catalog Number	Jaw	Length (in.)
BM013R	SERR	6

DUROGRIP TC CRILE-WOOD Needle Holder

Catalog Number	Jaw	Length (in.)
BM016R	SERR	5 3/4
BM017R	SERR	7 1/4
BM019R	SERR	7 7/8
BM030R	SERR	10 5/8
BM021R	SERR	12
MB604R	SERR	14
BM029R	SMOOTH	6



BM016R, BM021R, MB604R

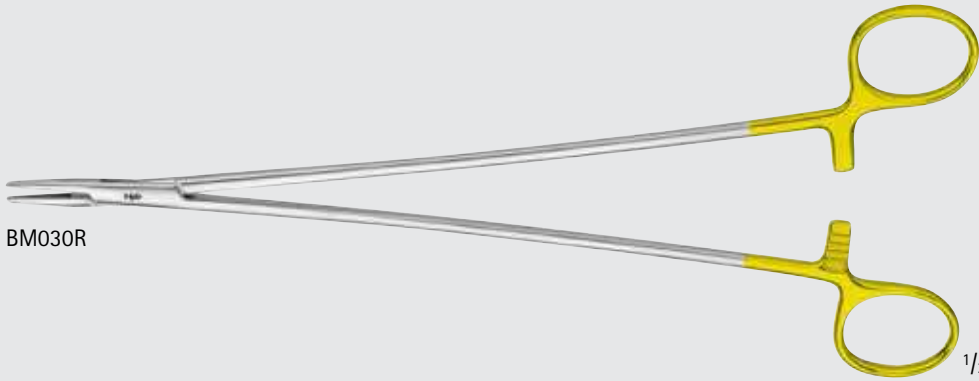
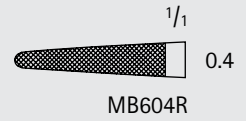
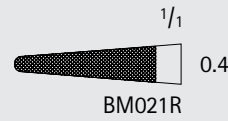
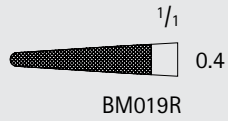
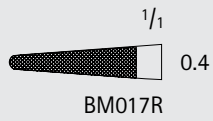
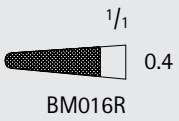

BM030R

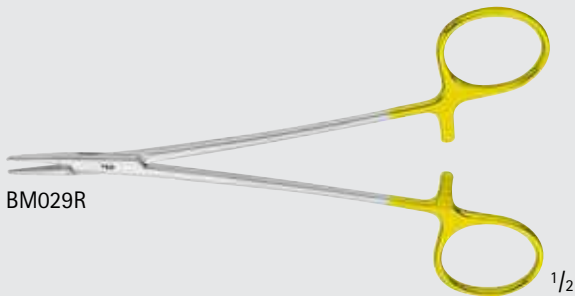
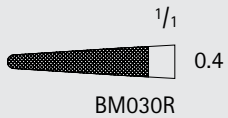

BM029R

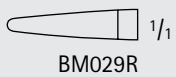

INCHES

General Surgery

DUROGRIP™ TC Needle Holders

GENERAL SURGERY

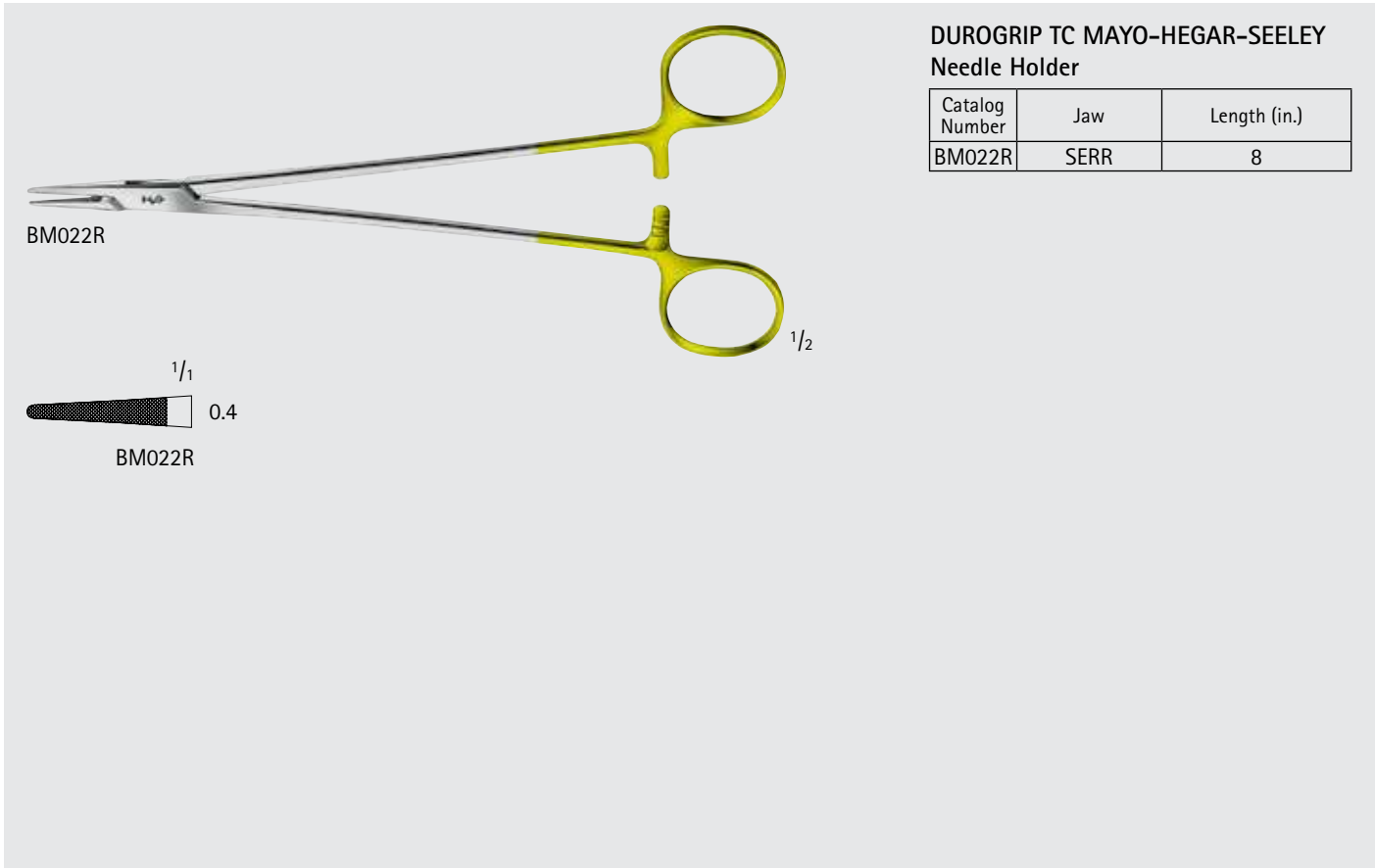
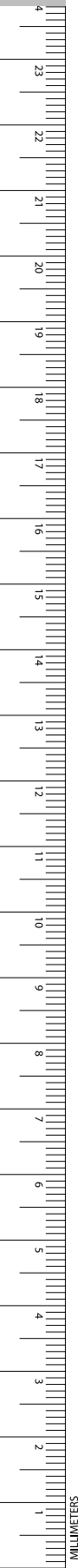

DUROGRIP TC MAYO-HEGAR-SEELEY Needle Holder

Catalog Number	Jaw	Length (in.)
BM022R	SERR	8

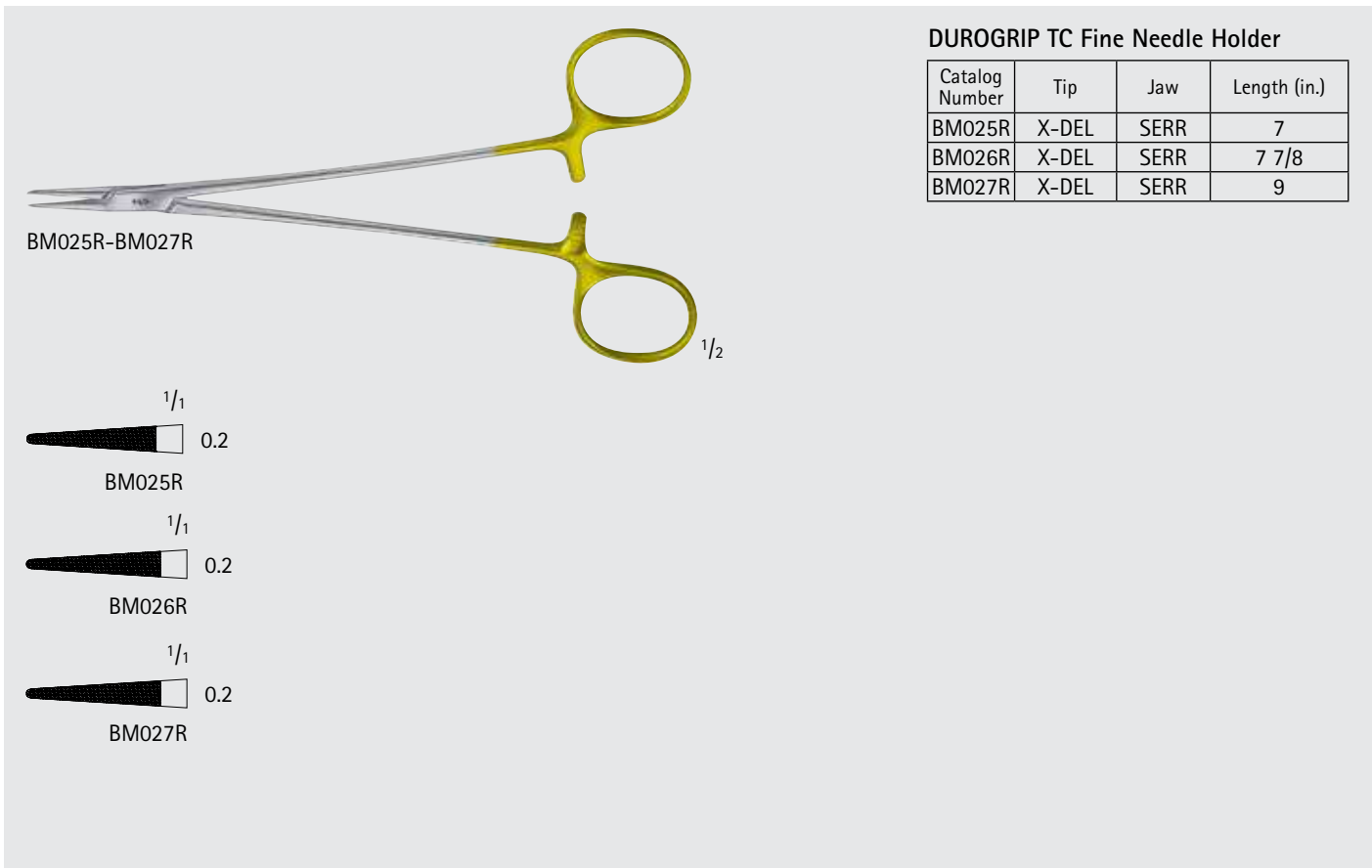

DUROGRIP TC Fine Needle Holder

Catalog Number	Tip	Jaw	Length (in.)
BM025R	X-DEL	SERR	7
BM026R	X-DEL	SERR	7 7/8
BM027R	X-DEL	SERR	9

DUROGRIP TC DEBAKEY Needle Holder

Catalog Number	Tip	Jaw	Length (in.)
BM032R	DEL	SERR	6
BM033R	DEL	SERR	6 1/2
BM035R	DEL	SERR	7
BM034R	DEL	SERR	8 1/4
BM036R	DEL	SERR	9
BM037R	DEL	SERR	10 1/4
BM038R	DEL	SERR	12
BM063R	X-DEL	SERR	6 1/2
BM064R	X-DEL	SERR	8 1/4
BM040R	X-DEL	SERR	12



BM032R

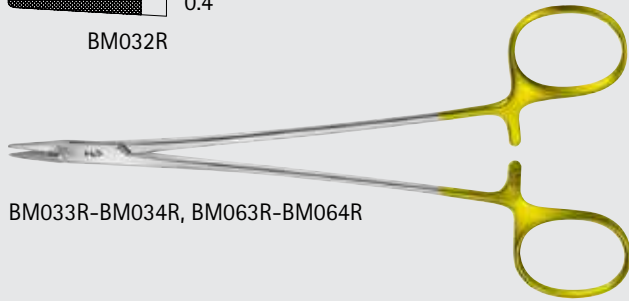
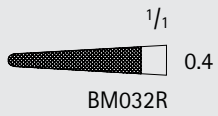

BM033R-BM034R, BM063R-BM064R

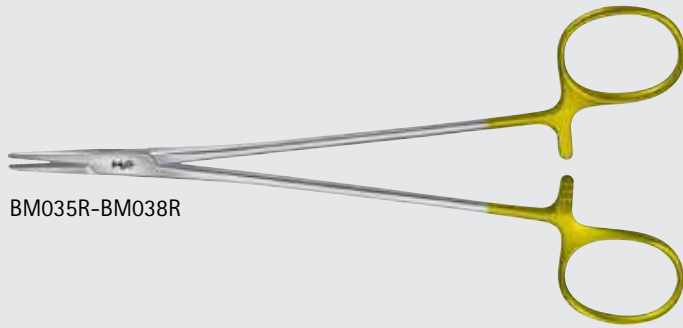
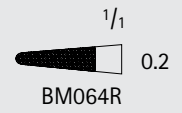
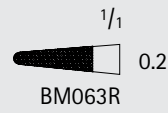
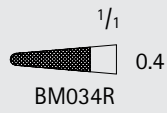
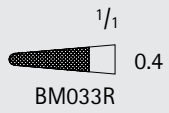

BM035R-BM038R

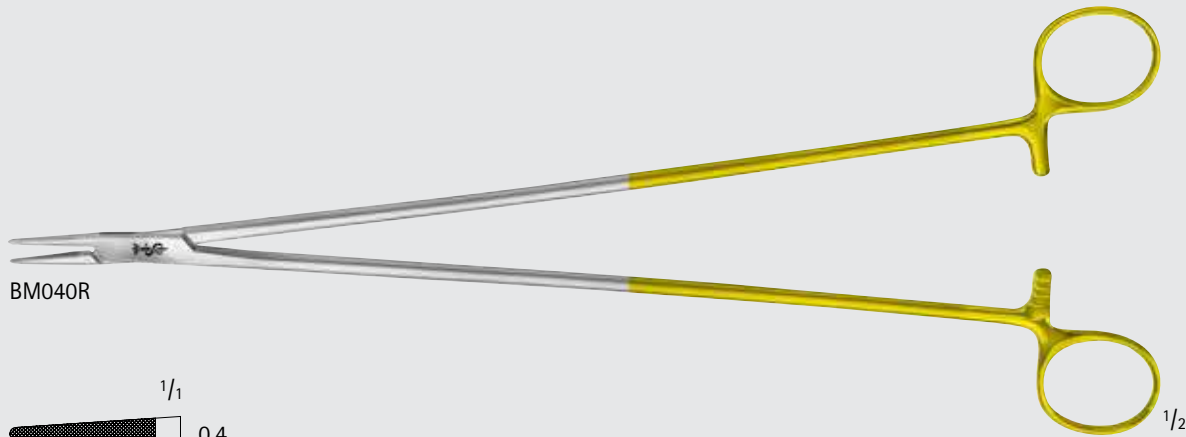
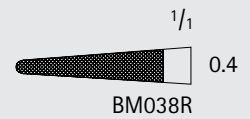
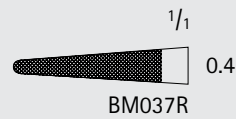
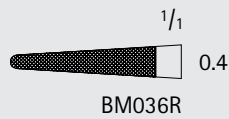
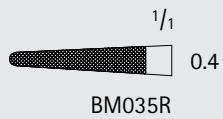

BM040R

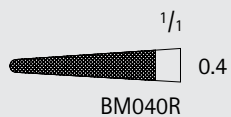

INCHES

General Surgery

DUROGRIP™ TC Needle Holders

GENERAL SURGERY

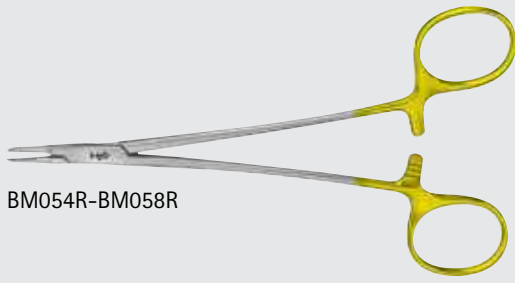

BM054R-BM058R

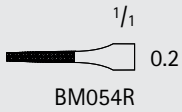

BM054R

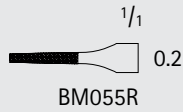

BM055R



BM056R

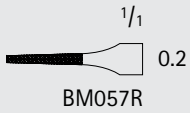

BM057R

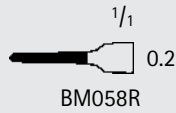

BM058R

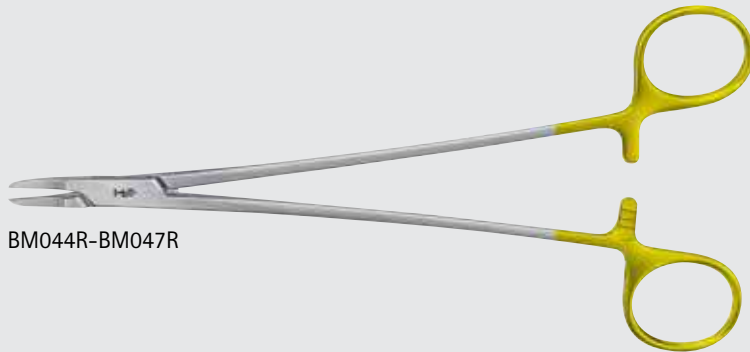

BM044R-BM047R

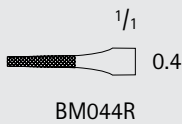

BM044R

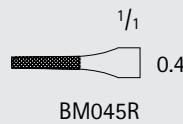

BM045R

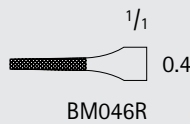

BM046R

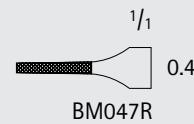

BM047R

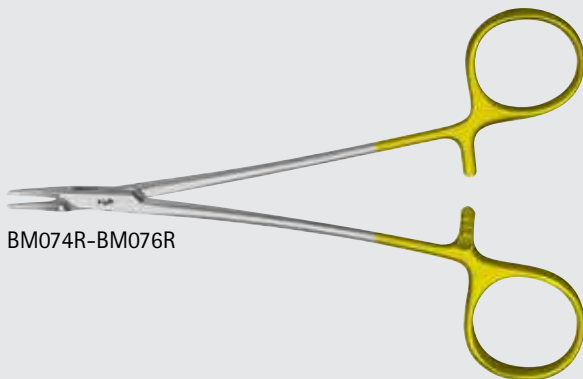

BM074R-BM076R

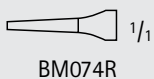

BM074R

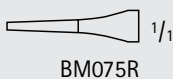

BM075R

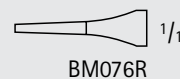

BM076R

DUROGRIP TC RYDER Needle Holder

Catalog Number	Tip	Jaw	Length (in.)
BM054R	X-DEL	SERR	5 1/4
BM055R	X-DEL	SERR	6 1/8
BM056R	X-DEL	SERR	6 7/8
BM057R	X-DEL	SERR	8 1/4
BM058R	X-DEL	SERR	9
BM044R	DEL	SERR	5 1/4
BM045R	DEL	SERR	6 7/8
BM046R	DEL	SERR	7 3/4
BM047R	DEL	SERR	10 1/2
BM074R	DEL	SMOOTH	6
BM075R	DEL	SMOOTH	7
BM076R	DEL	SMOOTH	8 7/8

DUROGRIP TC FRENCH Eye Needle Holder

Catalog Number	Jaw	Length (in.)
MB606R	SERR	6 1/4
MB607R	SERR	7 1/4
MB611R	SERR	8
MB612R	SERR	9 1/4

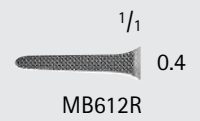
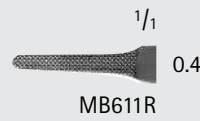
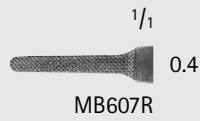
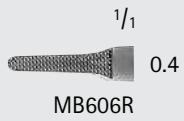
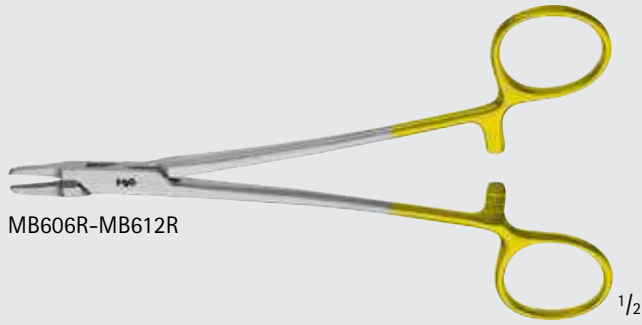

General Surgery

DUROGRIP™ TC Needle Holders

GENERAL SURGERY

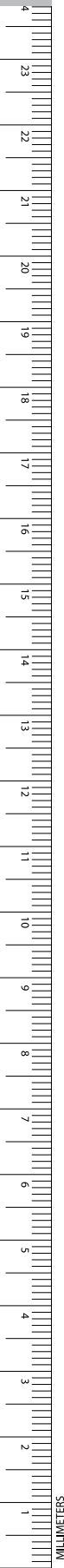

BM065R-BM070R

DUROGRIP TC MAYO-HEGAR Needle Holder

Catalog Number	Jaw	Length (in.)
BM065R	SERR	6
BM066R	SERR	7 1/4
BM067R	SERR	8
BM068R	SERR	9 1/4
BM070R	SERR	10 1/2
BM069R	SERR	12
MB617R	SERR	14

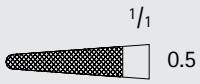

BM065R

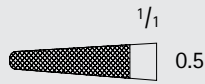

BM066R

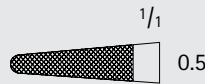

BM067R



BM068R



BM070R

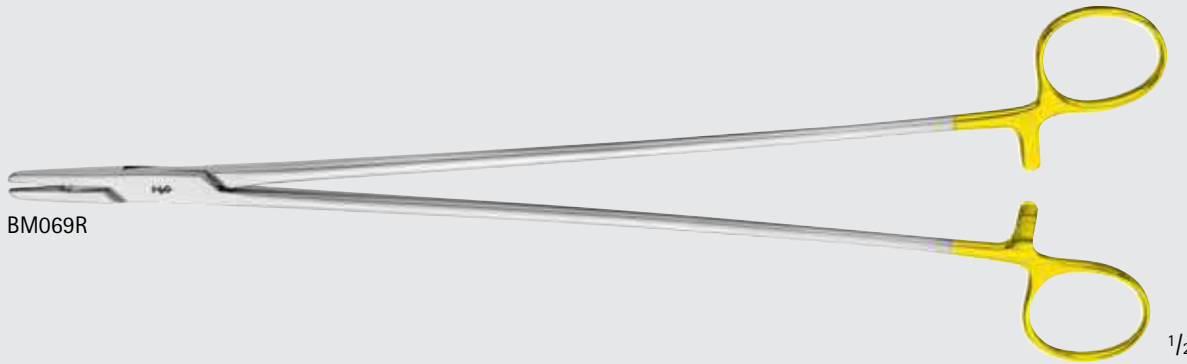

BM069R

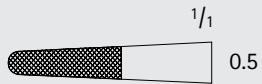

BM069R

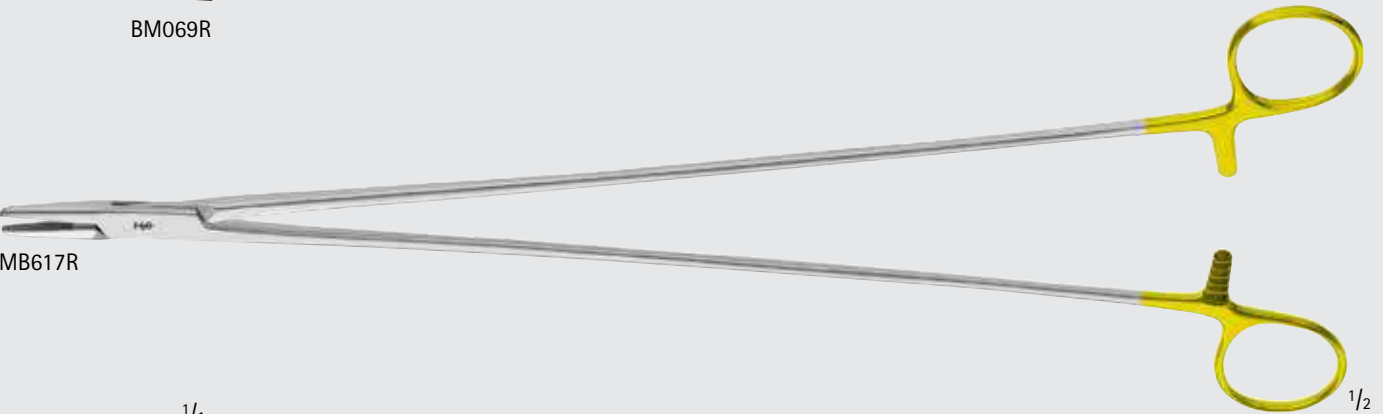

MB617R



MB617R

DUROGRIP TC HEGAR Needle Holder

Catalog Number	Tip	Jaw	Length (in.)
BM077R	HEAVY	SERR	8
BM078R	HEAVY	SERR	9 1/2

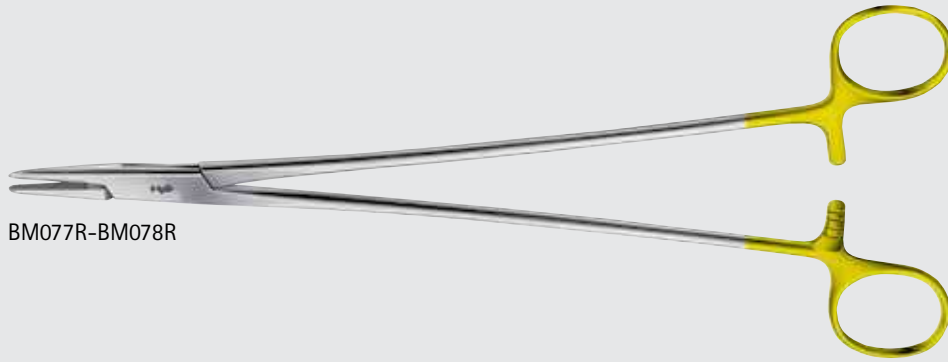

BM077R-BM078R

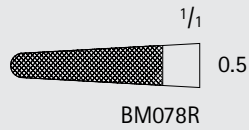
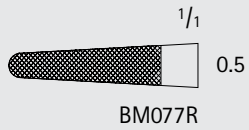

DUROGRIP TC WANGENSTEEN Needle Holder

Catalog Number	Jaw	Length (in.)
BM042R	SERR	10 3/4

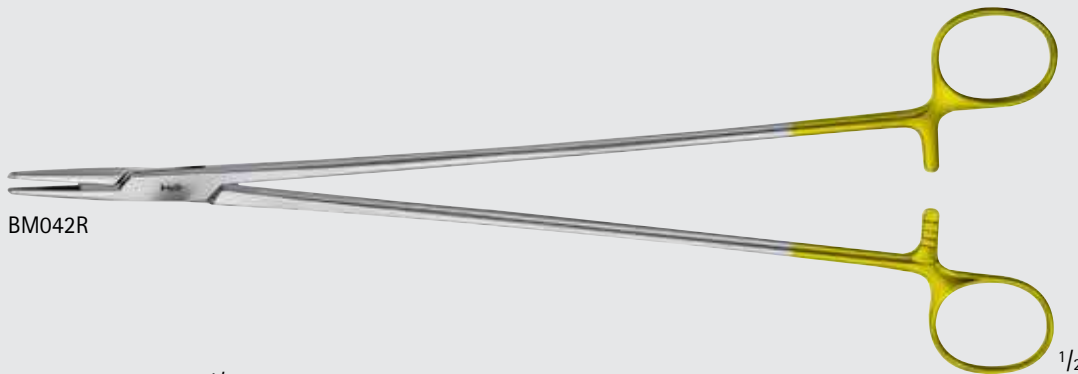

BM042R

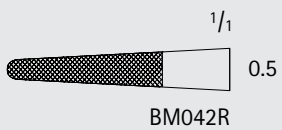

General Surgery

DUROGRIP™ TC Needle Holders

GENERAL SURGERY



DUROGRIP TC MASSON Needle Holder

Catalog Number	Jaw	Length (in.)
BM090R	SERR	10 1/2

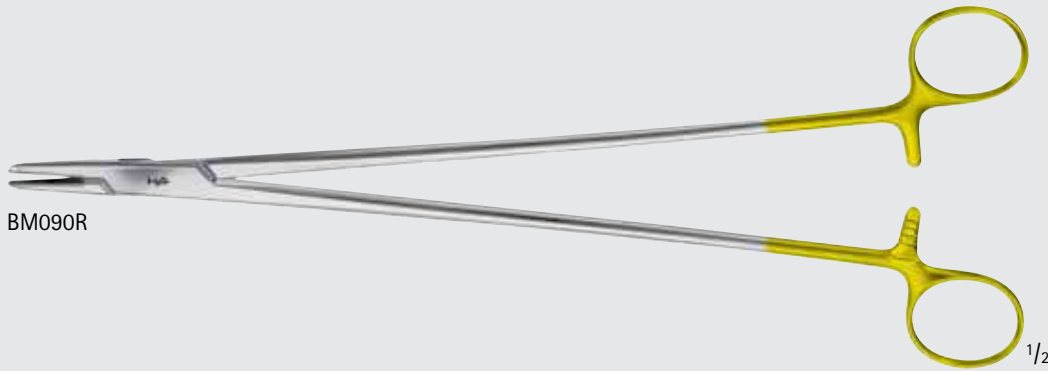

BM090R

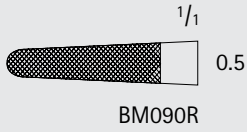

BM090R

DUROGRIP TC MAYO-MASSON Needle Holder

Catalog Number	Jaw	Length (in.)
MB918R	SERR	16

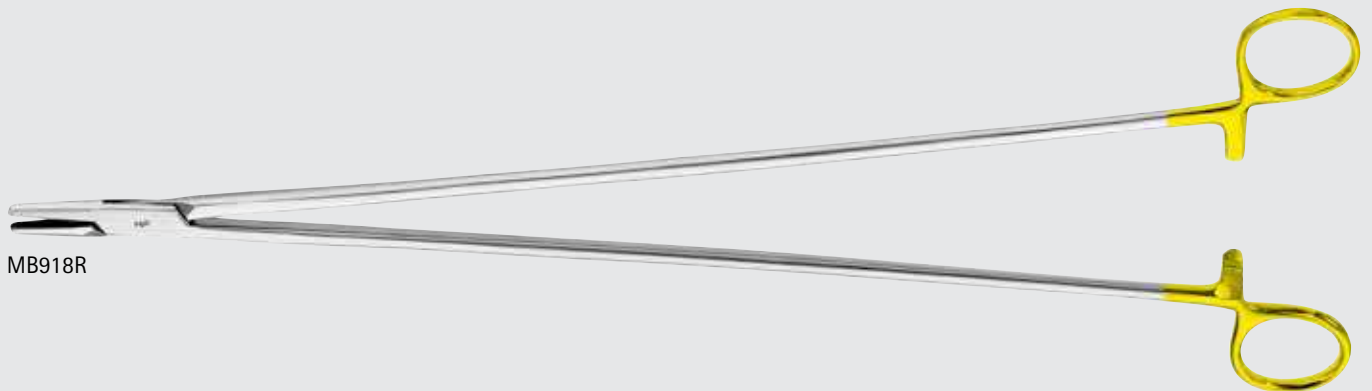

MB918R



MB918R

DUROGRIP TC HEANEY Needle Holder

Catalog Number	Tip	Jaw	Length (in.)
BM081R	CVD	SERR	7 7/8
BM084R	CVD	SERR	10 1/4

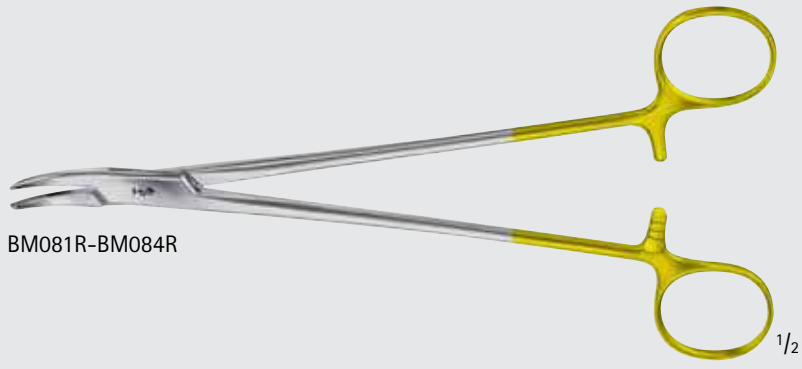

BM081R-BM084R

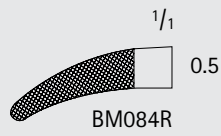
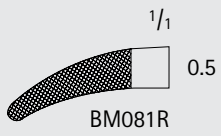

DUROGRIP TC MUELLER Needle Holder

Catalog Number	Tip	Jaw	Length (in.)
BM089R	CVD	SERR	14 1/4

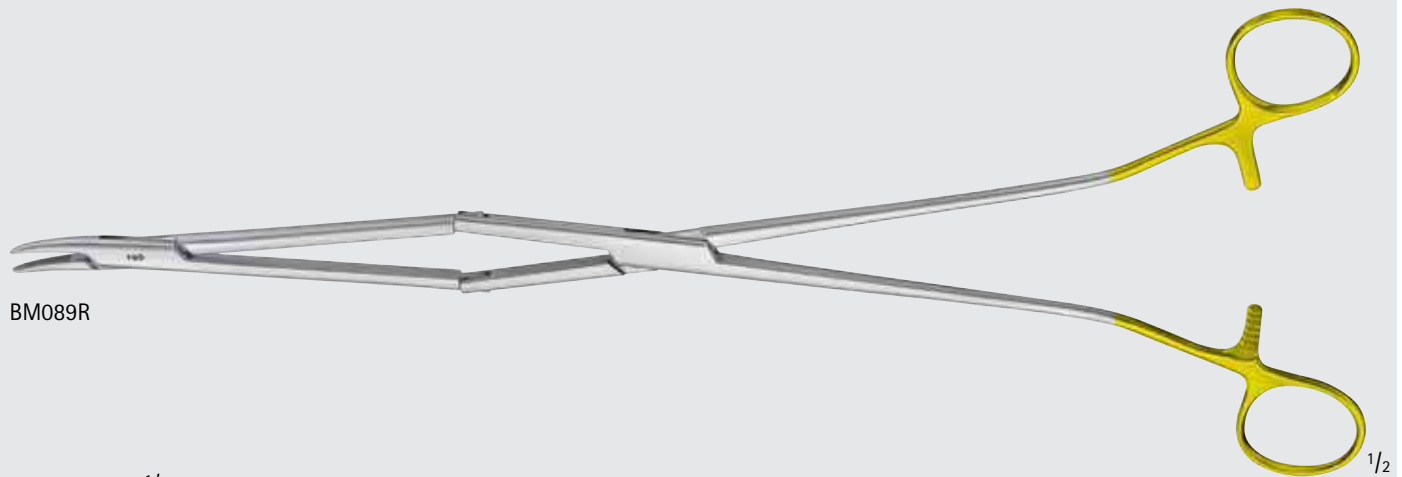

BM089R

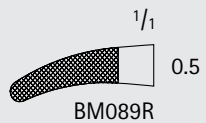

INCHES

General Surgery

DUROGRIP™ TC Needle Holders

GENERAL SURGERY

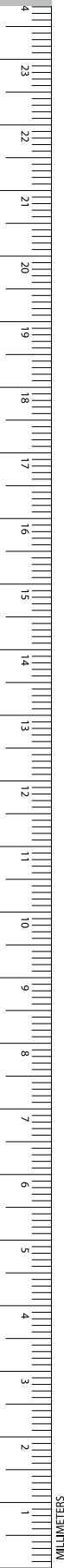

DUROGRIP TC FINOCHIETTO Needle Holder

Catalog Number	Tip	Jaw	Length (in.)
BM092R	ANG	SERR	10 1/2

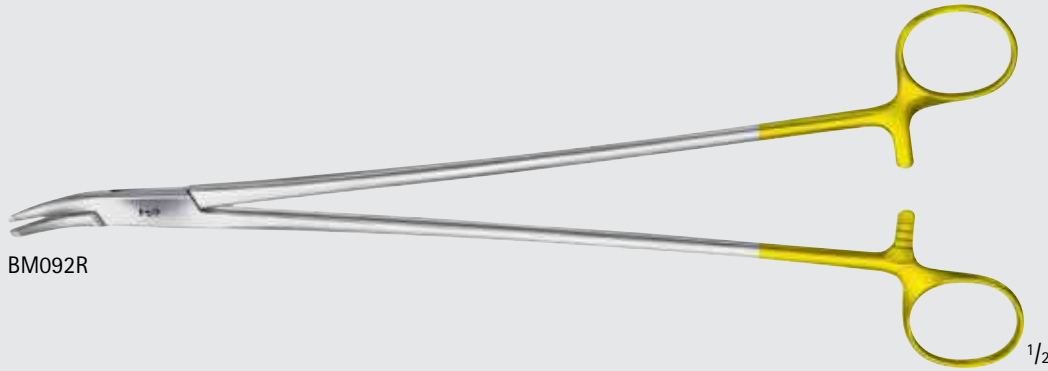

BM092R

1/2

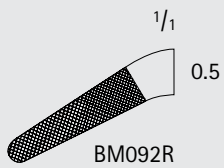

BM092R

DUROGRIP TC STRATTE Needle Holder

Catalog Number	Tip	Jaw	Length (in.)
BM095R	CVD	SERR	8 1/4
BM096R	CVD	SERR	9

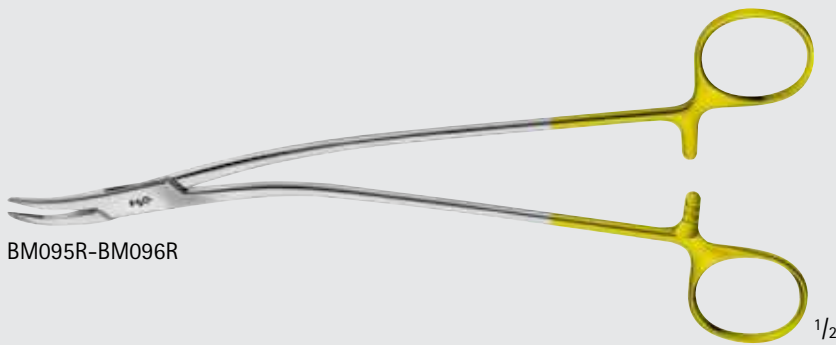

BM095R-BM096R

1/2

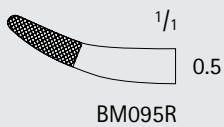

BM095R

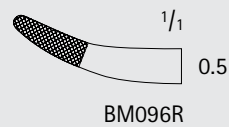

BM096R

DUROGRIP TC Wire Twister

Catalog Number	Tip	Jaw	Length (in.)
BM110R	ROUND	SERR	6 1/8
BM111R	SQUARE	SERR	6

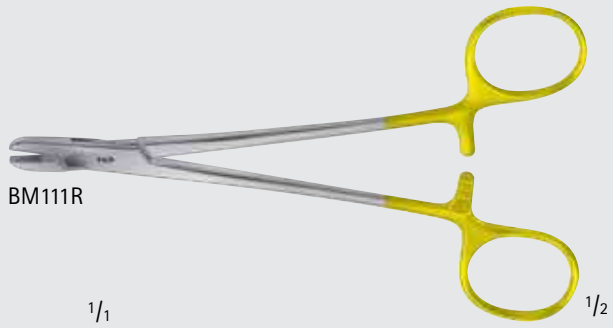
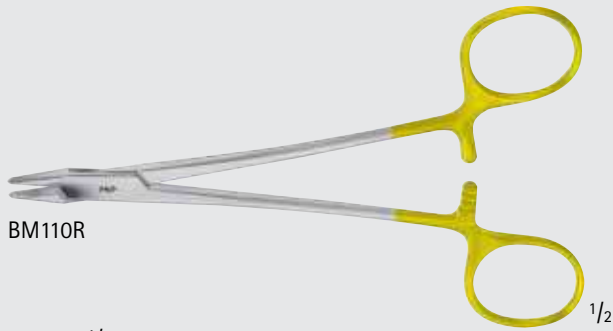

DUROGRIP TC BAUMGARTNER Wire Twister

Catalog Number	Tip	Jaw	Length (in.)
BM112R	SQUARE	SERR	7 7/8

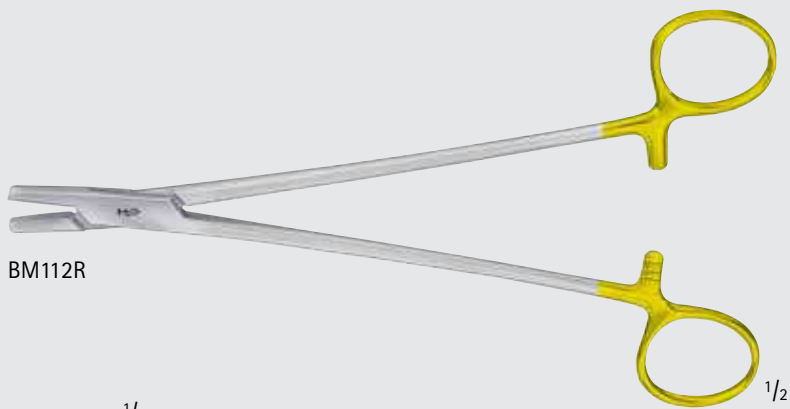

General Surgery

DUROGRIP™ TC Needle Holders

GENERAL SURGERY

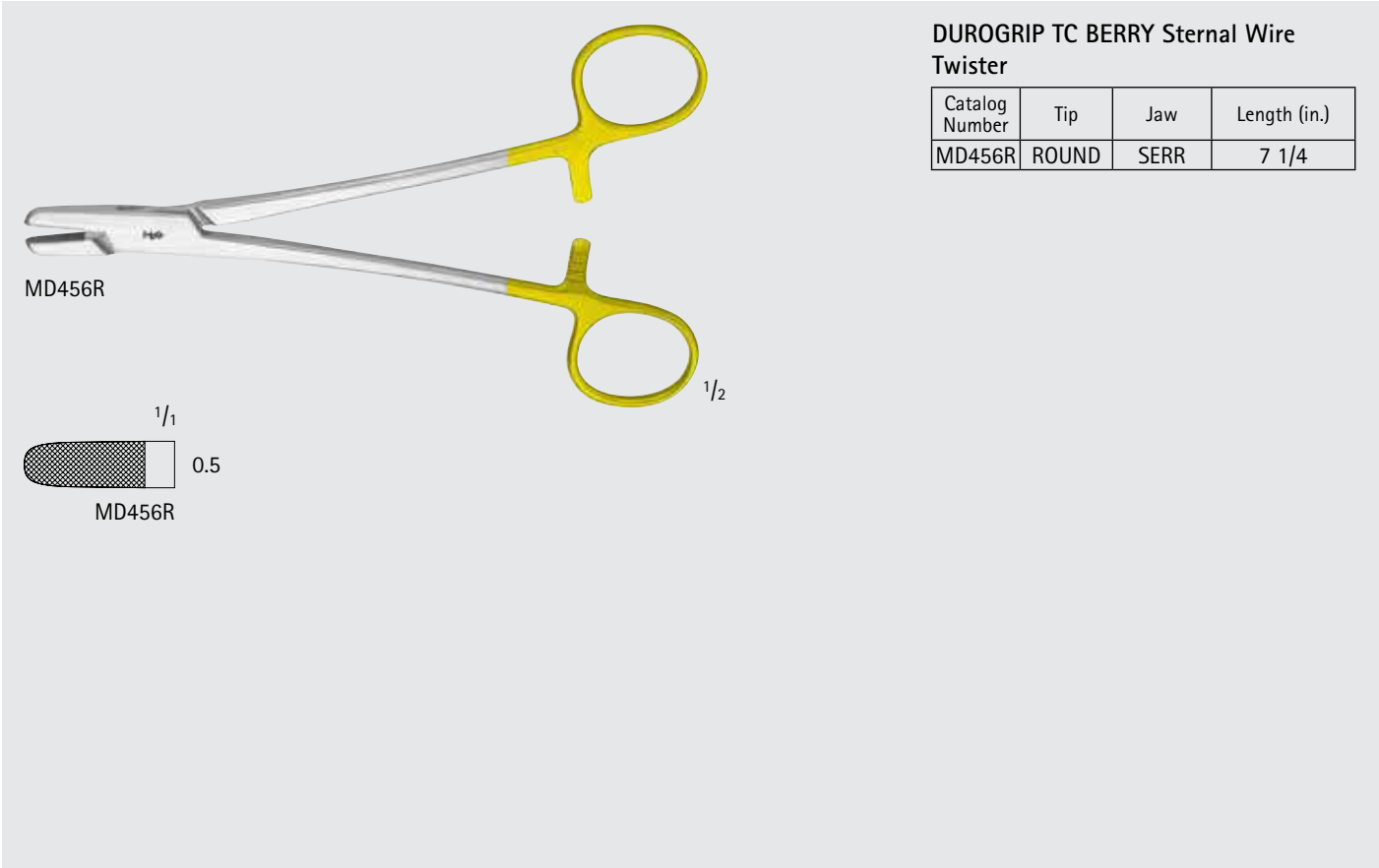
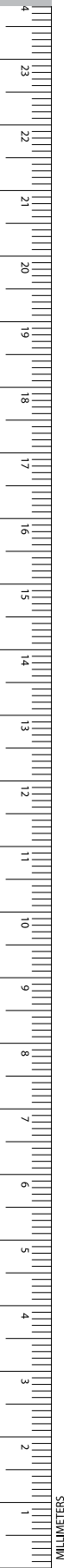

DUROGRIP TC BERRY Sternal Wire Twister

Catalog Number	Tip	Jaw	Length (in.)
MD456R	ROUND	SERR	7 1/4

MD456R

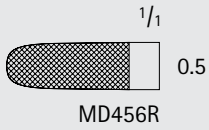

MD456R

1/2

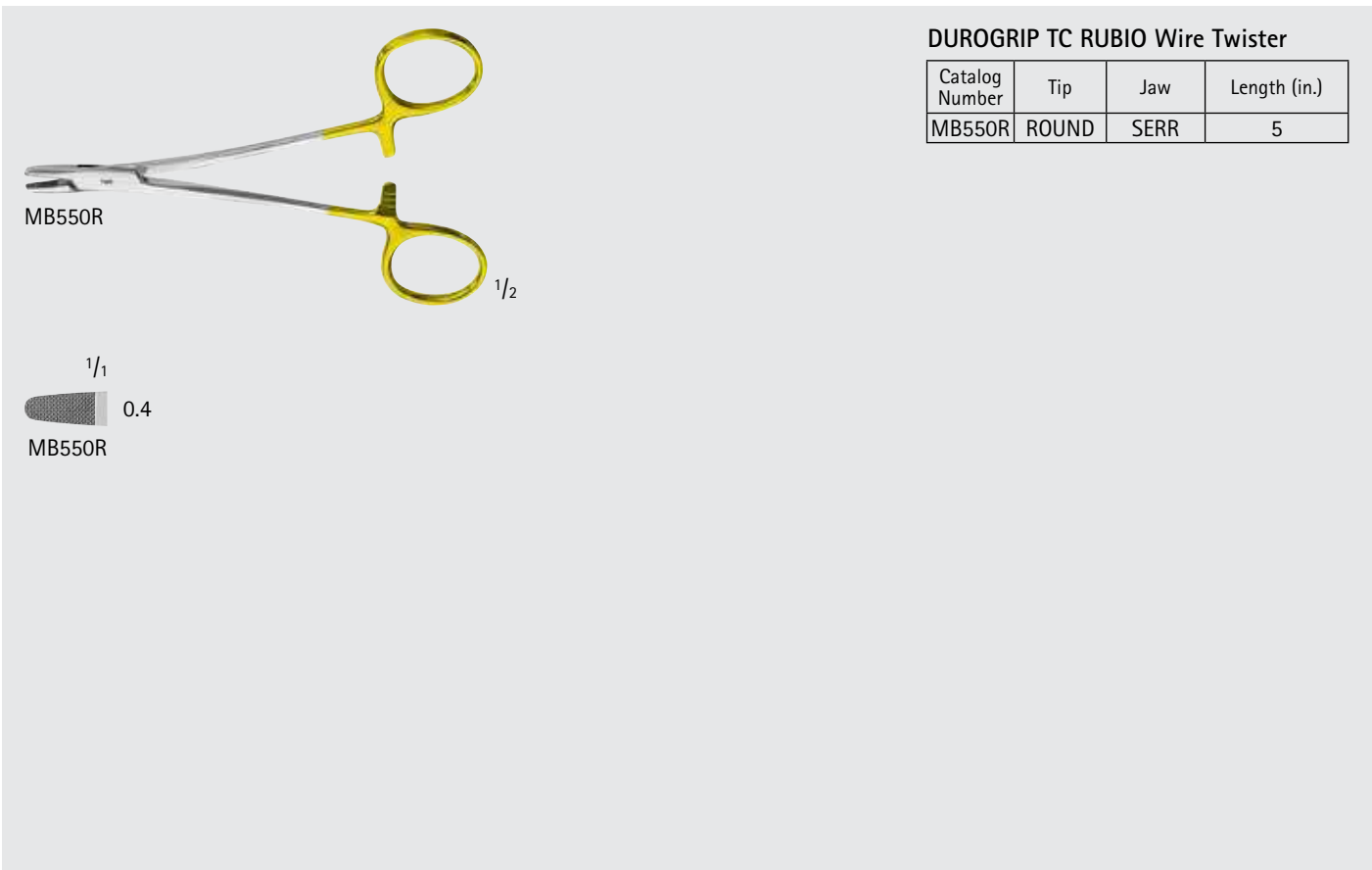

DUROGRIP TC RUBIO Wire Twister

Catalog Number	Tip	Jaw	Length (in.)
MB550R	ROUND	SERR	5

MB550R

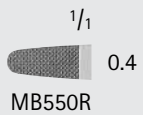

MB550R

1/2



BM149R-BM154R

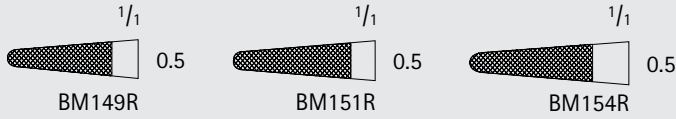

DUROGRIP TC MATHIEU Needle Holder

Catalog Number	Jaw	Length (in.)
BM149R	SERR	5 1/2
BM151R	SERR	6 1/2
BM154R	SERR	7 7/8

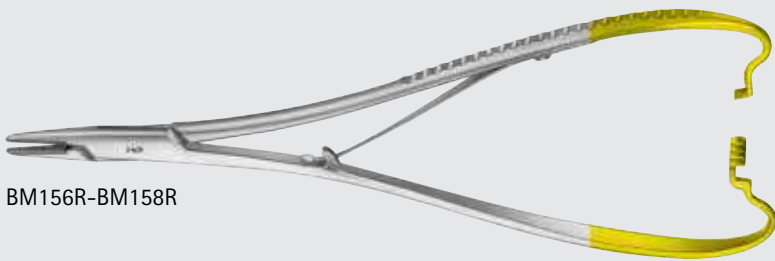

BM156R-BM158R



DUROGRIP TC MATHIEU Needle Holder, Heavy

Catalog Number	Jaw	Length (in.)
BM156R	SERR	7 7/8
BM158R	SERR	9 5/8



INCHES

General Surgery

Needle Cases



BL907R

Needle Case, Rectangle

Catalog Number	Dimensions (mm)
BL907R	70 x 53 x 9



BL930R-BL933R



BL931R-BL933R

Needle Case, Round

Catalog Number	Item	Dimensions (mm)
BL930R	COMPLETE NEEDLE CASE W/ INTERIOR BOX	65 x 16
BL931R	INTERIOR BOX ONLY	62 x 12
BL933R	INTERIOR BOX ONLY	90 x 12



BL941R

Needle Case, With 7 Sections

Catalog Number	Dimensions (mm)
BL941R	150 x 90 x 10

GENERAL SURGERY

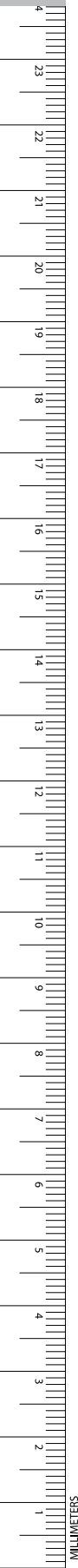



BM822R-BM824R

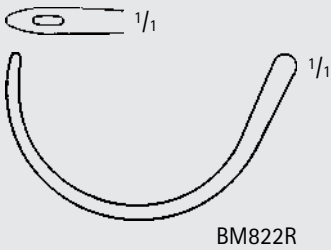

BM822R

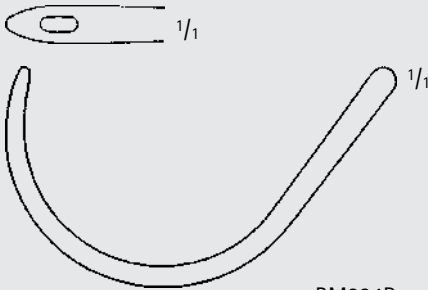

BM824R



BM749R, BM781R, BM807R, BM809R, BM811R, BM813R



BM781R

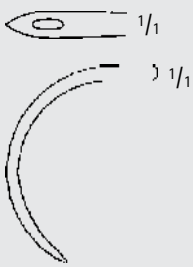

BM749R

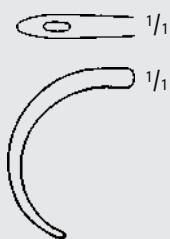

BM809R

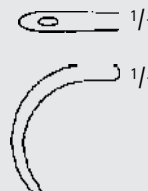

BM807R

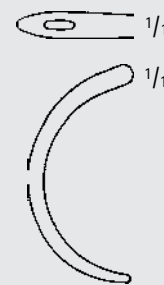

BM811R

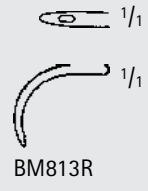

BM813R

DESCHAMPS Needle

Catalog Number	Hand Orientation	Tip	Length (in.)
BM822R	RIGHT	BLUNT, 3.5 MM	9 1/2
BM824R	RIGHT	BLUNT, 5 MM	11
BM781R	LEFT	SHARP, 2 MM	8 1/4
BM749R	LEFT	SHARP, 3.5 MM	8 1/2
BM809R	LEFT	BLUNT, 2.5 MM	8 1/4
BM807R	LEFT	BLUNT, 2.5 MM	8 1/2
BM811R	LEFT	BLUNT, 3.5 MM	8 1/2
BM813R	LEFT	STEEP, BLUNT, 2 MM	8 7/8



General Surgery

Ligature Needles

GENERAL SURGERY

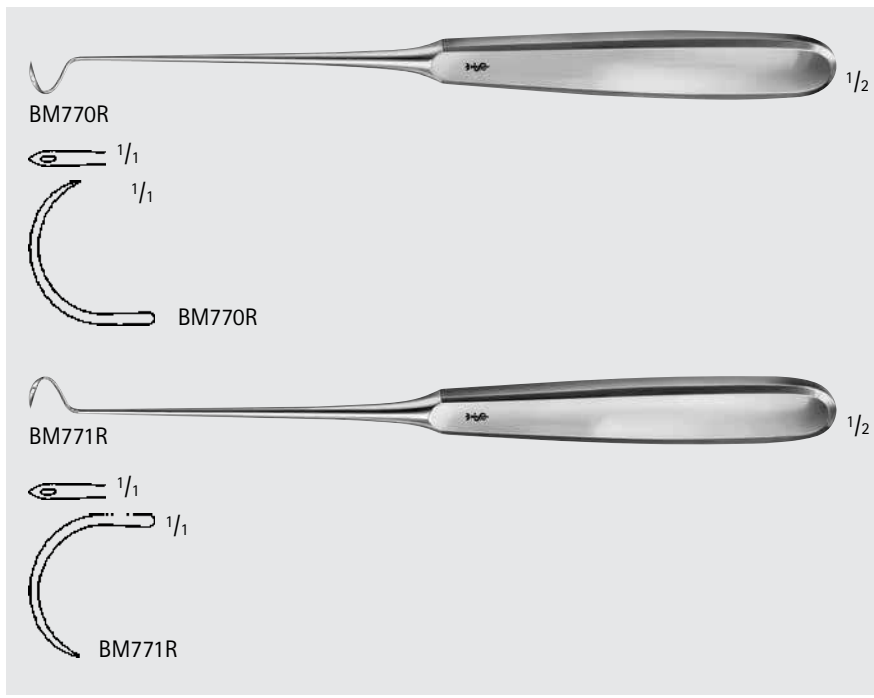

HURD Needle

Catalog Number	Hand Orientation	Tip	Length (in.)
BM770R	RIGHT	SHARP	8 1/4
BM771R	LEFT	SHARP	8 1/4

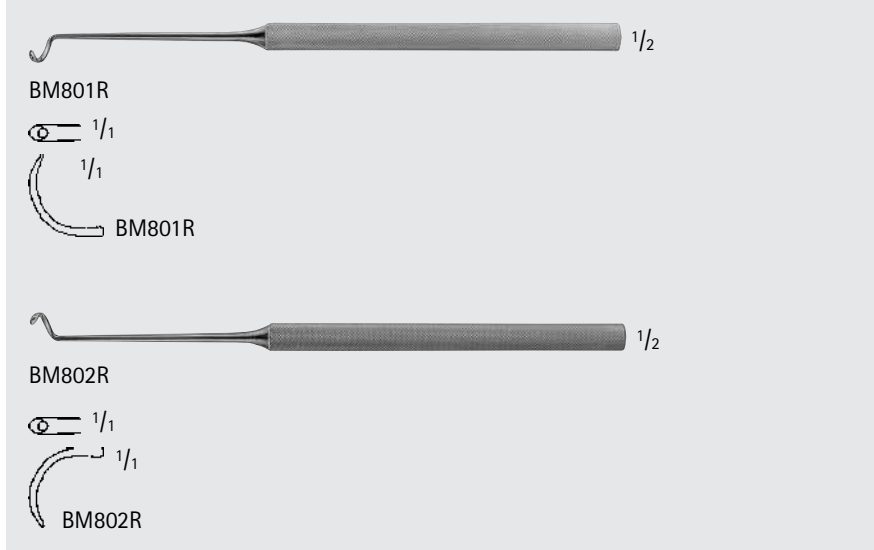

KRONECKER Needle

Catalog Number	Hand Orientation	Tip	Length (in.)
BM801R	RIGHT	BLUNT	6 1/8
BM802R	LEFT	BLUNT	6 1/8

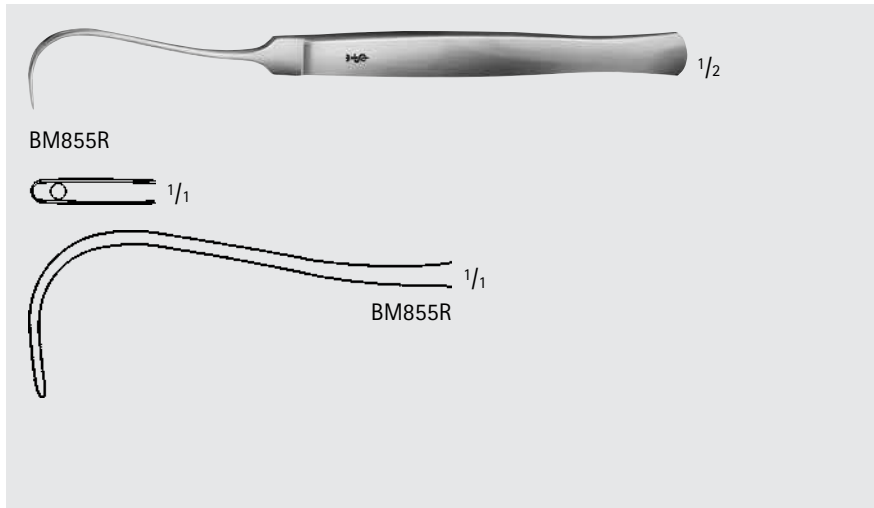

SYME Suture Needle

Catalog Number	Tip	Length (in.)
BM855R	BLUNT	6 3/4

Monopolar Diathermi Forceps, Insulated

Catalog Number	Length (in.)
GK033R	13 3/4

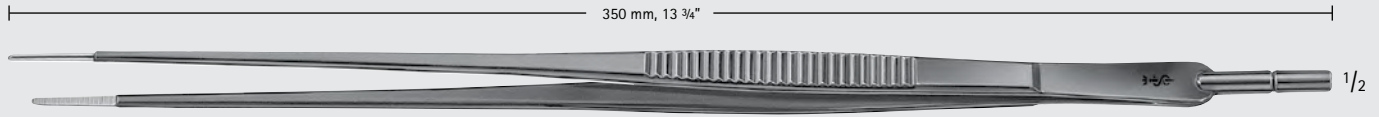

GK033R



Dressing Forceps, Standard Patterns

Catalog Number	Tip	Length (in.)
BD043R	SERR	4 1/2
BD045R	SERR	5 1/8
BD047R	SERR	5 3/4
BD049R	SERR	6 1/4
BD050R	SERR	7
BD051R	SERR	7 7/8
BD052R	SERR	9 3/4
BD053R	SERR	11 3/4



BD043R-BD053R

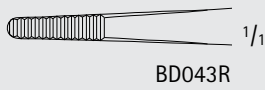

BD043R

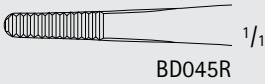

BD045R

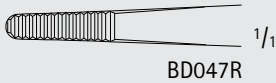

BD047R

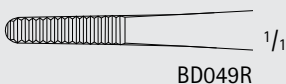

BD049R

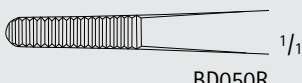

BD050R

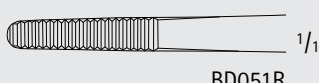

BD051R

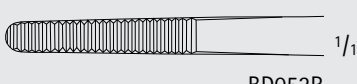

BD052R

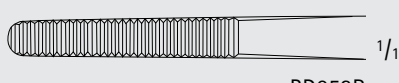

BD053R

Dressing Forceps, Extra Wide

Catalog Number	Tip	Length (in.)
BD077R	SERR	5 3/4



BD077R

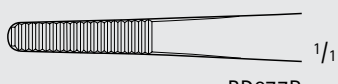

BD077R



INCHES

General Surgery

Dressing and Tissue Forceps

GENERAL SURGERY

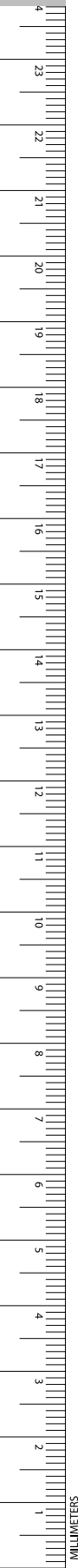

BD023R-BD033R

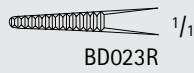

BD023R

1/1

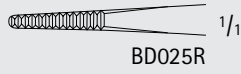

BD025R

1/1



BD027R

1/1



BD029R

1/1

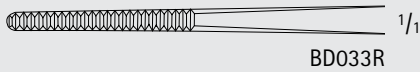

BD033R

1/1



BD035R-BD037R

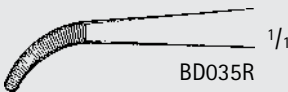

BD035R

1/1



BD037R

1/1

Dressing Forceps, Delicate

Catalog Number	Tip	Length (in.)
BD023R	STR, SERR	4 1/2
BD025R	STR, SERR	5 1/8
BD027R	STR, SERR	5 3/4
BD029R	STR, SERR	6 1/4
BD033R	STR, SERR	12
BD035R	CVD, SERR	5 1/8
BD037R	CVD, SERR	5 1/2



BD210R

1/2

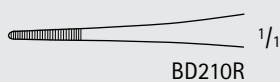

BD210R

1/1

Dressing Forceps, Extra Delicate

Catalog Number	Tip	Length (in.)
BD210R	SERR	4 1/2

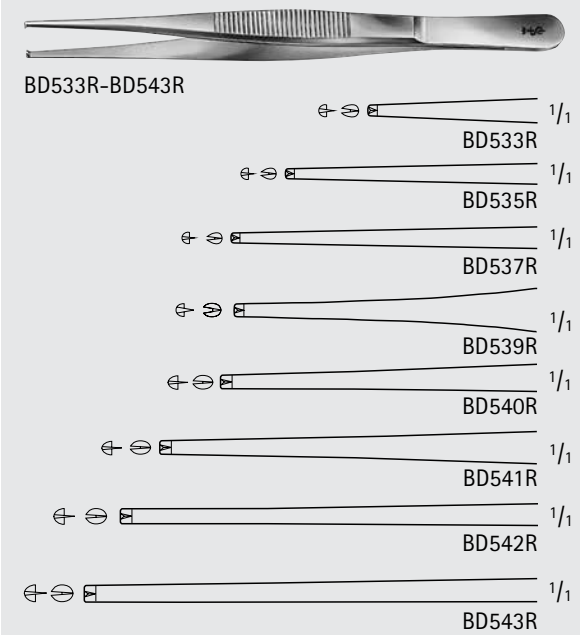

Tissue Forceps, Delicate

Catalog Number	Tip	Teeth	Length (in.)
BD533R	STR	1 x 2	4 1/2
BD535R	STR	1 x 2	5 1/8
BD537R	STR	1 x 2	5 3/4
BD539R	STR	1 x 2	6 1/4
BD540R	STR	1 x 2	7
BD541R	STR	1 x 2	7 7/8
BD542R	STR	1 x 2	9 3/4
BD543R	STR	1 x 2	11 3/4
MB803R	STR	2 x 3	4 1/2
BD575R	STR	2 x 3	5 1/8
BD577R	STR	2 x 3	5 3/4
BD579R	STR	2 x 3	6 1/4
BD580R	STR	2 x 3	7
BD581R	STR	2 x 3	7 7/8
BD587R	STR	3 x 4	5 3/4
BD589R	STR	3 x 4	6 1/4
BD591R	STR	3 x 4	7 7/8
BD527R	CVD	1 x 2	5 3/4

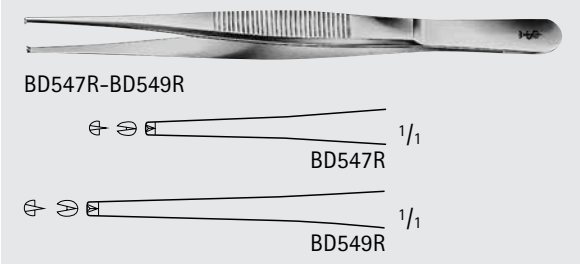
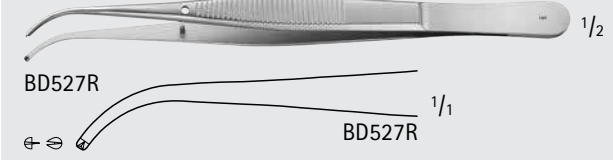
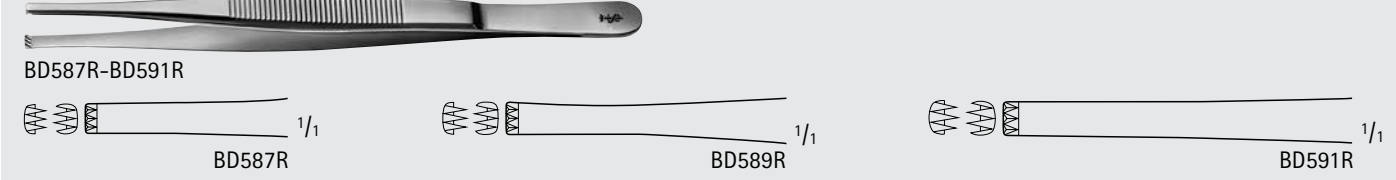
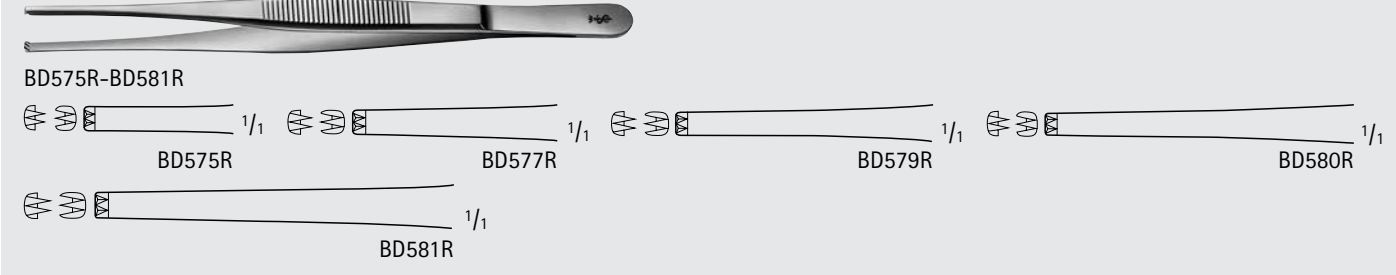

Tissue Forceps, Medium

Catalog Number	Teeth	Length (in.)
BD547R	1 x 2	5 3/4
BD549R	1 x 2	6 1/4



General Surgery

Dressing and Tissue Forceps

GENERAL SURGERY



BD553R-BD563R

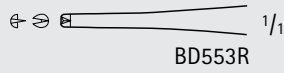

BD553R

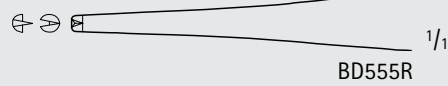

BD555R

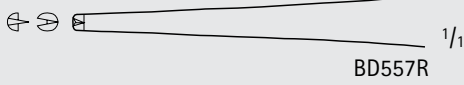

BD557R

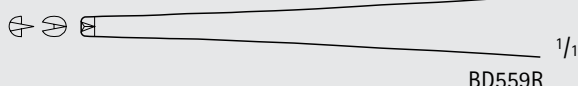

BD559R

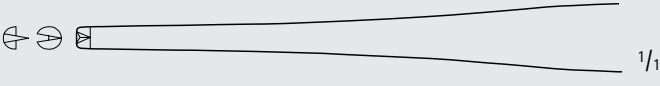

BD560R

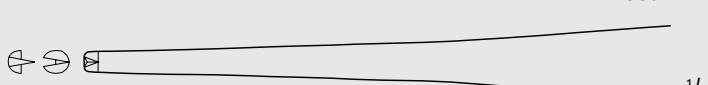

BD561R



BD562R

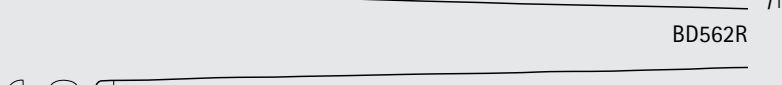

BD563R

Tissue Forceps, Standard Patterns

Catalog Number	Teeth	Length (in.)
BD553R	1 x 2	4 1/2
BD555R	1 x 2	5 1/8
BD557R	1 x 2	5 3/4
BD559R	1 x 2	6 1/4
BD560R	1 x 2	7
BD561R	1 x 2	7 7/8
BD562R	1 x 2	9 3/4
BD563R	1 x 2	11 3/4



BD690R-BD692R



BD690R

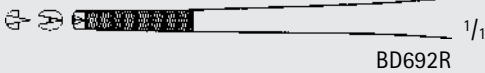

BD692R

STRASSBURGER Tissue Forceps

Catalog Number	Tip	Teeth	Length (in.)
BD690R	X-SERR	1 x 2	6
BD692R	X-SERR	1 x 2	7 7/8

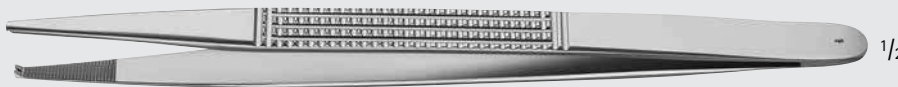

MG077R



MG077R

CURTIS Tissue Forceps

Catalog Number	Tip	Length (in.)
MG077R	SERR	8 3/4



BD693R



BD693R



MG357R



MG357R

BONNEY Tissue Forceps

Catalog Number	Tip	Teeth	Length (in.)
BD693R	SERR	1 x 2	6 7/8
MG357R	SERR	2 x 3	6 3/4



BD733R

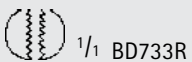

BD733R

MARTIN Tissue Forceps

Catalog Number	Teeth	Length (in.)
BD733R	7 x 8	6 1/8



General Surgery

Dressing and Tissue Forceps

GENERAL SURGERY



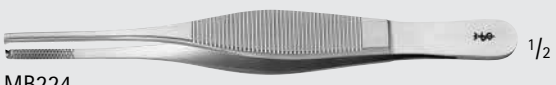



MB224 1/2



MB224 1/1



MG464R-MG465R 1/2



MG464R 1/1



MG465R 1/1

HEANEY Tissue Forceps

Catalog Number	Tip	Teeth	Length (in.)
MG464R	X-SERR	1 x 2	7 1/4
MB224	X-SERR	2 x 3	5 1/2
MG465R	X-SERR	3 x 4	7 1/2



BD725R-BD727R 1/2

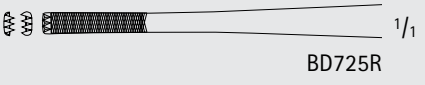

BD725R 1/1

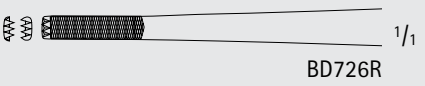

BD726R 1/1

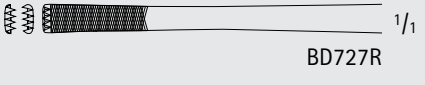

BD727R 1/1

STILLE-BARRAYA CV Forceps

Catalog Number	Tip	Teeth	Length (in.)
BD725R	X-SERR	3 x 4	7
BD726R	X-SERR	3 x 4	7 7/8
BD727R	X-SERR	3 x 4	9 3/4



BD755R 1/2



BD755R 1/1



BD760R-BD761R, MB921R-MB922R, XG006R 1/2

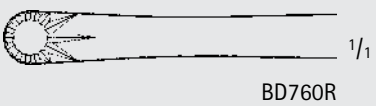

BD760R 1/1

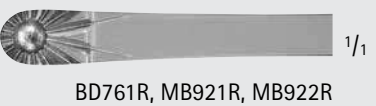

BD761R, MB921R, MB922R 1/1

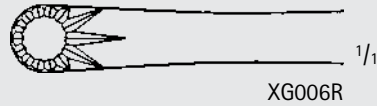

XG006R 1/1

RUSSIAN Tissue Forceps

Catalog Number	Length (in.)
BD755R	6
BD760R	7 7/8
XG006R	9 3/4
BD761R	10 1/4
MB921R	12
MB922R	14



MB208R-MB923R

MAYO-RUSSIAN Tissue Forceps

Catalog Number	Tip	Length (in.)
MB208R	FENESTRATED	9
MB923R	FENESTRATED	14



BD750R

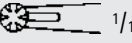

BD750R



MB795R



MB795R



MG078R



MG078R

SELMAN Tissue Forceps

Catalog Number	Length (in.)
BD750R	6 1/8
MB795R	7 7/8
MG078R	9 3/4



General Surgery

Dressing and Tissue Forceps

GENERAL SURGERY



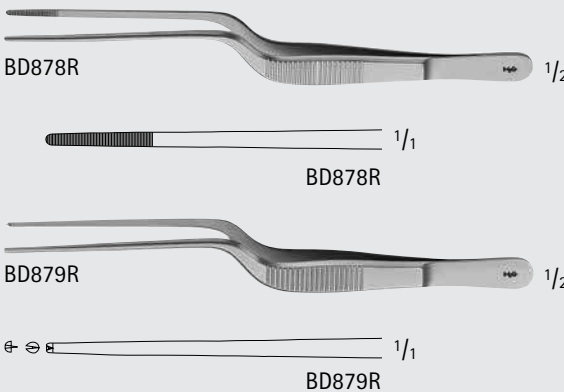

BD878R 1/2

BD878R 1/1

BD879R 1/2

BD879R 1/1

LUCAE Bayonet Forceps

Catalog Number	Tip	Teeth	Length (in.)
BD878R	SERR	-	5 1/2
BD879R	SMOOTH	1 x 2	5 1/2

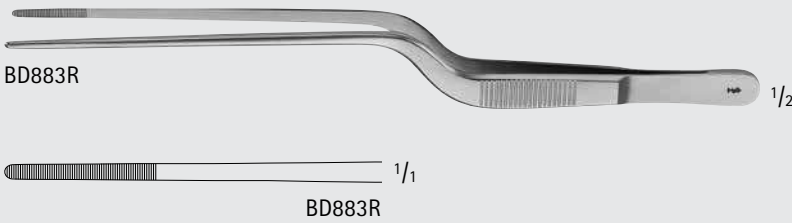

BD883R 1/2

BD883R 1/1

GRUENWALD Bayonet Forceps

Catalog Number	Tip	Length (in.)
BD883R	SERR	7 7/8

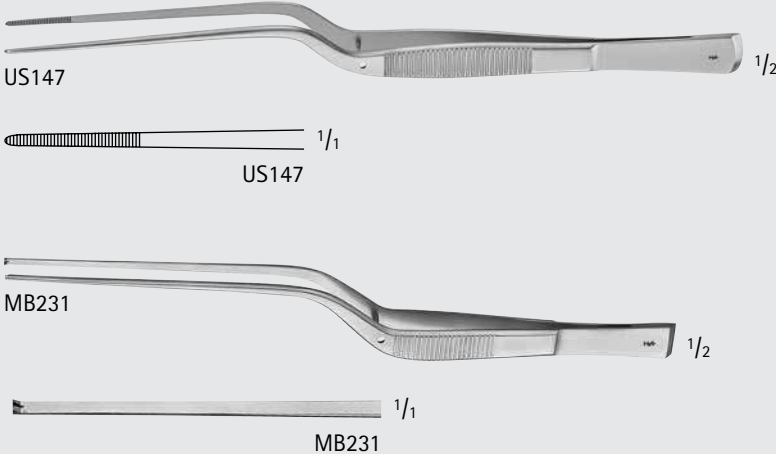

US147 1/2

US147 1/1

MB231 1/2

MB231 1/1

CUSHING Bayonet Forceps

Catalog Number	Tip	Teeth	Length (in.)
US147	SERR	-	7 3/4
MB231	SMOOTH	1 x 2	7 1/4

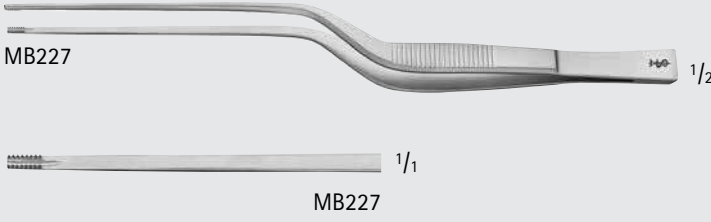

MB227 1/2

MB227 1/1

BROWN-CUSHING Bayonet Forceps

Catalog Number	Teeth	Length (in.)
MB227	7 x 7	7 1/4



BROWN-BAHNSON Bayonet Forceps



Catalog Number	Tip	Length (in.)
BD876R	SERR	6 1/8
MB804R	SERR	8

JANSEN Bayonet Forceps

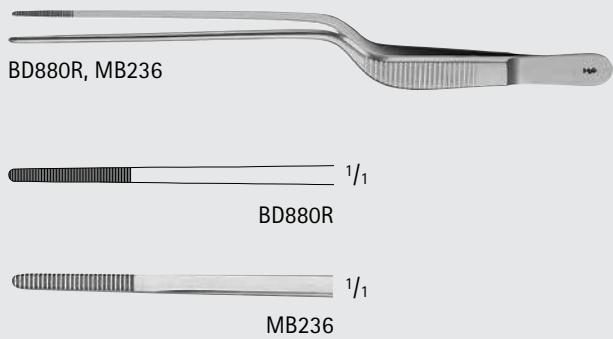

Catalog Number	Tip	Length (in.)
BD880R	SERR	6 1/4
MB236	SERR	6 1/2

Bayonet Forceps

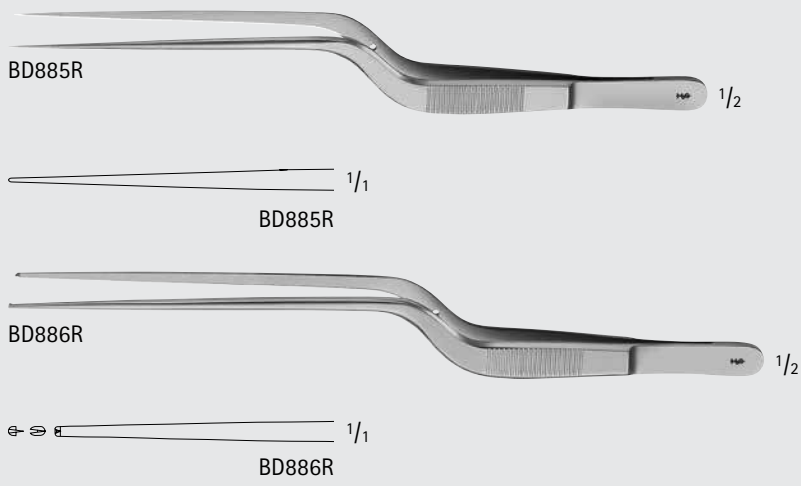

Catalog Number	Tip	Teeth	Length (in.)
BD885R	SMOOTH	-	7 1/4
BD886R	SMOOTH	1 x 2	7 7/8

GERALD Bayonet Forceps

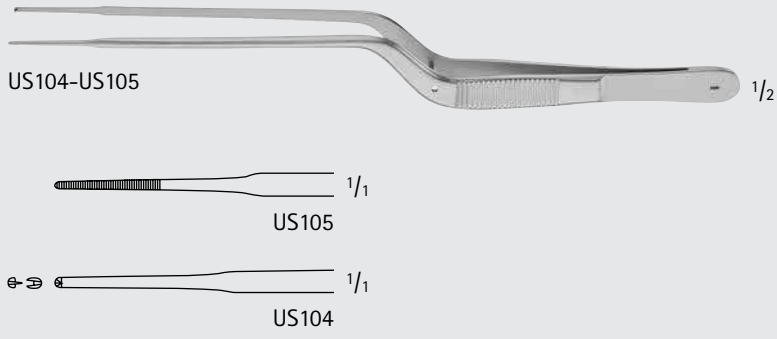

Catalog Number	Tip	Teeth	Length (in.)
US105	SERR	-	7 1/2
US104	SMOOTH	1 x 2	7 1/2

General Surgery

Dressing and Tissue Forceps

GENERAL SURGERY

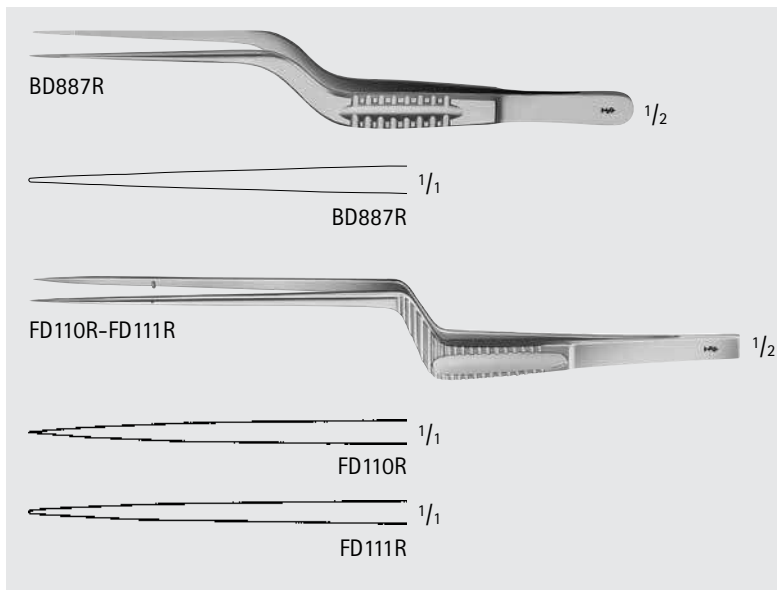
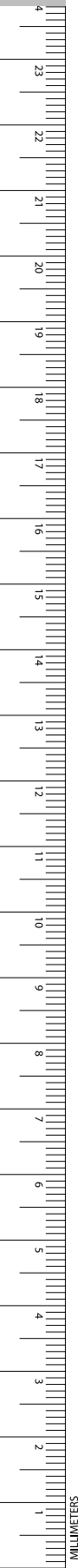

Bayonet Forceps

Catalog Number	Tip	Length (in.)
BD887R		6 1/4
FD110R	FINE	7 1/4
FD111R	BROAD	7 1/4



TROELTSCH Bayonet Forceps

Catalog Number	Tip	Length (in.)
BD900R	ANG/SERR	4
BD902R	ANG/SERR	4 1/2
BD910R	ANG/SERR	5 1/2
BD911R	ANG/SERR	6 3/4

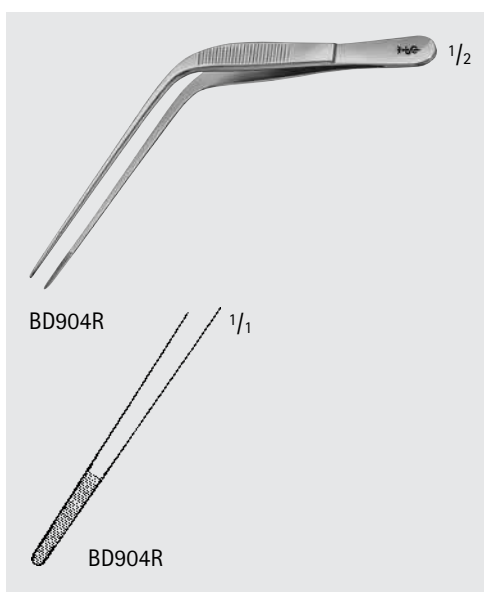
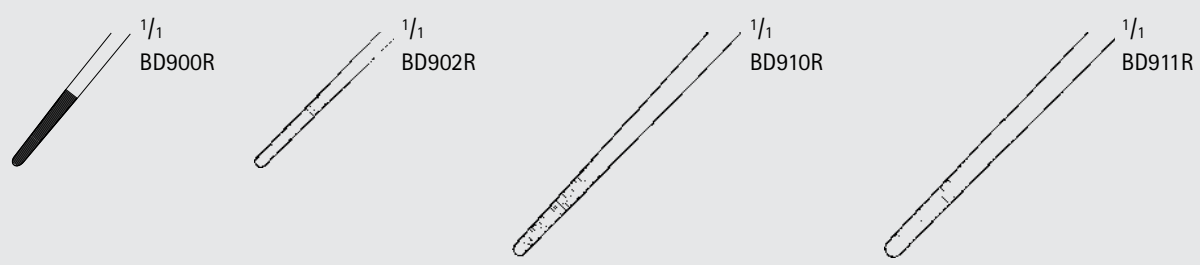

WILDE Bayonet Forceps

Catalog Number	Tip	Length (in.)
BD904R	ANG/SERR	4 1/2



HUDSON Forceps

Catalog Number	Tip	Teeth	Length (in.)
BD225R	SERR	-	5
MB291R	SMOOTH	1 x 2	5

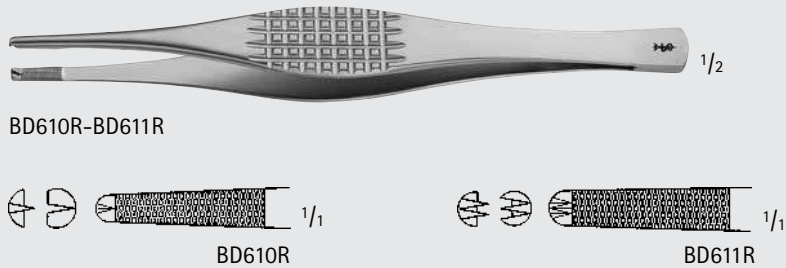

FERRIS-SMITH Tissue Forceps

Catalog Number	Tip	Teeth	Length (in.)
BD610R	X-SERR	1 x 2	6 7/8
BD611R	X-SERR	2 x 3	6 7/8



SEMKEN Forceps, Delicate

Catalog Number	Tip	Teeth	Length (in.)
BD215R	SERR	-	5
BD216R	SERR	-	6
BD665R	SMOOTH	1 x 2	5
BD667R	SMOOTH	1 x 2	6
BD666R	SMOOTH	2 x 3	5

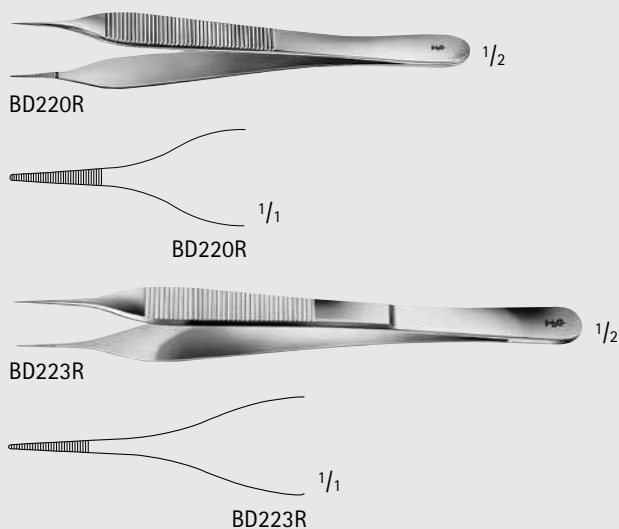
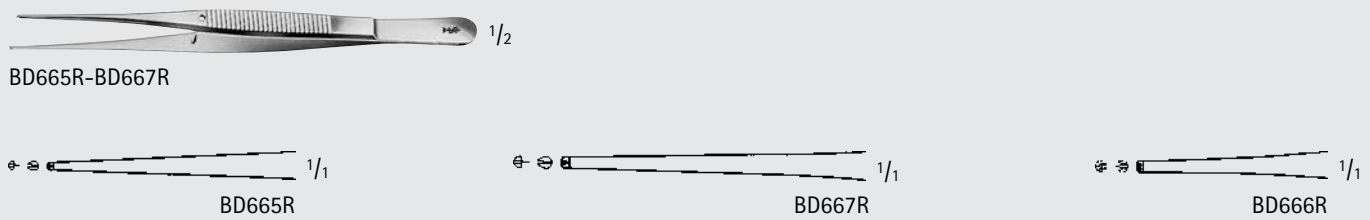

Micro ADSON Forceps, Delicate

Catalog Number	Tip	Length (in.)
BD220R	SERR, W/ PLATFORM	4 3/4
BD223R	SERR	6

General Surgery

Dressing and Tissue Forceps

GENERAL SURGERY

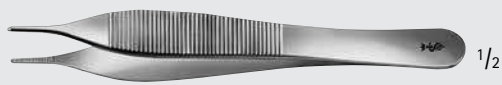

BD222R, MA156R

1/2



BD222R 1/1

MA156R 1/1



BD511R

1/2

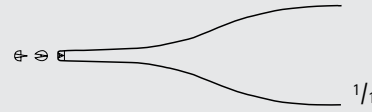

1/1



MG275R

1/2

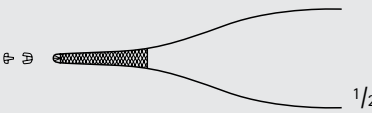

1/2



BD512R

1/2

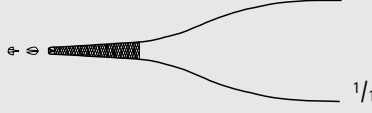

1/1



MA536R

1/2

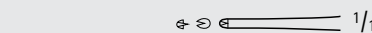

1/1

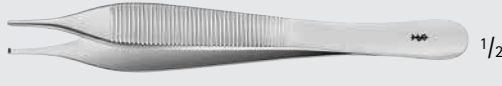

MB454R

1/2

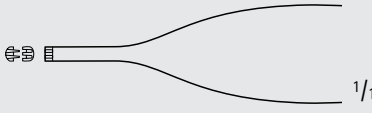

1/1



BD506R

1/2

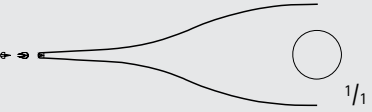

1/1



BD507R

1/2



1/1



BD508R

1/2

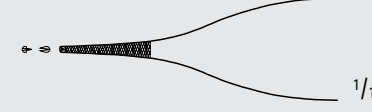

1/1



BD513R

1/2

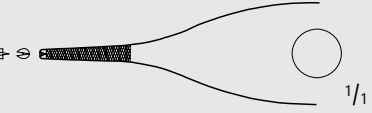

1/1

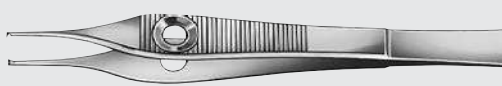

BD521R

1/2



1/1

ADSON Forceps, Delicate

Catalog Number	Tip	Teeth	Handle	Length (in.)
BD222R	SERR	-	-	4 3/4
MA156R	SERR, X-LONG	-	-	4 3/4
BD511R	SMOOTH	1 x 2	-	4 3/4
MG275R	SERR	1 x 2	-	4 3/4
BD512R	X-SERR W/ PLATFORM	1 x 2	-	4 3/4
MA536R	X-LONG	1 x 2	-	4 3/4
MB454R	SMOOTH	2 x 3	-	4 3/4
BD506R	SMOOTH	1 x 2	FENE-STRATED	4 3/4
BD507R	SMOOTH	1 x 2	FENE-STRATED	4 3/4
BD508R	SERR	1 x 2	FENE-STRATED	4 3/4
BD513R	X-SERR W/ PLATFORM	1 x 2	FENE-STRATED	4 3/4
BD521R	SMOOTH	1 x 2	FENE-STRATED	6

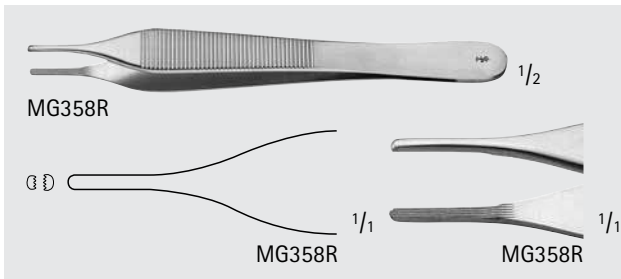

MUSTARDE Suture Removal Forceps

Catalog Number	Tip	Length (in.)
MG358R	LONGITUDINAL, SERR	5

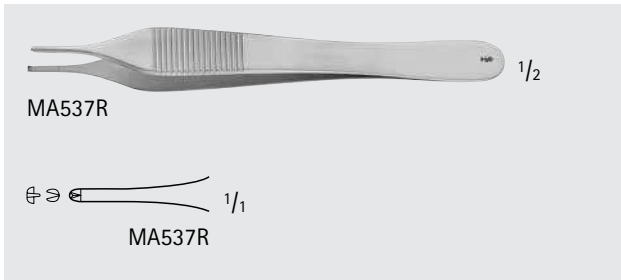

CALLISON-ADSON Tissue Forceps, W/ Platform

Catalog Number	Teeth	Length (in.)
MA537R	1 x 2	5

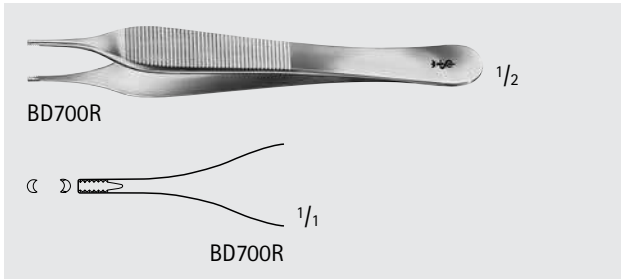

ADSON-BROWN Tissue Forceps

Catalog Number	Teeth	Length (in.)
BD700R	7 x 8	4 3/4

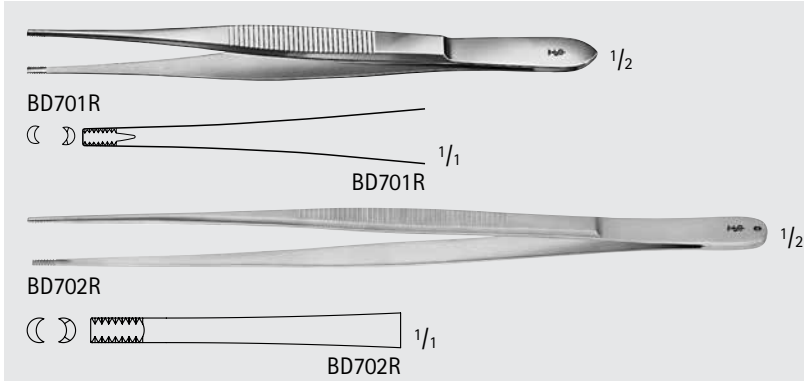

BROWN Tissue Forceps

Catalog Number	Teeth	Length (in.)
BD701R	7 x 8	6
BD702R	7 x 8	7 7/8

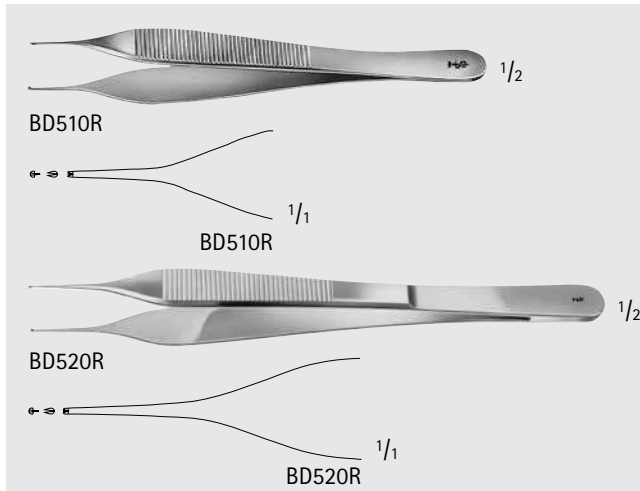

MICRO ADSON Tissue Forceps, Delicate

Catalog Number	Teeth	Length (in.)
BD510R	1 x 2	4 3/4
BD520R	1 x 2	6



General Surgery

Dressing and Tissue Forceps

GENERAL SURGERY



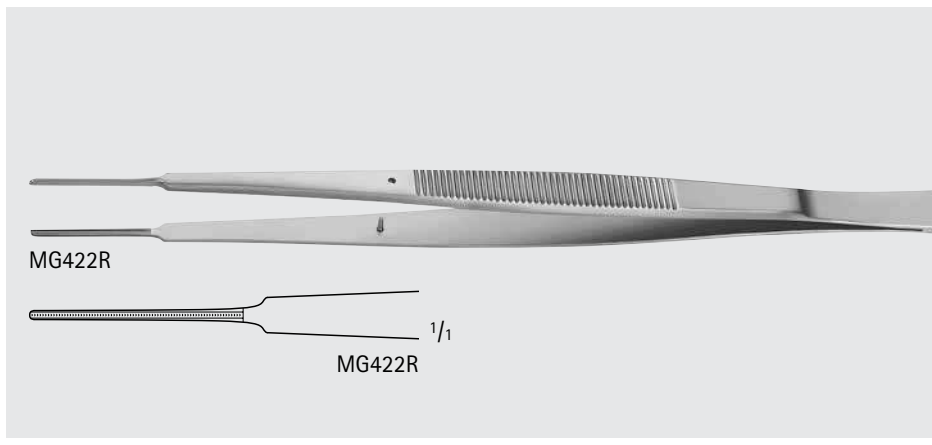

GERALD Tissue Forceps, Delicate

Catalog Number	Tip	Teeth	Length (in.)
BD662R	STR	1 x 2	6 7/8
BD664R	STR	1 x 2	9
BD663R	CVD	1 x 2	6 7/8



GERALD-DEBAKEY Forceps, Narrow

Catalog Number	Tip	Length (in.)
MG422R	SERR	9



ADSON Tissue Forceps, Delicate

Catalog Number	Teeth	Length (in.)
BD522R	1 x 2	7

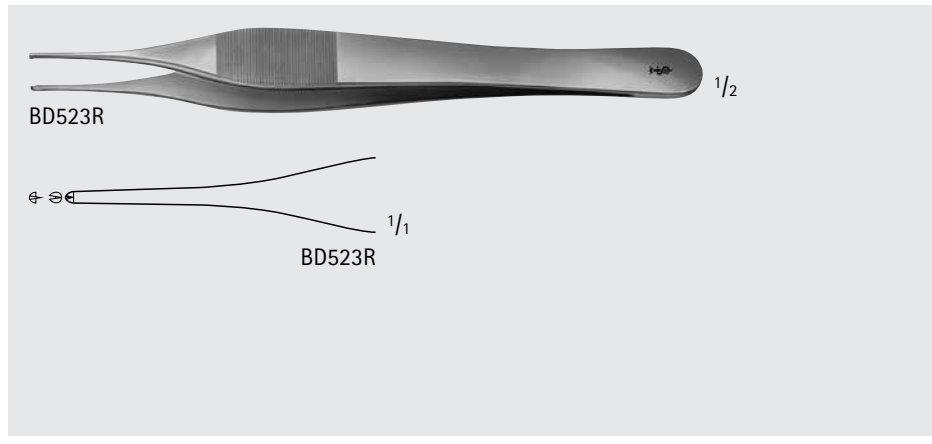

JEFFERSON Tissue Forceps, Delicate

Catalog Number	Teeth	Length (in.)
BD523R	1 x 2	7



BD228R-BD230R

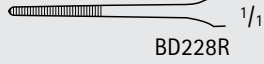

BD228R

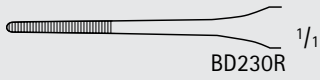

BD230R

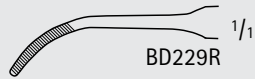

BD229R

GERALD Dressing Forceps, Delicate

Catalog Number	Tip	Length (in.)
BD228R	STR, SERR	6 7/8
BD230R	STR, SERR	9
BD229R	CVD, SERR	6 7/8



BD236R

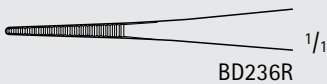

BD236R

MCINDOE Thumb Forceps, Delicate

Catalog Number	Tip	Length (in.)
BD236R	SERR	6



BD661R



BD661R

MCINDOE Tissue Forceps, Delicate

Catalog Number	Tip	Teeth	Length (in.)
BD661R	SERR	1 x 2	6



BD257R

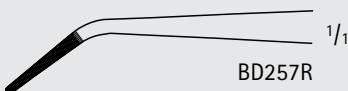

BD257R

Delicate Forceps, Angled

Catalog Number	Tip	Length (in.)
BD257R	SERR	7 7/8



General Surgery

Dressing and Tissue Forceps

GENERAL SURGERY



BD238R-BD243R

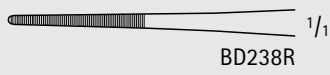

BD238R

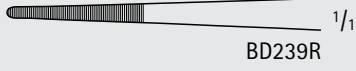

BD239R

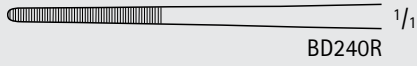

BD240R

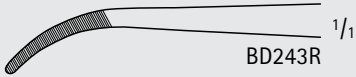

BD243R

CUSHING Forceps, Delicate

Catalog Number	Tip	Length (in.)
BD238R	STR, SERR	7
BD239R	STR, SERR	7 7/8
BD240R	STR, SERR	9 3/4
BD243R	CVD, SERR	7 7/8



MD463

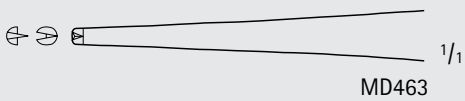

MD463

CUSHING Tissue Forceps

Catalog Number	Teeth	Length (in.)
MD463	1 x 2	7



BD246R

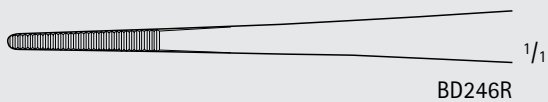

BD246R

BROPHY Forceps, Delicate

Catalog Number	Tip	Length (in.)
BD246R	SERR	7 7/8



BD231R-BD232R

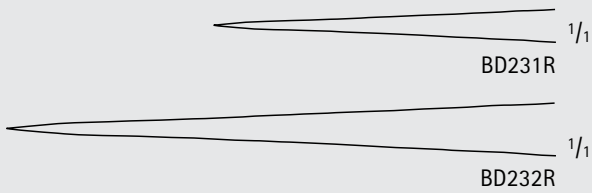

Forceps, Delicate

Catalog Number	Tip	Length (in.)
BD231R	SMOOTH	7
BD232R	SMOOTH	7 7/8



BD301R-BD305R

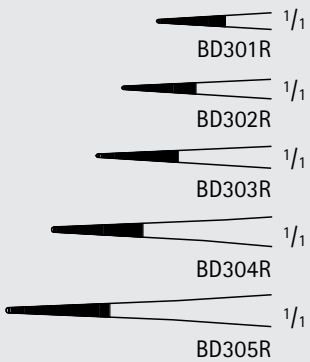

Micro Dressing Forceps

Catalog Number	Tip	Length (in.)
BD301R	STR, SERR	3 1/2
BD302R	STR, SERR	4 1/8
BD303R	STR, SERR	4 1/2
BD304R	STR, SERR	5 1/8
BD305R	STR, SERR	5 3/4
BD311R	CVD, SERR	3 1/2
BD312R	CVD, SERR	4 1/8
BD313R	CVD, SERR	4 1/2
BD314R	CVD, SERR	5 1/8
BD315R	CVD, SERR	5 3/4



BD311R-BD315R

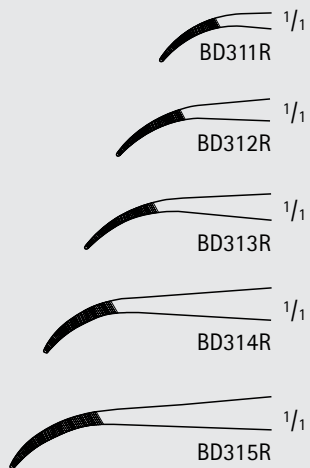

General Surgery

Dressing and Tissue Forceps

GENERAL SURGERY

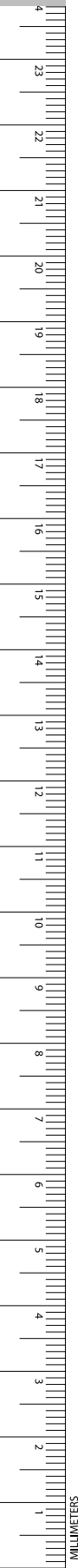



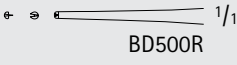

BD500R 1/2



BD500R 1/1



BD501R 1/2



BD501R 1/1



BD502R 1/2



BD502R 1/1

Micro Tissue Forceps

Catalog Number	Teeth	Length (in.)
BD500R	1 x 2	4
BD501R	1 x 2	4 1/4
BD502R	2 x 3	4 1/4



BD335R 1/2

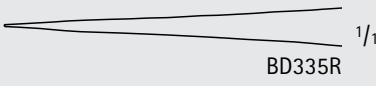

BD335R 1/1

Micro Forceps #3 Jewelers

Catalog Number	Tip Size (mm)	Length (in.)
BD335R	0.3	5 1/4



BD330R 1/2

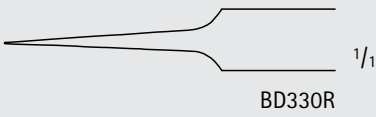

BD330R 1/1

Micro Forceps #4 Jewelers

Catalog Number	Tip Size (mm)	Length (in.)
BD330R	0.2	4 1/4



BD331R 1/2

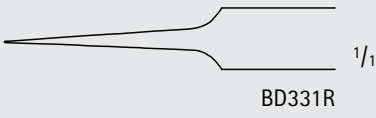

BD331R 1/1

Micro Forceps #5 Jewelers

Catalog Number	Tip Size (mm)	Length (in.)
BD331R	0.15	4 1/4



BD333R 1/2



BD333R 1/1

Micro Forceps #7 Jewelers

Catalog Number	Tip Size (mm)	Length (in.)
BD333R	0.2	4 1/2

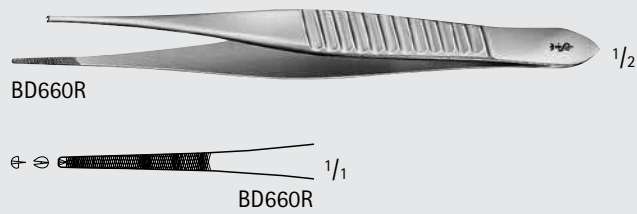

GILLIES Tissue Forceps, Delicate

Catalog Number	Tip	Teeth	Length (in.)
BD660R	X-SERR	1 x 2	6 1/8

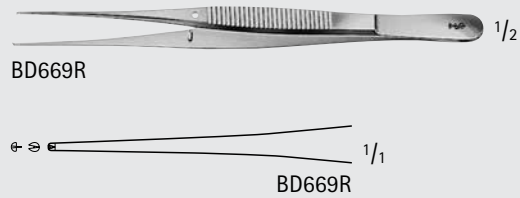

SEMKEN Tissue Forceps, Delicate

Catalog Number	Teeth	Length (in.)
BD669R	1 x 2	5 3/4

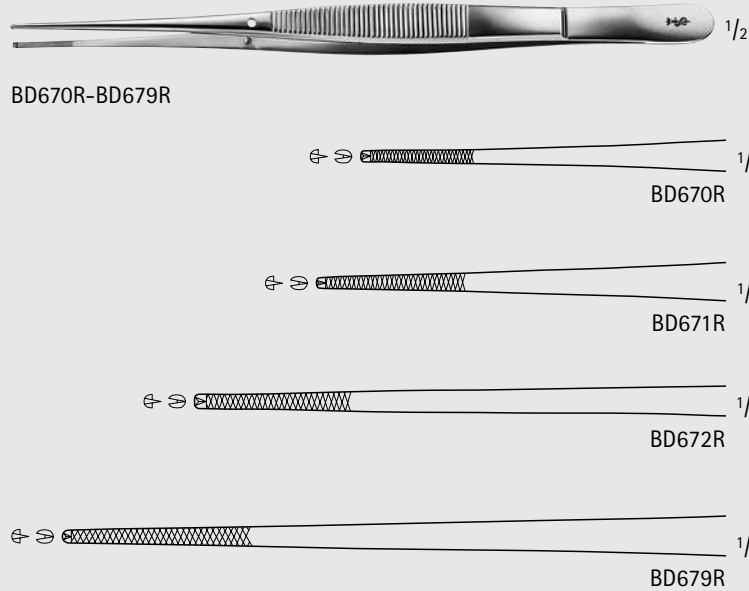

WAUGH Tissue Forceps, Delicate

Catalog Number	Tip	Teeth	Length (in.)
BD670R	X-SERR	1 x 2	7
BD671R	X-SERR	1 x 2	7 7/8
BD672R	X-SERR	1 x 2	9 3/4
BD679R	X-SERR	1 x 2	12

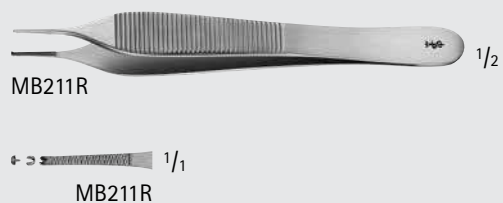

DOCKTOR Forceps

Catalog Number	Tip	Teeth	Length (in.)
MB211R	X-SERR	1 x 2	4 3/4



General Surgery

Dressing and Tissue Forceps

GENERAL SURGERY

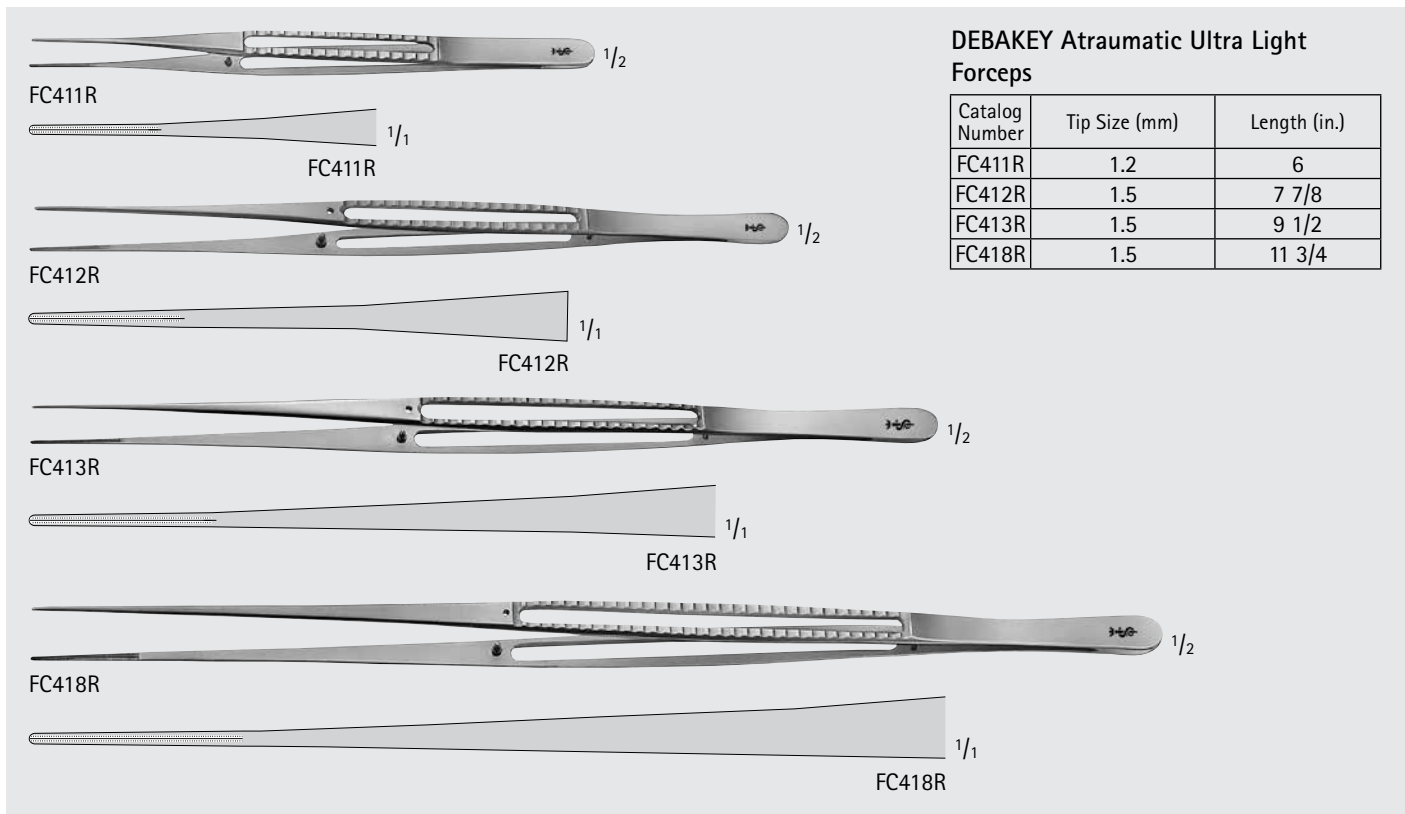
DEBAKEY Atraumatic Ultra Light Forceps

Catalog Number	Tip Size (mm)	Length (in.)
FC411R	1.2	6
FC412R	1.5	7 7/8
FC413R	1.5	9 1/2
FC418R	1.5	11 3/4



DEBAKEY Atraumatic Vascular Tissue Forceps

Catalog Number	Tip Size (mm)	Length (in.)
FB394R	1	6
FB395R	1	7 3/4
FB396R	1	9 1/2

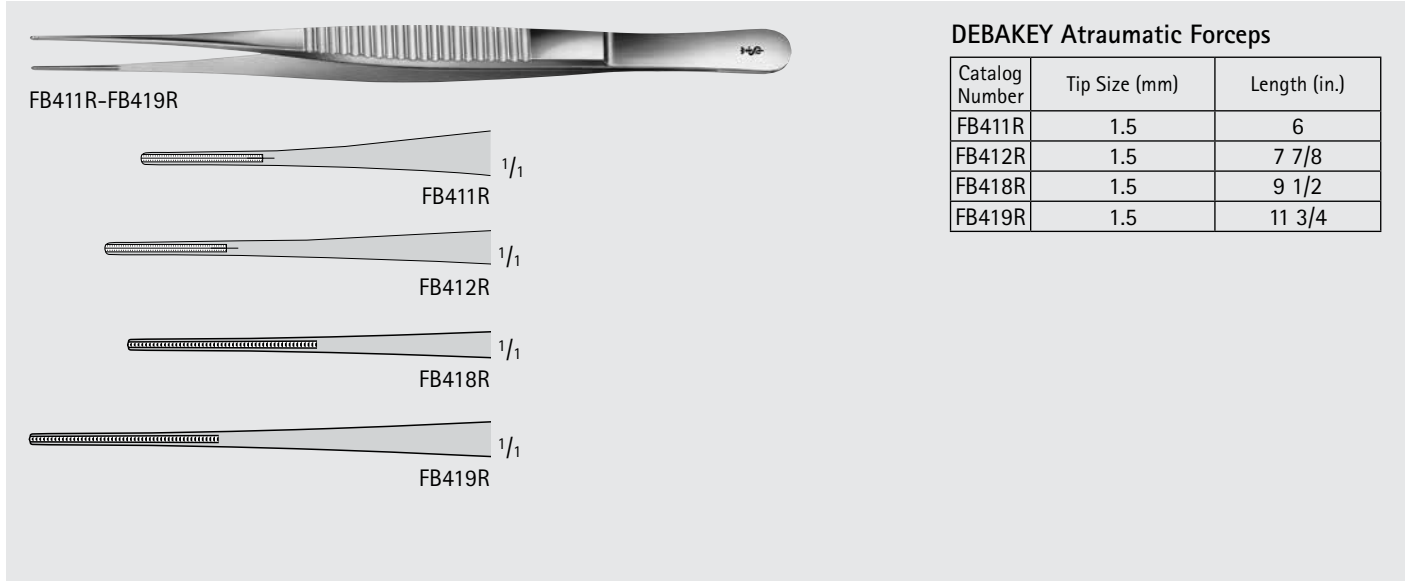

DEBAKEY Atraumatic Forceps

Catalog Number	Tip Size (mm)	Length (in.)
FB411R	1.5	6
FB412R	1.5	7 7/8
FB418R	1.5	9 1/2
FB419R	1.5	11 3/4

DEBAKEY Atraumatic Forceps

Catalog Number	Tip Size (mm)	Length (in.)
FB400R	2	6
FB402R	2	7 7/8
FB404R	2	9 1/2
FB405R	2	11 3/4
FB414R	2.8	6
FB415R	2.8	7 7/8
FB416R	2.8	9 1/2
FB417R	2.8	11 3/4
FB406R	3.5	7 7/8
FB407R	3.5	9 1/2
FB408R	3.5	11 3/4
FB409R	3.5	13 3/4

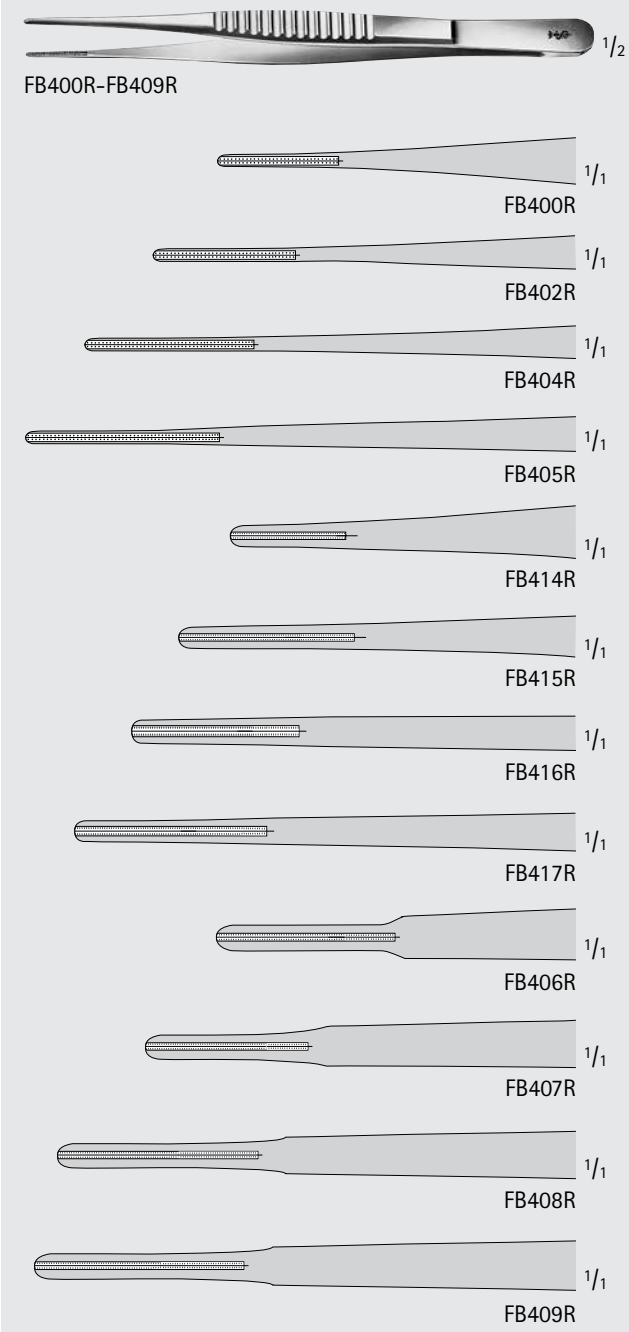

General Surgery

Dressing and Tissue Forceps

GENERAL SURGERY

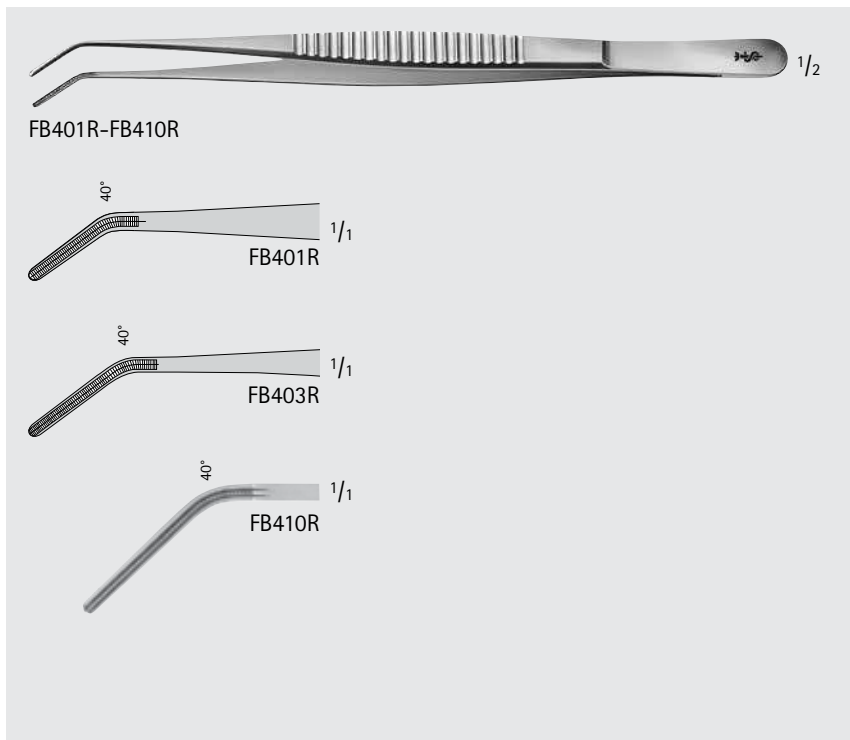

DEBAKEY Atraumatic Forceps, Angled

Catalog Number	Tip Size (mm)	Length (in.)
FB401R	2	6
FB403R	2	7 7/8
FB410R	2	9 1/2

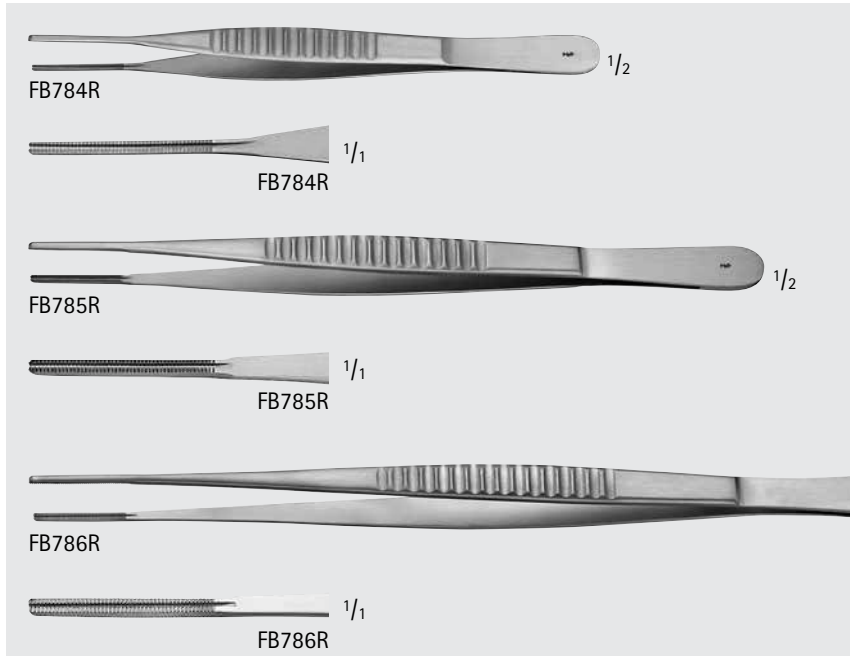

COOLEY Atraumatic Vascular Tissue Forceps

Catalog Number	Tip Size (mm)	Length (in.)
FB784R	1.5	6
FB785R	2.0	7 3/4
FB786R	2.3	9 1/2



COOLEY Vascular Tissue Forceps

Catalog Number	Length (in.)
BD250R	7 7/8



BD770R

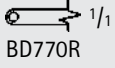

BD770R

MILLS Mammary/Coronary Tissue Forceps

Catalog Number	Length (in.)
BD770R	7



FB130R

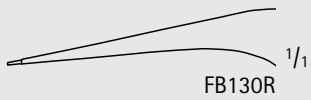

FB130R

Dilator Forceps

Catalog Number	Tip Size (mm)	Length (in.)
FB130R	0.2	4 1/2



BD980R

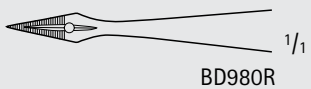

BD980R

HUNTER Splinter Forceps

Catalog Number	Length (in.)
BD980R	4 1/8



INCHES

General Surgery

DUROGRIP™ TC Tissue Forceps

GENERAL SURGERY

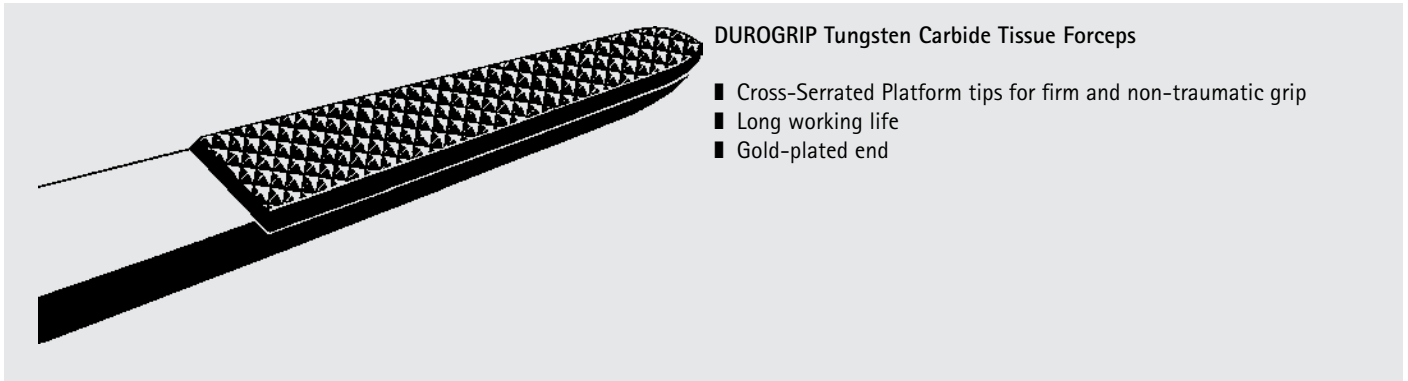
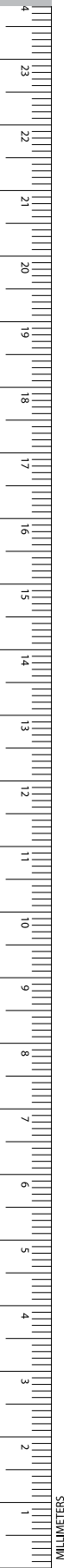

DUROGRIP Tungsten Carbide Tissue Forceps

- Cross-Serrated Platform tips for firm and non-traumatic grip
- Long working life
- Gold-plated end

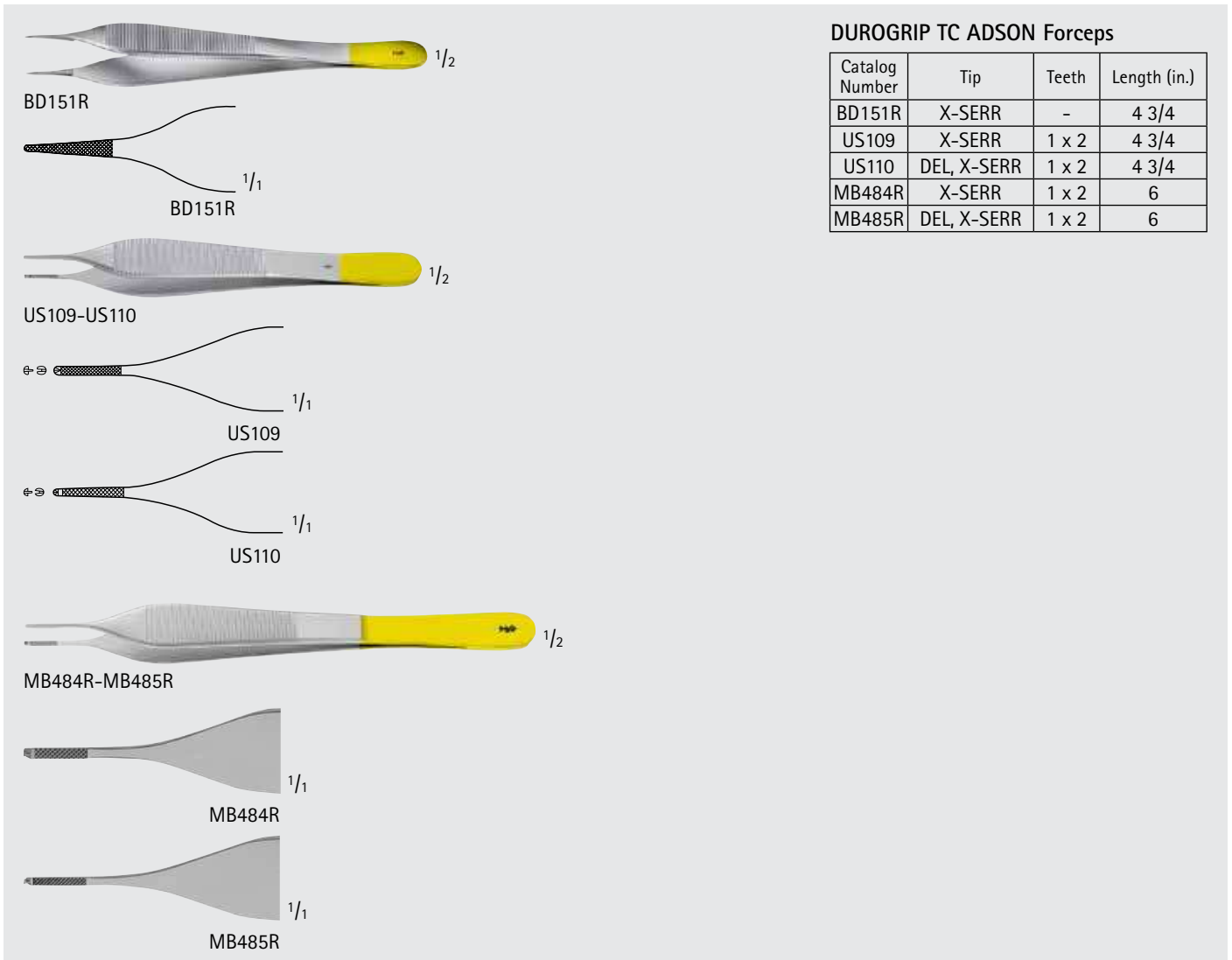

DUROGRIP TC ADSON Forceps

Catalog Number	Tip	Teeth	Length (in.)
BD151R	X-SERR	-	4 3/4
US109	X-SERR	1 x 2	4 3/4
US110	DEL, X-SERR	1 x 2	4 3/4
MB484R	X-SERR	1 x 2	6
MB485R	DEL, X-SERR	1 x 2	6

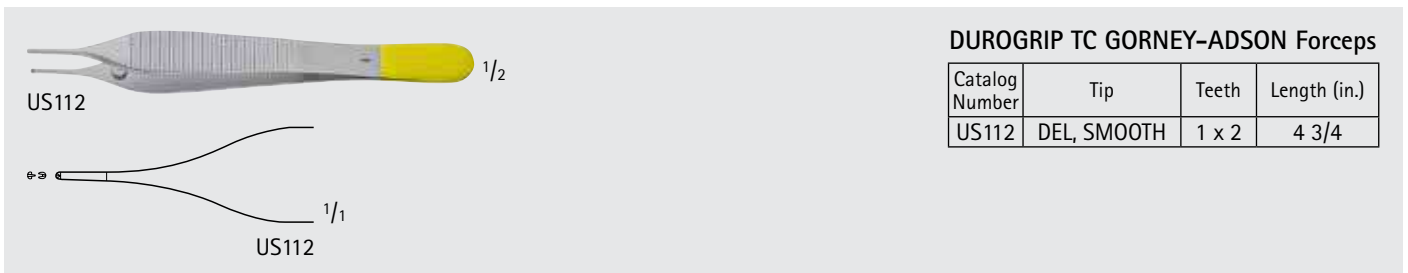

DUROGRIP TC GORNEY-ADSON Forceps

Catalog Number	Tip	Teeth	Length (in.)
US112	DEL, SMOOTH	1 x 2	4 3/4

DUROGRIP TC DEBAKEY Needle Forceps

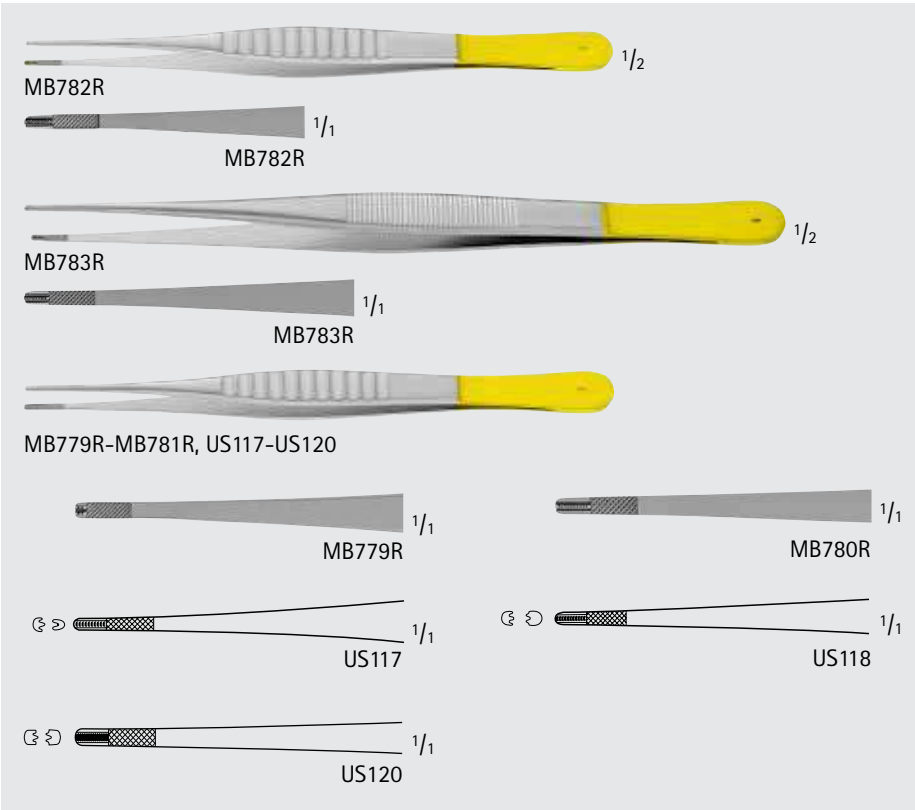

Catalog Number	Tip	Tip Size (mm)	Length (in.)
MB782R	-	1.5	6
MB783R	-	1.5	7 3/4
US119	NARROW	1.5	7 3/4
MB779R	-	2	6
MB780R	-	2	8
MB781R	-	2	10 1/2
US117	-	2	6
US118	-	2	8
US120	NARROW	2	9

GERALD Needle Forceps



Catalog Number	Tip	Teeth	Length (in.)
MG356R	X-SERR	1 x 2	6 7/8

DUROGRIP TC (POTTS-SMITH) Thumb Forceps



Catalog Number	Tip	Length (in.)
BD154R	X-SERR	5 3/4
BD156R	X-SERR	7
BD157R	X-SERR	7 7/8
BD158R	X-SERR	9
BD159R	X-SERR	9 3/4



General Surgery

DUROGRIP™ TC Tissue Forceps

GENERAL SURGERY

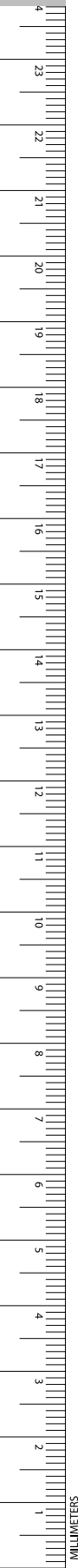
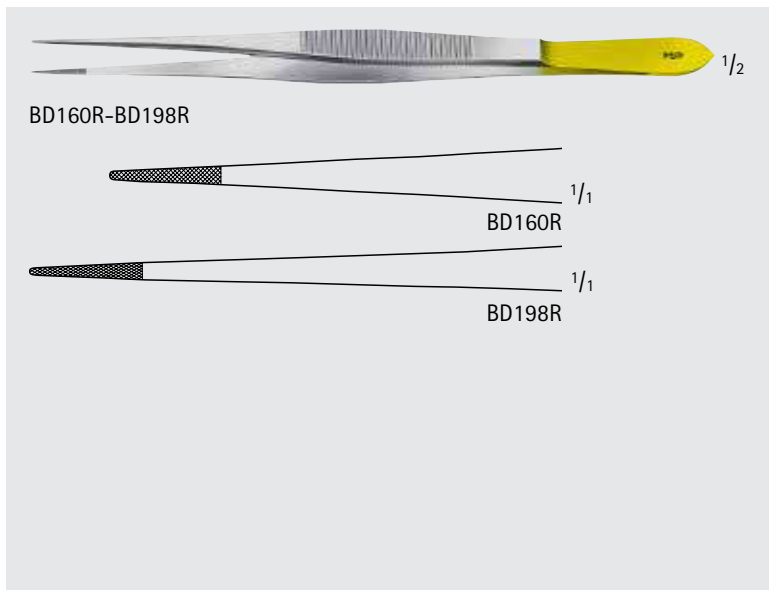
BD160R-BD198R

BD160R $\frac{1}{1}$

BD198R $\frac{1}{1}$

DUROGRIP TC CUSHING Forceps, W/ Scraper End

Catalog Number	Tip	Length (in.)
BD160R	X-SERR	7
BD198R	X-SERR	9 3/4

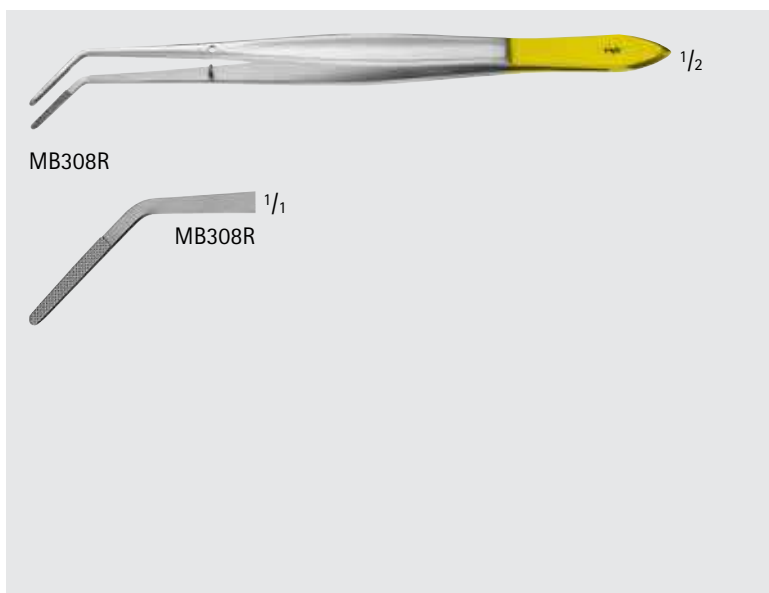

MB308R

MB308R $\frac{1}{1}$

DUROGRIP TC CUSHING Forceps

Catalog Number	Tip	Length (in.)
MB308R	ANG, X-SERR	6 1/4

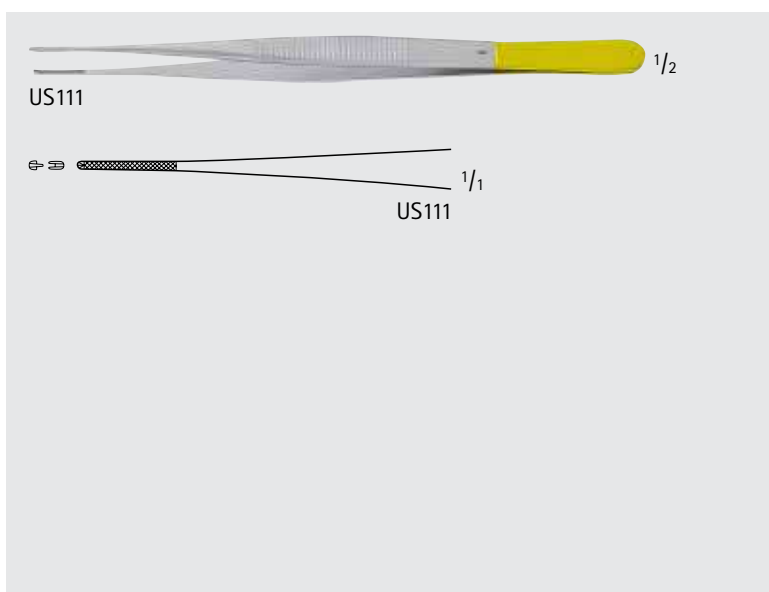

US111

US111 $\frac{1}{1}$

DUROGRIP TC SEMKEN Forceps

Catalog Number	Tip	Tip Size (mm)	Teeth	Length (in.)
US111	X-SERR	1	1 x 2	6 1/4



BD164R-BD166R

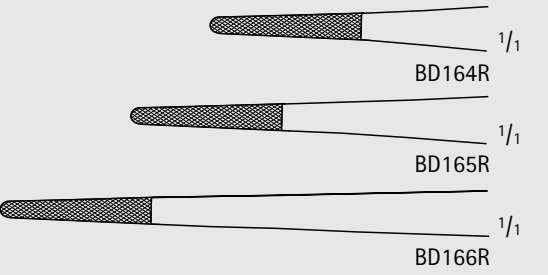

BD164R 1/1
BD165R 1/1
BD166R 1/1

Catalog Number	Tip	Length (in.)
BD164R	X-SERR	5 3/4
BD165R	X-SERR	7 7/8
BD166R	X-SERR	9 3/4

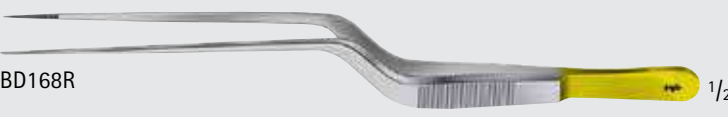

BD168R 1/2

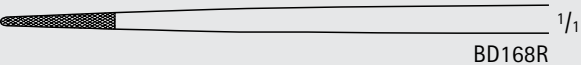

BD168R 1/1

Catalog Number	Tip	Length (in.)
BD168R	X-SERR	7 1/4



BD171R-BD173R

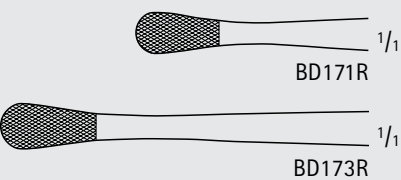

BD171R 1/1
BD173R 1/1

Catalog Number	Tip	Length (in.)
BD171R	X-SERR	6
BD173R	X-SERR	9



General Surgery

Abdominal and Intestinal Grasping Forceps

GENERAL SURGERY

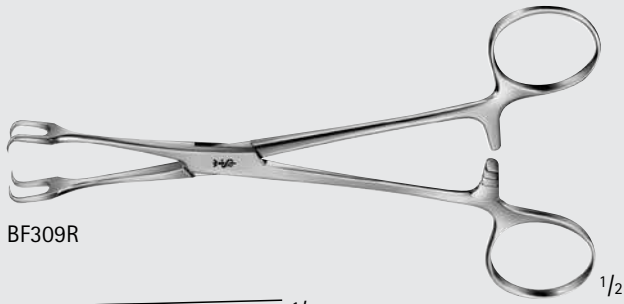

BF309R

1/2

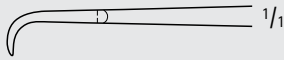

BF309R

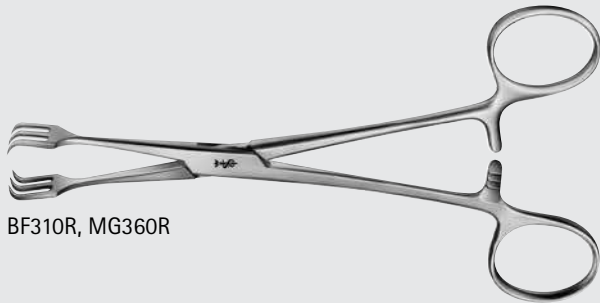

BF310R, MG360R

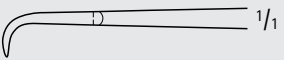

BF310R, MG360R

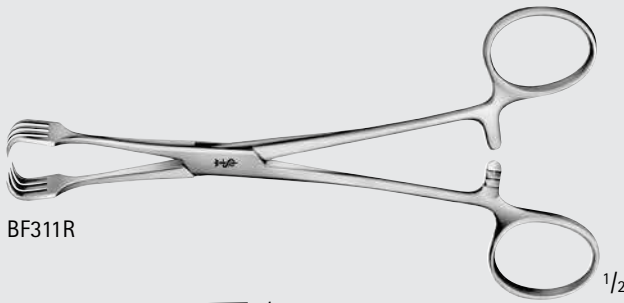

BF311R

1/2

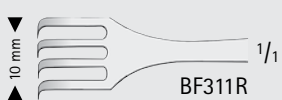
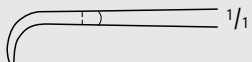

BF311R

LAHEY Forceps

Catalog Number	Teeth	Length (in.)
BF309R	2 x 2	6 1/8
BF310R	3 x 3	6 1/8
MG360R	3 x 3	8
BF311R	4 x 4	6 1/8

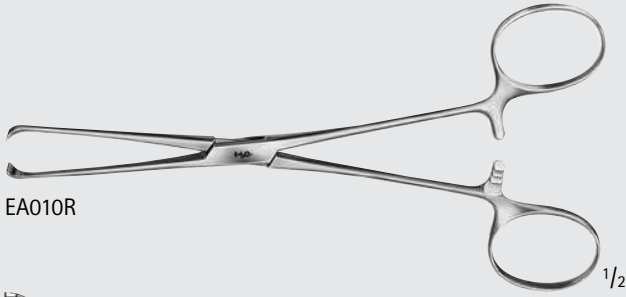

EA010R



EA010R $\frac{1}{1}$

$\frac{1}{2}$

BOYS-ALLIS Forceps

Catalog Number	Teeth	Length (in.)
EA010R	5 x 6	6 1/8

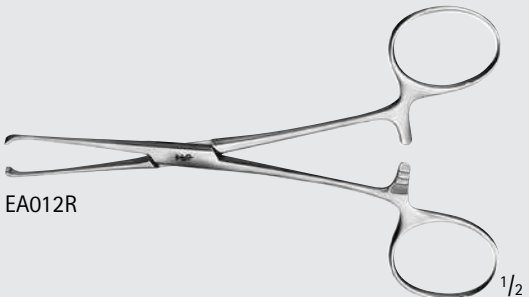

EA012R



EA012R $\frac{1}{1}$

$\frac{1}{2}$

Baby ALLIS Forceps

Catalog Number	Teeth	Length (in.)
EA012R	4 x 5	5 1/8

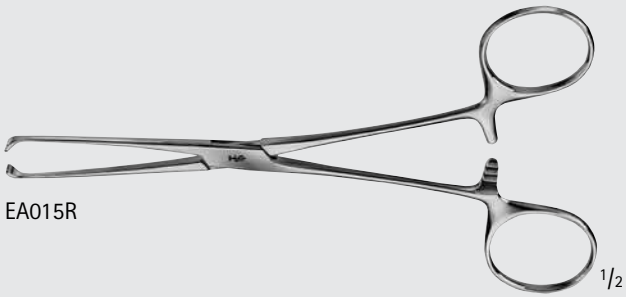

EA015R

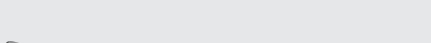

EA015R $\frac{1}{1}$

$\frac{1}{2}$

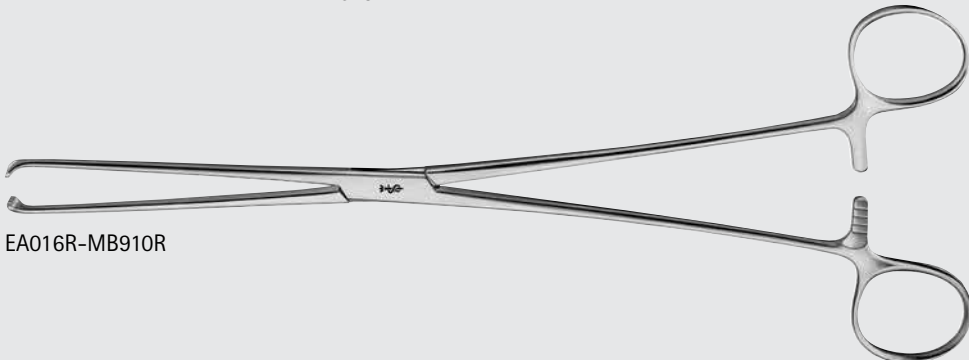

EA016R-MB910R



EA016R-MB910R $\frac{1}{1}$

ALLIS Forceps

Catalog Number	Teeth	Length (in.)
EA015R	4 x 5	6 1/8
EA016R	5 x 6	6 1/8
EA017R	5 x 6	7 1/2
FB938R	5 x 6	8 3/4
EA018R	5 x 6	10
MB910R	5 x 6	16



General Surgery

Abdominal and Intestinal Grasping Forceps

GENERAL SURGERY

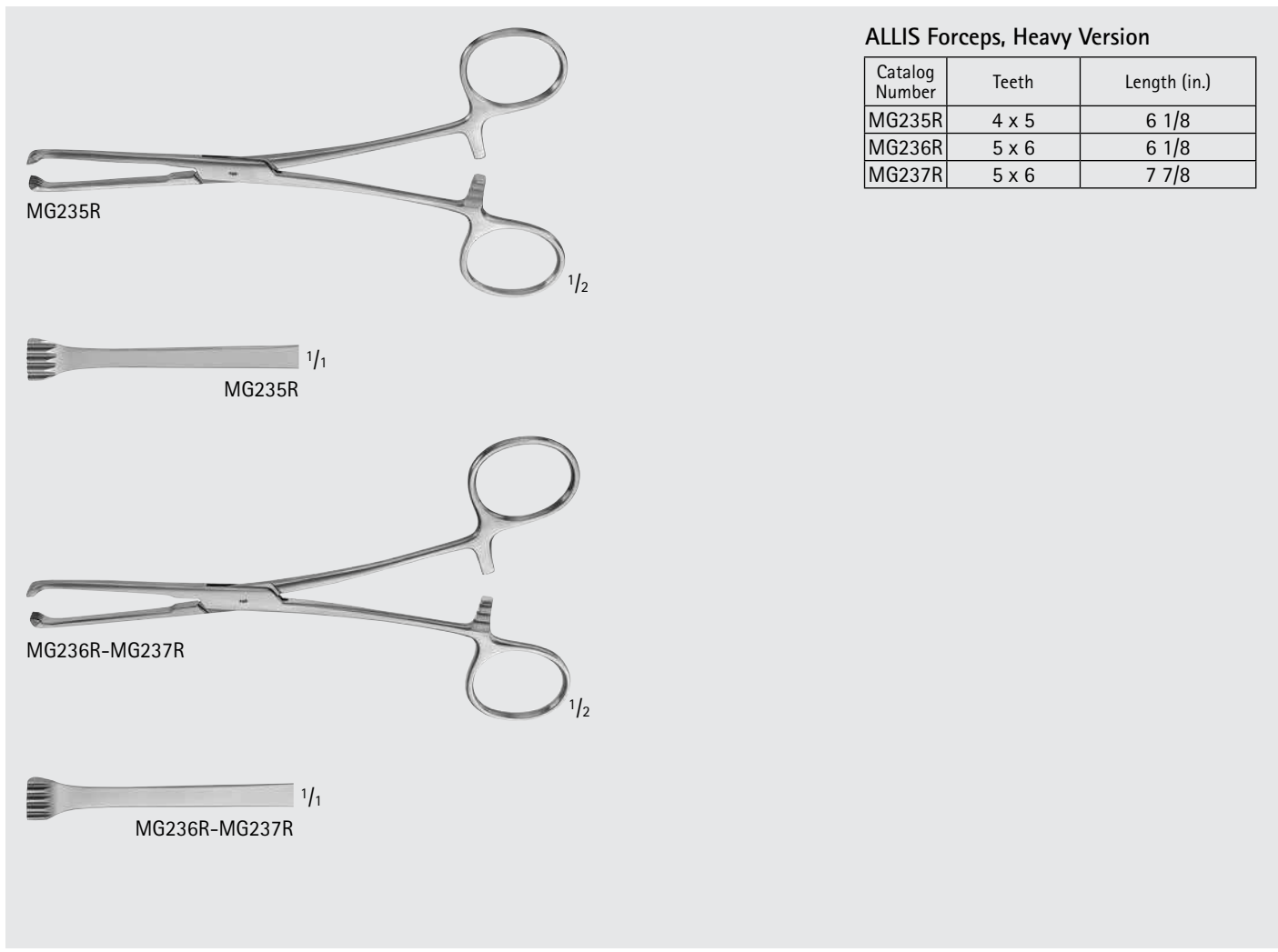

ALLIS Forceps, Heavy Version

Catalog Number	Teeth	Length (in.)
MG235R	4 x 5	6 1/8
MG236R	5 x 6	6 1/8
MG237R	5 x 6	7 7/8

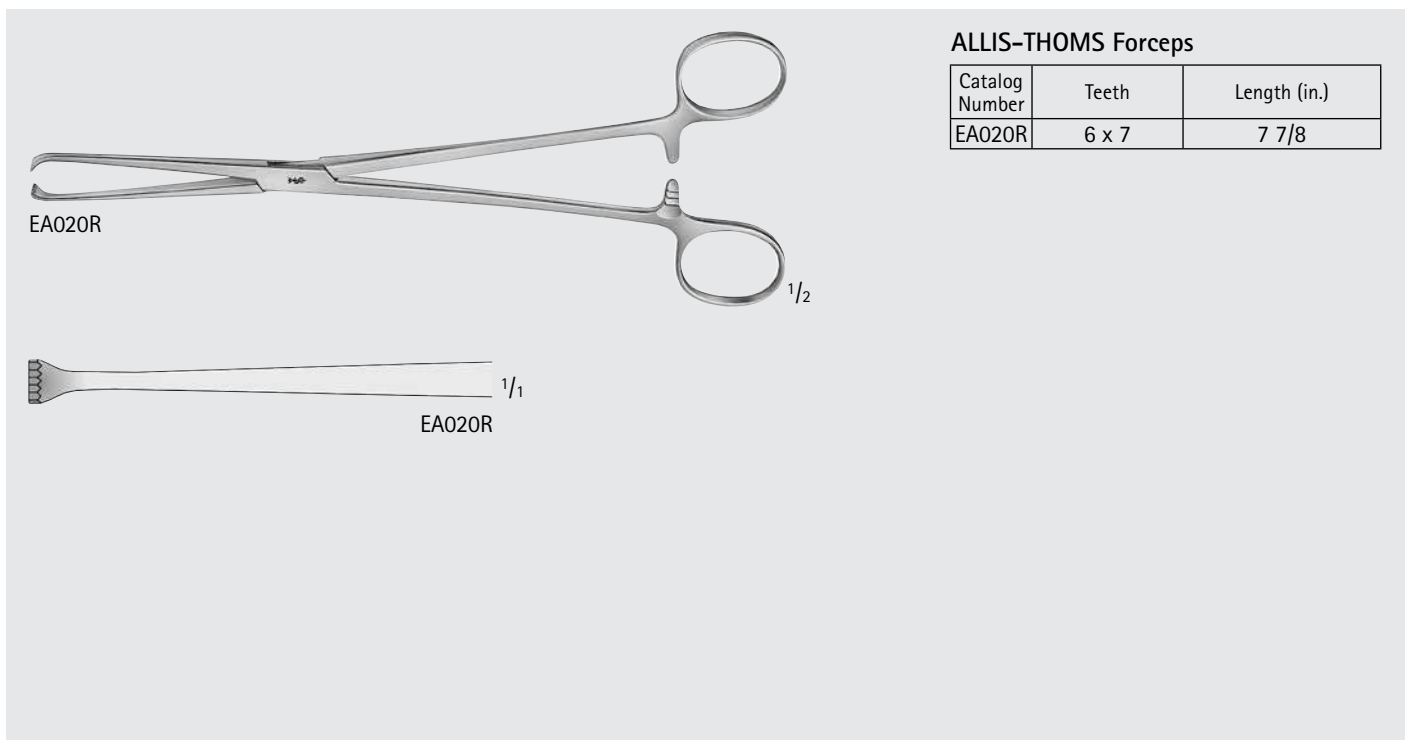

ALLIS-THOMS Forceps

Catalog Number	Teeth	Length (in.)
EA020R	6 x 7	7 7/8



JUDD-ALLIS Forceps

Catalog Number	Teeth	Length (in.)
EA025R	3 x 4	6 1/8
EA026R	3 x 4	7 7/8

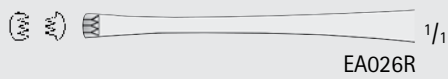
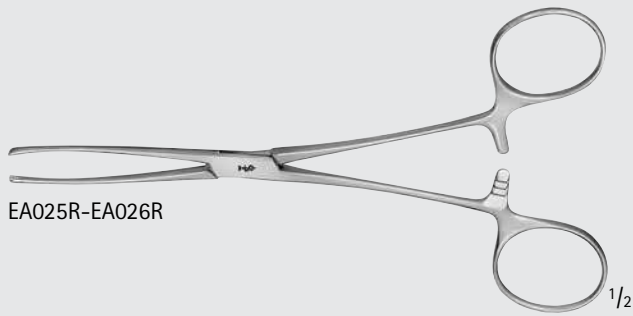

ALLIS-ADAIR Clamp

Catalog Number	Teeth	Length (in.)
MD568	9 x 10	6 1/4

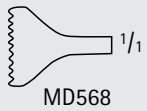
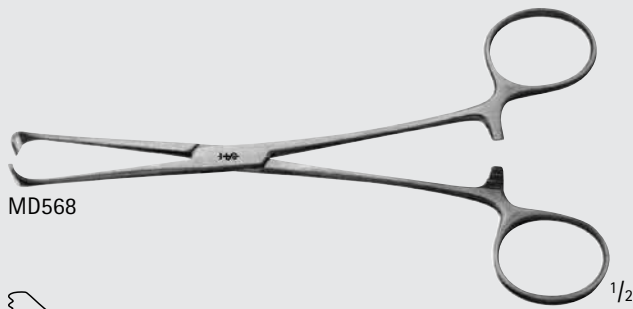

LOCKWOOD-ALLIS Intestinal Clamp

Catalog Number	Teeth	Length (in.)
MG455R	4 x 5	6 1/2

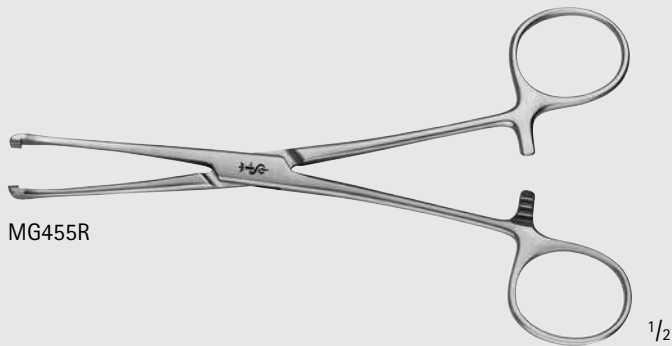

General Surgery

Abdominal and Intestinal Grasping Forceps

GENERAL SURGERY

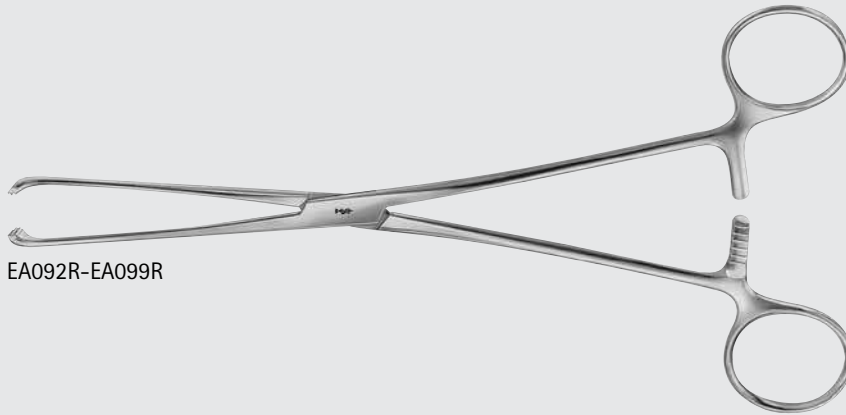

EA092R-EA099R

ALLIS Atraumatic Forceps

Catalog Number	Length (in.)
EA092R	6 1/4
EA095R	7 7/8
EA096R	8 3/4
EA097R	10
EA100R	11 5/8
EA099R	11 3/4
EA101R	14

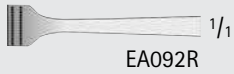

EA092R

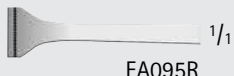

EA095R



EA096R

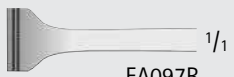

EA097R

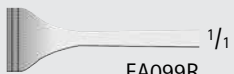

EA099R

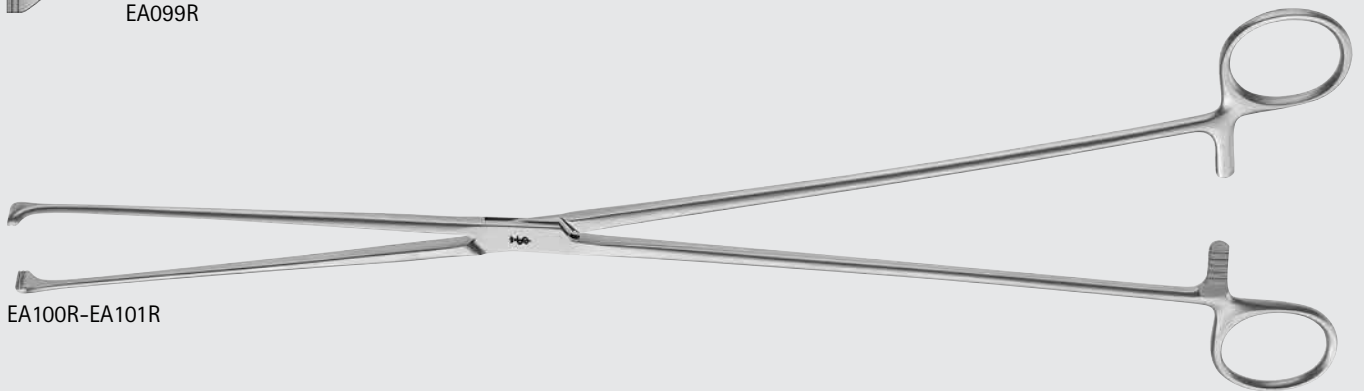

EA100R-EA101R

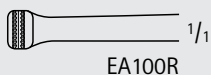

EA100R



EA101R

GLASSMAN-ALLIS Common Duct Forceps Non-Crushing

Catalog Number	Length (in.)
MG435R	8 1/2

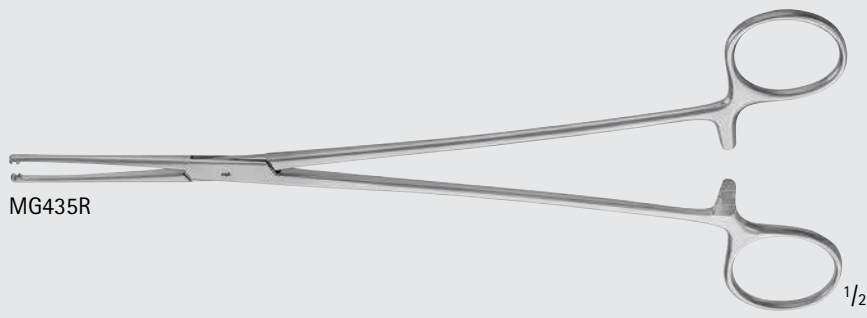

MG435R



MG435R

BABCOCK Tissue Holding Forceps

Catalog Number	Length (in.)
MB136R	12
MB137R	14



MB136R-MB137R



MB136R

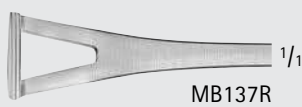

MB137R



INCHES

General Surgery

Abdominal and Intestinal Grasping Forceps

GENERAL SURGERY

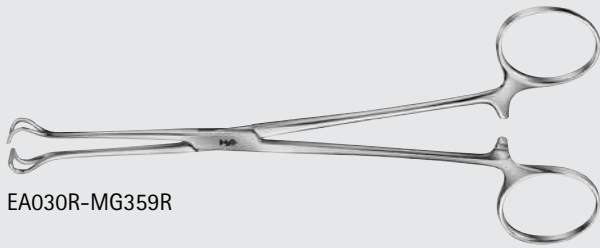
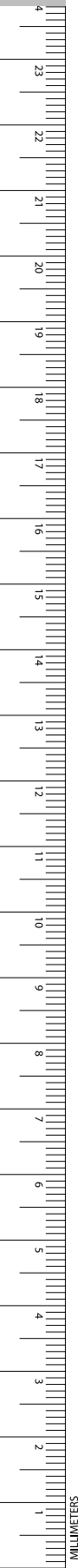

EA030R-MG359R



MG359R



EA030R



EA031R



EA032R

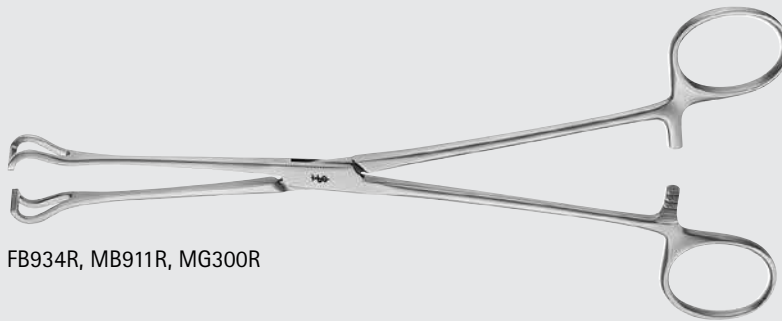

FB934R, MB911R, MG300R

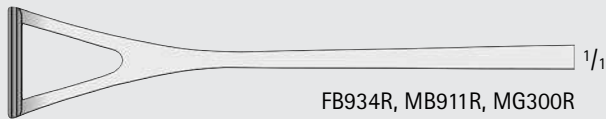

FB934R, MB911R, MG300R



MB911R

BABCOCK Forceps

Catalog Number	Tip	Length (in.)
MG359R	-	5 1/2
EA030R	-	6 1/8
EA031R	-	6 7/8
EA032R	-	8 1/2
FB934R	-	8 3/4
MB300R	-	14
MB911R	DEL, PETITE	16

BABCOCK Atraumatic Forceps

Catalog Number	Length (in.)
EA050R	6 1/4
EA052R	8 1/2
FB936R	8 3/4
MD470	9 1/2

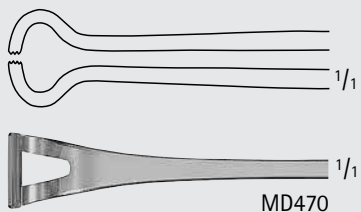
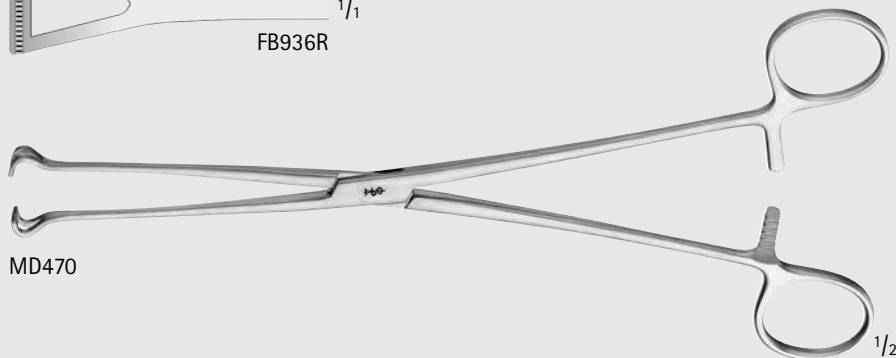
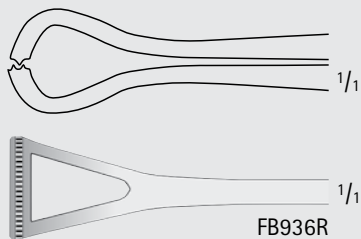
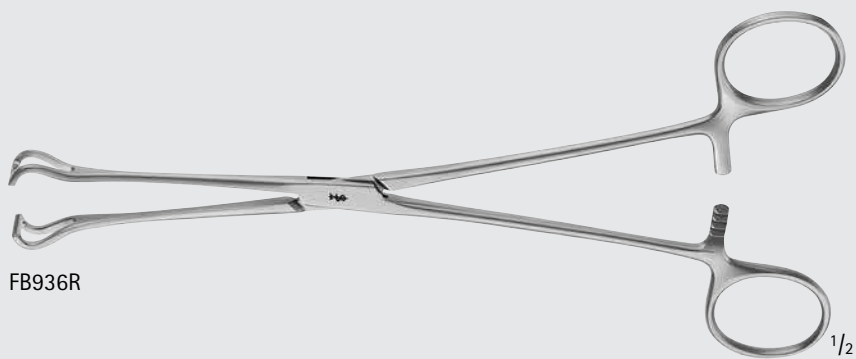
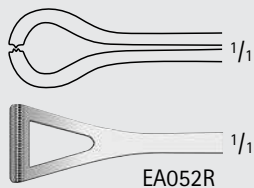
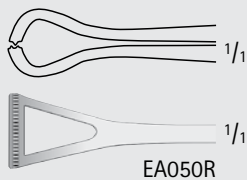
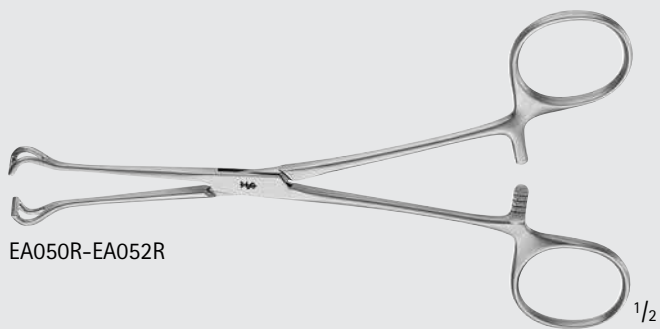

General Surgery

Abdominal and Intestinal Grasping Forceps

GENERAL SURGERY

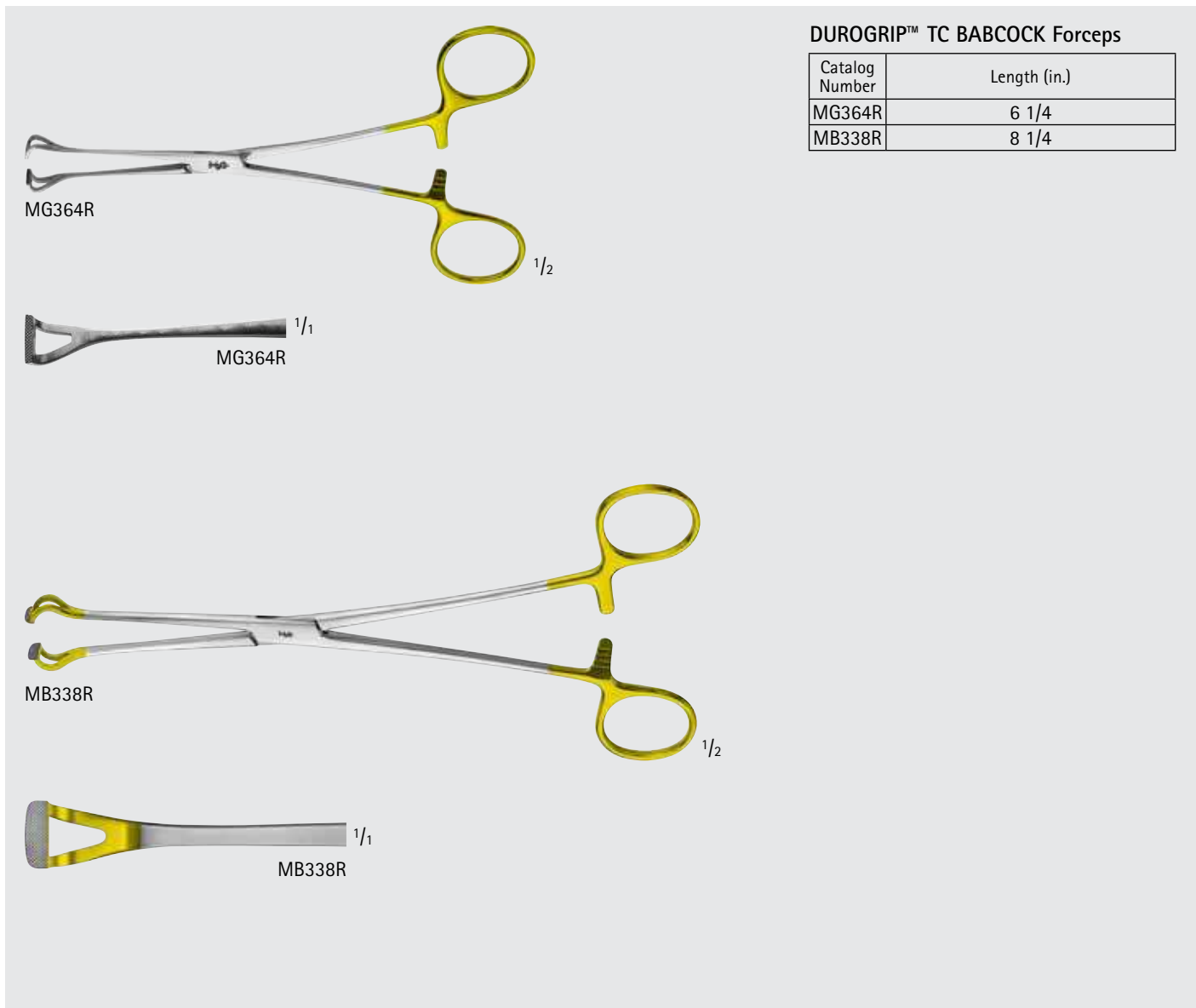

DUROGRIP™ TC BABCOCK Forceps

Catalog Number	Length (in.)
MG364R	6 1/4
MB338R	8 1/4

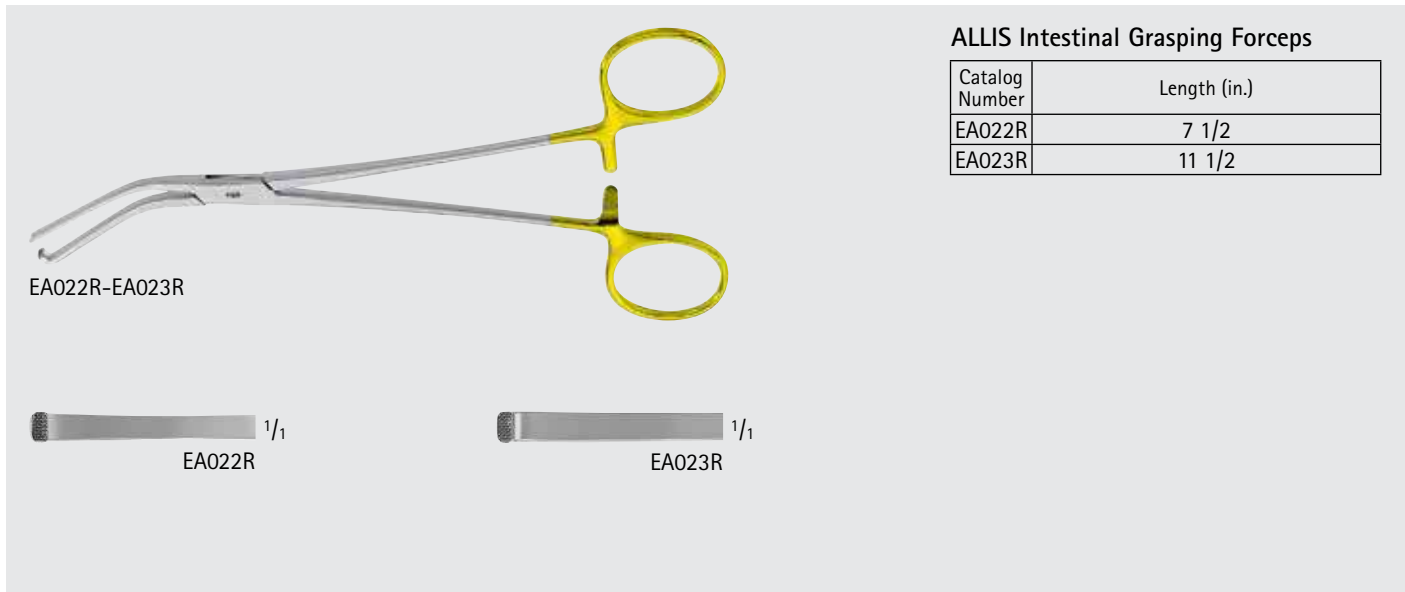

ALLIS Intestinal Grasping Forceps

Catalog Number	Length (in.)
EA022R	7 1/2
EA023R	11 1/2

COLLIN Intestinal Forceps

Catalog Number	Length (in.)
EA039R	5 1/2
EA040R	7

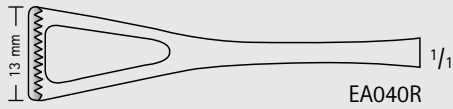
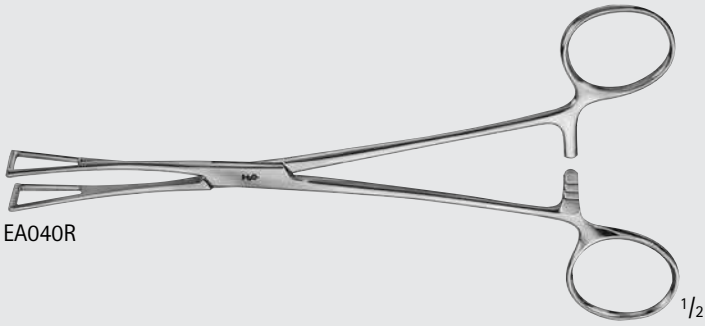
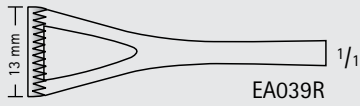
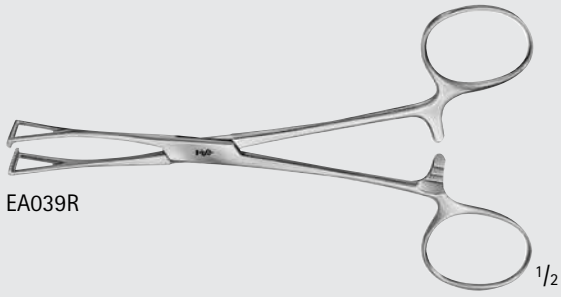

COLLIN Atraumatic Forceps

Catalog Number	Length (in.)
EA061R	7 3/4
EA062R	9

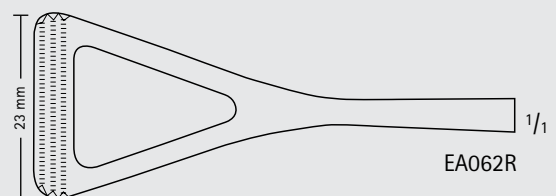
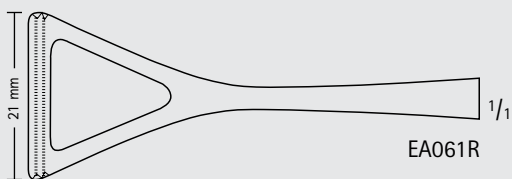
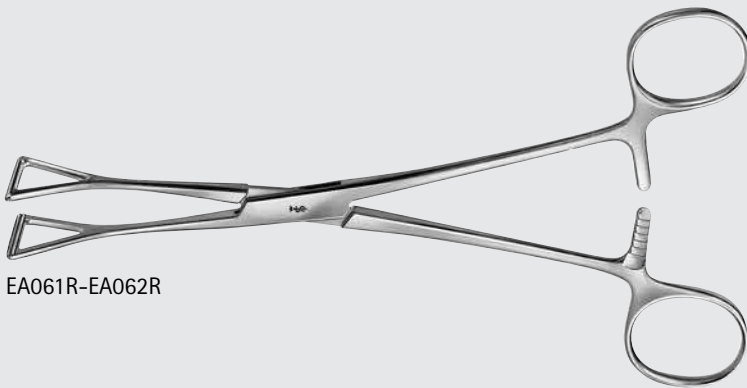

General Surgery

Abdominal and Intestinal Grasping Forceps

GENERAL SURGERY



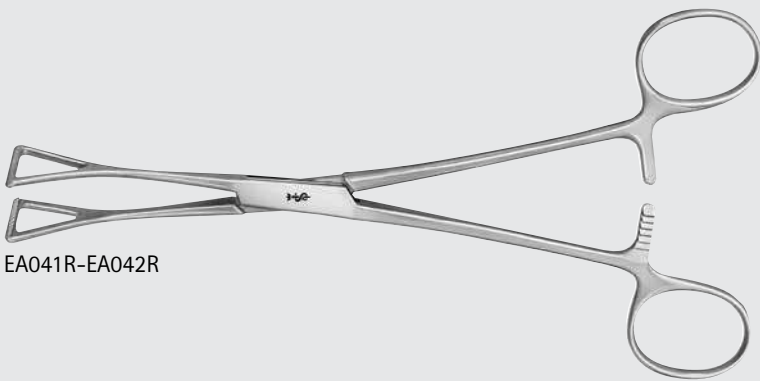

EA041R-EA042R

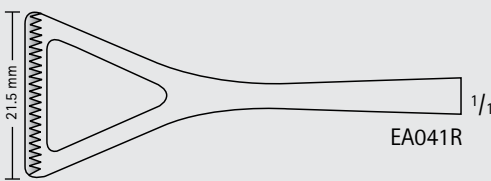

EA041R

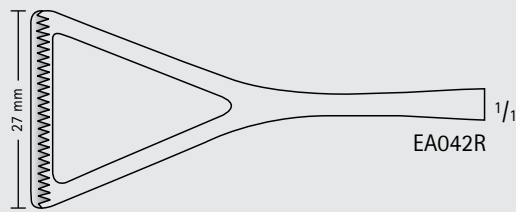

EA042R

DUVAL-COLLIN Intestinal Forceps

Catalog Number	Length (in.)
EA041R	7 3/4
EA042R	7 7/8

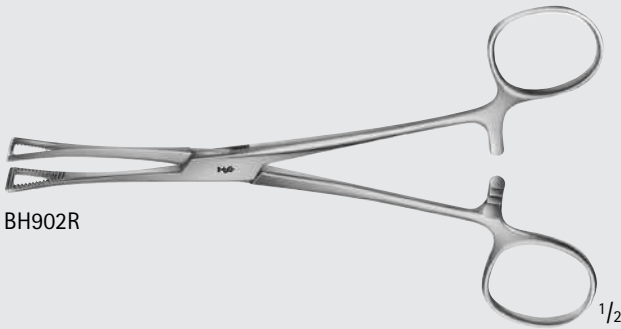

BH902R

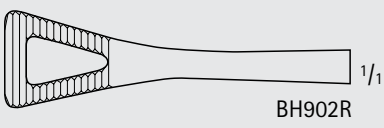

BH902R

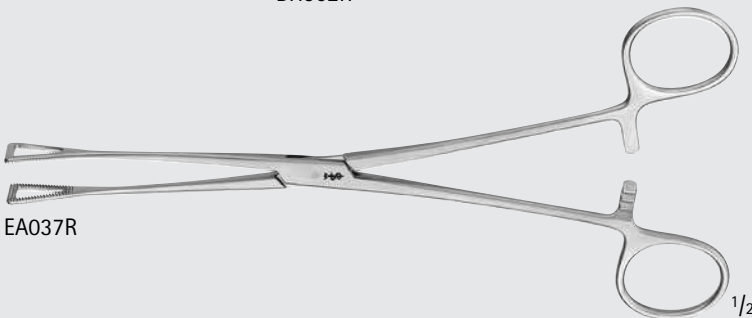

EA037R

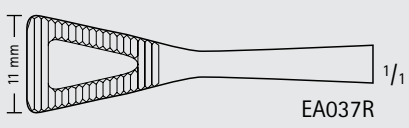

EA037R

PENNINGTON Forceps

Catalog Number	Length (in.)
BH902R	6 1/8
EA037R	7 7/8

BAINBRIDGE Intestinal Forceps, Longitudinal Serrations

Catalog Number	Jaw	Length (in.)
EA106R	STR	6 1/8
US114	STR	7 1/4
EA107R	CVD	6 1/8
US115	CVD	7 1/4

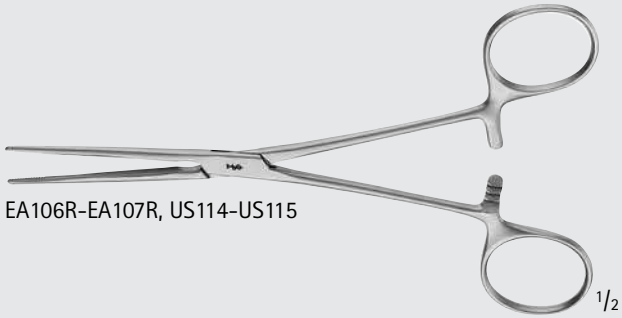

EA106R-EA107R, US114-US115



EA106R



EA107R



US114



US115

ALLEN Intestinal Forceps, Longitudinal Serrated

Catalog Number	Teeth	Length (in.)
EA114R	1 x 2	6 1/8
MB609R	1 x 2	7 7/8

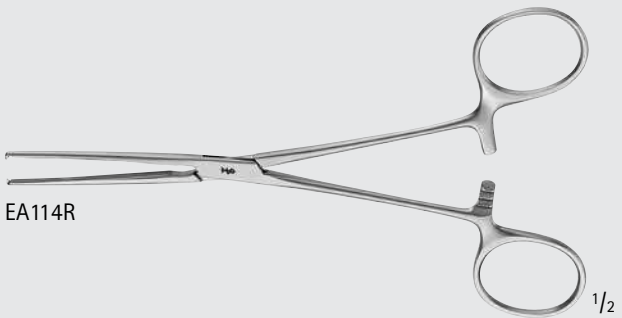

EA114R



EA114R



MB609R



MB609R



General Surgery

Abdominal and Intestinal Forceps

GENERAL SURGERY

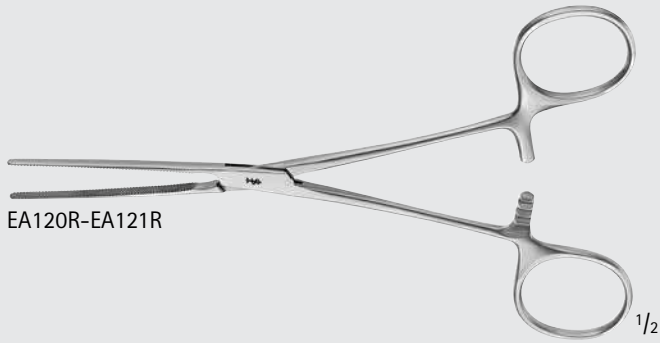

EA120R-EA121R



EA120R



EA121R

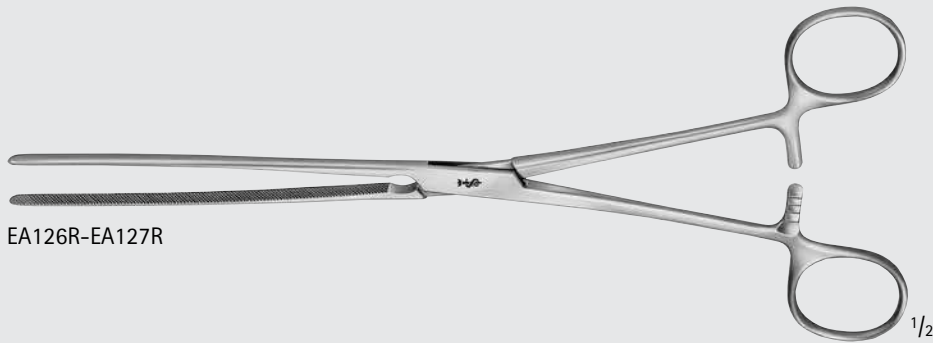

EA126R-EA127R

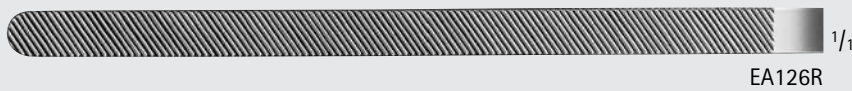

EA126R

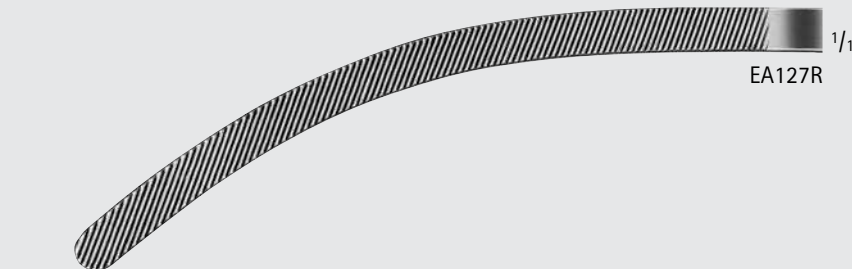

EA127R

DOYEN Intestinal Forceps, Elastic Blades

Catalog Number	Jaw	Length (in.)
EA120R	STR	6 1/2
EA126R	STR	9 1/4
EA121R	CVD	6 1/2
EA127R	CVD	9 1/4

DOYEN Intestinal Forceps, Elastic Blades, Longitudinal Serations

Catalog Number	Jaw	Length (in.)
EA130R	STR	9 1/2
EA131R	CVD	9 1/2

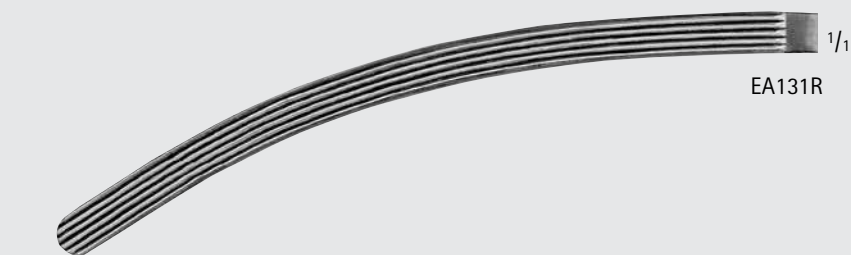
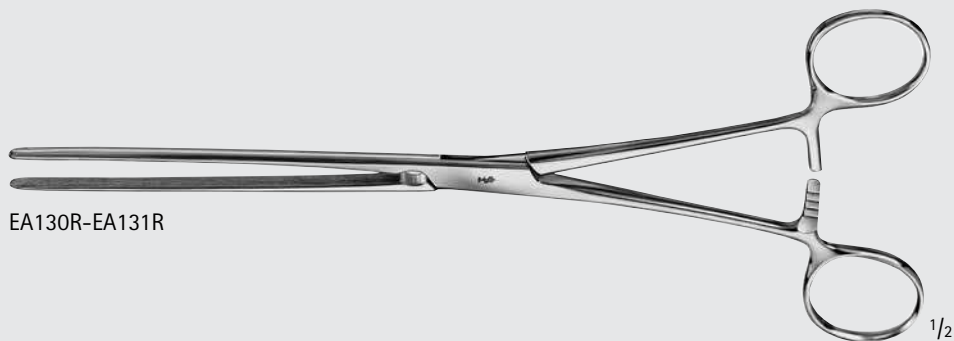

HARTMANN Intestinal Clamp, Elastic Blades

Catalog Number	Jaw	Length (in.)
EA124R	STR	7 7/8
EA125R	CVD	7 7/8

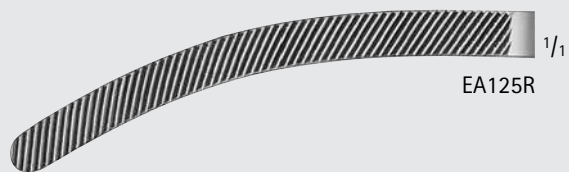
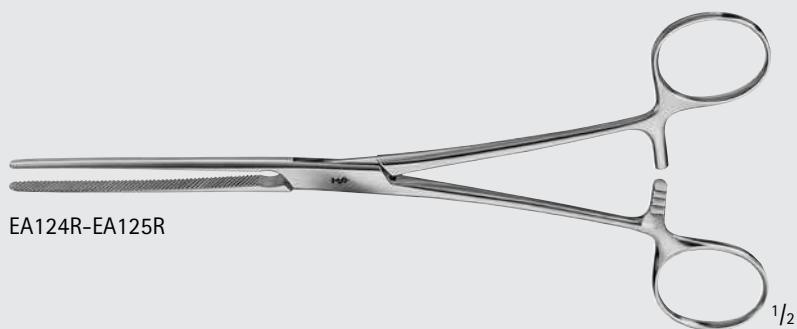

General Surgery

Abdominal and Intestinal Forceps

GENERAL SURGERY

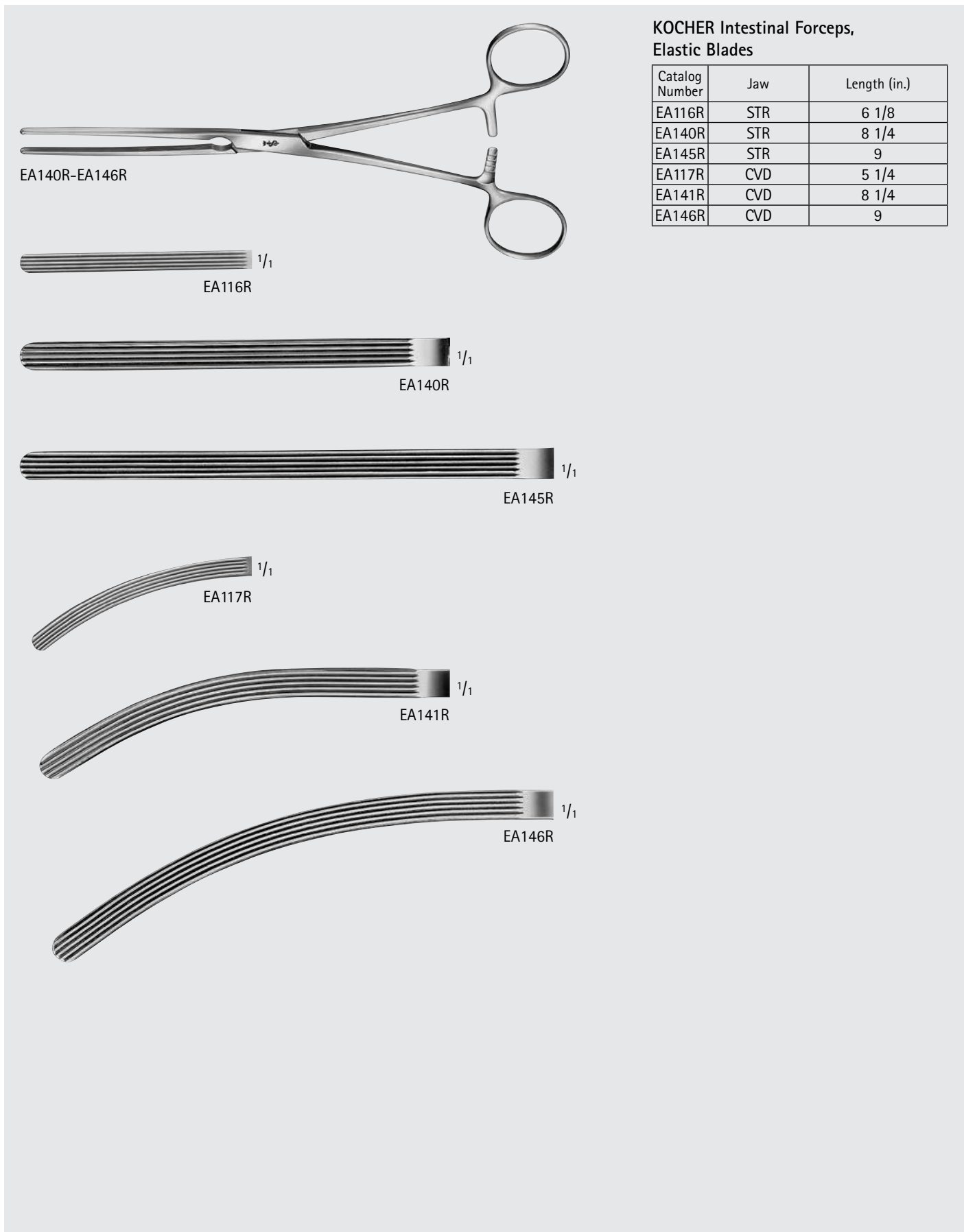
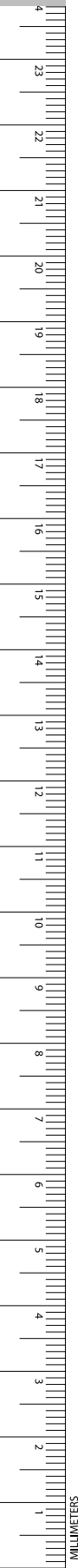

KOCHER Intestinal Forceps, Elastic Blades

Catalog Number	Jaw	Length (in.)
EA116R	STR	6 1/8
EA140R	STR	8 1/4
EA145R	STR	9
EA117R	CVD	5 1/4
EA141R	CVD	8 1/4
EA146R	CVD	9

EA140R-EA146R

EA116R 1/1

EA140R 1/1

EA145R 1/1

EA117R 1/1

EA141R 1/1

EA146R 1/1

KOCHER Intestinal Forceps, Elastic Blades

Catalog Number	Jaw	Length (in.)
EA150R	STR	8 3/4
EA151R	STR	9 3/4
EA152R	STR	11
EA155R	CVD	8 3/4
EA156R	CVD	9 3/4

EA150R-EA156R

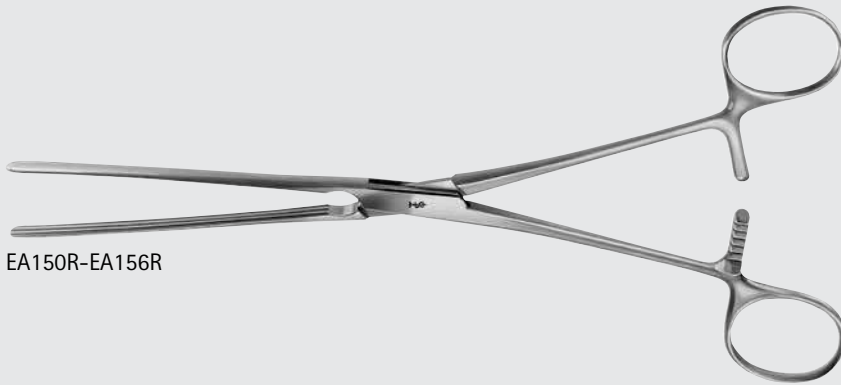

INCHES

General Surgery

Abdominal and Intestinal Forceps

GENERAL SURGERY



MAYO-ROBSON Intestinal Forceps, Hard Elastic Blades

Catalog Number	Jaw	Length (in.)
EA170R	STR	9 3/4
EA171R	CVD	9 3/4

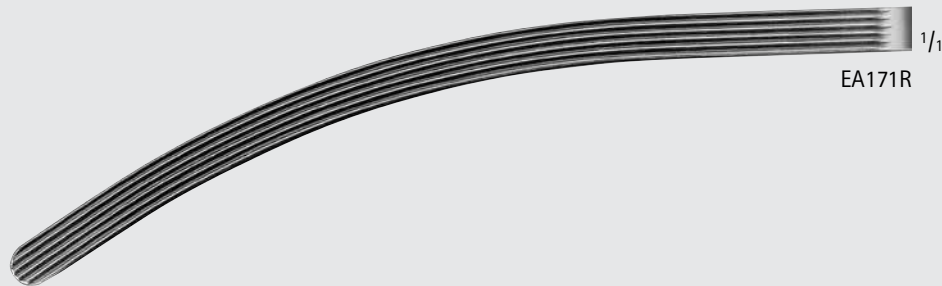
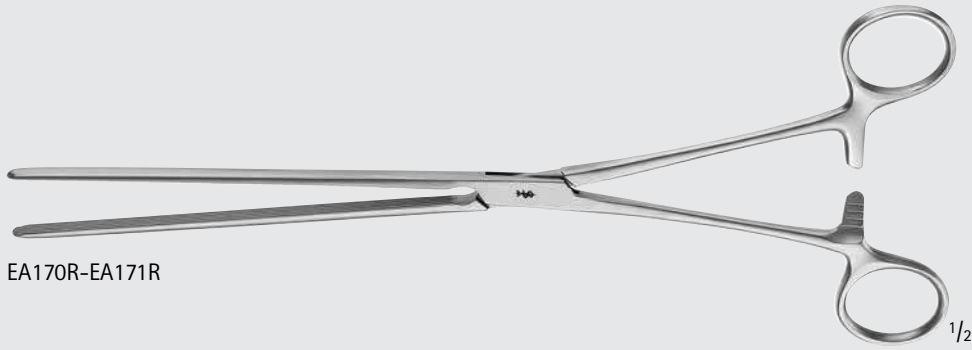



EA305R-EA450R

PAYR Intestinal Clamp

Catalog Number	Length (in.)
EA305R	7
EA306R	7 7/8
EA309R	10 3/4
EA450R	12 1/2

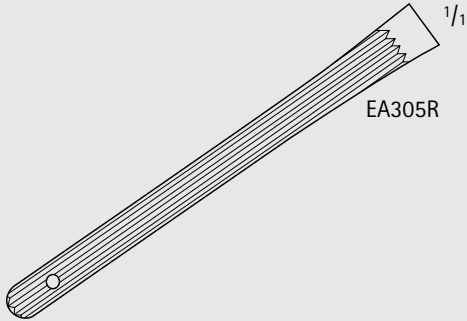

EA305R

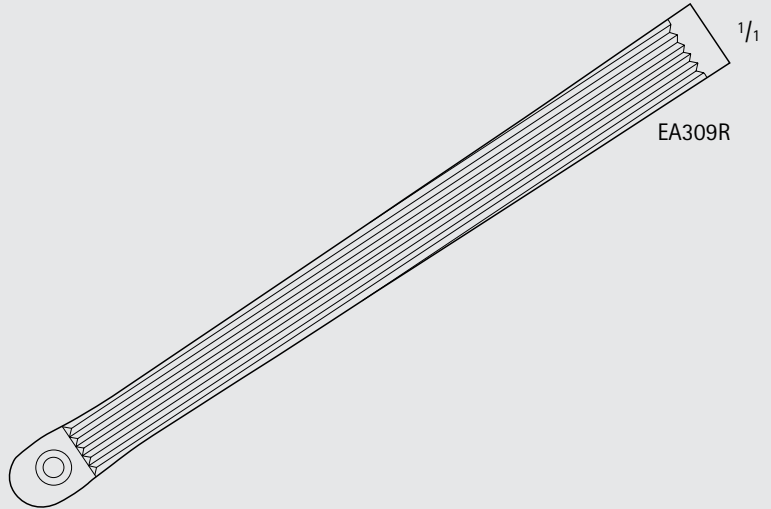

EA309R

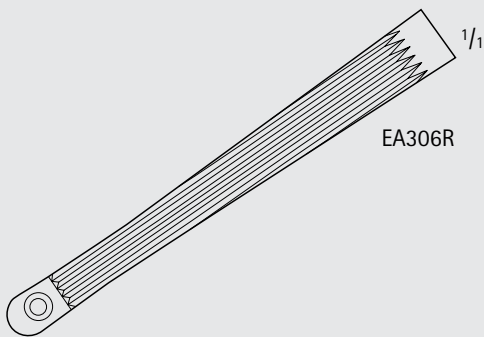

EA306R

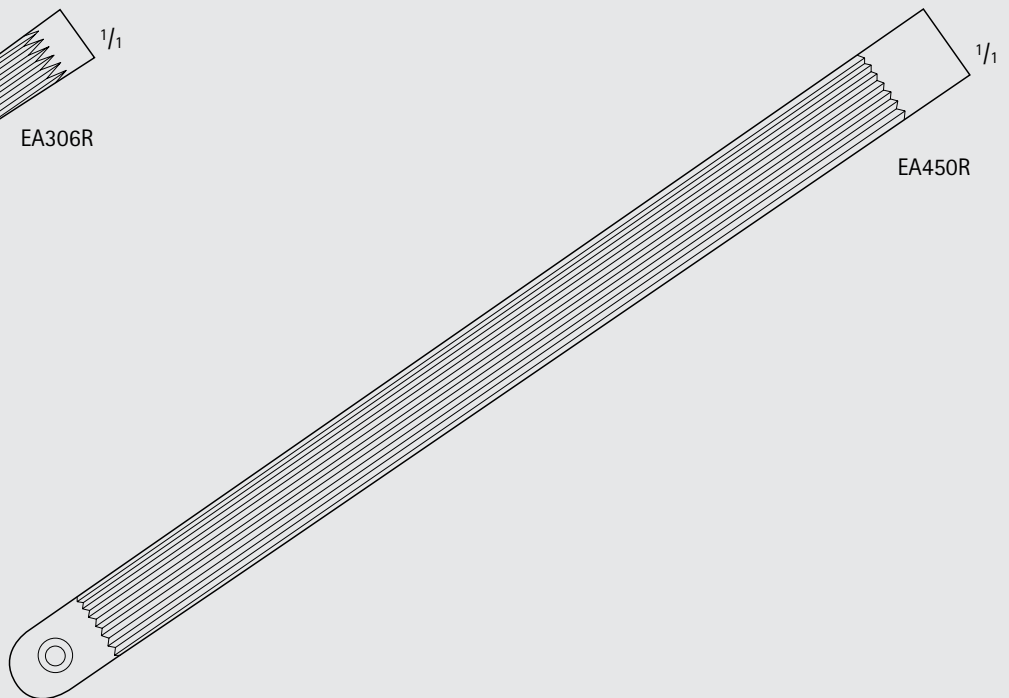

EA450R



General Surgery

Abdominal and Intestinal Forceps

GENERAL SURGERY

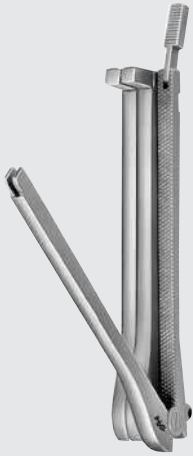

EA331R-EA332R

DEMARTEL-WOLFSON Anastomosis Clamp

Catalog Number	Description	Length (in.)
EA331R	SET OF 3	4
EA332R	SET OF 3	4 3/4



EA334R

Clamp Holder for Anastomosis Clamp

Catalog Number	Description	Length (in.)
EA334R	3" FOR USE WITH EA331R-EA332R	3 1/8

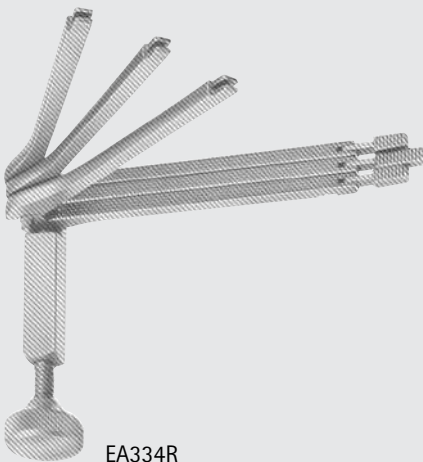

EA334R

KLEINSCHMIDT Appendectomy Forceps

Catalog Number	Jaw	Length (in.)
EA397R	CVD	5 1/8

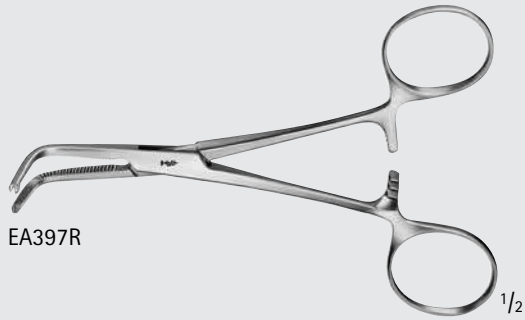

EA397R

1/2



EA397R

1/1

BENSON Pylorus Spreader

Catalog Number	Length (in.)
EA466R	6 1/8

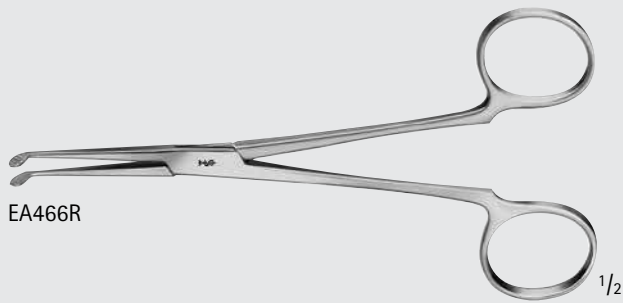

EA466R

1/2

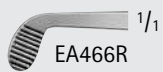

EA466R

1/1

TAUFIC Cholangiography Clamp

Catalog Number	Length (in.)
MG454R	8 1/2

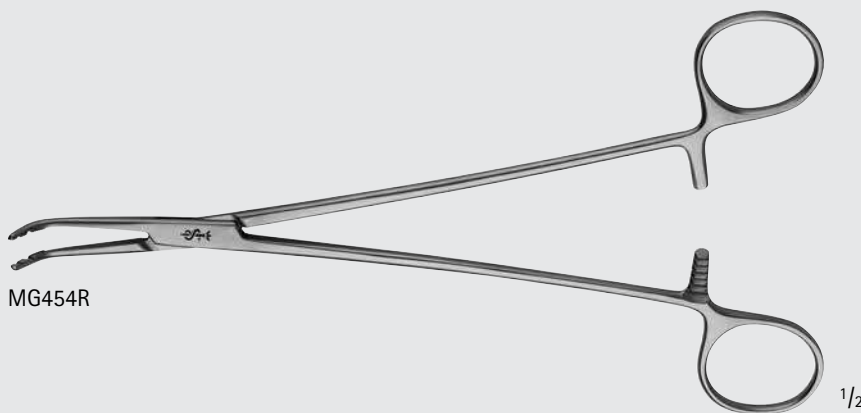

MG454R

1/2



MG454R

1/1



INCHES

General Surgery

Abdominal and Intestinal Forceps

GENERAL SURGERY

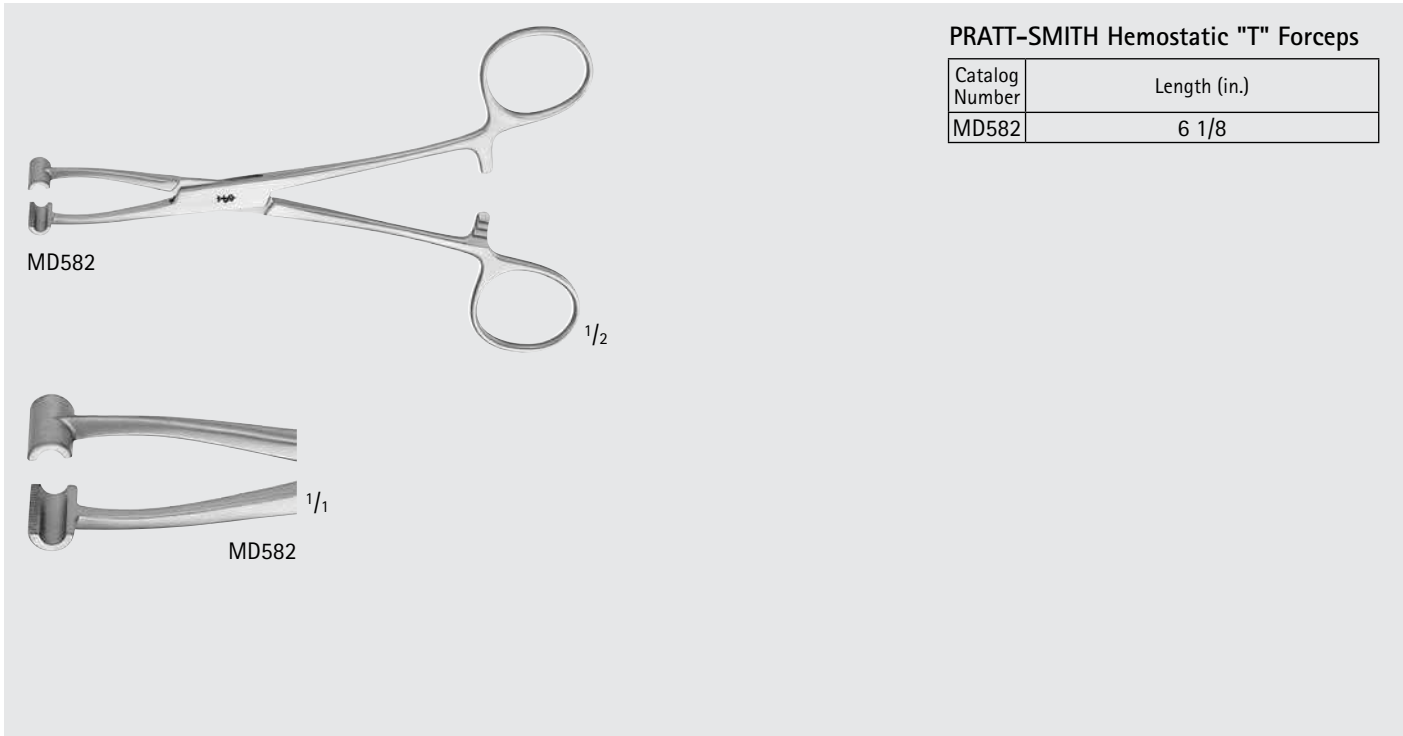

PRATT-SMITH Hemostatic "T" Forceps

Catalog Number	Length (in.)
MD582	6 1/8

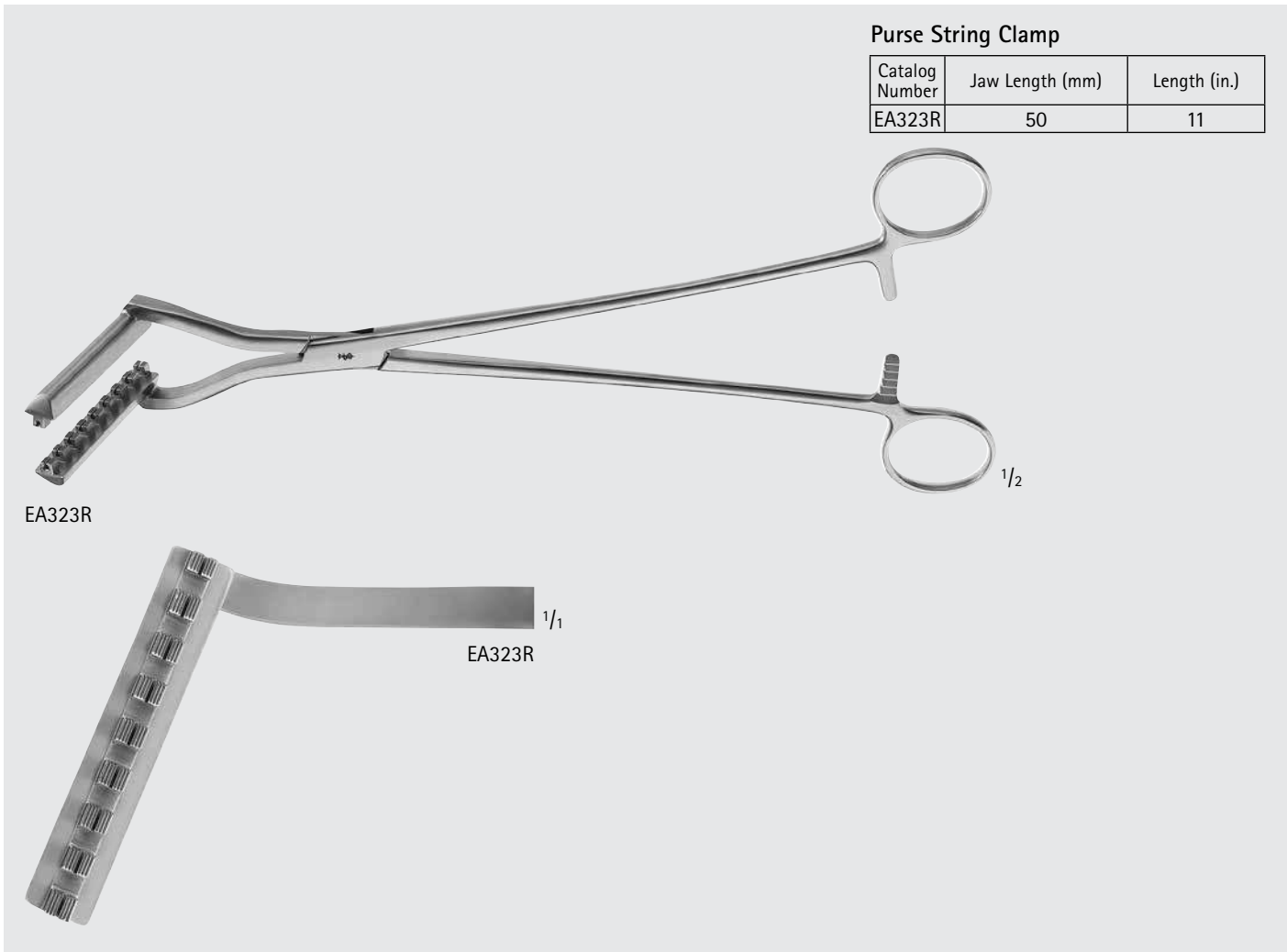

Purse String Clamp

Catalog Number	Jaw Length (mm)	Length (in.)
EA323R	50	11

LOWER Gall Duct Forceps

Catalog Number	Jaw	Length (in.)
EB001R	HEAVY-CVD	7

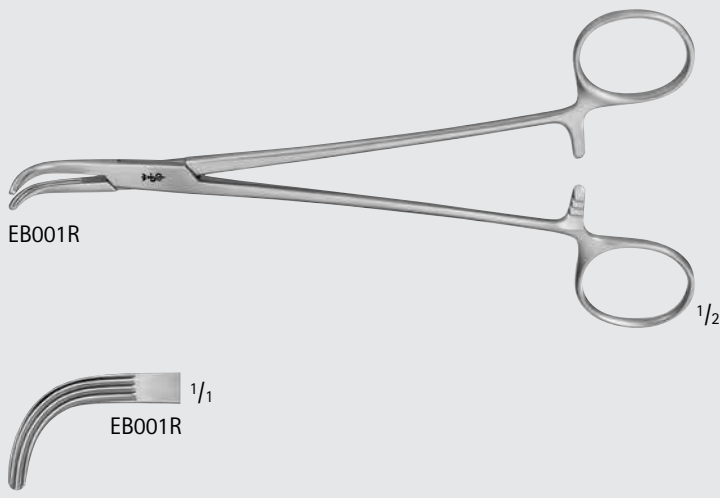

LAHEY (SWEET) Gall Duct Forceps

Catalog Number	Jaw	Length (in.)
EB003R	CVD	7 7/8

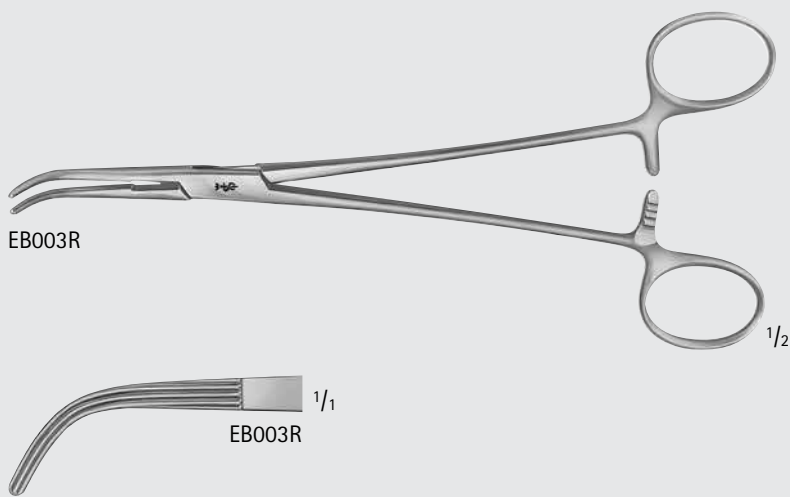

DESJARDINS Gall Duct Forceps

Catalog Number	Jaw	Length (in.)
EB008R	HEAVY-CVD	8 3/4

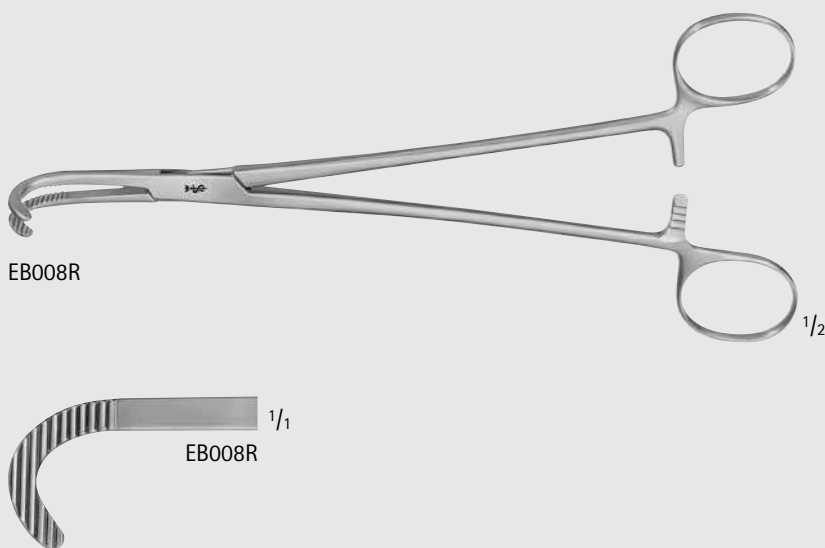

General Surgery

Abdominal and Intestinal Forceps

GENERAL SURGERY

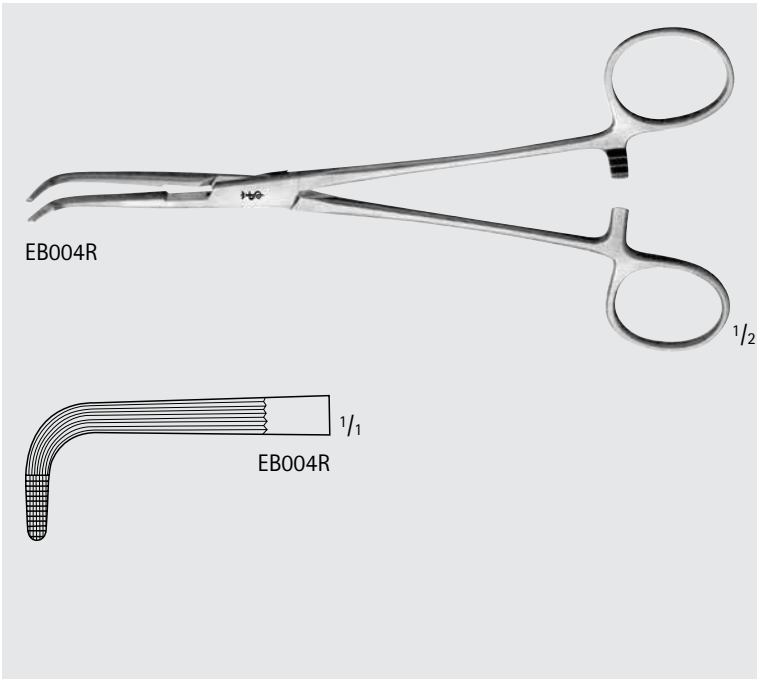
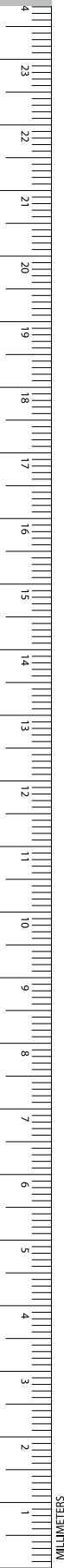

LAHEY Gall Duct Forceps

Catalog Number	Jaw	Length (in.)
EB004R	HEAVY-CVD	7 1/2

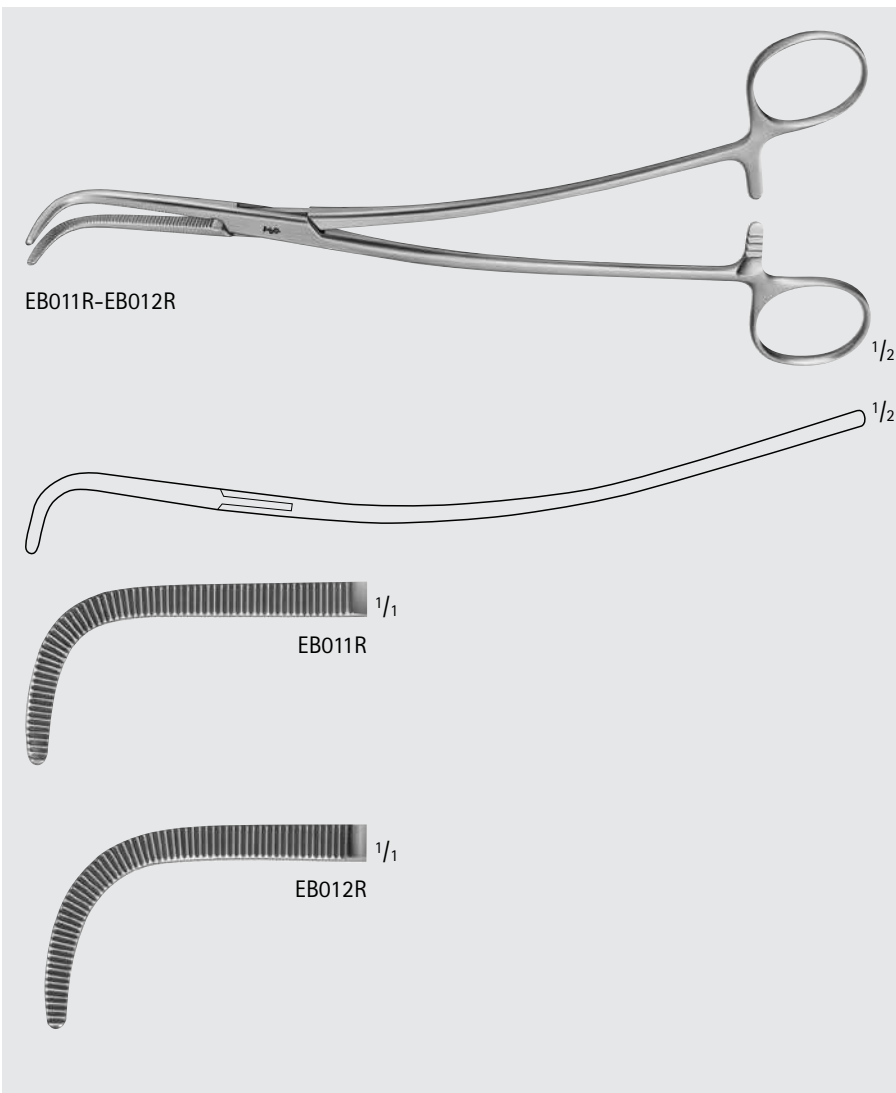

GRAY Cystic Gall Duct Forceps

Catalog Number	Jaw	Length (in.)
EB011R	SHORT, CVD	8 3/4
EB012R	LONG, CVD	8 3/4

MIXTER Gall Duct Forceps

Catalog Number	Jaw	Length (in.)
MB120R	HEAVY-CVD	6 1/4

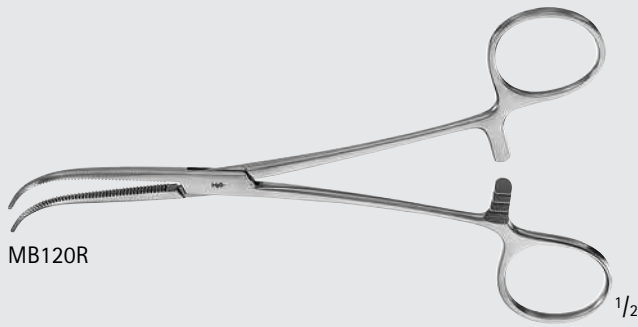

SHALLCROSS Cystic Duct Forceps

Catalog Number	Jaw	Length (in.)
MB126R	CVD	6 7/8
US152	FULL-CVD	8

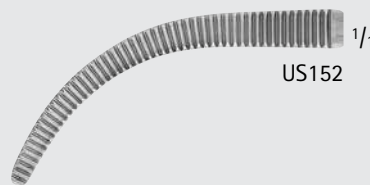
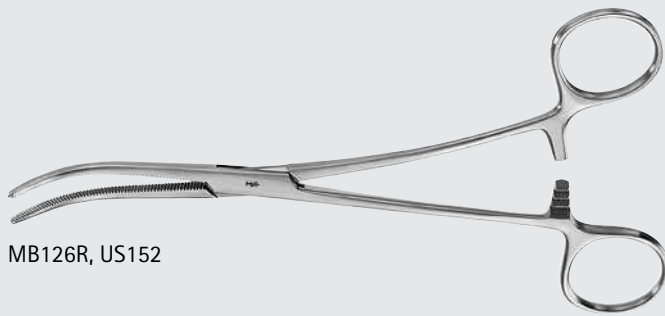

BLAKE Gall Stone Forceps

Catalog Number	Jaw	Length (in.)
EB220R	STR	8
EB221R	CVD	8

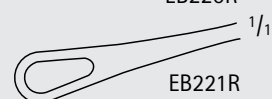
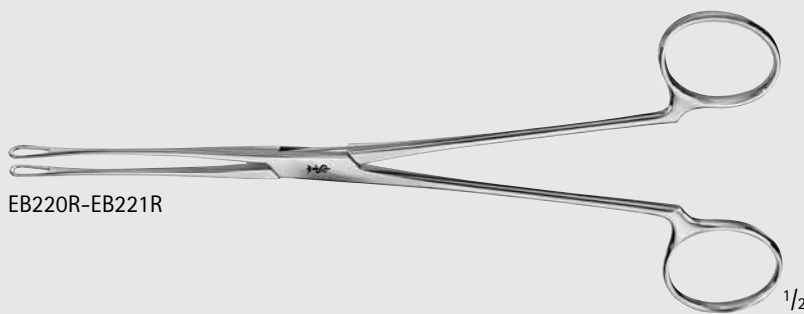

General Surgery

Abdominal and Intestinal Forceps

GENERAL SURGERY

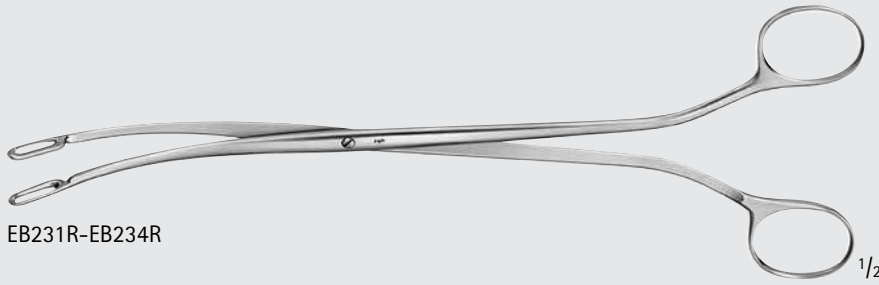

EB231R-EB234R

DESJARDINS Gall Stone Forceps

Catalog Number	Tip	Length (in.)
EB231R	OVAL	8 7/8
EB232R	OVAL	8 7/8
EB233R	TAPERED	8 7/8
EB234R	TAPERED	8 7/8



1/1



EB231R

1/1



EB232R

1/1



EB233R

1/1



EB234R

1/1

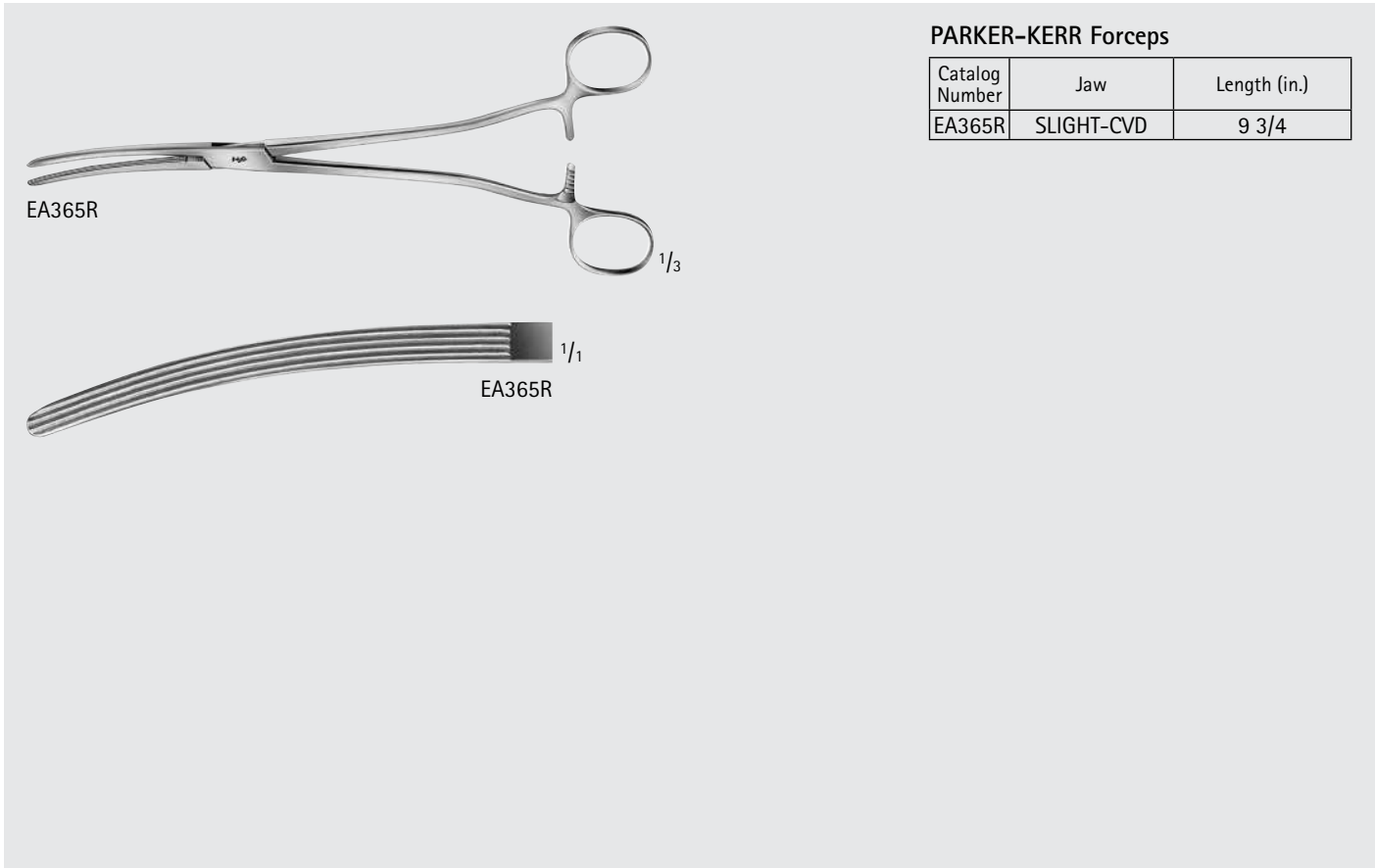

PARKER-KERR Forceps

Catalog Number	Jaw	Length (in.)
EA365R	SLIGHT-CVD	9 3/4

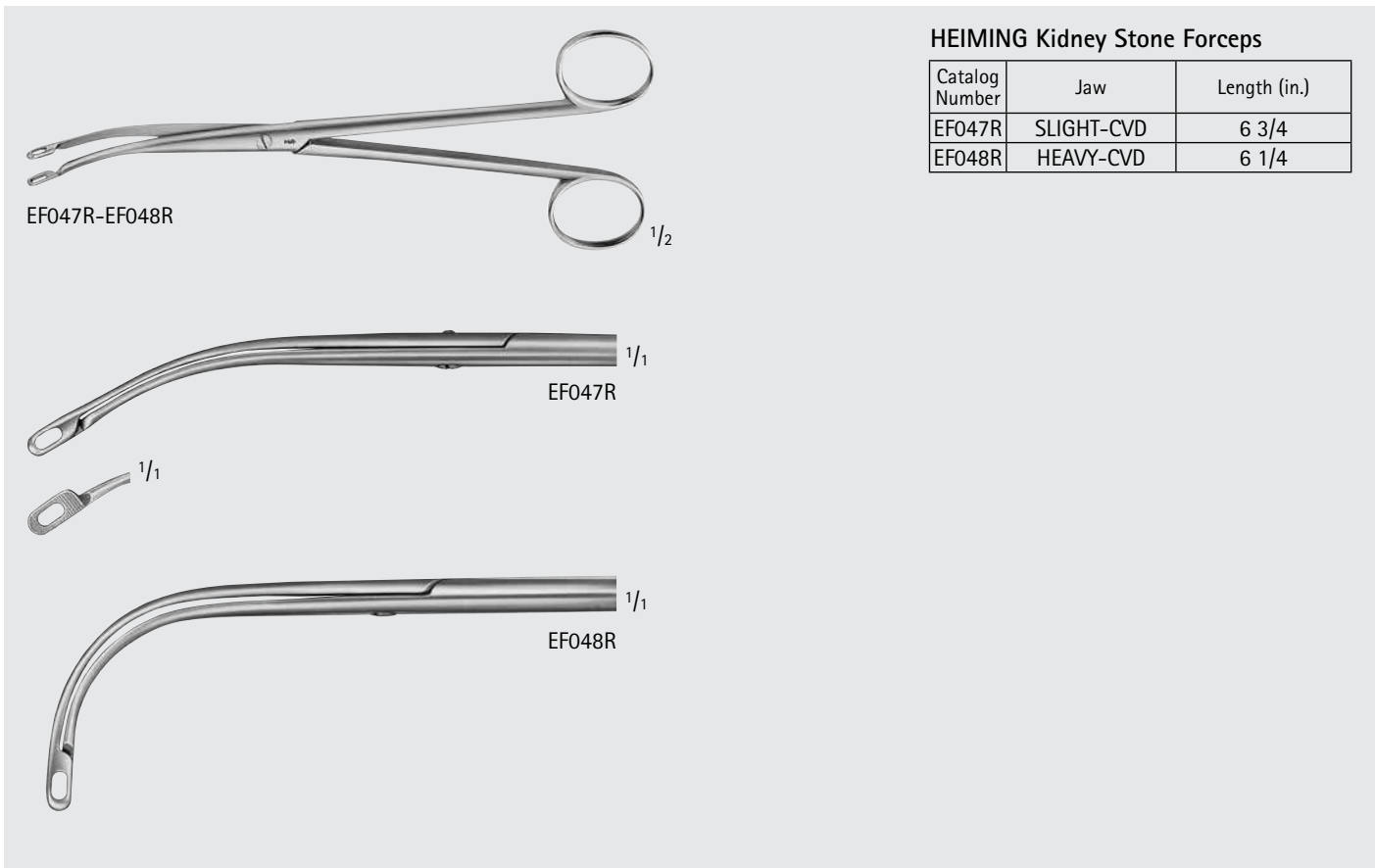

HEIMING Kidney Stone Forceps

Catalog Number	Jaw	Length (in.)
EF047R	SLIGHT-CVD	6 3/4
EF048R	HEAVY-CVD	6 1/4



General Surgery

Abdominal and Intestinal Forceps

GENERAL SURGERY

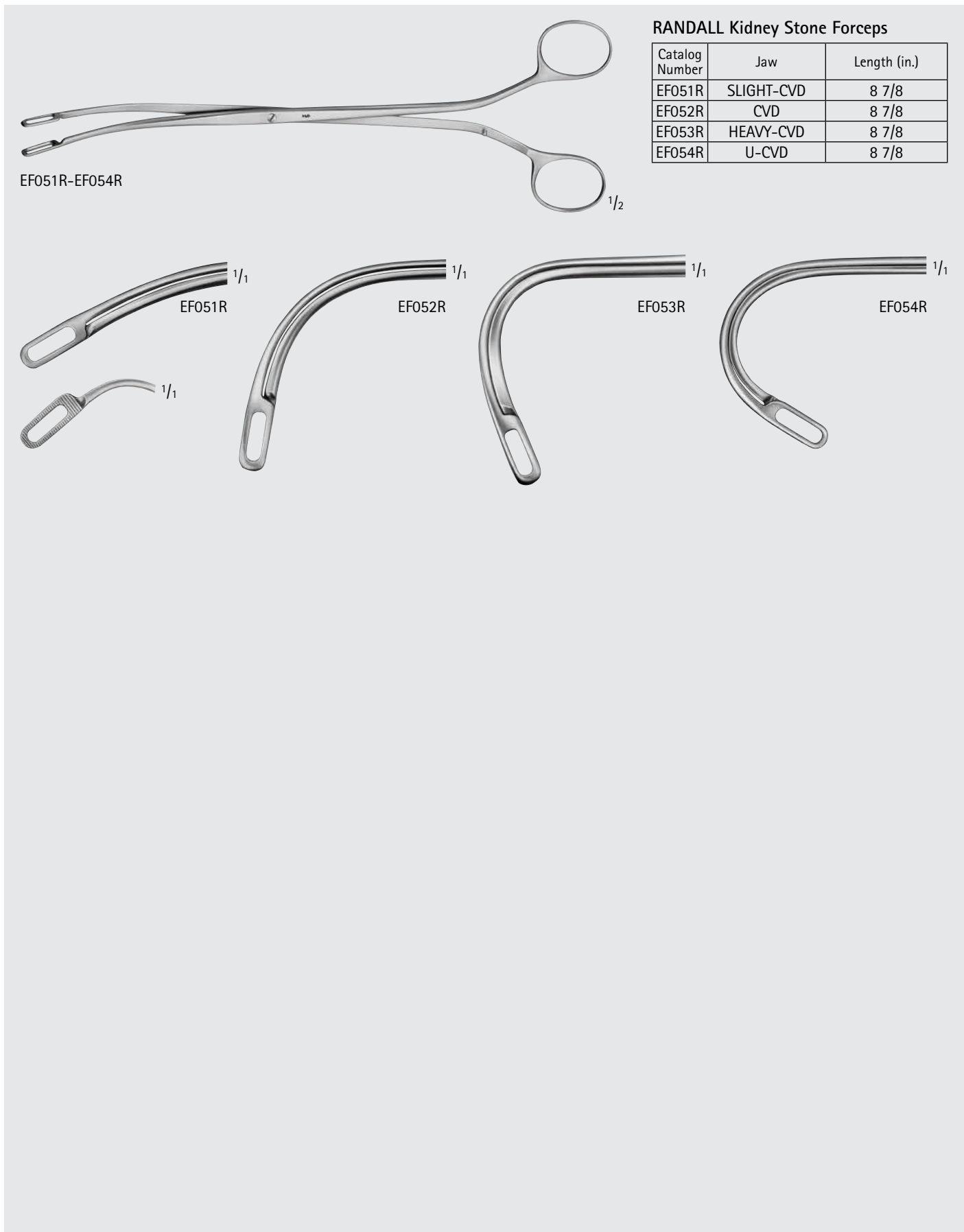

RANDALL Kidney Stone Forceps

Catalog Number	Jaw	Length (in.)
EF051R	SLIGHT-CVD	8 7/8
EF052R	CVD	8 7/8
EF053R	HEAVY-CVD	8 7/8
EF054R	U-CVD	8 7/8

EF051R-EF054R

1/2

EF051R

EF052R

EF053R

EF054R

1/1

1/1

1/1

1/1

RANDALL Kidney Stone Forceps
(continued)

Catalog Number	Jaw	Length (in.)
EF055R	CVD	7 1/2
EF056R	HEAVY-CVD	7 1/2
EB244R	90° ANG	9 5/8
EB246R	HEAVY-CVD, DEL	9

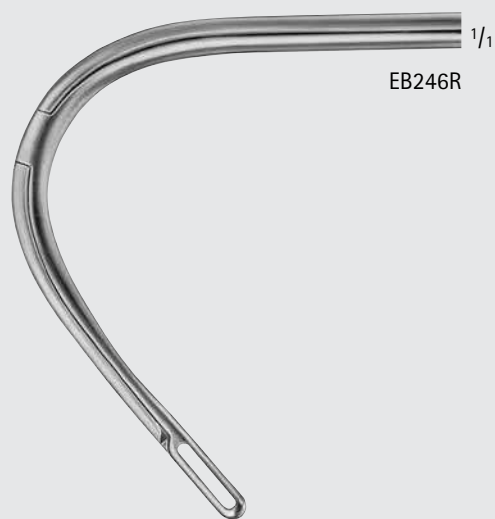
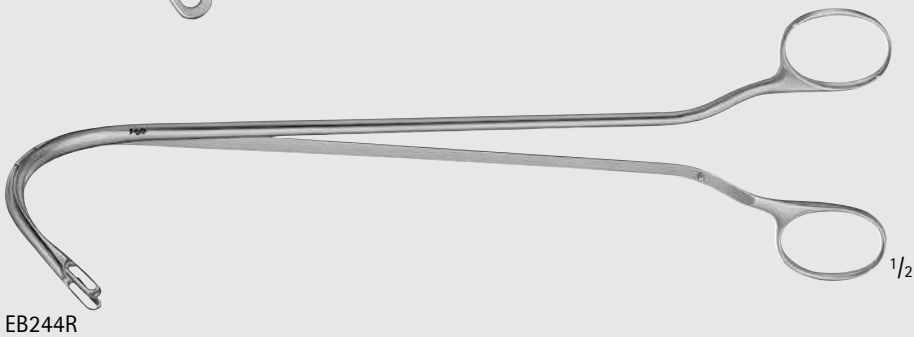
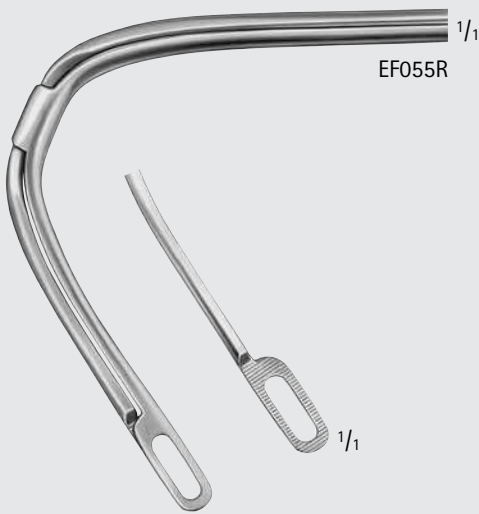
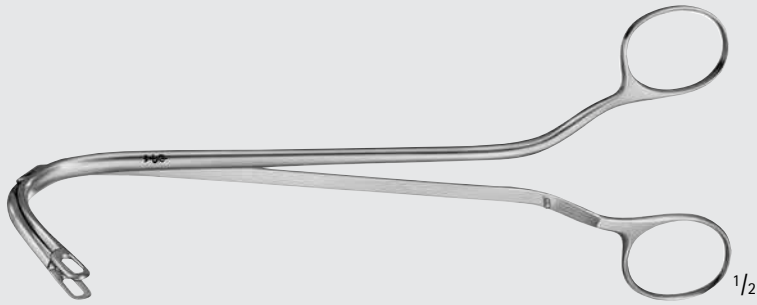



General Surgery

Atraumatic Intestinal Forceps and Clamps

GENERAL SURGERY

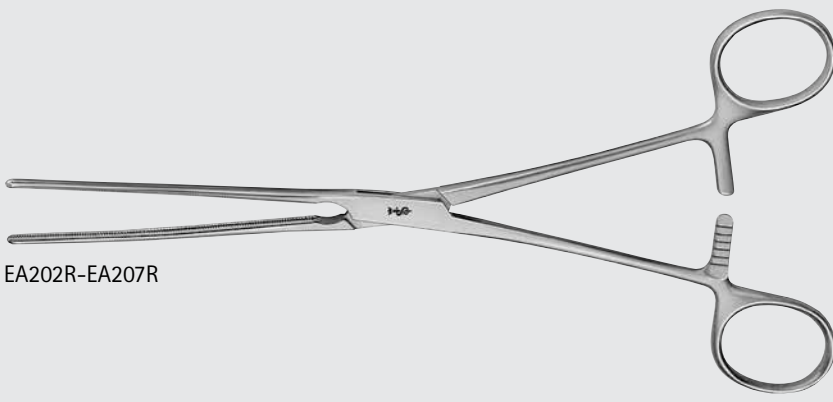
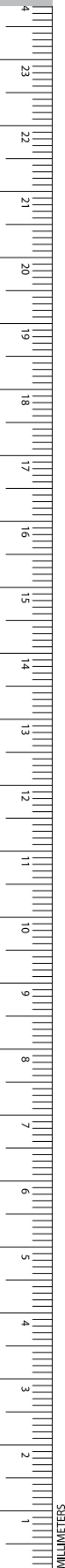

EA202R-EA207R

KOCHER Atraumatic Forceps, Elastic Blades

Catalog Number	Jaw	Length (in.)
EA202R	STR	8 3/4
EA204R	STR	9 3/4
EA206R	STR	11
EA203R	CVD	8 3/4
EA205R	CVD	9 3/4
EA207R	CVD	11



EA202R



EA204R



EA206R

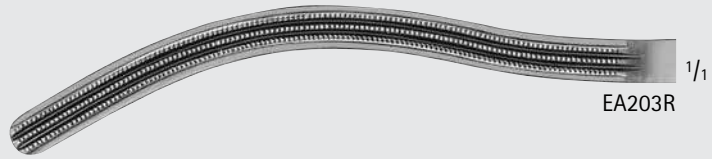

EA203R



EA205R



EA207R

HARTMANN Atraumatic Forceps, Elastic Blades

Catalog Number	Jaw	Length (in.)
EA210R	STR	7 7/8
EA211R	CVD	7 7/8

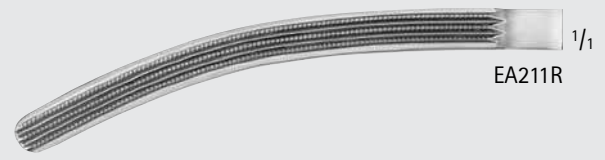
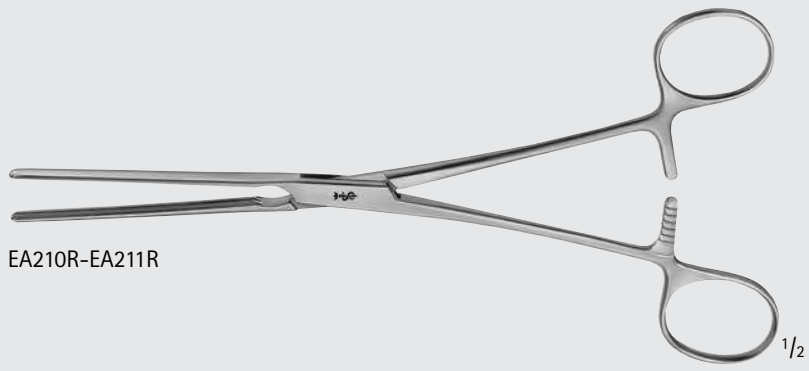

MAYO-ROBSON Atraumatic Forceps

Catalog Number	Jaw	Length (in.)
EA216R	STR	9 3/4
EA217R	CVD	9 3/4

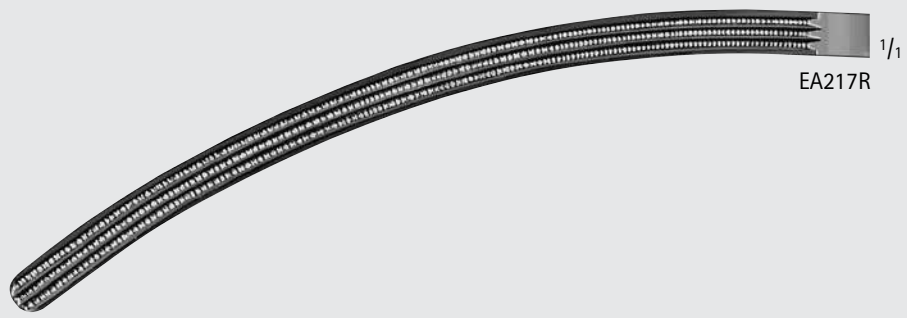

General Surgery

Atraumatic Intestinal Forceps and Clamps

GENERAL SURGERY

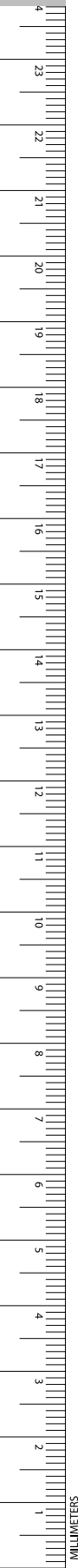

DOYEN Atraumatic Forceps, Elastic Blades

Catalog Number	Jaw	Length (in.)
EA222R	STR	6 3/4
EA212R	STR	9
EA223R	CVD	6 3/4
EA213R	CVD	9

EA212R-EA223R

EA222R 1/1

EA212R 1/1

EA223R 1/1

EA213R 1/1

SCUDDER Atraumatic Forceps

Catalog Number	Jaw	Length (in.)
EA240R	STR	13

EA240R

EA240R 1/2

GLASSMAN Anterior Resection Clamp

Catalog Number	Jaw	Jaw Length (mm)	Length (in.)
MB931R	90°, SERR	25	9 3/4
MB130R	90°, SERR	50	9 3/4
MB932R	90°, SERR	75	10

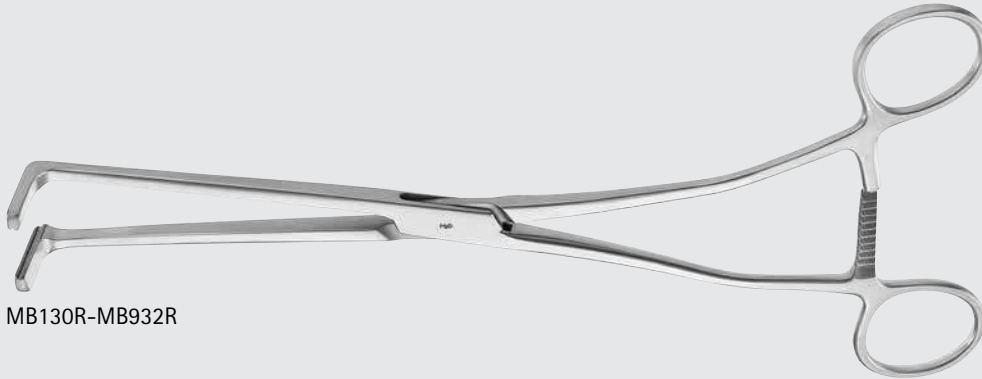

MB130R-MB932R



MB931R

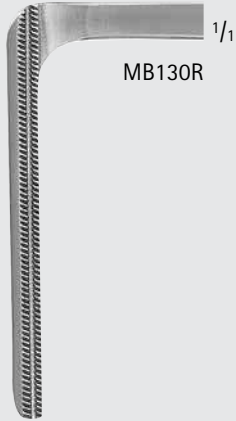

MB130R

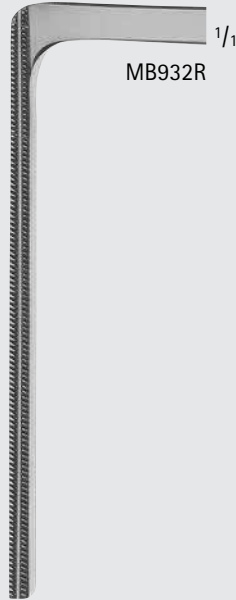

MB932R



General Surgery

Atraumatic Intestinal Forceps and Clamps

GENERAL SURGERY



CARTER-GLASSMAN Resection Clamp

Catalog Number	Jaw	Jaw Length (mm)	Length (in.)
MG460R	STR	110	11
MG439R	45° ANG	103	10 1/4



MG460R

1/2



1/1

MG460R



MG439R

1/2

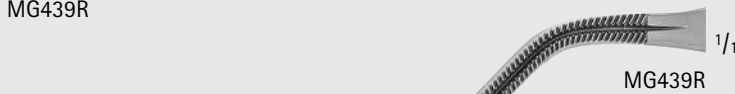

1/1

MG439R

GLASSMAN Intestinal and Liver Holding Clamp, Non-Crushing

Catalog Number	Jaw	Length (in.)
MG436R	STR	9 3/4
MG437R	CVD	9 5/8
MG438R	FULL CVD	9

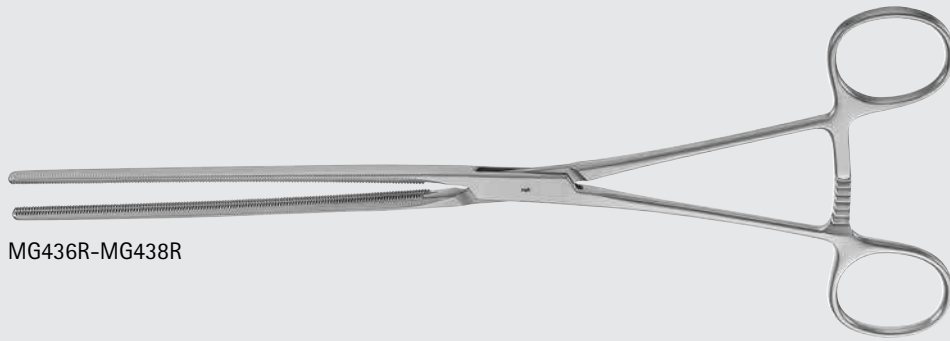

MG436R-MG438R



MG436R



MG437R



MG438R



INCHES

General Surgery

Atraumatic Intestinal Forceps and Clamps

GENERAL SURGERY

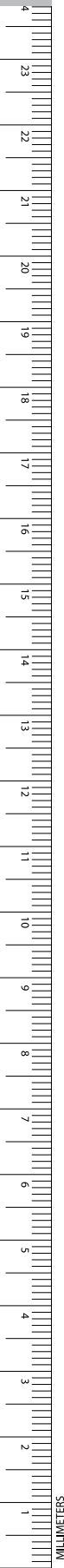

GLASSMAN Gastroenterostomy Clamp

Catalog Number	Jaw	Jaw Length (mm)	Length (in.)
MG433R	STR	116	11 1/2
MG434R	ANG	115	11 1/2

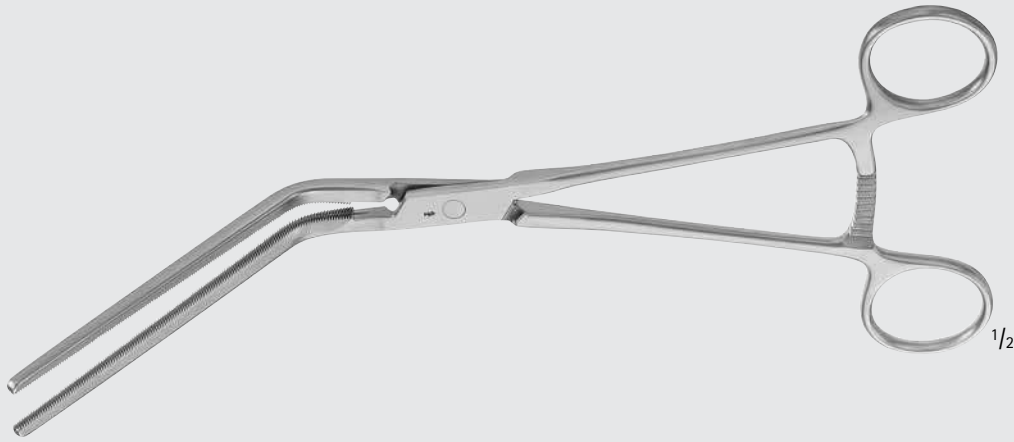

MG433R-MG434R



MG433R

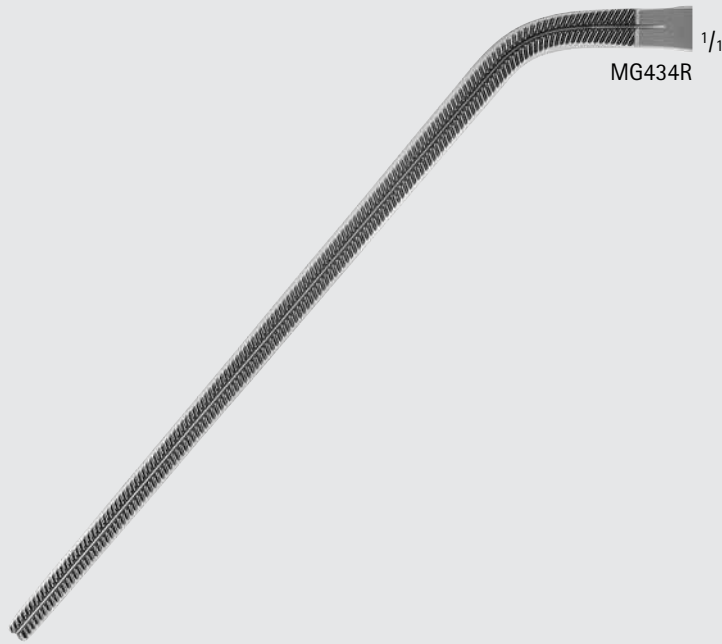

MG434R

GLASSMAN Gastrointestinal Clamp, Non-Crushing

Catalog Number	Jaw	Length (in.)
MB138R	STR	9 1/4
MB139R	ANG	9

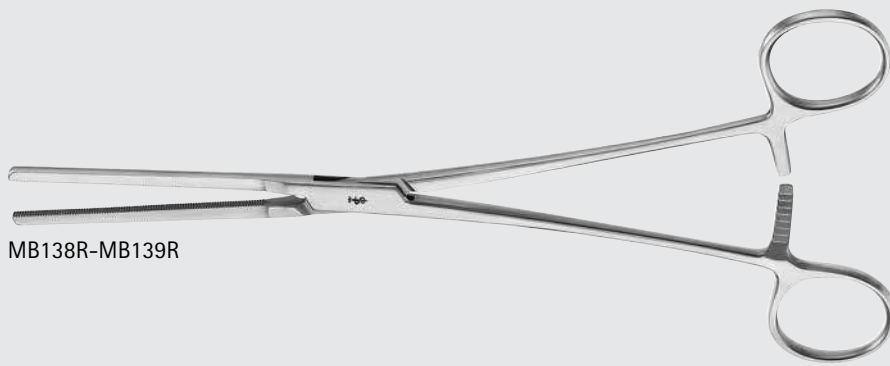

MB138R-MB139R

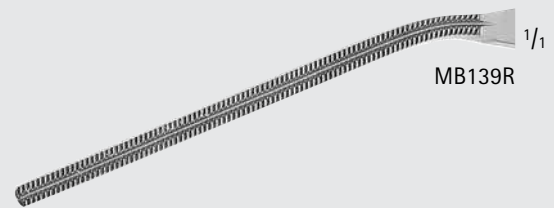
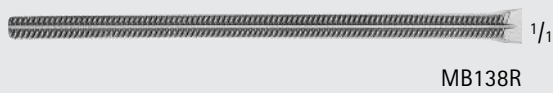

LISTER Sponge Forceps

Catalog Number	Jaw	Length (in.)
BF004R	STR	5 1/4
BF006R	STR	6 1/4
BF008R	STR	7 1/4

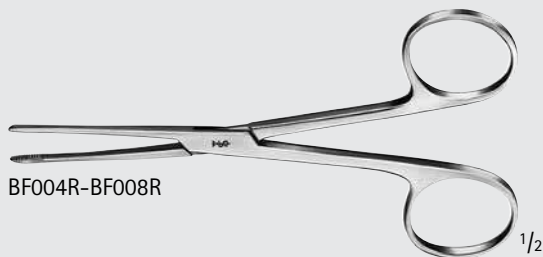

BF004R-BF008R

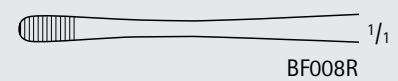
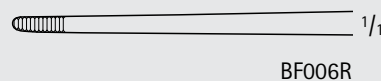
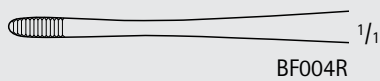

GROSS Forceps, W/ Ratchet

Catalog Number	Jaw	Length (in.)
BF046R	STR	7 7/8
BF047R	CVD	7 7/8

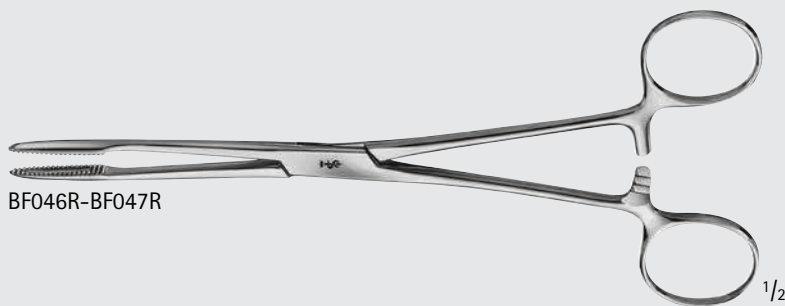

BF046R-BF047R

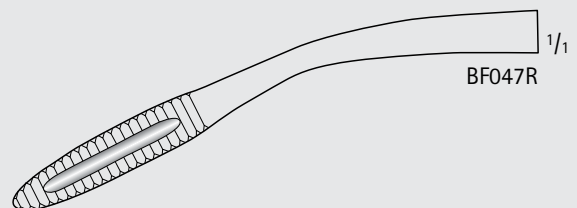
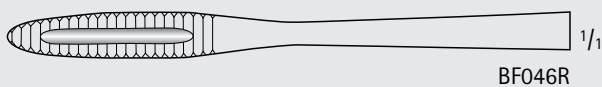

General Surgery

Dressing and Sponge Forceps

GENERAL SURGERY

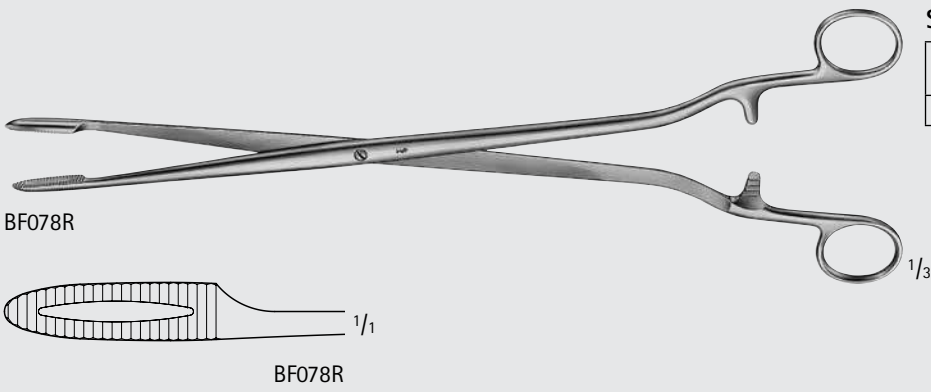
SIMS-MAIER Sponge Forceps

Catalog Number	Jaw	Length (in.)
BF078R	STR	13 3/4

BF078R

1/3

1/1

BF078R

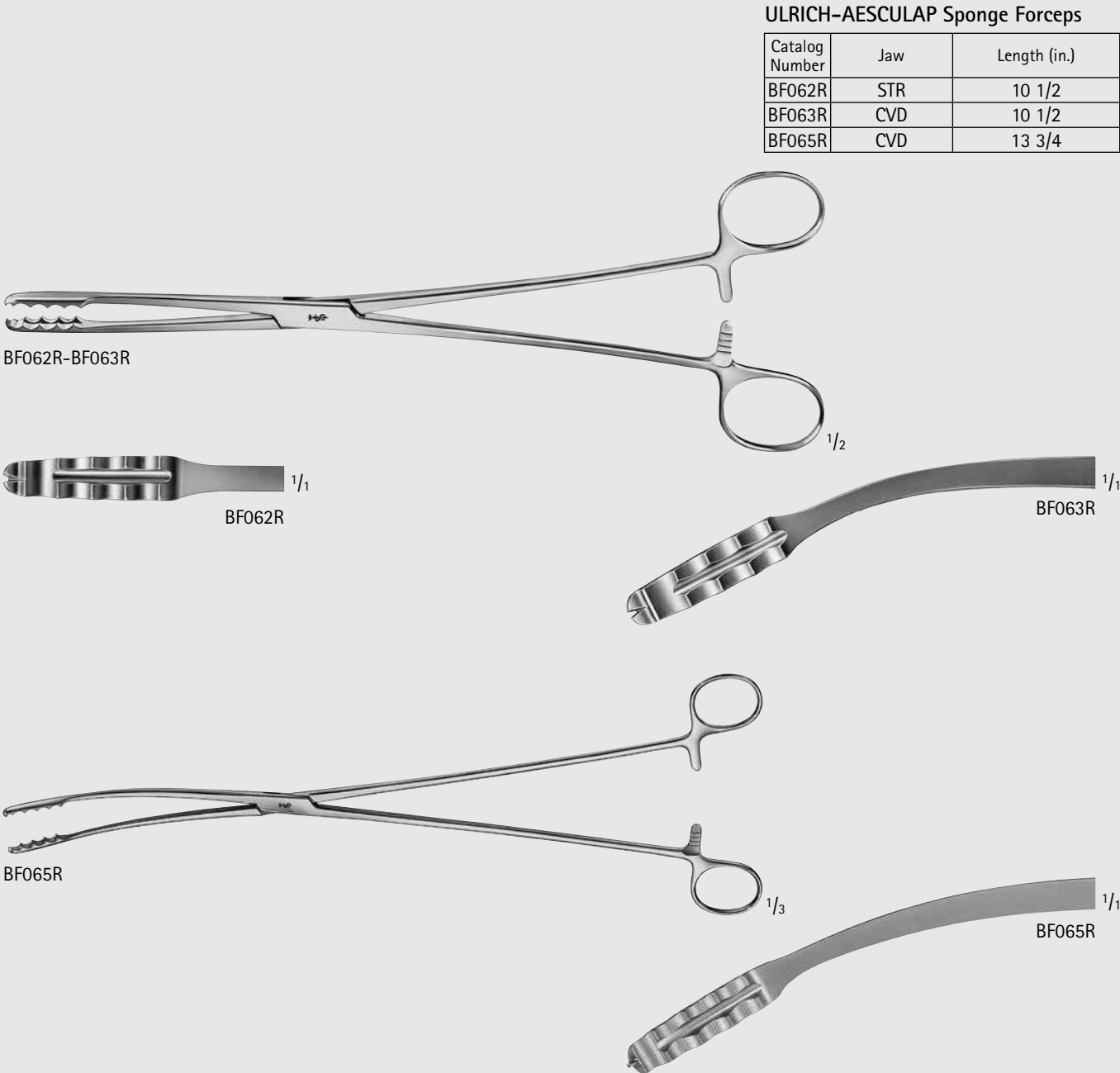

ULRICH-AESCULAP Sponge Forceps

Catalog Number	Jaw	Length (in.)
BF062R	STR	10 1/2
BF063R	CVD	10 1/2
BF065R	CVD	13 3/4

BF062R-BF063R

1/2

1/1

BF062R

1/1

BF063R

BF065R

1/3

1/1

BF065R

RAMPLEY Sponge Forceps

Catalog Number	Tip	Jaw	Length (in.)
BF116R	SERR	STR	7
BF118R	SERR	STR	9 3/4

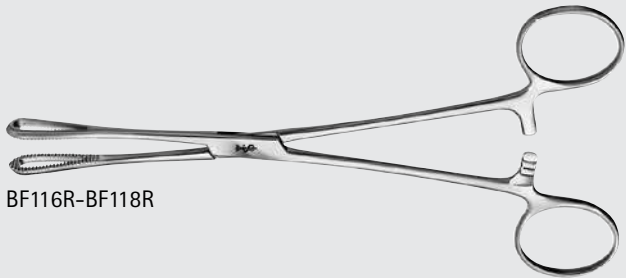

BF116R-BF118R



BF116R

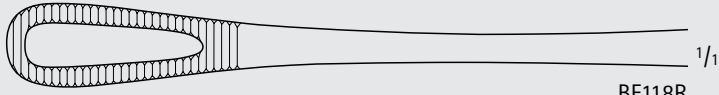

BF118R



INCHES

General Surgery

Dressing and Sponge Forceps

FOERSTER Sponge Forceps

Catalog Number	Tip	Jaw	Length (in.)
MB098R	SERR	STR	12
MB099R	SERR	STR	14
MB904R	SERR	STR	16

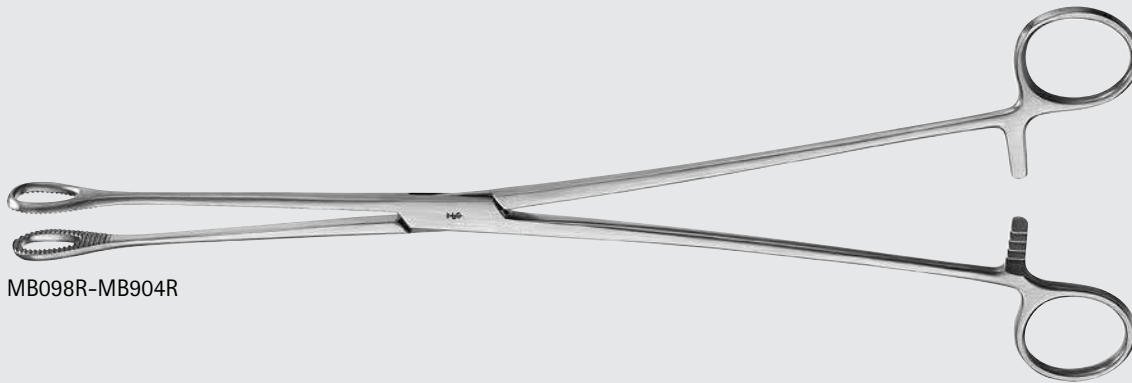

MB098R-MB904R

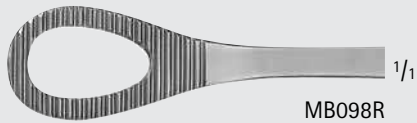

MB098R



MB099R



MB904R

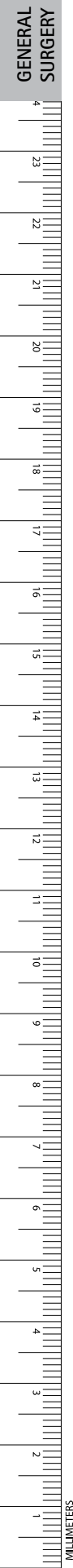

FOERSTER-BALLENGER Sponge Forceps

Catalog Number	Tip	Jaw	Length (in.)
BF112R	SERR	STR	7
BF120R	SMOOTH	STR	9 5/8
BF122R	SERR	STR	9 5/8
BF113R	SERR	CVD	7
BF121R	SMOOTH	CVD	9 5/8
BF123R	SERR	CVD	9 5/8

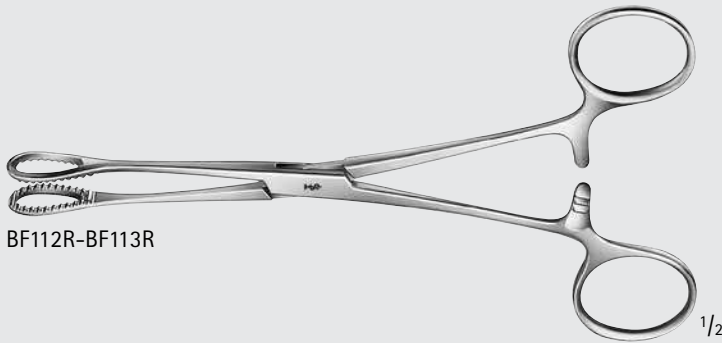

BF112R-BF113R

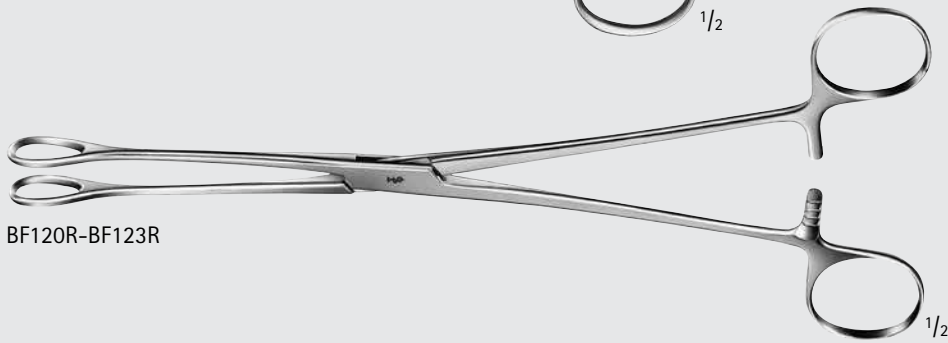

BF120R-BF123R

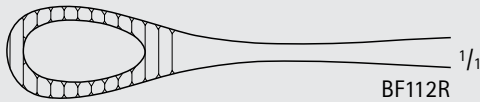

BF112R



BF120R

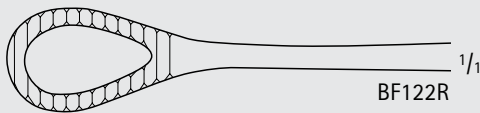

BF122R

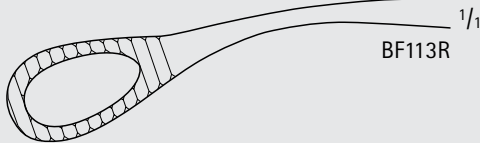

BF113R

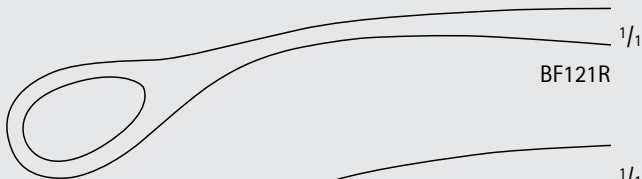

BF121R

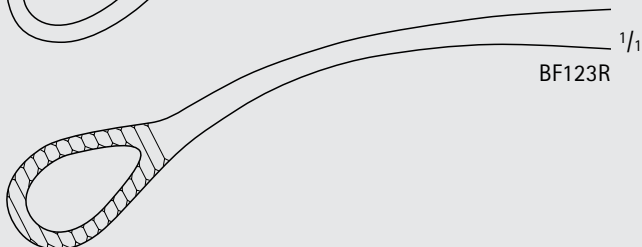

BF123R



INCHES

General Surgery

Dressing and Sponge Forceps

GENERAL SURGERY

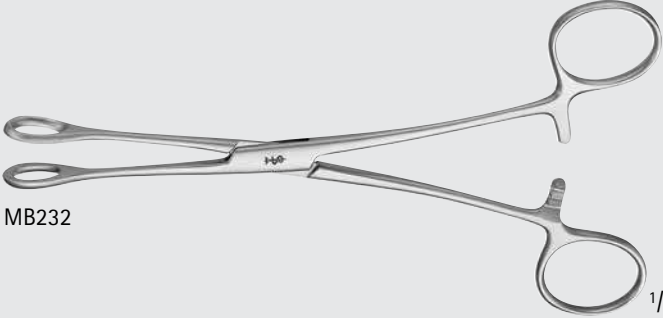
MB232 $\frac{1}{2}$

BALLENGER Sponge Forceps

Catalog Number	Tip	Jaw	Length (in.)
MB232	SMOOTH	STR	7

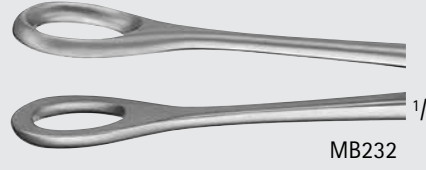

$\frac{1}{1}$
MB232

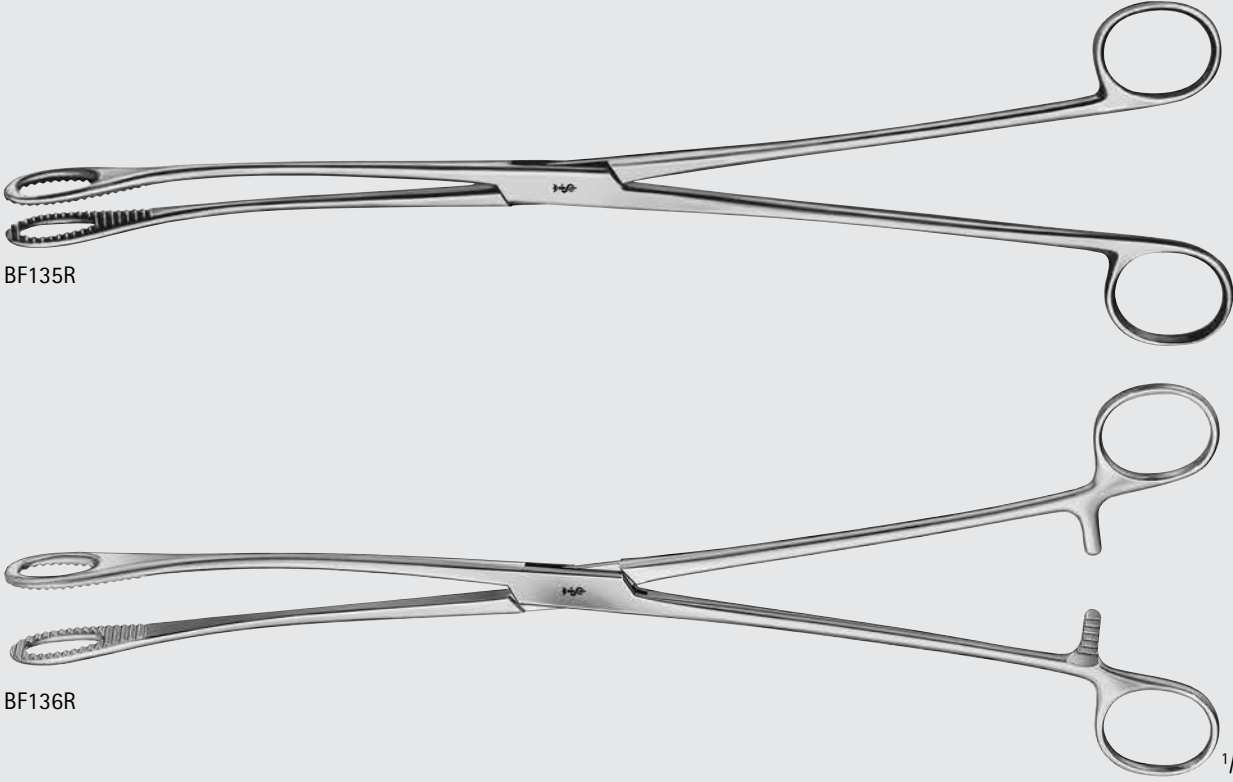

BF135R $\frac{1}{2}$

BF136R $\frac{1}{2}$

KELLY Sponge Forceps

Catalog Number	Tip	Jaw	Handle	Length (in.)
BF135R	SERR	CVD	W/ OUT RATCHET	12 1/2
BF136R	SERR	CVD	W/ RATCHET	12 1/2



$\frac{1}{1}$
BF135R-BF136R

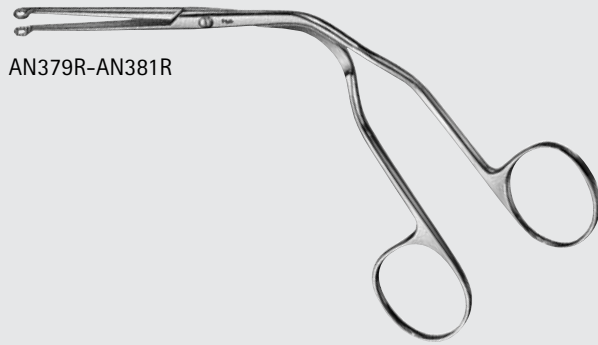

AN379R-AN381R

MAGILL Forceps

Catalog Number	Size	Length (in.)
AN379R	INFANT	6
AN380R	PEDIATRIC	7 7/8
AN381R	ADULT	9 3/4



AN379R



AN380R



AN381R

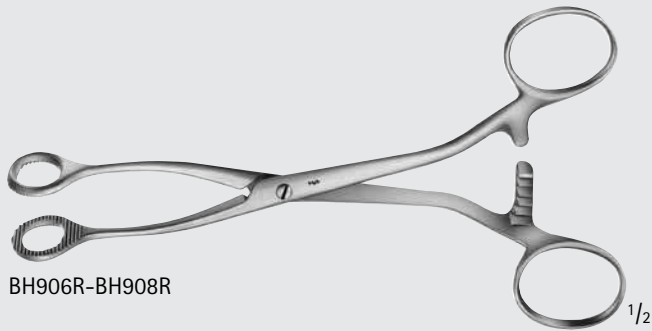

BH906R-BH908R

COLLIN Forceps W/ Ratchet

Catalog Number	Jaw	Length (in.)
BH906R	OVAL	6 1/4
BH908R	TEARDROP	6 1/4

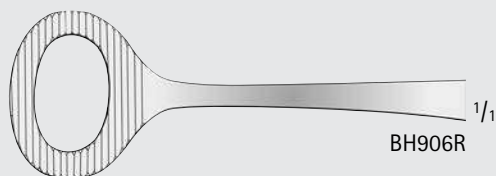

BH906R

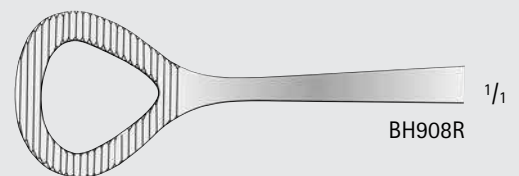

BH908R



General Surgery

Tongue Forceps

GENERAL SURGERY

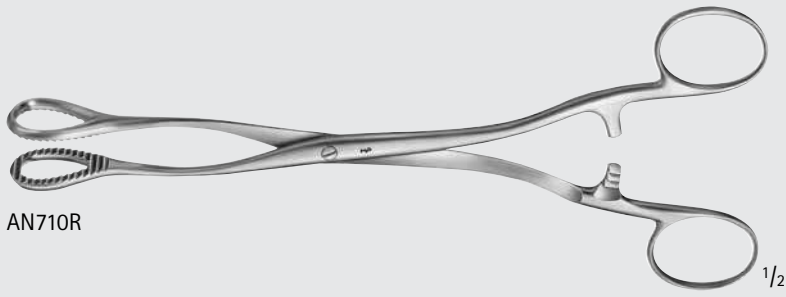

AN710R

1/2

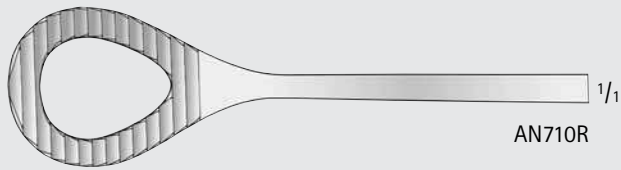

AN710R

1/1

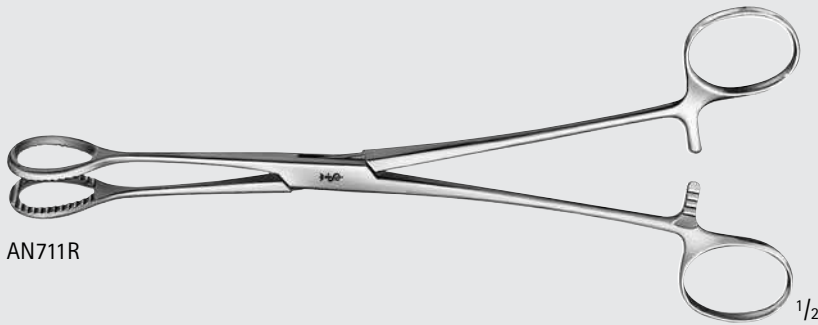

AN711R

1/2

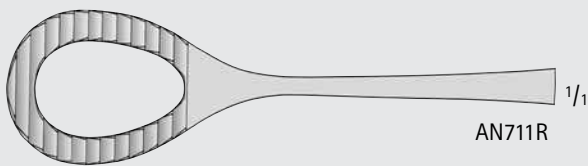

AN711R

1/1

HEYWOOD-SMITH Forceps

Catalog Number	Tip	Length (in.)
AN710R	SERR	7 7/8
AN711R	SERR	8 1/4

YEOMAN Rectal Biopsy Forceps

Catalog Number	Tip Size (mm)	Shaft Length (in.)
EA903R	4	16 1/2

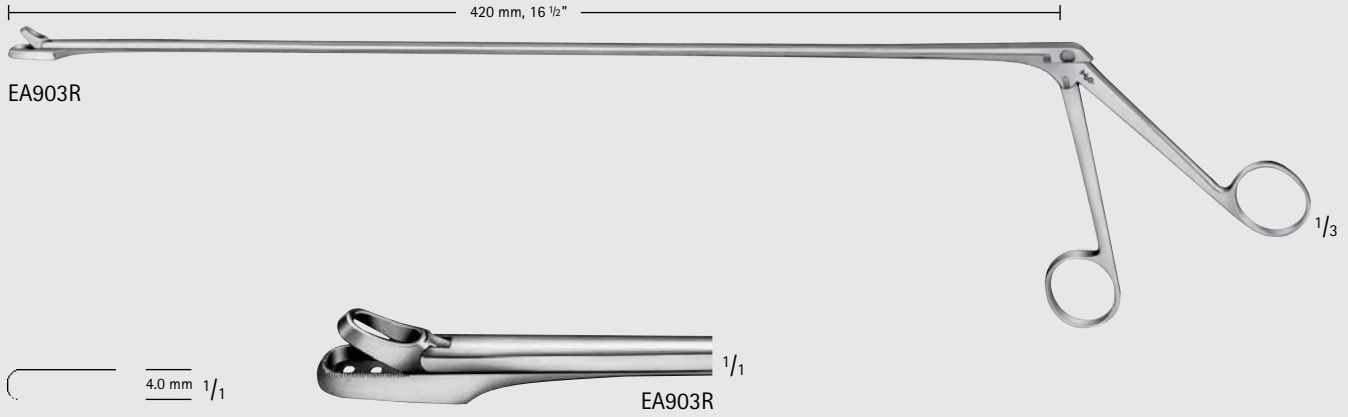

INCHES

General Surgery

Biopsy Forceps

GENERAL SURGERY



AESCULAP Rectal Swab Holder

Catalog Number	Shaft Length (in.)
EA943R	15 3/4

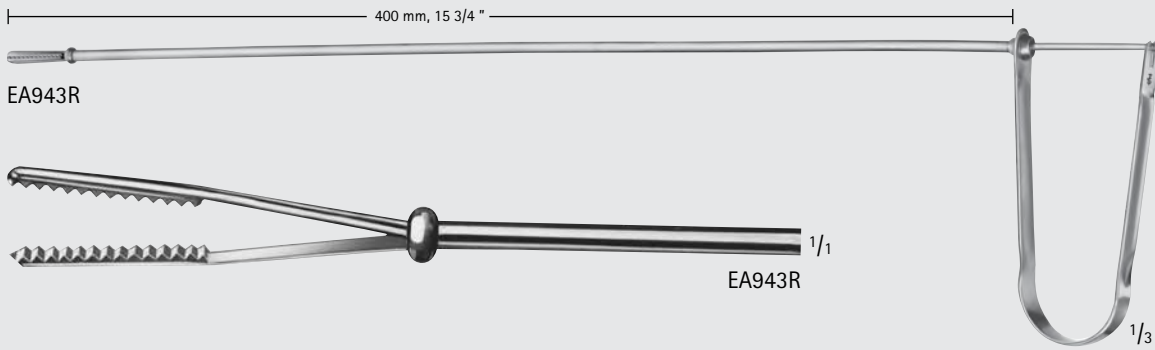

EA943R

EA943R

1/3

400 mm, 15 3/4 "



MB200R

1/2



MG098R

1/2

PRICE Muscle Biopsy Clamp

Catalog Number	Jaw	Jaw Size (mm)	Length (in.)
MB200R	DOUBLE-PRONG	8	4
MG098R	DOUBLE-PRONG	15	4 3/8

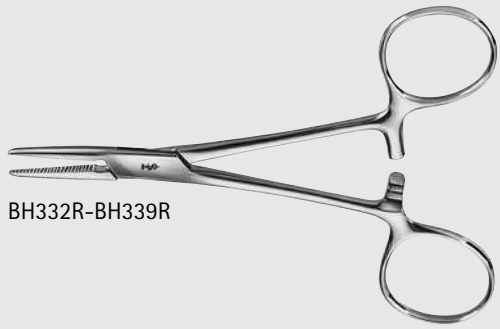

BH332R-BH339R



BH332R

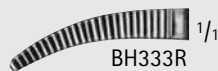

BH333R



BH334R



BH335R



BH336R



BH337R



BH338R



BH339R

SPENCER-WELLS Forceps

Catalog Number	Jaw	Length (in.)
BH332R	STR	5 1/8
BH334R	STR	6
BH336R	STR	6 7/8
BH338R	STR	7 7/8
BH333R	CVD	5 1/8
BH335R	CVD	6
BH337R	CVD	6 7/8
BH339R	CVD	7 7/8

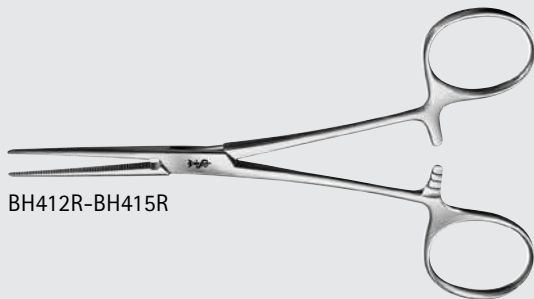

BH412R-BH415R



BH412R



BH413R



BH414R



BH415R

PEAN Forceps, Delicate

Catalog Number	Jaw	Length (in.)
BH412R	STR	5 1/8
BH414R	STR	5 1/2
BH413R	CVD	5 1/8
BH415R	CVD	5 1/2



INCHES

General Surgery

Hemostatic Forceps and Clamps

GENERAL SURGERY

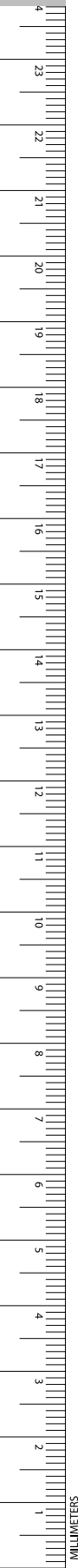
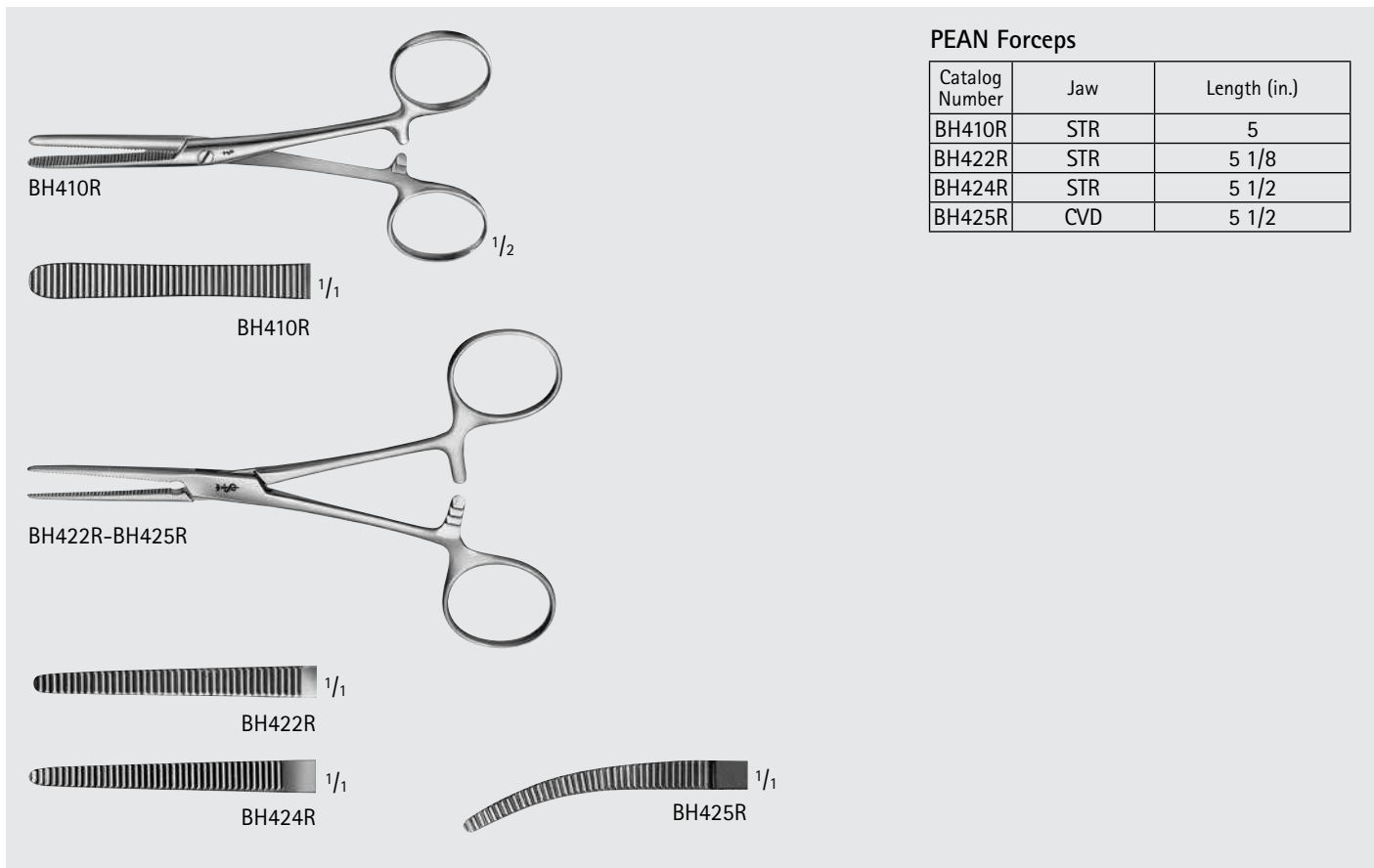
PEAN Forceps

Catalog Number	Jaw	Length (in.)
BH410R	STR	5
BH422R	STR	5 1/8
BH424R	STR	5 1/2
BH425R	CVD	5 1/2

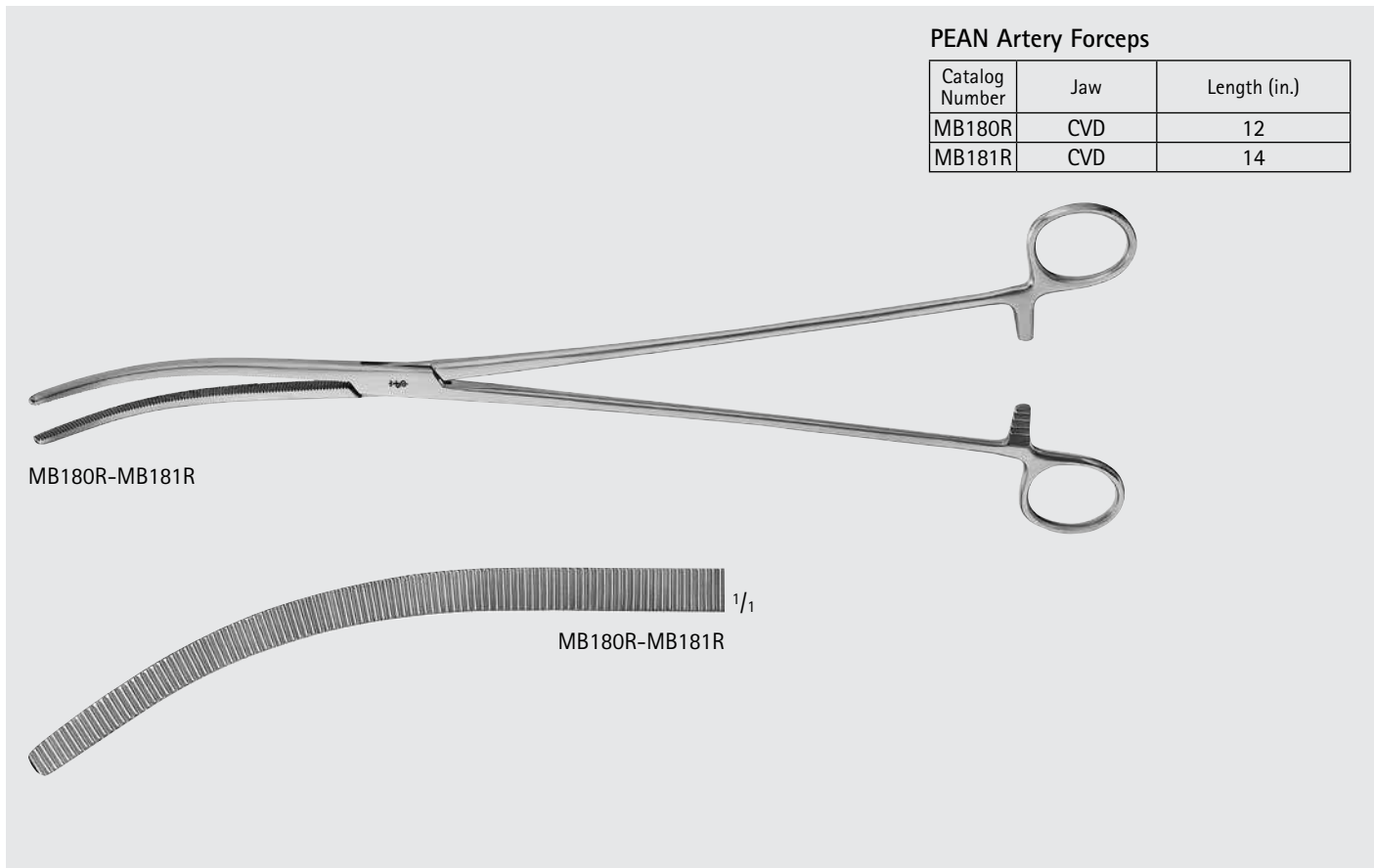

PEAN Artery Forceps

Catalog Number	Jaw	Length (in.)
MB180R	CVD	12
MB181R	CVD	14

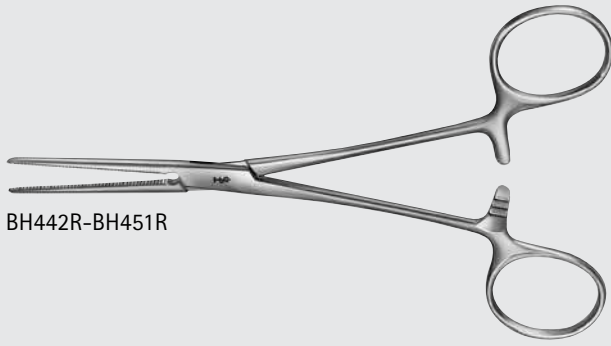

BH442R-BH451R

ROCHESTER-PEAN Forceps

Catalog Number	Jaw	Length (in.)
BH442R	STR	6 1/4
BH444R	STR	7 1/4
BH446R	STR	7 7/8
BH448R	STR	8 7/8
BH450R	STR	9 1/2
BH443R	CVD	6 1/4
BH445R	CVD	7 1/4
BH447R	CVD	7 7/8
BH449R	CVD	8 7/8
BH451R	CVD	9 1/2



BH442R



BH444R



BH446R



BH448R



BH450R



BH443R



BH445R



BH447R



BH449R

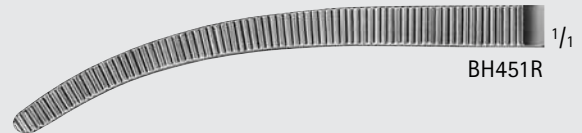

BH451R



INCHES

General Surgery

Hemostatic Forceps and Clamps

GENERAL SURGERY

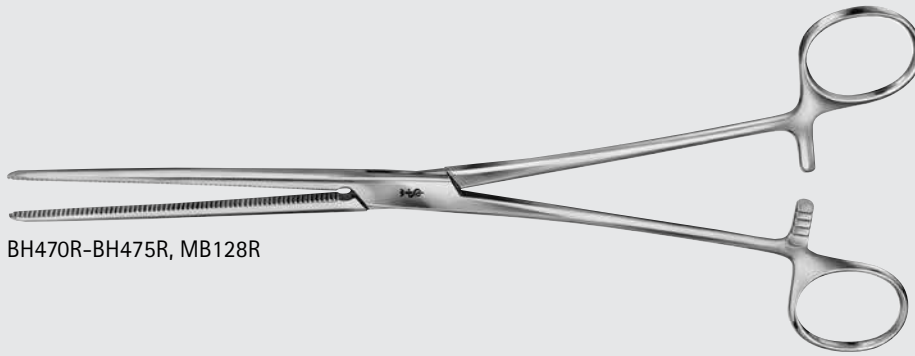

BH470R-BH475R, MB128R

PEAN Forceps, Long

Catalog Number	Jaw	Length (in.)
BH470R	STR	9 1/2
BH472R	STR	10 1/4
BH474R	STR	11
MB128R	STR	12
BH471R	CVD	9 1/2
BH473R	CVD	10 1/4
BH475R	CVD	11



BH470R



BH472R



BH474R



MB128R

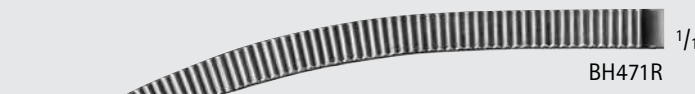

BH471R

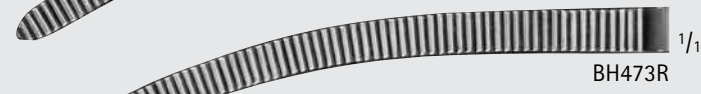

BH473R

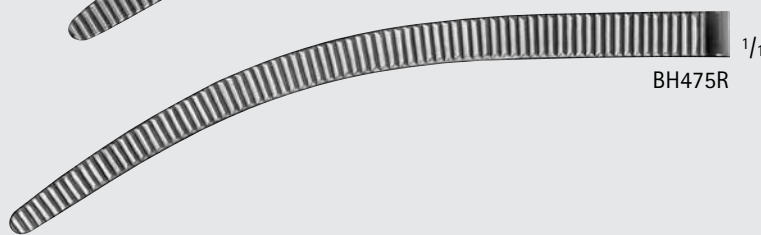

BH475R

KOCHER Forceps, Delicate

Catalog Number	Jaw	Teeth	Length (in.)
BH614R	STR	1 x 2	5 1/2
BH615R	CVD	1 x 2	5 1/2



BH614R-BH615R



BH614R



BH615R

KOCHER Forceps

Catalog Number	Jaw	Teeth	Length (in.)
BH630R	STR	1 x 2	6
BH631R	CVD	1 x 2	6

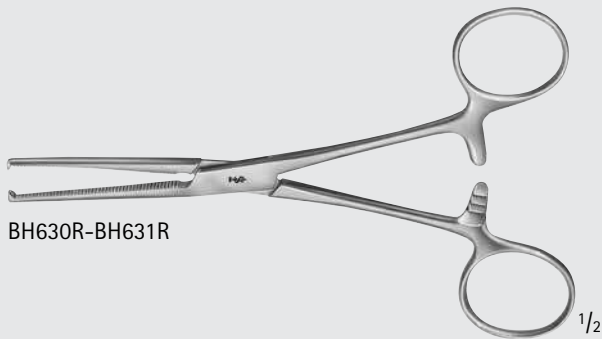

BH630R-BH631R



BH630R



BH631R



INCHES

General Surgery

Hemostatic Forceps and Clamps

GENERAL SURGERY

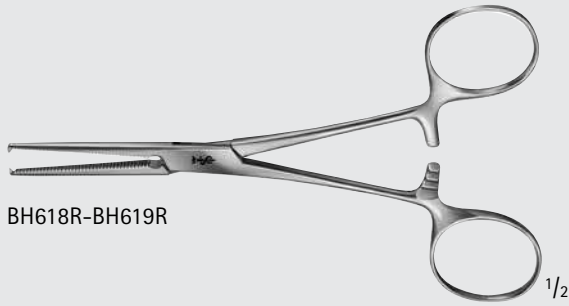
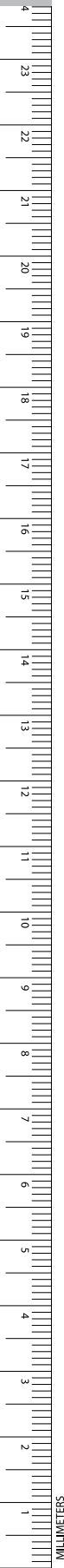

BH618R-BH619R

ROCHESTER-OCHSNER Forceps

Catalog Number	Jaw	Teeth	Length (in.)
BH618R	STR	1 x 2	5 1/2
BH619R	CVD	1 x 2	5 1/2



BH618R



BH619R

ROCHESTER-OCHSNER Artery Forceps

Catalog Number	Jaw	Teeth	Length (in.)
MB172R	STR	1 x 2	14

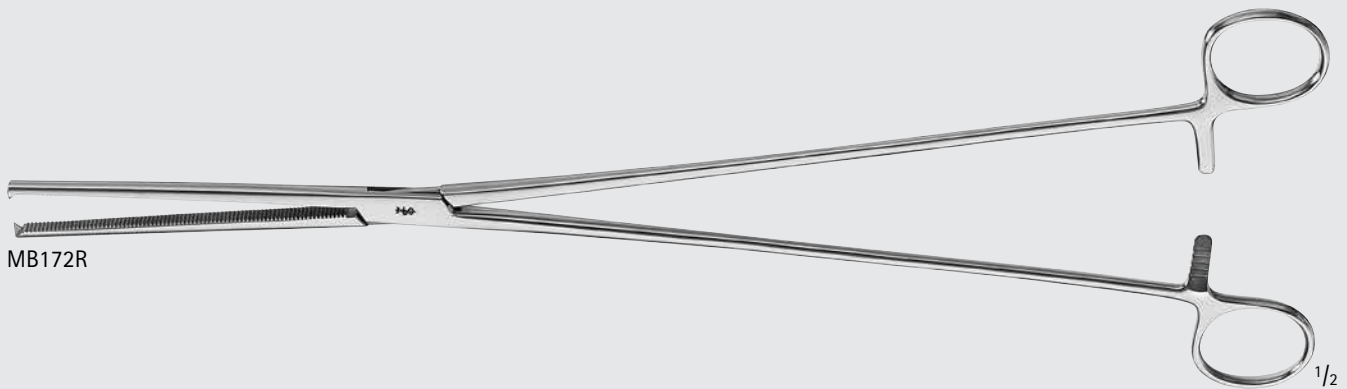

MB172R

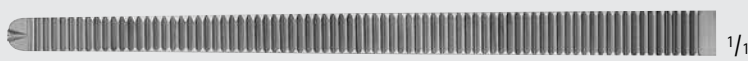

MB172R

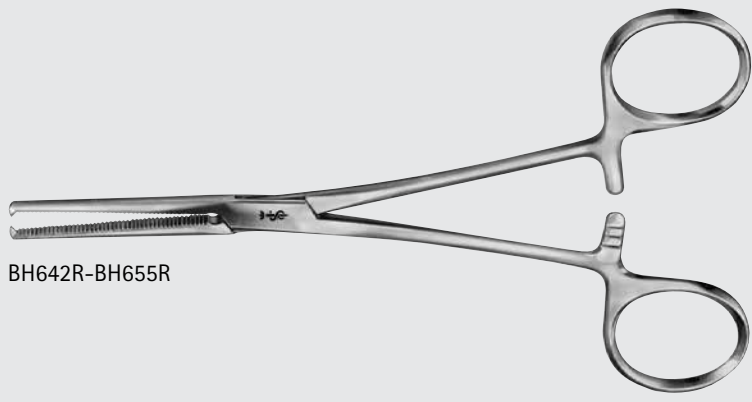

BH642R-BH655R

KOCHER-OCHSNER Forceps

Catalog Number	Jaw	Teeth	Length (in.)
BH642R	STR	1 x 2	6 1/4
BH644R	STR	1 x 2	7 1/4
BH646R	STR	1 x 2	7 7/8
BH648R	STR	1 x 2	8 7/8
BH650R	STR	1 x 2	9 1/2
BH652R	STR	1 x 2	10 1/4
BH654R	STR	1 x 2	11
BH643R	CVD	1 x 2	6 1/4
BH645R	CVD	1 x 2	7 1/4
BH647R	CVD	1 x 2	7 7/8
BH649R	CVD	1 x 2	8 7/8
BH651R	CVD	1 x 2	9 1/2
BH653R	CVD	1 x 2	10 1/4
BH655R	CVD	1 x 2	11



BH642R



BH644R



BH646R



BH648R



BH650R



BH652R



BH654R



BH643R



BH645R



BH647R



BH649R



BH651R



BH653R



BH655R



INCHES

General Surgery

Hemostatic Forceps and Clamps

GENERAL SURGERY



ROCHESTER-OCHSNER Forceps

Catalog Number	Jaw	Teeth	Length (in.)
MB807R	STR	1 x 2	14
MB909R	STR	1 x 2	16
MB908R	CVD	1 x 2	13 3/4

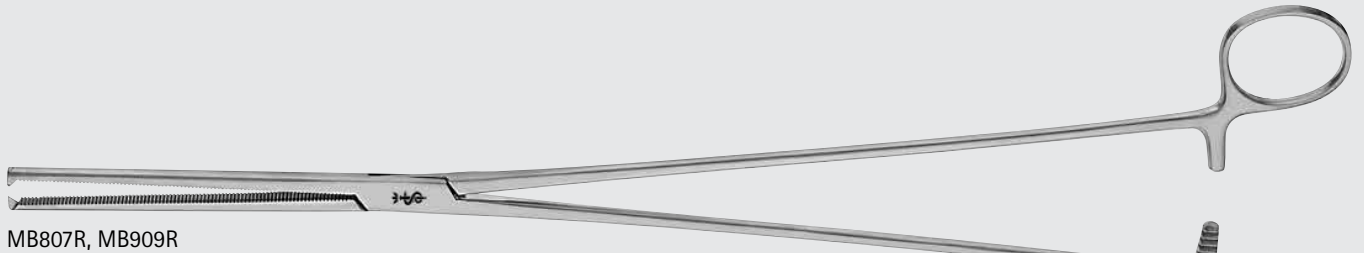

MB807R, MB909R



MB807R

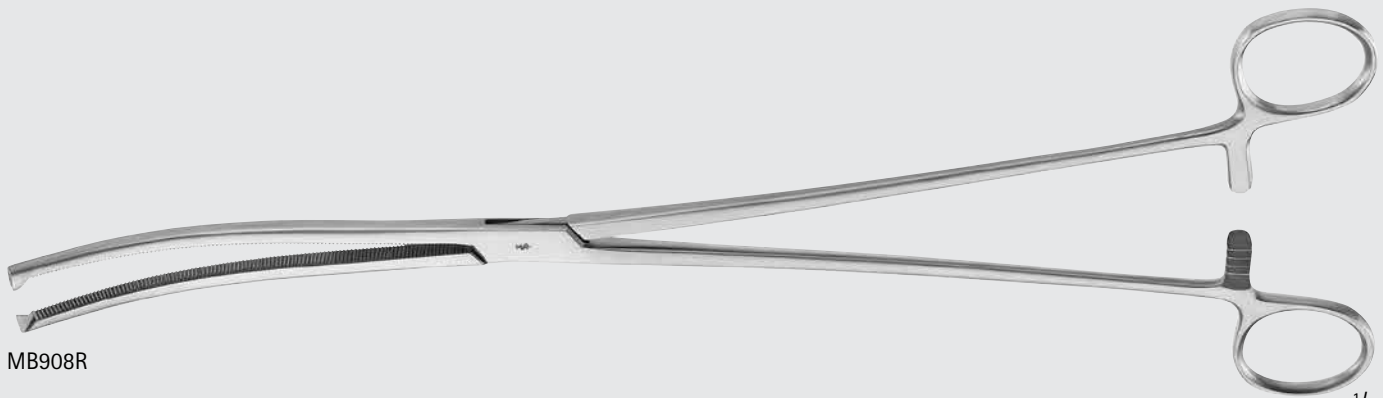

MB908R



MB908R

ROCHESTER-CARMALT Forceps

Catalog Number	Jaw	Length (in.)
BH800R	STR	6 1/4
BH804R	STR	7 7/8
MG196R	STR	9
MG431R	STR	10 1/4
BH801R	CVD	6 1/4
BH805R	CVD	7 7/8
MG197R	CVD	9
MG432R	CVD	10 1/4

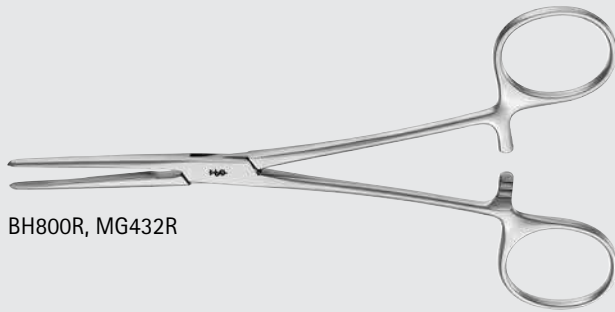

BH800R, MG432R



BH800R 1/1



BH804R 1/1



MG196R 1/1



MG431R 1/1



BH801R 1/1



BH805R 1/1

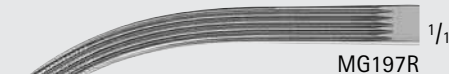

MG197R 1/1



MG432R 1/1

STOREY Forceps

Catalog Number	Tip	Length (in.)
MG353R	STRONG-CVD	8 3/4
MG354R	RIGHT-ANG	8 3/4

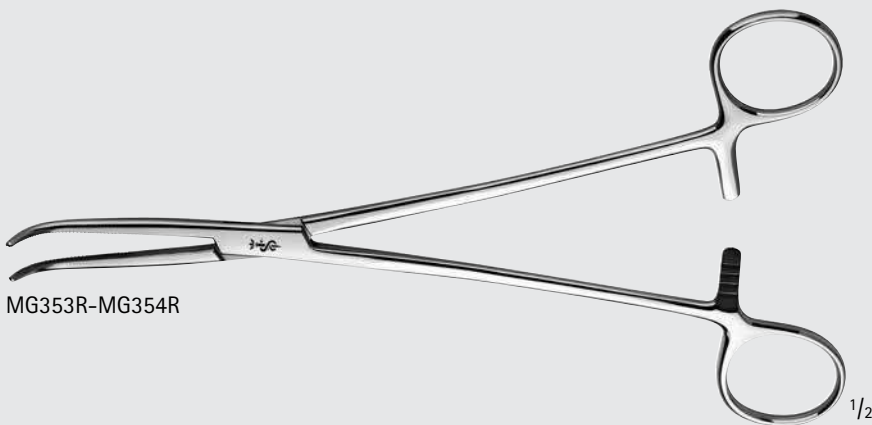

MG353R-MG354R 1/2



MG353R 1/1



MG354R 1/1



General Surgery

Hemostatic Forceps and Clamps

GENERAL SURGERY

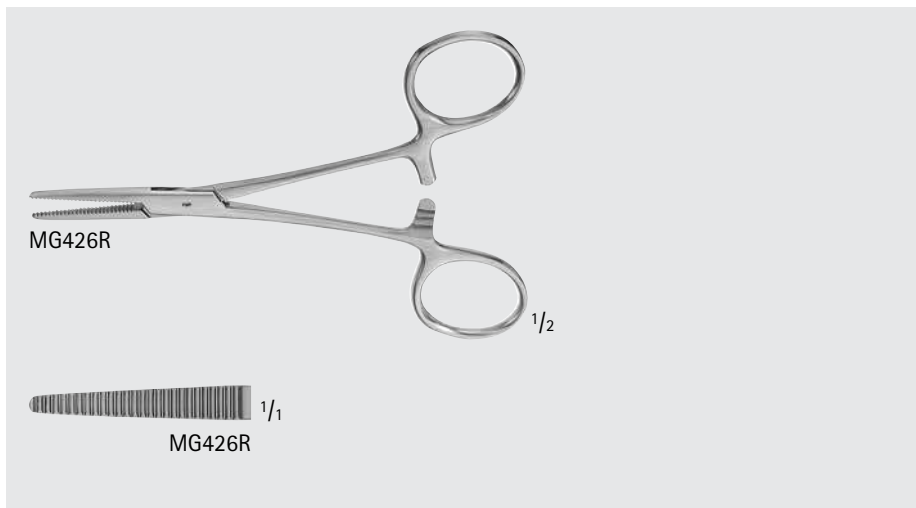

JONES Hemostatic Forceps

Catalog Number	Jaw	Length (in.)
MG426R	STR	5

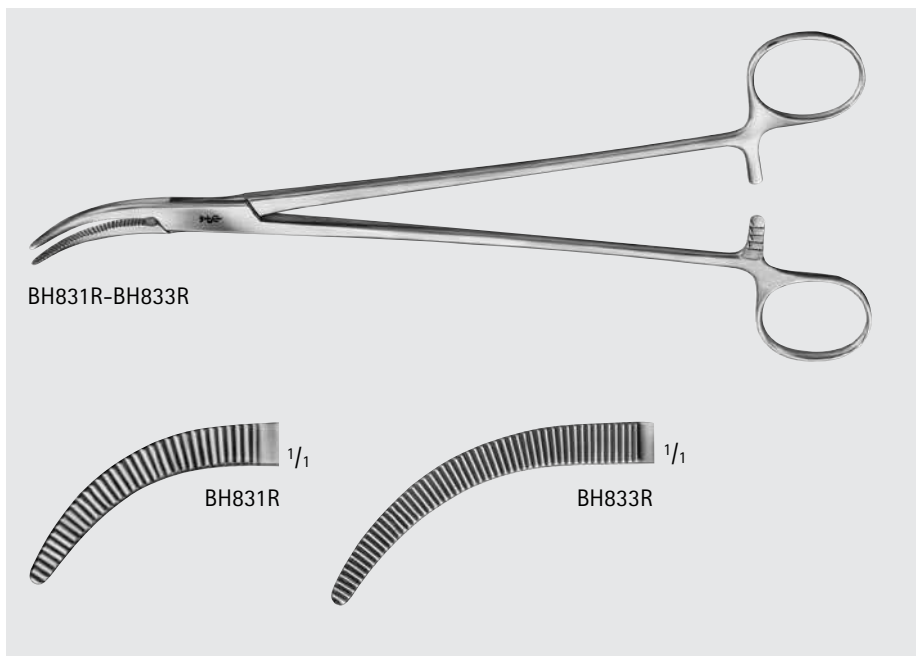

MOYNIHAN Forceps

Catalog Number	Jaw	Length (in.)
BH831R	CVD	9
BH833R	CVD	9 1/2

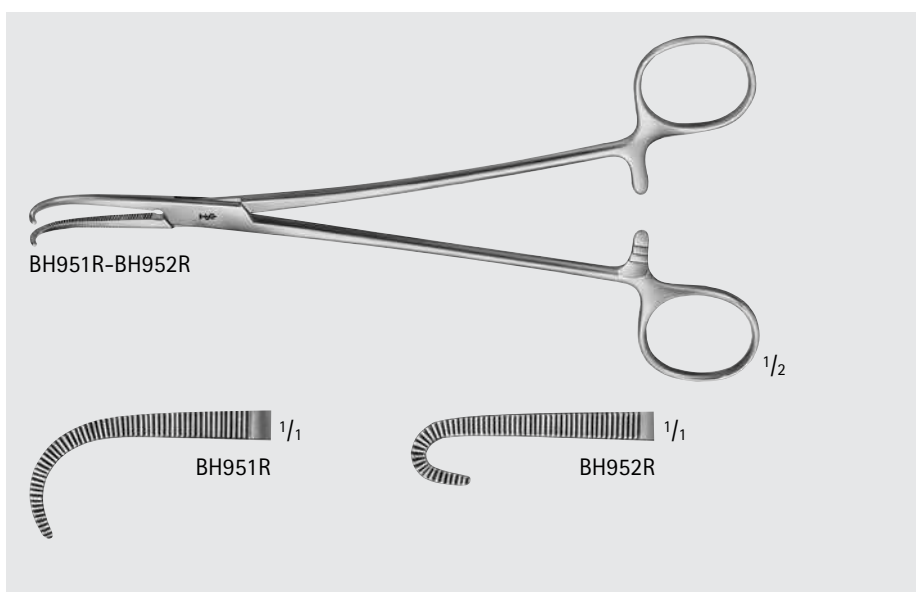

NEGUS Tonsil Forceps

Catalog Number	Jaw	Length (in.)
BH951R	HEAVY-CVD	7 1/2
BH952R	U-CVD	7 1/2

CARMALT Artery Forceps, Longitudinal Serrations

Catalog Number	Jaw	Length (in.)
MB182R	SLIGHT-CVD	12

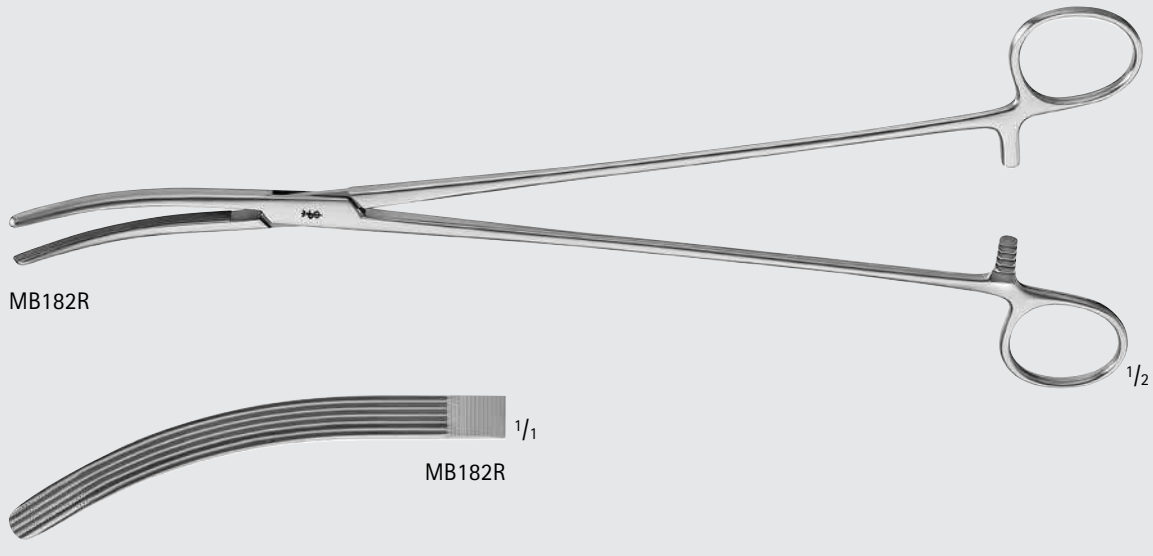

SCHNIDT Tonsil Clamp

Catalog Number	Ring Handle	Jaw	Length (in.)
MA172R	OPEN RING	STR	7 1/2
BH961R	OPEN-RING	SLIGHT-CVD	7 1/4
BH963R	OPEN-RING	CVD	7 1/4
BH957R	CLOSED-RING	SLIGHT-CVD	7 1/4
BH959R	CLOSED-RING	CVD	7 1/4

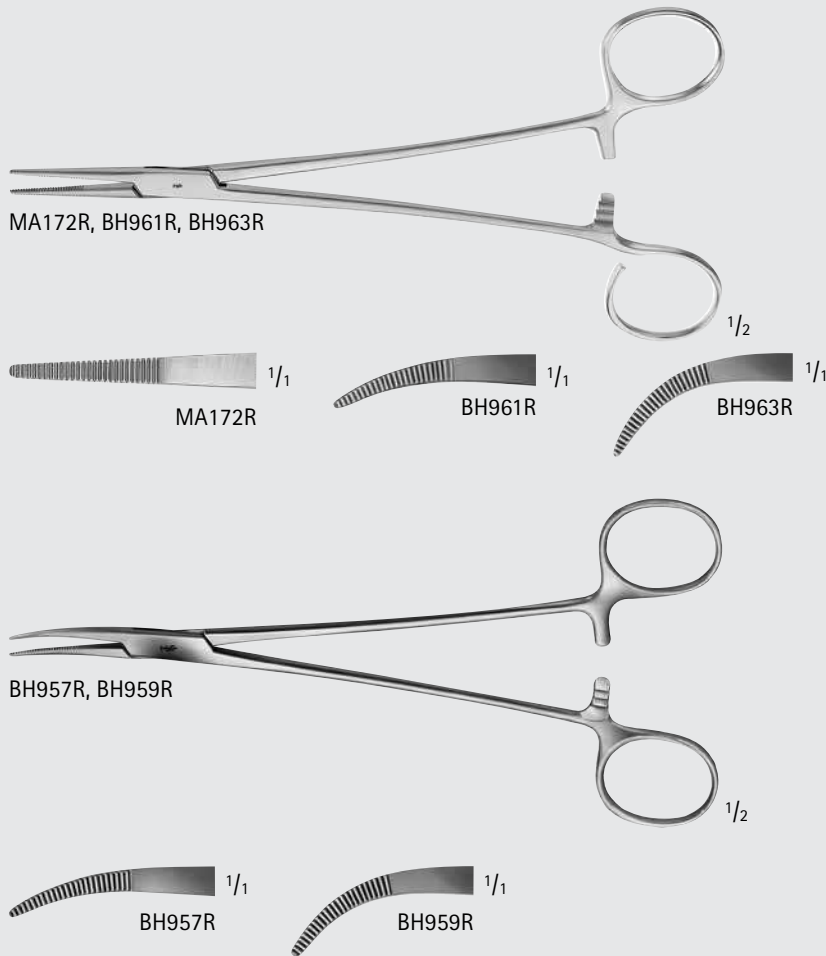

General Surgery

Hemostatic Forceps and Clamps

GENERAL SURGERY

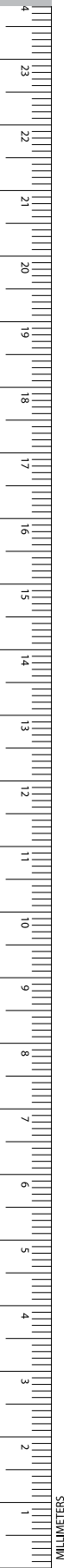
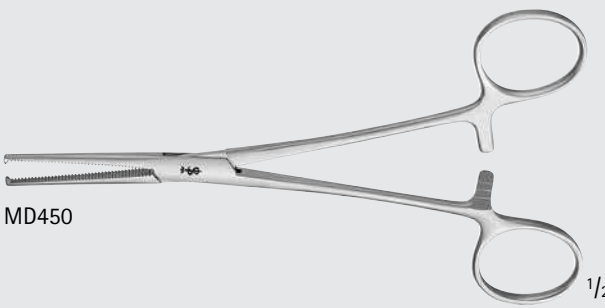



MD450 $\frac{1}{2}$

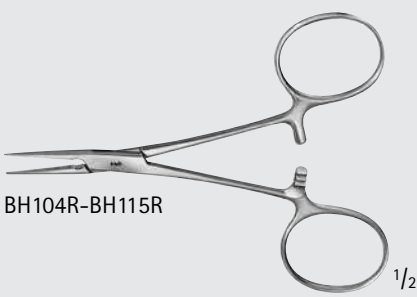

MD450 $\frac{1}{1}$

Catalog Number	Jaw	Teeth	Length (in.)
MD450	STR	1 x 2	6 1/4



BH104R-BH115R $\frac{1}{2}$



BH104R $\frac{1}{1}$



BH105R $\frac{1}{1}$



BH114R $\frac{1}{1}$



BH115R $\frac{1}{1}$

Catalog Number	Jaw	Teeth	Length (in.)
BH104R	STR	-	4
BH114R	STR	1 x 2	4
BH105R	CVD	-	4
BH115R	CVD	1 x 2	4



BH108R-BH119R $\frac{1}{2}$



BH108R $\frac{1}{1}$



BH109R $\frac{1}{1}$



BH118R $\frac{1}{1}$



BH119R $\frac{1}{1}$

Catalog Number	Jaw	Teeth	Length (in.)
BH108R	STR	-	5
BH118R	STR	1 x 2	5
BH109R	CVD	-	5
BH119R	CVD	1 x 2	5

HALSTED Mosquito Forceps, Delicate

Catalog Number	Jaw	Teeth	Length (in.)
BH110R	STR	-	5
BH120R	STR	1 x 2	5
BH210R	STR	-	7 7/8
BH214R	STR	1 x 2	7 7/8
BH111R	CVD	-	5
BH121R	CVD	1 x 2	5
BH211R	CVD	-	7 7/8
BH215R	CVD	1 x 2	7 7/8

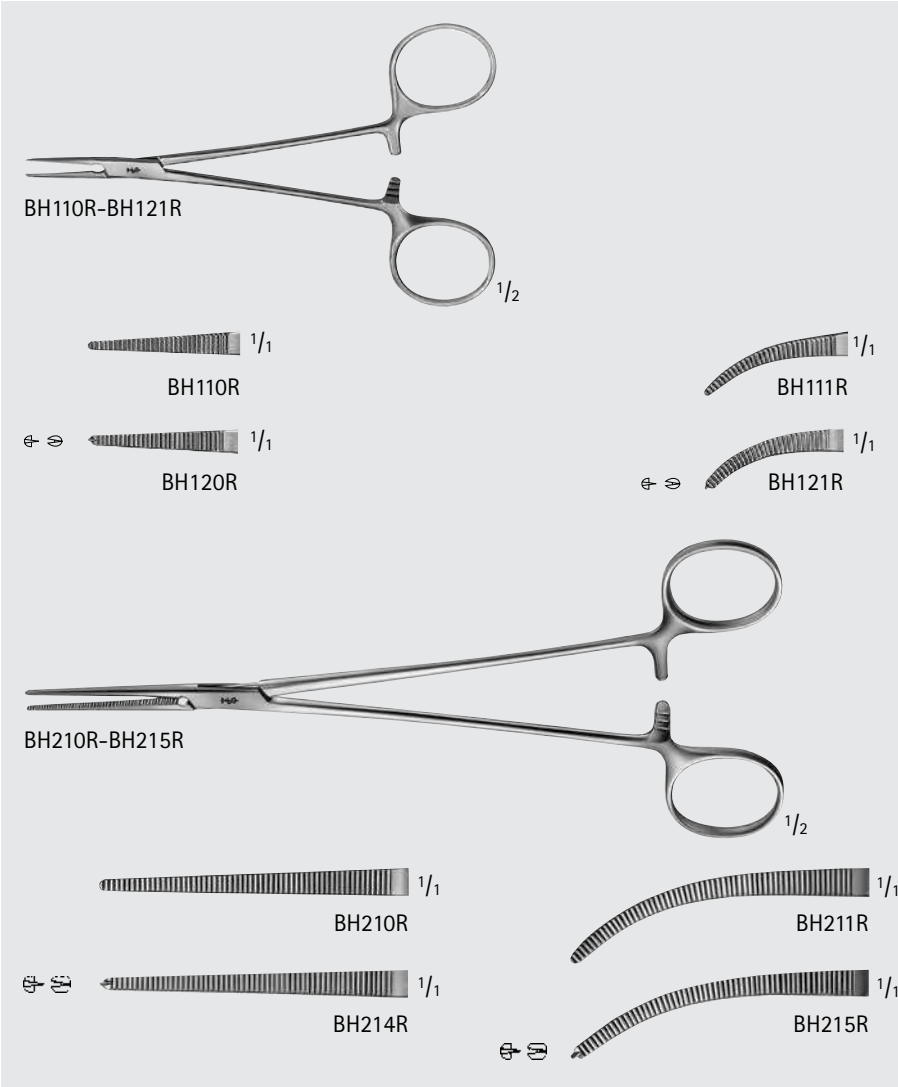

JACOBSON Mosquito Forceps

Catalog Number	Jaw	Length (in.)
BH106R	STR	5 1/8
MB229R	CVD	5

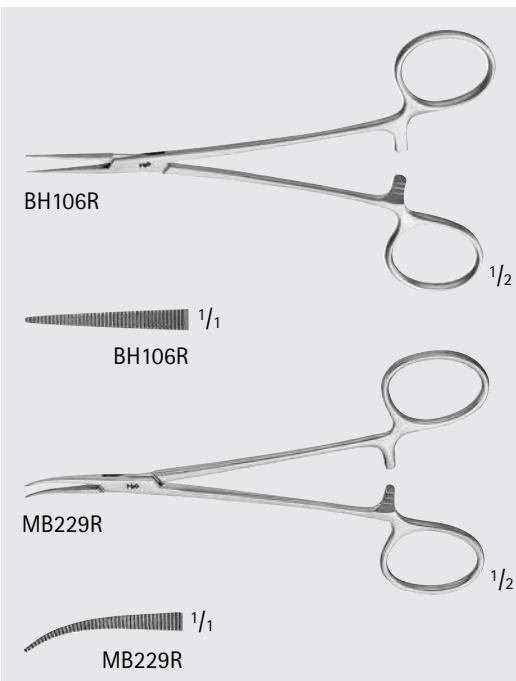

General Surgery

Hemostatic Forceps and Clamps

GENERAL SURGERY

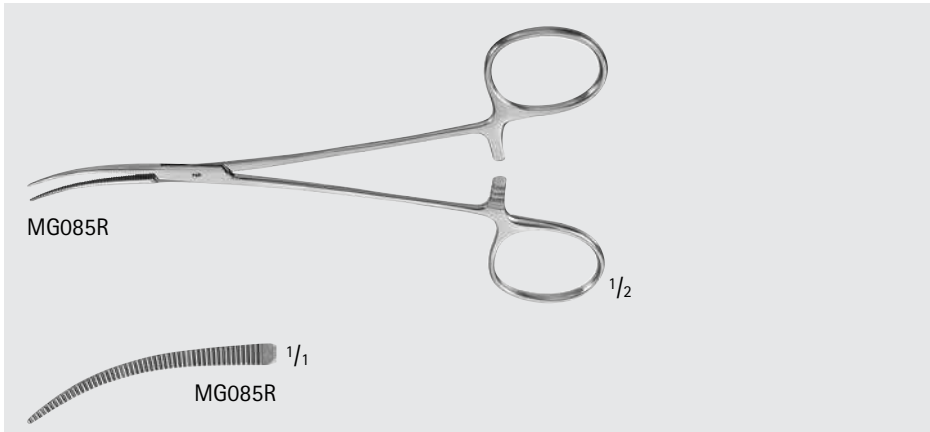
MG085R $\frac{1}{2}$

MG085R $\frac{1}{1}$

Mosquito Forceps		
Catalog Number	Jaw	Length (in.)
MG085R	DEL, CVD.	6

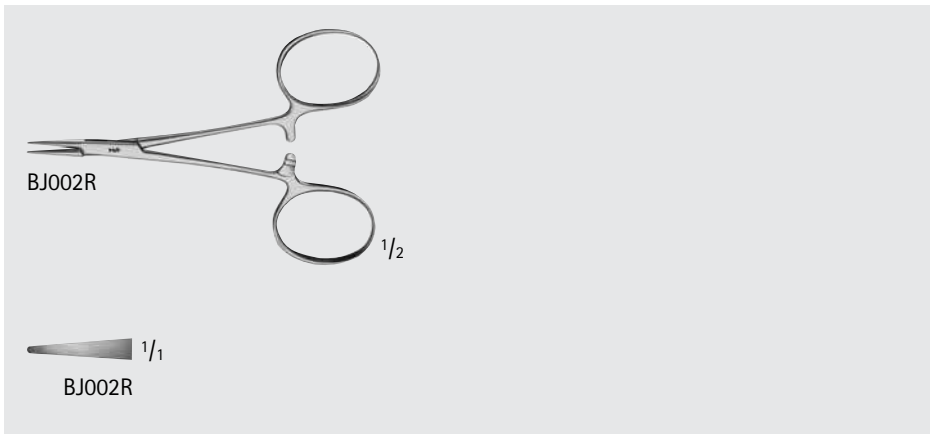

BJ002R $\frac{1}{2}$

BJ002R $\frac{1}{1}$

Suture Forceps			
Catalog Number	Tip	Jaw	Length (in.)
BJ002R	SMOOTH	STR	3 $\frac{3}{4}$

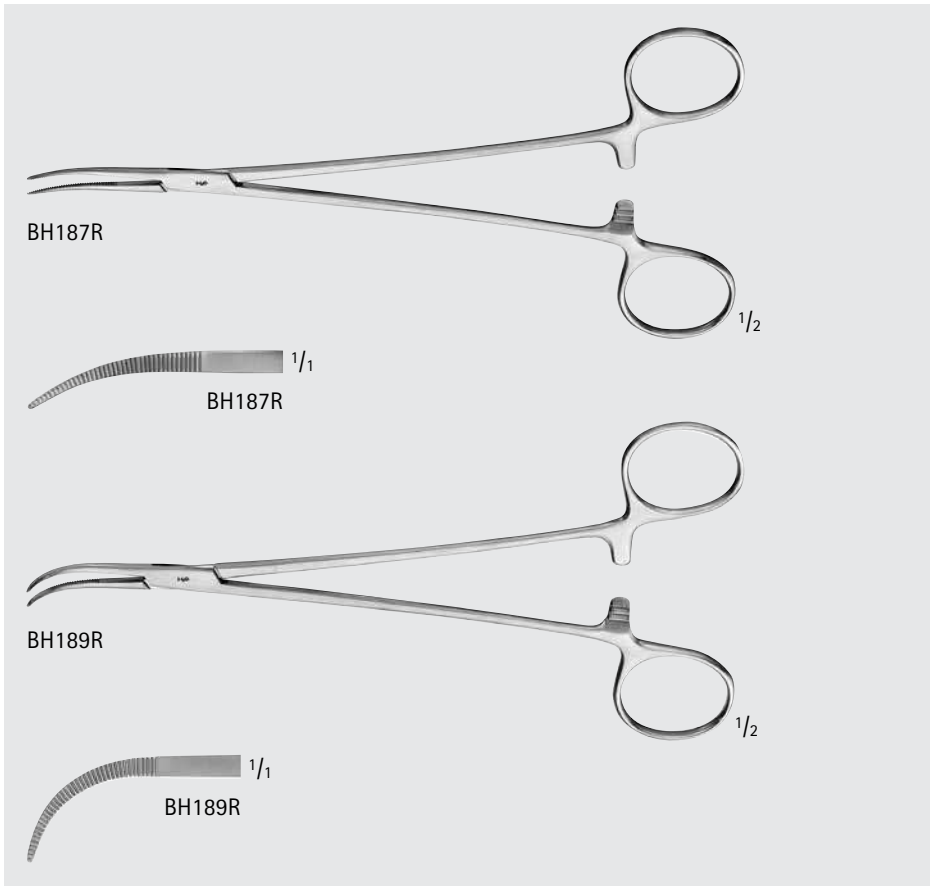

BH187R $\frac{1}{2}$

BH187R $\frac{1}{1}$

BH189R $\frac{1}{2}$

BH189R $\frac{1}{1}$

JACOBSON Hemostatic Forceps		
Catalog Number	Jaw	Length (in.)
BH187R	SLIGHT-CVD	7 $\frac{1}{2}$
BH189R	HEAVY-CVD	7 $\frac{1}{2}$



ADSON Hemostatic Forceps

Catalog Number	Jaw	Length (in.)
BH205R	CVD	8 1/2

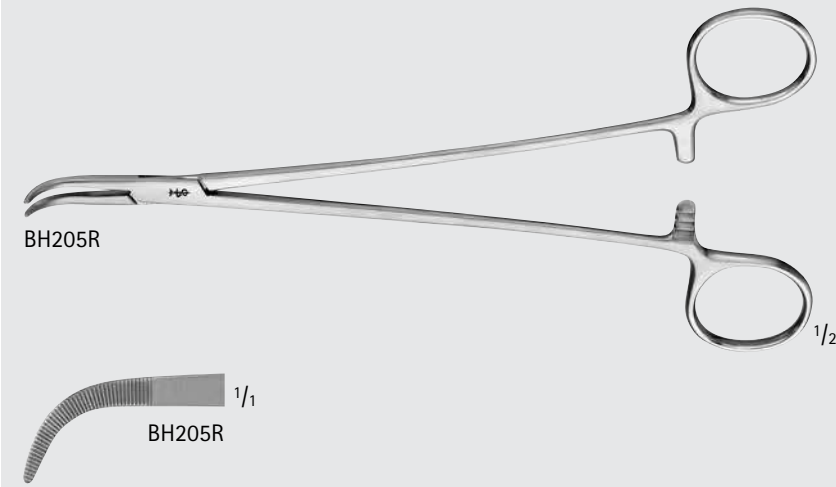

HALSTED Forceps Delicate

Catalog Number	Jaw	Teeth	Length (in.)
BH202R	STR	-	7 1/4
BH212R	STR	1 x 2	7 1/4
BH203R	CVD	-	7 1/4
BH213R	CVD	1 x 2	7 1/4

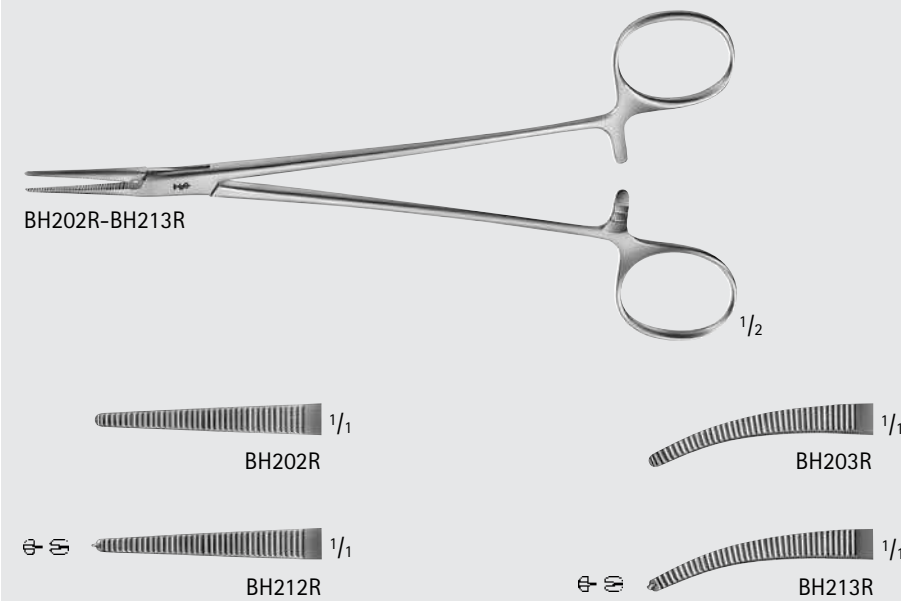

PROVIDENCE Hospital Forceps, Delicate

Catalog Number	Jaw	Length (in.)
BH130R	STR	5 1/2
BH131R	CVD	5 1/2

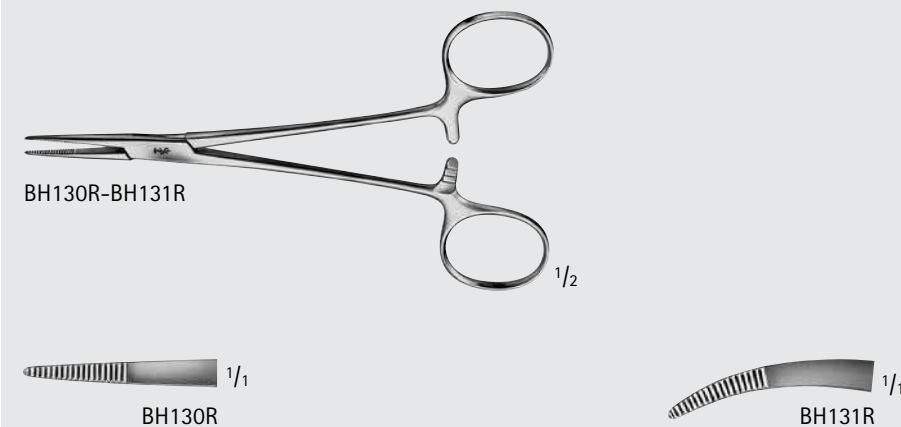

General Surgery

Hemostatic Forceps and Clamps

GENERAL SURGERY



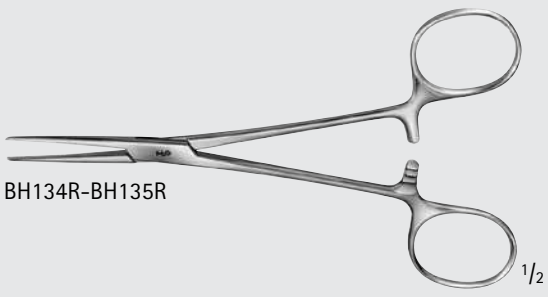

BH134R-BH135R 1/2



BH134R 1/1



BH135R 1/1

KELLY Forceps

Catalog Number	Jaw	Length (in.)
BH134R	STR	5 1/2
BH135R	CVD	5 1/2

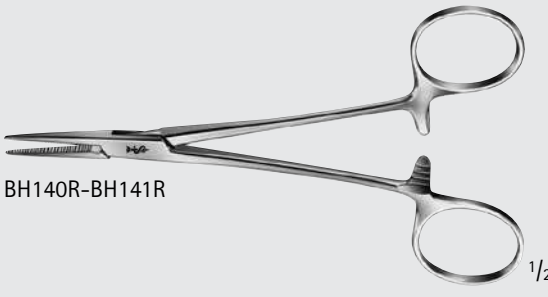

BH140R-BH141R 1/2



BH140R 1/1

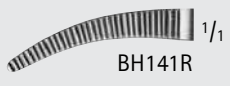

BH141R 1/1

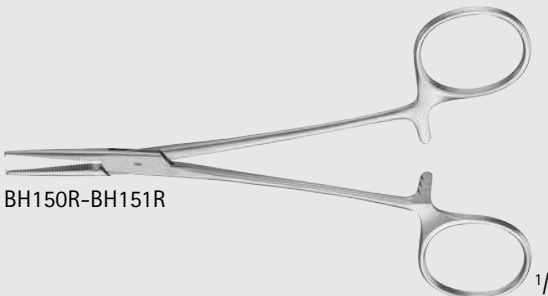

BH150R-BH151R 1/2



BH150R 1/1



BH151R 1/1

Baby CRILE Forceps

Catalog Number	Jaw	Teeth	Length (in.)
BH140R	STR	-	5 1/2
BH150R	STR	1 x 2	5 1/2
BH141R	CVD	-	5 1/2
BH151R	CVD	1 x 2	5 1/2

CRILE Forceps

Catalog Number	Jaw	Teeth	Length (in.)
BH144R	STR	-	5 1/2
BH154R	STR	1 x 2	5 1/2
BH166R	STR	-	6 1/4
BH176R	STR	1 x 2	6 1/4
BH145R	CVD	-	5 1/2
BH155R	CVD	1 x 2	5 1/2
BH167R	CVD	-	6 1/4
BH177R	CVD	1 x 2	6 1/4

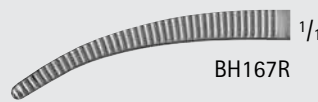
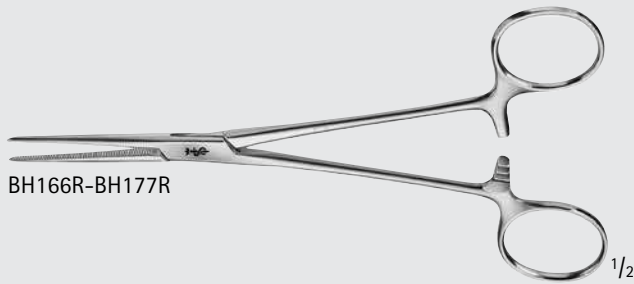
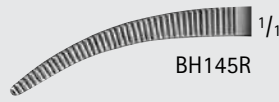
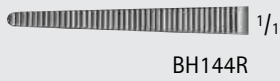

INCHES

General Surgery

Hemostatic Forceps and Clamps

GENERAL SURGERY

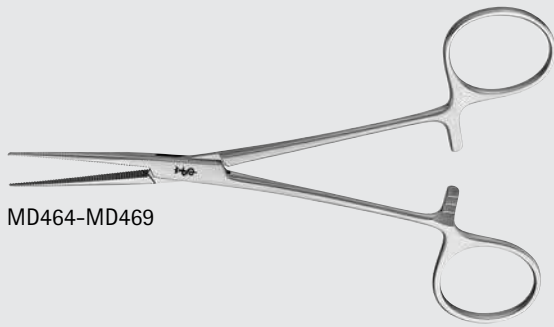
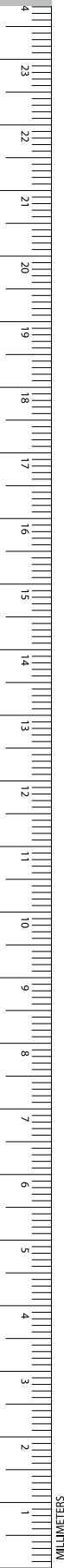

MD464-MD469

COLLER Artery Forceps

Catalog Number	Jaw	Length (in.)
MD464	STR	5 3/4
MD466R	STR	6 1/2
MD468	STR	7
MD465R	CVD	5 3/4
MD467R	CVD	6 1/2
MD469	CVD	7



MD464



MD466R



MD468



MD465R



MD467R



MD469

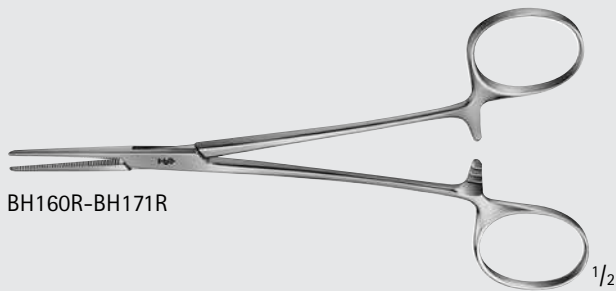

BH160R-BH171R

LERICHE Forceps, Delicate

Catalog Number	Jaw	Teeth	Length (in.)
BH160R	STR	-	6
BH170R	STR	1 x 2	6
BH161R	CVD	-	6
BH171R	CVD	1 x 2	6



BH160R



BH170R

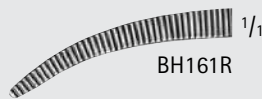

BH161R

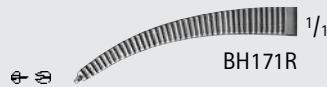

BH171R



RANKIN Forceps, Delicate

Catalog Number	Jaw	Length (in.)
BH164R	STR	6 1/4
BH165R	CVD	6 1/4

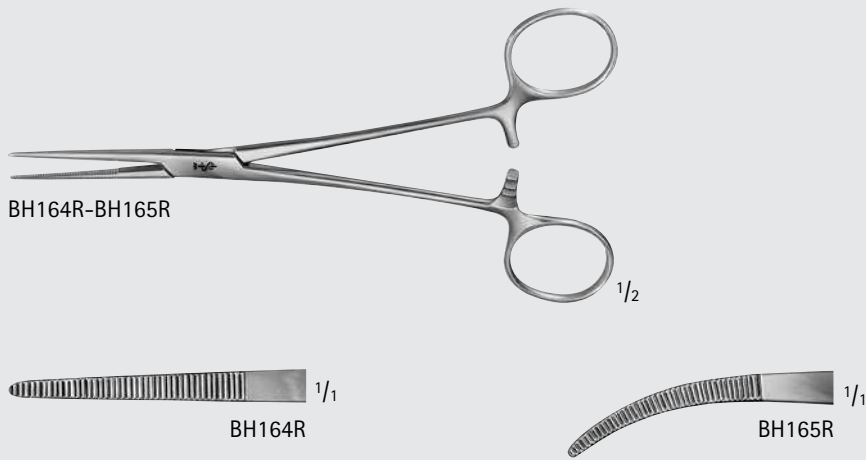

BIRKETT Hemostatic Forceps

Catalog Number	Jaw	Length (in.)
BH197R	CVD	7 1/4

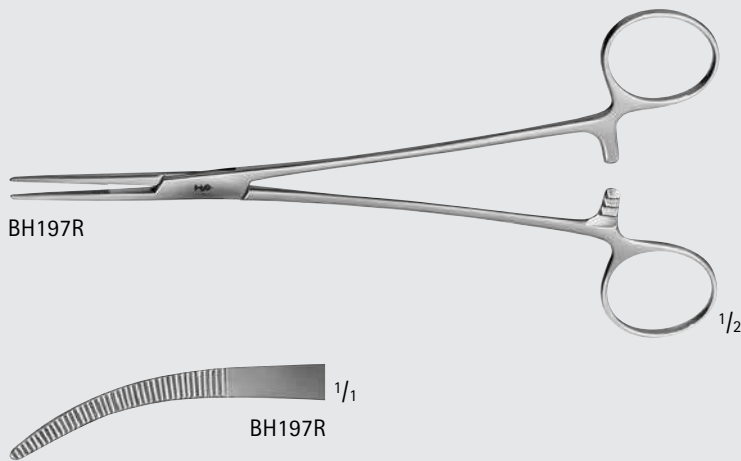

NISSEN Tonsil Forceps, Delicate

Catalog Number	Jaw	Length (in.)
BH199R	CVD	7 1/4

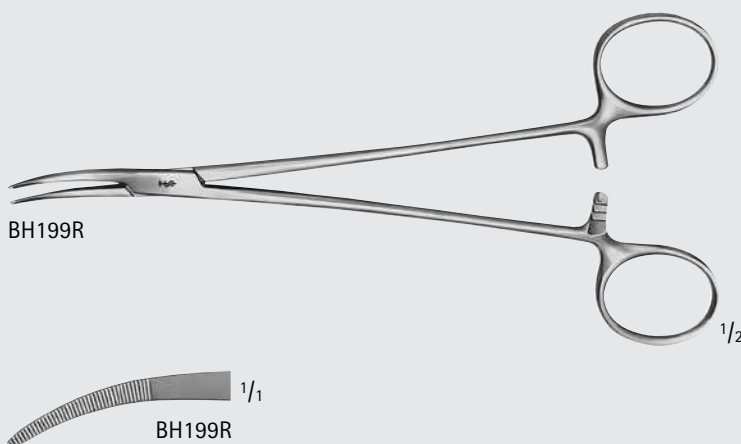

General Surgery

Hemostatic Forceps and Clamps

GENERAL SURGERY

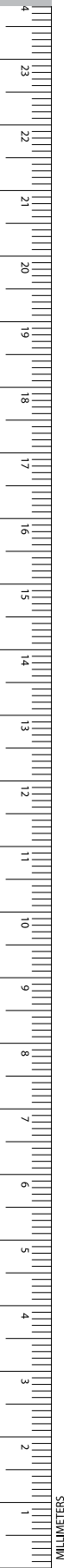
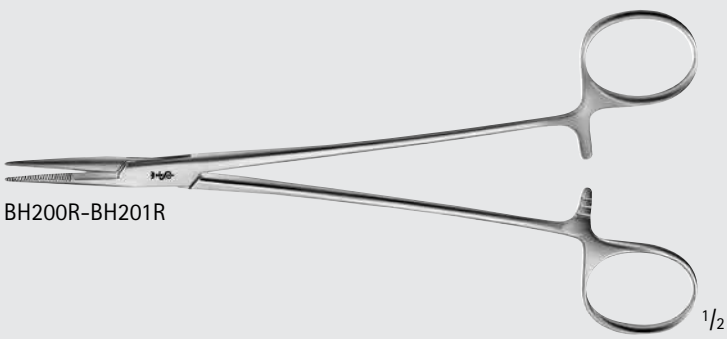
BH200R-BH201R 1/2



BH200R 1/1



BH201R 1/1

Catalog Number	Jaw	Length (in.)
BH200R	STR	7 1/4
BH201R	CVD	7 1/4

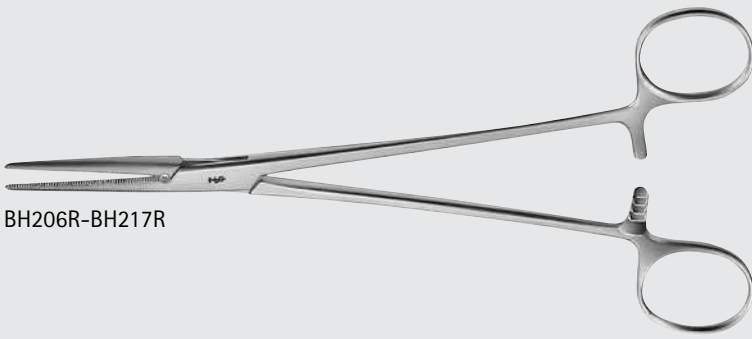

BH206R-BH217R



BH206R 1/1



BH216R 1/1



BH207R 1/1



BH217R 1/1



BH209R 1/1

Catalog Number	Jaw	Teeth	Length (in.)
BH206R	STR	-	7 7/8
BH216R	STR	1 x 2	7 7/8
BH207R	CVD	-	7 7/8
BH217R	CVD	1 x 2	7 7/8
BH209R	HVY-CVD	-	7 3/4

BENGOLEA Forceps, Delicate

Catalog Number	Jaw	Length (in.)
BH228R	STR	9 5/8
BH229R	CVD	9 5/8

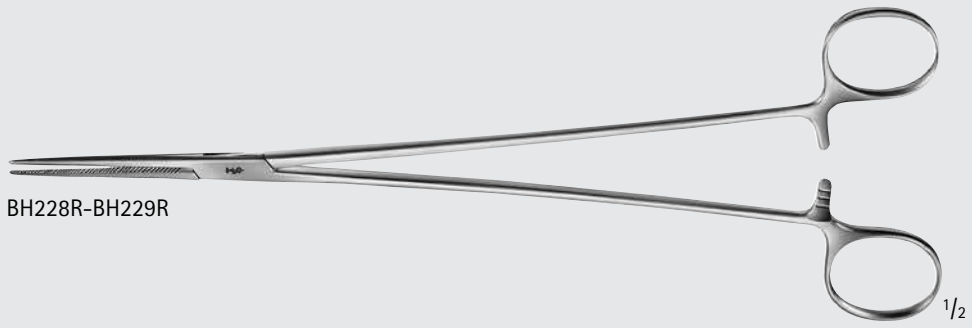

BH228R-BH229R



BH228R



BH229R

BRIDGE Forceps, Delicate

Catalog Number	Jaw	Length (in.)
BH230R	STR	10 3/4
BH231R	CVD	10 3/4

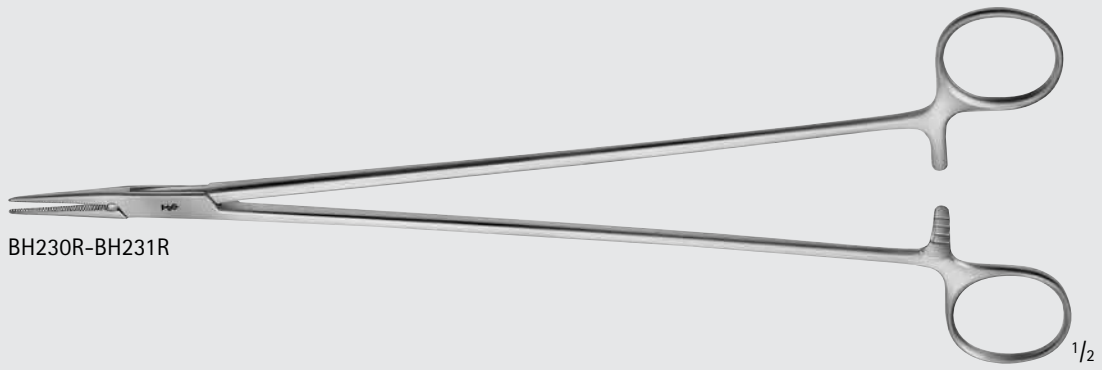

BH230R-BH231R



BH230R

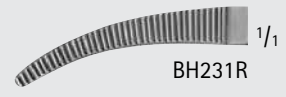

BH231R



INCHES

General Surgery

Dissecting and Right Angle Forceps

GENERAL SURGERY



GEMINI Right Angle Forceps

Catalog Number	Length (in.)
BJ100R	5 1/2
BJ102R	7
BJ103R	7 7/8
BJ104R	9
BJ106R	11

HOLLE Forceps, Delicate

Catalog Number	Length (in.)
BJ037R	5 3/4
BJ038R	7 1/4
BJ039R	9 1/4

KANTROWITZ Right Angle Forceps

Catalog Number	Length (in.)
MB058R	6 3/8
BJ057R	7 7/8
BJ058R	9 5/8
BJ059R	10 3/4
MB061R	12

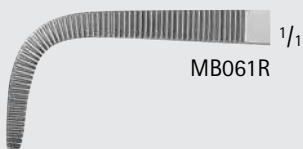
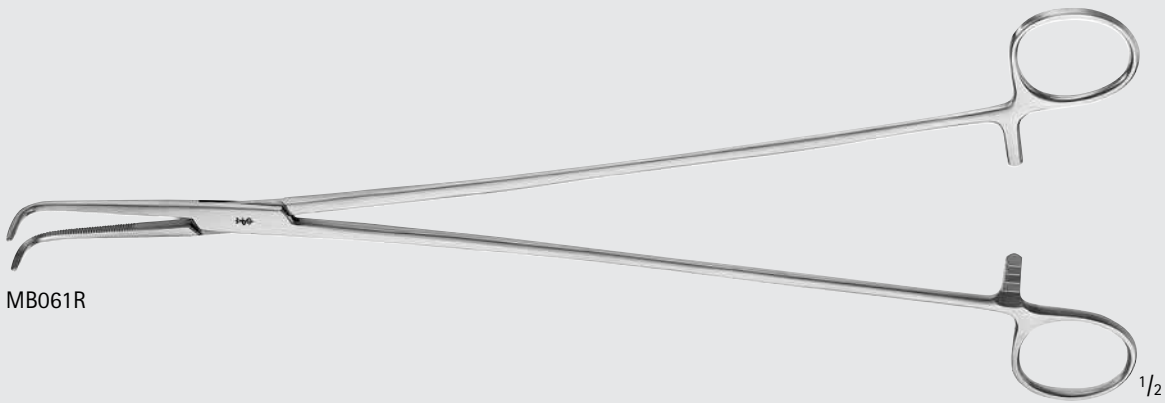
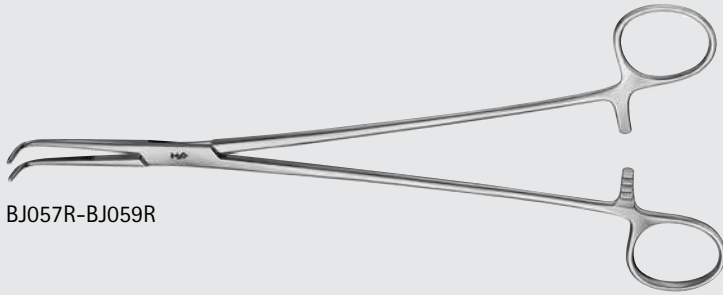
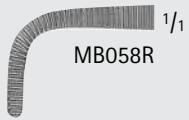
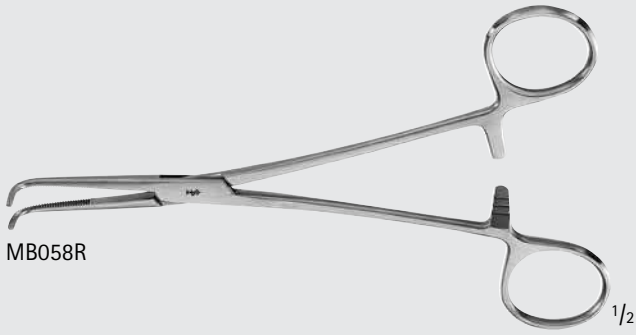

General Surgery

Dissecting and Right Angle Forceps

GENERAL SURGERY



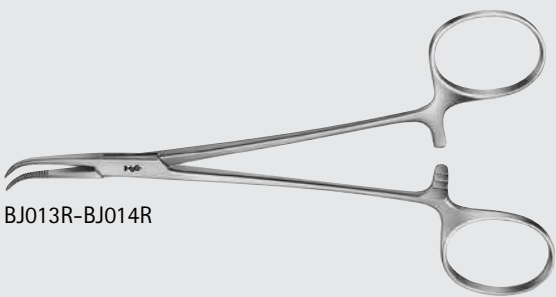

BJ013R-BJ014R



BJ013R ^{1/1}



BJ014R ^{1/1}

Baby ADSON Forceps

Catalog Number	Length (in.)
BJ013R	5 1/2
BJ014R	7

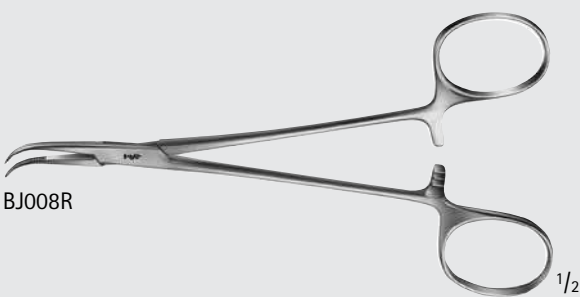

BJ008R ^{1/2}



BJ008R ^{1/1}

Micro ADSON Suture Forceps

Catalog Number	Length (in.)
BJ008R	5 1/2

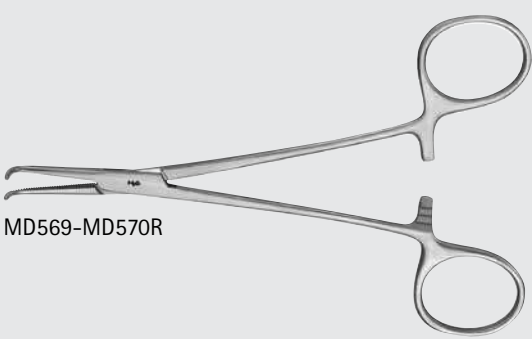

MD569-MD570R



MD569 ^{1/1}



MD570R ^{1/1}

MIXTER (MEEKER) Right Angle Forceps

Catalog Number	Length (in.)
MD569	5 1/2
MD570R	7

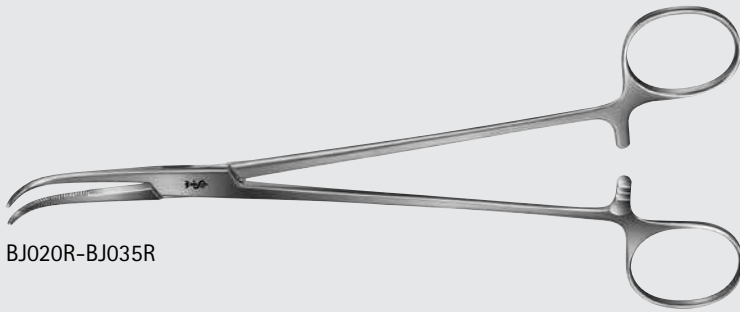

BJ020R-BJ035R

OVERHOLT-GEISSENDOERFER Forceps

Catalog Number	Jaw Curve (#)	Length (in.)
BJ020R	0	7 3/4
BJ021R	1	8
BJ022R	2	8 3/4
BJ023R	3	8 7/8
BJ024R	4	8 3/4
BJ025R	5	9
BJ026R	6	8 7/8
BJ031R	1	10 1/4
BJ032R	2	10 5/8
BJ033R	3	10 3/4
BJ034R	4	10 5/8
BJ035R	5	11



BJ020R

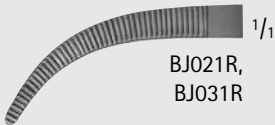

BJ021R,
BJ031R

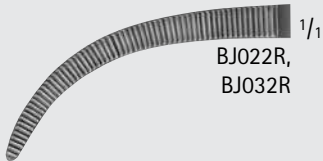

BJ022R,
BJ032R



BJ023R,
BJ033R

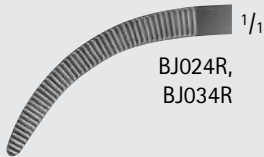

BJ024R,
BJ034R

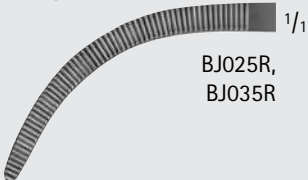

BJ025R,
BJ035R



BJ026R



INCHES

General Surgery

Dissecting and Right Angle Forceps

GENERAL SURGERY

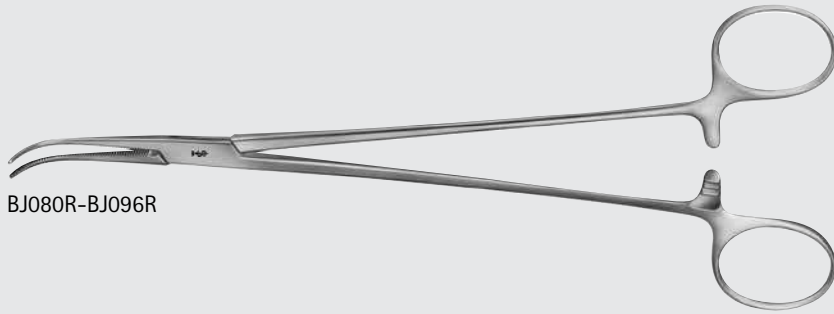
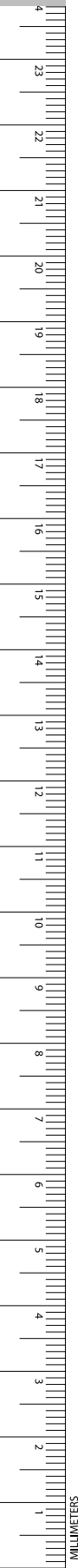

BJ080R-BJ096R



BJ080R

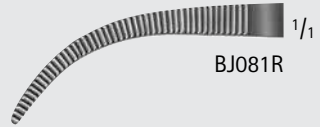

BJ081R



BJ082R

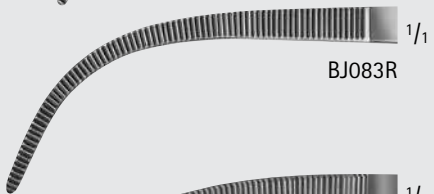

BJ083R



BJ086R



BJ090R

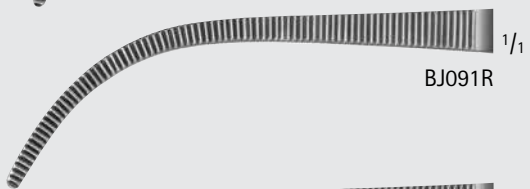

BJ091R

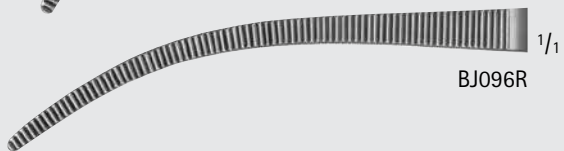

BJ096R

OVERHOLT Forceps

Catalog Number	Jaw Curve (#)	Length (in.)
BJ080R	0	8 1/2
BJ081R	1	8 1/4
BJ082R	2	8 3/4
BJ083R	3	8 7/8
BJ086R	6	8 7/8
BJ090R	0	11 5/8
BJ091R	1	11 5/8
BJ096R	6	11 3/4

MEEKER Forceps

Catalog Number	Length (in.)
MB459R	11

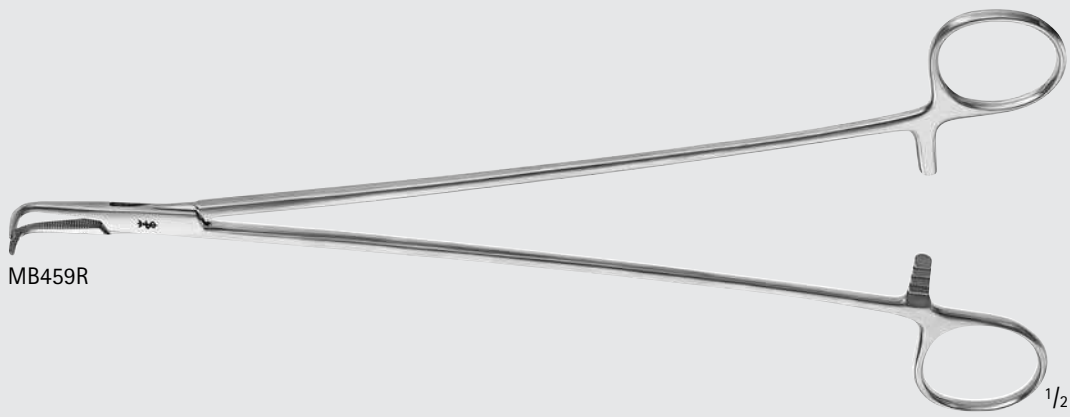

MB459R

¹/₂

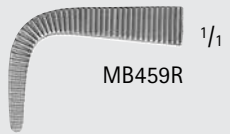

¹/₁
MB459R



INCHES

General Surgery

Dissecting and Right Angle Forceps

GENERAL SURGERY

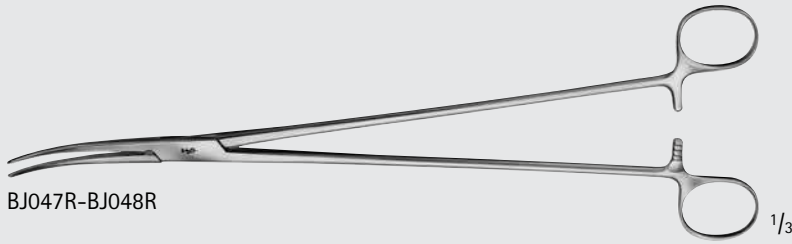

BJO47R-BJO48R

ZENKER Ligature Forceps

Catalog Number	Jaw	Length (in.)
BJO47R	SLIGHT-CVD	11 3/4
BJO48R	HEAVY-CVD	11 1/2
BJ130R	SLIGHT-CVD	13 3/4
BJ131R	CVD	13 3/4
BJ132R	HEAVY-CVD	13 3/4



BJO47R

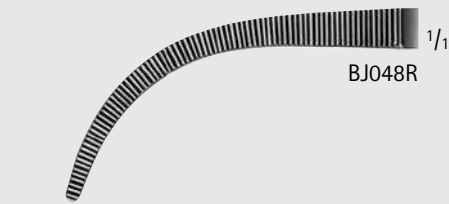

BJO48R

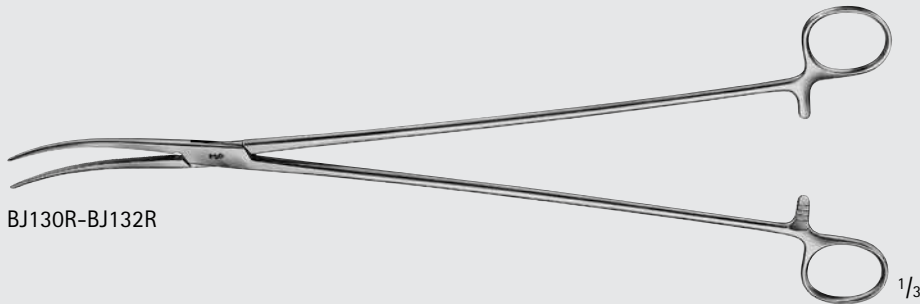

BJ130R-BJ132R

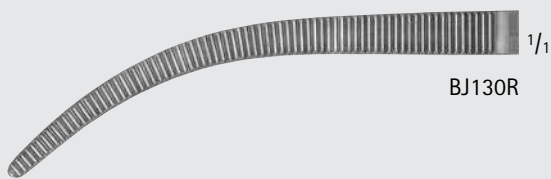

BJ130R

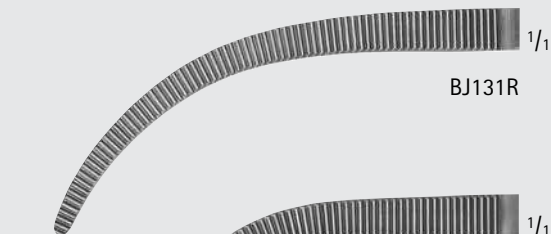

BJ131R

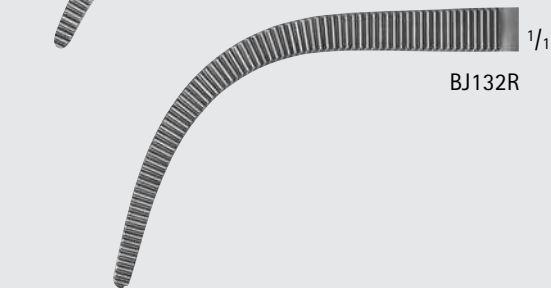

BJ132R

MIXTER-O'SHAUGNESSY Forceps

Catalog Number	Length (in.)
BJ050R	7 1/2



FINOCHIETTO Forceps

Catalog Number	Length (in.)
BJ052R	9 5/8

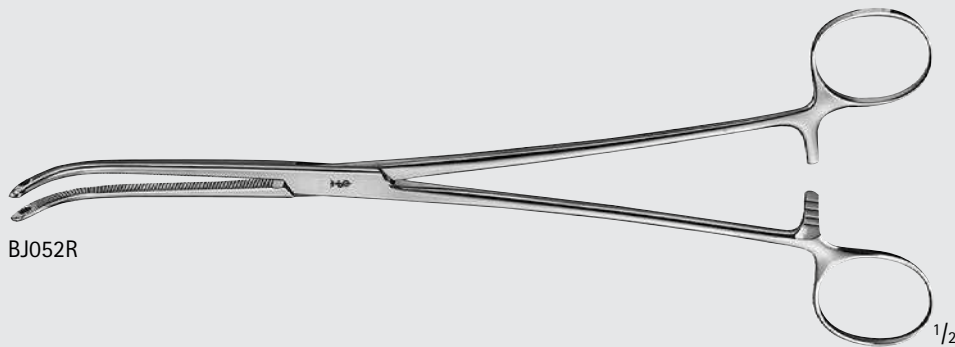

General Surgery

Dissecting and Right Angle Forceps

GENERAL SURGERY

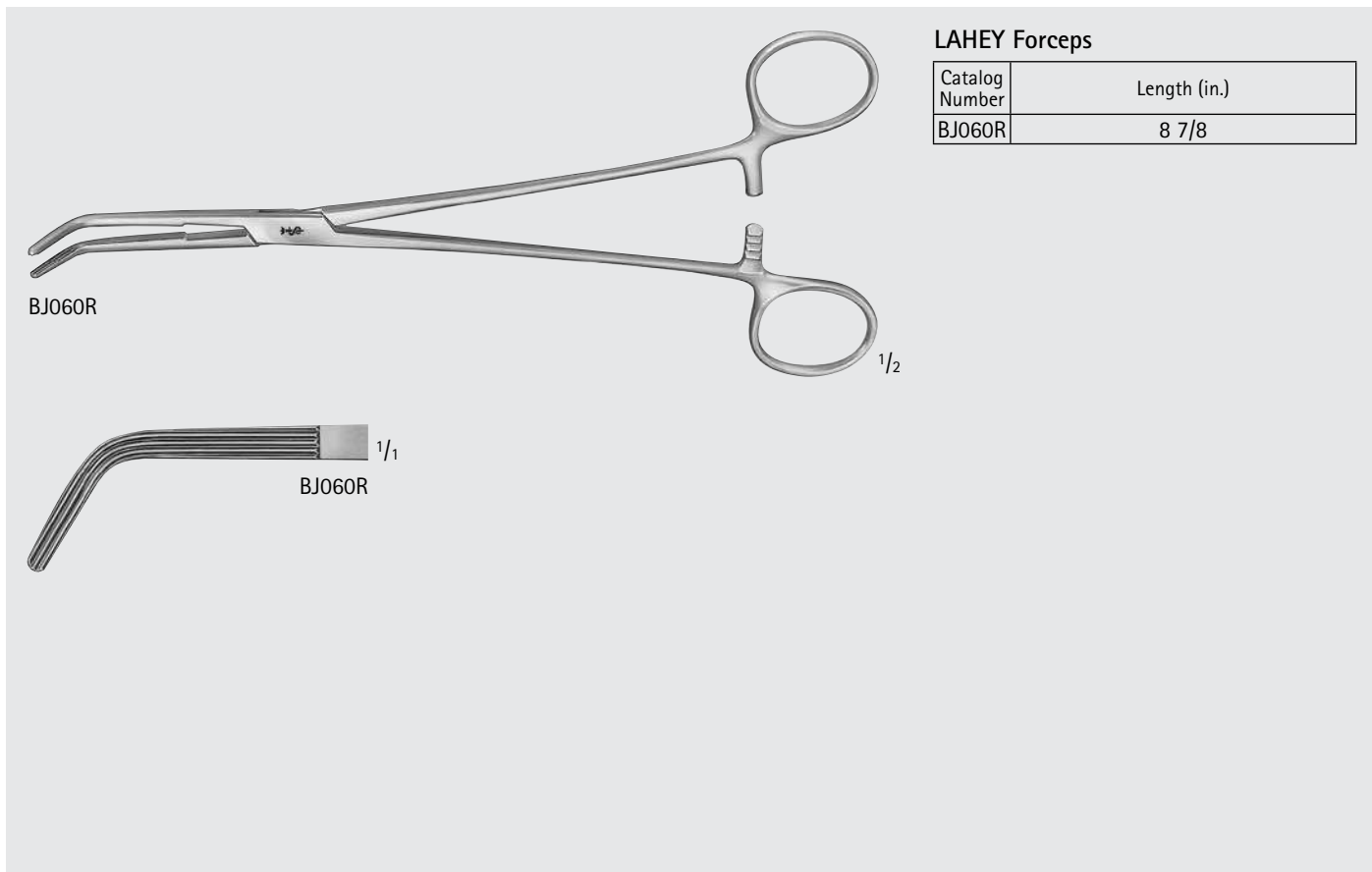

LAHEY Forceps

Catalog Number	Length (in.)
BJ060R	8 7/8

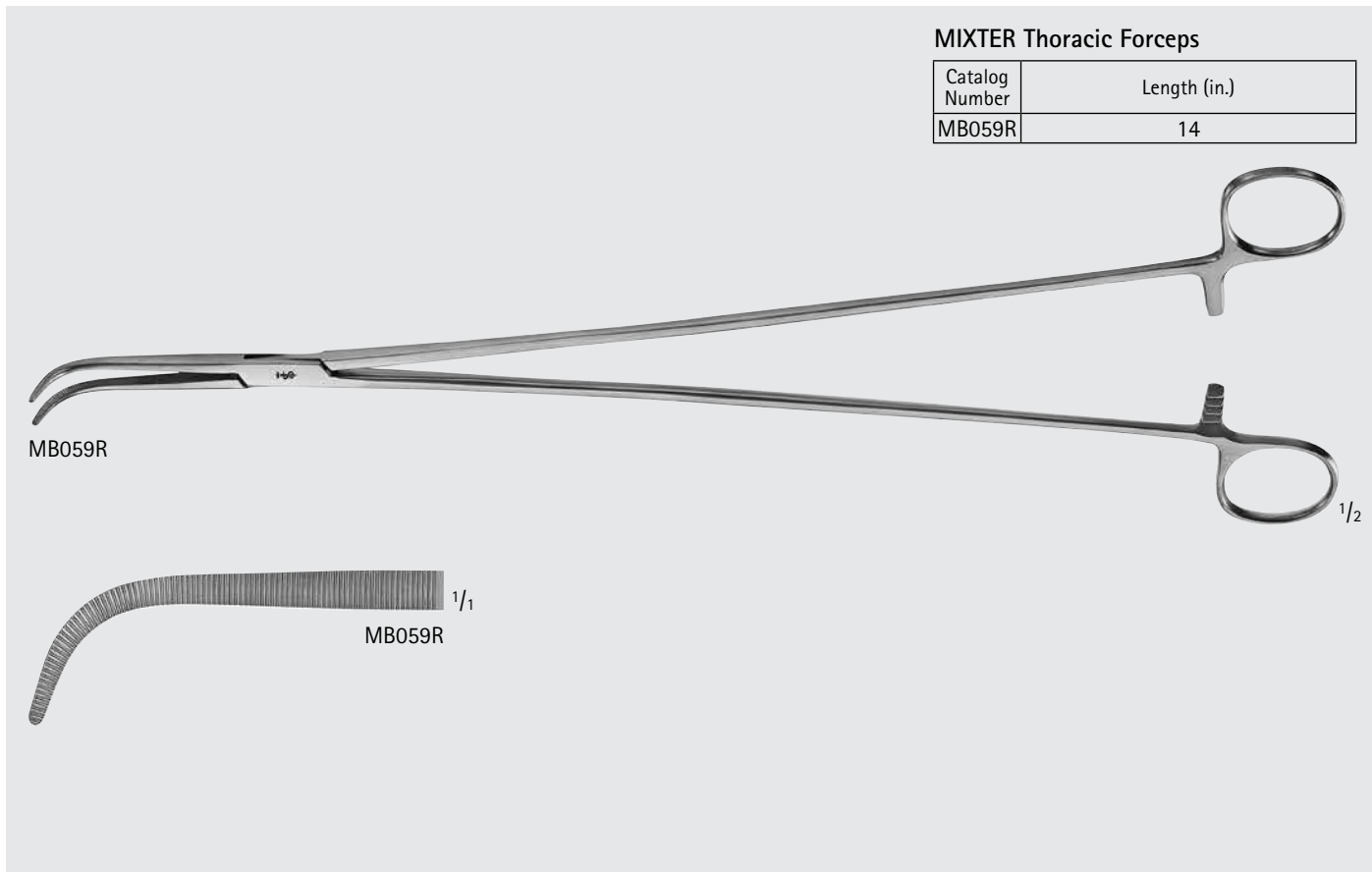

MIXTER Thoracic Forceps

Catalog Number	Length (in.)
MB059R	14

MIXTER Forceps, Longitudinal Serrations

Catalog Number	Length (in.)
BJ061R	8 3/4
BJ062R	9 3/4
BJ073R	11 1/2

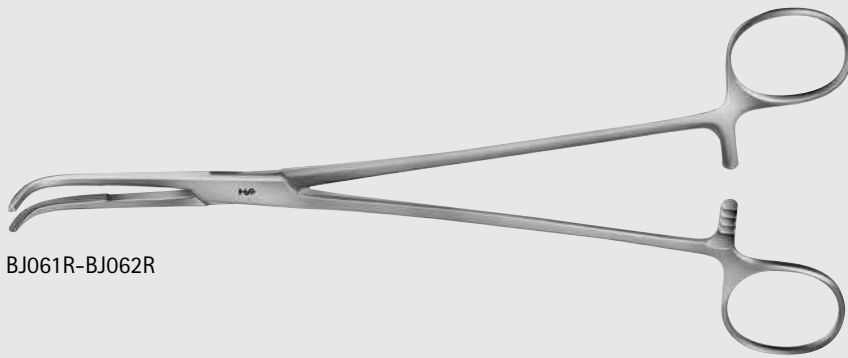

BJ061R-BJ062R



BJ061R



BJ062R

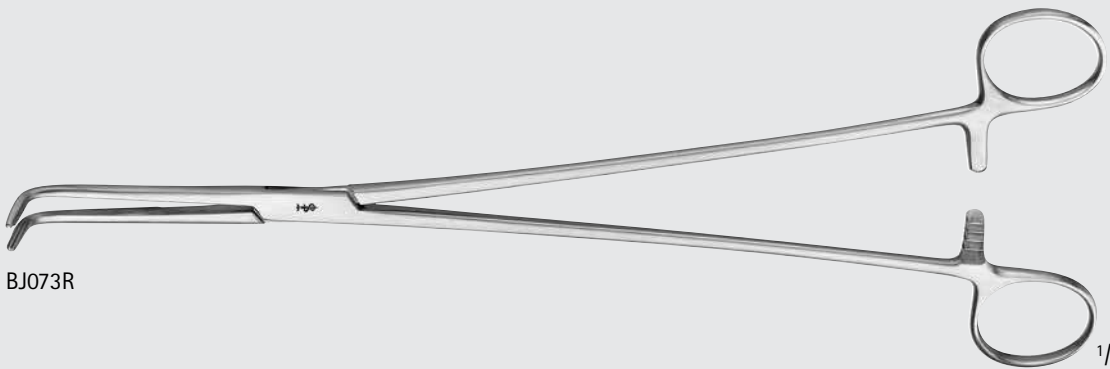

BJ073R



BJ073R



INCHES

General Surgery

Dissecting and Right Angle Forceps

GENERAL SURGERY

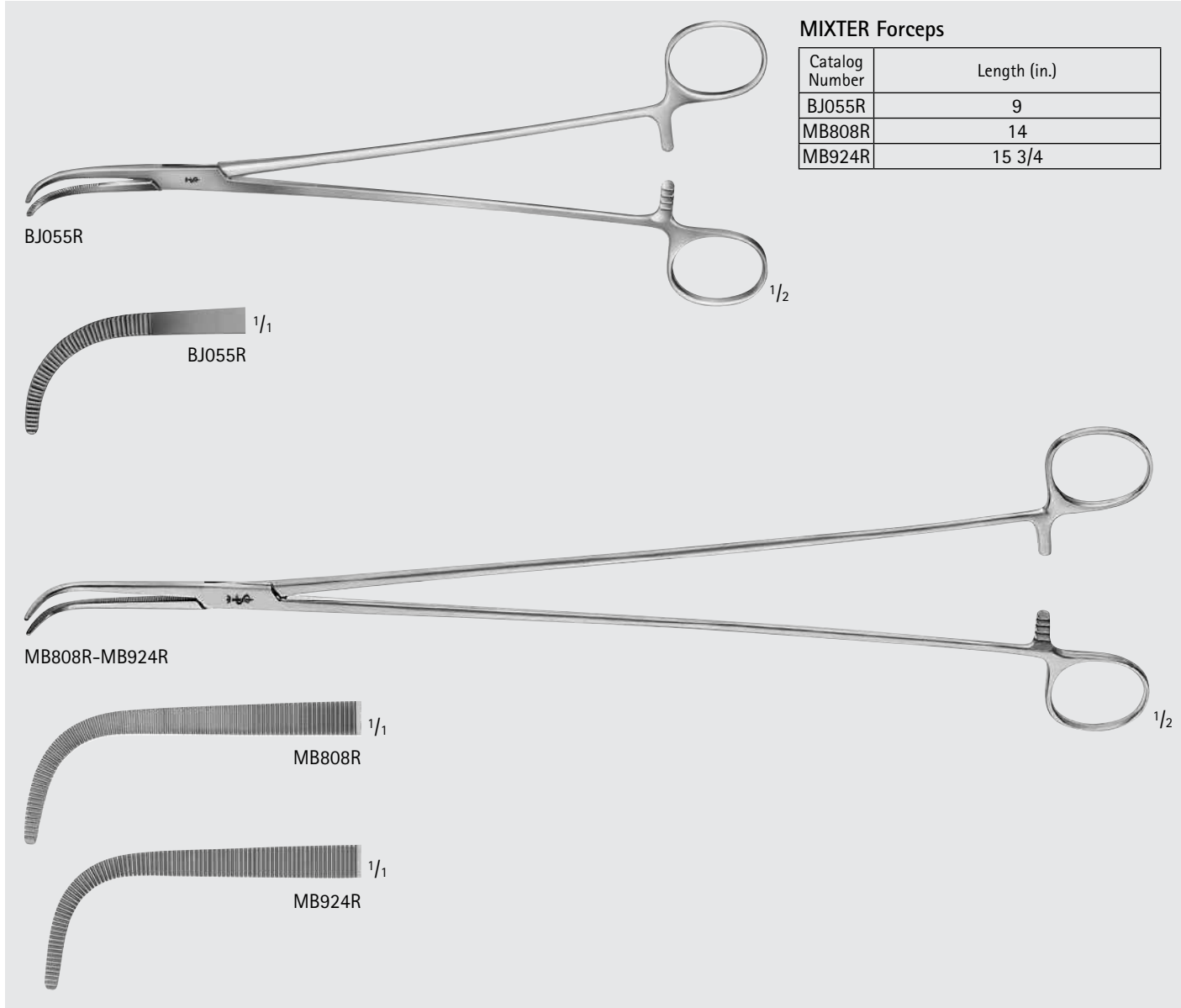
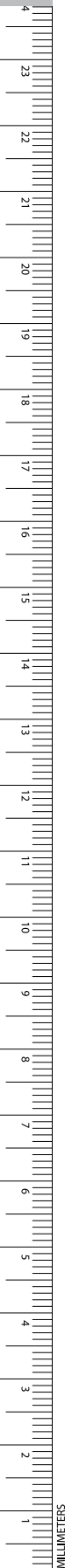

MIXTER Forceps

Catalog Number	Length (in.)
BJ055R	9
MB808R	14
MB924R	15 3/4

BJ055R

BJ055R

MB808R-MB924R

MB808R

MB924R

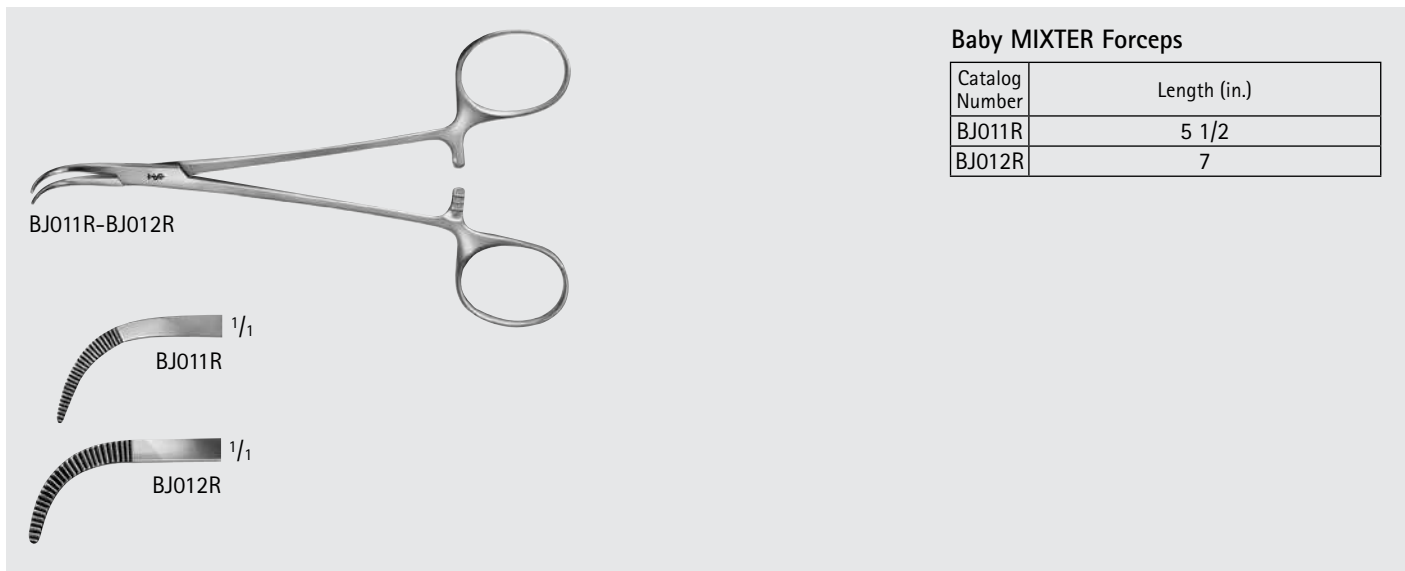

Baby MIXTER Forceps

Catalog Number	Length (in.)
BJ011R	5 1/2
BJ012R	7

BJ011R-BJ012R

BJ011R

BJ012R

**HARRINGTON-MIXTER Forceps,
Longitudinal Serrations**

Catalog Number	Length (in.)
BJ072R	12 1/2

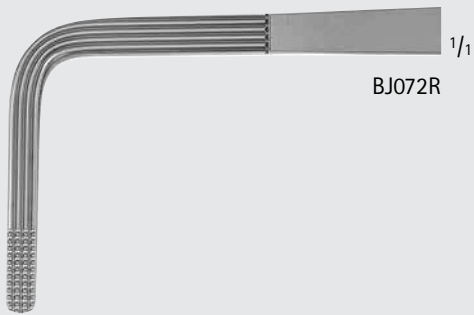
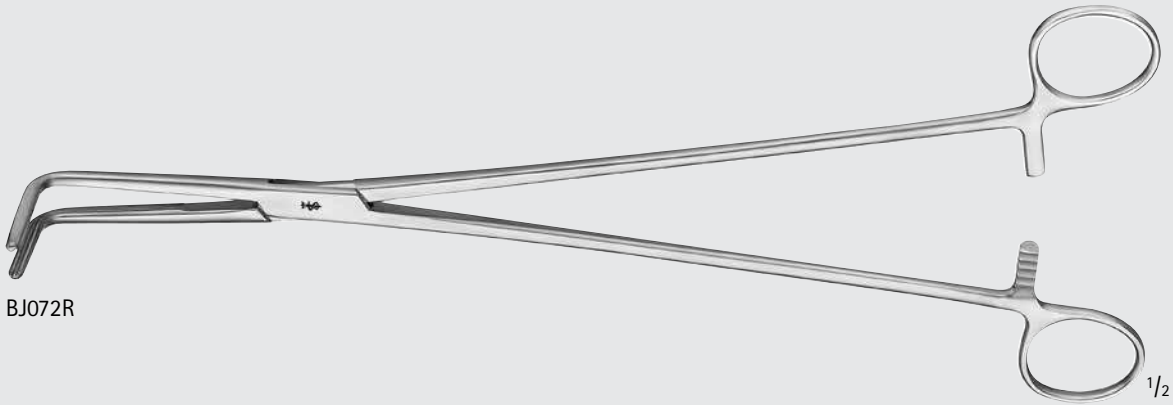

WIKSTROEM Forceps

Catalog Number	Length (in.)
BJ051R	8

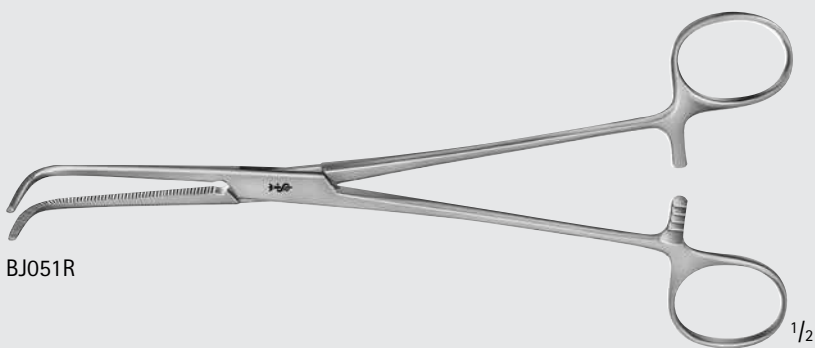

General Surgery

Dissecting and Right Angle Forceps

GENERAL SURGERY

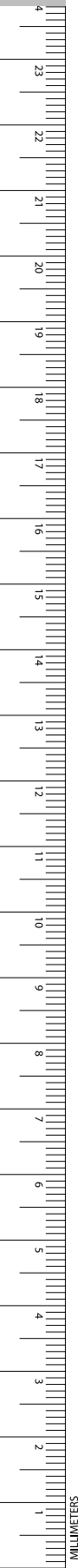

LAWRENCE Forceps

Catalog Number	Length (in.)
BJ070R	10 5/8

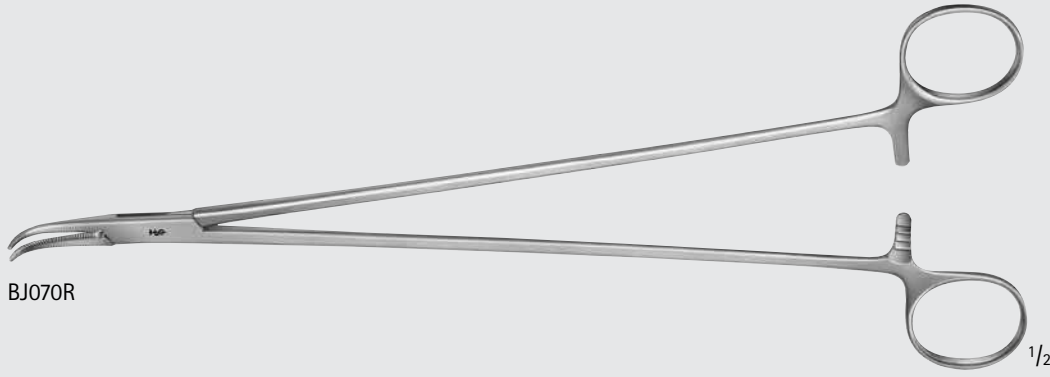

BJ070R

1/2



BJ070R

1/1

REINHOFF Swan Neck Clamp

Catalog Number	Tip	Jaw	Handle	Length (in.)
US116	SERR	CVD	CVD	10 1/4



US116

1/2



US116

1/1

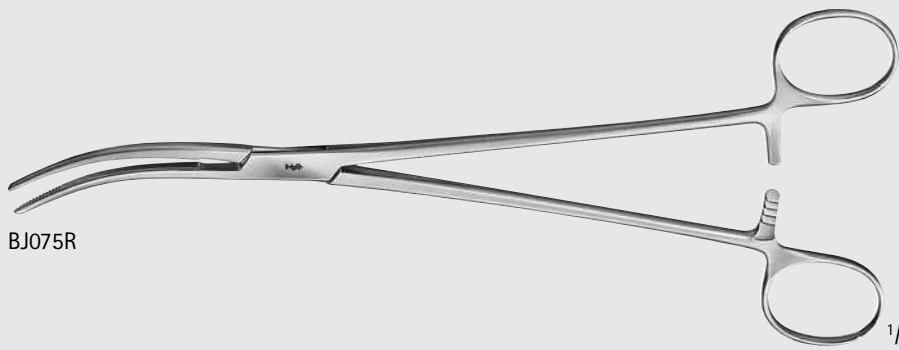

BJ075R

1/2



1/1

BJ075R

KIEBACK Forceps

Catalog Number	Jaw	Length (in.)
BJ075R	CVD, LONGITUDINAL SERR	9 1/4

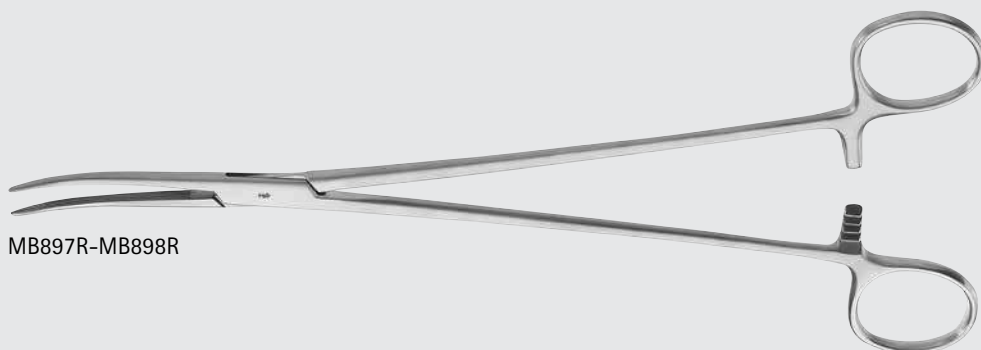

MB897R-MB898R



1/1

MB897R-MB898R

COLLIER-ANDERSON Forceps

Catalog Number	Jaw	Length (in.)
MB897R	CVD, LONGITUDINAL SERR	10
MB898R	CVD, LONGITUDINAL SERR	11

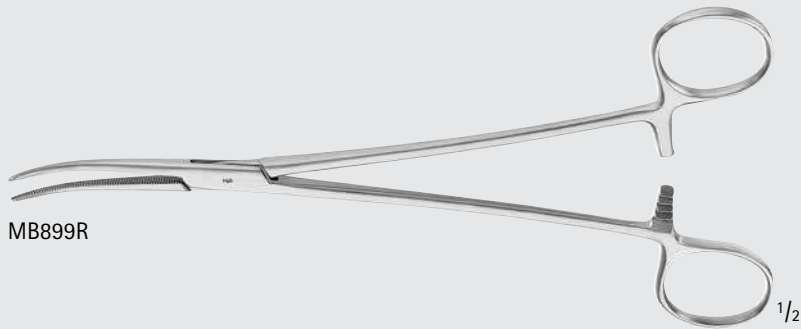

MB899R

1/2



1/1

MB899R

DEBAKEY-COLLIER Forceps

Catalog Number	Jaw	Length (in.)
MB899R	CVD, SERR	8



General Surgery

Towel and Tubing Clamps

GENERAL SURGERY



BF407R

JONES Towel Clamp

Catalog Number	Length (in.)
BF407R	3 1/4

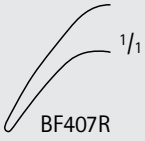

BF407R

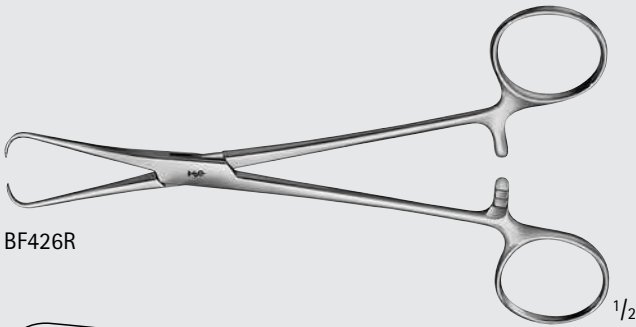

BF426R

BERNHARD Towel Clamp

Catalog Number	Length (in.)
BF426R	6 1/4

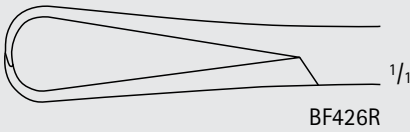

BF426R



BF431R-BF433R

BACKHAUS Towel Clamp

Catalog Number	Length (in.)
BF431R	3 1/2
BF432R	4 1/4
BF433R	5 1/4



BF431R

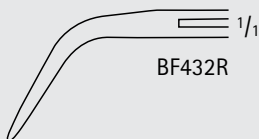

BF432R

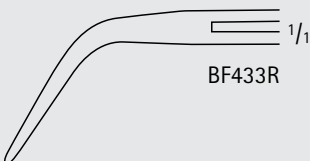

BF433R

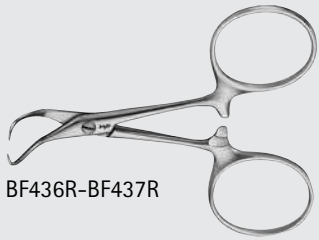

BF436R-BF437R

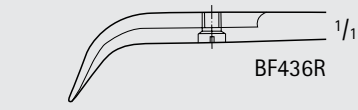

BF436R

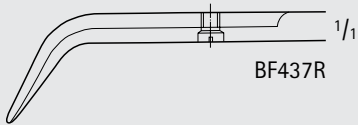

BF437R

BACKHAUS Towel Clamp, W/ Screw

Catalog Number	Length (in.)
BF436R	3 1/8
BF437R	4 1/8

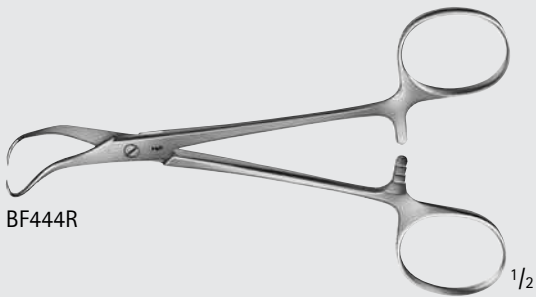

BF444R

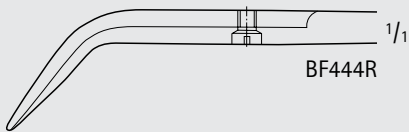

BF444R

BACKHAUS-KOCHER Towel Clamp, W/ Screw

Catalog Number	Length (in.)
BF444R	5 1/4



BF448R

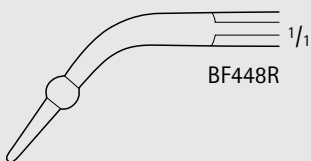

BF448R

ROEDER Towel Clamp, W/ Ball On Jaws

Catalog Number	Length (in.)
BF448R	5 1/4

General Surgery

Towel and Tubing Clamps

GENERAL SURGERY

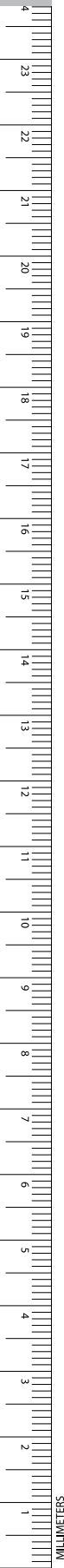

BF464R

1/2



BF464R

1/1

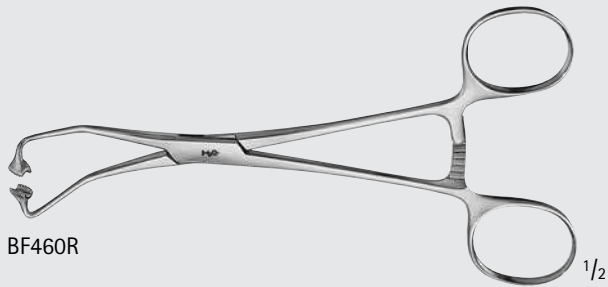

BF460R

1/2

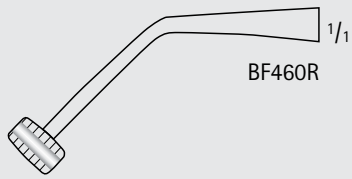

BF460R

1/1

Towel Clamp, Paper Drape

Catalog Number	Length (in.)
BF464R	5 1/2
BF460R	6

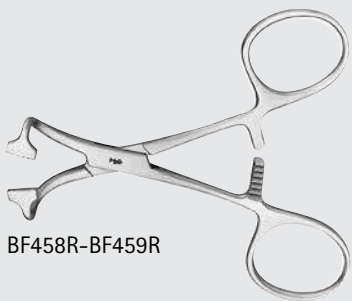

BF458R-BF459R

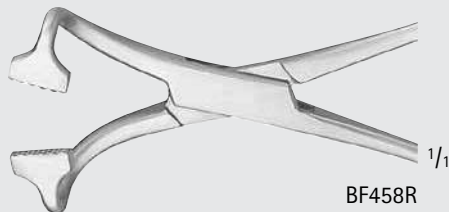

BF458R

1/1

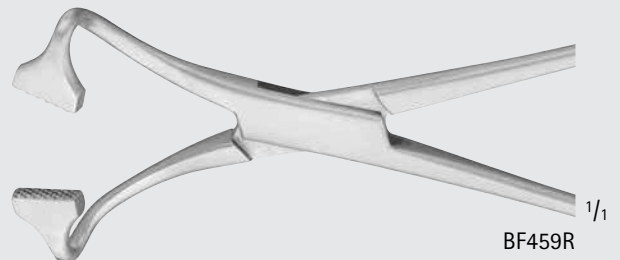

BF459R

1/1

Non-Perforating Towel Forceps

Catalog Number	Length (in.)
BF458R	4
BF459R	5 1/2



BF461R

1/2



1/1

BF461R



BF463R

1/2



1/1

BF463R

LORNA Non-Perforating Towel Clamp

Catalog Number	Length (in.)
BF461R	3 3/4
BF463R	5 1/8

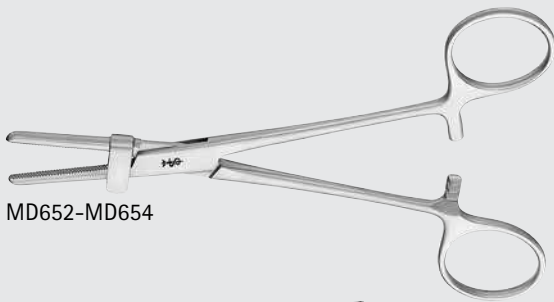

MD652-MD654



1/1

MD652



1/1

MD653



1/1

MD654

Tubing Clamp, W/ Guard

Catalog Number	Jaw	Length (in.)
MD652	SERR	6
MD653	SERR	7
MD654	SERR	7 7/8

General Surgery

Skin Hooks

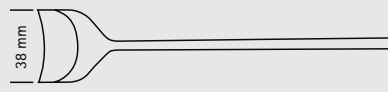
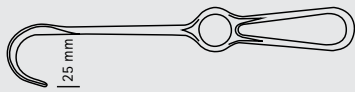

Dimensions for blade size of retractors
 1st number = depth Example: 25 x 38 mm
 2nd number = width



OL620R, MA185R, OL622R-OL624R, MD581

JOSEPH Skin Hook

Catalog Number	Tip	Prongs	Tip Size (mm)	Length (in.)
OL620R	SHARP	1	-	6 1/2
MA185R	SHARP	2	2	6 1/4
OL622R	SHARP	2	3	6 1/2
OL623R	SHARP	2	6	6 1/2
OL624R	SHARP	2	8	6 1/2
MD581	SHARP	2	10	6 1/2



OL621R

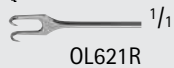

OL621R

FREER Double Hook

Catalog Number	Tip	Tip Size (mm)	Length (in.)
OL621R	SHARP	2.0 x 3.2	6



OA332R-OA333R



OA332R

OA333R

GRAEFE Hook

Catalog Number	Tip	Length (in.)
OA332R	SHARP	5
OA333R	BLUNT	5



OA334R-OA335R

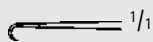
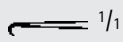

OA334R

OA335R

GUTHRIE Double Hook

Catalog Number	Tip	Length (in.)
OA334R	SHARP	5
OA335R	SHARP	5 1/8

GENERAL SURGERY

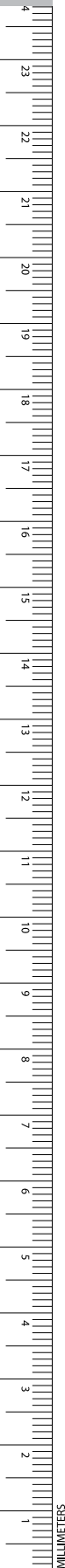



OA336R-OA338R



ROLLET Hook Retractor

Catalog Number	Tip	Blade End	Tip Size (mm)	Length (in.)
OA336R	SHARP	2 PRONGS	2.2 x 4.5	5 1/8
OA337R	SHARP	4 PRONGS	2.5 x 7.0	5 1/4
OA338R	BLUNT	4 PRONGS	2.2 x 7.0	5 1/4



OL615R

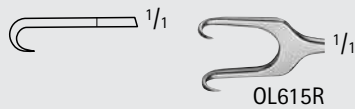

MCINDOE Hook

Catalog Number	Tip	Blade End	Tip Size (mm)	Length (in.)
OL615R	SHARP	2 PRONGS	9	6



OA340R

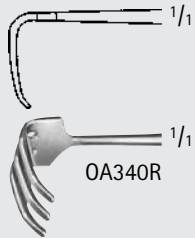

PAUL Tendon Hook

Catalog Number	Tip	Blade End	Tip Size (mm)	Length (in.)
OA340R	BLUNT	3 PRONGS	11 x 8	4 3/4



OA351R

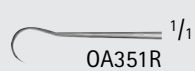

JAEGER Hook Retractor, Fine

Catalog Number	Tip	Length (in.)
OA351R	SHARP	5 1/4



OL610R



KILNER Skin Hook

Catalog Number	Tip	Length (in.)
OL610R	SHARP	6 1/4



OL611R-OL612R



GILLIES Skin Hook

Catalog Number	Tip	Hook End	Length (in.)
OL611R	SHARP	SMALL	7
OL612R	SHARP	LARGE	7

General Surgery

Skin Hooks

GENERAL SURGERY

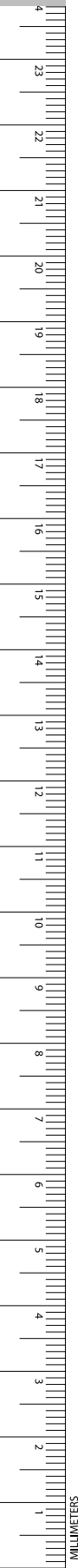

COTTLE Hook

Catalog Number	Tip	Hook End	Length (in.)
OL617R	SHARP	ANG	6 1/4
OL619R	SHARP	HVY-CVD	6 1/4

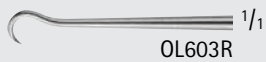

KLEINERT-KUTZ Skin Hook

Catalog Number	Size	Tip	Tip Size (mm)	Length (in.)
OL601R	1	SHARP	2.5	6 1/4
OL602R	2	SHARP	4.2	6 1/4
OL603R	3	SHARP	4.8	6 1/4



Prong Micro Hooks

Catalog Number	Tip	Tip Size (mm)	Length (in.)
MB885R	SHARP	1	5 5/8
MB886R	SHARP	2	5 5/8
MB887R	BLUNT	2	5 5/8
MB888R	SHARP	2	5 5/8
MB889R	SHARP	5	5 5/8
MB890R	SHARP	7	5 5/8
MB891R	SHARP	10	5 5/8



BROM Vein Hook

Catalog Number	Length (in.)
BT075R	6 3/4



BERGMANN Hook

Catalog Number	Tip	Tip Size (mm)	Length (in.)
BT100R	SHARP	7	5 1/2



EMMET Fistula Hook

Catalog Number	Tip	Length (in.)
BT161R	SHARP	8 3/4

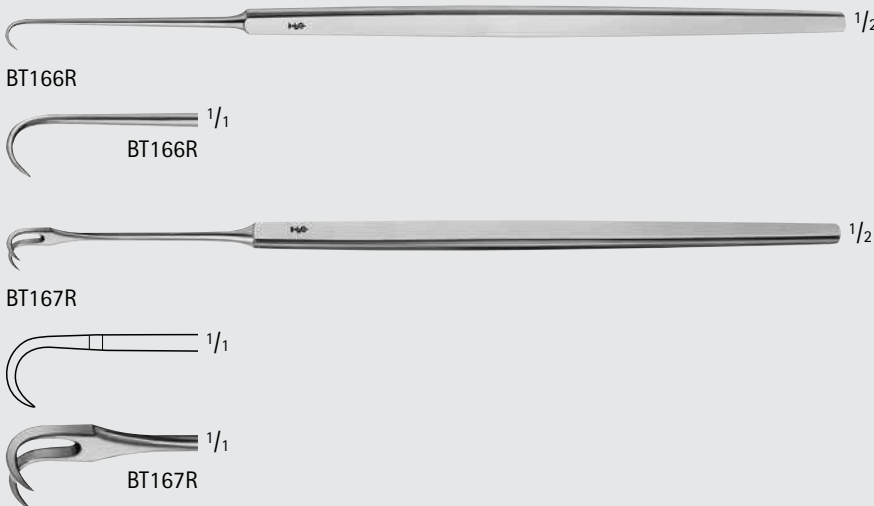

SIMON Fistula Hook

Catalog Number	Tip	Blade End	Length (in.)
BT166R	SHARP	1 PRONG	8 3/4
BT167R	SHARP	2 PRONGS	8 3/4

General Surgery

Hand Held Retractors

GENERAL SURGERY



Baby SENN-MILLER Retractor, Flat Handle

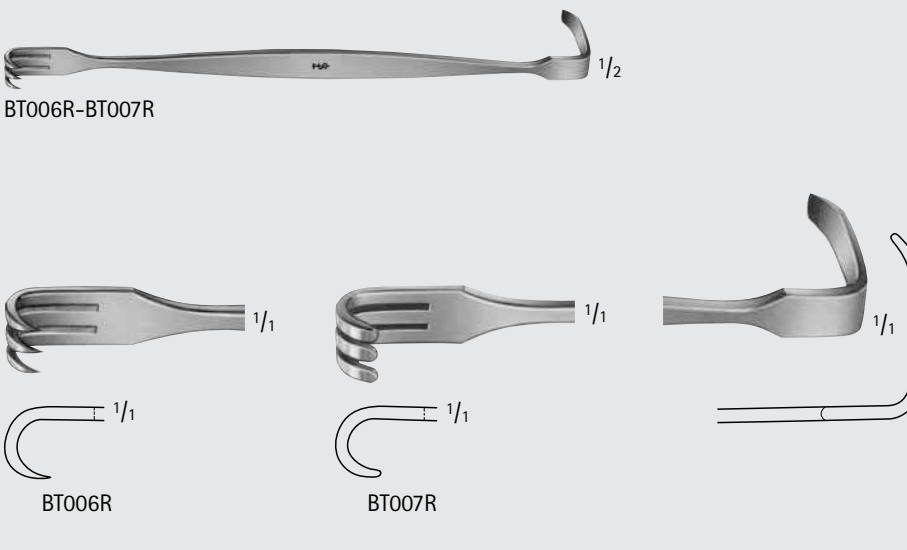

Catalog Number	Tip	Blade End	Blade Size (mm)	Length (in.)
BT006R	SHARP	3 PRONGS	8 x 7 / 22 x 7	6 1/8
BT007R	BLUNT	3 PRONGS	8 x 7 / 22 x 7	6 1/8

SENN-MILLER Retractor

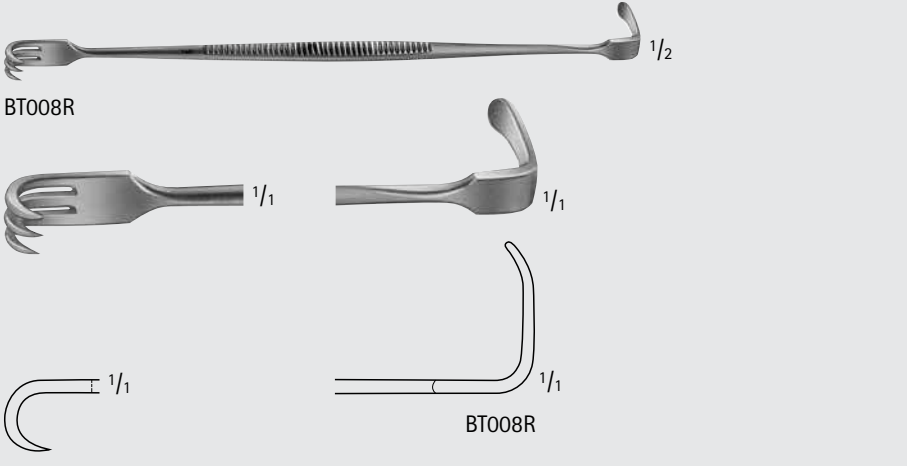

Catalog Number	Tip	Blade End	Blade Size (mm)	Length (in.)
BT008R	SHARP	3 PRONGS	8 x 7 / 18 x 5.5	6 1/2

SENN Retractor, Round Tapered Handle

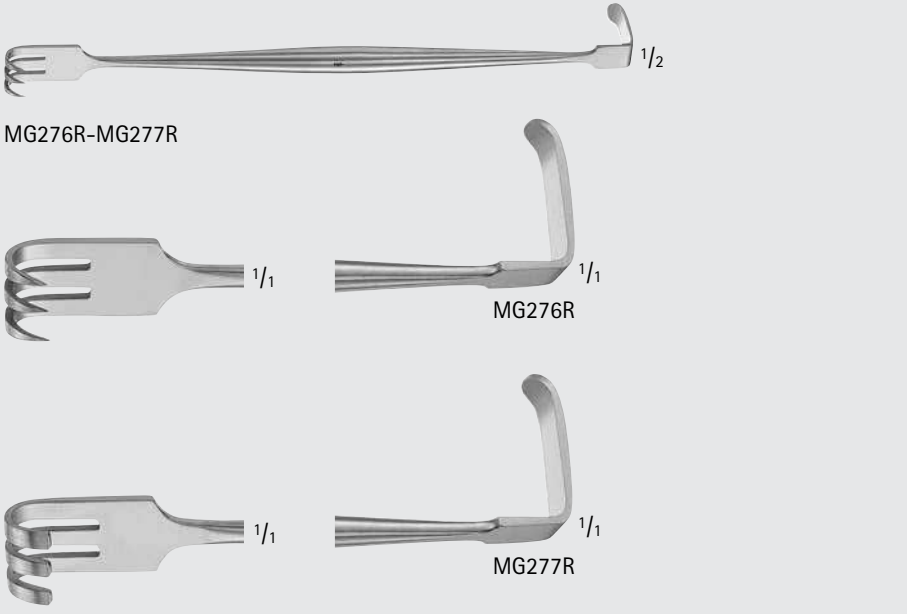

Catalog Number	Tip	Blade End	Blade Size (mm)	Length (in.)
MG276R	SHARP	3 PRONGS	9 x 10 / 22 x 7	6 1/4
MG277R	BLUNT	3 PRONGS	9 x 10 / 22 x 7	6 1/4



RAGNELL Retractor

Catalog Number	Blade Size (mm)	Length (in.)
BT004R	3 x 5 / 6.3 x 14	6
MG274R	3 x 11 / 5.4 x 17	6

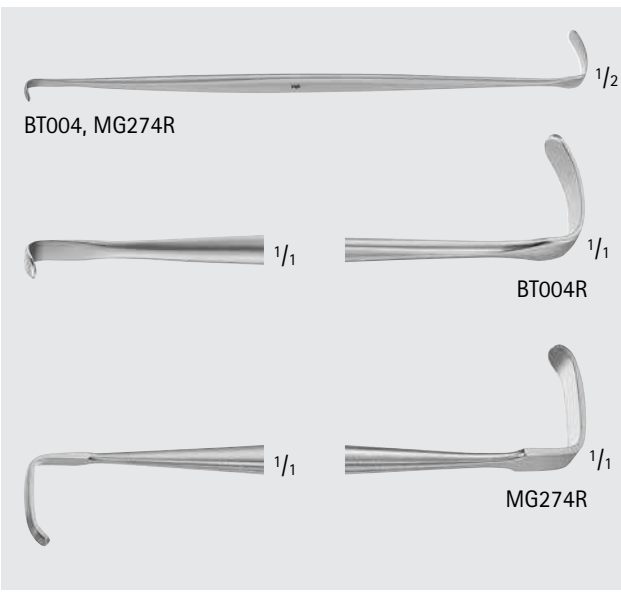

DAVIS Double Ended Retractor

Catalog Number	Blade Size (mm)	Length (in.)
MG475R	19 x 9 / 23 x 6.4	6

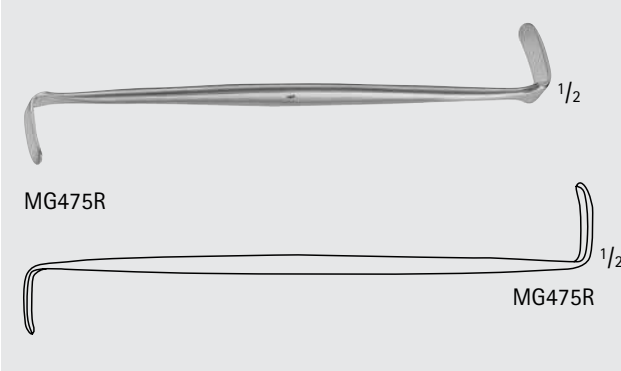

Double Ended Retractor

Catalog Number	Blade Size (mm)	Length (in.)
BT187R	20 x 15 / 20 x 19	8

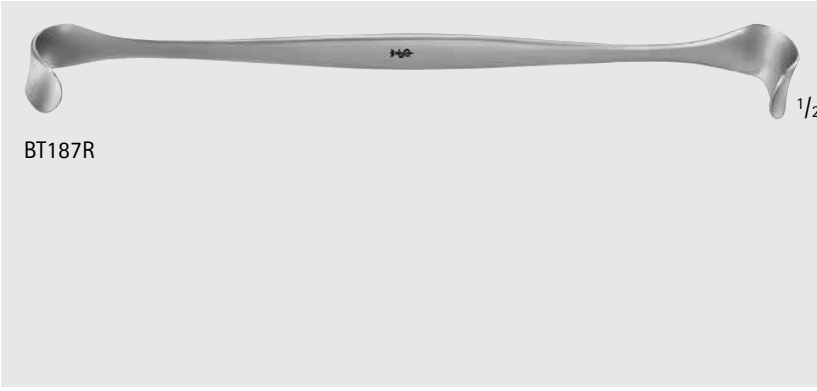

GOELET Retractor

Catalog Number	Blade Size (mm)	Length (in.)
MD497	30 x 32 / 35 x 40	7 1/2

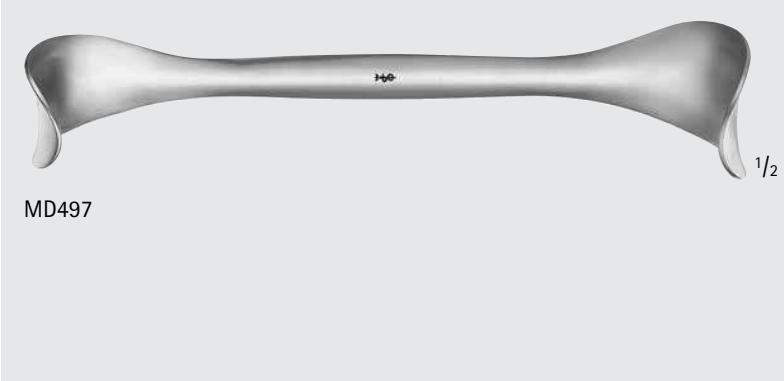

General Surgery

Hand Held Retractors

GENERAL SURGERY



BT010R



BT010R

LUER Retractor

Catalog Number	Blade Size (mm)	Length (in.)
BT010R	10 x 8 / 12 x 11	4 1/4



BT020R

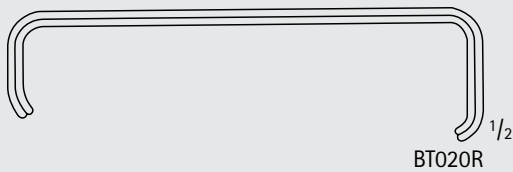

BT020R



BT021R

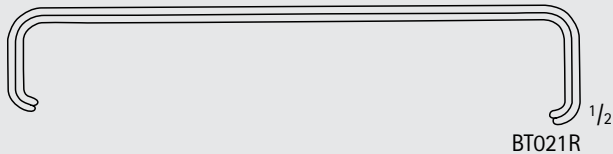

BT021R

FARABEUFR Retractor, 2/Set

Catalog Number	Blade Size (mm)	Length (in.)
BT020R	25 x 10 / 32 x 12 22 x 10 / 29 x 12	5
BT021R	23 x 16 / 28 x 16 19 x 16 / 24 x 16	6



MB984R

MAYO-COLLINS Retractor, 2/Set

Catalog Number	Blade Size (mm)	Length (in.)
MB984R	31 x 20 / 30 x 18 28 x 19 / 26 x 17	5 7/8



BT022R

1/2

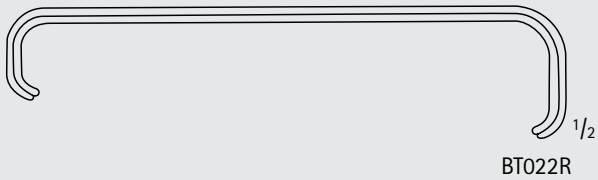

BT022R

1/2

COLLIN Retractor, 2/Set

Catalog Number	Blade Size (mm)	Length (in.)
BT022R	21 x 14 / 32 x 16 17 x 14 / 28 x 16	6



BT012R

1/2

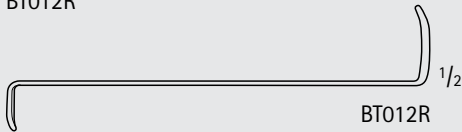

BT012R

1/2

CRILE Retractor

Catalog Number	Blade Size (mm)	Length (in.)
BT012R	11 x 4 / 19 x 6	4 1/4

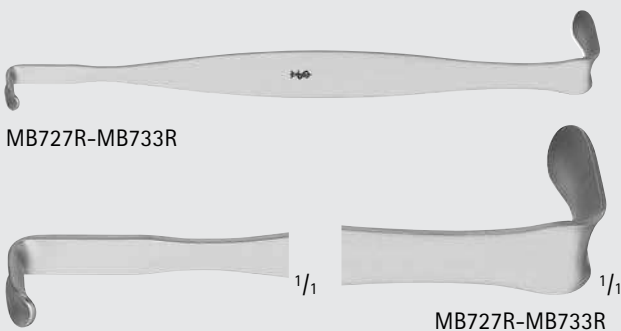

MB727R-MB733R

MB727R-MB733R

1/1

1/1

CRILE Retractor

Catalog Number	Size	Blade Size (mm)	Length (in.)
MB727R	1	3 x 11 / 6 x 21	4 1/4
MB728R	2	6 x 13 / 10 x 21	6 1/8
MB729R	3	16 x 25 / 17 x 35	6 1/4
MB730R	4	22 x 29 / 29 x 44	7
MB731R	5	29 x 41 / 35 x 51	7
MB732R	6	32 x 64 / 35 x 70	7 7/8
MB733R	7	41 x 76 / 51 x 79	8 7/8



INCHES

General Surgery

Hand Held Retractors

GENERAL SURGERY

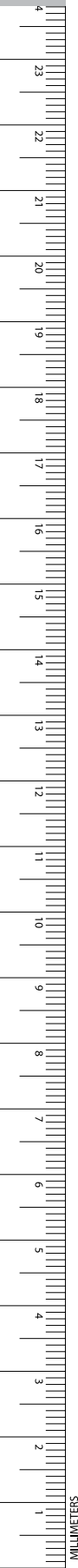

BT011R

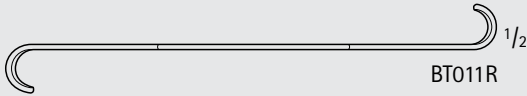

BT011R

ROSE Tracheal Retractor

Catalog Number	Blade Size (mm)	Length (in.)
BT011R	10 x 12 / 11 x 15	5 1/8



MG474R

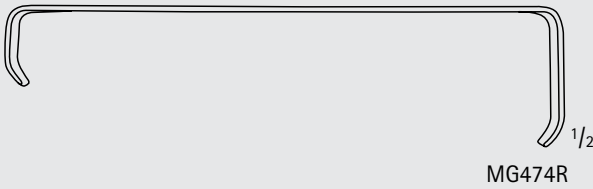

MG474R

Children's Hospital Retractor

Catalog Number	Blade Size (mm)	Length (in.)
MG474R	11 x 22 / 14 x 35	4 1/2



BT025R

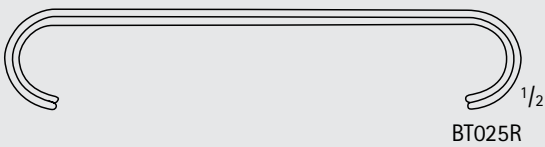

BT025R



BT026R

PARKER Retractor, 2/Set

Catalog Number	Blade Size (mm)	Length (in.)
BT025R	22 x 15 / 22 x 15 18 x 15 / 18 x 15	5 1/4
BT026R	31 x 25 / 27 x 25 31 x 25 / 27 x 25	7



BT034R-BT036R

ROUX Retractor

Catalog Number	Blade Size (mm)	Length (in.)
BT034R	20 x 22 / 25 x 29	6
BT035R	25 x 26 / 30 x 38	6 1/4
BT036R	28 x 29 / 33 x 44	6 3/4



BT034R



BT035R



BT036R





INCHES

General Surgery

Hand Held Retractors

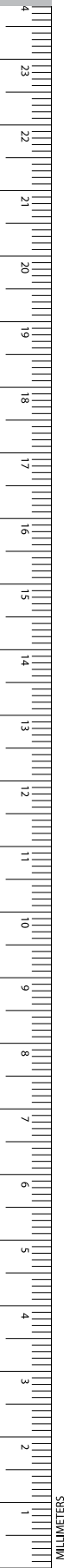
GENERAL SURGERY

BT030R-BT033R $\frac{1}{2}$

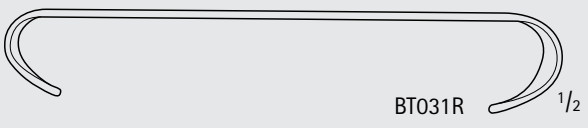

BT031R $\frac{1}{2}$

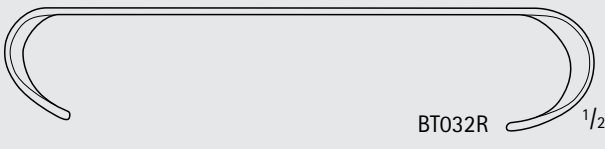

BT032R $\frac{1}{2}$

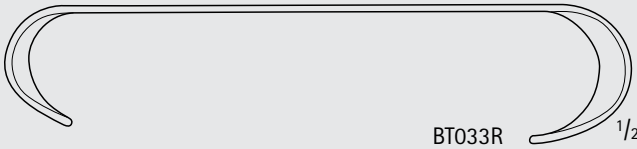

BT033R $\frac{1}{2}$

ROUX Retractor

Catalog Number	Blade Size (mm)	Length (in.)
BT030R	COMPLETE SET BT031R-BT033R	-
BT031R	21 x 22 / 27 x 28	5 3/4
BT032R	26 x 26 / 32 x 26	6 1/8
BT033R	30 x 30 / 36 x 44	6 1/2



MB584R-MB585R $\frac{1}{2}$

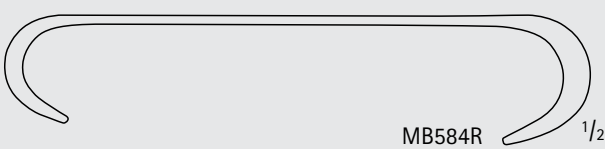

MB584R $\frac{1}{2}$



MB585R $\frac{1}{2}$

ROUX Retractor

Catalog Number	Blade Size (mm)	Length (in.)
MB584R	25 x 26 / 30 x 37	6 1/2
MB585R	28 x 28 / 29 x 40	6 1/2



BT029R $\frac{1}{2}$

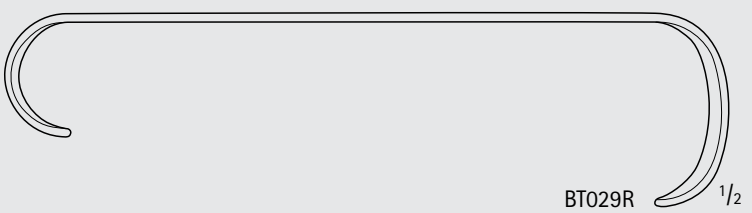

BT029R $\frac{1}{2}$

ROUX Retractor, Long

Catalog Number	Blade Size (mm)	Length (in.)
BT029R	28 x 28 / 46 x 28	7 1/2



BT040R

MATHIEU Retractor, 2/Set

Catalog Number	Blade Size (mm)	Length (in.)
BT040R	42 x 13 / 41 x 13 45 x 25 / 40 x 25	7 7/8

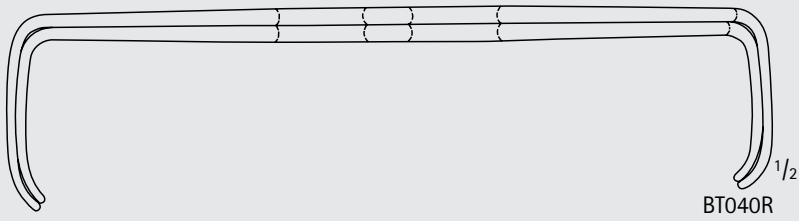

BT040R



BT041R

US Army Retractor, 2/Set

Catalog Number	Blade Size (mm)	Length (in.)
BT041R	26 x 15 / 22 x 15 43 x 15 / 39 x 15	8 3/4



BT041R



INCHES

General Surgery

Hand Held Retractors

GENERAL SURGERY

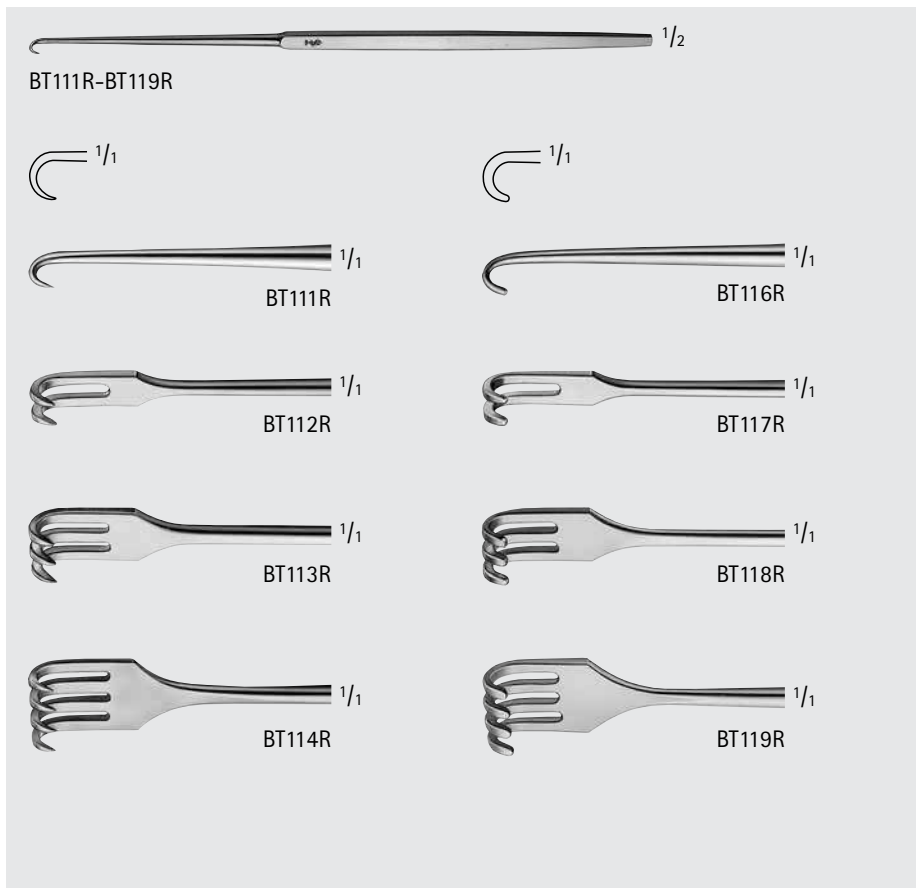
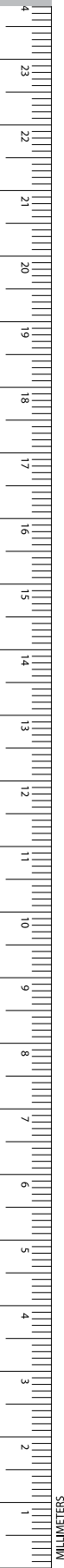

Hook, Small Curve

Catalog Number	Tip	Blade End	Blade Size (mm)	Length (in.)
BT111R	SHARP	1 PRONG	-	6 1/2
BT112R	SHARP	2 PRONGS	5.0 x 4.2	6 1/2
BT113R	SHARP	3 PRONGS	5.0 x 7.0	6 1/2
BT114R	SHARP	4 PRONGS	5.0 x 9.5	6 1/2
BT116R	BLUNT	1 PRONG	-	6 1/2
BT117R	BLUNT	2 PRONGS	4.5 x 4.2	6 1/2
BT118R	BLUNT	3 PRONGS	4.5 x 7.0	6 1/2
BT119R	BLUNT	4 PRONGS	4.5 x 9.0	6 1/2

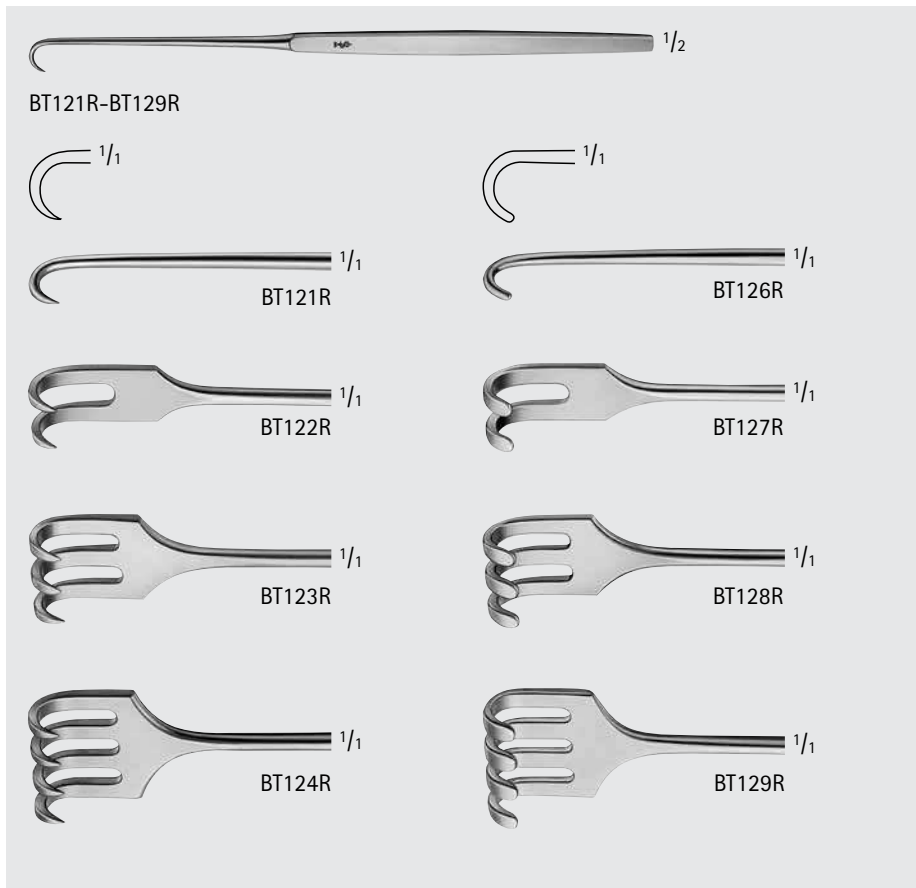

Hook, Large Curve

Catalog Number	Tip	Blade End	Blade Size (mm)	Length (in.)
BT121R	SHARP	1 PRONG	-	6 1/2
BT122R	SHARP	2 PRONGS	7.5 x 7.5	6 1/2
BT123R	SHARP	3 PRONGS	7.5 x 10.0	6 1/2
BT124R	SHARP	4 PRONGS	7.5 x 14.0	6 1/2
BT126R	BLUNT	1 PRONG	-	6 1/2
BT127R	BLUNT	2 PRONGS	6.8 x 7.5	6 1/2
BT128R	BLUNT	3 PRONGS	6.8 x 10.0	6 1/2
BT129R	BLUNT	4 PRONGS	6.8 x 14.0	6 1/2

CRILE Hook and Dissector

Catalog Number	Length (in.)
MB060R	11 3/4



KLAPP Tendon Hook

Catalog Number	Tip	Blade End	Blade Size (mm)	Length (in.)
BT172R	BLUNT	4 PRONGS	15 x 11	6 7/8

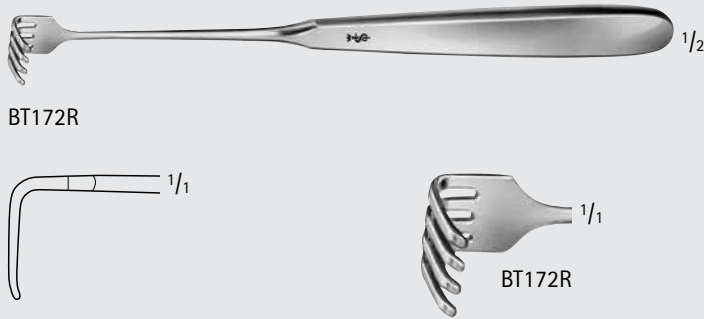

Vein Retractor

Catalog Number	Blade Size (mm)	Length (in.)
BT179R	10 x 13	6 1/4

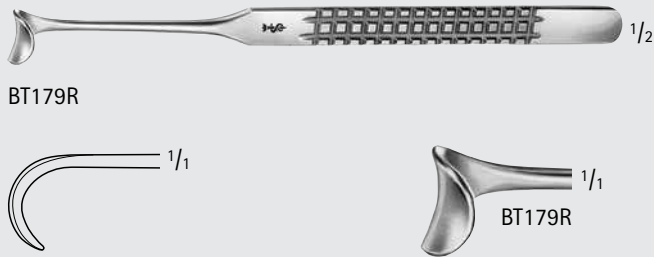

KOENIG Vein Retractor

Catalog Number	Blade Size (mm)	Length (in.)
BT182R	13 x 13	7
BT183R	12 x 16	7

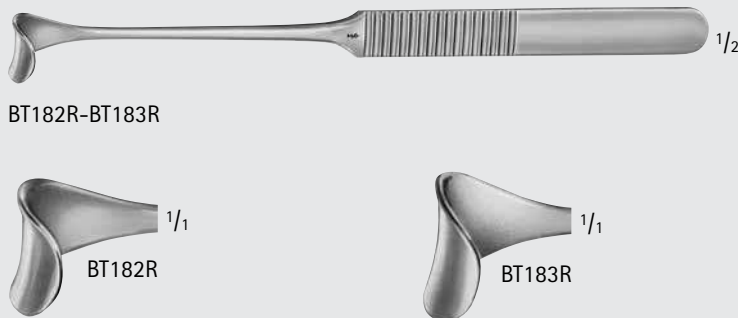

General Surgery

Hand Held Retractors





GENERAL SURGERY



MEYERDING Thumb Retractor

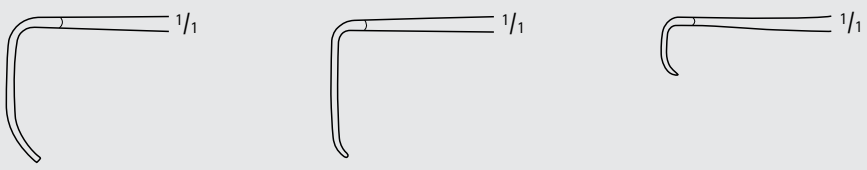

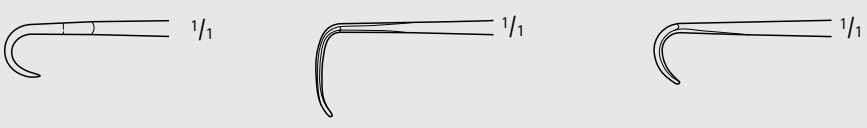

Catalog Number	Blade Size	Size (#)	Blade Size (mm)	Length (in.)
BT193R	A	1	18 x 7	7
BT194R	B	2	16 x 5	7
BT195R	C	3	7 x 4	7
BT196R	D	4	5 x 10	7
BT197R	E	5	11 x 4	7
BT198R	F	6	6 x 4	7

CUSHING-KOCHER Retractor





Catalog Number	Blade Size (mm)	Length (in.)
BT190R	10 x 10	6 7/8

CUSHING Vein Retractor

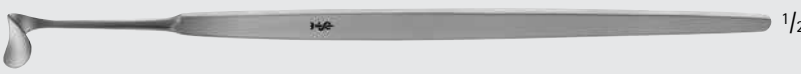

Catalog Number	Blade Size (mm)	Length (in.)
BT184R	10 x 13	8
BT185R	14 x 18	8

**CUSHING Vein Retractor
(continued)**

Catalog Number	Blade Size (mm)	Length (in.)
BT200R	14 x 11	9 3/4
BT202R	22 x 15	9 3/4



BT200R-BT202R



CUSHING Vein Retractor

Catalog Number	Blade Size (mm)	Length (in.)
MB912R	14	12 1/2
MB913R	14	14
MB914R	14	16



MB912R-MB914R



GIL VERNET Retractor, Malleable

Catalog Number	Blade Size (mm)	Length (in.)
MB766R	9	11 1/4
MB767R	11	11 1/4
MB768R	13	11 1/4
MB769R	18	11 1/4



MB766R-MB769R



INCHES

General Surgery

Hand Held Retractors

GENERAL SURGERY

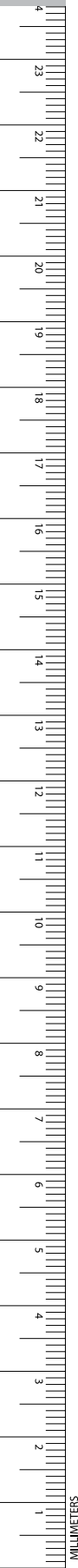

BT221R

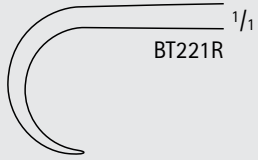

BT221R



BT222R-BT230R

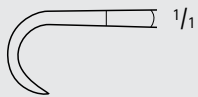

1/1

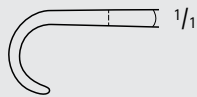

1/1



BT222R



BT227R



BT223R



BT228R



BT224R



BT229R



BT225R



BT230R

VOLKMANN Retractor

Catalog Number	Tip	Blade End	Blade Size (mm)	Length (in.)
BT221R	SHARP	1 PRONG	8.5 x 8	8 3/4
BT222R	SHARP	2 PRONGS	9 x 8	8 7/8
BT223R	SHARP	3 PRONGS	9 x 13	8 7/8
BT224R	SHARP	4 PRONGS	9 x 19	8 7/8
BT225R	SHARP	6 PRONGS	9 x 29	8 7/8
BT227R	BLUNT	2 PRONGS	8.5 x 12	8 7/8
BT228R	BLUNT	3 PRONGS	8.5 x 13	8 7/8
BT229R	BLUNT	4 PRONGS	8.5 x 19	8 7/8
BT230R	BLUNT	6 PRONGS	8.5 x 29	8 7/8

VOLKMANN Retractor, Small

Catalog Number	Tip	Blade End	Blade Size (mm)	Length (in.)
BT240R	SHARP	1 PRONG	-	8 3/4
BT241R	BLUNT	1 PRONG	-	8 3/4
BT242R	SHARP	2 PRONGS	9 x 8	8 3/4
BT243R	SHARP	3 PRONGS	9 x 13	8 3/4
BT244R	SHARP	4 PRONGS	9 x 19	8 3/4
BT246R	SHARP	6 PRONGS	9 x 29	8 3/4
BT248R	SHARP	8 PRONGS	9 x 40	8 3/4
BT257R	SEMI-S	2 PRONGS	8.5 x 8	8 3/4
BT259R	SEMI-S	3 PRONGS	8.5 x 13	8 3/4
BT260R	SEMI-S	4 PRONGS	8.5 x 19	8 3/4
BT261R	SEMI-S	6 PRONGS	8.5 x 29	8 3/4
BT265R	SEMI-S	8 PRONGS	8.5 x 40	8 3/4
BT252R	BLUNT	2 PRONGS	8 x 8	8 3/4
BT253R	BLUNT	3 PRONGS	8 x 13	8 3/4
BT254R	BLUNT	4 PRONGS	8 x 19	8 3/4
BT256R	BLUNT	6 PRONGS	8 x 29	8 3/4
BT258R	BLUNT	8 PRONGS	8 x 40	8 3/4



BT240R-BT241R

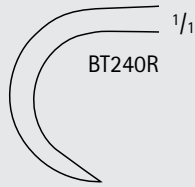

BT240R

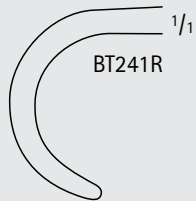

BT241R



BT242R-BT265R

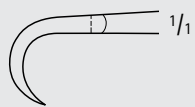

BT242R

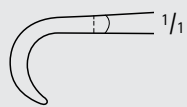

BT257R

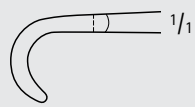

BT252R



BT243R



BT259R



BT253R



BT244R



BT260R



BT254R



BT246R



BT261R



BT256R



BT248R



BT265R



BT258R



INCHES

General Surgery

Hand Held Retractors

GENERAL SURGERY



MG260R-MG264R



MG265R-MG269R

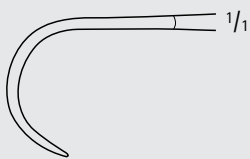

MG260R

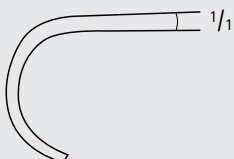

MG265R



MG261R



MG266R



MG262R



MG267R



MG264R

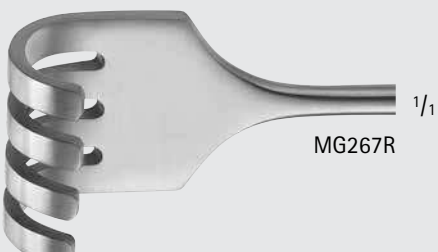

MG269R

VOLKMANN Retractor, US Version

Catalog Number	Tip	Blade End	Blade Size (mm)	Length (in.)
MG260R	SHARP	2 PRONGS	20 x 11	8 3/4
MG261R	SHARP	3 PRONGS	20 x 18	8 3/4
MG262R	SHARP	4 PRONGS	20 x 26	8 3/4
MG264R	SHARP	6 PRONGS	20 x 40	8 3/4
MG265R	BLUNT	2 PRONGS	20 x 11	8 3/4
MG266R	BLUNT	3 PRONGS	20 x 18	8 3/4
MG267R	BLUNT	4 PRONGS	20 x 26	8 3/4
MG269R	BLUNT	6 PRONGS	20 x 40	8 3/4

KOCHER Retractor, Large

Catalog Number	Tip	Blade End	Blade Size (mm)	Length (in.)
BT262R	SEMI-S	2 PRONGS	16 x 9	8 3/4
BT263R	SEMI-S	3 PRONGS	16 x 14	8 3/4
BT264R	SEMI-S	4 PRONGS	16 x 20	8 3/4
BT266R	SEMI-S	6 PRONGS	16 x 30	8 3/4
BT272R	BLUNT	2 PRONGS	15.5 x 9	8 3/4
BT273R	BLUNT	3 PRONGS	15.5 x 14	8 3/4
BT274R	BLUNT	4 PRONGS	15.5 x 20	8 3/4
BT276R	BLUNT	6 PRONGS	15.5 x 30	8 3/4

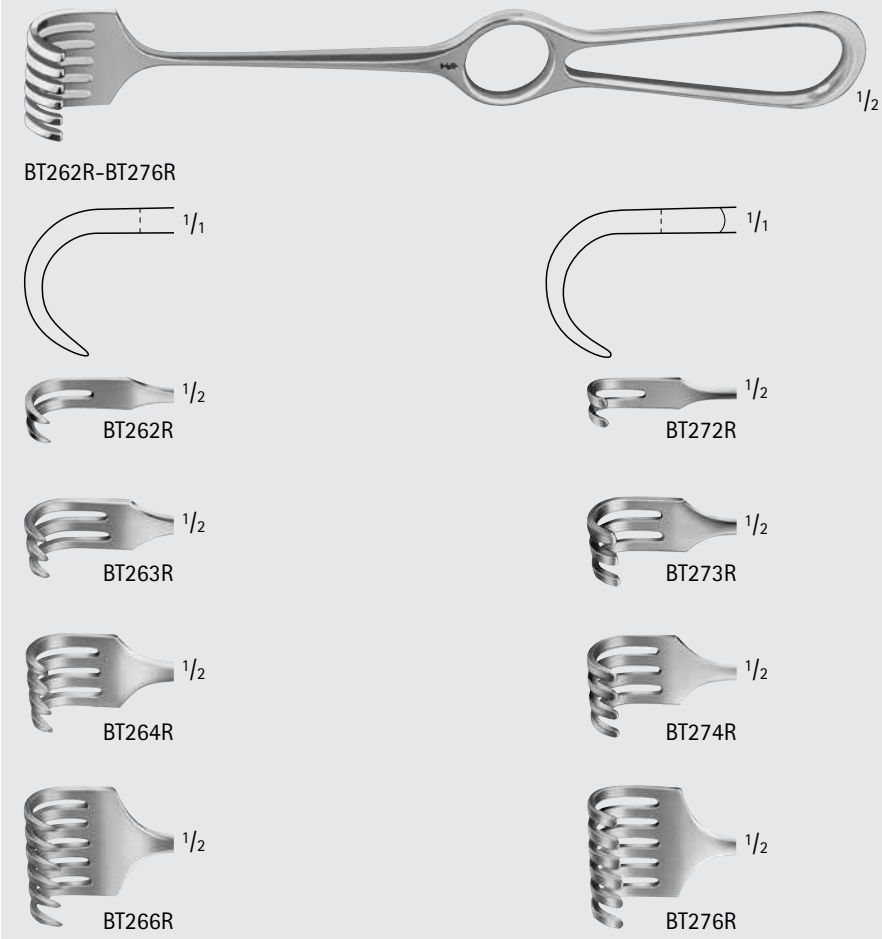

KOERTE Retractor

Catalog Number	Tip	Blade End	Blade Size (mm)	Length (in.)
BT279R	SEMI-S	8 PRONGS	26 x 40	9 1/2
BT278R	BLUNT	8 PRONGS	26 x 40	9 1/2

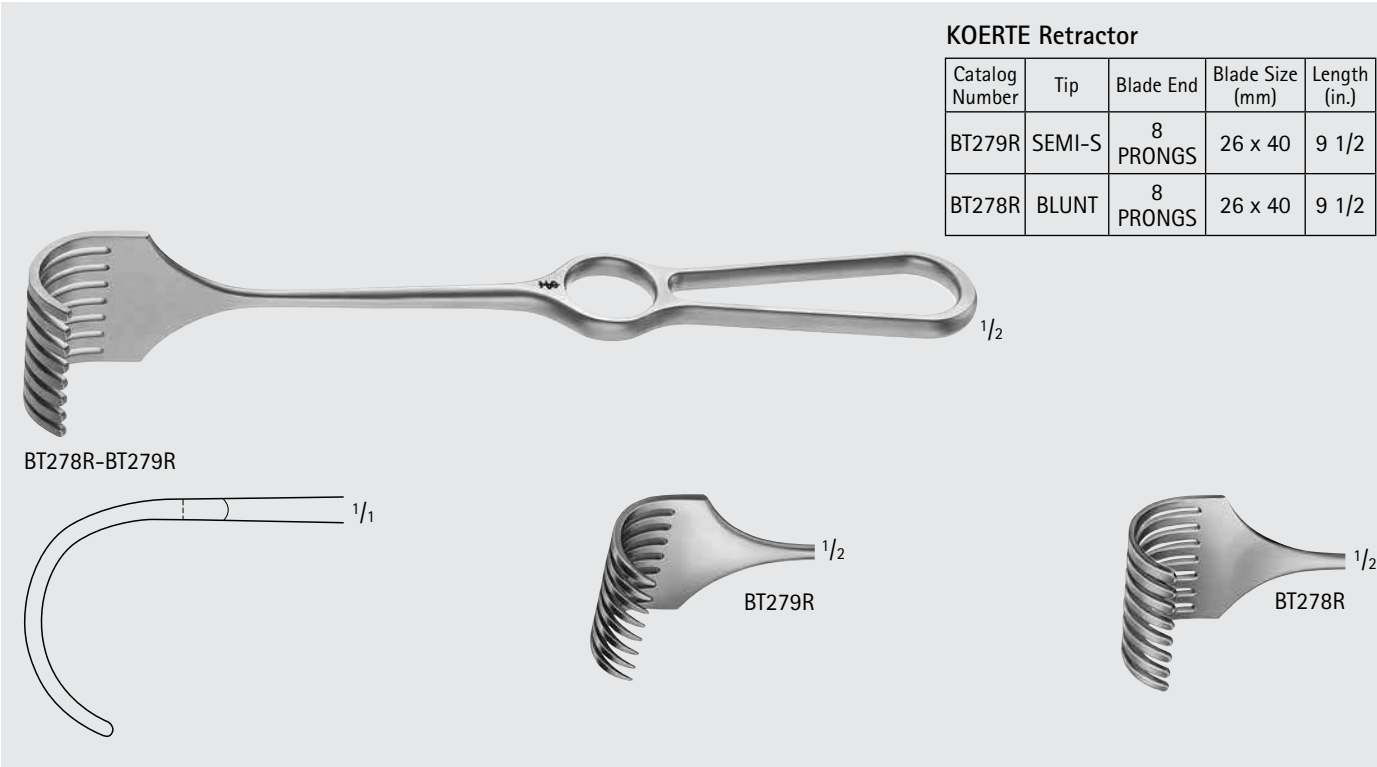

General Surgery
Hand Held Retractors

GENERAL SURGERY

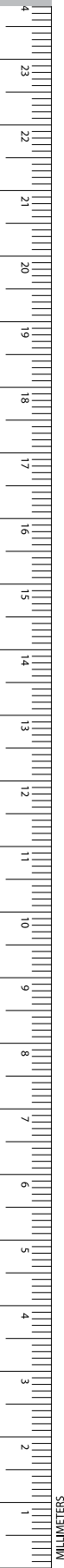

ISRAEL Retractor

Catalog Number	Tip	Blade End	Blade Size (mm)	Length (in.)
BT284R	BLUNT	4 PRONGS	39 x 40	10
BT285R	BLUNT	5 PRONGS	47 x 51	10
BT286R	BLUNT	6 PRONGS	53 x 62	10
BT287R	BLUNT	6 PRONGS	70 x 70	10



BT284R-BT287R

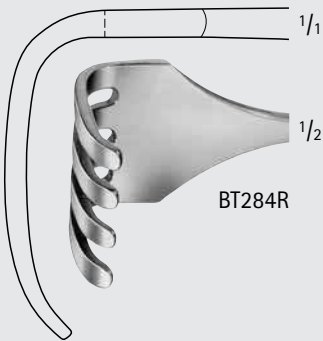

BT284R

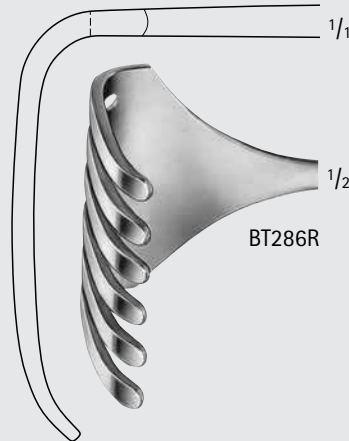

BT286R

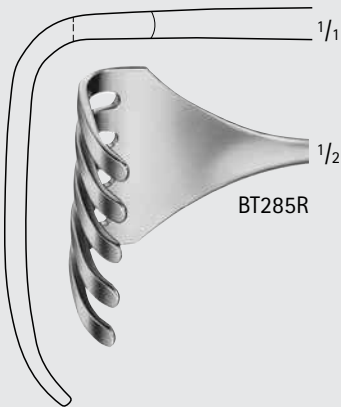

BT285R

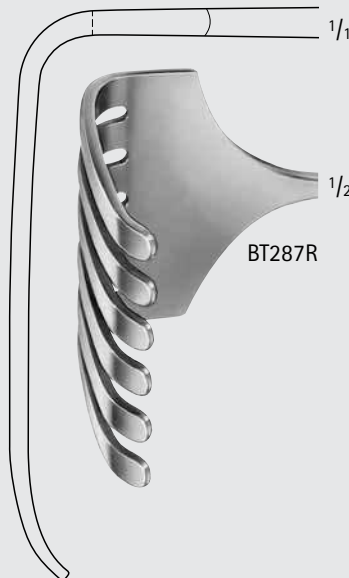

BT287R

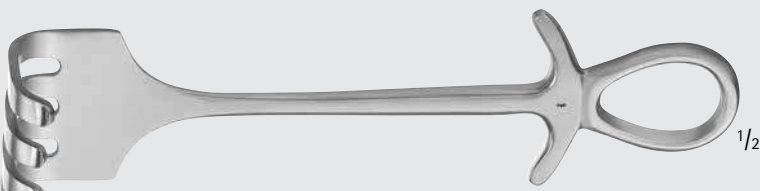

MG284R 1/2



MG284R 1/2

ISRAEL Retractor, T-Handle

Catalog Number	Tip	Blade End	Blade Size (mm)	Length (in.)
MG284R	BLUNT	4 PRONGS	46 x 40	7 1/2



BT293R-BT296R 1/2



BT293R 1/1

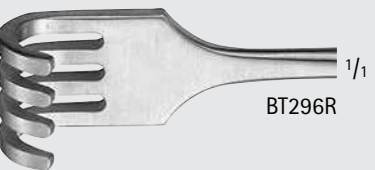

BT296R 1/1



BT294R 1/1

MURPHY Retractor

Catalog Number	Tip	Blade End	Length (in.)
BT293R	SHARP	3 PRONGS	7 3/4
BT294R	SHARP	4 PRONGS	7 3/4
BT296R	BLUNT	4 PRONGS	7 3/4



BT290R 1/1

BT290R 1/2

KOERTE-WAGNER Retractor



Catalog Number	Tip	Blade End	Blade Size (mm)	Length (in.)
BT290R	SEMI-S	8 PRONGS	28 x 40	11



INCHES

General Surgery
Hand Held Retractors

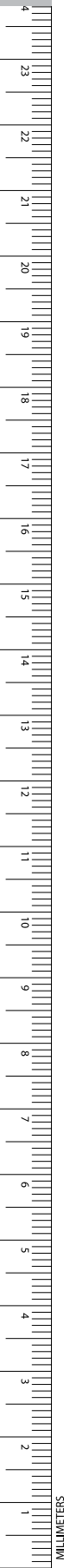
GENERAL SURGERY

LANGENBECK Retractor

Catalog Number	Blade Size (mm)	Length (in.)
BT311R	30 x 10	9
BT315R	40 x 10	9
BT316R	43 x 13	9

BT311R-BT316R

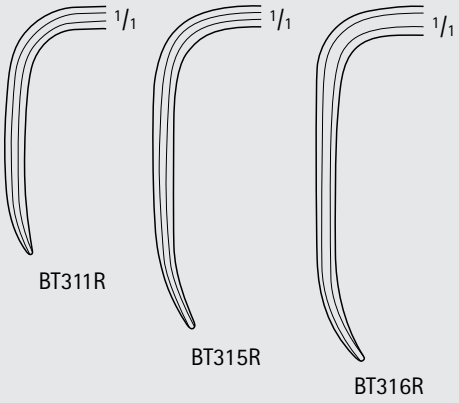

BT311R BT315R BT316R



SAUERBRUCH Retractor

Catalog Number	Blade Size (mm)	Length (in.)
BT351R	46 x 16	8 7/8
BT352R	55 x 22	8 7/8
BT353R	72 x 19	8 7/8

BT351R-BT353R

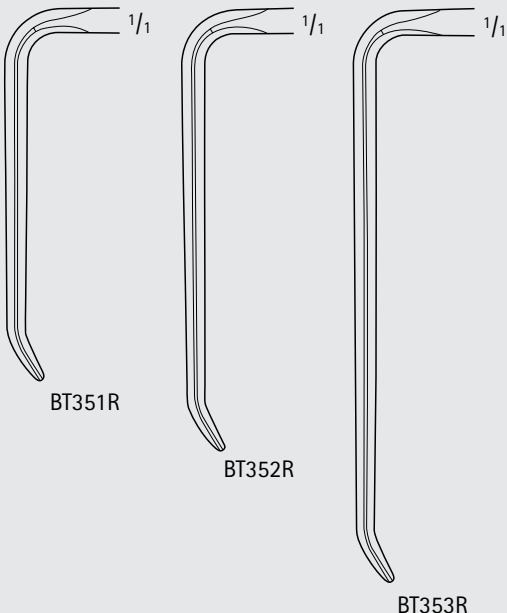

BT351R BT352R BT353R



BT354R-BT365R

KOCHER-LANGENBECK Retractor

Catalog Number	Blade Size (mm)	Length (in.)
BT354R	25 x 6	8 1/2
BT356R	35 x 8	8 1/2
BT357R	35 x 11	8 1/2
BT358R	35 x 15	8 1/2
BT359R	41 x 11	8 1/2
BT361R	55 x 11	8 1/2
BT363R	70 x 14	8 1/2
BT364R	80 x 12	8 1/2
BT365R	80 x 16	8 1/2

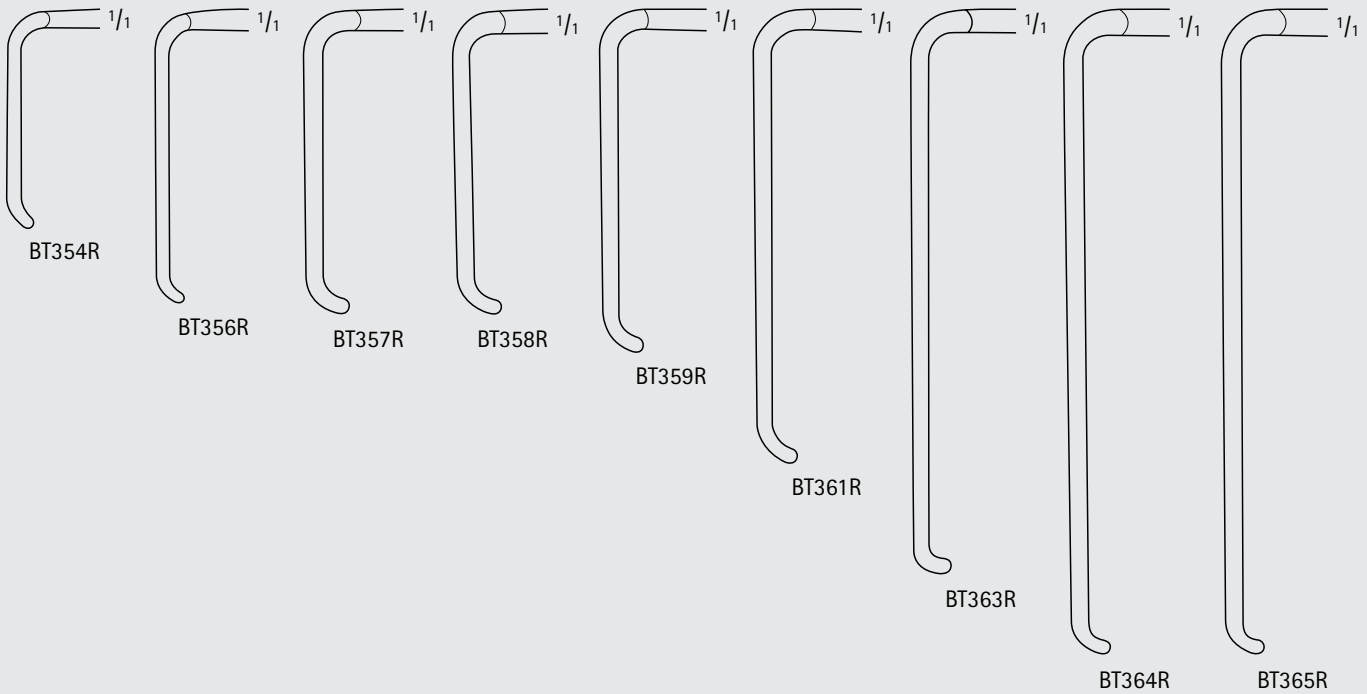

MB785R



MB785R

LAHEY Goiter Retractor

Catalog Number	Blade Size (mm)	Length (in.)
MB785R	24 x 8	7 7/8





INCHES

General Surgery

Hand Held Retractors

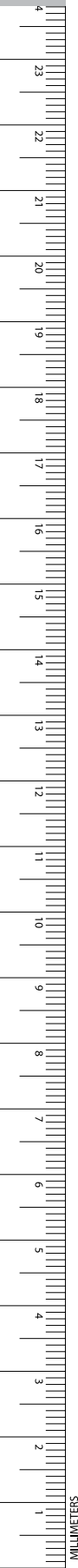
GENERAL SURGERY

MB748R $\frac{1}{2}$

MCBURNEY Thyroid Retractor

Catalog Number	Blade Size (mm)	Length (in.)
MB748R	20 x 10	7 1/2



MB748R $\frac{1}{1}$



BT404R-BT406R

MIDDELDORPF Retractor

Catalog Number	Blade Size (mm)	Length (in.)
BT404R	15 x 15	8 3/4
BT405R	20 x 22	8 1/2
BT406R	28 x 28	9 1/4



BT404R $\frac{1}{1}$

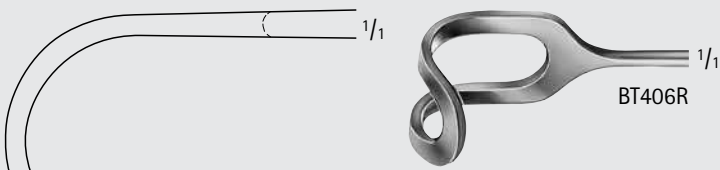

BT406R $\frac{1}{1}$

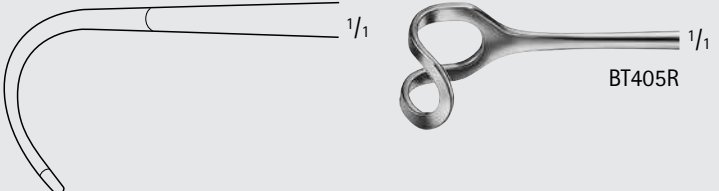

BT405R $\frac{1}{1}$



BT408R $\frac{1}{2}$

GREENE Retractor

Catalog Number	Blade Size (mm)	Length (in.)
BT408R	28 x 22	8 7/8

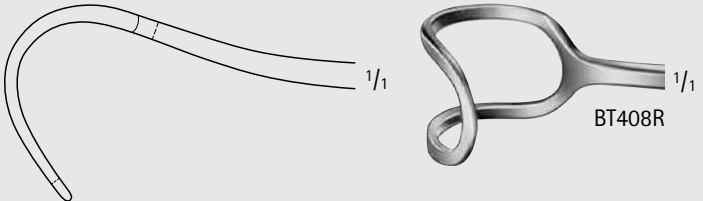

BT408R $\frac{1}{1}$



DOCKHORN Cheek Retractor

Catalog Number	Blade Size (mm)	Length (in.)
D0438R	40 x 12	8 1/4
D0439R	55 x 14	8 1/4

D0438R-D0439R

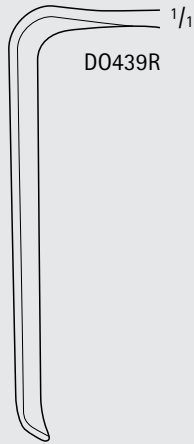

INCHES

General Surgery
Abdominal Retractors

GENERAL
SURGERY

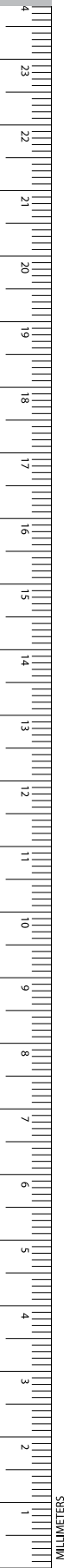

HOESEL Retractor

Catalog Number	Blade Size (mm)	Length (in.)
BT442R	100 x 30	9 3/4
BT446R	220 x 40	9 3/4

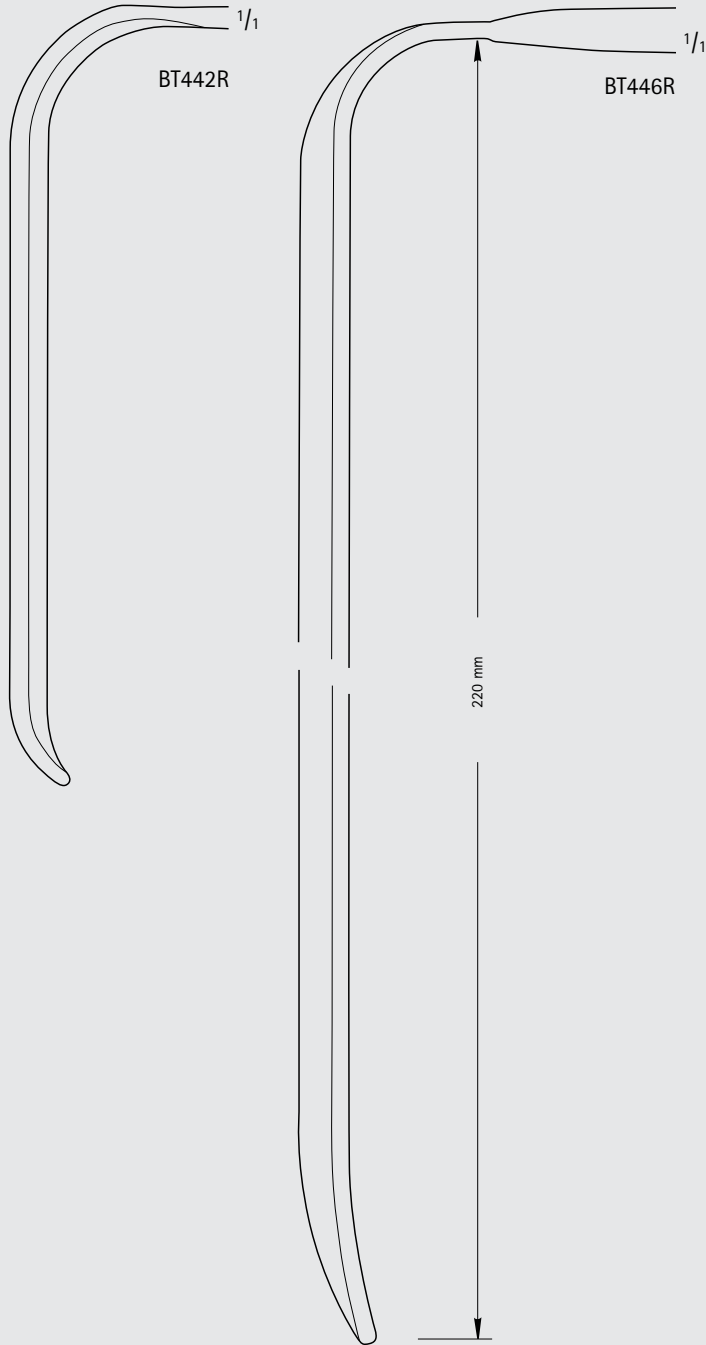
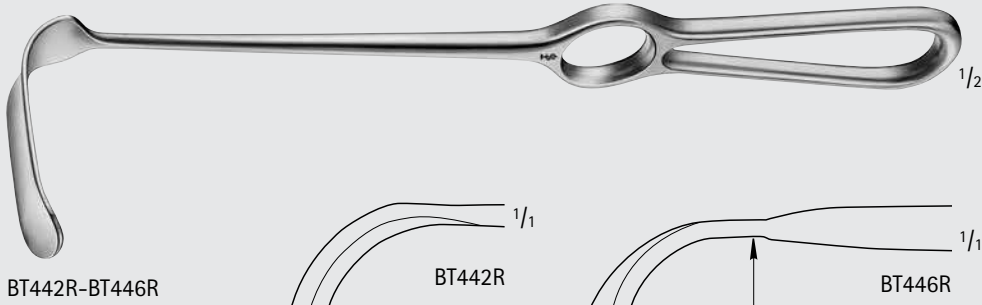

KOCHER Retractor

Catalog Number	Blade Size (mm)	Length (in.)
BT461R	80 x 42	9 3/4
BT462R	80 x 50	9 3/4
BT463R	80 x 60	9 3/4



BT461R-BT463R

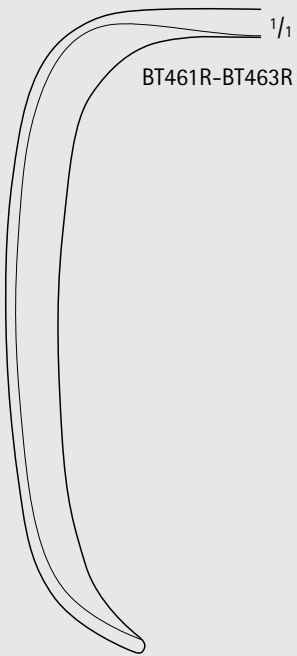

General Surgery
Abdominal Retractors

GENERAL SURGERY



KRAEMER Retractor

Catalog Number	Blade Size (mm)	Length (in.)
BT464R	66 x 10	8 1/4

BT464R



CASPAR Retractor

Catalog Number	Blade Size (mm)	Length (in.)
BT465R	67 x 17	8 1/4

BT465R





MIASPAS® Mini ALIF LANGENBECK Retractor

Catalog Number	Blade Size (mm)	Length (in.)
BT450R	125 x 20	8 1/4
BT451R	125 x 35	8 1/4
BT466R	80 x 20	8 1/4
BT467R	110 x 20	8 1/4
BT468R	80 x 35	8 1/4
BT469R	110 x 35	8 1/4

BT450R-BT469R



RICHARDSON-EASTMAN Retractor

Catalog Number	Description	Tip	Length (in.)
BT470R	2/SET (BT471R, BT472R)	-	-
BT471R	-	SM	9 3/4
BT472R	-	LRG	10 5/8

BT470R-BT472R

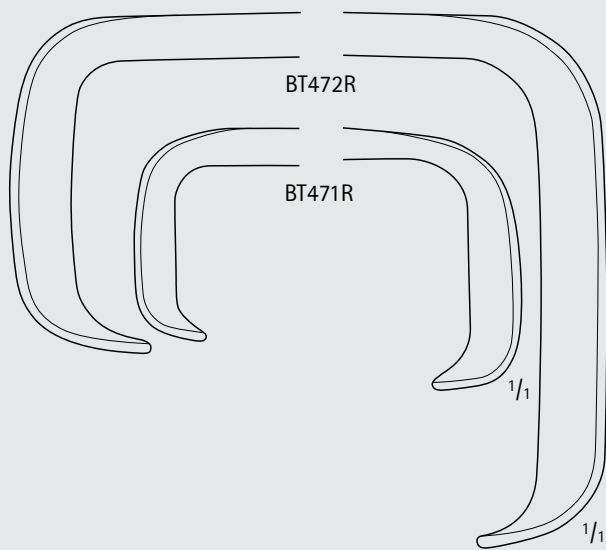

General Surgery

Abdominal Retractors

GENERAL SURGERY

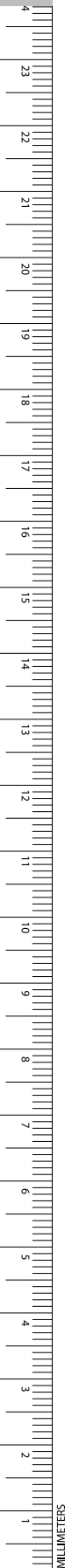

BT475R-BT477R

RICHARDSON Retractor

Catalog Number	Blade Size (mm)	Blade Size (in.)	Length (in.)
BT475R	23 x 20	1 x 3/4	9 1/2
BT476R	30 x 29	1 1/4 x 1 1/8	9 1/2
BT477R	37 x 37	1 1/2 x 1 1/2	9 1/2
BT478R	47 x 21	2 x 3/4	9 1/2

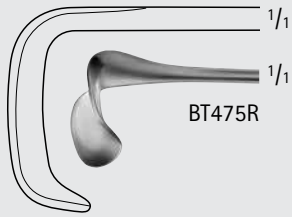

BT475R

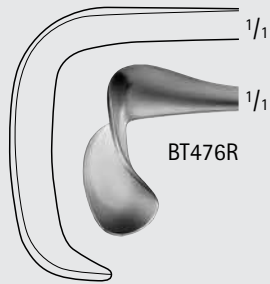

BT476R

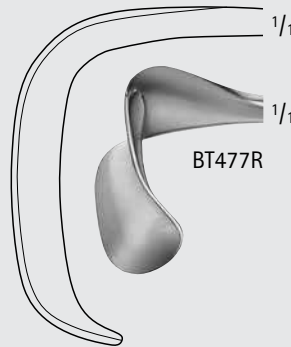

BT477R



BT478R

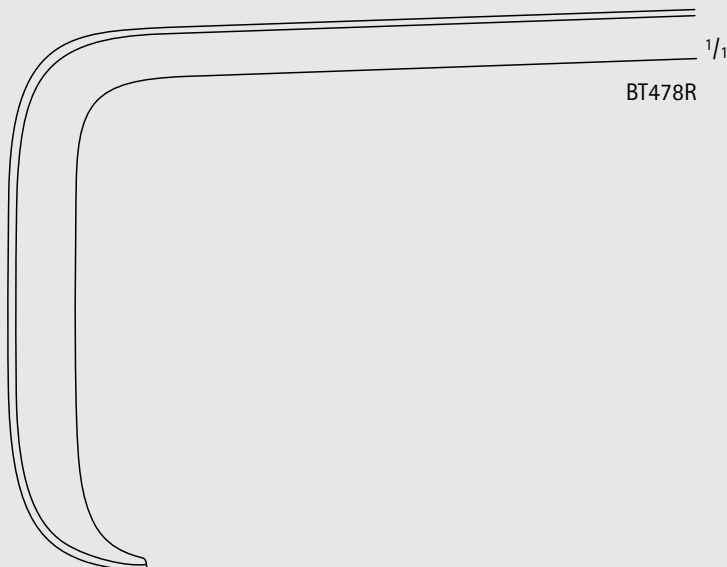

BT478R

RICHARDSON Retractor

Catalog Number	Blade Size (mm)	Blade Size (in.)	Length (in.)
BT479R	65 x 41	2 1/2 x 1 5/8	9 3/4



BT479R

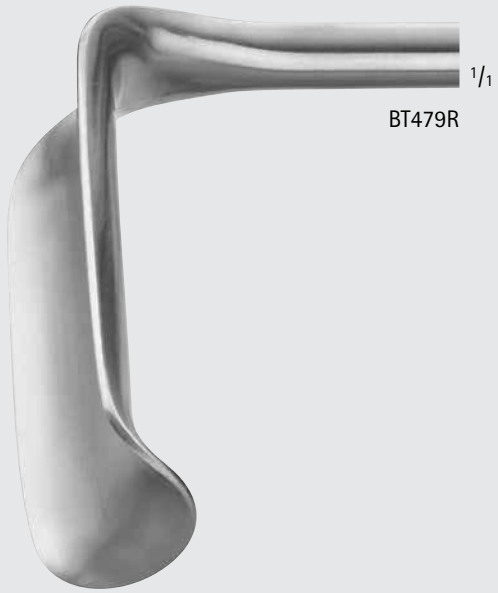

General Surgery
Abdominal Retractors

GENERAL SURGERY

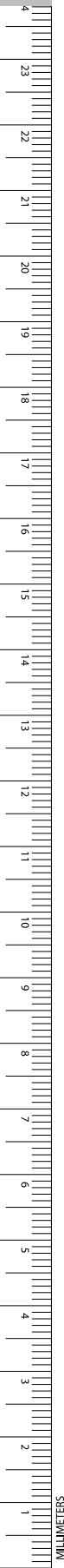

KELLY Retractor

Catalog Number	Blade Size (mm)	Blade Size (in.)	Length (in.)
BT481R	50 x 40	2 x 1 1/2	10 1/4
BT482R	64 x 54	2 1/2 x 2	10 1/4
BT483R	70 x 65	2 3/4 x 2 1/2	10 1/4
BT484R	90 x 76	3 1/2 x 3	10 1/4

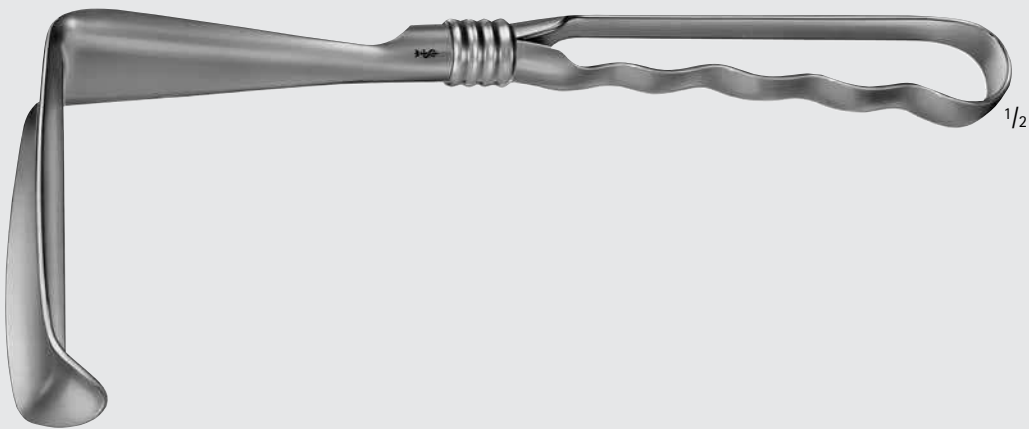

BT481R-BT484R



BT481R

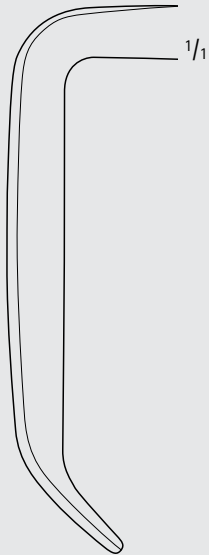

BT482R

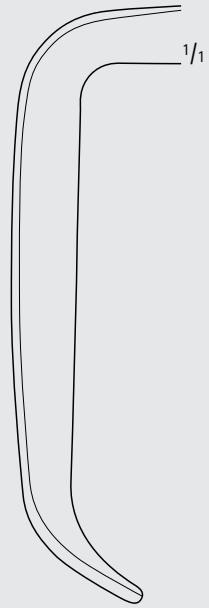

BT483R

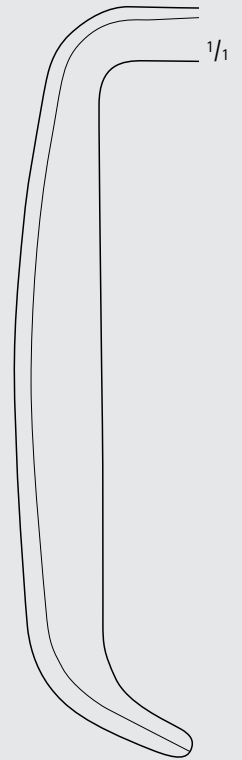

BT484R

SAUERBRUCH Retractor, Open

Catalog Number	Blade Size (mm)	Length (in.)
BT514R	130 x 38	10 1/4

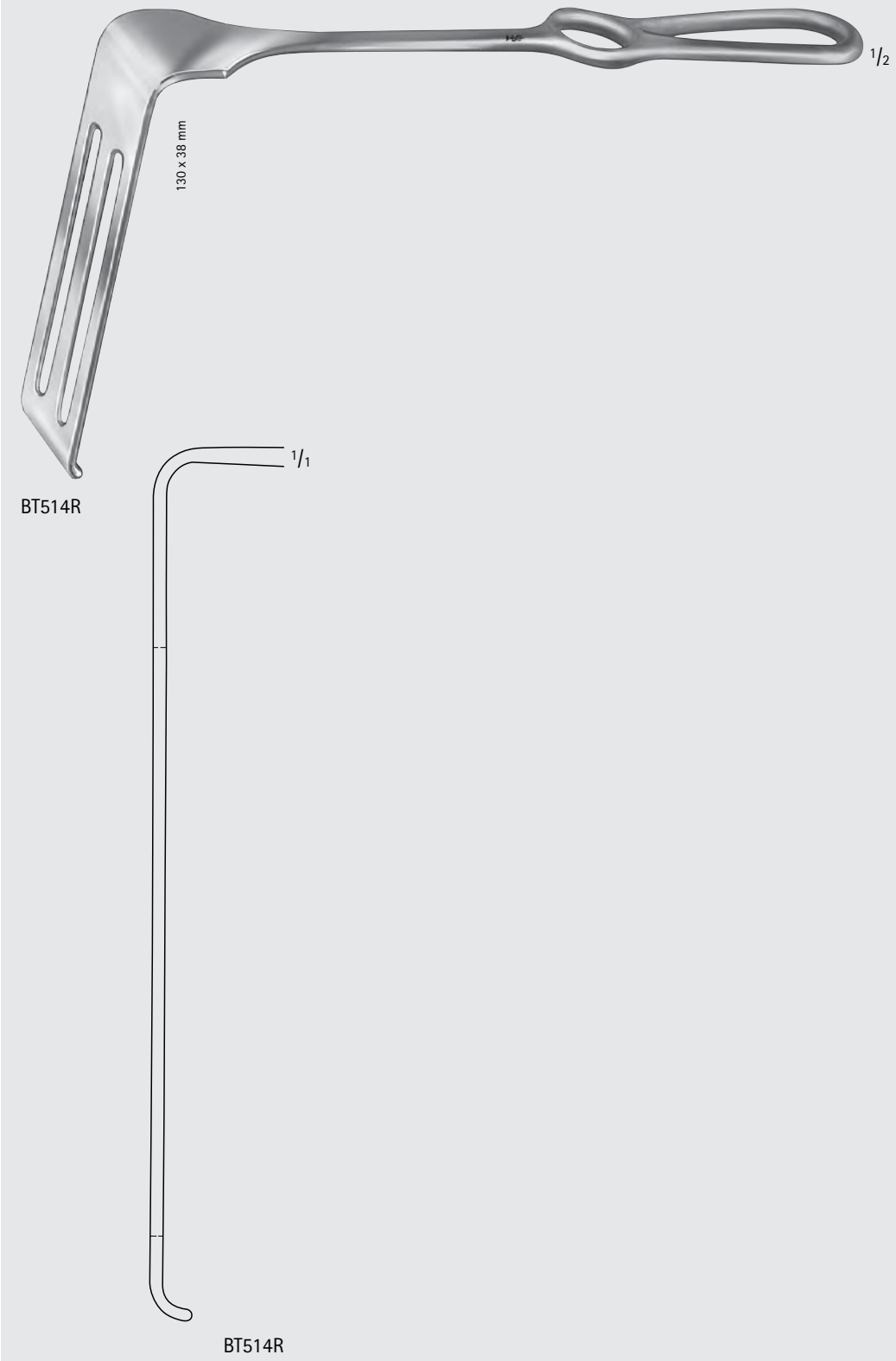

General Surgery
Abdominal Retractors

GENERAL
SURGERY



HARRINGTON Lung Spatula

Catalog Number	Blade Size (mm)	Blade End	Length (in.)
BT551R	123 x 45	FLEX	11 5/8
BT552R	123 x 64	FLEX	11 5/8
MB930R	190 x 115	FLEX	12 1/2



BT551R, BT552R, MB930R

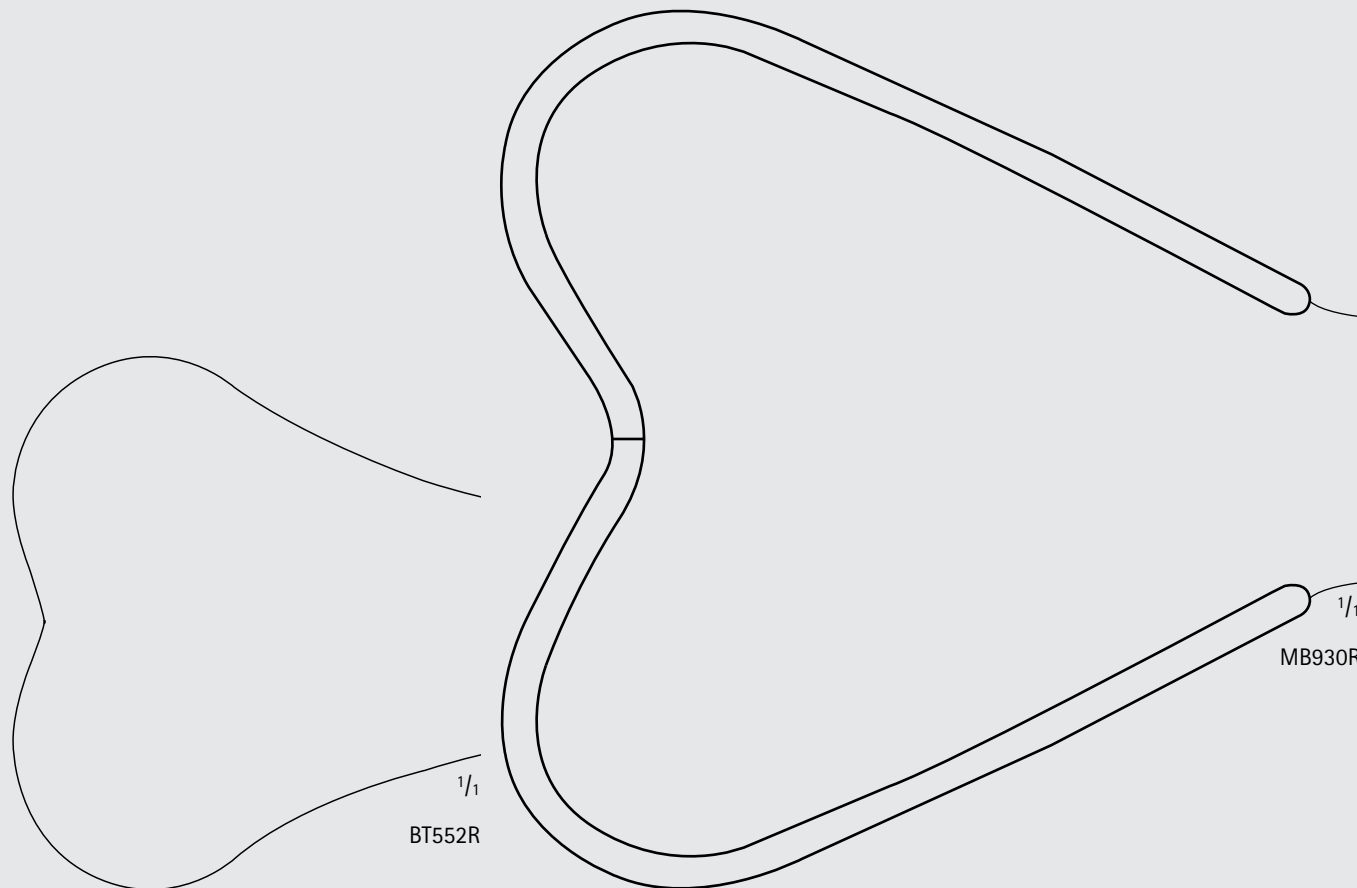
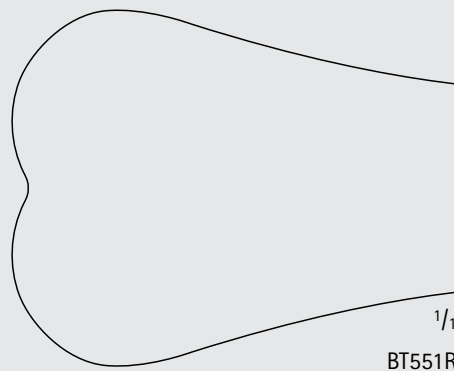

HARRINGTON Retractor, Large Blade

Catalog Number	Blade Size (mm)	Blade End	Length (in.)
MG472R	195 x 115	FLEX	14 3/8

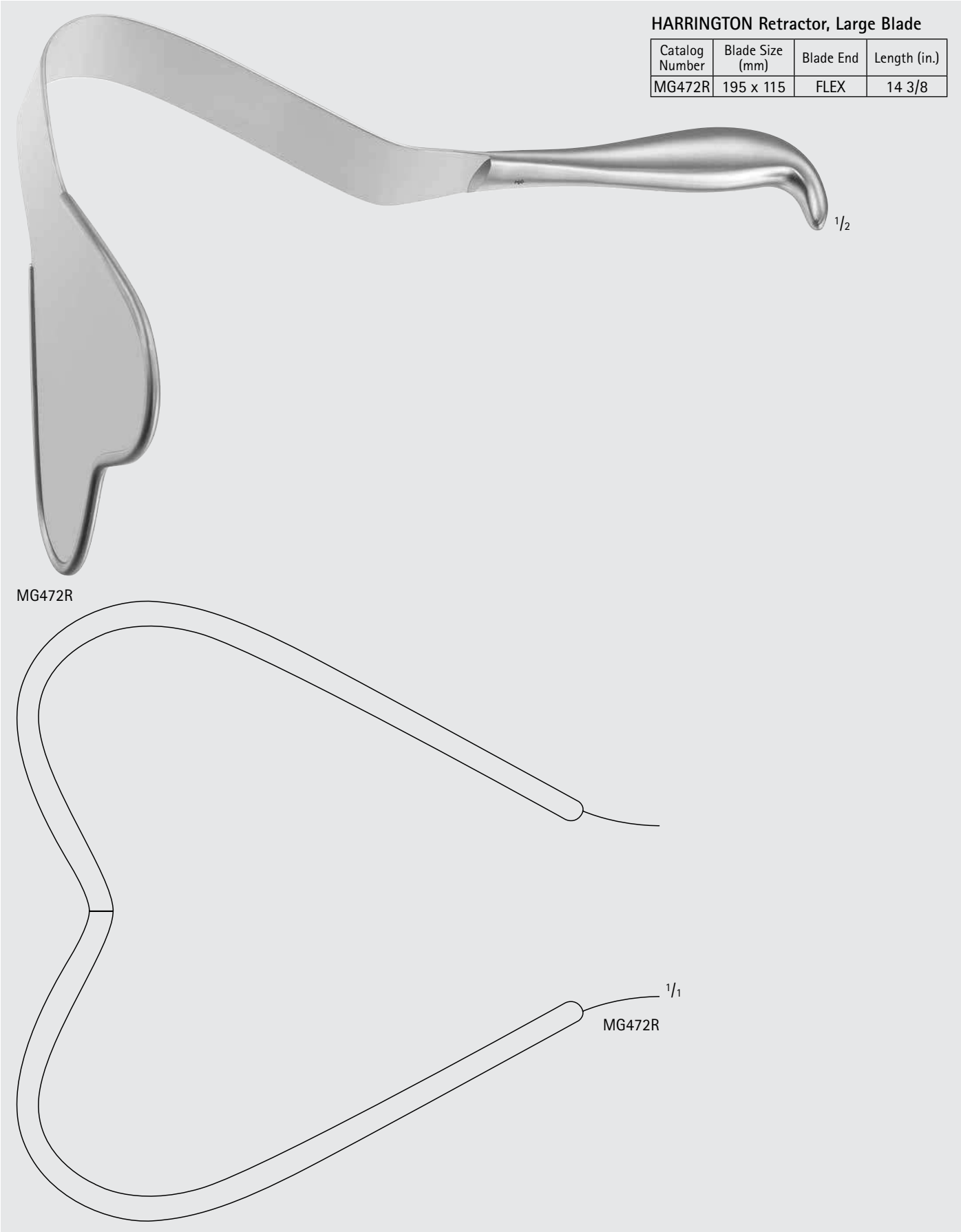

INCHES

General Surgery
Abdominal Retractors

GENERAL SURGERY

HARRINGTON-PEMBERTON Lung
Spatula

Catalog Number	Blade Size (mm)	Blade End	Length (in.)
BT553R	175 x 64	FLEX	11 5/8



BT553R

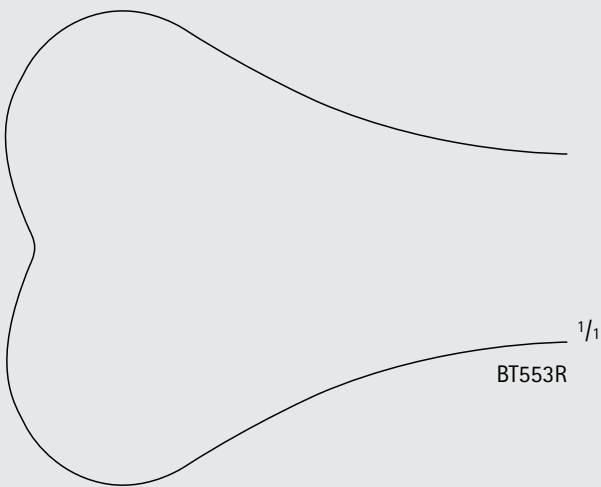

BT553R 1/1

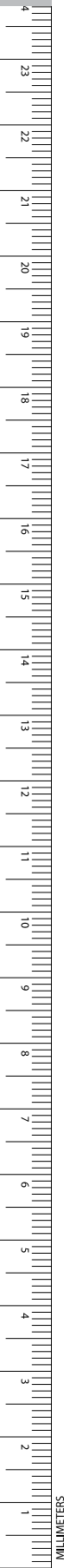

ZENKER Retractor

Catalog Number	Blade Size (mm)	Length (in.)
BT594R	36 x 8	9 1/2
BT595R	60 x 12	10
BT596R	75 x 12	10 5/8
BT597R	120 x 12	11 1/2



BT594R-BT597R

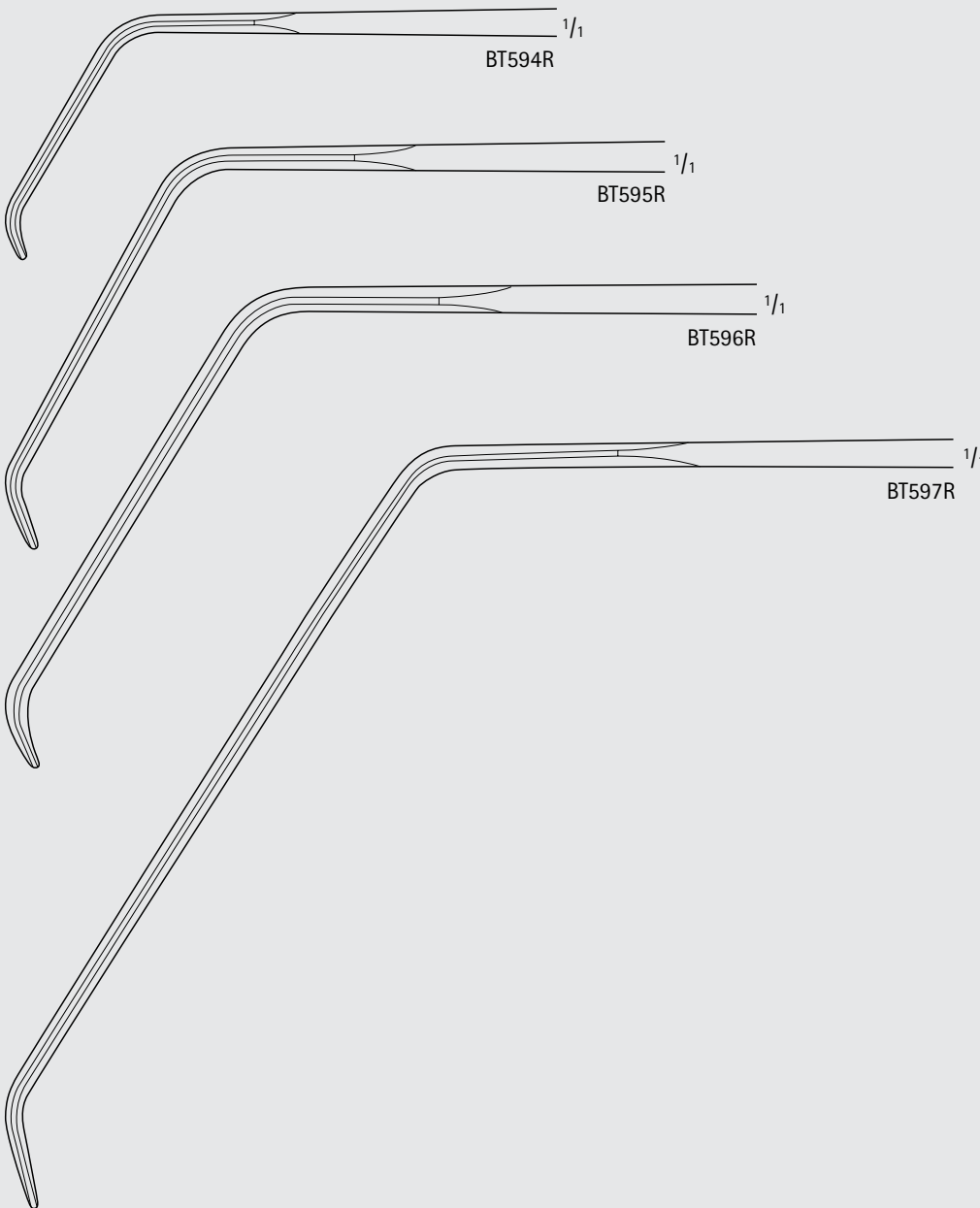

INCHES

General Surgery
Abdominal Retractors

GENERAL SURGERY

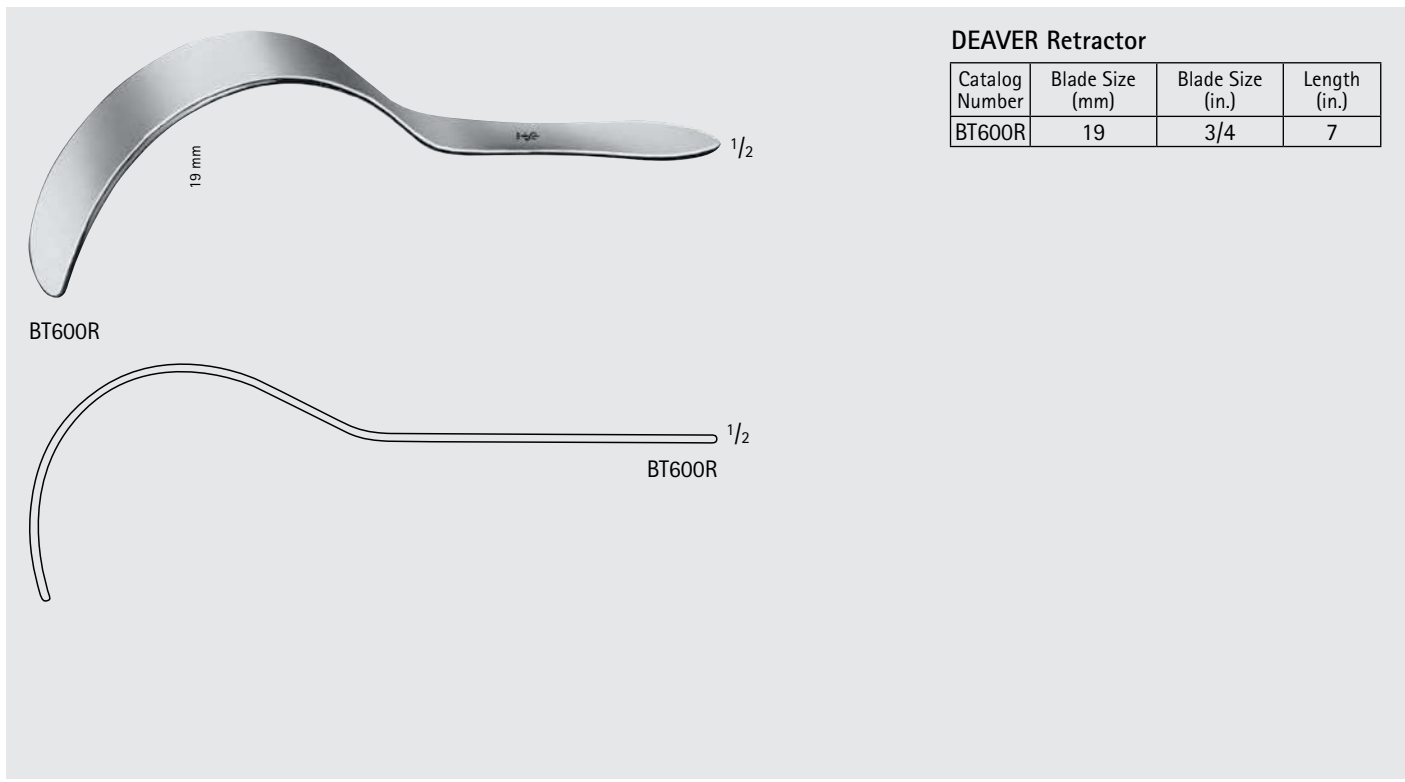

DEAVER Retractor

Catalog Number	Blade Size (mm)	Blade Size (in.)	Length (in.)
BT600R	19	3/4	7

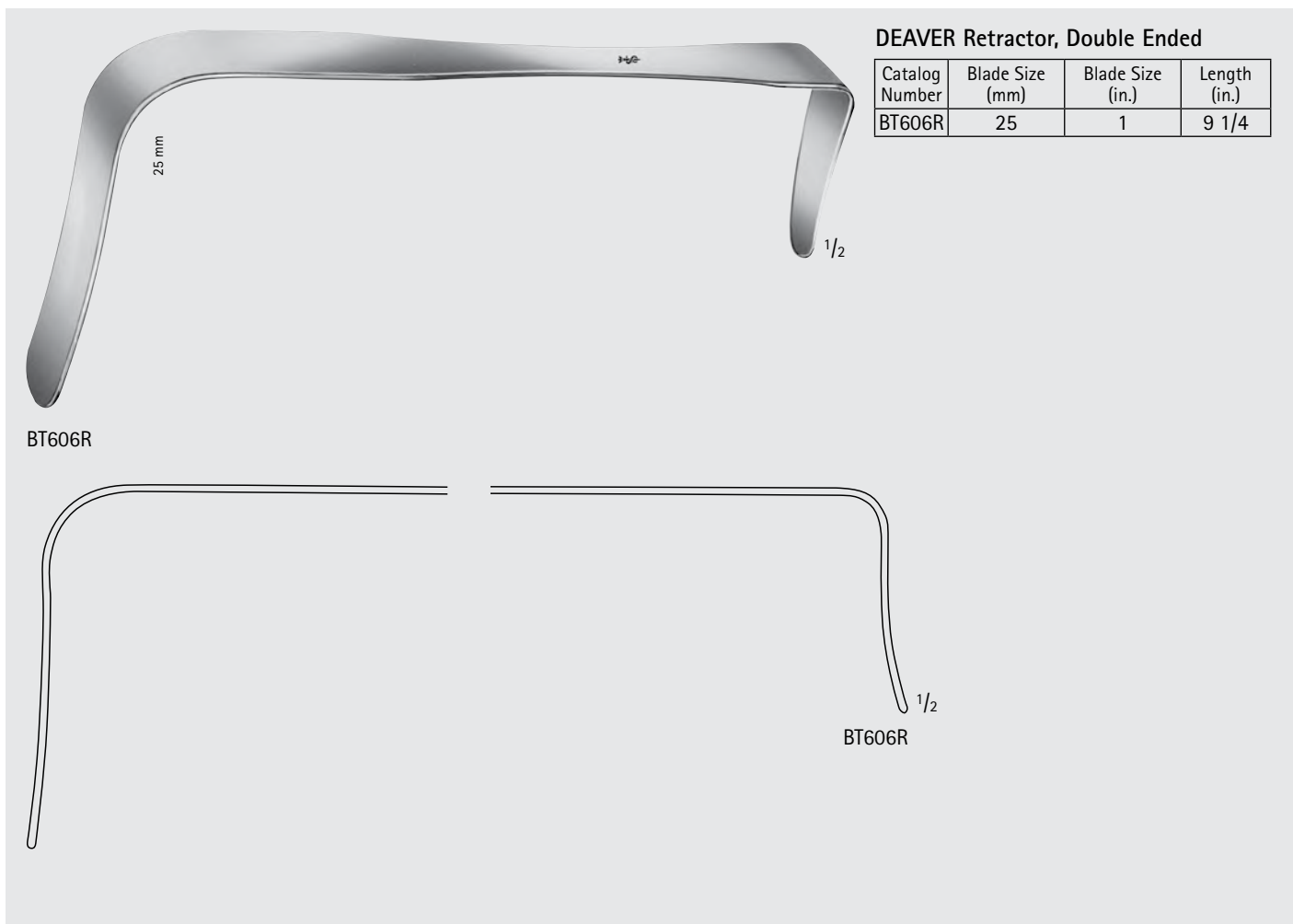

DEAVER Retractor, Double Ended

Catalog Number	Blade Size (mm)	Blade Size (in.)	Length (in.)
BT606R	25	1	9 1/4

DEAVER Retractor

Catalog Number	Blade Size (mm)	Blade Size (in.)	Length (in.)
BT601R	22	7/8	8 1/2
BT602R	25	1	11 3/4
BT603R	25	1	12 3/8



BT601R

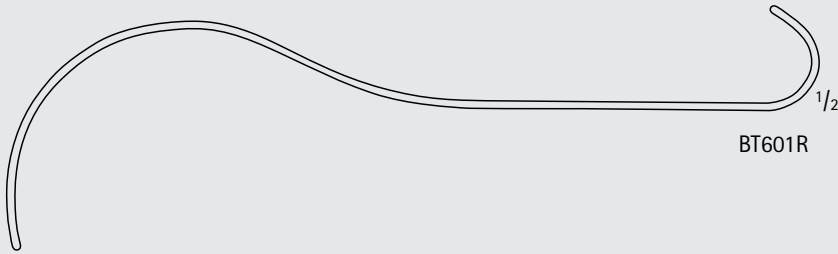

BT601R



BT602R-BT603R

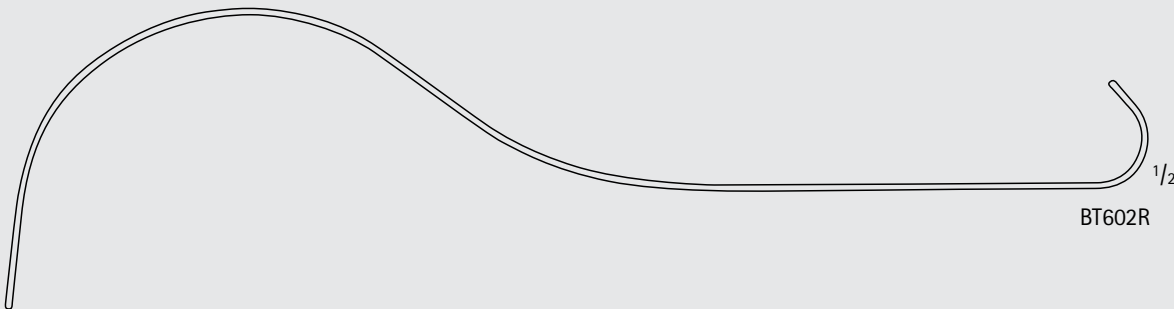

BT602R

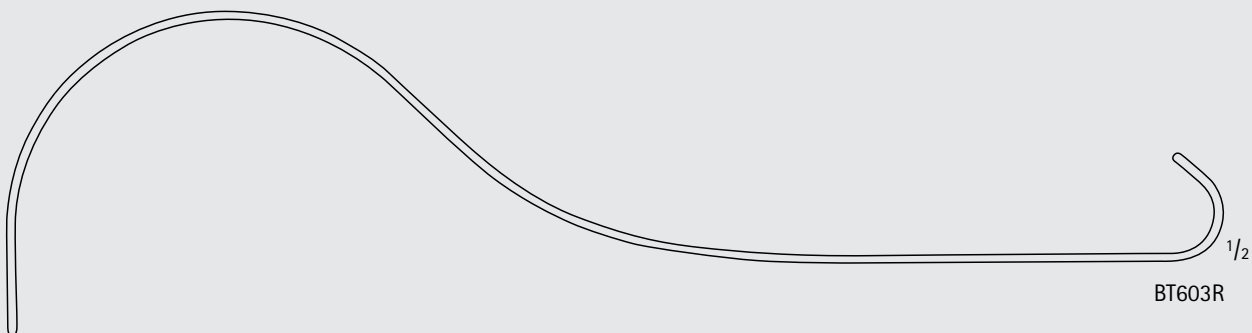

BT603R



INCHES

General Surgery
Abdominal Retractors

GENERAL
SURGERY

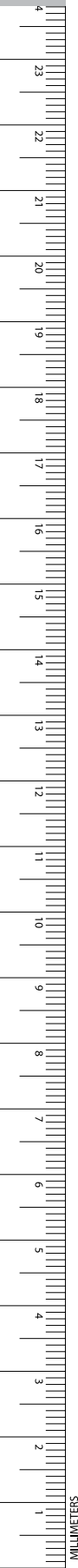

DEAVER Retractor
(continued)

Catalog Number	Blade Size (mm)	Blade Size (in.)	Length (in.)
BT604R	38	1 1/2	11 3/4

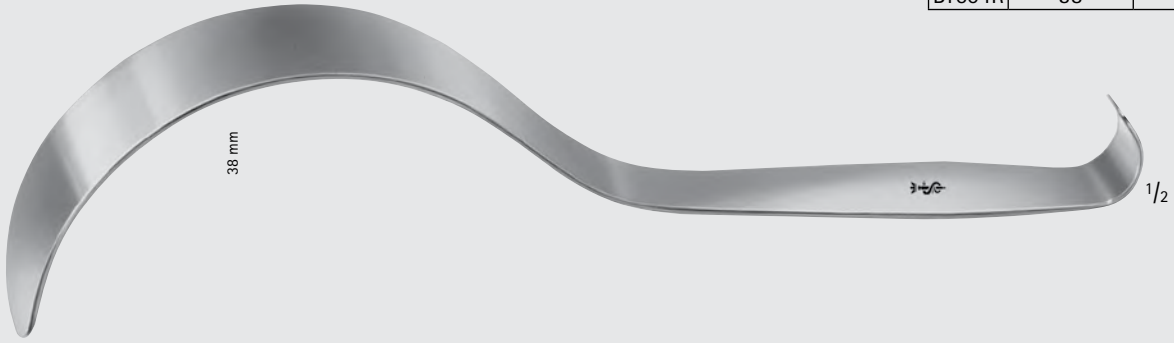

BT604R

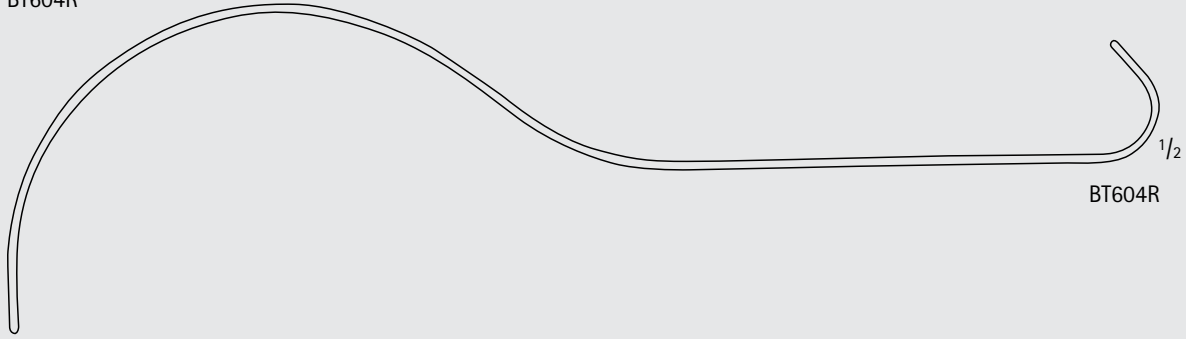

BT604R

DEAVER Retractor
(continued)

Catalog Number	Blade Size (mm)	Blade Size (in.)	Length (in.)
BT605R	50	2	12 1/4
BT607R	25	1	14 3/8



BT605R-BT607R

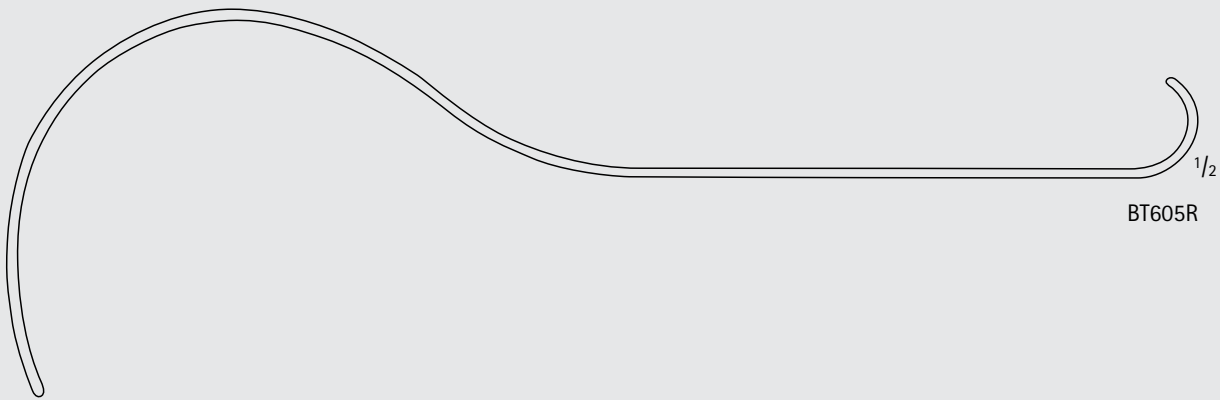

BT605R

1/2

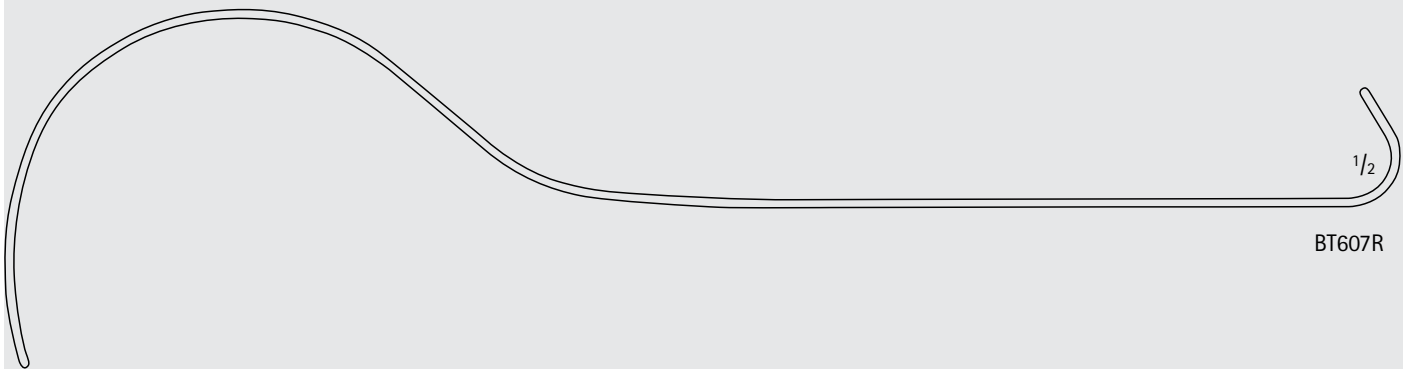

BT607R

1/2



INCHES

General Surgery
Abdominal Retractors

GENERAL
SURGERY



DEAVER Retractor
(continued)

Catalog Number	Blade Size (mm)	Blade Size (in.)	Length (in.)
BT608R	75	3	12 1/2

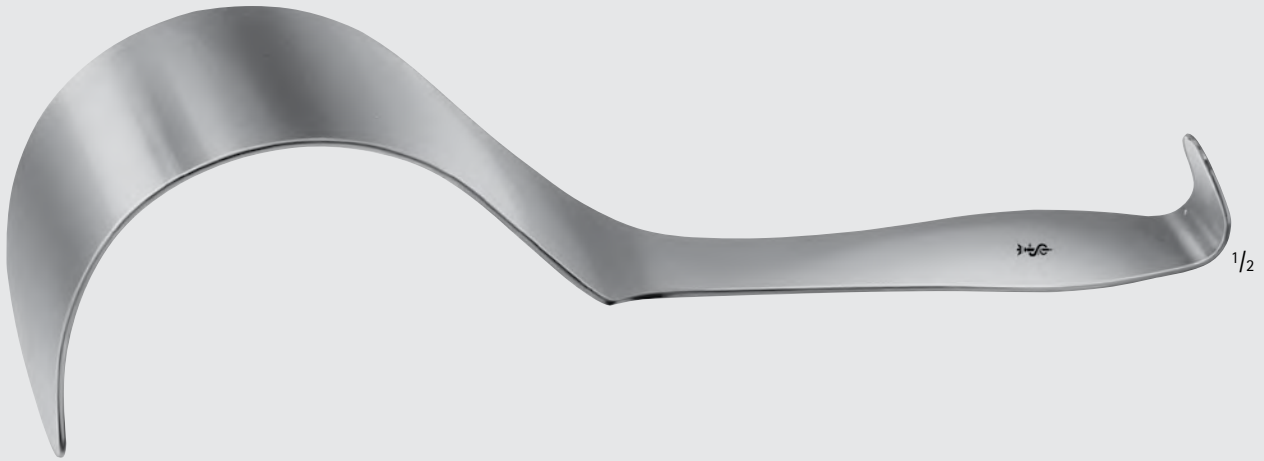

BT608R

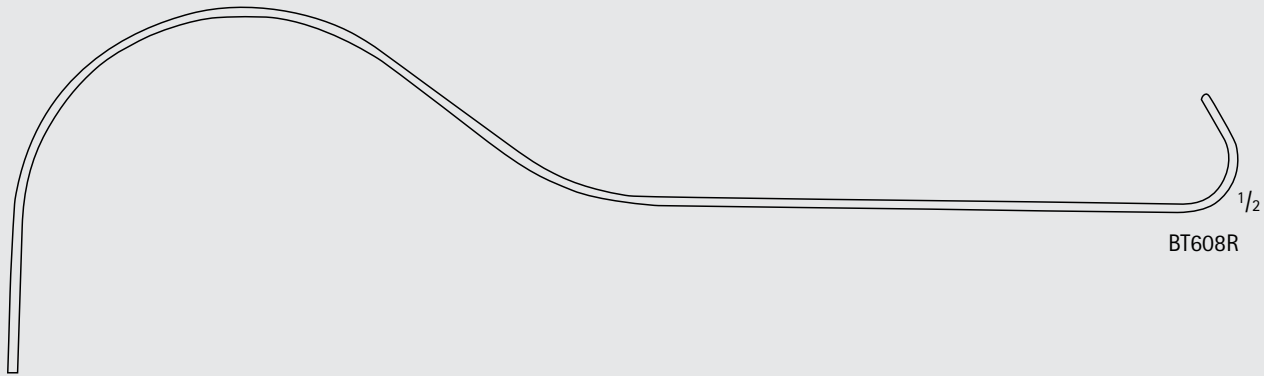

BT608R

DEAVER Retractor, W/ Grip

Catalog Number	Blade Size (mm)	Blade Size (in.)	Length (in.)
BT611R	25	1	12 1/4
BT613R	38	1 1/2	12 1/4
BT614R	50	2	12
BT615R	75	3	12 1/4



BT611R-BT615R

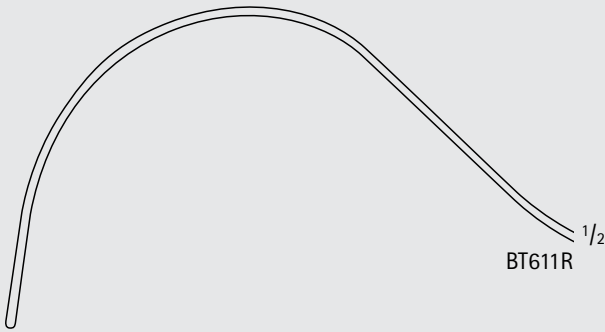

BT611R ^{1/2}

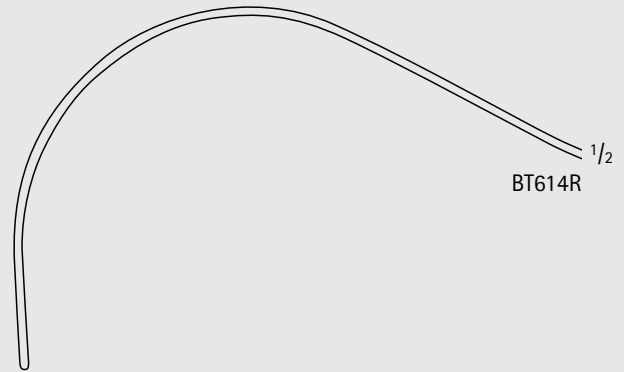

BT614R ^{1/2}

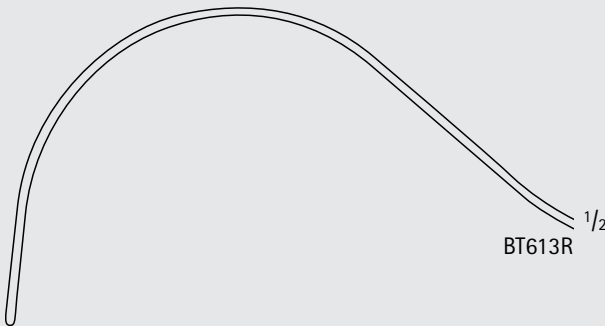

BT613R ^{1/2}

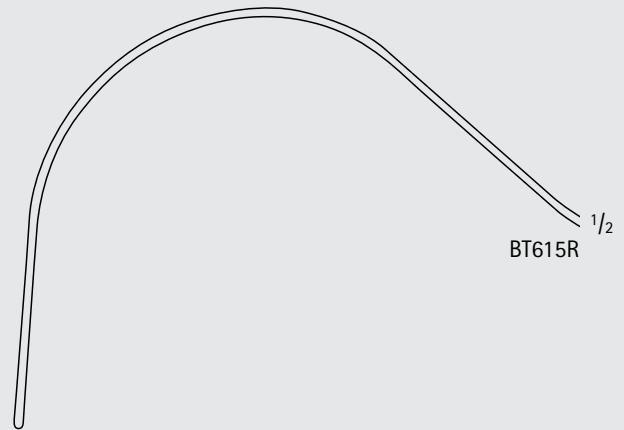

BT615R ^{1/2}



INCHES

General Surgery
Abdominal Retractors

GENERAL
SURGERY

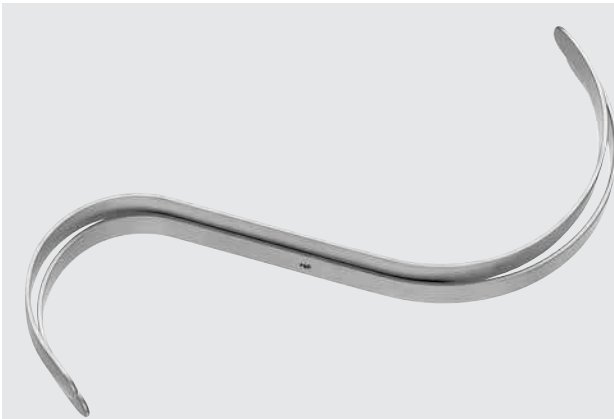
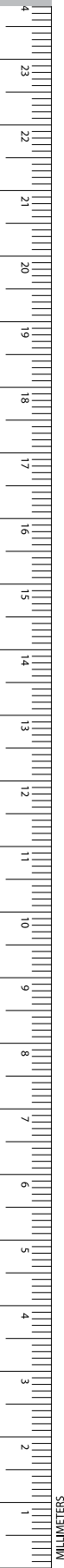

MD071R-MD076

HASSON "S" Retractor, 2/Set

Catalog Number	Blade	Blade Size (mm)	Length (in.)
MD076	MALLEABLE	10	6 1/4
MD077	MALLEABLE	13	7
MD071R	RIGID	10	7 1/8
MD072R	RIGID	13	7 1/8

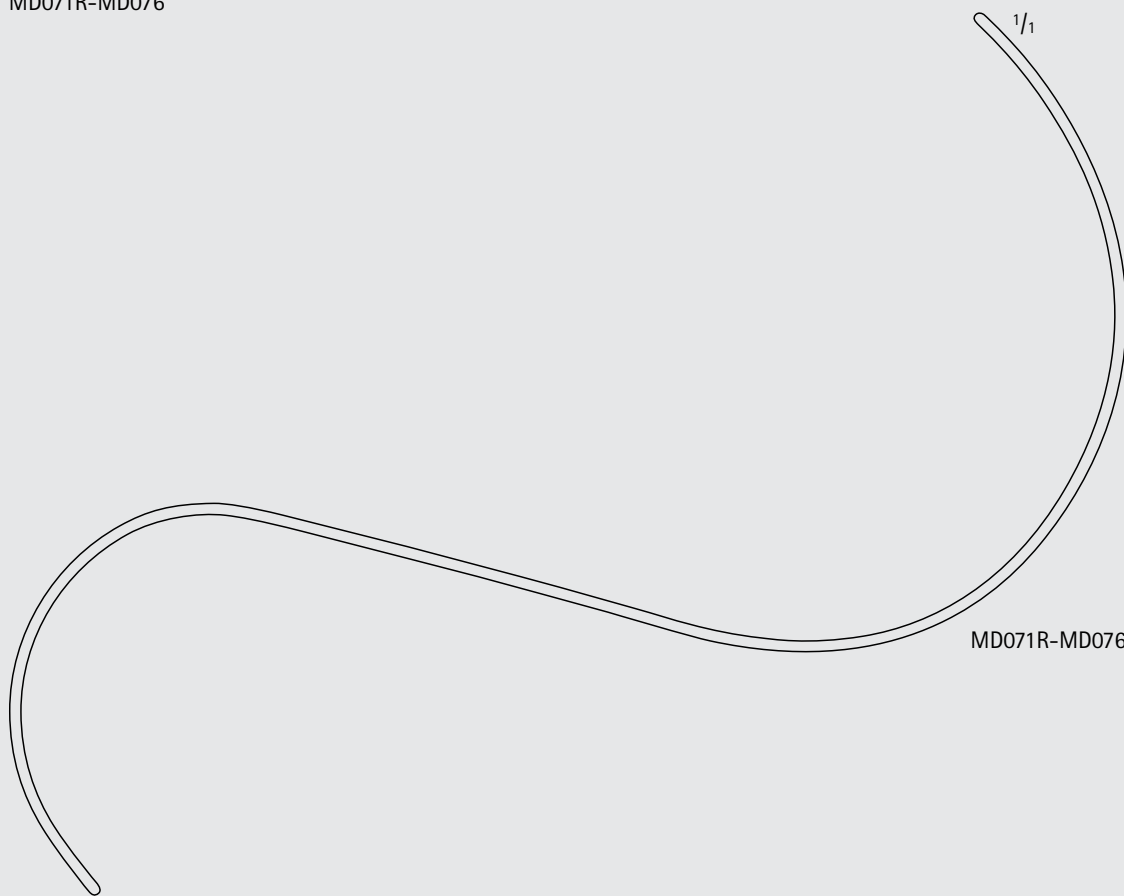

MD071R-MD076



BT750R

TUFFIER Spatula, Malleable

Catalog Number	Blade Size (mm)	Blade Size (in.)	Length (in.)
BT750R	17 / 25	3/4 / 1	7 7/8



BT751R-BT763R, MD498, MG480R-MG484R

Ribbon Spatula, Malleable

Catalog Number	Blade Size (mm)	Blade Size (in.)	Length (in.)
MG480R	5	1/8	8
BT751R	12	1/2	7 7/8
BT752R	17	3/4	7 7/8
MG481R	25	1	8
BT755R	25	1	9 3/4
MD498	75	3	13
MG482R	20	3/4	13
BT756R	25	1	13
BT761R	30	1 1/4	13
BT762R	40	1 1/2	13
BT763R	50	2	13
MG483R	65	2 1/2	13
MG484R	100	4	13



BT758R

HABERER Spatula, Malleable

Catalog Number	Blade Size (mm)	Blade Size (in.)	Length (in.)
BT758R	40 / 50	1 1/2 / 2	12



MG374R



MG374R

Spatula and Packer, Double Ended

Catalog Number	Length (in.)
MG374R	5 3/4

General Surgery
Abdominal Retractors

GENERAL
SURGERY



DOYEN Abdominal Retractor

Catalog Number	Blade Size (mm)	Length (in.)
BT667R	53 x 80	9 3/4
BT669R	72 x 82	10 1/4



BT667R



BT669R

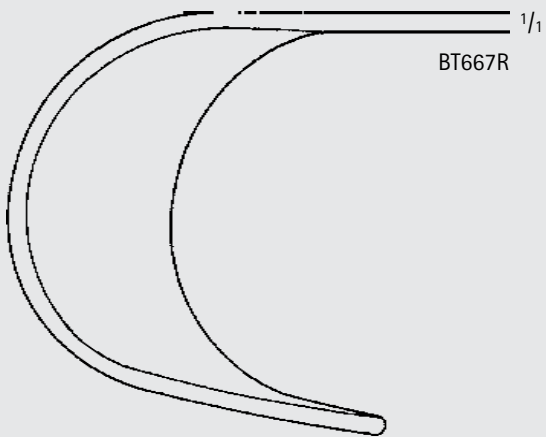

BT667R

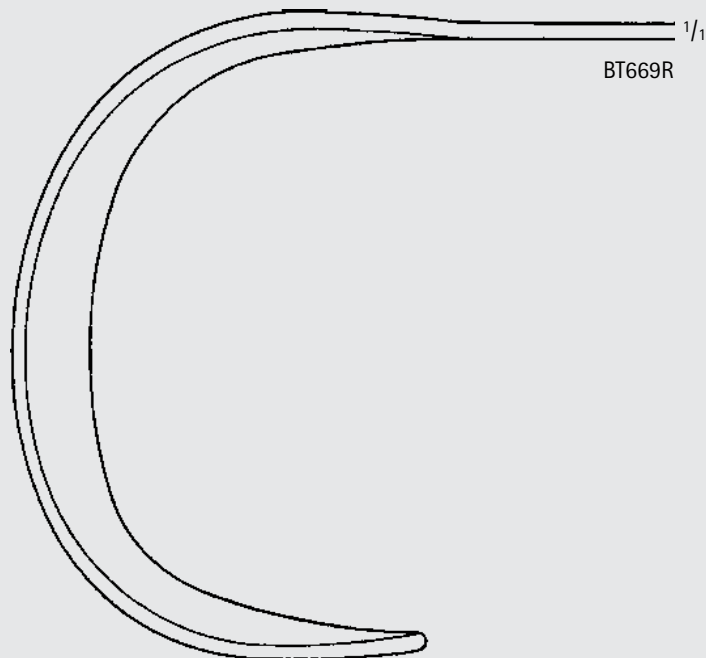

BT669R

**WEINBERG Vagotomy Retractor, Joe's
Hoe**

Catalog Number	Blade Size (mm)	Length (in.)
MG491R	47 x 57 / 93 x 157	9

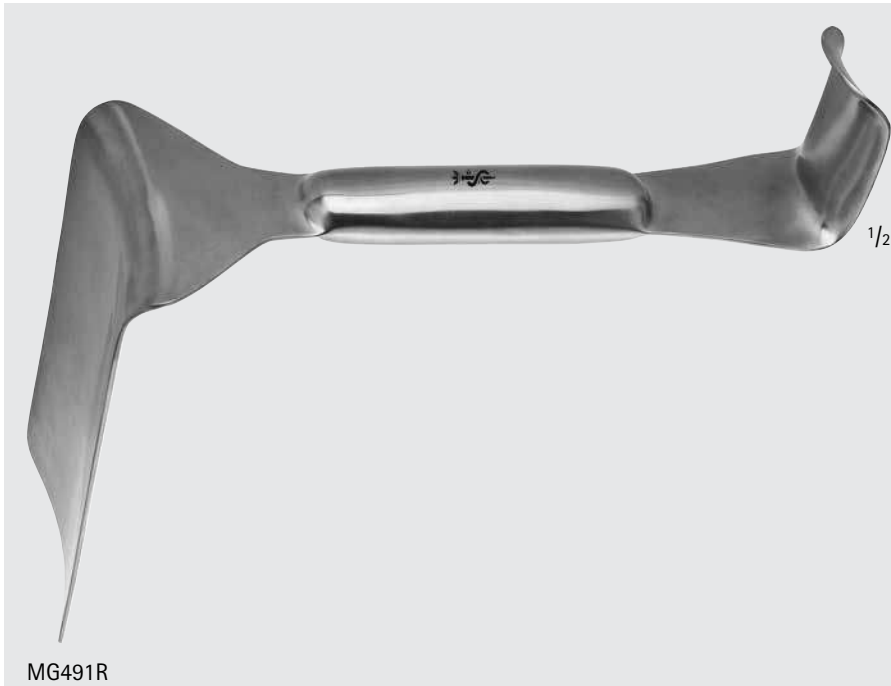

General Surgery
Abdominal Retractors

GENERAL SURGERY

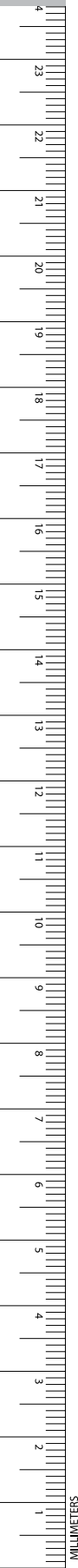

ST. MARKS Pelvis Retractor

Catalog Number	Blade Size (mm)	Length (in.)
BT670R	124 x 60	11 1/2
BT672R	174 x 60	13

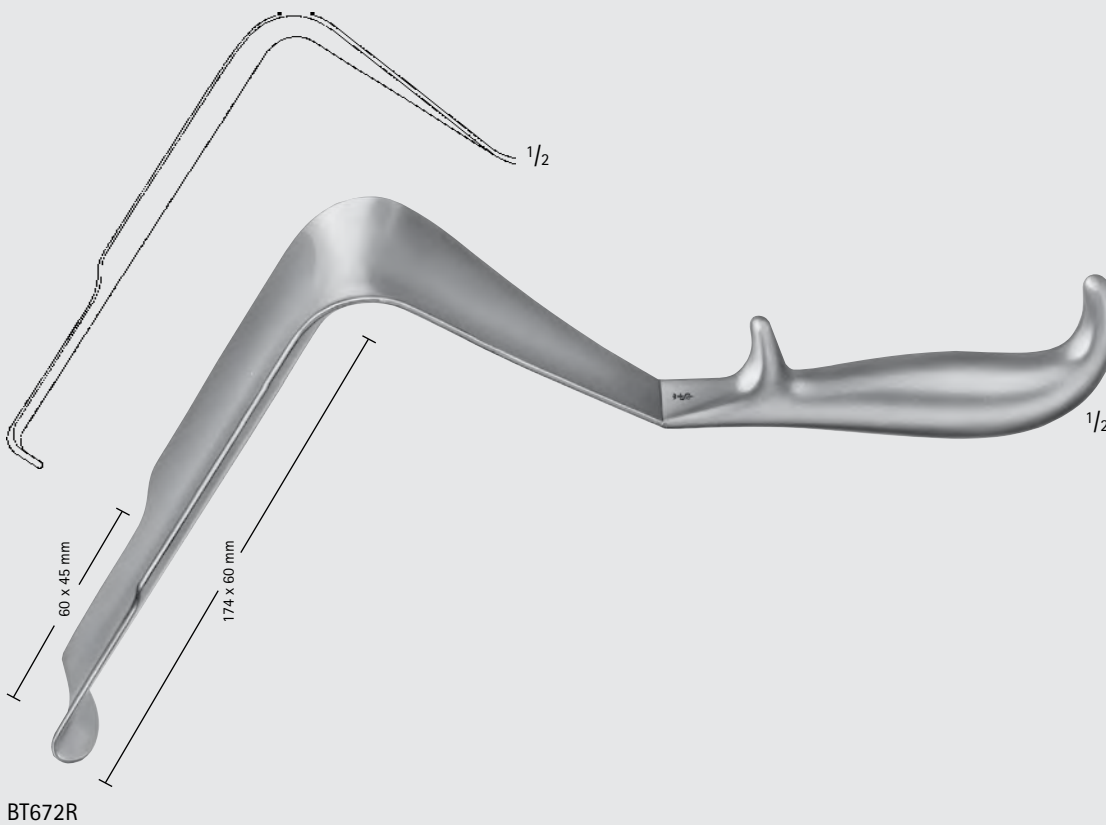
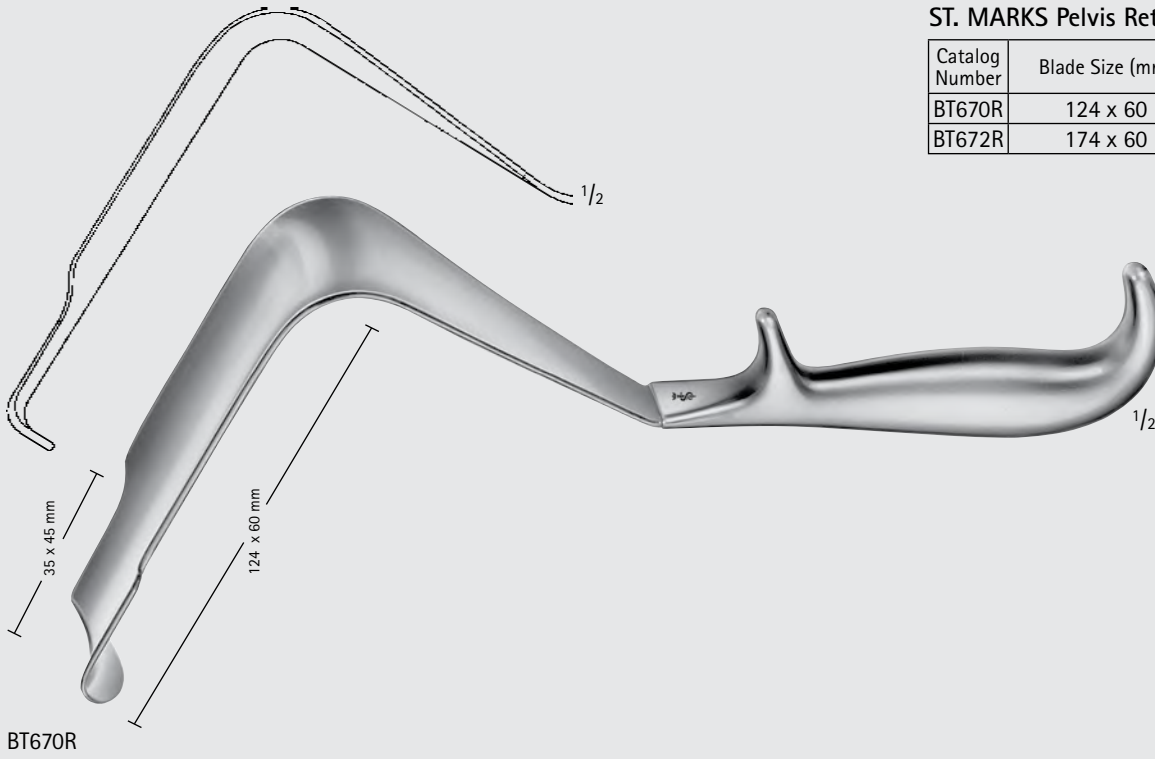

ST. MARKS Pelvis Retractor
(continued)

Catalog Number	Blade Size (mm)	Length (in.)
BT674R	178 x 60	13

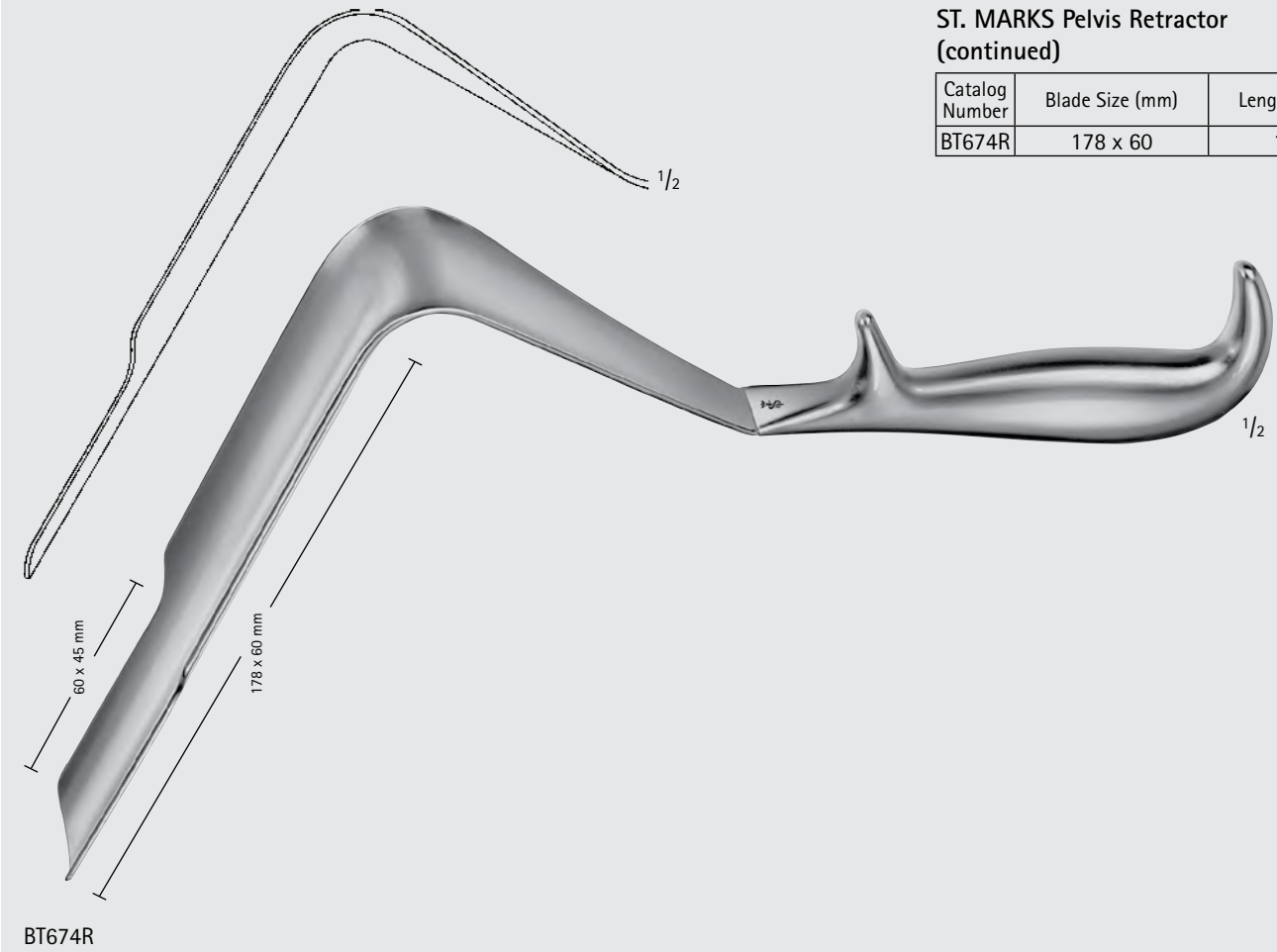

General Surgery
Abdominal Retractors

GENERAL SURGERY

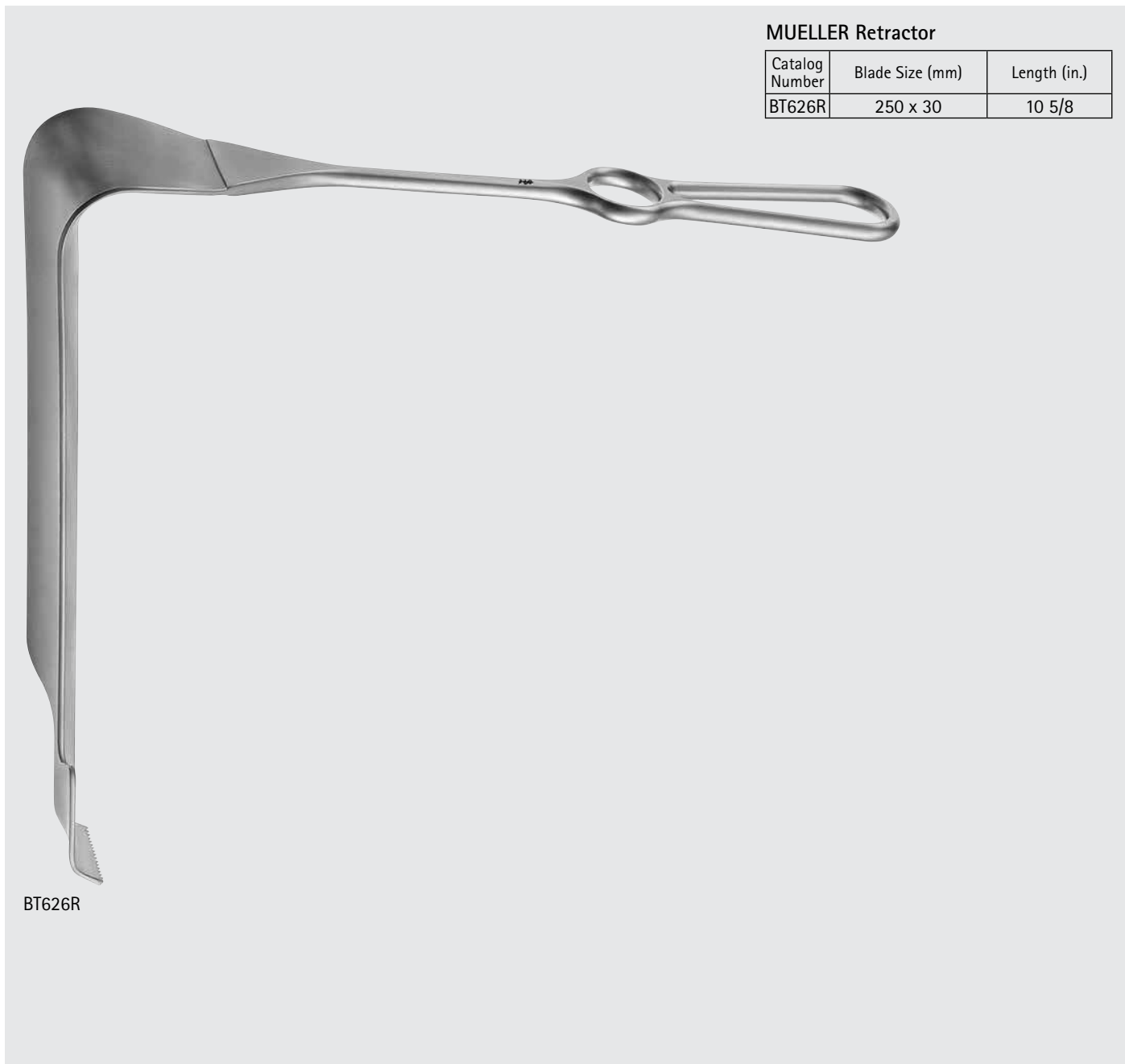

MUELLER Retractor

Catalog Number	Blade Size (mm)	Length (in.)
BT626R	250 x 30	10 5/8

BT626R



MAYO-COLLINS Appendectomy Retractor

Catalog Number	Length (in.)
MB129R	6 3/4

MB129R

1/2

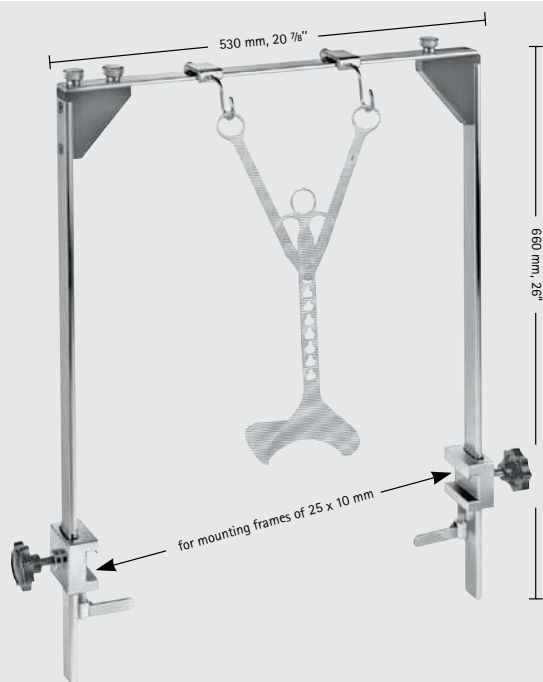

ROCHARD Retractor Mounting Frame, F/ BT711R-BT715R

Catalog Number	Mounting Arms
BT708R	DOUBLE
BT709R	SINGLE

Mounting frame for fastening to the lateral bars of the operating tables, can be dismantled for decontamination and sterilization.

BT708R-BT709R

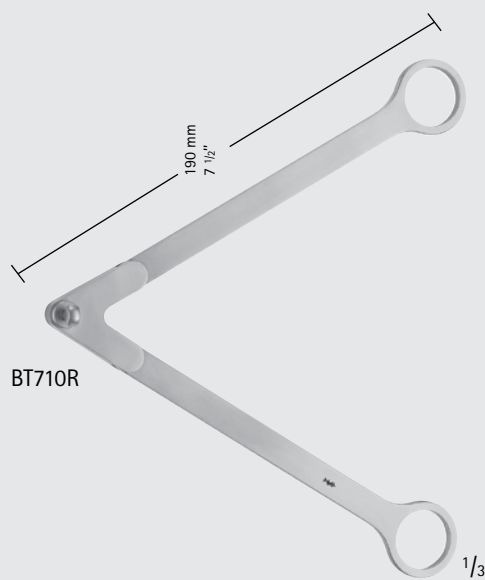

ROCHARD Fixation Device, F/ BT711R-BT715R

Catalog Number	Length (mm)	Length (in.)
BT710R	190	7 1/2

BT710R

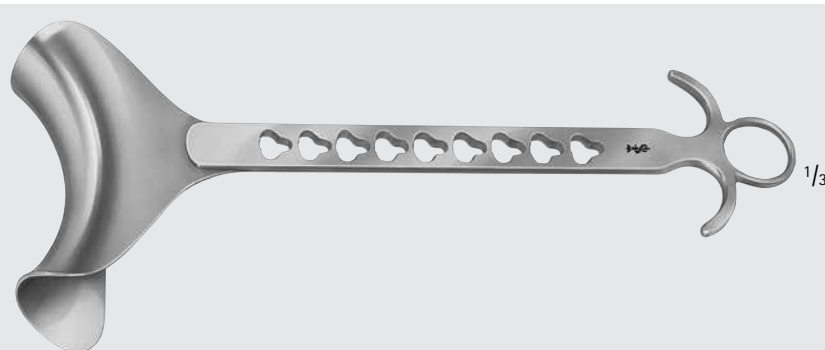

ROCHARD Blades

Catalog Number	Blade Size (mm)	Length (in.)
BT711R	48 x 90	12 1/4
BT712R	48 x 105	12 1/4
BT713R	48 x 120	12 1/4
BT714R	48 x 135	12 1/4
BT715R	48 x 155	12 1/4

BT711R-BT715R



General Surgery
Abdominal Retractors

Abdominal Retractor, Malleable,
W/ Handle

Catalog Number	Blade Size (mm)	Blade Size (in.)	Length (in.)
BT773R	30	1 1/4	16 1/8
BT774R	40	1 1/2	16 1/8
BT775R	50	2	16 1/8
BT776R	60	2 1/2	16 1/8
BT777R	70	2 3/4	16 1/8



BT773R-BT777R ^{1/3}

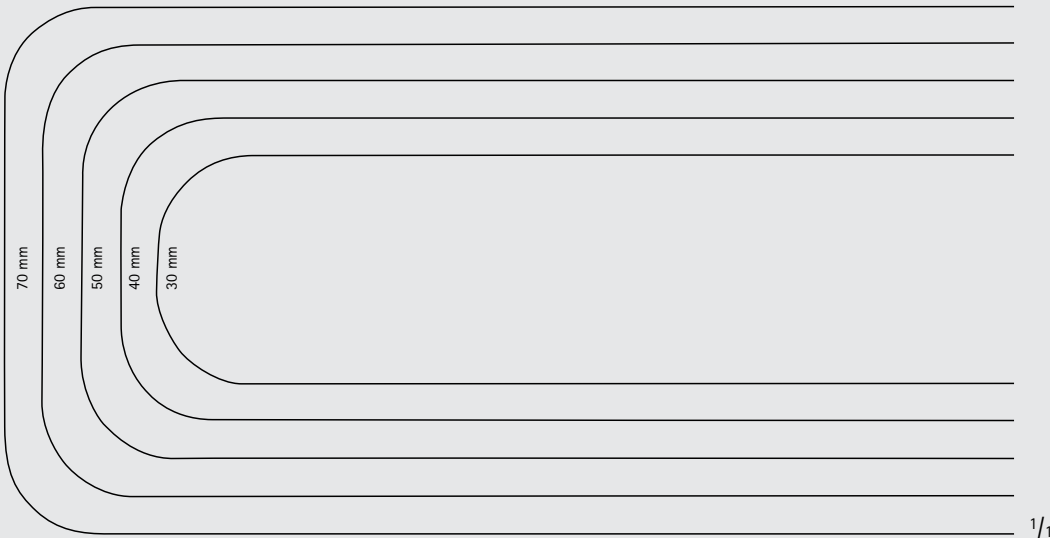

BT773R-BT777R ^{1/1}

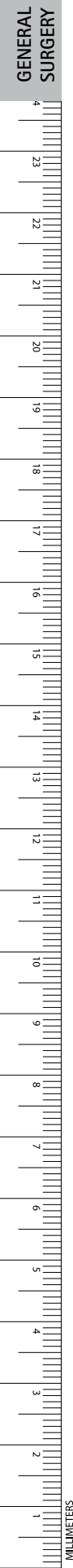



MB226, MG582R-MG586R

Laparotomy Ring

Catalog Number	Diameter (in.)
MG582R	1 1/2
MG585R	1 3/4
MB226	2
MG586R	3

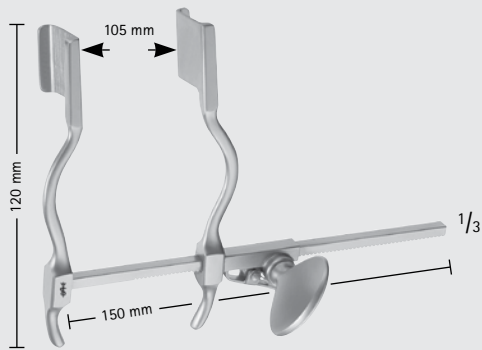

BV512R

HERTZLER Abdominal Retractor

Catalog Number	Blade Size (mm)
BV512R	20 x 25



General Surgery

Abdominal Retractors

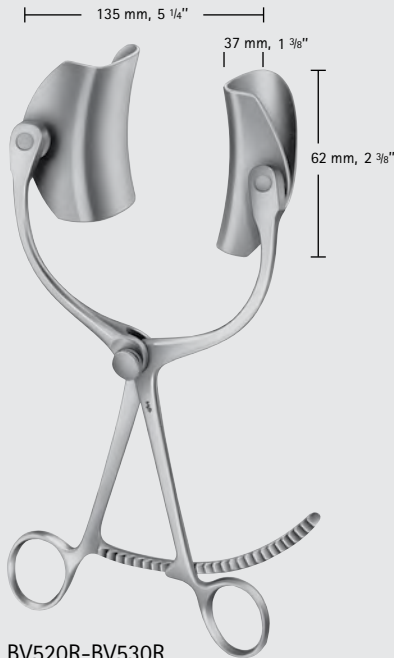

BV520R-BV530R



BV551R

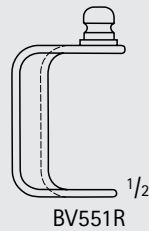

BV551R

COLLIN Abdominal Retractor W/ Ball Snap Closure

Catalog Number	Description
BV530R	SET COMPLETE
BV520R	SPREADER ONLY
BV551R	LATERAL BLADES, Pair, 37 x 62 MM



BV399R

Blade Ejector

Catalog Number	Description	Length (in.)
BV399R	FOR CHANGING BLADES WITH BALL SNAP CLOSURE	4 1/2

GENERAL SURGERY



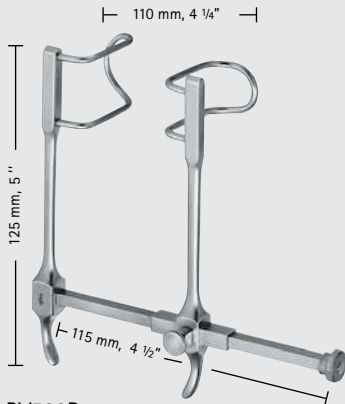

GOSSET Abdominal Retractor, Small

Catalog Number	Blade Depth (mm)
BV500R	38

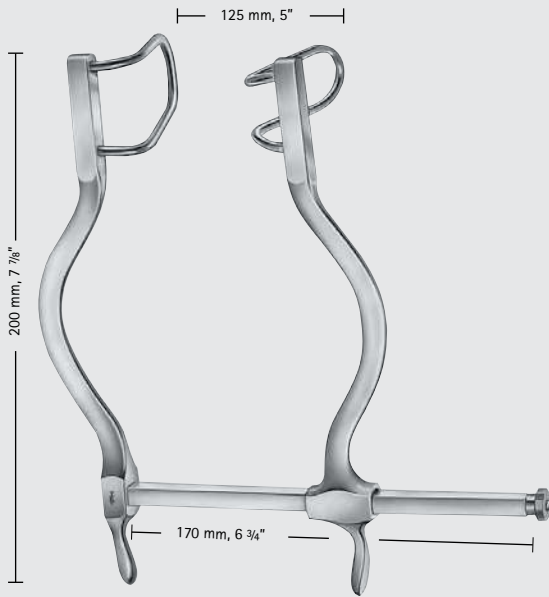

GOSSET Abdominal Retractor, Medium

Catalog Number	Blade Depth (mm)
BV502R	55



INCHES

General Surgery

Abdominal Retractors

GENERAL SURGERY

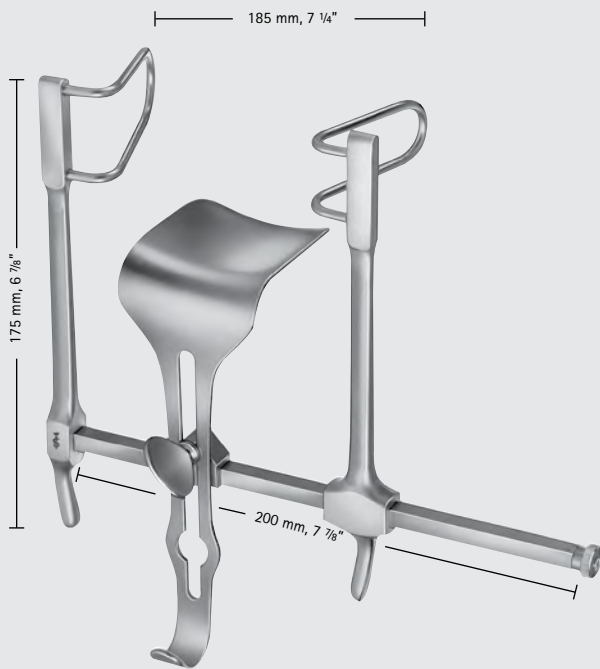

BV505R-BV506R

GOSSET Abdominal Retractor, Large

Catalog Number	Description
BV505R	SET COMPLETE
BV506R	CENTER BLADE ONLY 59 x 57 MM

BV505R Includes:
1 Center Blade BV506R

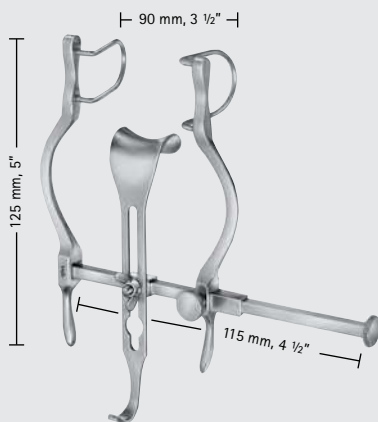

BV601R-BV602R

BALFOUR Baby Abdominal Retractor

Catalog Number	Description
BV601R	SET COMPLETE
BV602R	CENTER BLADE ONLY, 21 x 24 MM

BV601R Includes:
1 Center Blade BV602R

BALFOUR Abdominal Retractor

Catalog Number	Description	Lateral Blades Depth (mm)
BV605R	BALFOUR RETRACTOR, 200 x 155 MM	60
BV608R	BALFOUR RETRACTOR, 200 x 235 MM	60
BV610R	BALFOUR RETRACTOR, 200 x 265 MM	90
BV606R	CENTER BLADE, 47 x 80 MM	-
BV609R	CENTER BLADE, 62 x 76 MM	-
BV611R	CENTER BLADE, 80 x 80 MM	-

BV605R includes BV606R
 BV608R includes BV609R
 BV610R includes BV611R

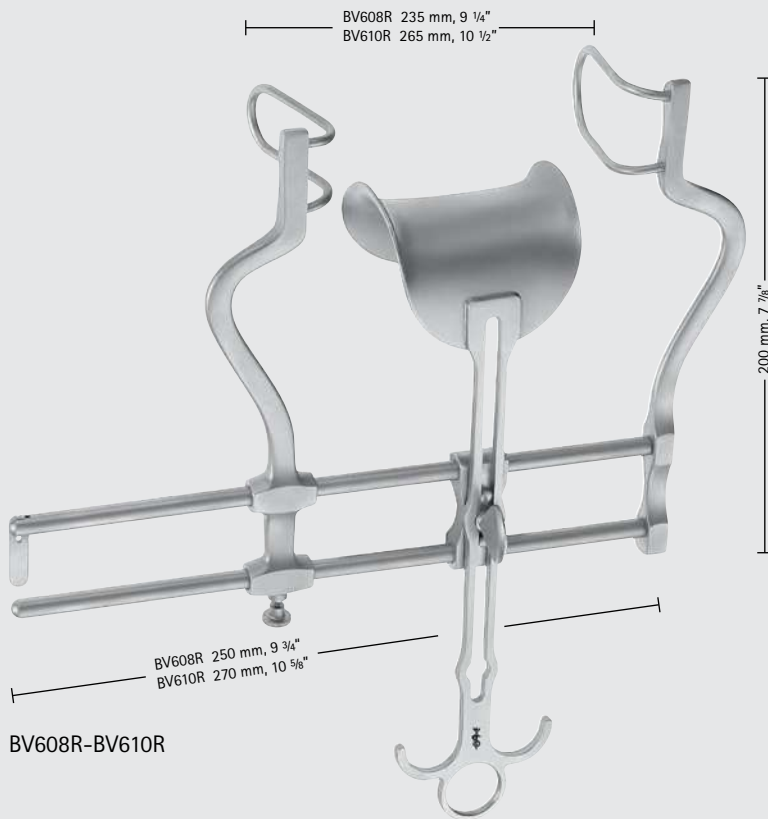
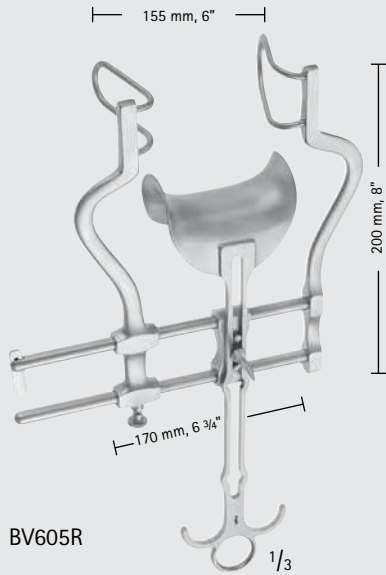

General Surgery

Abdominal Retractors

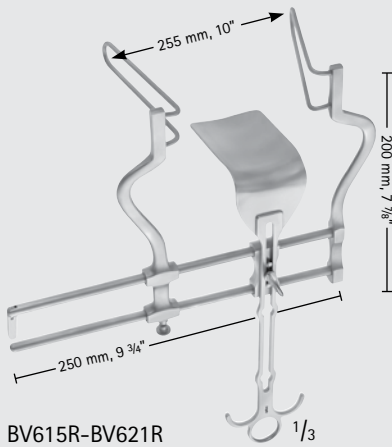

BV615R-BV621R 1/3

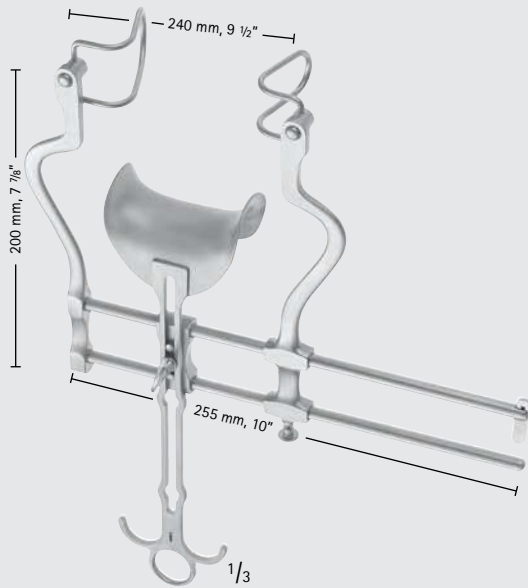

BV632R-BV638R 1/3

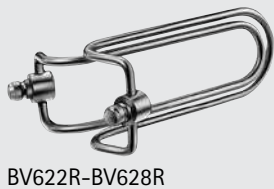

BV622R-BV628R

BALFOUR Abdominal Retractor (continued)

Catalog Number	Description
BV615R	BALFOUR RETRACTOR, 200 x 255 MM COMPLETE W/ BV616R
BV632R	BALFOUR RETRACTOR, COMPLETE W/ BV606R, BV621R, BV622R
BV634R	BALFOUR RETRACTOR, COMPLETE W / BV609R, BV621R, BV624R
BV636R	BALFOUR RETRACTOR, COMPLETE W/ BV611R, BV621R, BV626R
BV638R	BALFOUR RETRACTOR, COMPLETE W/ BV611R, BV621R, BV628R
BV616R	CENTER BLADE, 107 x 59 MM
BV621R	SPREADER ONLY, 200 x 250 MM
BV622R	LATERAL BLADE, PAIR 50 MM
BV624R	LATERAL BLADE, PAIR 60 MM
BV626R	LATERAL BLADE, PAIR 75 MM
BV628R	LATERAL BLADE, PAIR 90 MM

GENERAL SURGERY



**BALFOUR Side Blade Solid
F/ Retractor MB221R, MB222R**

Catalog Number	Description
MB637R	PAIR, 2 1/2" (64 MM) DEEP
MB638R	PAIR, 3 1/2" (89 MM) DEEP
MB639R	PAIR, 4" (102 MM) DEEP



MB637R



MB638R



MB639R

**BALFOUR Side Blade Wire
F/ Retractor MB221R, MB222R**

Catalog Number	Description
MB577R	PAIR, 2 1/2" (64 MM) DEEP
MB578R	PAIR, 3 1/2" (89 MM) DEEP
MB579R	PAIR, 4" (102 MM) DEEP



MB577R



MB578R

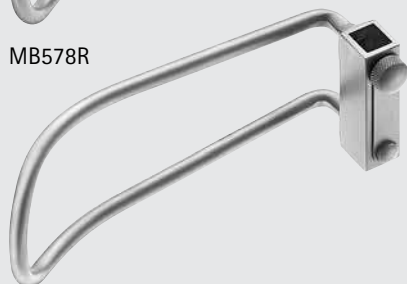

MB579R



General Surgery
Abdominal Retractors

GENERAL SURGERY

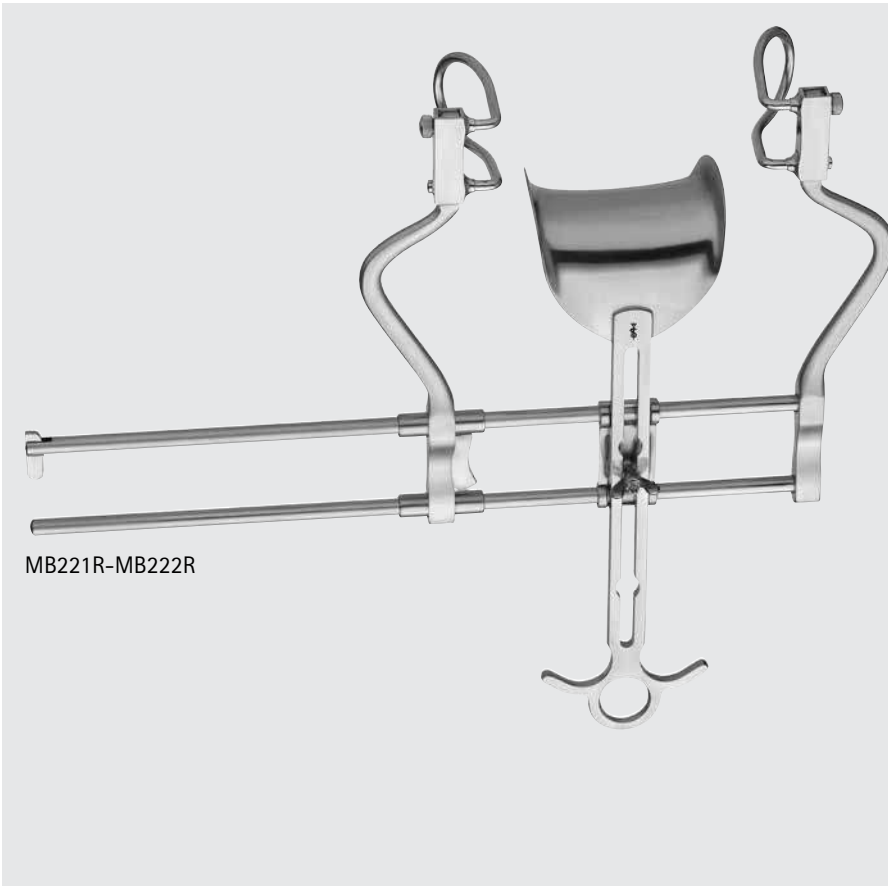
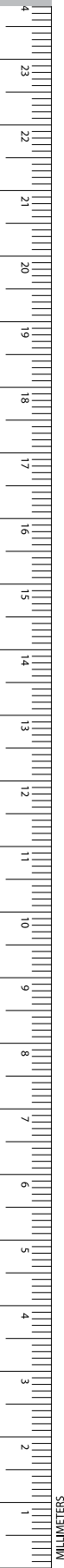

MB221R-MB222R

BALFOUR Retractor W/ Exchangeable Lateral Blades

Catalog Number	Total Width (in.)	Opening Width (in.)	Description
MB221R	16	10 1/2	2 PAIRS OF DETACHABLE BLADES 2 1/2" AND 3 1/2", 1 CENTER BLADE 2 3/4" x 3 1/4"
MB222R	16	8 1/2	2 PAIRS OF DETACHABLE BLADES 2 1/2" AND 3 1/2", 1 CENTER BLADE 2 1/2" x 2 1/2"

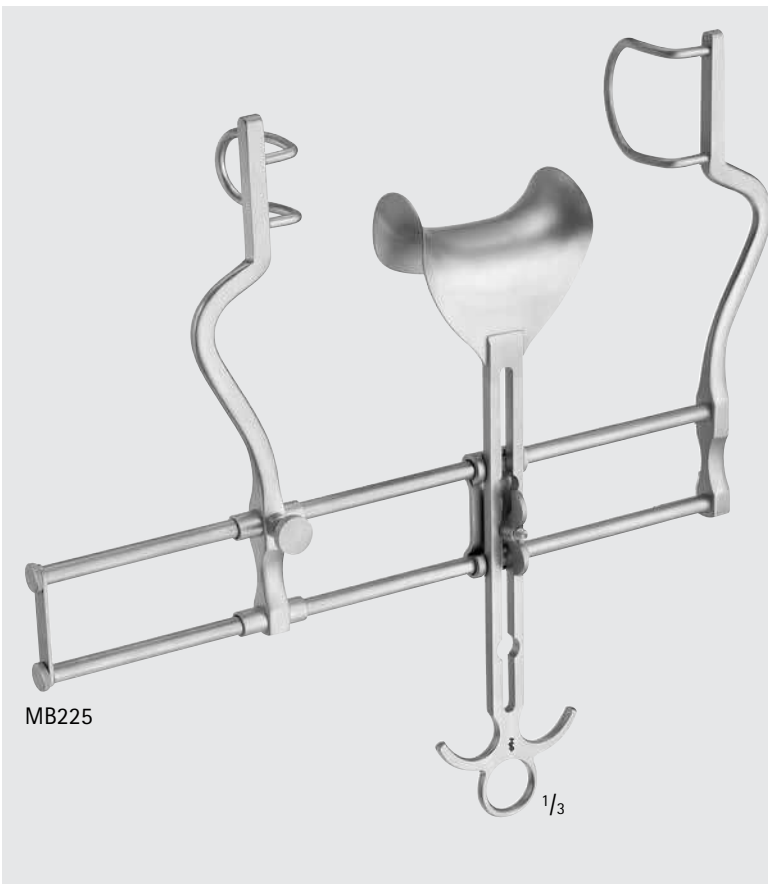

MB225

1/3

BALFOUR Retractor

Catalog Number	Total Width (in.)	Opening Width (in.)	Description
MB225	13	11	2 LATERAL BLADES 2" x 2" AND 1 1/4" x 2", 1 CENTER BLADE 3" x 10 1/2"



MB573R-MB574R

DIXON Center Blade

Catalog Number	Blade	Blade Size (mm)
MB573R	MALLEABLE	171 x 51
MB574R	MALLEABLE	267 x 57



BV617R

**BALFOUR Center Blade For All
BALFOUR Retractors**

Catalog Number	Blade Size (mm)
BV617R	54 x 80



BV618R

Center Blade F/ BV615R

Catalog Number	Blade Size (mm)
BV618R	75 x 80



General Surgery
Abdominal Retractors

GENERAL SURGERY

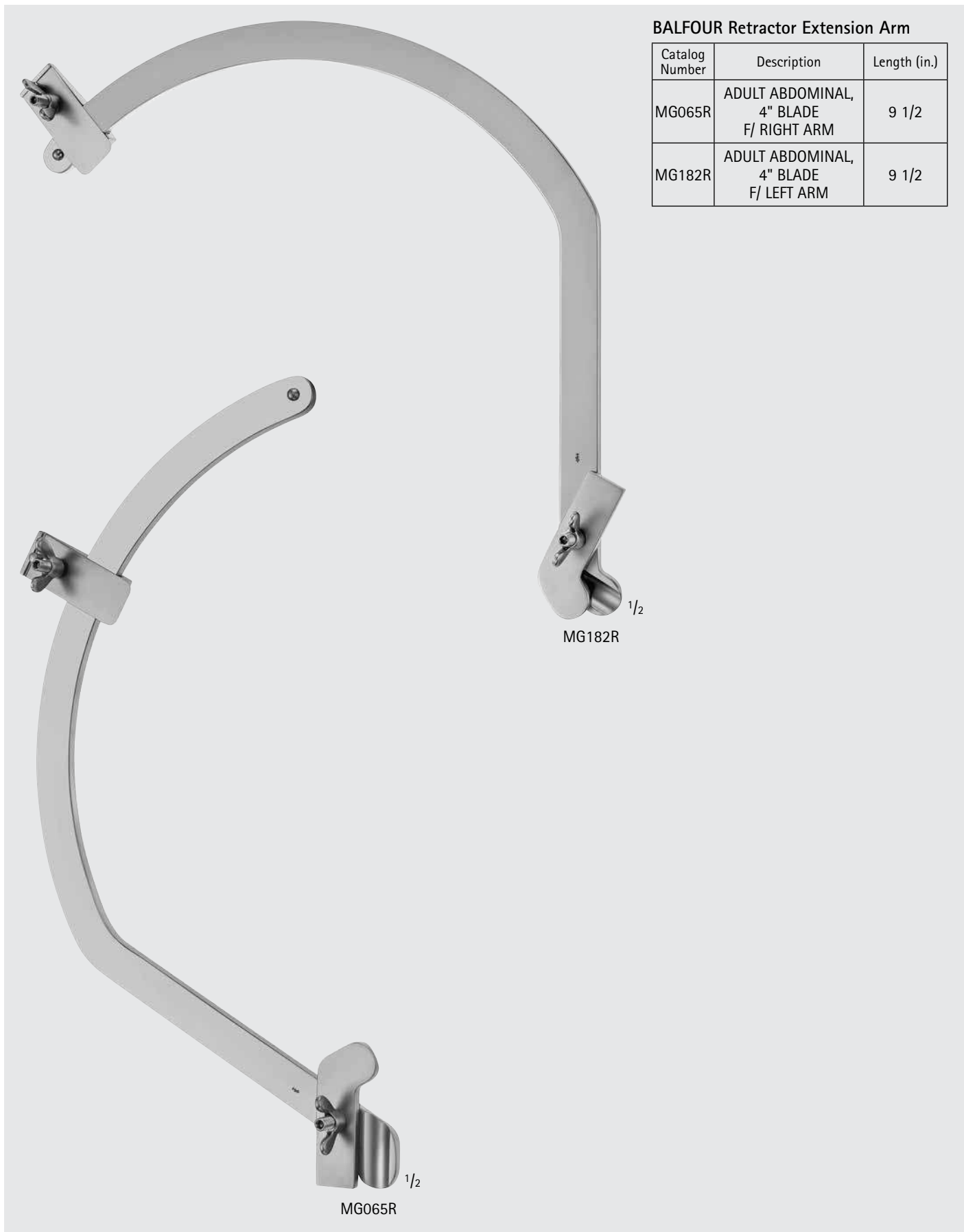

BALFOUR Retractor Extension Arm

Catalog Number	Description	Length (in.)
MG065R	ADULT ABDOMINAL, 4" BLADE F/ RIGHT ARM	9 1/2
MG182R	ADULT ABDOMINAL, 4" BLADE F/ LEFT ARM	9 1/2

MG182R

MG065R

DENIS-BROWNE Abdominal Retractor

Catalog Number	Description
BV650R	COMPLETE SET
BV648R	2 BLADES ONLY, 40 x 30 MM
BV649R	2 BLADES ONLY, 40 x 40 MM
BV646R	BLADE ONLY, 20 x 30 MM

BV650R Includes:
1 Frame
2 Blades of each BV648R and BV649R

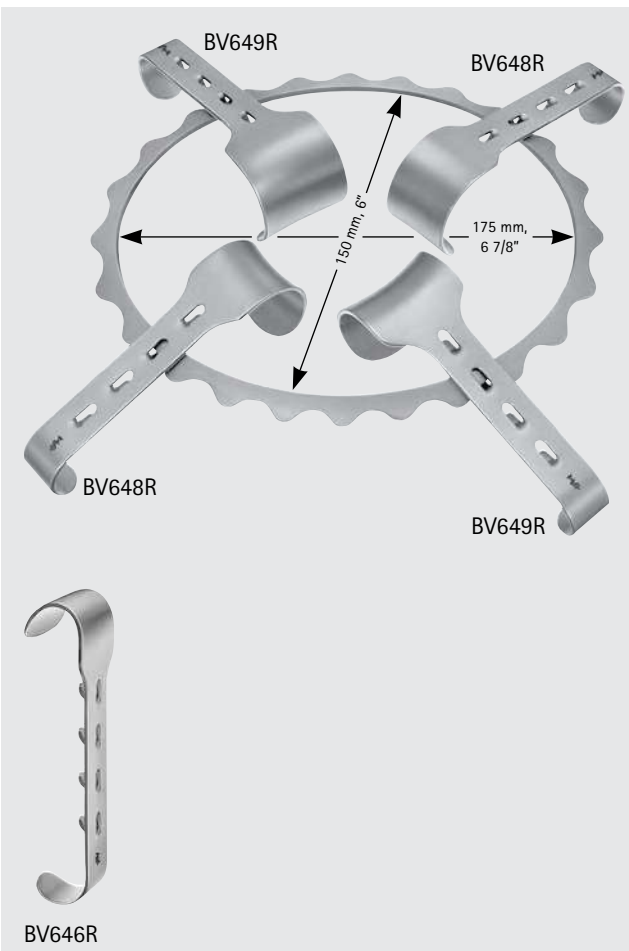

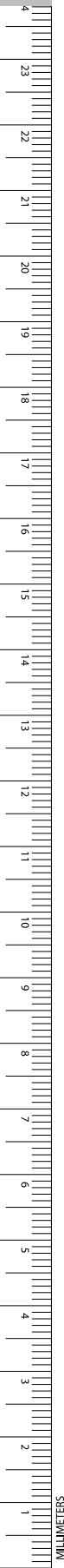

SEMM Abdominal Retractor

Catalog Number	Description	Blade Size (mm)
BV654R	COMPLETE SET	-
BV653R	FRAME	-
BV655R	2 BLADES	46 x 64
BV656R	BLADE	53 x 54
BV657R	BLADE	82 x 97
BV658R	BLADE	98 x 51
BV659R	BLADE	107 x 36

BV654R Includes:
 1 Frame BV653R
 1 Blade of each BV656R, BV657R,
 BV658R and BV659R
 2 Blades BV655R

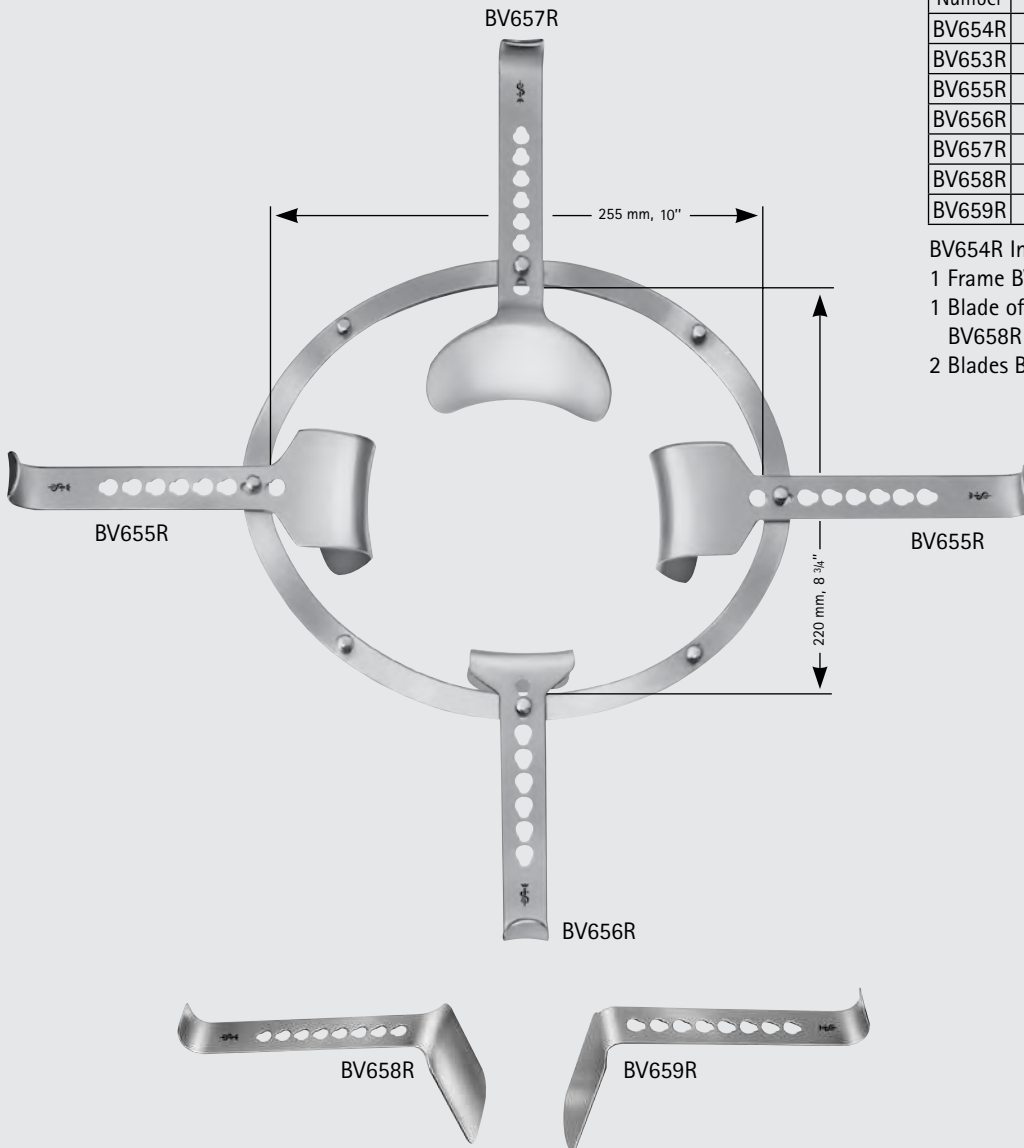

■ For more information about Universal Ring Retractor System see our brochure number DOC380.

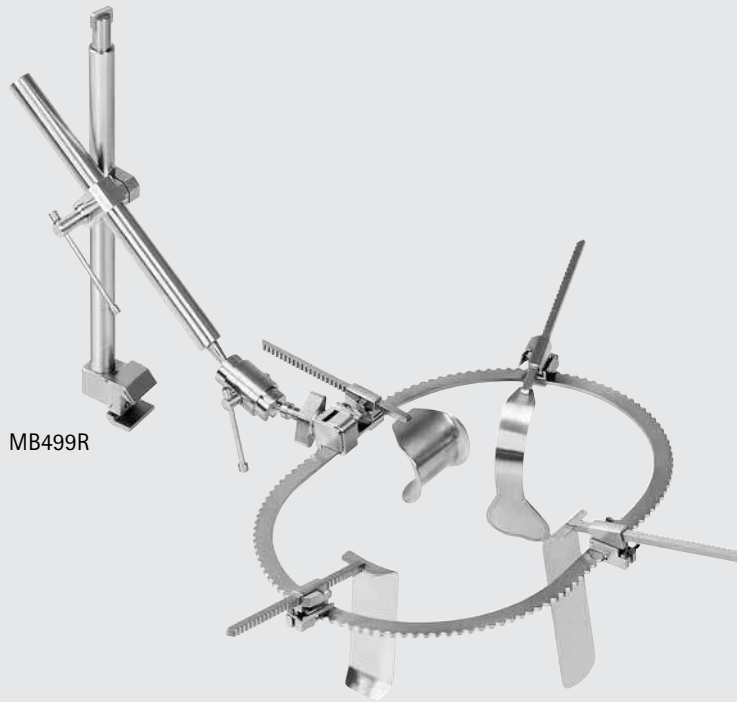

MB499R

Universal Ring Retractor System

Catalog Number	Description
MB499R	COMPLETE SET

Complete System Includes:

MB497	Segmented Medium Oval Ring
MB516	Medium Oval Ring
MB506	Standard Table Clamp 18"
MB488R	Horizontal Flex Bar w/ 360° Rotation 19 1/4"
MB487R	Horizontal Fixed Bar 15 1/2"
MB504	Post Clamp for 1" Bar
MB503	Non-Tilting Blade Clamp (2 each)
MB510	Tilting Blade Clamp (6 each)
MB524	KELLY Retractor Blade 2" x 3" (2 each)
MB525	KELLY Retractor Blade 2" x 4"
MB526	KELLY Retractor Blade 2" x 5"
MB527	KELLY Retractor Blade 2" x 6"
MB529	Malleable Retractor Blade 1 1/2" x 6"
MB530	Malleable Retractor Blade 2" x 6"
MB532	Malleable Retractor Blade 3" x 6"
MB534	BALFOUR Bladder Blade 3" x 2 1/2"
MB544	HARRINGTON Sweetheart Blade 2 1/2" x 5"
MB546	GELPI Point Retractor Blade

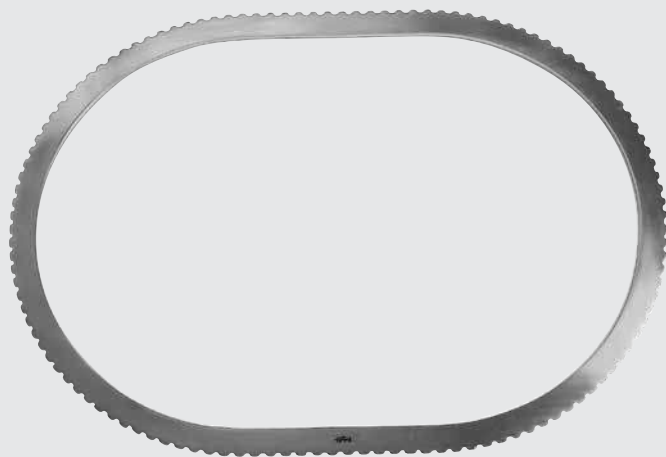

MB515-MB517

Oval Ring

Catalog Number	Size	Width x Length (in.)
MB515	SMALL	8 1/2 x 12
MB516	MEDIUM	10 1/2 x 15
MB517	LARGE	12 1/2 x 18 1/2



General Surgery

Universal Ring Retractor System

GENERAL SURGERY

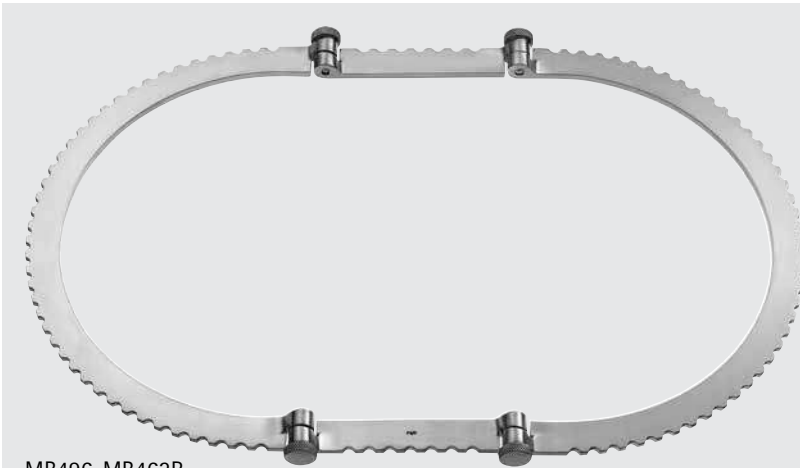
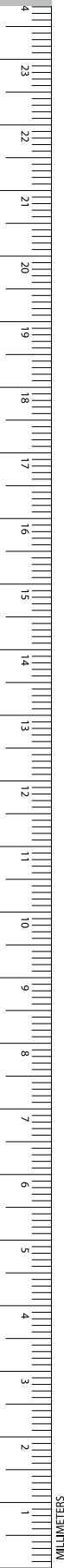

MB496-MB462R

Segmented Oval Ring

Catalog Number	Size	Description	Width x Length (in.)
MB496	SMALL	INCLUDES REMOVABLE 4" SEGMENTS	8 1/2 x 14
MB497	MEDIUM	INCLUDES REMOVABLE 8" SEGMENTS	10 1/2 x 19 1/2
MB498	LARGE	INCLUDES REMOVABLE 6" SEGMENTS	12 1/2 x 19 1/2
MB462R	X-LARGE	INCLUDES REMOVABLE 6" SEGMENTS	16 x 22



MB471R-MB473R

Segments for Segmented Oval Ring, Pair

Catalog Number	Length (in.)
MB471R	4
MB472R	6
MB473R	8



MB564

URRS Segmented Ring Screw

Catalog Number
MB564

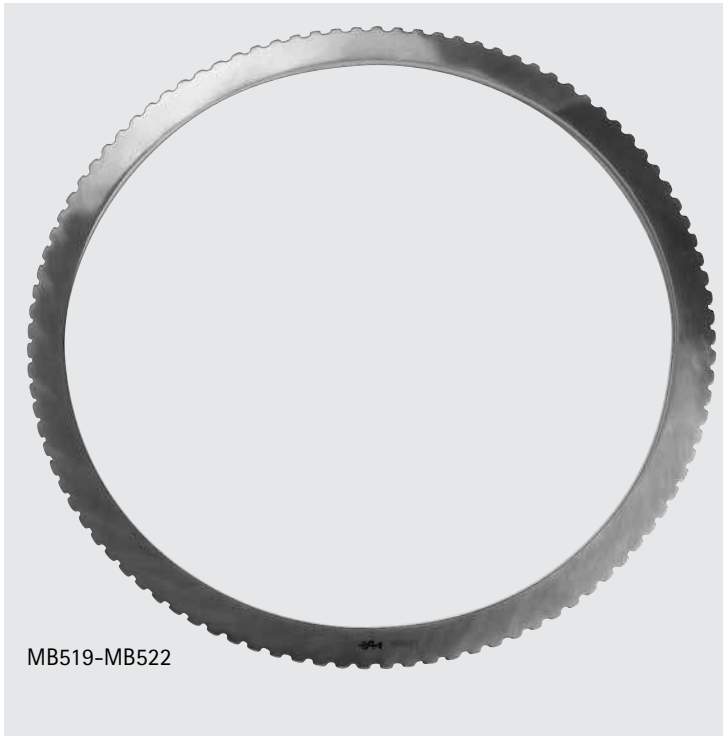

Round Ring

Catalog Number	Size	Diameter (in.)
MB519	SET	-
MB520	SMALL	8 1/2
MB521	MEDIUM	10 1/2
MB522	LARGE	12 1/2

MB519 Includes:
1 Ring of each MB520-MB522

MB519-MB522

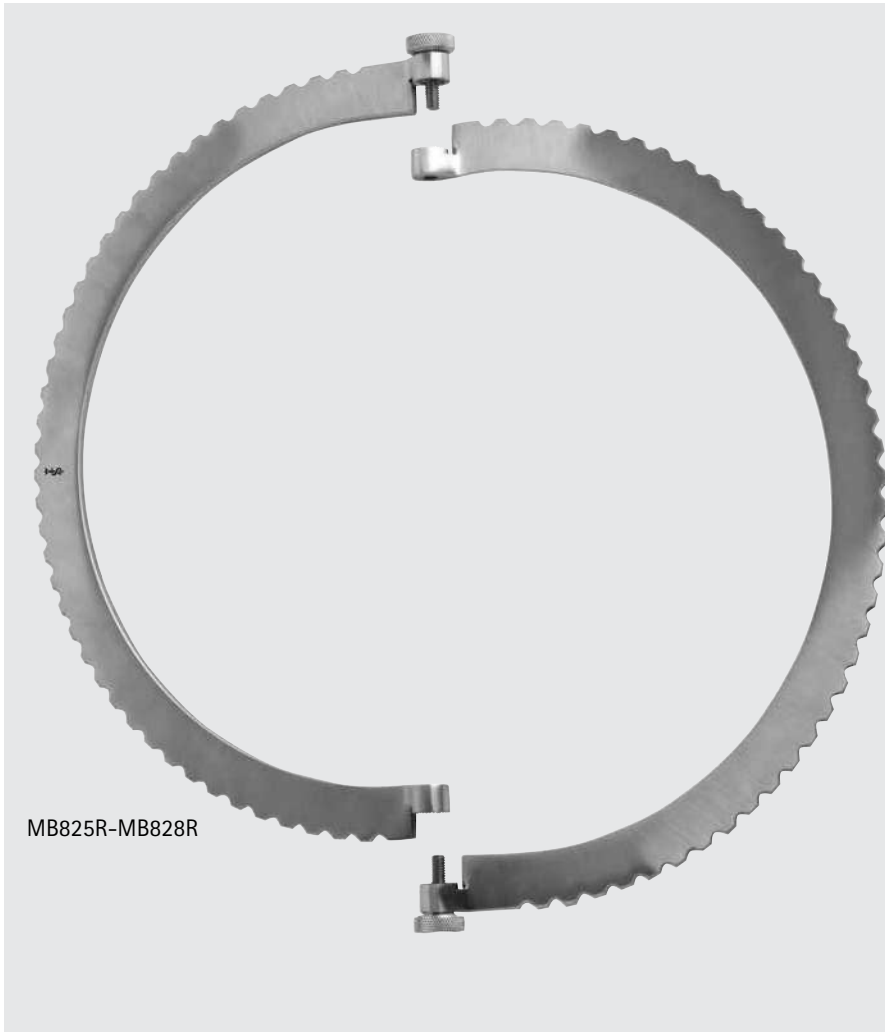

Segmented Round Ring

Catalog Number	Size	Diameter (in.)
MB825R	SMALL	8 1/2
MB826R	MEDIUM	10 1/2
MB827R	LARGE	12 1/2
MB828R	X-LARGE	16

MB825R-MB828R



General Surgery

Universal Ring Retractor System

GENERAL SURGERY

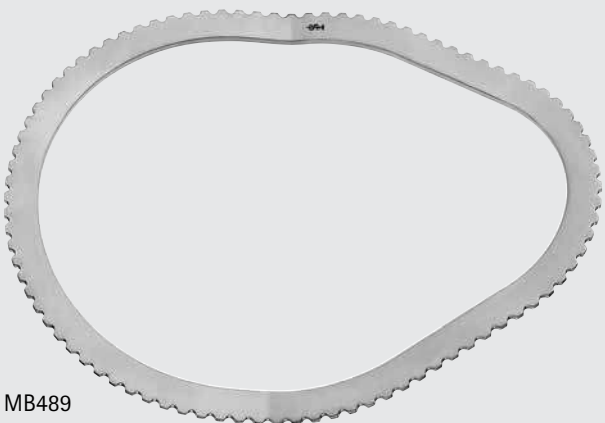
MB489

Vaginal Ring

Catalog Number	Description	Width x Length (in.)
MB489	20° ANGLE	8 x 10 1/2



MG511R

Tilt and Swivel Clamp

Catalog Number
MG511R

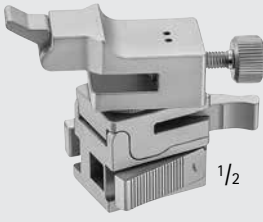

MB973R

Multi Directional Blade Clamp

Catalog Number
MB973R



MB503

Non-Tilting Blade Clamp

Catalog Number
MB503

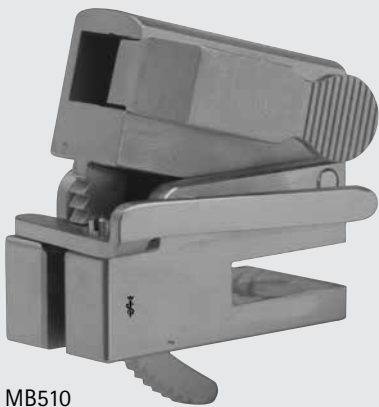

MB510

Tilting Blade Clamp

Catalog Number
MB510

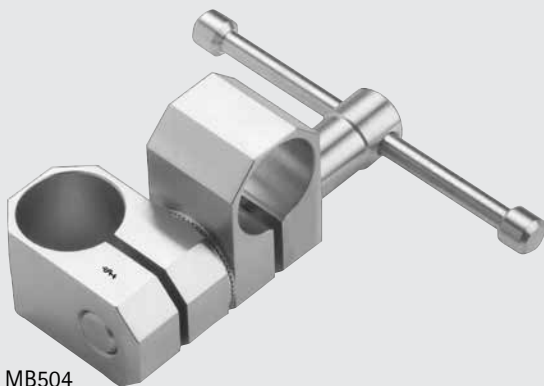

MB504

Post Clamp

Catalog Number
MB504



INCHES

General Surgery
Universal Ring Retractor System

GENERAL SURGERY

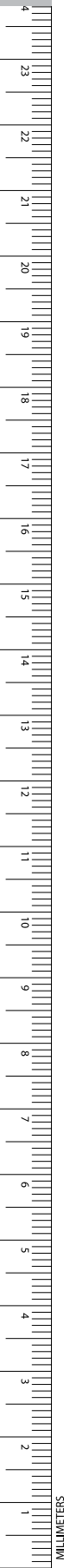

Table Clamp

Catalog Number	Working Length (in.)	Length (in.)
MB506	15	18
MB460R	21	24



MB460R-MB506

Flat Table Clamp

Catalog Number	Working Length (in.)	Total Length (in.)
MB670R	11 1/2	18
MB821R	17	24



MB670R-MB821R

Horizontal Fixed Bar

Catalog Number	Length (in.)
MB487R	15 1/2
MB823R	22



MB487R-MB823R

Horizontal Flex Bar W/ 360° Rotation

Catalog Number	Length (in.)
MB488R	19
MB824R	22 1/2



MB488R-MB824R

Vertical Extension Bar

Catalog Number	Length (in.)
MB508	12
MB822R	14



MB508-MB822R

Adapter For Attaching Handheld Retractors

Catalog Number
MB509



MB509



INCHES

General Surgery

Universal Ring Retractor System

GENERAL SURGERY

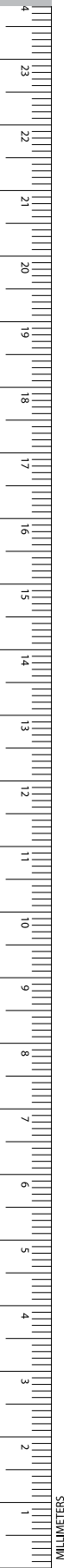

MB469R-MB555

KELLY Retractor Blade

Catalog Number	Description	Width x Depth (in.)
MB555	-	1 x 1 1/2
MB556	-	1 x 2 1/2
MB936R	-	2 x 1 1/2
MB937R	-	2 x 2 1/2
MB524	-	2 x 3
MB525	-	2 x 4
MB526	-	2 x 5
MB527	-	2 x 6
MB469R	BARIATRIC	2 x 8



MB938A-MB943A

Aluminum KELLY Retractor Blade

Catalog Number	Description	Width x Depth (in.)
MB938A	-	2 x 2 1/2
MB939A	-	2 x 3
MB940A	-	2 x 4
MB941A	-	2 x 5
MB942A	-	2 x 6
MB943A	BARIATRIC	2 x 8



MB467R-MB860R

Malleable Retractor Blade

Catalog Number	Description	Width x Depth (in.)
MB860R	-	3/4 x 2
MB861R	-	3/4 x 3
MB862R	-	1 x 1
MB863R	-	1 x 4
MB864R	-	1 x 5
MB865R	-	1 1/2 x 3
MB866R	-	1 1/2 x 4
MB529	-	1 1/2 x 6
MB867R	-	1 1/2 x 8
MB530	-	2 x 6 1/2
MB531	-	2 x 8
MB463R	BARIATRIC	2 x 10
MB532	-	3 x 6
MB464R	BARIATRIC	3 x 10
MB466R	BARIATRIC	3 x 12
MB869R	BARIATRIC	4 x 8
MB465R	BARIATRIC	4 x 10
MB467R	BARIATRIC	4 x 12

Aluminum Malleable Retractor Blade, Flat

Catalog Number	Description	Width x Depth (in.)
MB954A	-	1 1/2 x 6
MB955A	-	2 x 6
MB956A	-	2 x 8
MB957A	-	3 x 6
MB958A	BARIATRIC	2 x 10
MB959A	BARIATRIC	3 x 10

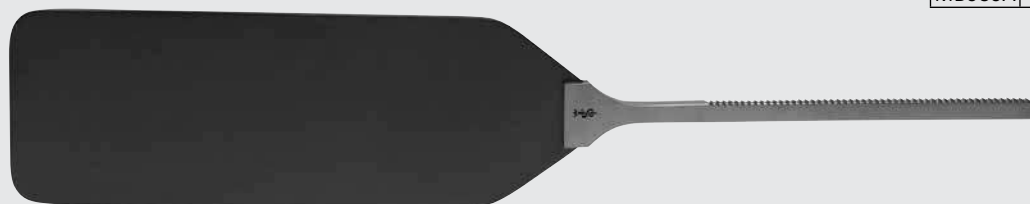

MB954A-MB959A

General Surgery

Universal Ring Retractor System

GENERAL SURGERY



MB557-MB559

RICHARDSON Retractor

Catalog Number	Width x Depth (in.)
MB557	3/4 x 1
MB558	3/4 x 2
MB559	1 x 1 1/4



MB470R-MB534

BALFOUR Bladder Blade

Catalog Number	Description	Width x Depth (in.)
MB534	-	3 x 2 1/2
MB535	-	3 x 3 1/4
MB470R	BARIATRIC	3 x 3 1/2



MB829A-MB830A

Aluminum BALFOUR Bladder Blade

Catalog Number	Width x Depth (in.)
MB829A	2 x 2 3/8
MB830A	3 x 2 1/2

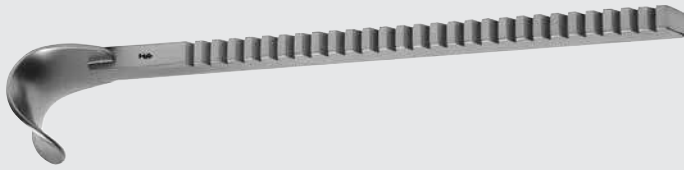

MB968R-MB969R

MAYO Retractor Blade

Catalog Number	Width x Depth (in.)
MB968R	1 1/4 x 1 1/4
MB969R	2 x 2

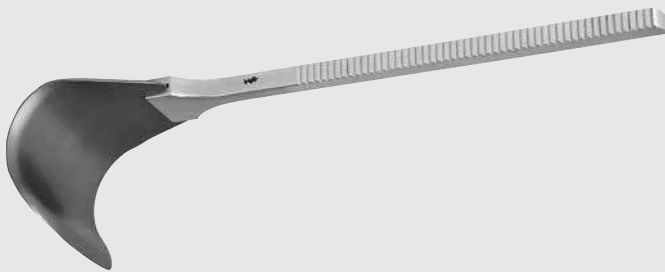

MB970A

Aluminum MAYO Retractor Blade

Catalog Number	Width x Depth (in.)
MB970A	2 3/4 x 2



MB537-MB539

DEAVER Retractor Blade

Catalog Number	Width x Depth (in.)
MB537	1 x 4 1/2
MB538	1 1/2 x 4 1/2
MB539	2 x 4 1/2

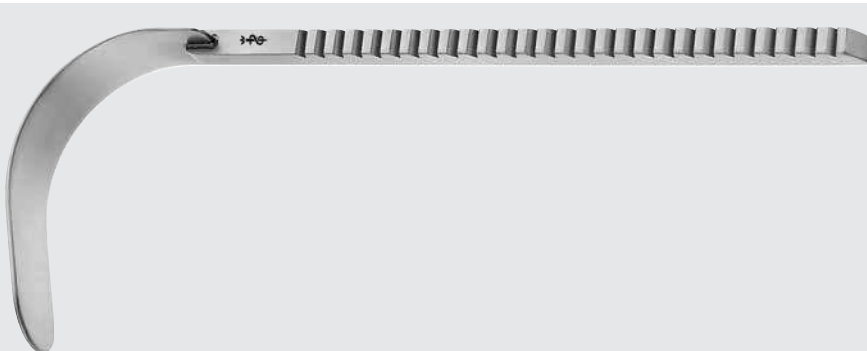

MB492-MB493

DEAVER Vaginal Retractor Blade

Catalog Number	Description	Width x Depth (in.)
MB492	SMALL	1 x 3 1/2
MB493	LARGE	1 x 5



INCHES

General Surgery

Universal Ring Retractor System

GENERAL SURGERY

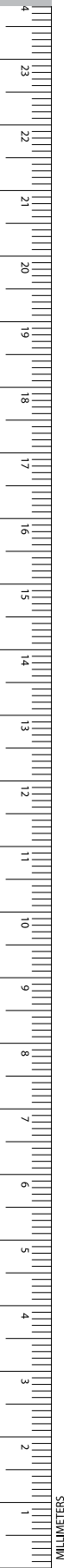

MB490

Vaginal Retractor Posterior Blade

Catalog Number	Width x Depth (in.)
MB490	1 x 4 1/2



MB491

Vaginal Retractor Lateral Blade

Catalog Number	Width x Depth (in.)
MB491	1 x 3



MB871R

ST. MARK'S Deep Pelvic Retractor Blade

Catalog Number	Width x Depth (in.)
MB871R	2 3/8 x 7 1/2



MB494-MB495

Rectal Blade

Catalog Number	Description	Width x Depth (in.)
MB494	SMALL	7/8 x 2 7/8
MB495	LARGE	7/8 x 3 7/8

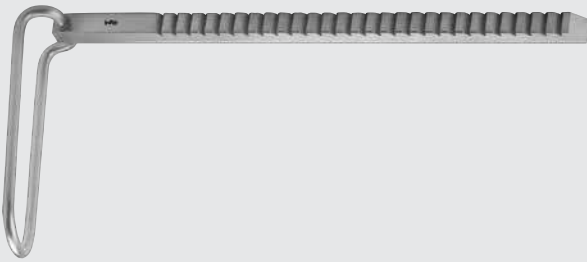

MB541

Skin Incision Blade

Catalog Number	Width x Depth (in.)
MB541	1 1/8 x 3 1/4



INCHES

General Surgery
Universal Ring Retractor System

GENERAL SURGERY

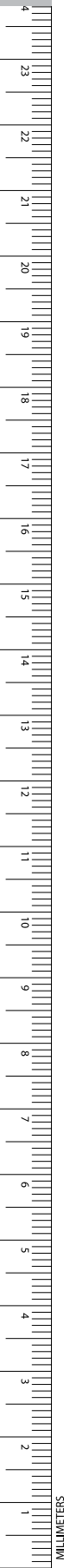

MB543-MB832R

HARRINGTON Sweetheart Blade

Catalog Number	Description	Width x Depth (in.)
MB543	-	1 1/2 x 5
MB544	-	2 1/2 x 5 5/8
MB468R	BARIATRIC	3 1/2 x 10
MB832R	BARIATRIC	4 1/2 x 10

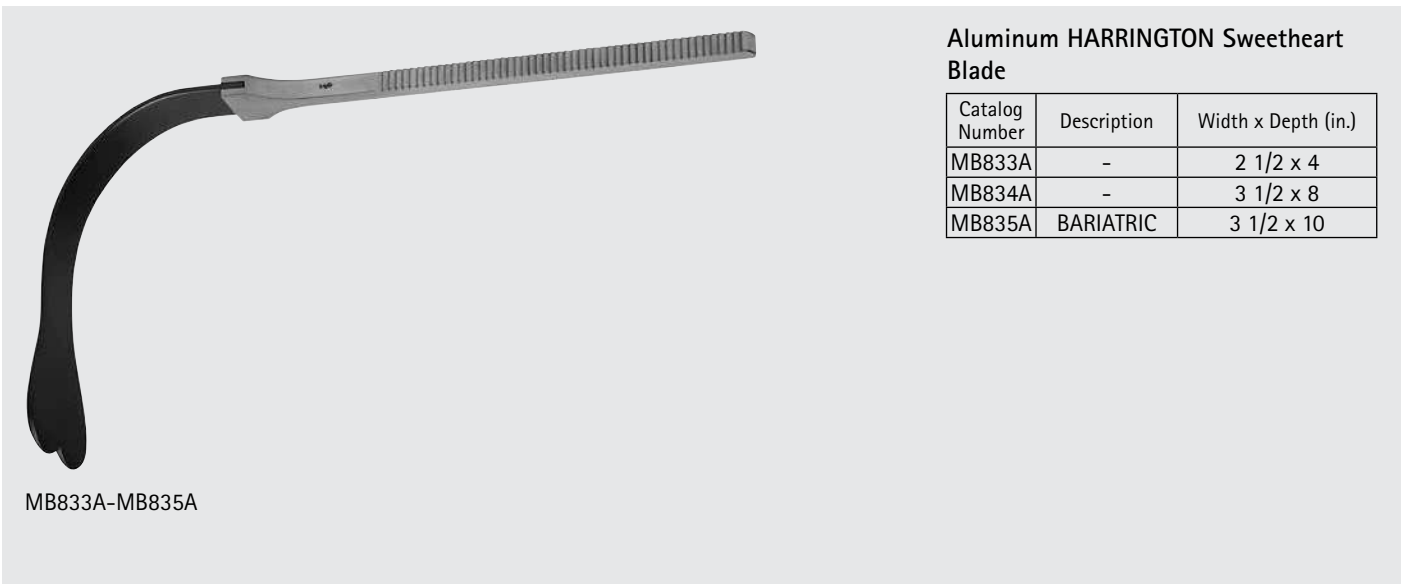

MB833A-MB835A

Aluminum HARRINGTON Sweetheart Blade

Catalog Number	Description	Width x Depth (in.)
MB833A	-	2 1/2 x 4
MB834A	-	3 1/2 x 8
MB835A	BARIATRIC	3 1/2 x 10



MB546

GELPI Point Retractor Blade

Catalog Number
MB546

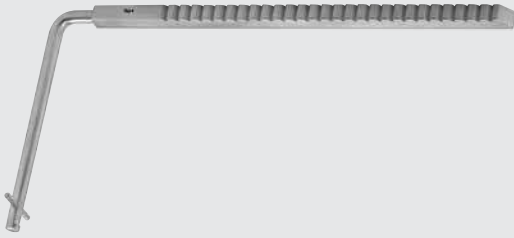

MB548-MB549

SCOVILLE Hook Retractor Blade

Catalog Number	Description	Depth (in.)
MB549	SMALL	2
MB548	LARGE	3 1/4



MB566-MB568

Rake Retractor

Catalog Number	Description	Width x Depth (in.)
MB566	3 PRONGS	2/3 x 3/4
MB567	4 PRONGS	3/4 x 1/3
MB568	6 PRONGS	1 x 1/3



MB551-MB553

MEYERDING Retractor Blade

Catalog Number	Width x Depth (in.)
MB551	1 x 3 1/3
MB552	2 x 3 3/4
MB553	2/3 x 2 1/3



General Surgery
Universal Ring Retractor System

GENERAL SURGERY

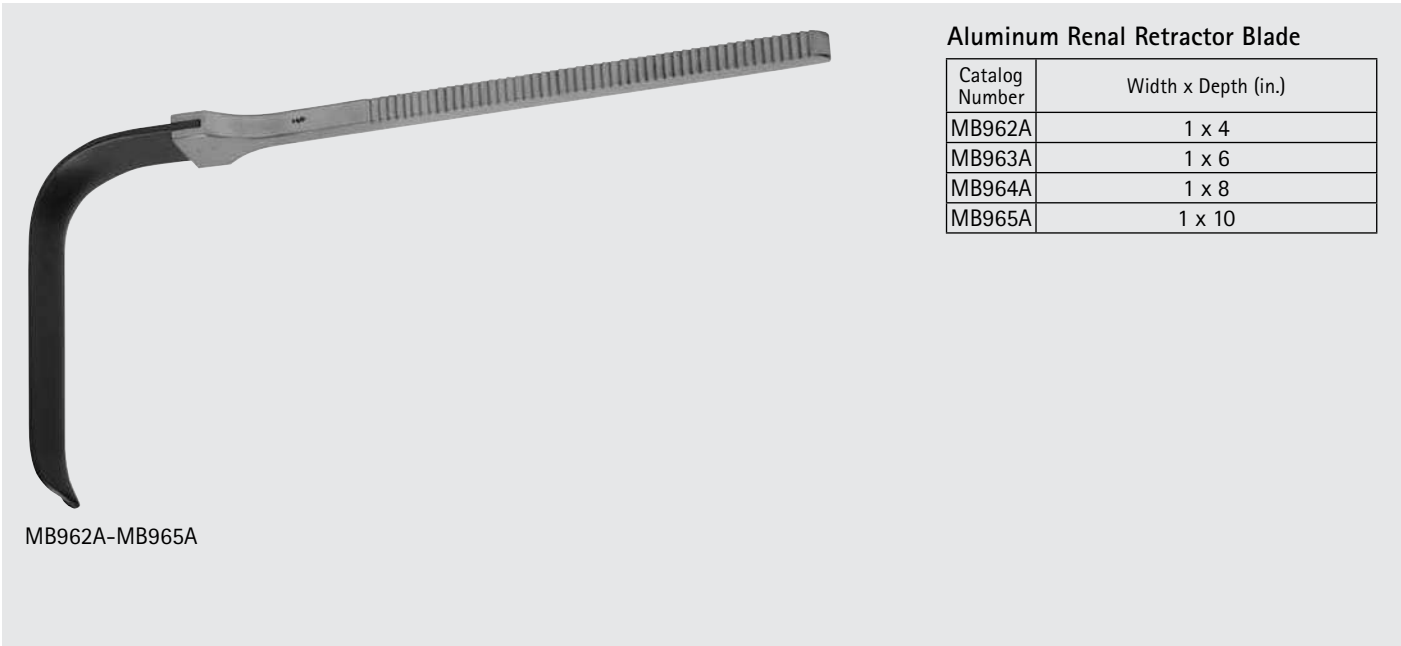
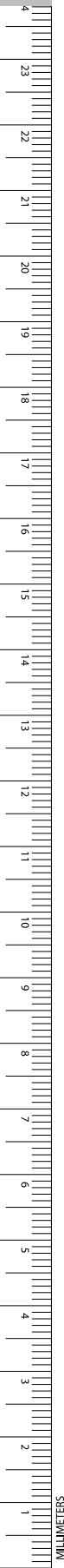

Aluminum Renal Retractor Blade

Catalog Number	Width x Depth (in.)
MB962A	1 x 4
MB963A	1 x 6
MB964A	1 x 8
MB965A	1 x 10

MB962A-MB965A

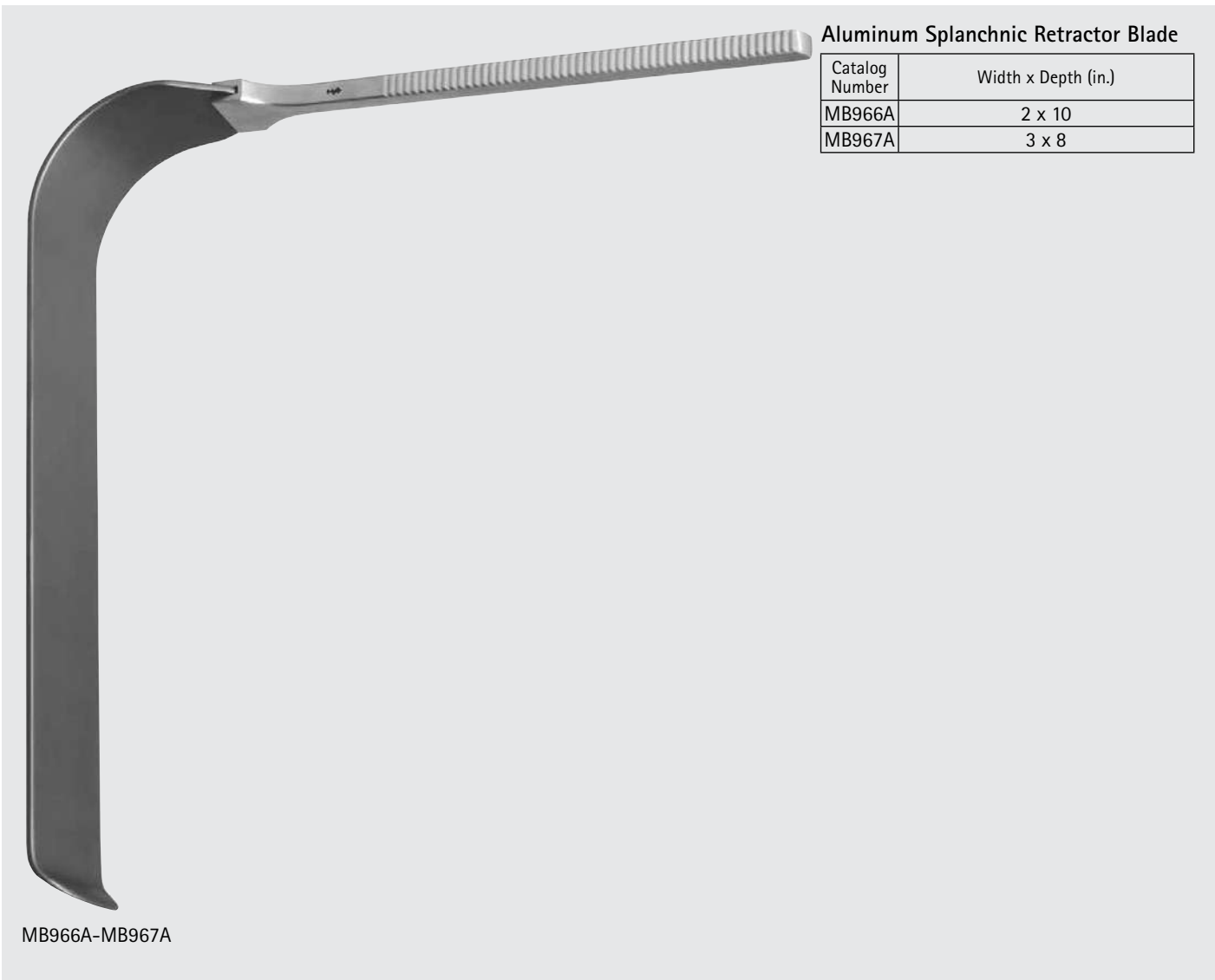

Aluminum Splanchnic Retractor Blade

Catalog Number	Width x Depth (in.)
MB966A	2 x 10
MB967A	3 x 8

MB966A-MB967A

Perforated Super Malleable Retractor Blade

Catalog Number	Width x Depth (in.)
MB960R	2 x 9
MB961R	3 x 9



MB960R-MB961R

YU-HOLTGREWE Malleable Retractor Blade

Catalog Number	Width x Depth (in.)
MB870R	2 1/2 x 6

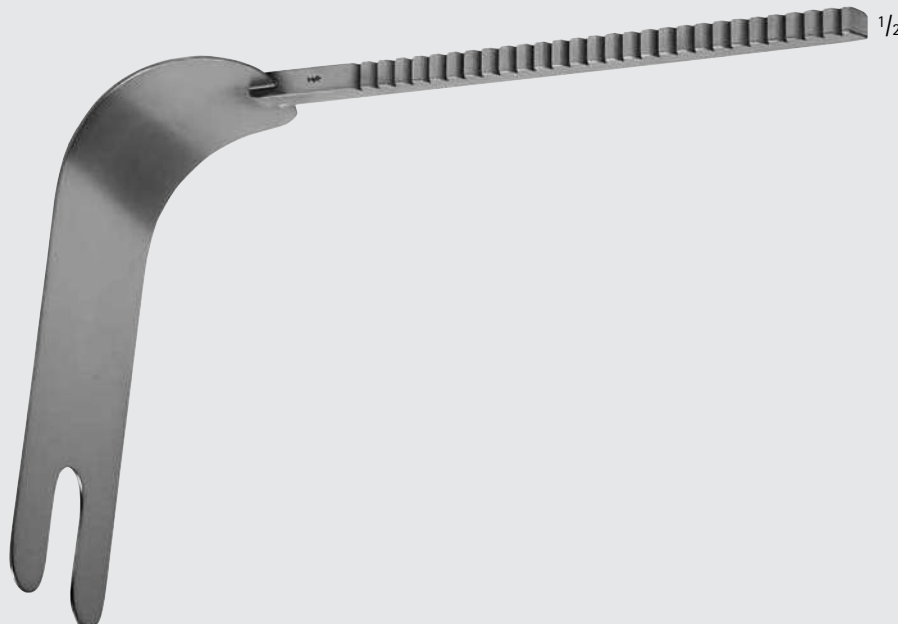

MB870R



General Surgery

Self Retaining Retractors



BV001R

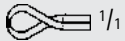

BV001R

FINSEN Retractor

Catalog Number	Tip	Blade End	Length (in.)
BV001R	SHARP	2 x 3 PRONGS	2



BV002R

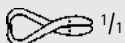

BV002R

FINSEN Retractor

Catalog Number	Tip	Blade End	Length (in.)
BV002R	SHARP	3 x 4 PRONGS	2 3/4

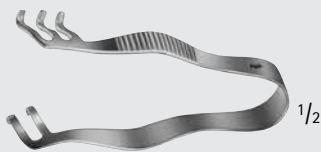

BV003R

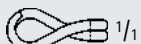

BV003R

FINSEN Modified Retractor

Catalog Number	Tip	Blade End	Length (in.)
BV003R	BLUNT	2 x 3 PRONGS	3



BV005R



BV005R

FINSEN Retractor

Catalog Number	Tip	Blade End	Length (in.)
BV005R	SHARP	3 x 4 PRONGS	2 3/4



BV014R

PARSONNET Epicardial Retractor

Catalog Number	Tip	Blade End	Length (in.)
BV014R	SHARP	3 x 3 PRONGS	2

GENERAL SURGERY





BV006R-BV007R



BV006R

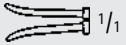

BV007R

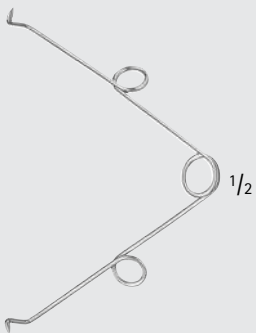

MD471

Spring Wire Retractor

Catalog Number	Tip	Prongs	Length (in.)
BV006R	BLUNT	3 x 3	1 3/4
BV007R	BLUNT	3 x 3	2 1/4
MD471	SHARP	1 x 1	3

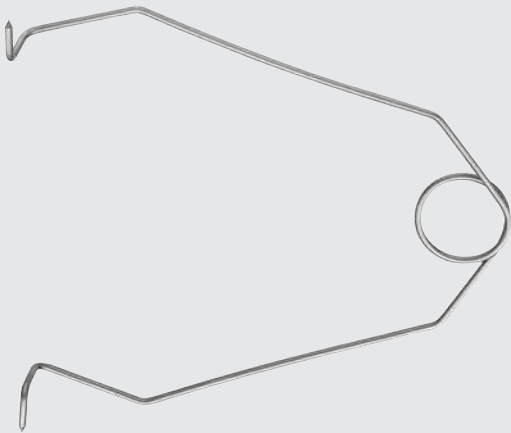

MB196R-MB777R

Spring Wire Retractor

Catalog Number	Size	Length (in.)
MB777R	SMALL	5
MB778R	MEDIUM	5 1/8
MB196R	LARGE	9



INCHES

General Surgery

Self Retaining Retractors

GENERAL SURGERY

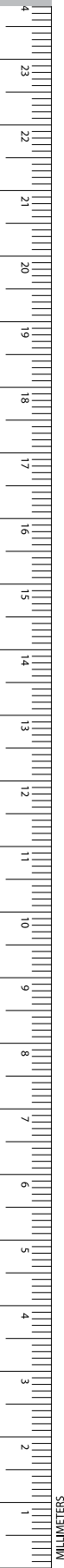

BV010R-BV011R



BV010R



BV011R

ALM Retractor

Catalog Number	Tip	Blade End	Length (in.)
BV010R	SHARP	4 x 4 PRONGS	2 3/4
BV011R	SHARP	4 x 4 PRONGS	4



BV008R-BV015R



BV008R



BV015R

HEISS Self-Retaining Retractor

Catalog Number	Tip	Blade End	Length (in.)
BV015R	SHARP	4 x 4 PRONGS	4
BV008R	BLUNT	4 x 4 PRONGS	4

WEITLANER Retractor

Catalog Number	Tip	Blade End	Length (in.)
BV073R	BLUNT	2 x 3 PRONGS	4 1/4
MA438R	BLUNT	3 x 3 PRONGS	4 1/4
BV074R	BLUNT	3 x 4 PRONGS	5 1/8
BV075R	BLUNT	3 x 4 PRONGS	6 1/2
BV104R	BLUNT/DEEP	3 x 4 PRONGS	5 1/8

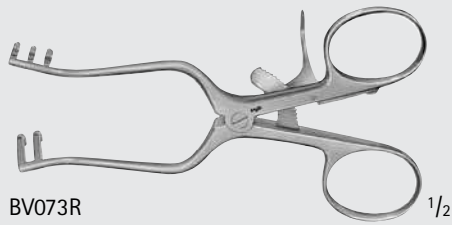

BV073R

1/2

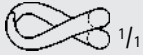

BV073R

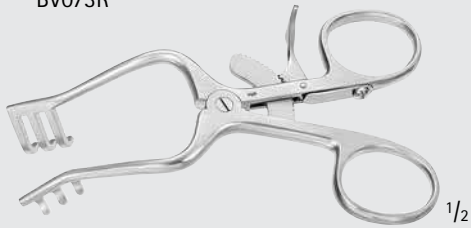

MA438R

1/2



MA438R

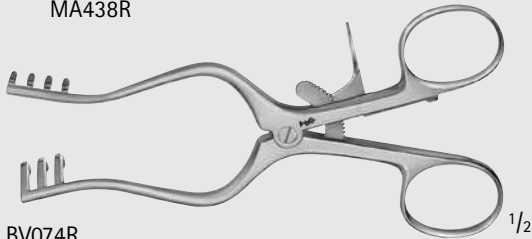

BV074R

1/2

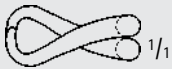

BV074R

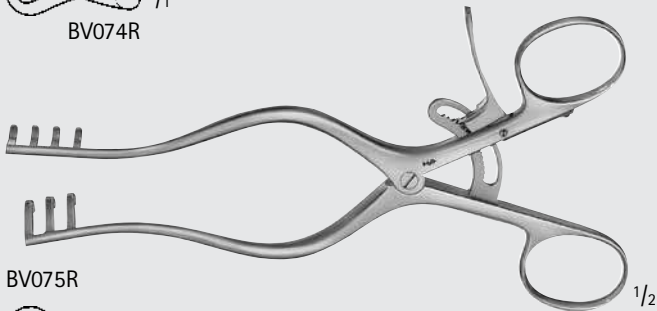

BV075R

1/2

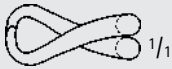

BV075R

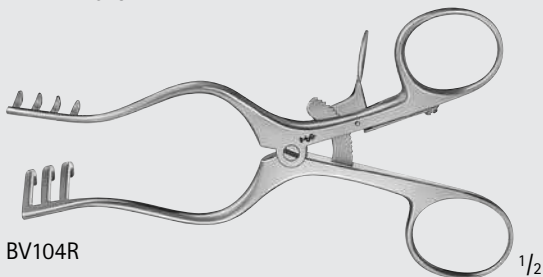

BV104R

1/2

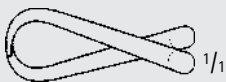

BV104R



INCHES

General Surgery

Self Retaining Retractors

GENERAL SURGERY

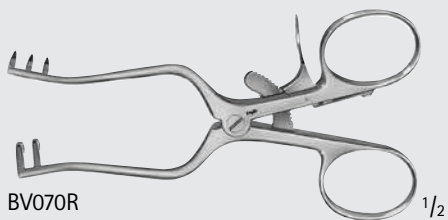

BV070R

1/2



BV070R

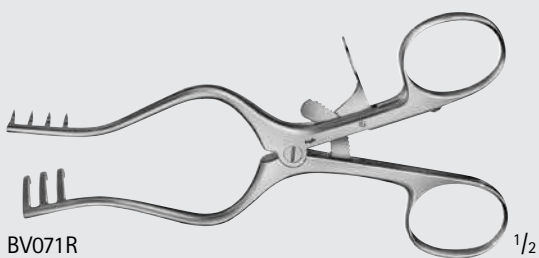

BV071R

1/2



BV071R

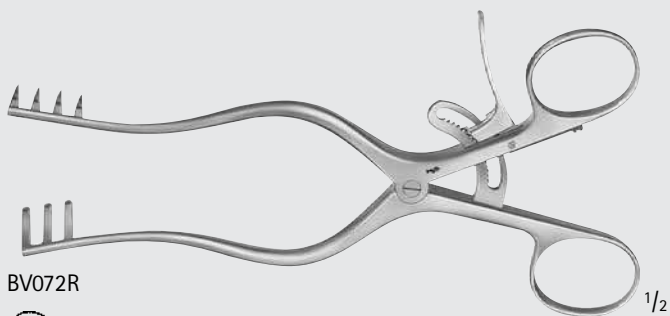

BV072R

1/2



BV072R

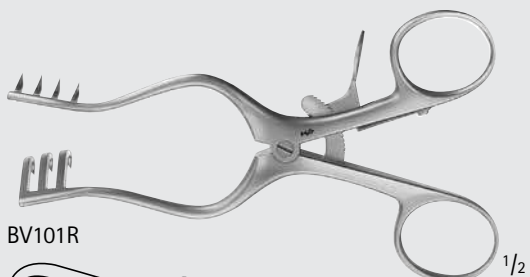

BV101R

1/2



BV101R



BV066R

1/2



BV066R

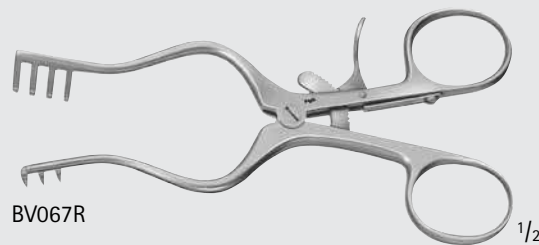

BV067R

1/2

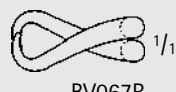

BV067R

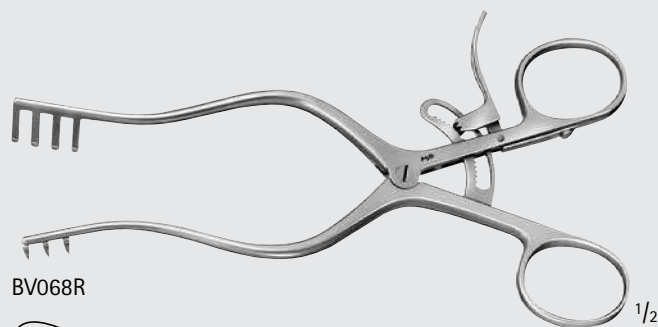

BV068R

1/2

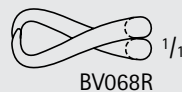

BV068R

WEITLANER Retractor

Catalog Number	Tip	Blade End	Length (in.)
BV070R	SHARP	2 x 3 PRONGS	4 1/4
BV071R	SHARP	3 x 4 PRONGS	5 1/8
BV072R	SHARP	3 x 4 PRONGS	6 1/2
BV101R	SHARP/DEEP	3 x 4 PRONGS	5 1/8
BV066R	SEMI-S	2 x 3 PRONGS	4 1/4
BV067R	SEMI-S	3 x 4 PRONGS	5 1/8
BV068R	SEMI-S	3 x 4 PRONGS	6 1/2



WULLSTEIN Retractor

Catalog Number	Tip	Blade End	Length (in.)
BV076R	SHARP	3 x 3 PRONGS	5
BV077R	BLUNT	3 x 3 PRONGS	5

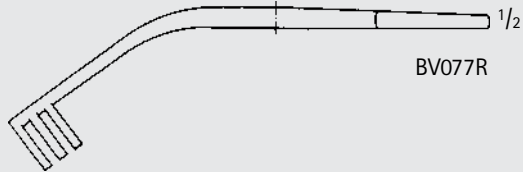
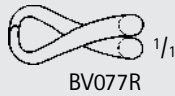
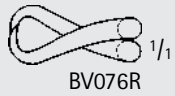

Baby ADSON Retractor, Hinged

Catalog Number	Tip	Blade End	Length (in.)
BV085R	SEMI-S	3 x 4 PRONGS	5 1/2
BV094R	SEMI-S	3 x 4 PRONGS	6 1/2

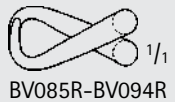
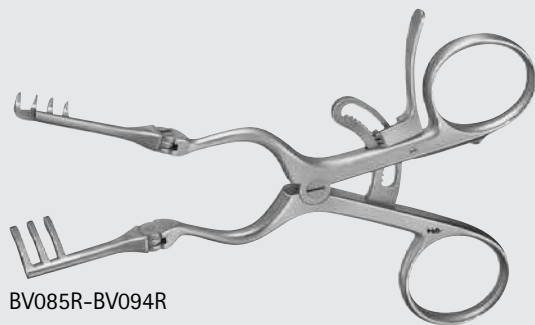

Baby ADSON Retractor, Angled

Catalog Number	Tip	Blade End	Length (in.)
MG007R	BLUNT	4 x 4 PRONGS	7 1/2

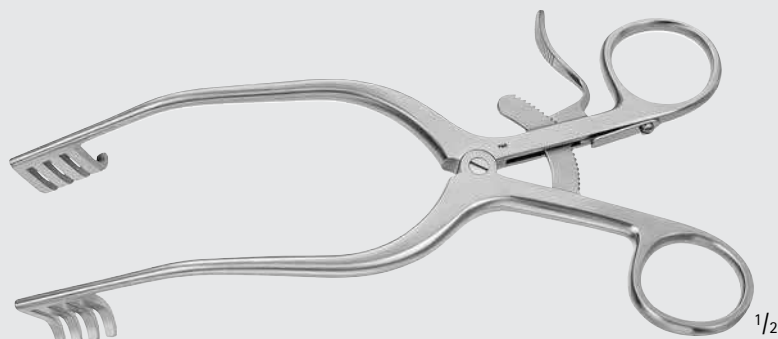

MG007R

General Surgery

Self Retaining Retractors

GENERAL SURGERY

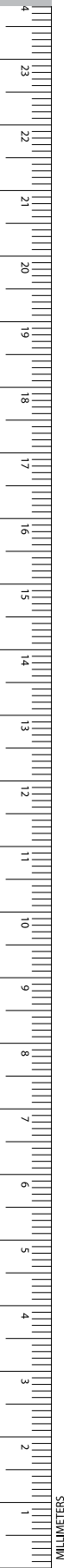

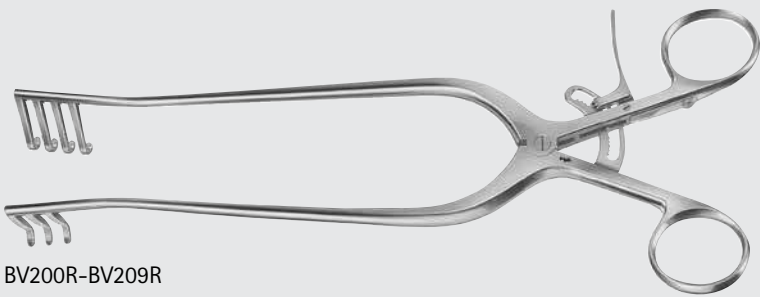

BV200R-BV209R

WEITLANER Retractor

Catalog Number	Tip	Blade End	Length (in.)
BV200R	SHARP	3 x 4 PRONGS	7 7/8
BV206R	SHARP	3 x 4 PRONGS	9 1/2
BV208R	SHARP	5 x 6 PRONGS	10
BV201R	BLUNT	3 x 4 PRONGS	7 7/8
BV207R	BLUNT	3 x 4 PRONGS	9 1/2
BV209R	BLUNT	5 x 6 PRONGS	10

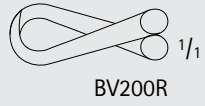

BV200R

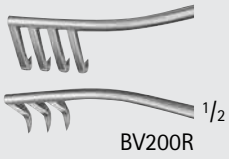

BV200R



BV201R

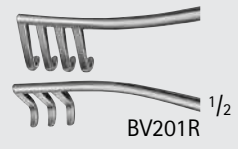

BV201R

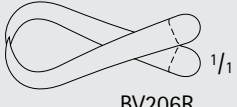

BV206R

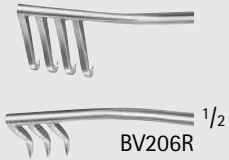

BV206R



BV207R

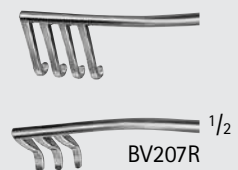

BV207R

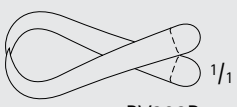

BV208R

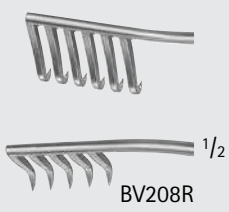

BV208R

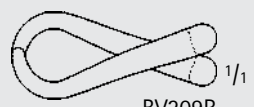

BV209R

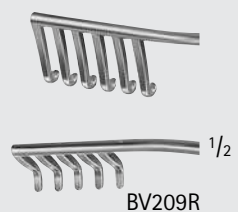

BV209R



MB476R

MISKIMON Cerebellar Retractor

Catalog Number	Tip	Blade End	Length (in.)
MB476R	SHARP	7 x 7 PRONGS	7 7/8



MB476R



MB476R

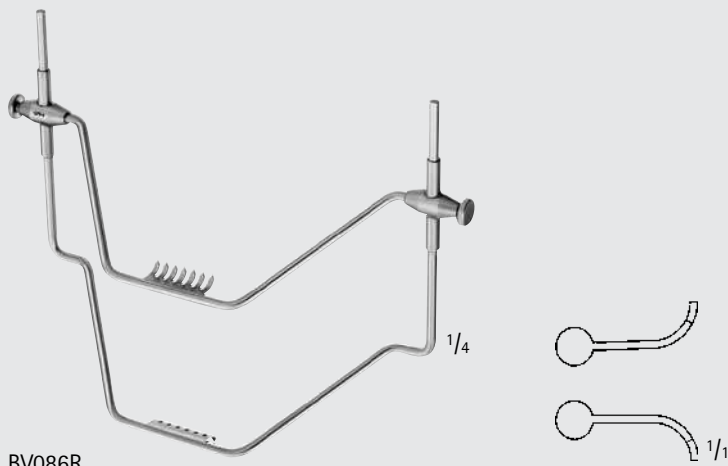

Thyroid Retractor

Catalog Number	BV086R
----------------	--------

BV086R $\frac{1}{4}$

BV086R $\frac{1}{1}$

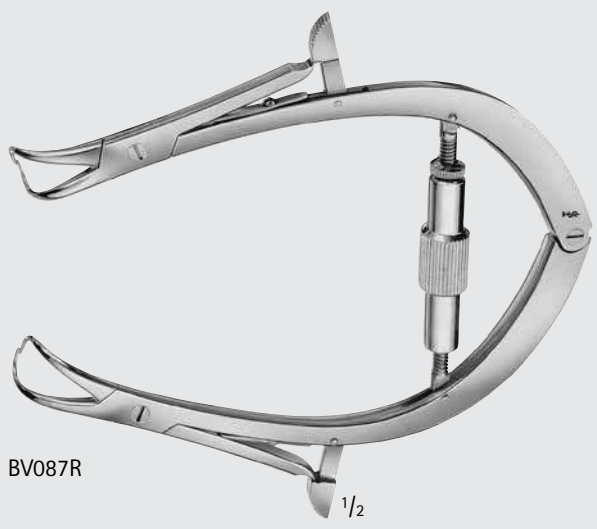

JOLL (FRIEDMANN) Thyroid/Vaginal Retractor

Catalog Number	Length (in.)
BV087R	6 1/8

BV087R $\frac{1}{2}$

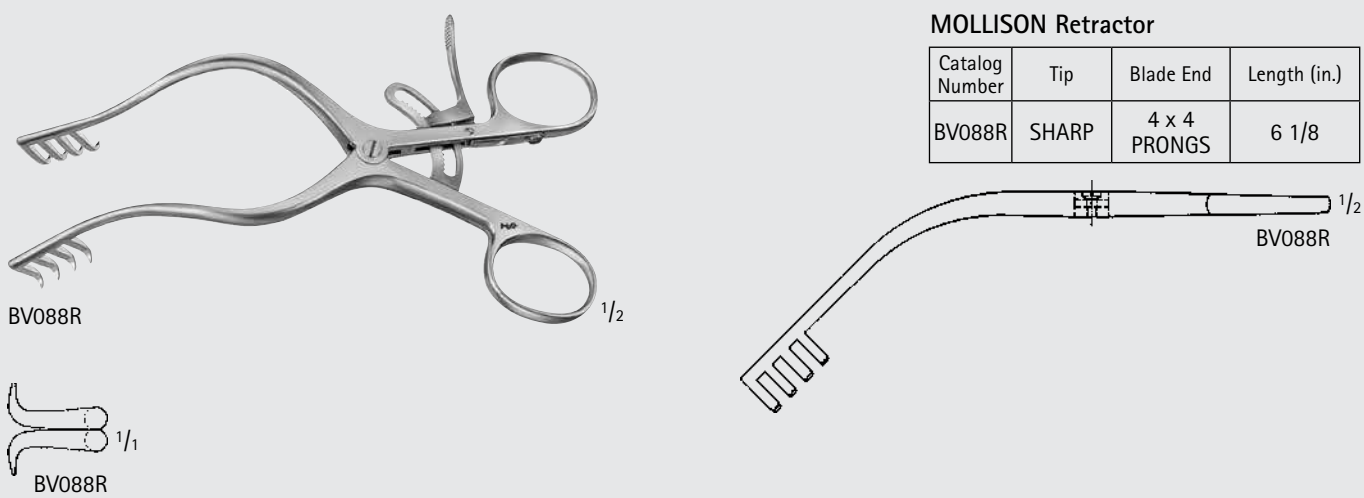

MOLLISON Retractor

Catalog Number	Tip	Blade End	Length (in.)
BV088R	SHARP	4 x 4 PRONGS	6 1/8

BV088R $\frac{1}{2}$

BV088R $\frac{1}{1}$



General Surgery

Self Retaining Retractors

GENERAL SURGERY

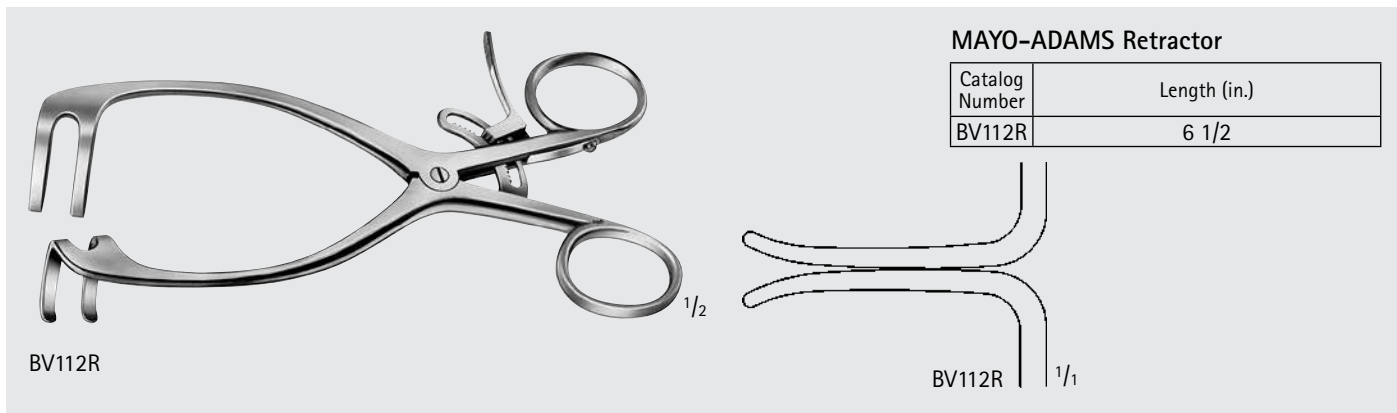



MAYO-ADAMS Retractor

Catalog Number	Length (in.)
BV112R	6 1/2

BV112R ^{1/2}

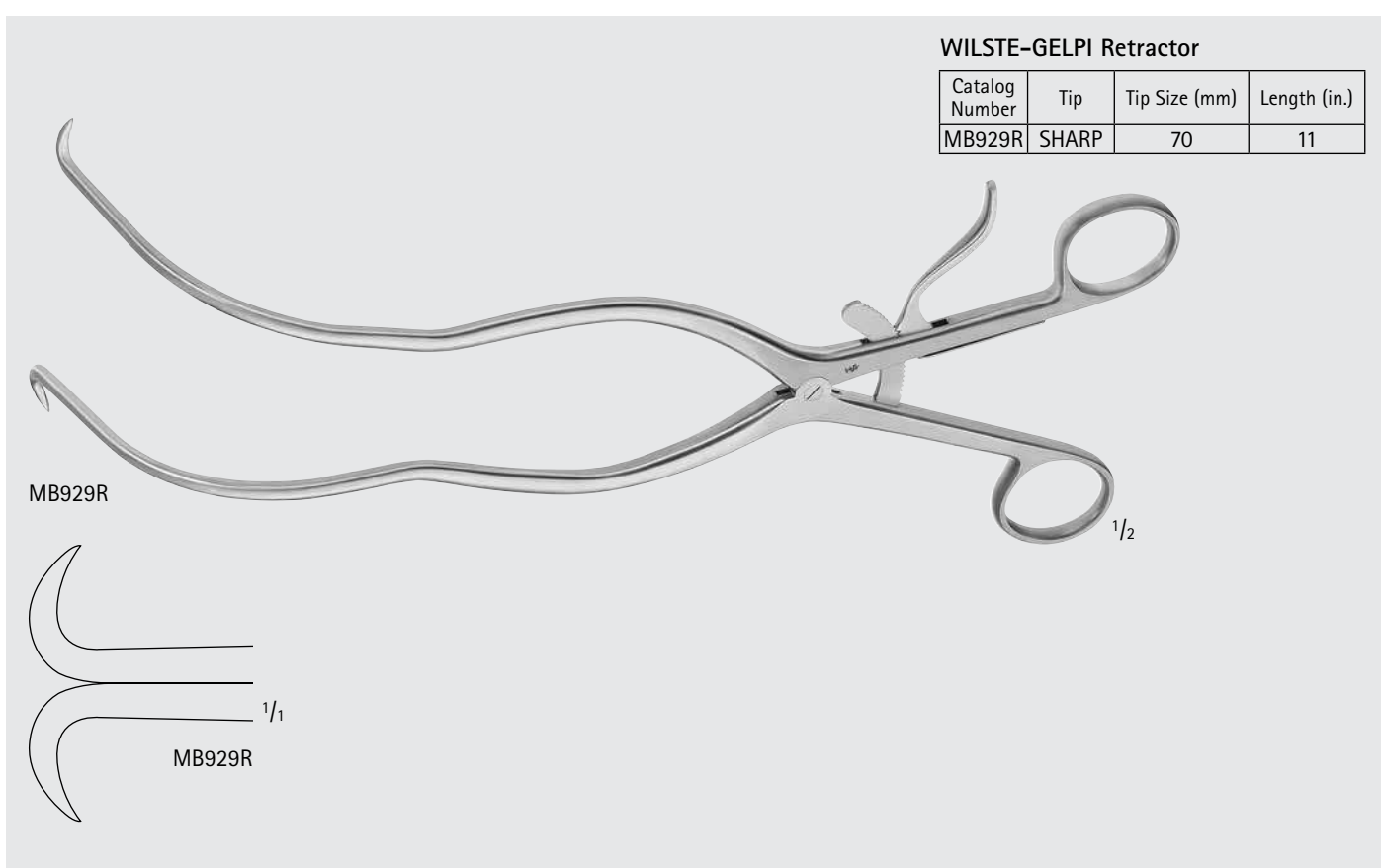
BV112R ^{1/1}



WILSTE-GELPI Retractor

Catalog Number	Tip	Tip Size (mm)	Length (in.)
MB929R	SHARP	70	11

MB929R ^{1/2}

MB929R ^{1/1}

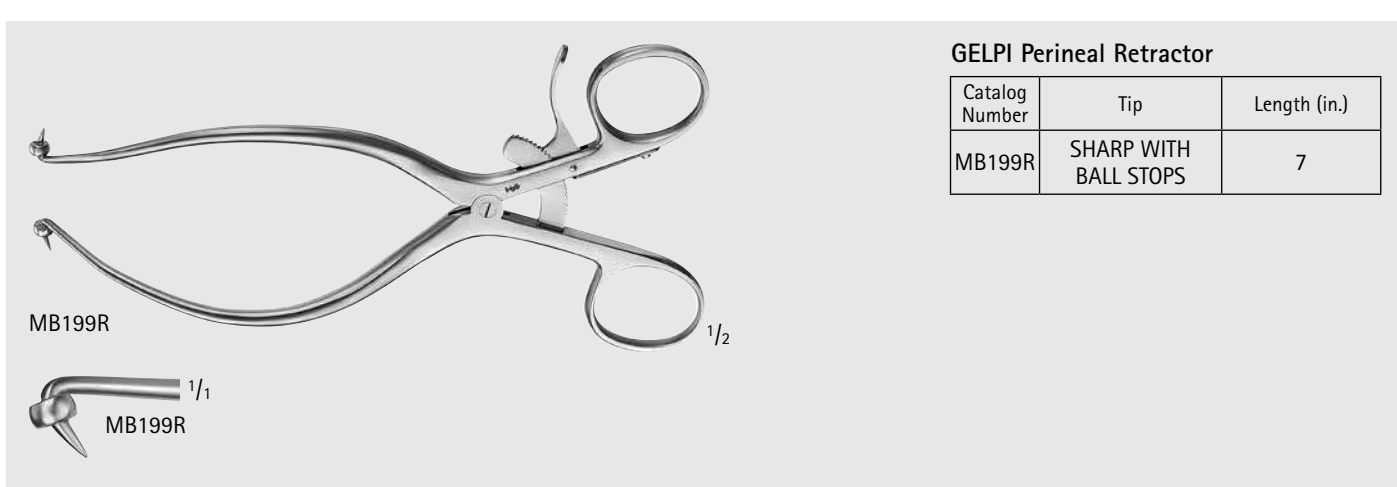

GELPI Perineal Retractor

Catalog Number	Tip	Length (in.)
MB199R	SHARP WITH BALL STOPS	7

MB199R ^{1/2}

MB199R ^{1/1}

GELPI Vaginal Retractor

Catalog Number	Tip	Length (in.)
MG176R	SHARP	3 1/2
BV996R	SHARP	5 1/4
BV997R	SHARP	6 7/8
MD651	SHARP	7 1/4
MG177R	BLUNT	4 1/2

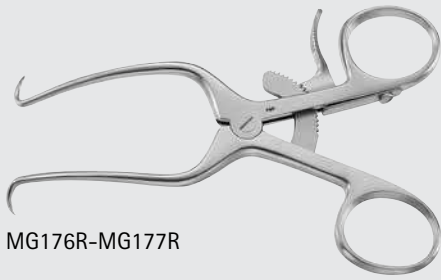

MG176R-MG177R

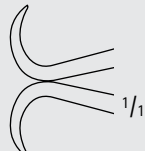

MG176R



MG177R



BV996R

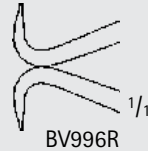

BV996R

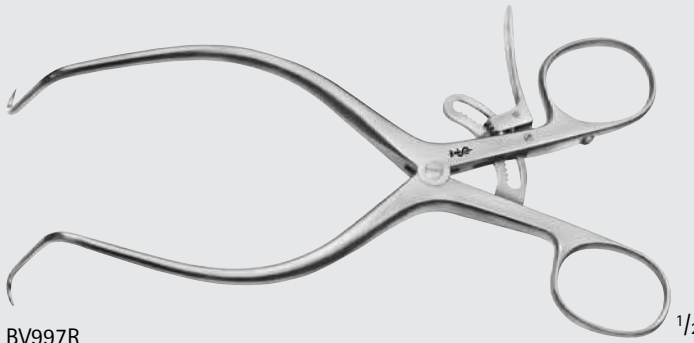

BV997R

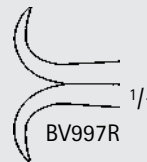

BV997R

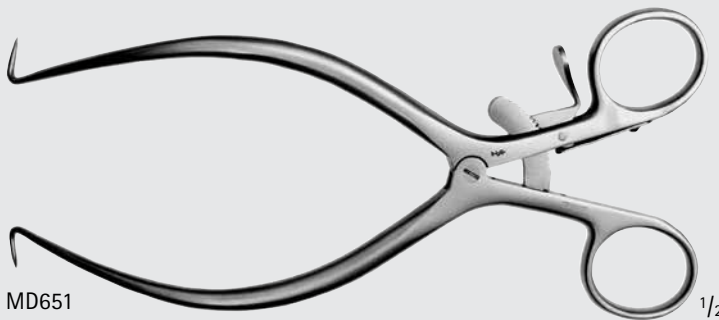

MD651



MD651



INCHES

General Surgery

Self Retaining Retractors

GENERAL SURGERY



BV998R

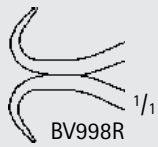

BV998R

DEBAKEY Femur Retractor for Children

Catalog Number	Tip	Length (in.)
BV998R	SHARP	4

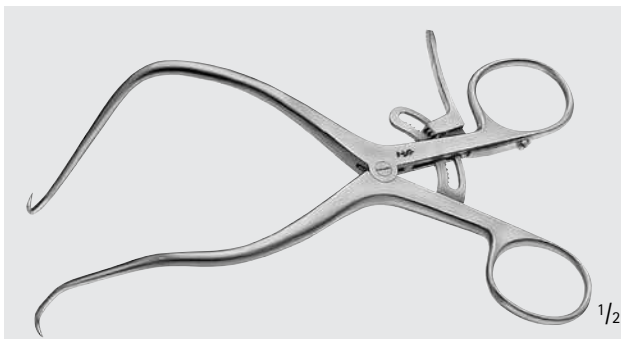

BV999R

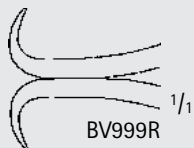

BV999R

DEBAKEY Femur Retractor for Adults

Catalog Number	Tip	Length (in.)
BV999R	SHARP	5 1/2

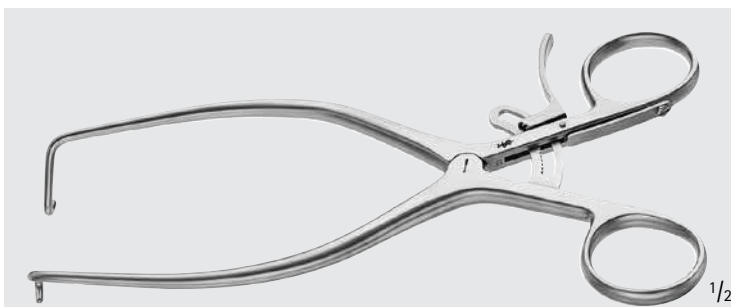

BV993R

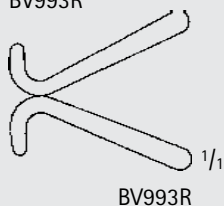

BV993R

JACKSON-BURROWS Retractor

Catalog Number	Tip	Length (in.)
BV993R	BLUNT	7

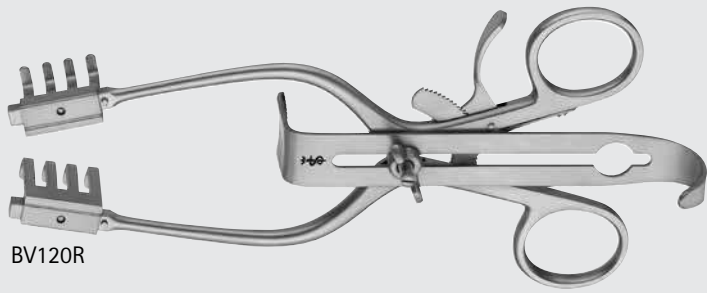

BV120R

HENLY Retractor

Catalog Number	Description	Blade Size (mm)	Blade Size (in.)	Length (in.)
BV120R	COMPLETE SET	-	-	7
MB842R	CENTER BLADE, SMALL	19 x 16	3/4 x 5/8	-
MB843R	CENTER BLADE, MEDIUM	25 x 16	1 x 5/8	-
MB844R	CENTER BLADE, LARGE	32 x 16	1 1/4 x 5/8	-
MB848R	CENTER BLADE, X-LARGE	76 x 16	3 x 5/8	-
MB845R	SIDE BLADE, PAIR (4 PRONGS)	25 x 25	1 x 1	-
MB846R	SIDE BLADE, PAIR (4 PRONGS)	51 x 25	2 x 1	-
MB847R	SIDE BLADE, PAIR (4 PRONGS)	76 x 22	3 x 1	-
MB849R	FRAME ONLY	-	-	7

BV120R Complete Set Includes:

- 1 Frame,
- 1 each of 4 Center Blades,
- 1 Pair of each of 3 Side Blades

Materials in set sold separately: MB842R-MB849R



MB842R 1/2

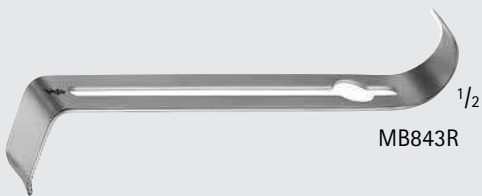

MB843R 1/2

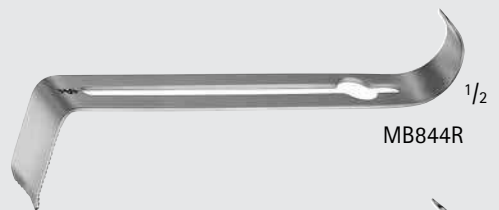

MB844R 1/2



MB848R 1/2



MB845R 1/2



MB846R 1/2



MB847R 1/2

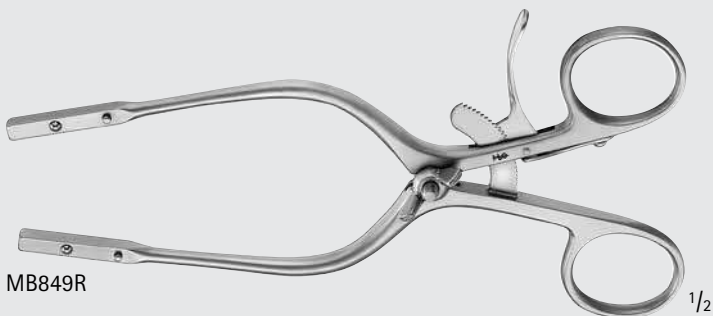

MB849R 1/2



General Surgery

Rectal Specula Instruments

GENERAL SURGERY

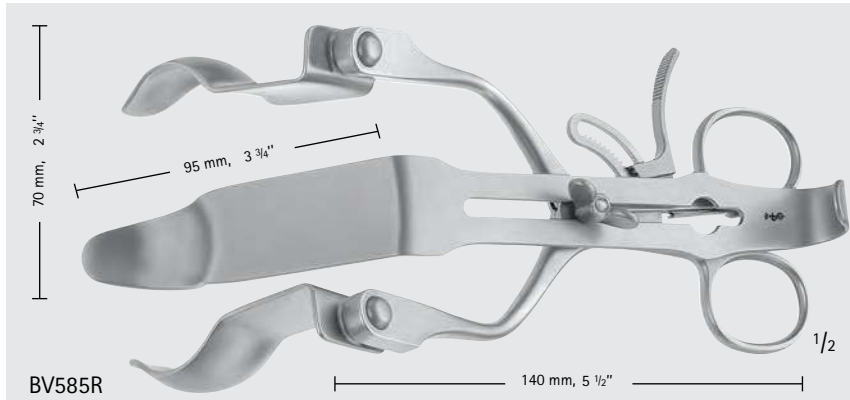

BV585R

PARKS Rectal Spreader

Catalog Number	Item	Length (mm)
BV585R	COMPLETE SET	-
BV581R	SPREADER ONLY	-
BV582R	CENTER BLADE	-
BV583R	SIDE BLADE, PAIR	70
BV586R	SIDE BLADE, PAIR	90
BV584R	SIDE BLADE, PAIR	93
BV589R	SIDE BLADE, PAIR	150

Set Includes:

- 1 Spreader BV581R
- 1 Center Blade BV582R
- 2 Blades of each BV583R and BV584R

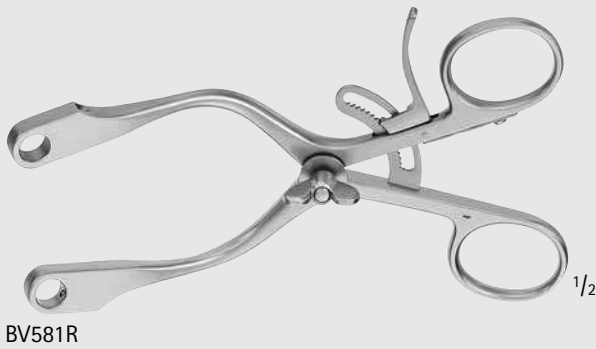

BV581R

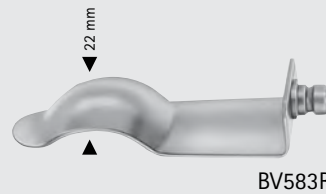

BV583R

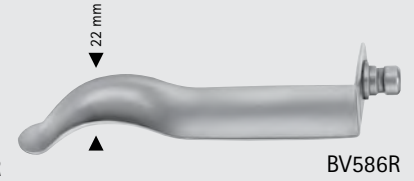

BV586R

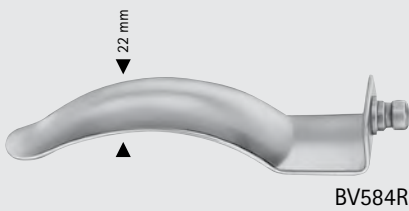

BV584R

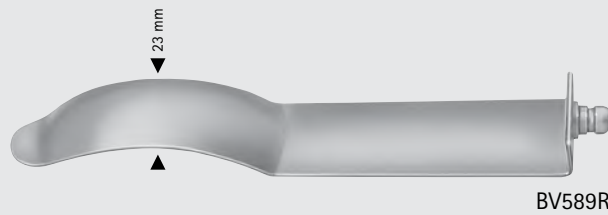

BV589R

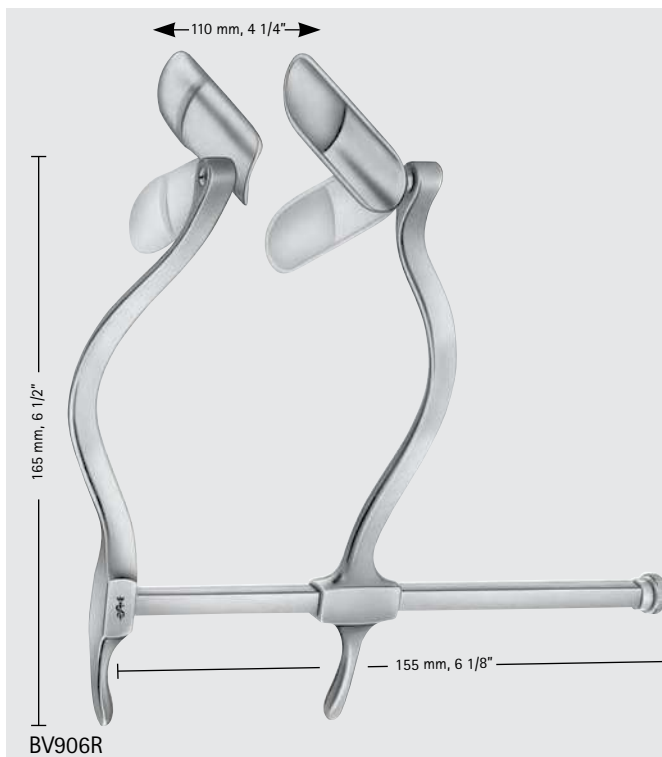

BV906R

SMITH-BUIE Rectal Retractor

Catalog Number	Blade Size (mm)
BV906R	58 x 23

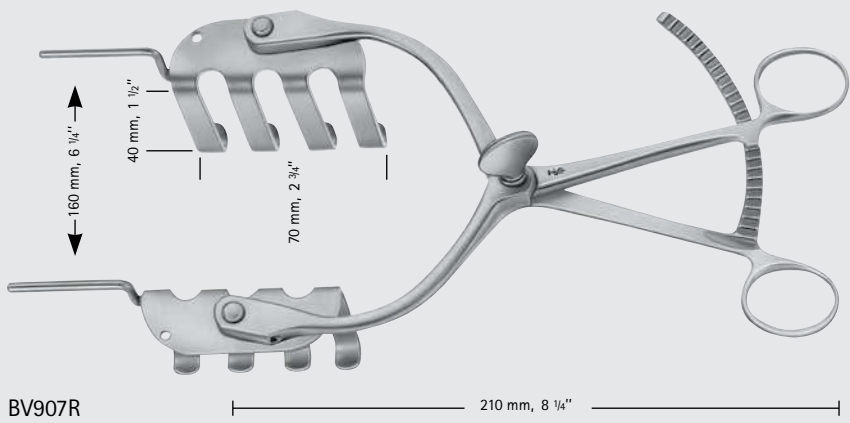

ST. MARKS MODIFIED GIRONA Perineal Retractor

Catalog Number	BV907R
----------------	--------

BV907R

Dimensions: 160 mm, 6 1/4"; 40 mm, 1 1/2"; 70 mm, 2 3/4"; 210 mm, 8 1/4"

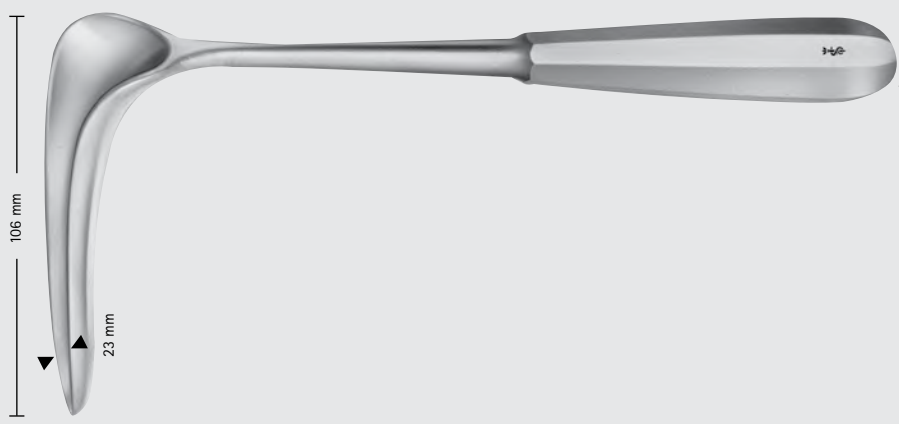

CZERNY Rectal Speculum

Catalog Number	Length (in.)
EA800R	8 7/8

EA800R

Dimensions: 106 mm; 23 mm; 1/2"



SAWYER Retractor

Catalog Number	Size	Blade Size (mm)	Length (in.)
MB773R	SMALL	70 x 19	10 3/4
MB772R	MEDIUM	82 x 29	10 3/4
MG178R	LARGE	97 x 38	11 5/8

MB772R-MG178R



General Surgery

Rectal Specula Instruments

GENERAL SURGERY

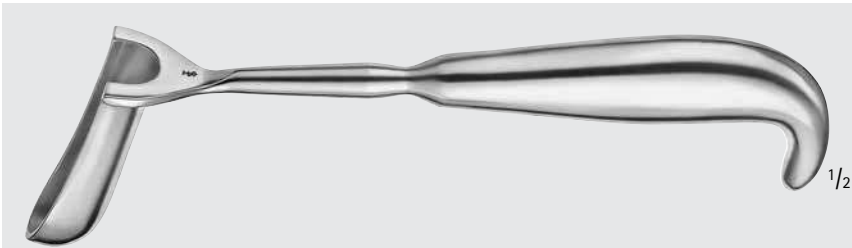
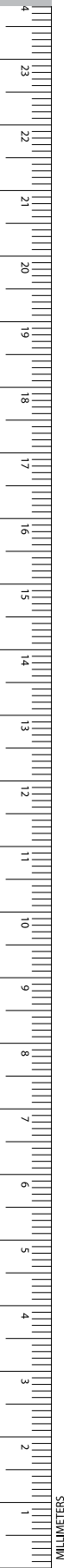

MB774R-MB776R

HILL-FERGUSSON Rectal Retractor

Catalog Number	Blade Size (mm)	Length (in.)
MB775R	64 x 24	8 1/4
MB774R	76 x 35	8 1/4
MB776R	76 x 32	8 1/4



EA820R

SIMS Rectal Speculum

Catalog Number	Blade	Length (in.)
EA820R	SOLID	6 1/4
EA821R	FENESTRATED	6 1/4



EA821R

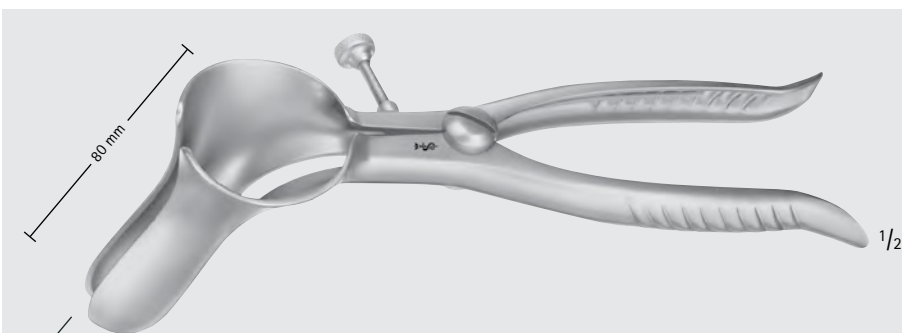

EA831R

PRATT Rectal Speculum

Catalog Number	Length (in.)
EA831R	8

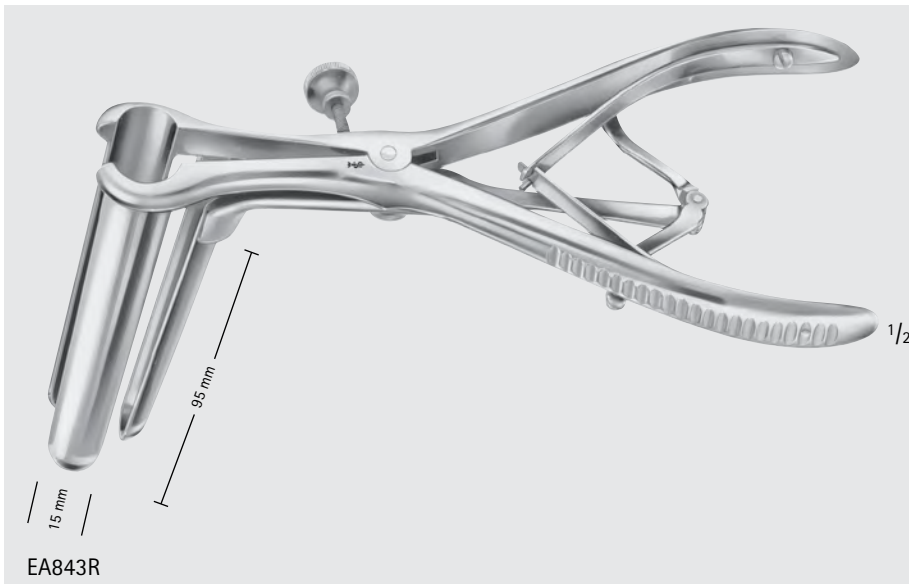

MATHIEU Rectal Speculum

Catalog Number	Length (in.)
EA843R	8 1/2



IVES-FANSLER Anuscope

Catalog Number	Length (in.)
EA880R	5 3/4



Rectal Speculum

Catalog Number	Length (in.)
MB274R	2 3/8



General Surgery

Rectal Specula Instruments

GENERAL SURGERY

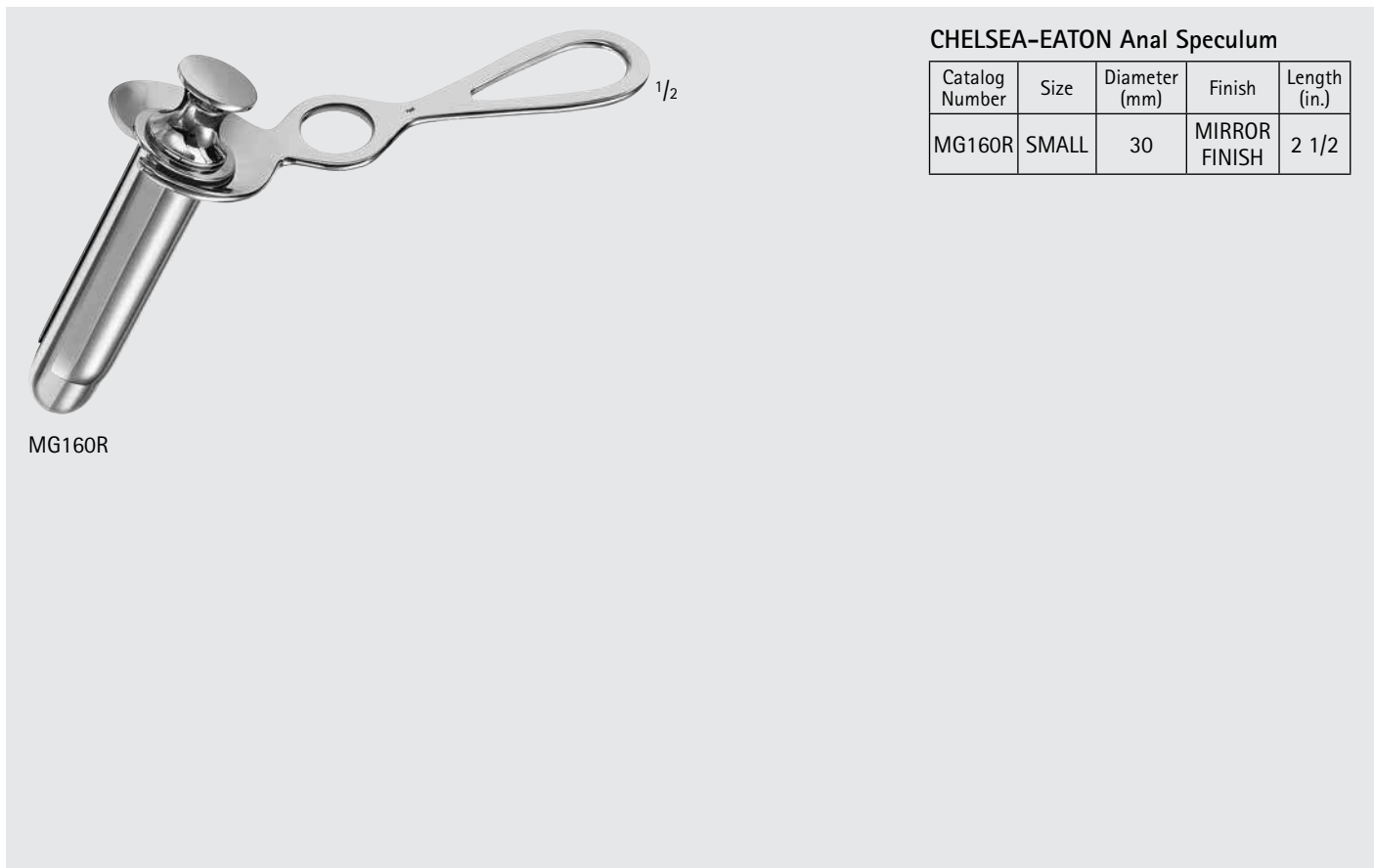
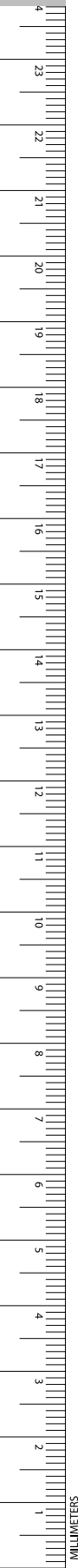

MG160R

CHELSEA-EATON Anal Speculum

Catalog Number	Size	Diameter (mm)	Finish	Length (in.)
MG160R	SMALL	30	MIRROR FINISH	2 1/2

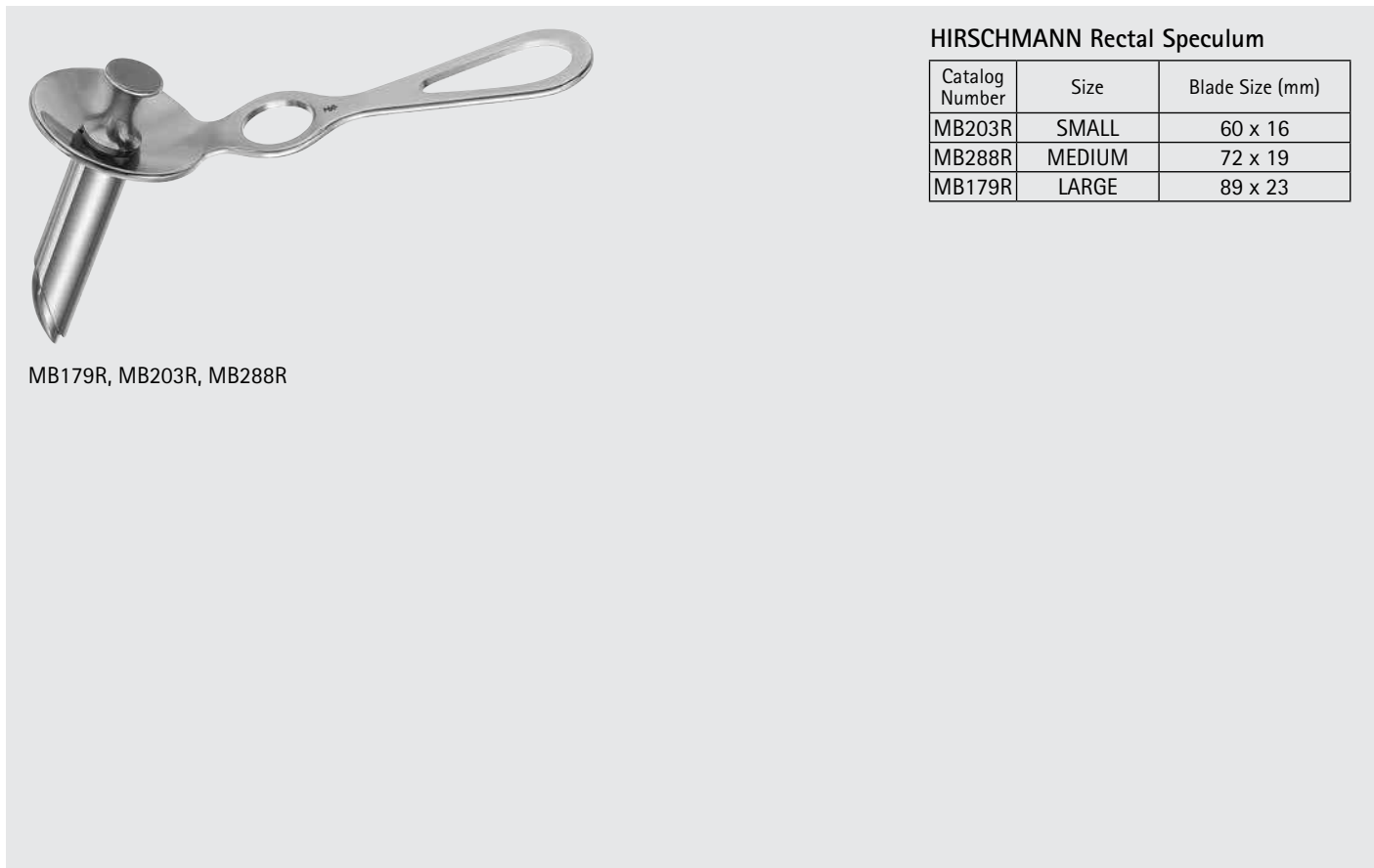

MB179R, MB203R, MB288R

HIRSCHMANN Rectal Speculum

Catalog Number	Size	Blade Size (mm)
MB203R	SMALL	60 x 16
MB288R	MEDIUM	72 x 19
MB179R	LARGE	89 x 23



MB284R, MG162R-MG163R

BRINKERHOFF Rectal Speculum

Catalog Number	Size	Diameter (in.)	Length (in.)
MG162R	SMALL	1/2 x 1	3 3/4
MG163R	MEDIUM	5/8 x 1	3 3/4
MB284R	LARGE	3/4 x 1 1/4	4 1/2



EA882R-EA887R

KELLY Sphincteroscope

Catalog Number	Diameter (mm)	Working Length (mm)	Length (in.)
EA882R	21	54	6 1/4
EA887R	22	140	5 1/2
EA883R	25	50	6 1/4



General Surgery

Rectal Specula Instruments

GENERAL SURGERY

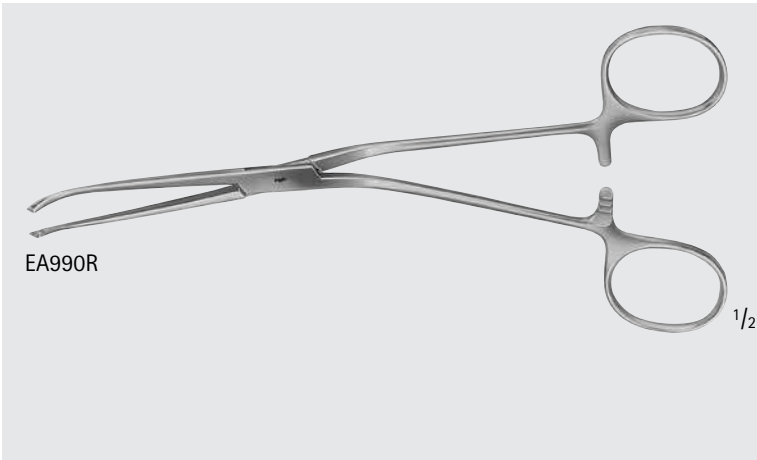
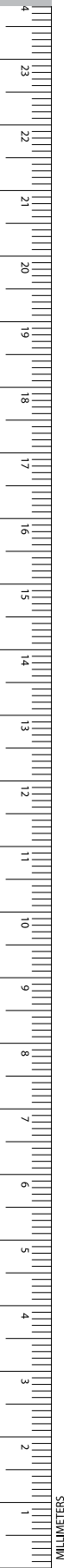

MCGIVNEY Hemorrhoidal Forceps

Catalog Number	Length (in.)
EA990R	7 1/4

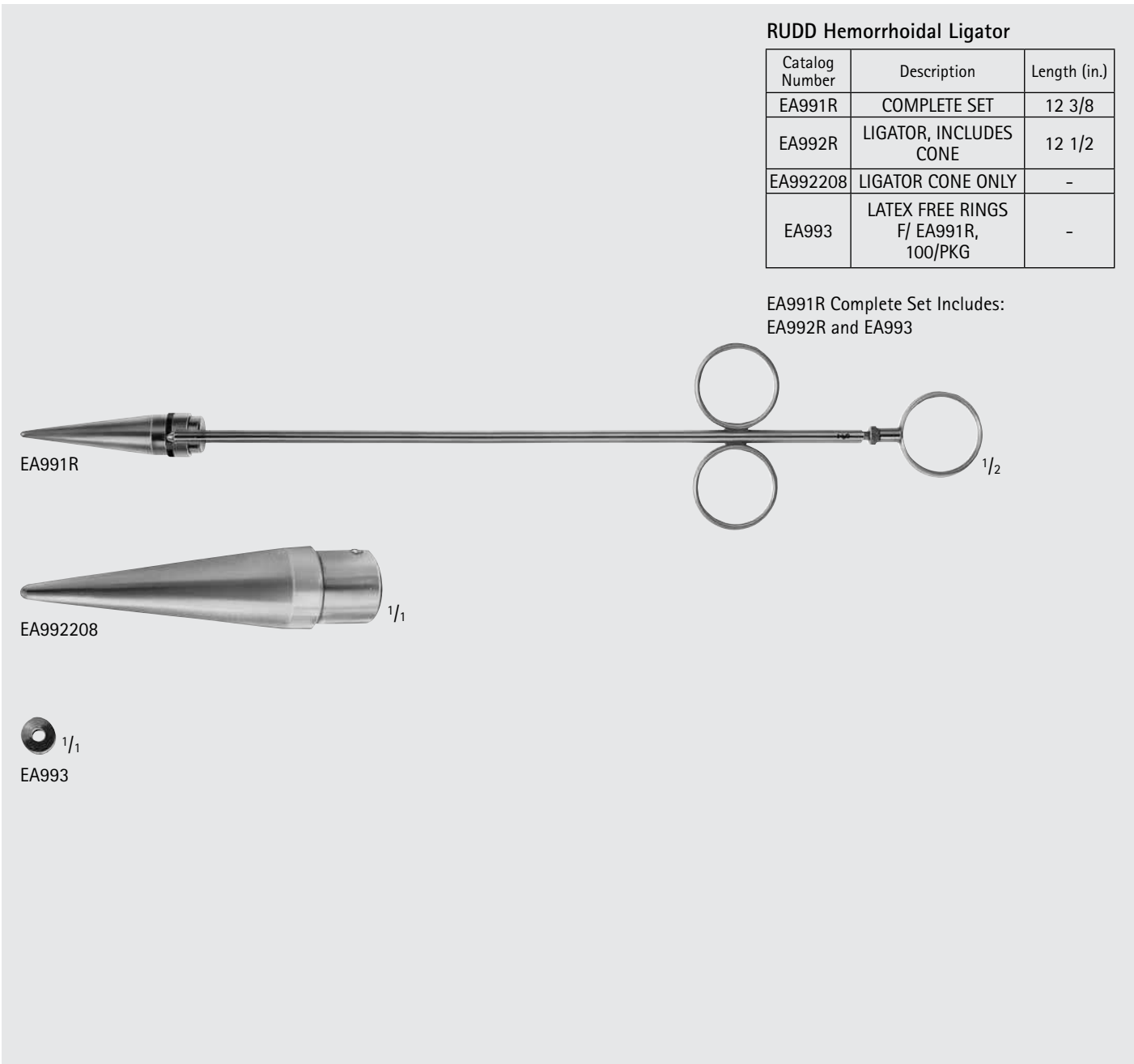

RUDD Hemorrhoidal Ligator

Catalog Number	Description	Length (in.)
EA991R	COMPLETE SET	12 3/8
EA992R	LIGATOR, INCLUDES CONE	12 1/2
EA992208	LIGATOR CONE ONLY	-
EA993	LATEX FREE RINGS F/ EA991R, 100/PKG	-

EA991R Complete Set Includes:
EA992R and EA993

STEWART Crypt Hook

Catalog Number	Length (in.)
MB892R	9



MB892R



MB892R



INCHES

General Surgery

Probes, Dilators and Scoops

GENERAL SURGERY

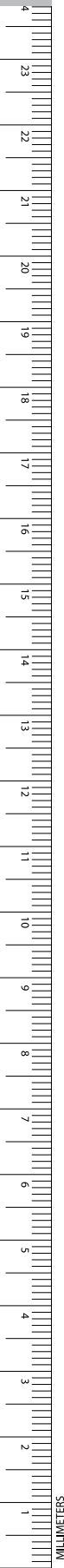

BAKES Bile-Duct Dilator

Catalog Number	Tip Size (mm)	Length (in.)
EB061R	1	12 3/8
EB062R	2	12 3/8
EB063R	3	12 3/8
EB064R	4	12 3/8
EB065R	5	12 3/8
EB066R	6	12 1/2
EB067R	7	12 1/2
EB068R	8	12 1/2
EB069R	9	12 1/2
EB070R	10	12 1/2
EB071R	11	12 1/2
EB072R	12	12 1/2
EB073R	13	12 1/2
EB074R	SET, 3-11 mm	-



EB061R-EB074R

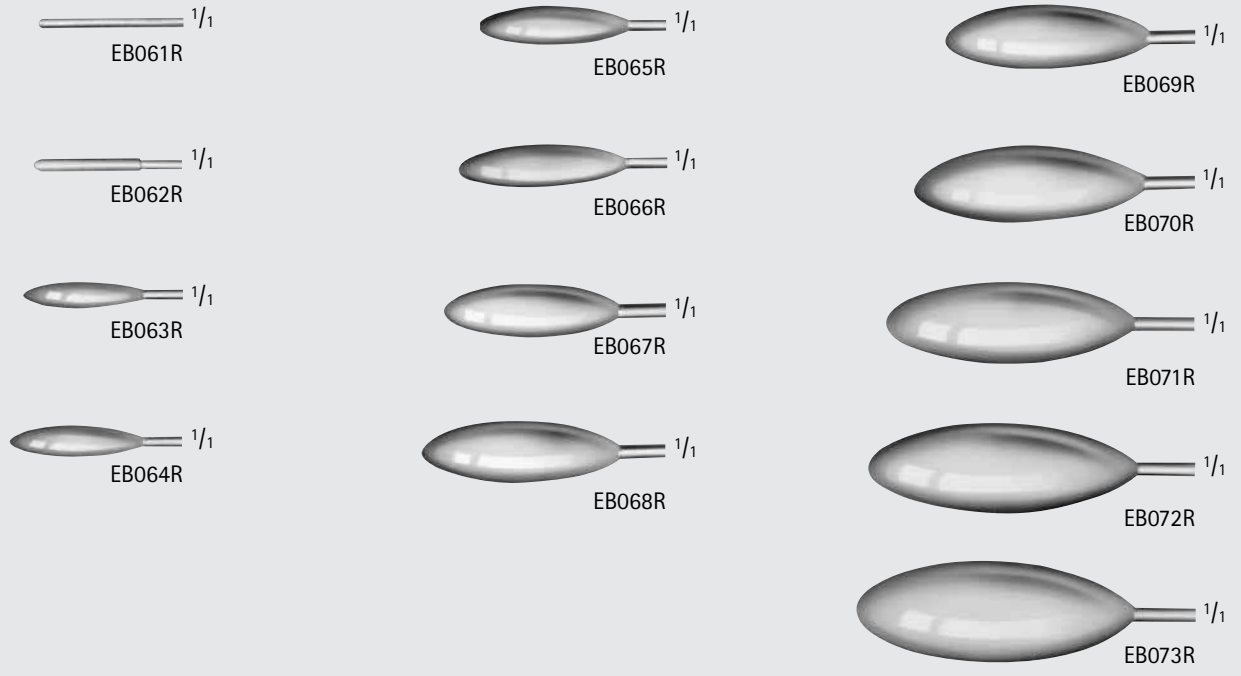

EB061R 1/1

EB065R 1/1

EB069R 1/1

EB062R 1/1

EB066R 1/1

EB070R 1/1

EB063R 1/1

EB067R 1/1

EB071R 1/1

EB064R 1/1

EB068R 1/1

EB072R 1/1

EB073R 1/1

LUER-KOERTE Scoops, Malleable Shaft

Catalog Number	Tip Size (mm)	Length (in.)
EB168R	2.8	12 3/4
EB169R	3.4	12 3/4
EB170R	4.3	12 3/4
EB171R	5.5	12 3/4
EB172R	6.7	12 3/4
EB173R	8.0	12 3/4
EB174R	11.0	12 3/4
EB175R	15.0	12 3/4

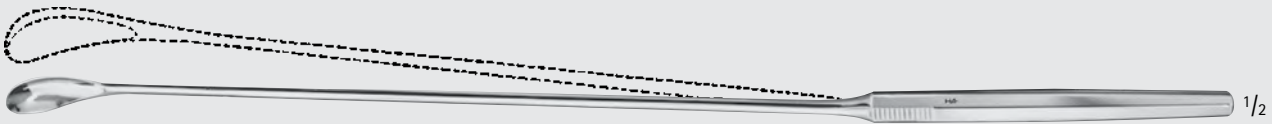

EB168R-EB175R

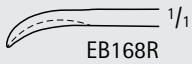

EB168R

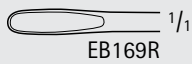

EB169R

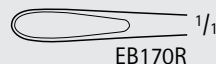

EB170R

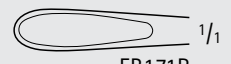

EB171R

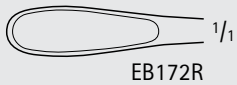

EB172R

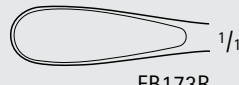

EB173R



EB174R

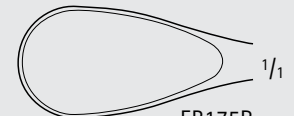

EB175R



BN003R-BN006R

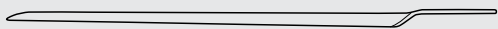

BN003R-BN006R

Director W/ Tongue

Catalog Number	Blade Shape	Length (in.)
BN003R	STR	5 1/8
BN004R	STR	5 3/4
BN006R	STR	6 1/4



BN010R

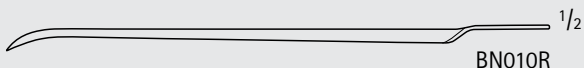

BN010R

DOYEN Director W/ Tongue

Catalog Number	Blade Shape	Length (in.)
BN010R	CVD	5 3/4

General Surgery

Probes, Dilators and Scoops

GENERAL SURGERY



MB336R

Grooved Director W/ Tongue

Catalog Number	Length (in.)
MB336R	4 1/2

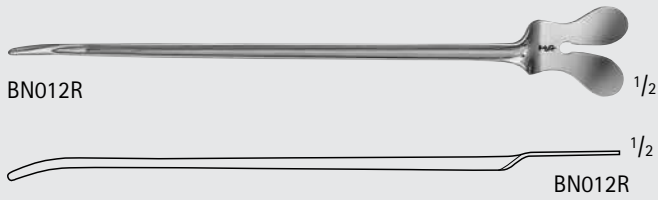

BN012R

BN012R

NELATON Director

Catalog Number	Blade Shape	Length (in.)
BN012R	CVD	6 1/4

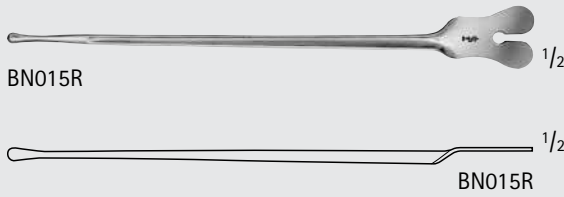

BN015R

BN015R

Director, W/ Probe Tip & Tongue

Catalog Number	Diam. of Tip (mm)	Blade Shape	Length (in.)
BN015R	3.3	STR	5 1/2

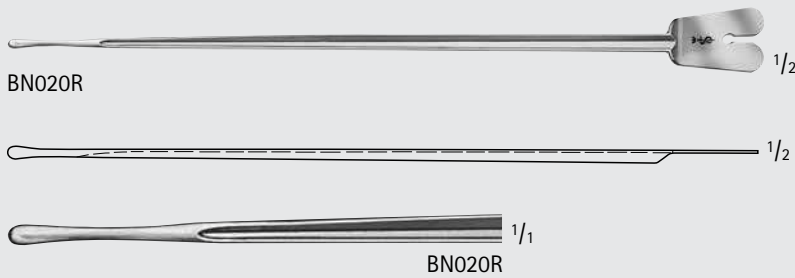

BN020R

BN020R

BRODIE Director, W/ Probe Tip & Tongue

Catalog Number	Diam. of Tip (mm)	Blade Shape	Length (in.)
BN020R	3.5	STR	7 7/8

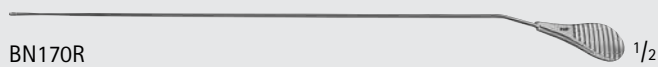

BN170R

Probe

Catalog Number	Diam. of Tip (mm)	Length (in.)
BN170R	1.4	6 1/4

LOCKHART-MUMMERY Fistula Probe

Catalog Number	Blade Shape	Length (in.)
BN021R	#1-STR	6 1/2
BN022R	#2-SLT-CVD	6 1/2
BN023R	#3-CVD	6 1/2
BN024R	#4-HVY-CVD	6 1/2

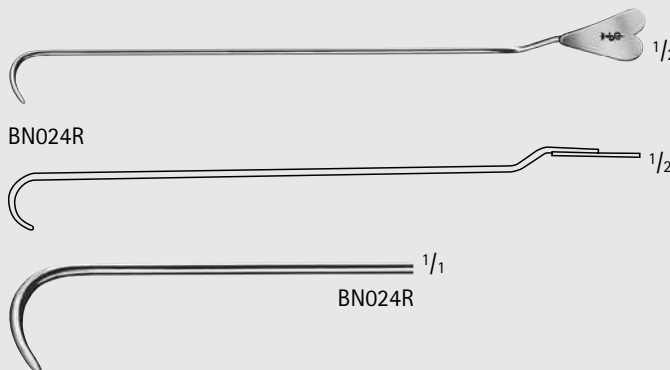
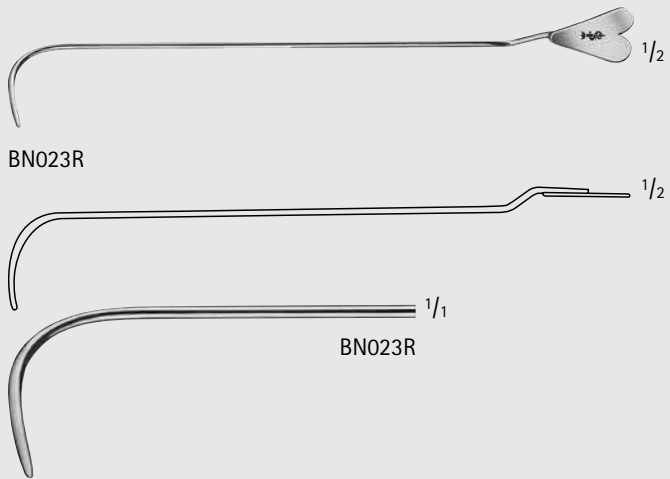
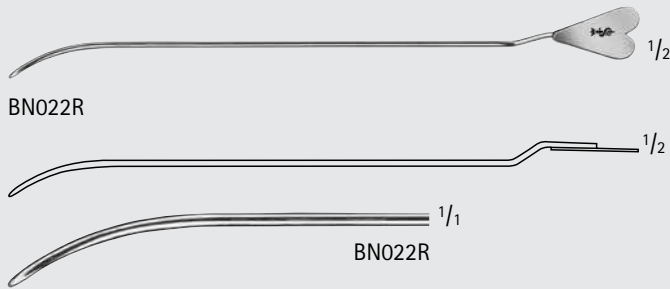
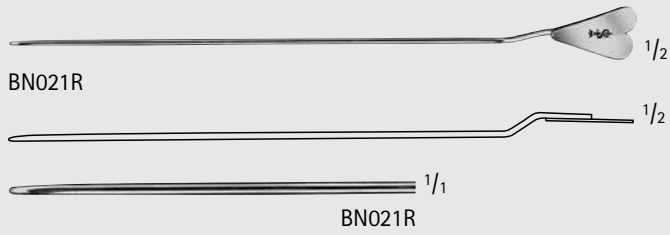

General Surgery

Probes, Dilators and Scoops

GENERAL SURGERY

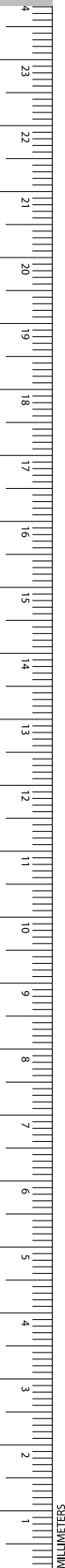

MG168R-MG169R

BUIE Fistula Probe

Catalog Number	Description	Length (in.)
MG168R	LIGHT	6 1/2
MG169R	HEAVY	6 1/2



BN034R-BN040R, MB603R

Probe W/ Eye

Catalog Number	Tip Size (mm)	Length (in.)
MB603R	1.5	5
BN034R	2.5	5 3/4
BN036R	2.5	6 1/4
BN040R	3	7 7/8



MG571

Probe W/ Eye, Silver

Catalog Number	Tip Size (mm)	Length (in.)
MG571	1.75	4 1/2



BN054R



BN063R-BN070R

Myrtle Leaf Probe

Catalog Number	Tip Size (mm)	Length (in.)
BN054R	1.5	5 3/4
BN063R	2	5 1/8
BN064R	2	5 3/4
BN066R	2	6 1/4
BN068R	2	7
BN070R	2	7 7/8

BN104R-BN150R

Double Ended Probe

Catalog Number	Tip Size (mm)	Length (in.)
BN104R	1.0	5 3/4
BN113R	1.5	5 1/8
BN114R	1.5	5 3/4
BN116R	1.5	6 1/4
BN118R	1.5	7
BN120R	1.5	7 7/8
BN125R	1.5	9 3/4
BN134R	2.0	5 3/4
BN136R	2.0	6 1/4
BN138R	2.0	7
BN140R	2.0	7 7/8
BN150R	2.0	11 3/4

BN090R

1/2

Double Ended Probe W/ Eye, Malleable

Catalog Number	Tip Size (mm)	Length (in.)
BN090R	3.0	7 1/2
BN095	3.5	9 3/4
BN096	3.5	11 3/4

BN095-BN096

PRATT Rectal Probe, Malleable

Catalog Number	Tip Size (mm)	Length (in.)
MB486	2.0	10

MB486

1/2

Probe

Catalog Number	Tip Size (mm)	Length (in.)
BN101R	2.0	11 3/4

BN101R

1/2



INCHES

General Surgery

Probes, Dilators and Scoops

GENERAL SURGERY



FERGUSSON Gall Stone Scoop, Double Ended

Catalog Number	Size	Length (in.)
MB697R	SMALL	9 1/2
MB698R	MEDIUM	9 1/2
MB699R	LARGE	9 1/2



MB697R-MB699R



MB697R-MB699R

BARR Fistula Probe, Double Ended

Catalog Number	Length (in.)
MG170R	6 5/8



MG170R

PRATT Fistula Probe, Crypt Hook

Catalog Number	Length (in.)
EA890R	9 1/2



EA890R

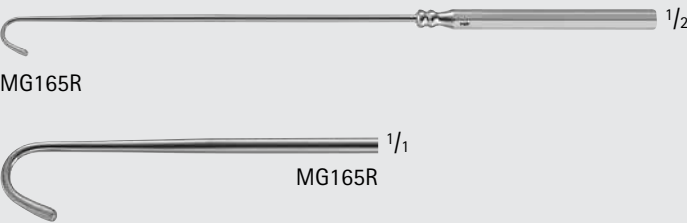

MG165R 1/2

MG165R 1/1

ROSSER Crypt Hook

Catalog Number	Length (in.)
MG165R	6 5/8

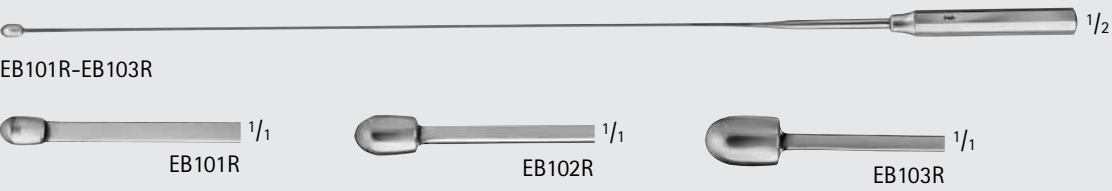

EB101R-EB103R 1/2

EB101R 1/1

EB102R 1/1

EB103R 1/1

DESJARDINS Gall Duct Probe, Flexible

Catalog Number	Tip Size (mm)	Length (in.)
EB101R	3.8	11 1/4
EB102R	4.3	11 1/4
EB103R	6.8	11 1/4

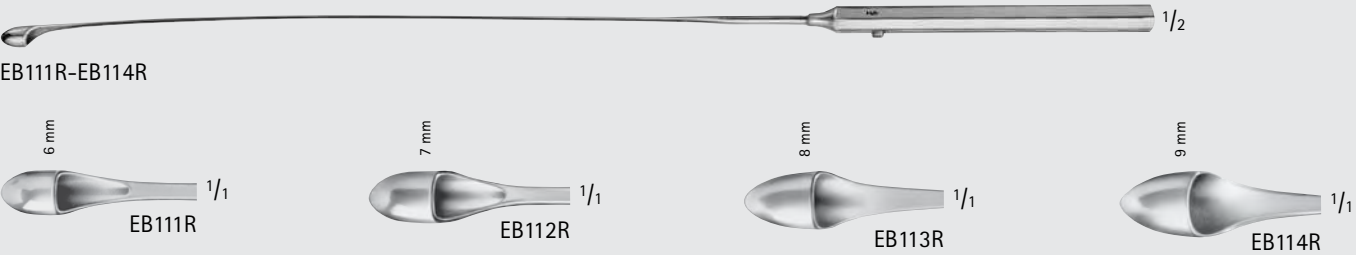

EB111R-EB114R 1/2

6 mm 1/1

EB111R

7 mm 1/1

EB112R

8 mm 1/1

EB113R

9 mm 1/1

EB114R

DESJARDINS Gall Stone Scoop

Catalog Number	Tip Size (mm)	Length (in.)
EB111R	6	11 3/4
EB112R	7	11 3/4
EB113R	8	11 3/4
EB114R	9	11 3/4



E0005R 1/2

MAYO Gall Duct Probe

Catalog Number	Tip Size (mm)	Tip	Length (in.)
E0005R	5	MALLEABLE	13



General Surgery

Scalpel Handles

GENERAL SURGERY



Micro Scalpel Handle

Catalog Number	Size	Length (in.)	Handle
MB104R	3H	4	Hexagonal
MB141R	3HL	6	Hexagonal
MB280R	3KM	3	Round Knurled
MB997R	3K	4	Round Knurled
MB281R	3KD	5	Round Knurled
BB046R	3K	5 1/4	Round Knurled
MB271R	3KL	6	Round Knurled
BB048R	3KL	6 1/8	Round Knurled
MG221R	3	7	Round Knurled
BB054R	3	7 7/8	Round Knurled
MG222R	3	8	Round Knurled
BB060R	3	17 3/4	Round Knurled
MB475R	COLLET		



MB104R



MB141R



MB280R



MB997R



MB281R



BB046R



MB271R



BB048R

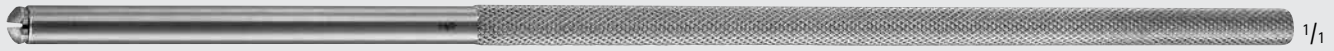

MG221R



BB054R



MG222R

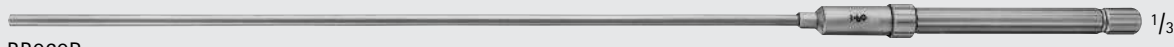

BB060R



MB475R

MB475R

Replacement collet for MB104R, MB141R, MB271R, MB280R, MB281R and MB997R

CORWIN Knife Handle

Catalog Number	Length (in.)
MA203R	5 1/2



CASPAR Scalpel Handle

Catalog Number	Length (in.)
BB052R	7



**LANDOLT Scalpel Handle,
F/ Microsurgery Blades**

Catalog Number	Length (in.)
BB053R	8 1/4
BB057R	9 3/4

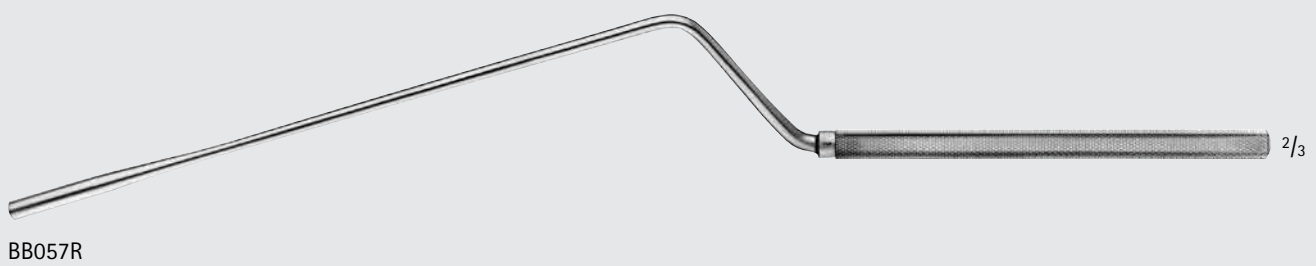
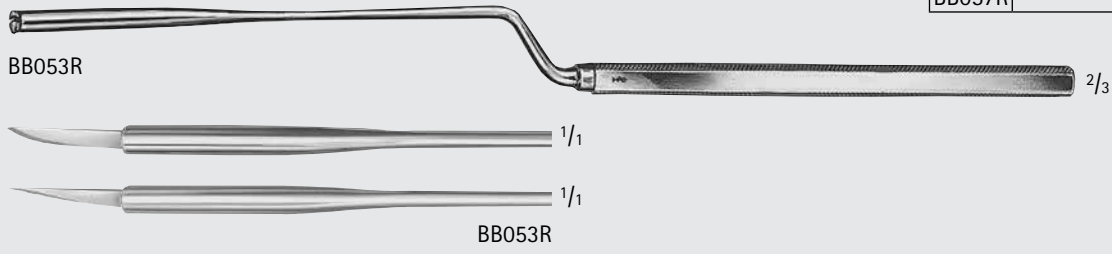

**YASARGIL Arachnoid Blades
F/ LANDOLT Scalpel Handles**

Catalog Number	Tip Size (mm)	Packaging
BB331R	1.5	10/BOX
BB332R	2.5	10/BOX



General Surgery

Scalpel Handles

GENERAL SURGERY

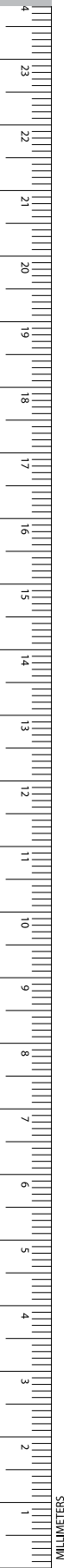

Transsphenoidal Scalpel Handle, Bayonet, F/ Vertical and Lateral Blades

Catalog Number	Length (in.)
BB071R	8 1/4

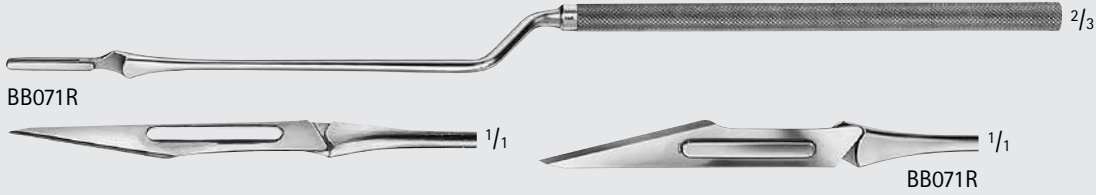

Sterile Microsurgery Blades

Catalog Number	Tip	Packaging
BB361R	SMALL CHISEL #61	10/BOX
BB362R	WIDE CHISEL #62	10/BOX
BB363R	SPEAR #63	1 EACH
BB364R	ROUND #64	10/BOX
BB365R	SMALL, SHARP #65	10/BOX
BB367R	CURVED, POINTED #67	10/BOX
BB368R	SMALL SICKLE #68	10/BOX

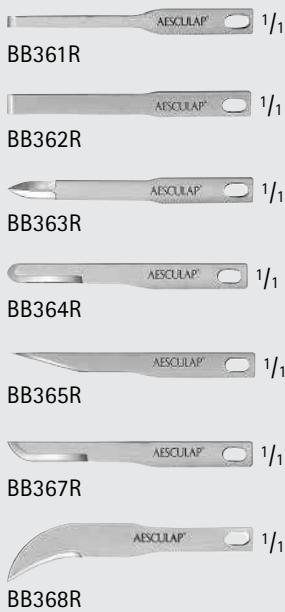

BARRON Scalpel Handle #3 F/ Blades nos. 10-15, 40, 42

Catalog Number	Length (in.)
BB068R	5 1/8



Scalpel Handle #3, F/ Blades nos. 10-15, 40, 42

Catalog Number	Length (in.)
BB070R	6 1/8



Scalpel Handle #3, F/ Blades nos. 10-15, 40, 42

Catalog Number	Size	Length (in.)
BB074R	#3	5
BB075R	#3L	8 1/4
BB175R	#3XL	9 3/4
MB917R	#3	16



BB074R

1/1



BB075R

2/3



BB175R

1/2



MB917R

1/3

Scalpel Handle #3L, F/ Blades nos. 10-15, 40, 42

Catalog Number	Blade Shape	Length (in.)
MB127R	ANG	8



MB127R

2/3



BB078R

1/2

Scalpel X-Long Handle, #3, F/ Blades nos. 10-15, 40, 42

Catalog Number	Blade Shape	Length (in.)
BB078R	STR	8 7/8



INCHES

General Surgery

Scalpel Handles

GENERAL SURGERY

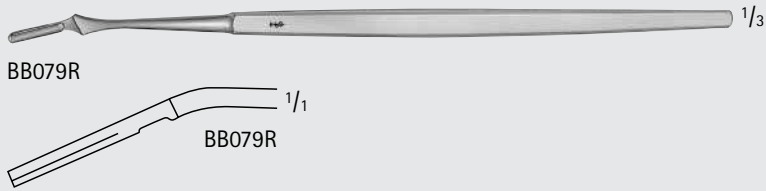
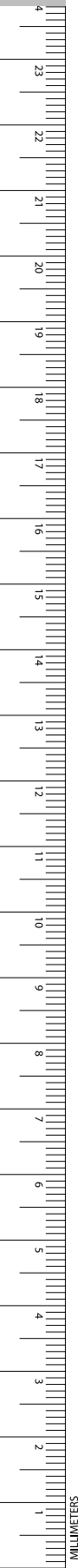

BB079R

Scalpel X-Long Handle, #3, F/ Blades nos. 10-15, 40, 42

Catalog Number	Blade Shape	Length (in.)
BB079R	ANG	8 7/8



BB080R

Scalpel Handle #4, F/ Blade nos. 18-36

Catalog Number	Length (in.)
BB080R	8 7/8

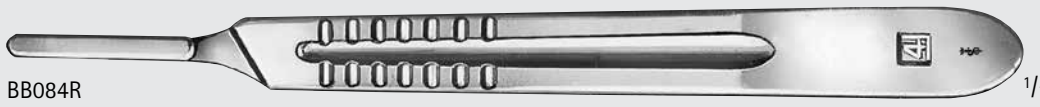

BB084R

Scalpel Handle #4, F/ Blades nos. 18-36

Catalog Number	Length (in.)
BB084R	5 1/4



BB085R

Scalpel Handle #4L, F/ Blades nos. 18-36

Catalog Number	Length (in.)
BB085R	8 1/2

Scalpel Handle #4XL, F/ Blades nos. 18-36

Catalog Number	Length (in.)
BB087R	9 3/4



Scalpel Handle #7, F/ Blades nos. 10-15, 40, 42

Catalog Number	Length (in.)
BB077R	6 1/4



Scalpel Handle #9XL, F/ Blades nos. 18-36

Catalog Number	Length (in.)
MA202R	4 5/8
BB089R	5 3/4



INCHES

General Surgery

Scalpel Blades



BB510, 16600495



BB515, 16600525



BB511, 16600509



BB540 double cutting



BB512, 16600517

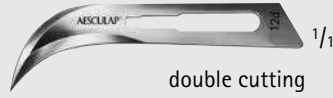

BB542 double cutting

Sterile Scalpel Blade, For #3 Handle

Catalog Number		Blade Number	Packaging
Carbon	Stainless Steel		
BB510	16600495	#10	100/BOX
BB511	16600509	#11	100/BOX
BB512	16600517	#12	100/BOX
BB515	16600525	#15	100/BOX
BB540	-	#40	100/BOX
BB542	-	#42	100/BOX



BB520, 16600550



BB521, 16600568



BB522, 16600576



BB523, 16600584



BB524, 16600592



BB525, 16616634



BB536, 16615522

Sterile Scalpel Blade, For #4 Handle

Catalog Number		Blade Number	Packaging
Carbon	Stainless Steel		
BB520	16600550	#20	100/BOX
BB521	16600568	#21	100/BOX
BB522	16600576	#22	100/BOX
BB523	16600584	#23	100/BOX
BB524	16600592	#24	100/BOX
BB525	16616634	#25	100/BOX
BB536	16615522	#36	100/BOX



BB500, 16600487

Sterile Stitch Cutter Blade #3 Handle

Catalog Number		Packaging
Carbon	Stainless Steel	
BB500	16600487	100/BOX

GENERAL SURGERY



Sterile Scalpels W/ Plastic Handle and Blade Protector

Catalog Number		Size	Packaging
Carbon	Stainless Steel		
BA210	5518059	10	10/BOX
BA211	5518040	11	10/BOX
BA212	5518105	12	10/BOX
BA215	5518032	15	10/BOX
BA218	-	18	10/BOX
BA219	-	19	10/BOX
BA220	5518067	20	10/BOX
BA221	5518075	21	10/BOX
BA222	5518083	22	10/BOX
BA223	5518016	23	10/BOX
BA224	5518091	24	10/BOX



General Surgery

Amputation and Autopsy Instruments

GENERAL SURGERY

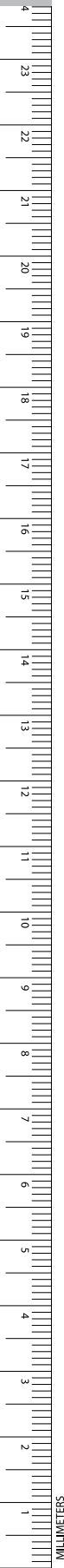

LISTON Amputating Knife

Catalog Number	Blade Length (mm)	Blade Size (in.)
FH100R	130	5 1/8
FH101R	160	6 1/4
FH102R	190	7 1/2
FH103R	220	8 3/4



FH100R-FH103R

CATLIN Amputating Knife, Double Cutting

Catalog Number	Blade Length (mm)	Blade Size (in.)
FH116R	160	6 1/4



FH116R

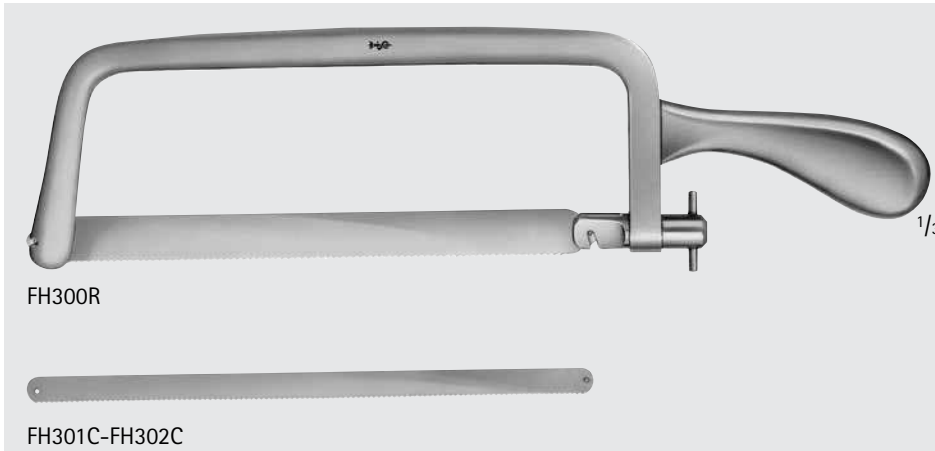

CHARRIÈRE Amputation Saw, 2 Blades

Catalog Number	Item	Blade Size (in.)	Blade Width (mm)	Total Length (in.)
FH300R	SAW COMPLETE W/2 BLADES	8 1/2	-	14
FH301C	CARBON STEEL BLADE	8 1/2	12	-
FH302C	CARBON STEEL BLADE	8 1/2	18	-



CHARRIÈRE Amputation Saw

Catalog Number	Item	Blade Size (in.)	Total Length (in.)
FH320R	SAW COMPLETE	7 1/4	10 1/2



SATTERLEE Amputation Saw

Catalog Number	Item	Total Length (in.)
FH325R	SAW COMPLETE	11 1/2
FH326R	CARBON STEEL BLADE F/ FH325R	-



General Surgery

Amputation and Autopsy Instruments

GENERAL SURGERY

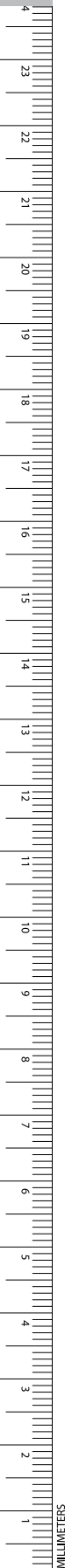



FH335R 1/2

LANGENBECK Metacarpal Saw

Catalog Number	Length (in.)
FH335R	9 1/4



FH414-FH415, FH430R



FH414-FH415, FH430R 5/1

GIGLI Wire Saw

Catalog Number	Diameter (mm)	Wires	Sales Unit	Length (in.)
FH414	1.4	6	BOX OF 5	15 3/4
FH415	1.4	6	BOX OF 5	19 3/4
FH430R	1.8	4	BOX OF 5	19 3/4



MB986R

GIGLI Saw Handle

Catalog Number	Packaging
MB986R	2/SET



FH480R 1/2

GIGLI Hook Handle, F/ Wire Saws

Catalog Number	Packaging
FH480R	2/SET

POOLE Suction Tube

Catalog Number	Handle	Tip Size (FR)	Hole in Tip Inner/Outer	Tube Diameter Inner/Outer	Length (in.)
MG272R	STR	30	YES/YES	5 mm/10 mm	8 1/2
GF862R	STR	30	YES/NO	5 mm/10 mm	8 7/8
MB927R	STR	30	YES/YES	4 mm/10 mm	14
MB928R	STR	30	YES/YES	4 mm/10 mm	16
MG271R	CVD	24	YES/NO	4 mm/8 mm	8 3/4
GF860R	CVD	21	YES/YES	4 mm/8 mm	8 7/8



MG272R



GF862R



MB927R-MB928R



MB927R



MB928R



MG271R





GF860R



General Surgery

Suction Tubes

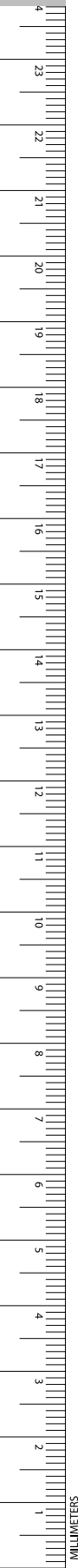
GENERAL SURGERY

Diam. 4 mm

Olive Diam. 9 mm

1/2

GF917R

ADSON Suction Tube

Catalog Number	Tip Size (mm)	Tip Size (FR)	Length (in.)
GF917R	4	11	7 1/2



Olive Diam. 6 - 9 mm

1/2

GF919R

Nasal Suction Tube W/ Luer Hub, Tapered

Catalog Number	Tip Size (mm)	Length (in.)
GF919R	5	7



Diam. 8 mm Outer Tube

1/2

Olive Diam. 9 - 11 mm

GF821R

COOLEY Suction Tube

Catalog Number	Tip Size (mm)	Length (in.)
GF821R	8.0	13 1/4

COOLEY Suction Tube W/ Detachable Tip

Catalog Number	Tip Size (mm)	Shaft	Length (in.)
GF822R	8.0	SLT-CVD	12 1/4
GF823R	9.0	CVD	11 5/8
GF824R	8.0	ANG	12 1/2
GF825R	9.0	90°	10 1/2



GF822R

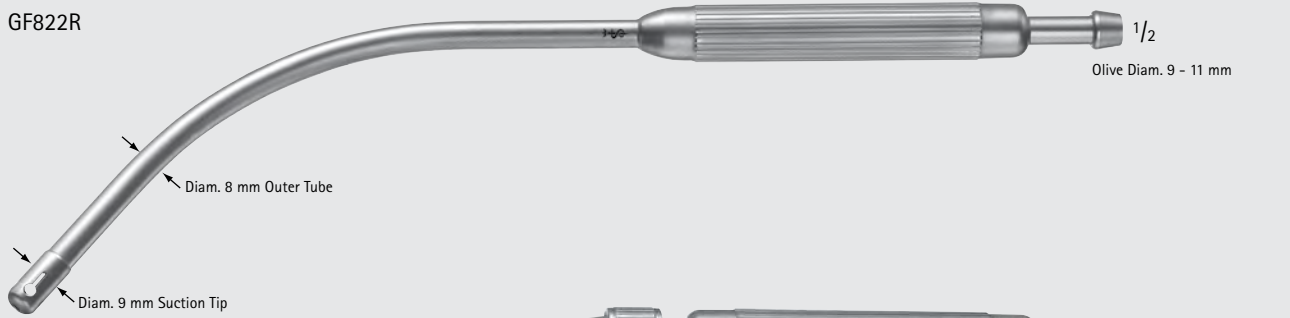

GF823R



GF824R

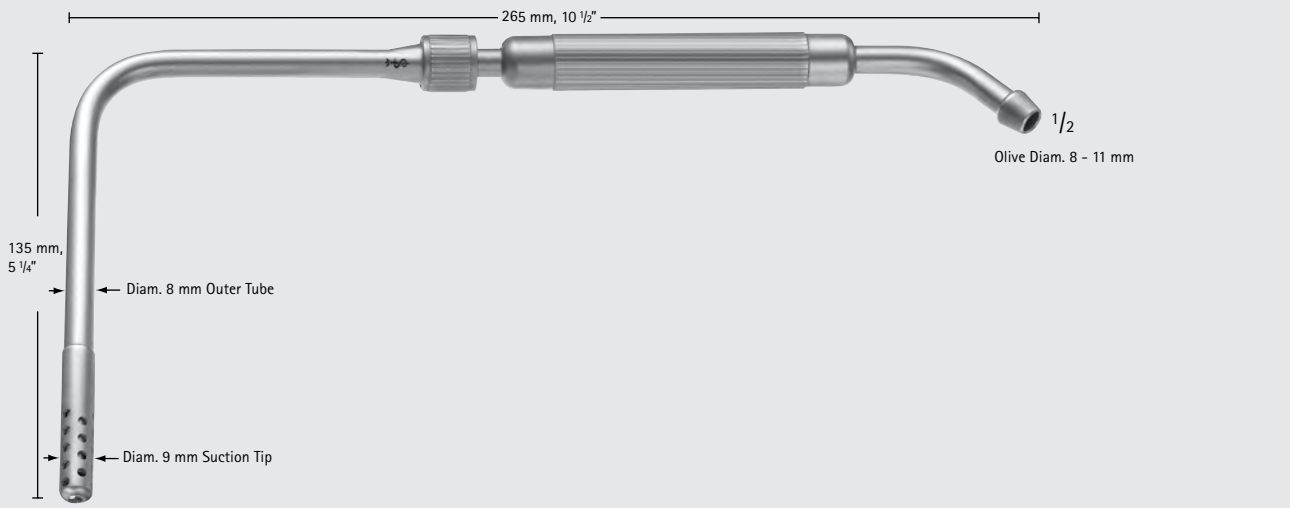

GF825R



General Surgery

Suction Tubes

GENERAL SURGERY



Grafting Suction Tube

Catalog Number	Tip Size (mm)	Length (in.)
MB286R	3	9 1/2
MB287R	4	9 1/2



MB286R-MB287R

DEBAKEY Suction Tube

Catalog Number	Tip Size (mm)	Length (in.)
GF946R	3	10 3/4
GF947R	5	6 1/4
GF948R	5	10 5/8
GF946205	REPLACEMENT TIP FOR GF946R	-



GF946R



Diam. 9 mm

GF946R



GF947R

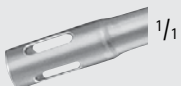

Diam. 5 mm

GF947R

Olive Diam. 9 mm

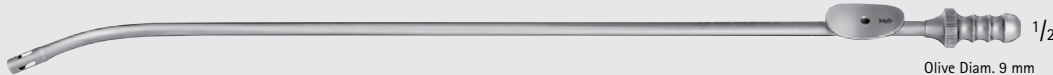

GF948R

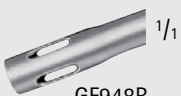

Diam. 5 mm

GF948R

Olive Diam. 9 mm



MF333R-MF347R

Atraumatic Suction Tube

Catalog Number	Tip Size (FR)	Working Length (in.)	Length (in.)
MF333R	3	3	6 1/4
MF334R	5	3	6 1/4
MF335R	7	3	6 1/4
MF336R	10	3	6 1/4
MF337R	12	3	6 1/4
MF338R	3	4	7 1/4
MF339R	5	4	7 1/4
MF340R	7	4	7 1/4
MF341R	10	4	7 1/4
MF342R	12	4	7 1/4
MF343R	3	5	8 1/4
MF344R	5	5	8 1/4
MF345R	7	5	8 1/4
MF346R	10	5	8 1/4
MF347R	12	5	8 1/4

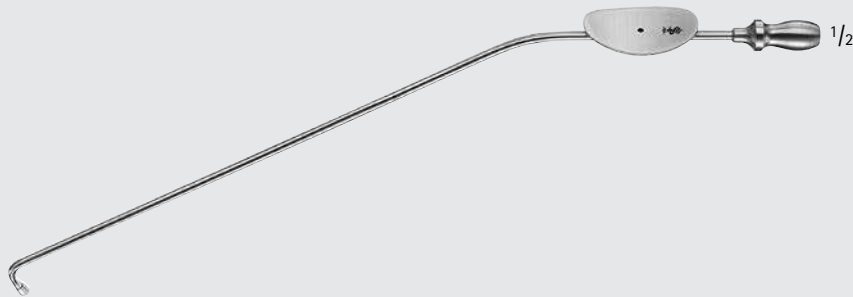

MF106R-MF111R

Atraumatic Suction Tube

Catalog Number	Tip	Tip Size (FR)	Length (in.)
MF106R	90° DOWN	5	8 1/2
MF107R	90° DOWN	7	8 1/2
MF108R	90° DOWN	10	8 1/2
MF109R	90° UP	5	8 1/2
MF110R	90° UP	7	8 1/2
MF111R	90° UP	10	8 1/2



MF106R-MF108R



MF109R-MF111R



INCHES

General Surgery

Suction Tubes

YANKAUER Suction Tube

Catalog Number	Description	Tip Opening (mm)	Length (in.)
GF944R	-	2.0	11 1/4
OM671R	-	4.8	11 1/4
MB919R	-	2.0	12
MG092R	W/ VALVE	2.0	13 1/4
MB051R	-	2.0	14
MB920R	W/ VALVE	2.0	16
GF944200	REPLACEMENT TIP F/ GF944R	-	-
OM671200	REPLACEMENT TIP F/ OM671R	-	-
MB051200	REPLACEMENT TIP F/ MB051R, MB053R, MG919R, MG920R	-	-
MG092200	REPLACEMENT TIP F/ MG092R	-	-

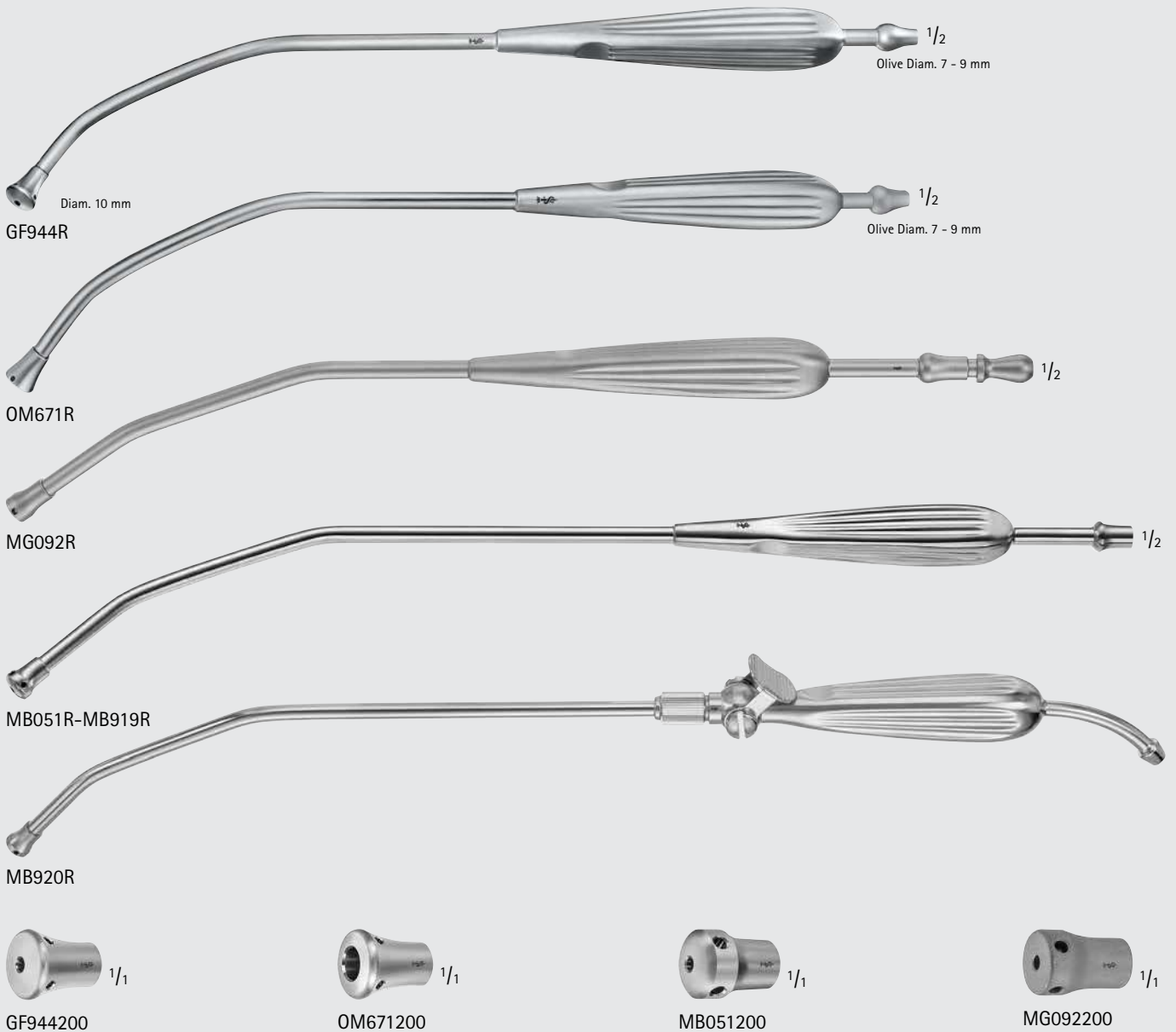



YANKAUER Suction W/ Thumb Control

Catalog Number	Description	Length (in.)
MB052R	HANDLE W/ THUMB CONTROL	6 7/8
MB053R	SUCTION TUBE, CHROME PLATED	6 5/8

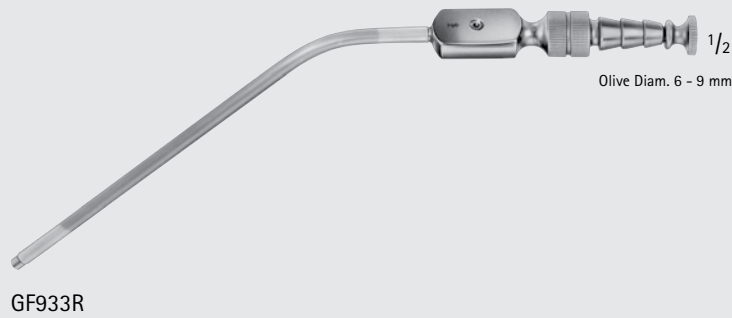

FERGUSON Suction Tube

Catalog Number	Tip	Tip Size (mm)	Length (in.)
GF933R	ROUND	4	7



General Surgery

Suction Tubes

GENERAL SURGERY

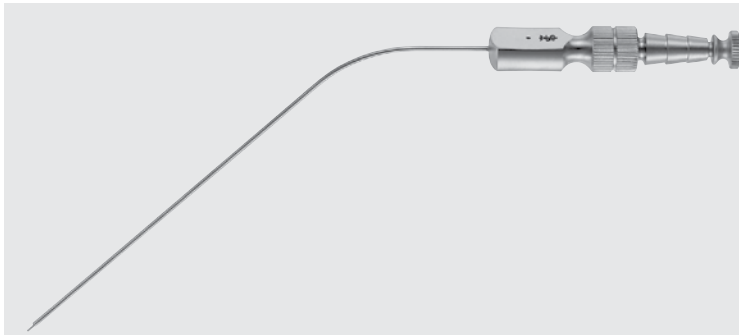
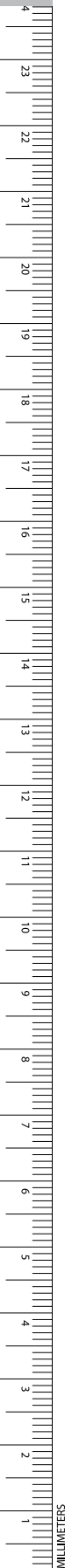

GF350R-GF385R

FERGUSSON Suction Tube, Luer Hub

Catalog Number	Diameter (mm)	Working Length (in.)	Length (in.)
GF350R	1.5	4 1/4	7 3/4
GF351R	2.0	4 1/4	7 3/4
GF352R	2.5	4 1/4	7 3/4
GF353R	3.0	4 1/4	7 3/4
GF354R	4.0	4 1/4	7 3/4
GF355R	5.0	4 1/4	7 3/4
GF360R	1.5	5 1/8	8 1/2
GF361R	2.0	5 1/8	8 1/2
GF362R	2.5	5 1/8	8 1/2
GF363R	3.0	5 1/8	8 1/2
GF364R	4.0	5 1/8	8 1/2
GF365R	5.0	5 1/8	8 1/2
GF370R	1.5	6 1/4	9 5/8
GF371R	2.0	6 1/4	9 5/8
GF372R	2.5	6 1/4	9 5/8
GF373R	3.0	6 1/4	9 5/8
GF374R	4.0	6 1/4	9 5/8
GF375R	5.0	6 1/4	9 5/8
GF380R	1.5	7 7/8	11
GF381R	2.0	7 7/8	11
GF382R	2.5	7 7/8	11
GF383R	3.0	7 7/8	11
GF384R	4.0	7 7/8	11
GF385R	5.0	7 7/8	11

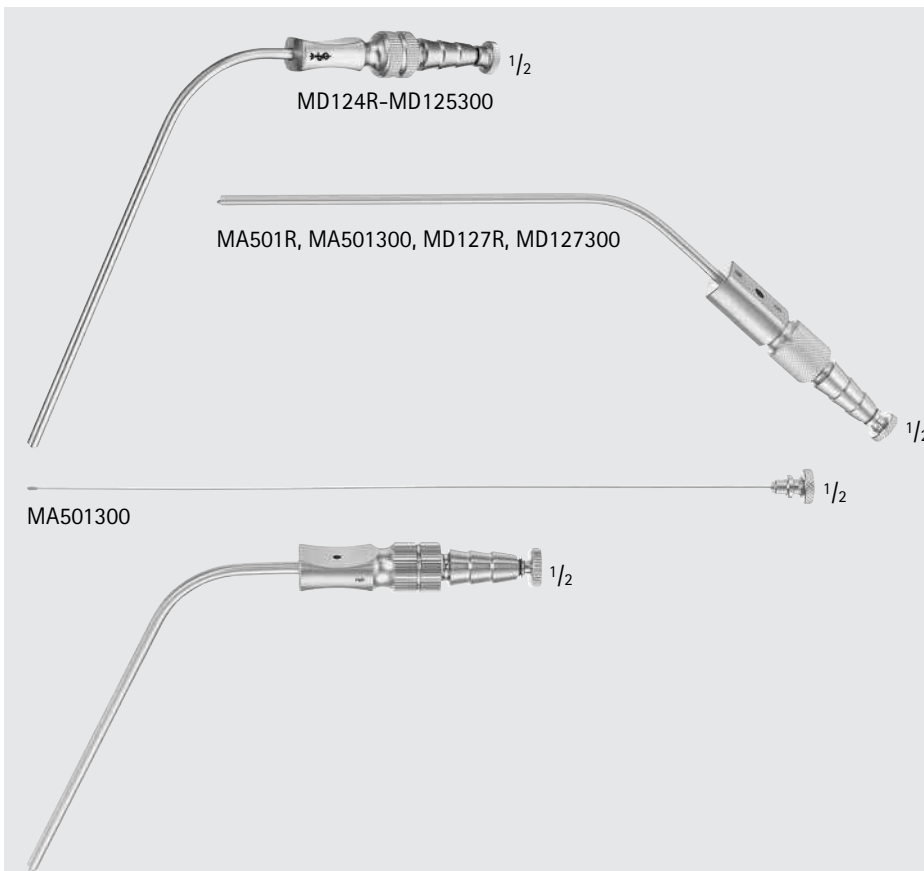

FRAZIER Suction Tube

Catalog Number	Tip Size (FR)	Description	Working Length (in.)
MD124R	7		4 1/4
MD124300	7	SUCTION STYLET W/ OLIVE TIP FOR MD124R	
MD125R	7		4 1/4
MD125300	8	SUCTION STYLET W/ OLIVE TIP FOR MD125R	
MA501R	9		4 1/4
MA501300		SUCTION STYLET W/ OLIVE TIP FOR MA501R	
MD127R	10		4 1/4
MD127300	10	SUCTION STYLET W/ OLIVE TIP FOR MD127R	
MA499R	11		4 1/4
MA499300	11	SUCTION STYLET W/ OLIVE TIP FOR MA499R	
MD129R	12		4 1/4
MD129300	12	SUCTION STYLET W/ OLIVE TIP FOR MD129R	

MA499R, MA499300, MD129R, MD129300



MF479R-MF489R, MF499R-MF508R

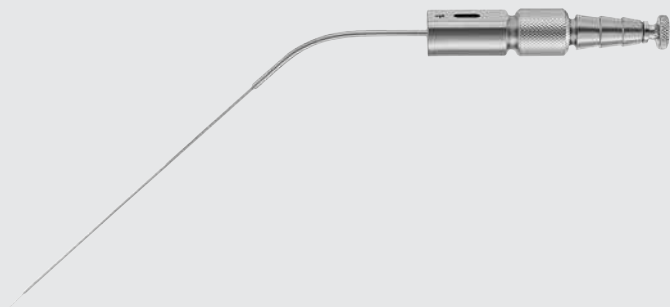

MF489R-MF498R, MF509R-MF518R

FRAZIER Slotted Suction Tube

Catalog Number	Tip Size (FR)	Shaft	Length (in.)
MF479R	3	STR	5 1/2
MF480R	4	STR	5 1/2
MF481R	5	STR	5 1/2
MF482R	6	STR	5 1/2
MF483R	7	STR	5 1/2
MF484R	8	STR	5 1/2
MF485R	9	STR	5 1/2
MF486R	10	STR	5 1/2
MF487R	11	STR	5 1/2
MF488R	12	STR	5 1/2
MF499R	3	STR	7
MF500R	4	STR	7
MF501R	5	STR	7
MF502R	6	STR	7
MF503R	7	STR	7
MF504R	8	STR	7
MF505R	9	STR	7
MF506R	10	STR	7
MF507R	11	STR	7
MF508R	12	STR	7
MF489R	3	ANG	5 1/2
MF490R	4	ANG	5 1/2
MF491R	5	ANG	5 1/2
MF492R	6	ANG	5 1/2
MF493R	7	ANG	5 1/2
MF494R	8	ANG	5 1/2
MF495R	9	ANG	5 1/2
MF496R	10	ANG	5 1/2
MF497R	11	ANG	5 1/2
MF498R	12	ANG	5 1/2
MF509R	3	ANG	7
MF510R	4	ANG	7
MF511R	5	ANG	7
MF512R	6	ANG	7
MF513R	7	ANG	7
MF514R	8	ANG	7
MF515R	9	ANG	7
MF516R	10	ANG	7
MF517R	11	ANG	7
MF518R	12	ANG	7



INCHES

General Surgery

Suction Tubes

GENERAL SURGERY

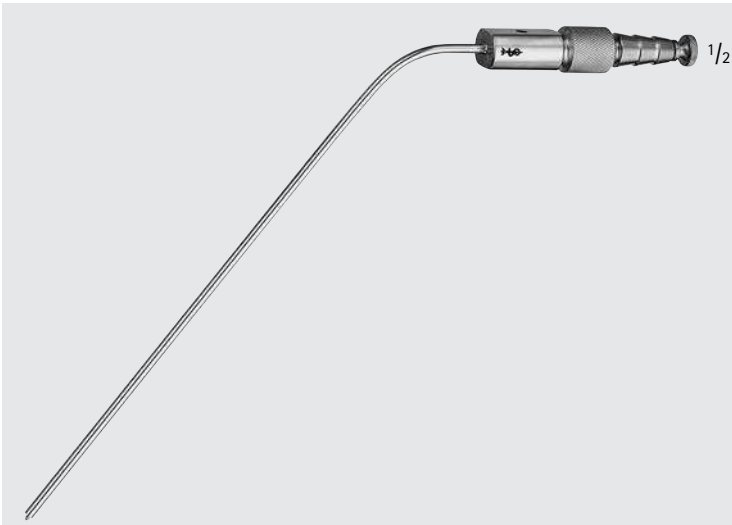
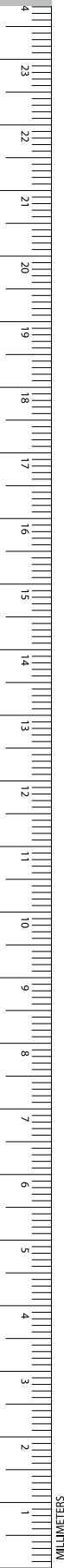

MD091-MD099

FRAZIER Long-Suction Tube

Catalog Number	Tip Size (FR)	Length (in.)
MD091	3	6 1/2
MD092	5	6 1/2
MD093	6	6 1/2
MD094	7	6 1/2
MD095	8	6 1/2
MD096	9	6 1/2
MD097	10	6 1/2
MD098	11	6 1/2
MD099	12	6 1/2



Olive Diam. 6 - 9 mm

GF923R-GF925R

FRAZIER Suction Tube W/ Luer Hub

Catalog Number	Tip Size (FR)	Length (in.)
GF923R	9	7
GF925R	15	7

- Teardrop shaped thumb control for a very precise suction regulation
- Malleable material for individual forming of the suction hose
- Conical design of the tube prevents plugging
- Delivered with stylet

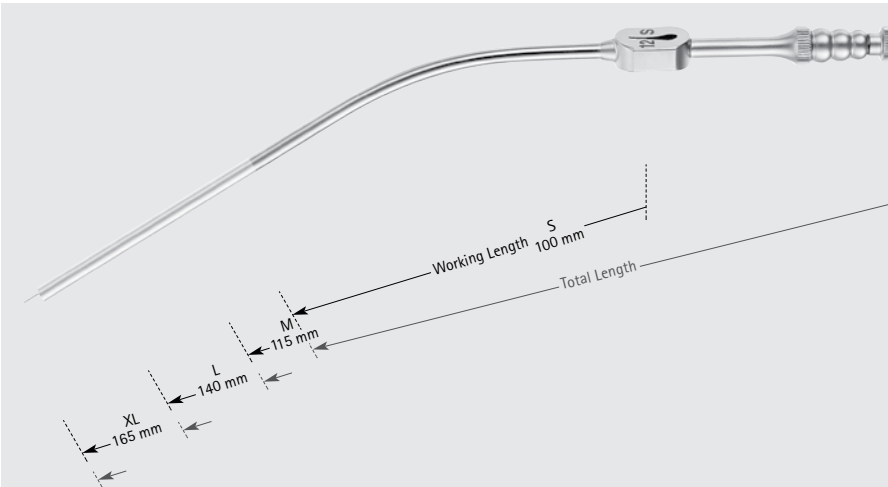

GF391R-GF429R

Suction Tube, Fukushima Style, W/ Tapered Teardrop Control

Catalog Number	Size	Tip Size (mm)	Tip Size (FR)	Working Length (in.)	Length (in.)
GF401R	S	1.0	3	4	6 1/2
GF402R	S	1.4	4	4	6 1/2
GF403R	S	1.7	5	4	6 1/2
GF404R	S	2.0	6	4	6 1/2
GF405R	S	2.3	7	4	6 1/2
GF406R	S	2.7	8	4	6 1/2
GF407R	S	3.0	9	4	6 1/2
GF408R	S	3.3	10	4	6 1/2
GF409R	S	4.0	12	4	6 1/2
GF391R	M	1.0	3	4 1/2	7
GF392R	M	1.4	4	4 1/2	7
GF393R	M	1.7	5	4 1/2	7
GF394R	M	2.0	6	4 1/2	7
GF395R	M	2.3	7	4 1/2	7
GF396R	M	2.7	8	4 1/2	7
GF397R	M	3.0	9	4 1/2	7
GF398R	M	3.3	10	4 1/2	7
GF399R	M	4.0	12	4 1/2	7
GF411R	L	1.0	3	5 1/2	8
GF412R	L	1.4	4	5 1/2	8
GF413R	L	1.7	5	5 1/2	8
GF414R	L	2.0	6	5 1/2	8
GF415R	L	2.3	7	5 1/2	8
GF416R	L	2.7	8	5 1/2	8
GF417R	L	3.0	9	5 1/2	8
GF418R	L	3.3	10	5 1/2	8
GF419R	L	4.0	12	5 1/2	8
GF421R	XL	1.0	3	6 1/2	9
GF422R	XL	1.4	4	6 1/2	9
GF423R	XL	1.7	5	6 1/2	9
GF424R	XL	2.0	6	6 1/2	9
GF425R	XL	2.3	7	6 1/2	9
GF426R	XL	2.7	8	6 1/2	9
GF427R	XL	3.0	9	6 1/2	9
GF428R	XL	3.3	12	6 1/2	9
GF429R	XL	4.0	12	6 1/2	9



INCHES

General Surgery

Suction Tubes

GENERAL SURGERY

GF980R

olive diam. 6 - 9 mm

1/2

LANDOLT Dissecting Suction Tube

Catalog Number	Tip	Tip Size (mm)	Length (in.)
GF980R	ANG, SHARP	3.2	7 7/8

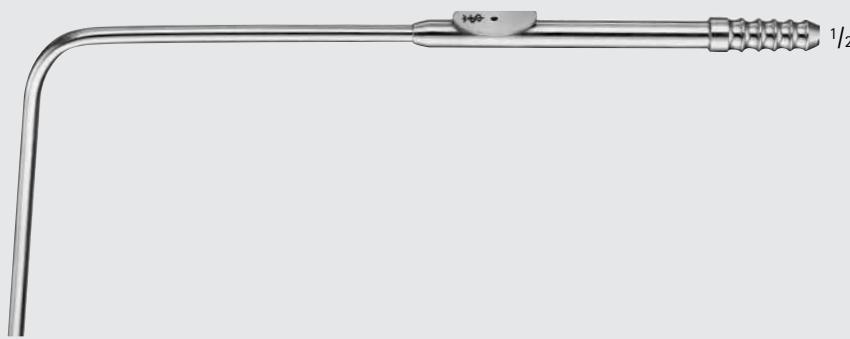

MB635R-MB636R

1/2

SACHS Suction Tube

Catalog Number	Tip Size	Length (in.)
MB635R	SMALL	8 1/2
MB636R	LARGE	8 1/2



US106-US107

1/2

PRIBRAM Suction Tube with Thumb Control

Catalog Number	Tip	Length (in.)
US106	16	5 1/2
US107	18	5 1/2



MG100R-MG110R

1/2

OCHSNER Trocar

Catalog Number	Tip Size (FR)	Length (in.)
MG100R	10	6
MG101R	12	6
MG102R	14	6
MG103R	16	6
MG104R	18	6
MG105R	20	6
MG106R	22	6
MG107R	24	6
MG108R	26	6
MG109R	27	6
MG110R	28	6



AA804R-AA806R

Steel Ruler, Graduated In Millimeters and Inches

Catalog Number	Length (in.)
AA804R	6
AA805R	11 3/4
AA806R	19 3/4

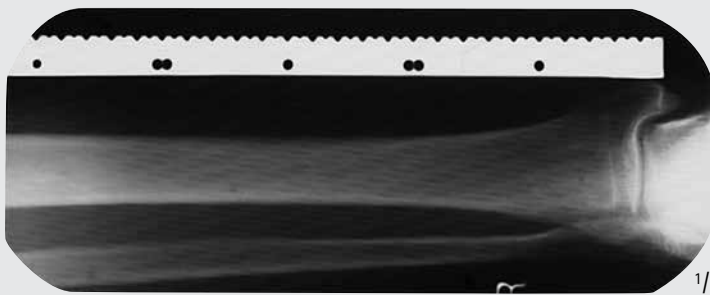

AA808R

Ruler, F/ X-Ray Work

Catalog Number	Length (in.)
AA808R	19 3/4

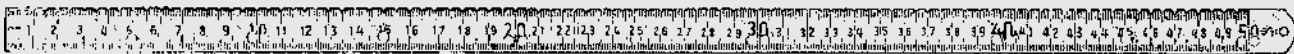

AD110R

Finger-Goniometer

Catalog Number	AD110R
----------------	--------



INCHES

General Surgery

Accessories

GENERAL SURGERY



MG001R-MG004R

Surgical Spoon

Catalog Number	Size	Blade Size (mm)	Length (in.)
MG003R	SMALL	25	4 1/4
MG002R	MEDIUM	30	5 1/4
MG004R	MEDIUM-LARGE	35	6 1/4
MG001R	LARGE	40	7 1/2



783101-783102

1/2

Staple Remover

Catalog Number	Description
783102	REUSABLE
783101	SINGLE USE (BOX OF 6)



MG377R-MG378R

TAYLOR Percussion Hammer

Catalog Number	Size	Length (in.)
MG377R	SMALL	7
MG378R	LARGE	7 3/4



Metal Sponge Bowl

Catalog Number	Capacity (qts.)
US061	1
US060	1 1/2
US062	1 7/8

US060-US062

1/2



Metal Cup

Catalog Number	Item	Capacity (oz.)
US066	MEDICINE CUP	2
US063	IODINE CUP	6
US067	SOLUTION BASIN	12
US065	IODINE CUP	14
US064	GRADUATED MEASURE	32

US063-US067

1/2



Kidney Tray

Catalog Number	Length (in.)
JG504R	6 3/4
JG506R	9 3/4

JG504R-JG506R



INCHES

ROYAL

INTERNATIONAL



ALIS



Manufacturing Unit -

**115-A Waryana Industrial Complex, Leather Complex Road,
Jalandhar Punjab, 144021**



Sales Office -

**Plot No. 581- Kakrola Housing Complex, Near Metro Pillar 802,
Dwarka Mor, Delhi, 110078**



Our Certifications -

**UDYAM , ISO 13485, WHO-GMP, ISO 9001:2015, CE , ROHS,
FDA , MD-42, MD-5**

CONTACT US:



+91- 98141-81255, +91- 98142-62255



www.alisprofessional.com



info@royalinternational.org