

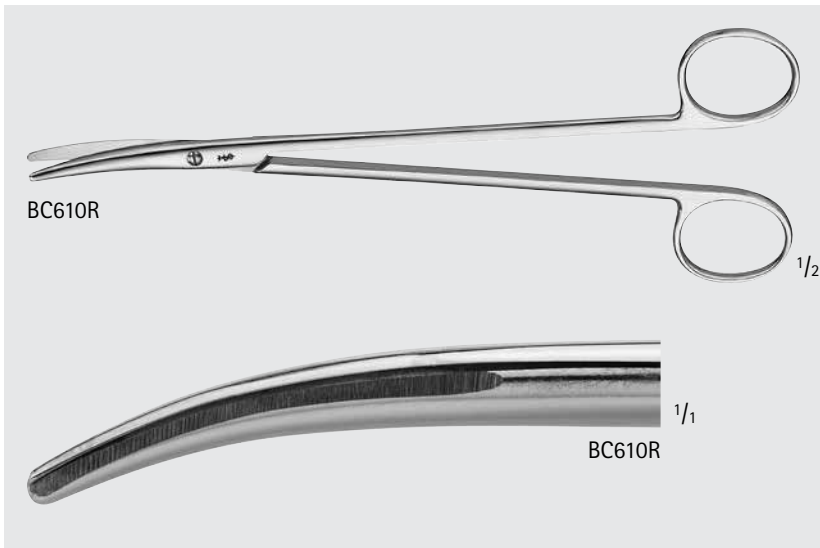
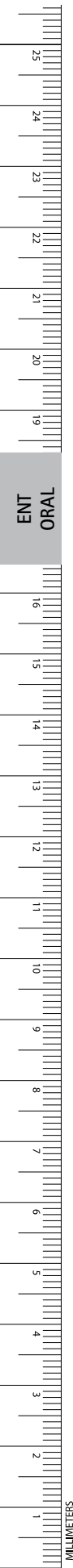

ENT-ORAL

Scissors	706 - 708
Needles	709
Forceps	709 - 712
Clamps	713 - 719
Tracheal Dilators / Hooks / Retractors	720 - 721
Retractors	722 - 724
Tonsil Dissectors	725
Adenotomes, Tonsil Snares and Wires	726 - 728
Mouth Gags	729 - 737
Tonsil Knives	738
Suction Tubes	739
Adenoid Curettes	740 - 742
Syringes	743
Laryngeal Mirrors	744
Amalgam Carriers	745

ENT-ORAL
Oral Scissors

LILLIE Dissecting Scissors

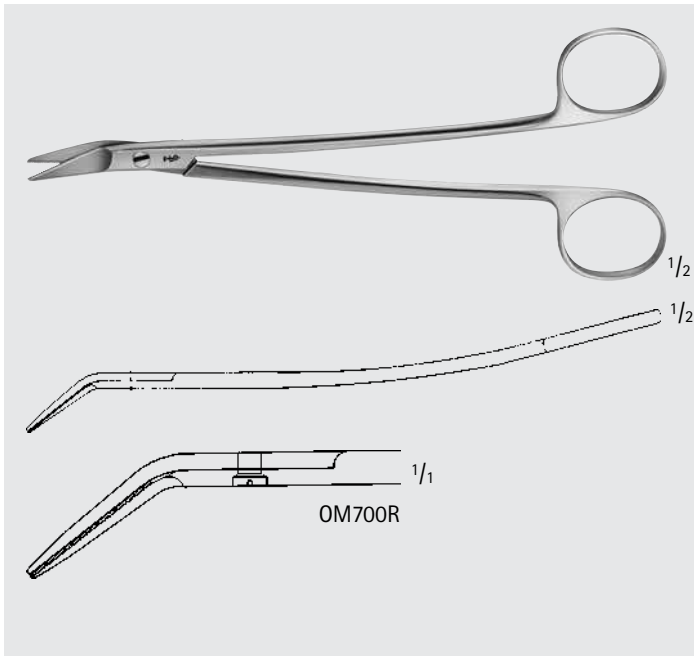
Catalog Number	Tip	Blade	Length (in.)
BC610R	B/B	CVD	7 7/8

DEAN Tonsil Scissors

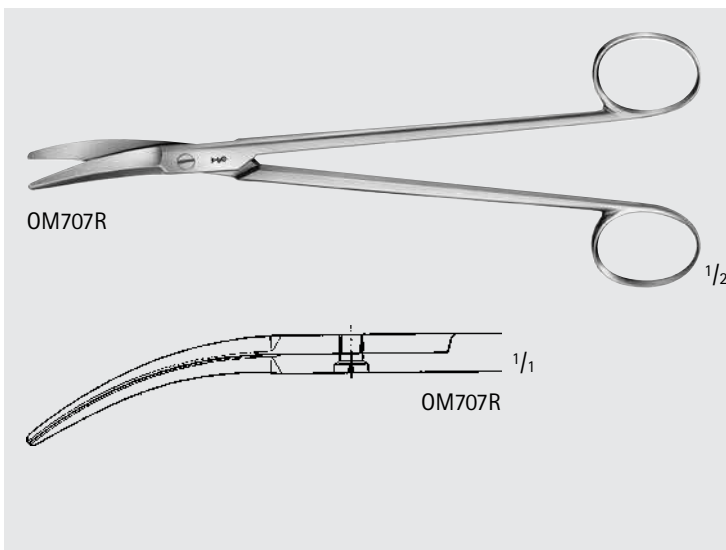
Catalog Number	Tip	Blade	Length (in.)
OM700R	B/B	ANG-SERR	6 3/4

BOETTCHER Tonsil Scissors

Catalog Number	Tip	Blade	Length (in.)
OM707R	B/B	CVD	7

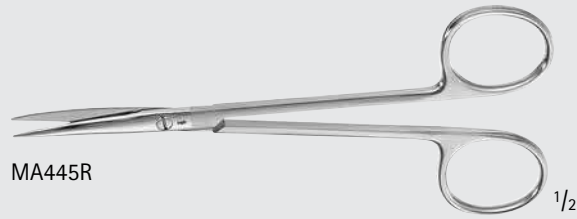

MA445R

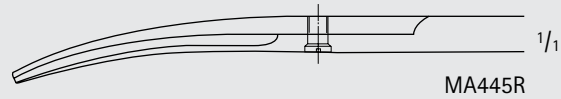

MA445R

BROPHY Gum Scissors

Catalog Number	Tip	Blade	Length (in.)
MA445R	S/S	CVD	5 1/2

DUROTIP™ Tungsten Carbide Scissors

- Excellent cutting accuracy
- Long working life
- Gold-plated rings

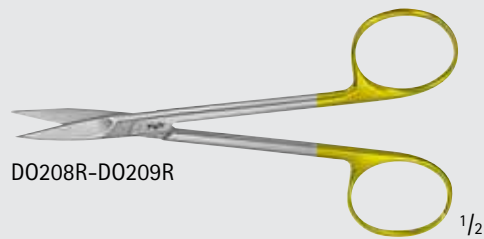

D0208R-D0209R

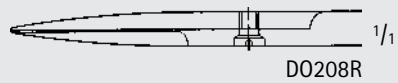

D0208R

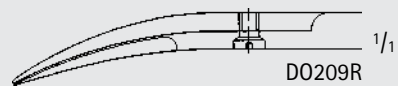

D0209R

DUROTIP TC Gum Scissors, Delicate

Catalog Number	Tip	Blade	Length (in.)
D0208R	S/S	STR	4 3/4
D0209R	S/S	CVD	4 3/4



ENT
ORAL

INCHES

ENT-ORAL

Laryngeal Scissors

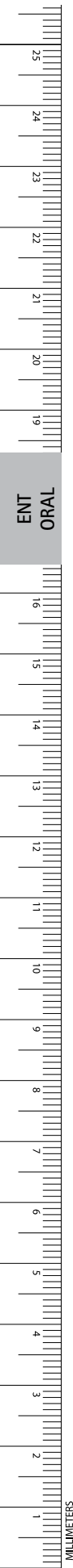

Micro Laryngeal Scissors, W/ Flush Port

Catalog Number	Tip	Blade	Working Length (in.)
OP310R	S/S	STR	9 3/4
OP311R	S/S	CVD-LEFT	9 3/4
OP312R	S/S	CVD-RIGHT	9 3/4
OP313R	S/S	ANG-UP	9 3/4

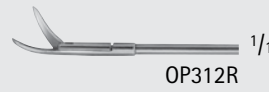
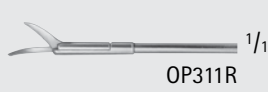
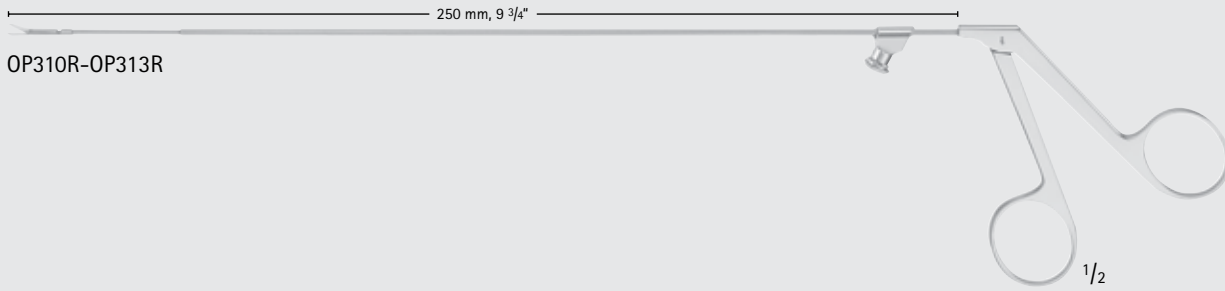

KLEINSASSER Micro Scissors

Catalog Number	Tip	Blade	Blade Size (mm)	Working Length (in.)
MA460R	B/B	STR	4	14

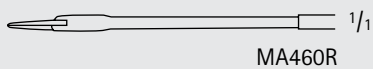
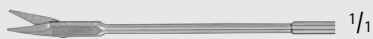
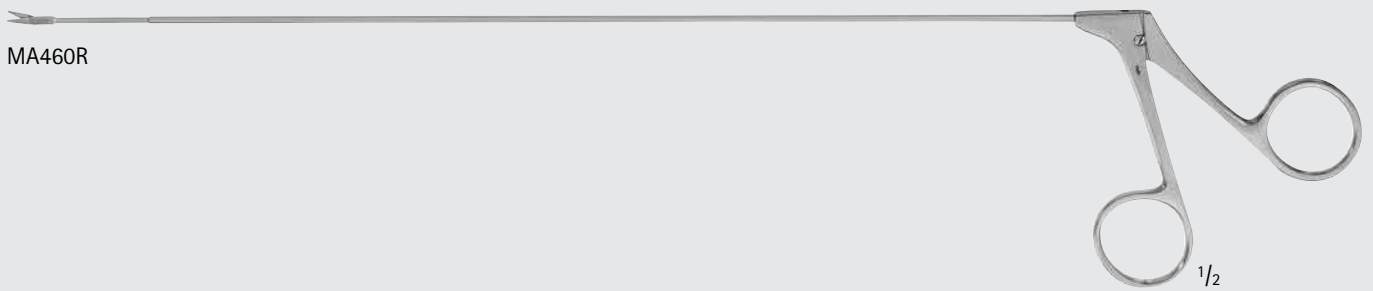

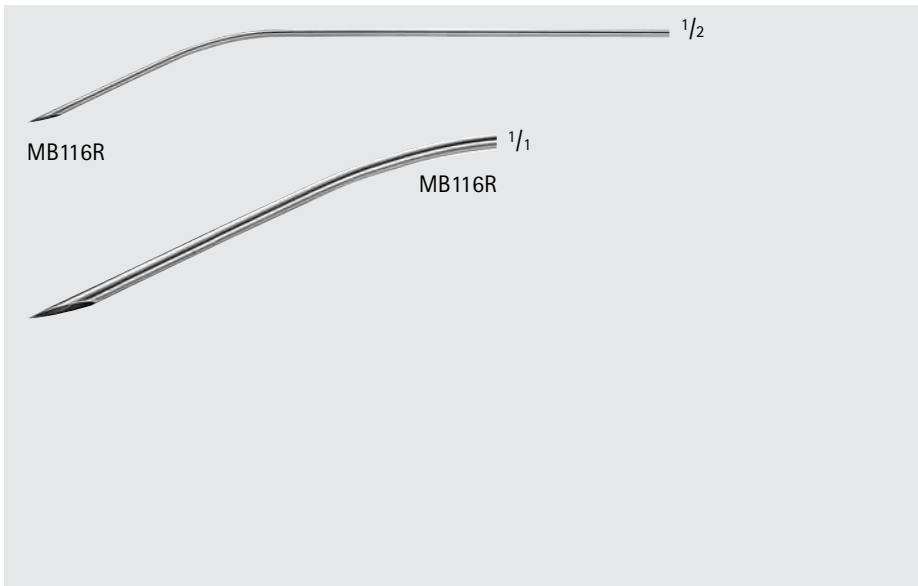

MB116R $\frac{1}{2}$

MB116R $\frac{1}{1}$

DINGMAN Wire Passing Needle

Catalog Number	Tip	Length (in.)
MB116R	CVD	6 $\frac{3}{4}$

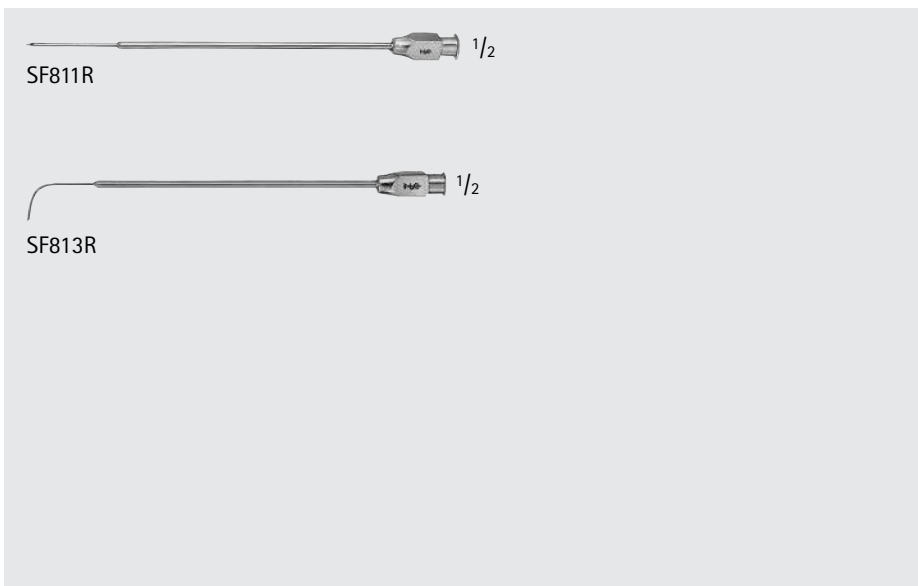

SF811R $\frac{1}{2}$

SF813R $\frac{1}{2}$

Tonsil Needle, 23 Gauge

Catalog Number	Tip	Tip Size (mm)	Length (in.)
SF811R	STR	DIAM. 0.8	3
SF813R	CVD	DIAM. 0.8	3

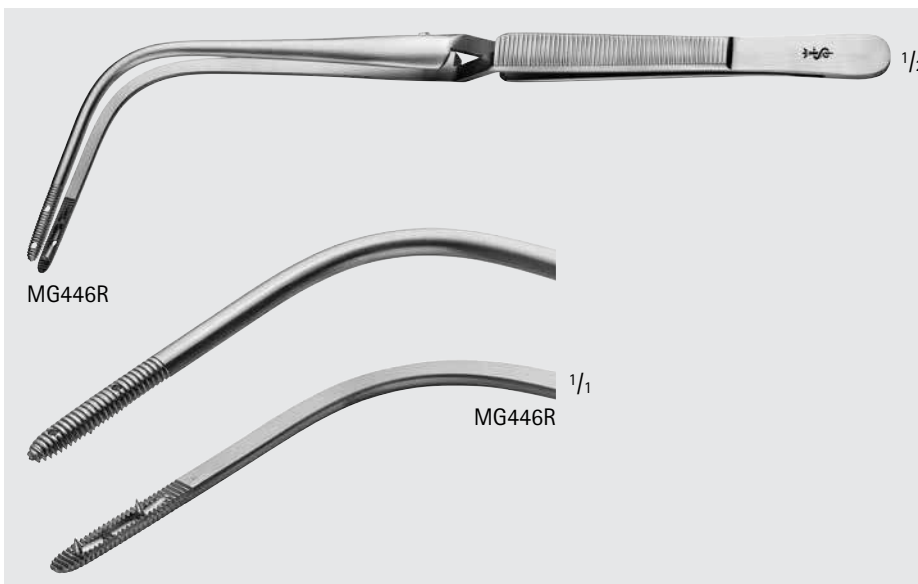

MG446R $\frac{1}{2}$

MG446R $\frac{1}{1}$

JACKSON Laryngeal Self-Closing Dressing Forceps

Catalog Number	Tip	Teeth	Length (in.)
MG446R	SERR	1 x 2	9





ENT-ORAL

Forceps

Laryngeal Forceps, W/ Flush Port

Catalog Number	Jaw	Working Length (in.)
OP300R	STR	9 3/4
OP301R	CVD-LEFT	9 3/4
OP302R	CVD-RIGHT	9 3/4

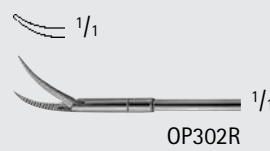
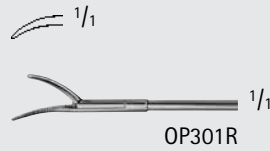
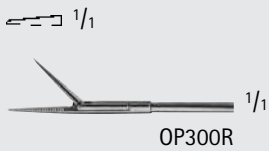
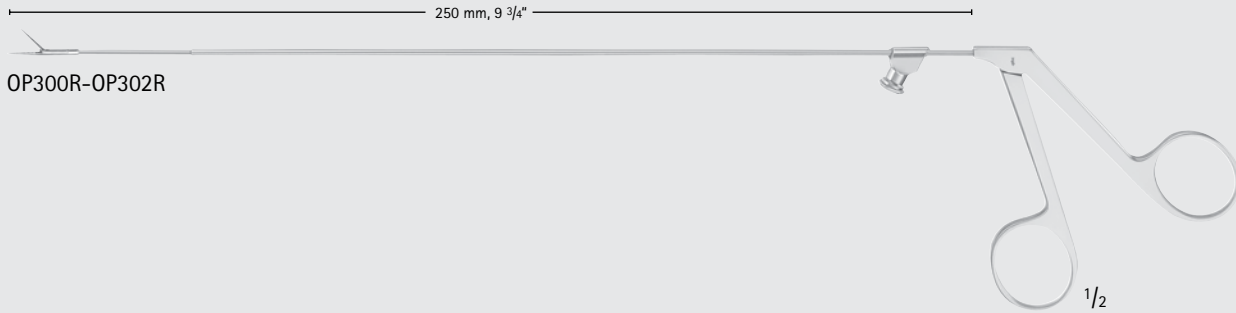

Micro Laryngeal Cup Forceps, W/ Flush Port

Catalog Number	Cup Size (mm)	Jaw	Working Length (in.)
OP304R	2	STR	9 3/4
OP305R	2	ANG-LEFT	9 3/4
OP306R	2	ANG-RIGHT	9 3/4
OP307R	2	ANG-UP	9 3/4

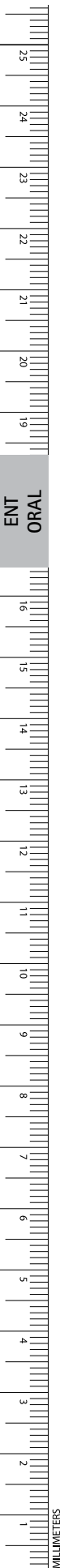
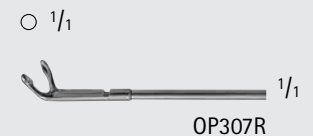
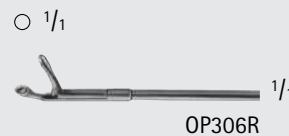
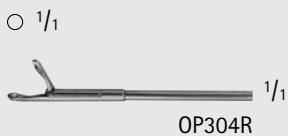
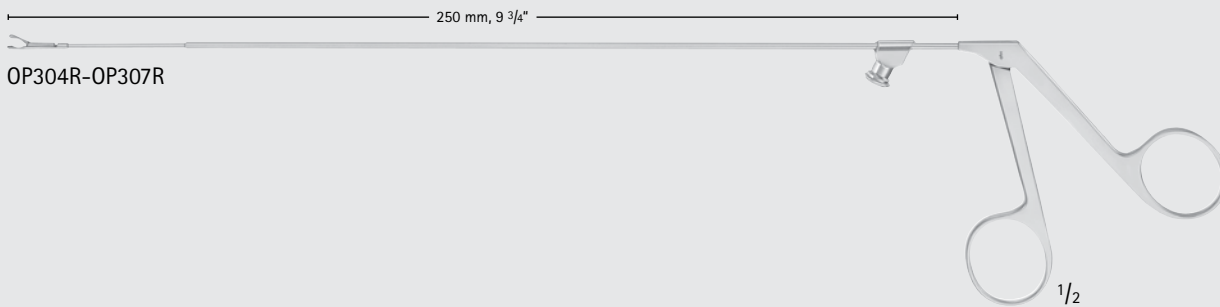

Alligator Grasping Forceps

Catalog Number	Tip	Tip Size (mm)	Working Length (in.)	Length (in.)
MA663R	SERR	8.8 x 4	11	13 3/4

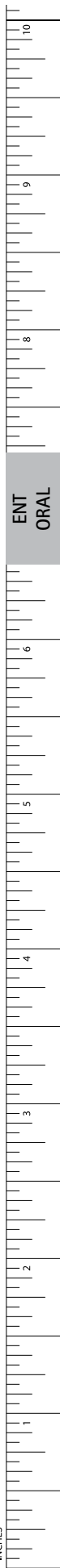
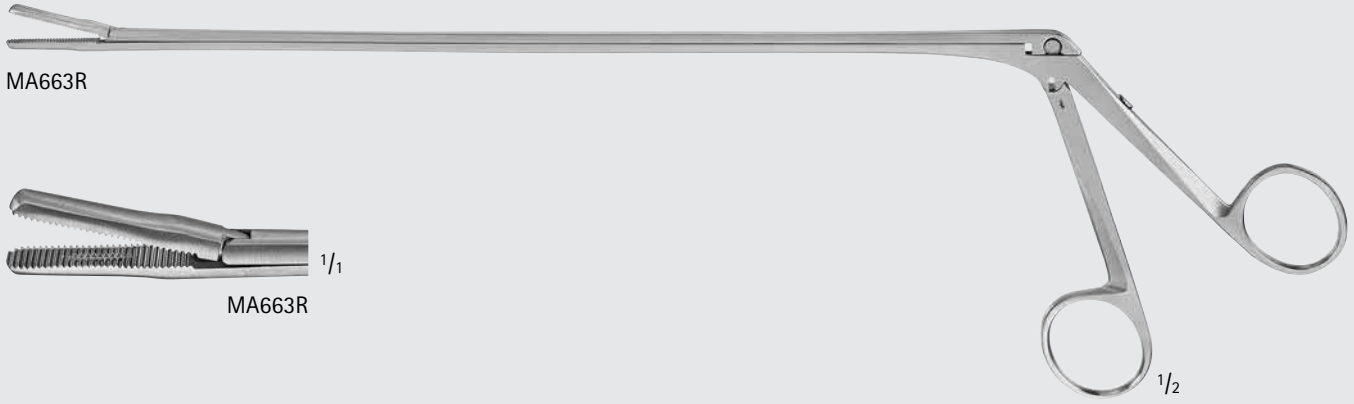

ENT-ORAL

Forceps

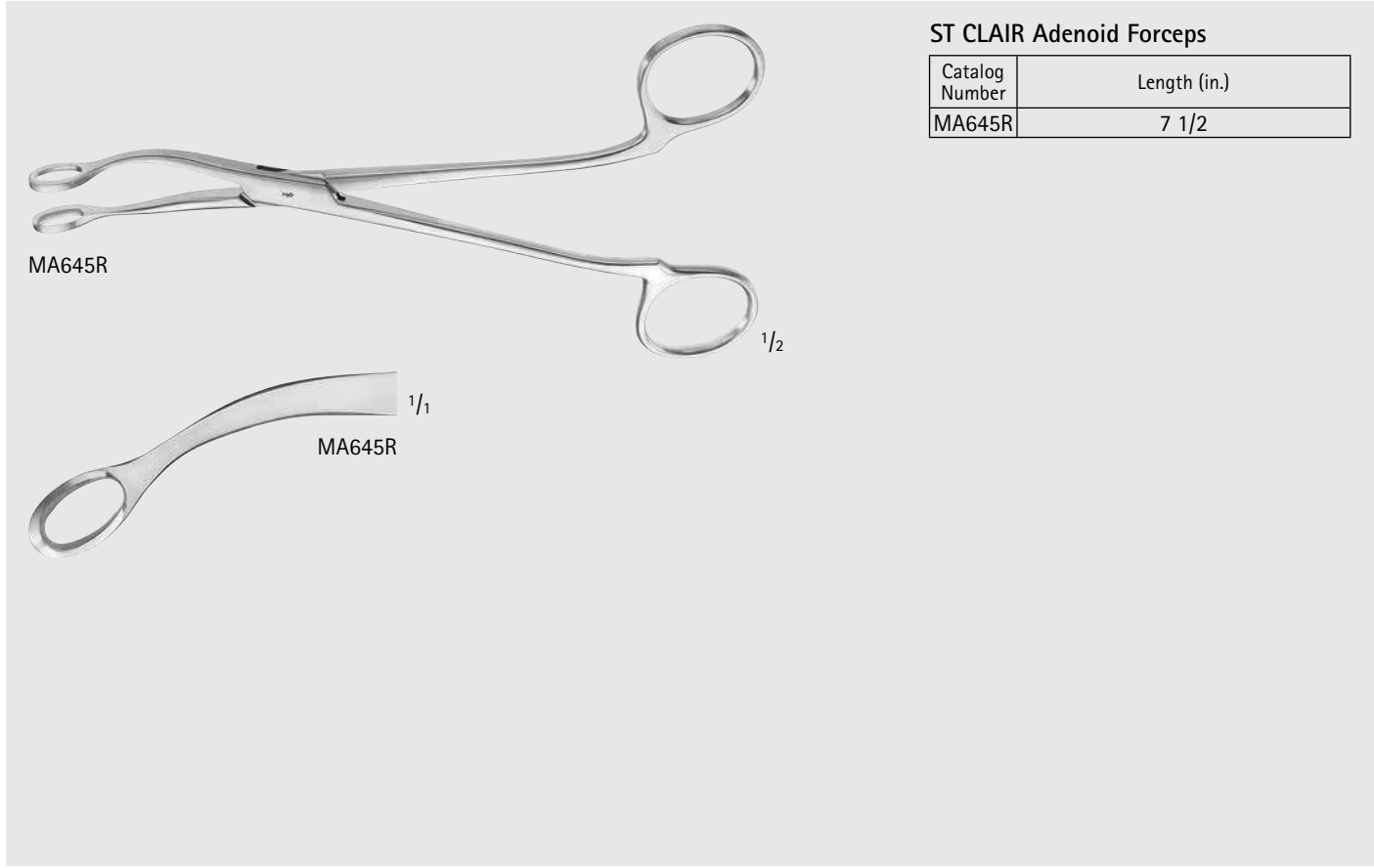
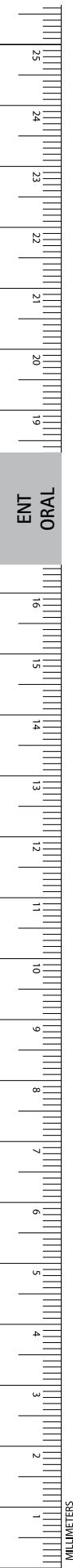

ST CLAIR Adenoid Forceps

Catalog Number	Length (in.)
MA645R	7 1/2

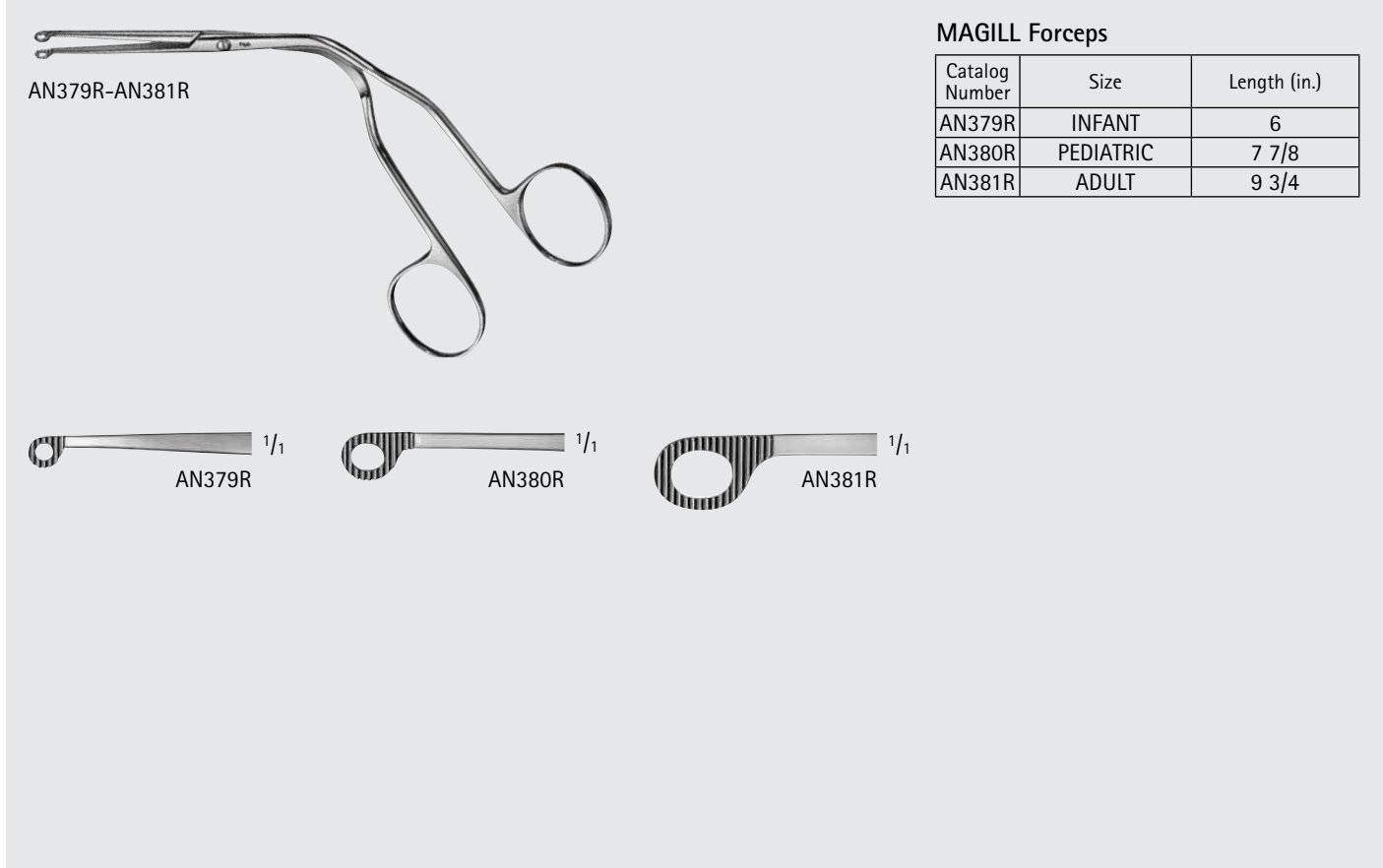

MAGILL Forceps

Catalog Number	Size	Length (in.)
AN379R	INFANT	6
AN380R	PEDIATRIC	7 7/8
AN381R	ADULT	9 3/4

SCHNIDT Tonsil Clamp

Catalog Number	Ring Handle	Jaw	Length (in.)
MA172R	OPEN RING	STR	7 1/2
BH961R	OPEN-RING	SLIGHT-CVD	7 1/4
BH963R	OPEN-RING	CVD	7 1/4
BH957R	CLOSED-RING	SLIGHT-CVD	7 1/4
BH959R	CLOSED-RING	CVD	7 1/4

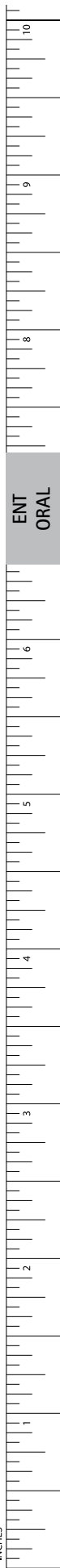
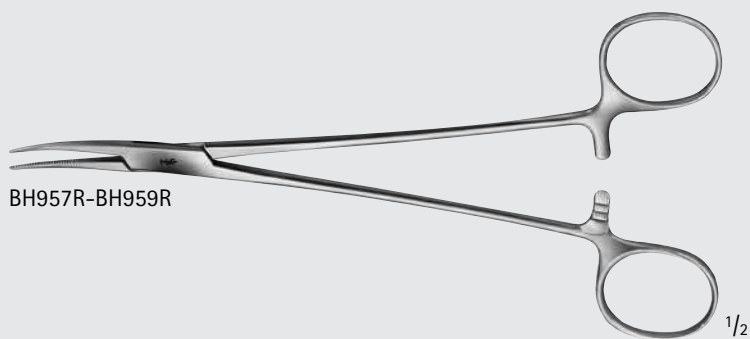
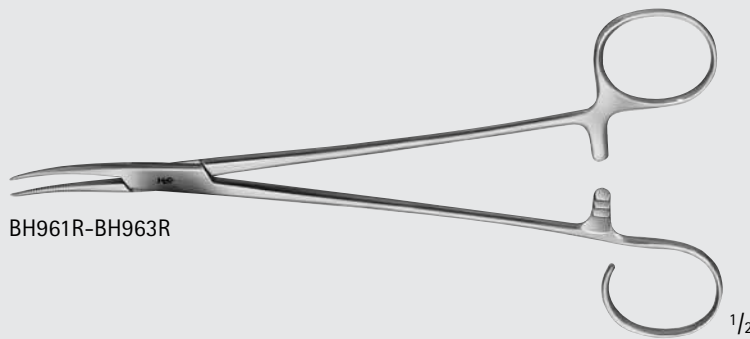
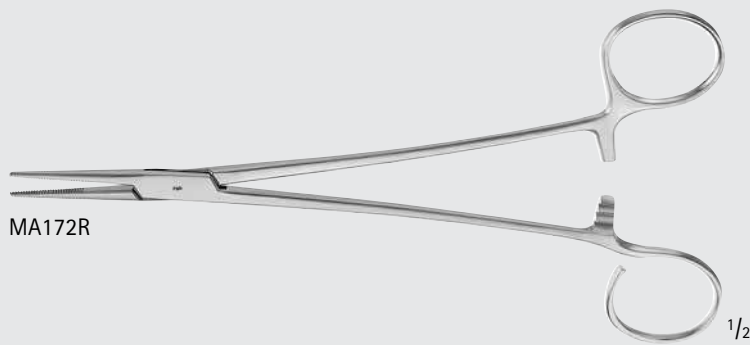

ENT-ORAL

Clamps

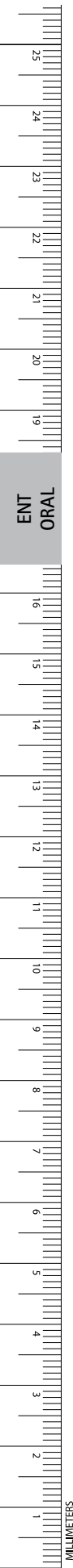

Tonsil Clamp, X-long

Catalog Number	Jaw	Length (in.)
MB103R	CVD	14 1/2

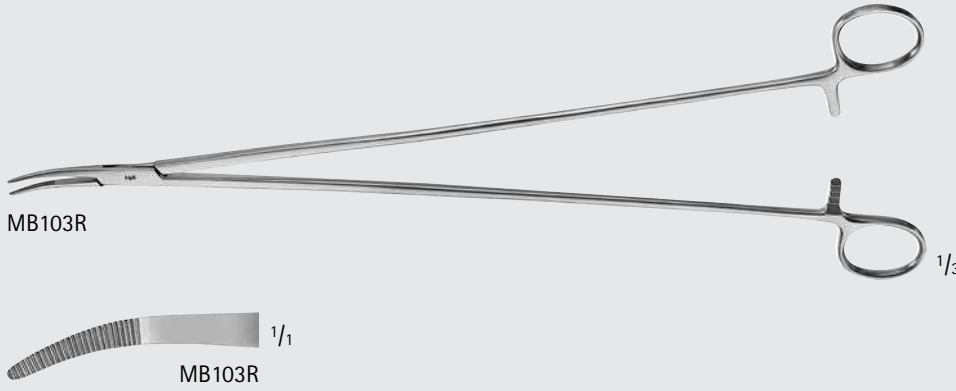

ADSON Tonsil Clamp, Delicate

Catalog Number	Jaw	Length (in.)
BH200R	STR	7 1/4
BH201R	CVD	7 1/4

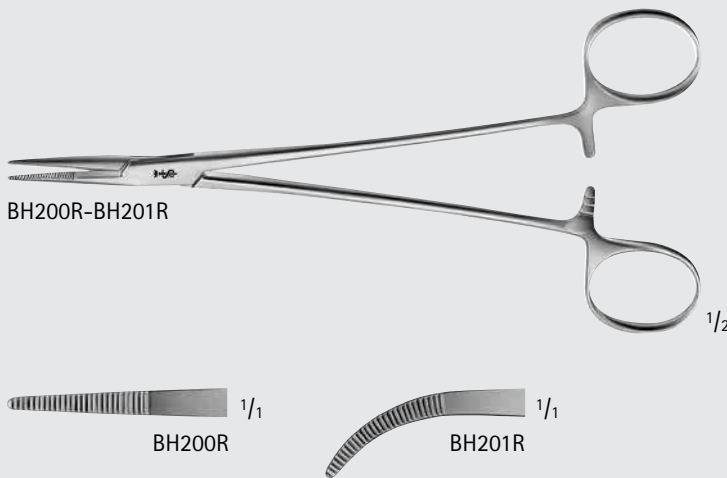

NISSEN Tonsil Clamp, Delicate

Catalog Number	Jaw	Length (in.)
BH199R	CVD	7 1/4

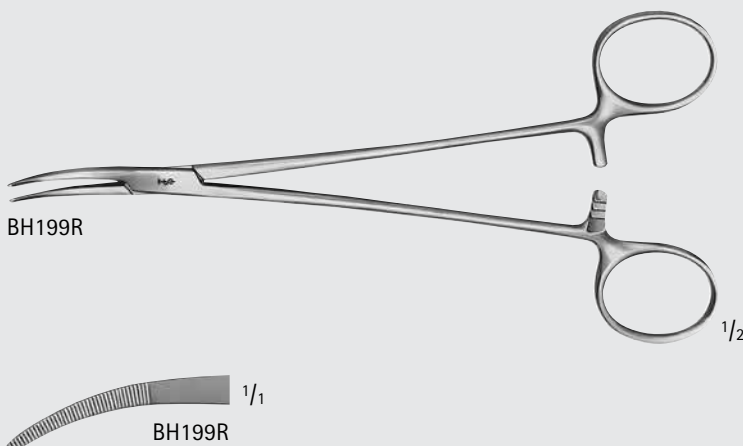

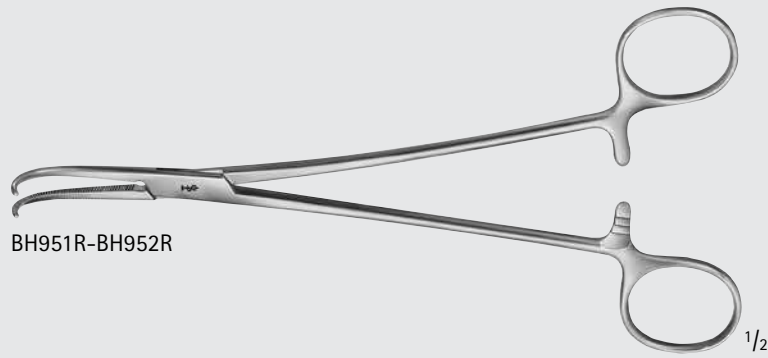

BH951R-BH952R

1/2

NEGUS Tonsil Clamp

Catalog Number	Jaw	Length (in.)
BH951R	HEAVY-CVD	7 1/2
BH952R	U-CVD	7 1/2

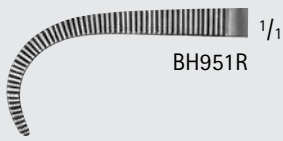

BH951R

1/1

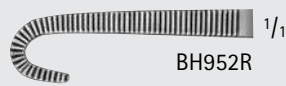

BH952R

1/1

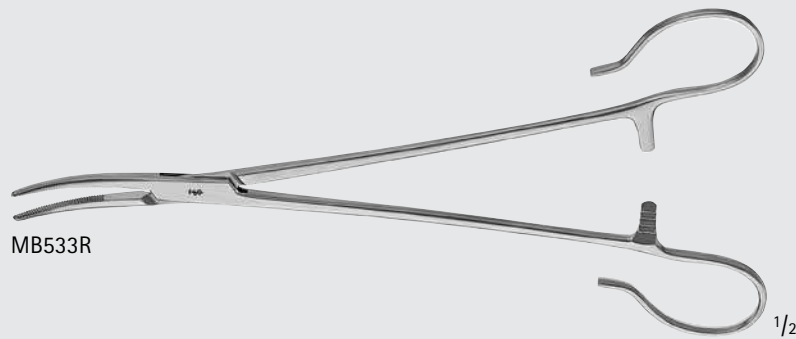

MB533R

1/2

MCHENRY Tonsil Artery and Sponge Holding Clamp

Catalog Number	Jaw	Length (in.)
MB533R	CVD	8

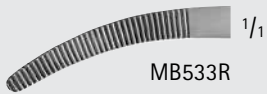

MB533R

1/1



INCHES

ENT-ORAL

Clamps

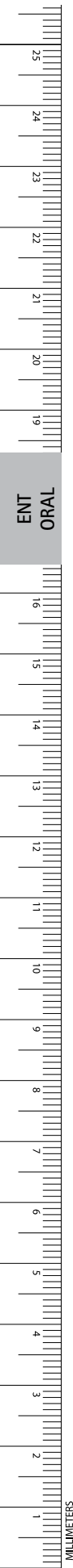
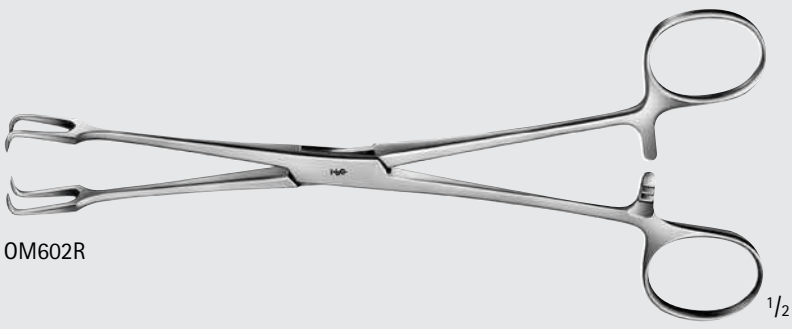
OM602R $\frac{1}{2}$

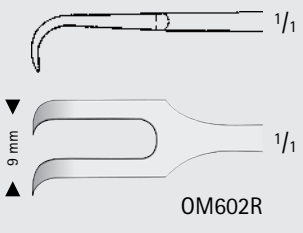

OM602R $\frac{1}{1}$

9 mm

MUSEUX Tonsil Clamp

Catalog Number	Tip	Length (in.)
OM602R	2 x 2	7 7/8

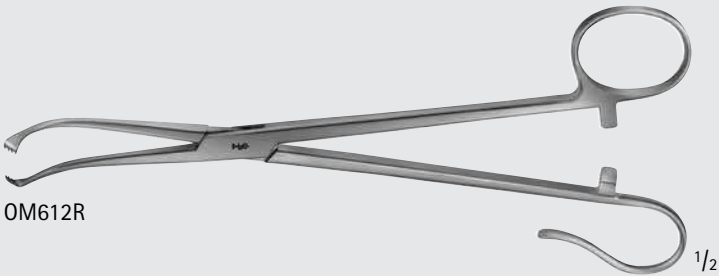

OM612R $\frac{1}{2}$



OM612R $\frac{1}{1}$

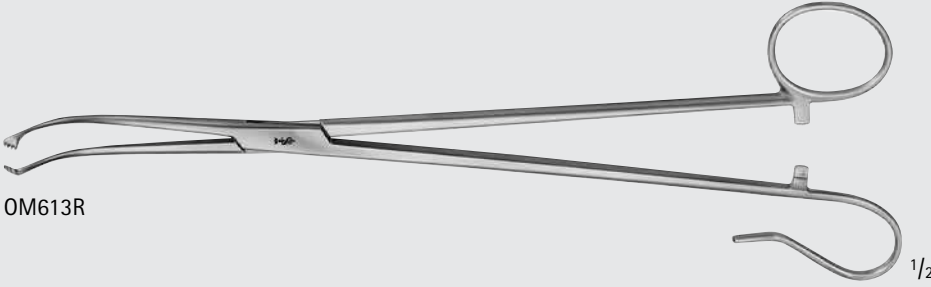

OM613R $\frac{1}{2}$

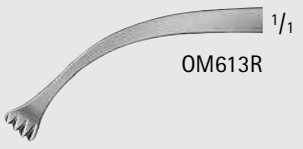

OM613R $\frac{1}{1}$

WHITE Tonsil Seizing Clamp

Catalog Number	Length (in.)
OM612R	7
OM613R	9 1/4

ALLIS-COAKLEY Tonsil Clamp

Catalog Number	Jaw	Length (in.)
MA539R	STR	7 7/8
MA540R	STRONG CVD	7 5/8

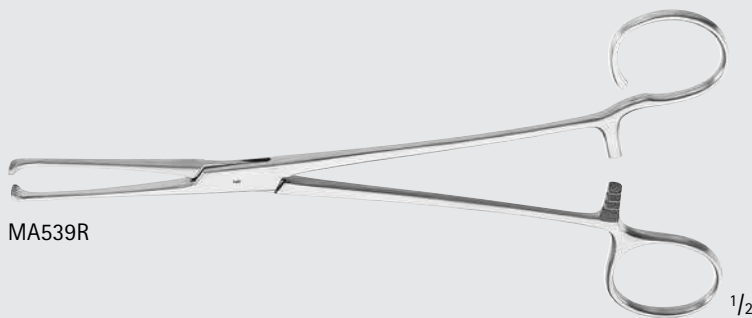

MA539R $\frac{1}{2}$



MA539R $\frac{1}{1}$



MA540R $\frac{1}{2}$



MA540R $\frac{1}{1}$

COLVER Tonsil Seizing Clamp

Catalog Number	Length (in.)
OM611R	7 7/8



OM611R $\frac{1}{2}$



OM611R $\frac{1}{1}$

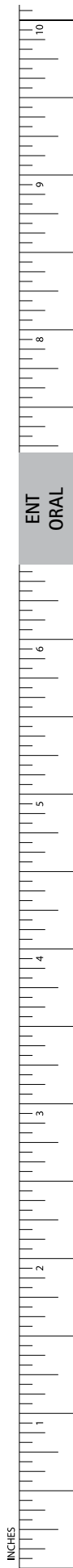

ENT-ORAL

Clamps

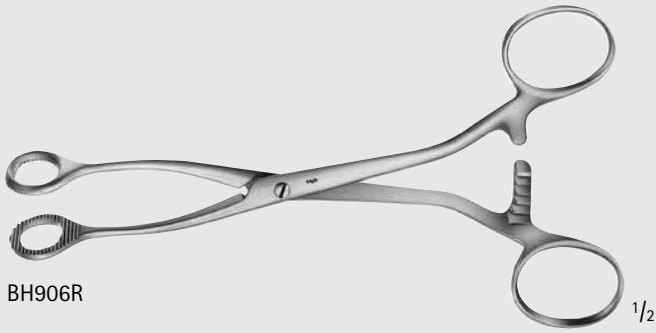
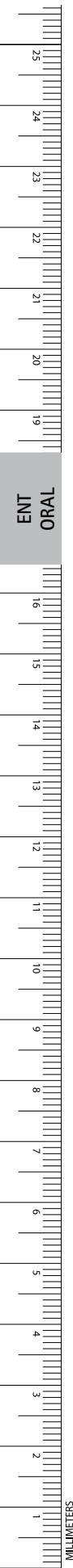

BH906R

1/2

COLLIN Tongue Clamp

Catalog Number	Jaw	Length (in.)
BH906R	OVAL	6 1/4

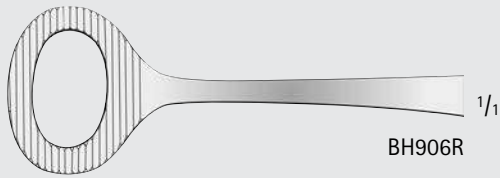

BH906R

1/1

ENT
ORAL

HEYWOOD-SMITH Tongue Clamp

Catalog Number	Tip	Length (in.)
AN710R	SERR	7 7/8
AN711R	SERR	8 1/4

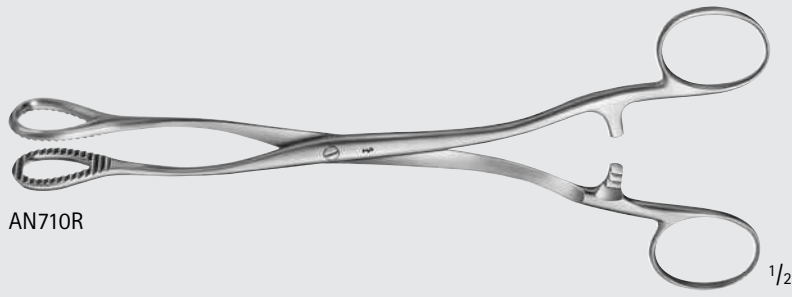

AN710R

1/2

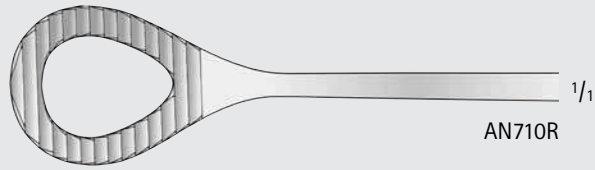

AN710R

1/1

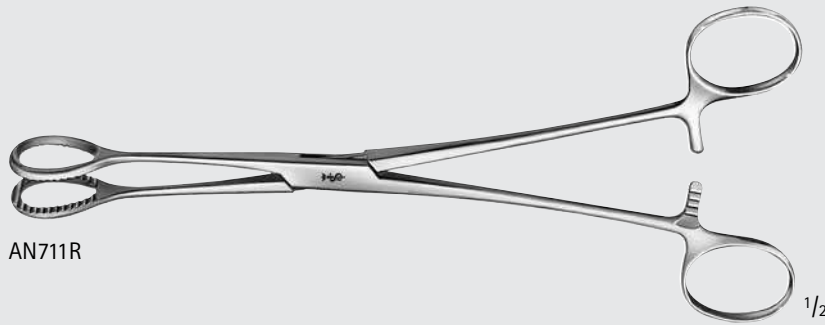

AN711R

1/2

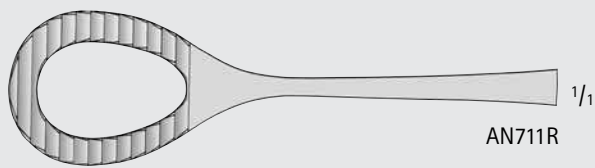

AN711R

1/1

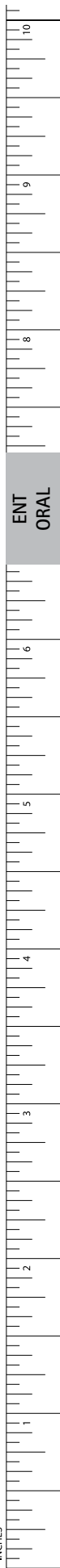

ENT-ORAL

Tracheal Dilators/Hooks/Retractors



FA025R

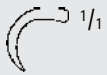

FA026R

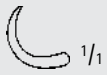

BOSE Tracheal Hook

Catalog Number	Tip	Length (in.)
FA025R	CVD-LEFT	6 1/2
FA026R	CVD-RIGHT	6 1/2



BT103R-BT107R



Tracheal Retractor

Catalog Number	Tip	Blade End	Length (in.)
BT103R	SHARP	1 PRONG	7
BT106R	BLUNT	1 PRONG	7
BT107R	BLUNT	2 PRONGS	7



MB230



JACKSON Tracheal Retractor

Catalog Number	Length (in.)
MB230	7

ENT
ORAL



FA005R

TROUSSEAU Tracheal Dilator

Catalog Number	Length (in.)
FA005R	4 3/4

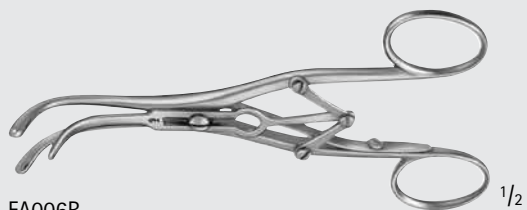

FA006R

LABORDE Tracheal Dilator

Catalog Number	Length (in.)
FA006R	5
FA007R	5 1/4

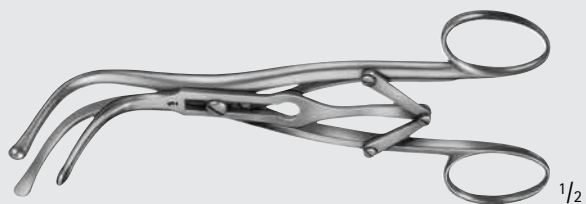

FA007R

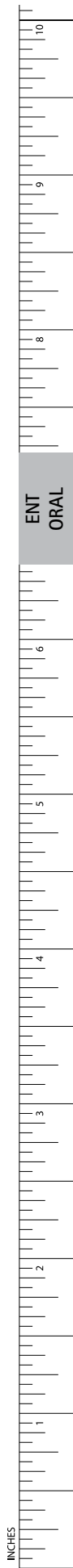

ENT-ORAL

Retractors

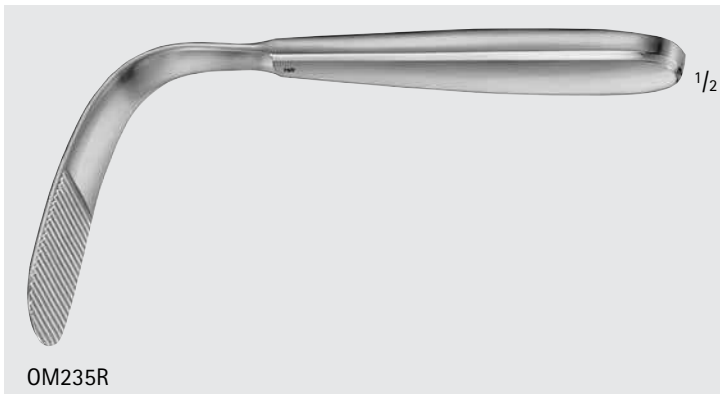
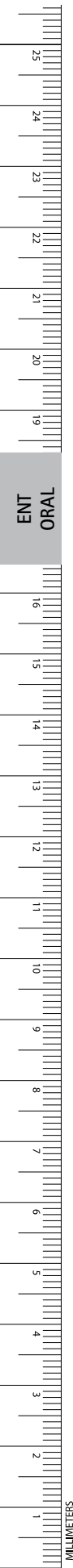

OM235R

TOBOLD Tongue Depressor

Catalog Number	Length (in.)
OM235R	6 1/4



OM236R-OM237R

WEDER Tongue Depressor

Catalog Number	Size	Length (in.)
OM236R	SMALL	5
OM237R	LARGE	5

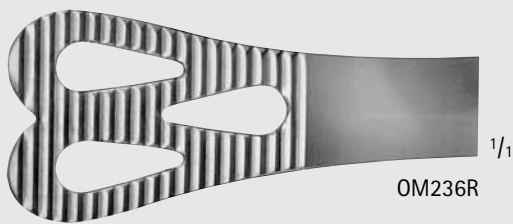

OM236R

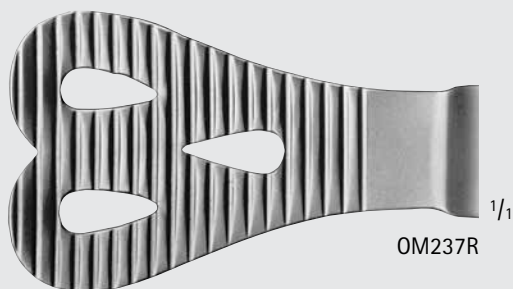

OM237R

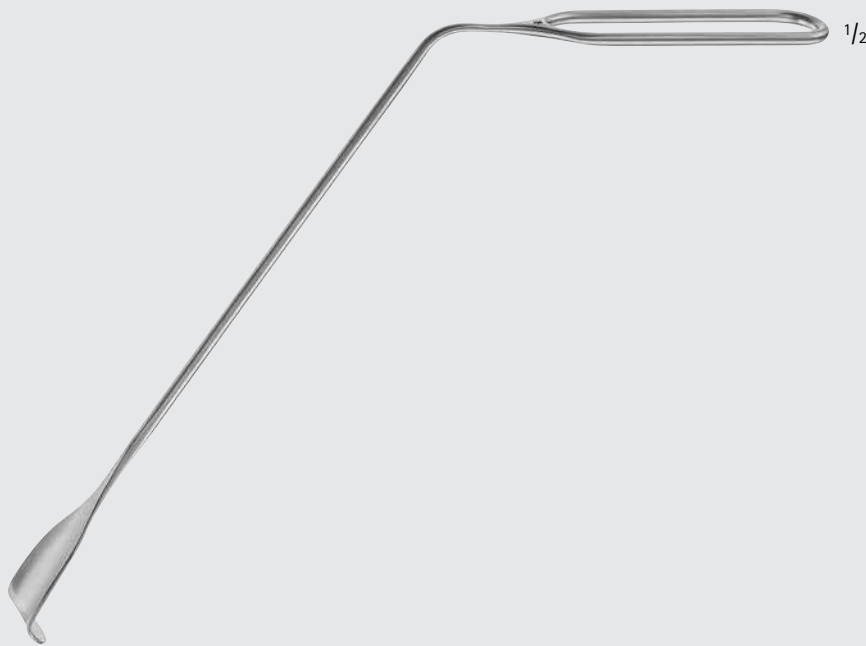

1/2

MA719R



1/1

MA719R

LOTHROP Uvula Retractor

Catalog Number	Blade Size (mm)	Length (in.)
MA719R	17 x 20	9 5/8



1/2

MA608R

GOODYEAR Uvula Retractor

Catalog Number	Blade Size (mm)	Length (in.)
MA608R	15	7 3/8

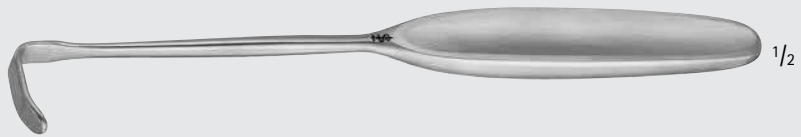

1/2

MB785R



1/1

MB785R

LAHEY Goiter Retractor

Catalog Number	Blade Size (mm)	Length (in.)
MB785R	24 x 8	7 7/8

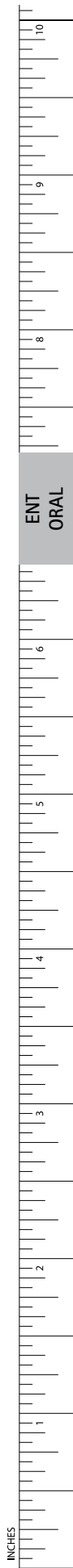

ENT-ORAL

Retractors



MA434R-MA437R

SEWALL Orbital Retractor

Catalog Number	Blade Size (mm)	Length (in.)
MA434R	7 x 52	6 3/4
MA435R	9 x 44	6 3/8
MA436R	11 x 50	6 3/8
MA437R	13 x 67	6 3/4

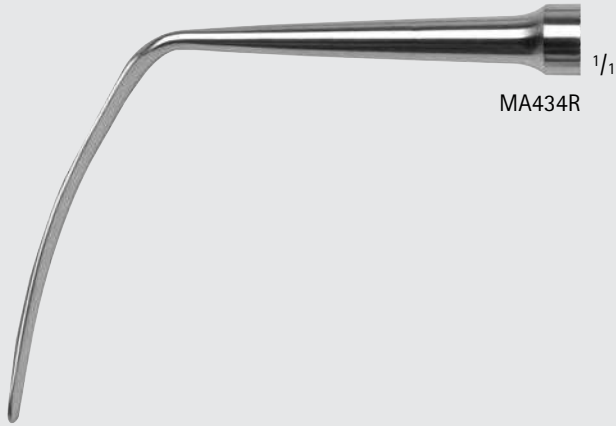

MA434R



MA435R



MA436R

ENT
ORAL

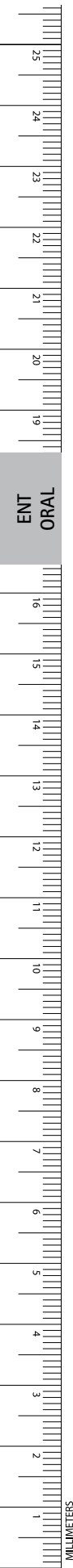

HURD Tonsil Dissector / Pillar Retractor

Catalog Number	Tip Size (mm)	Length (in.)
OM660R	6	8 1/2
OM661R	10	8 1/2

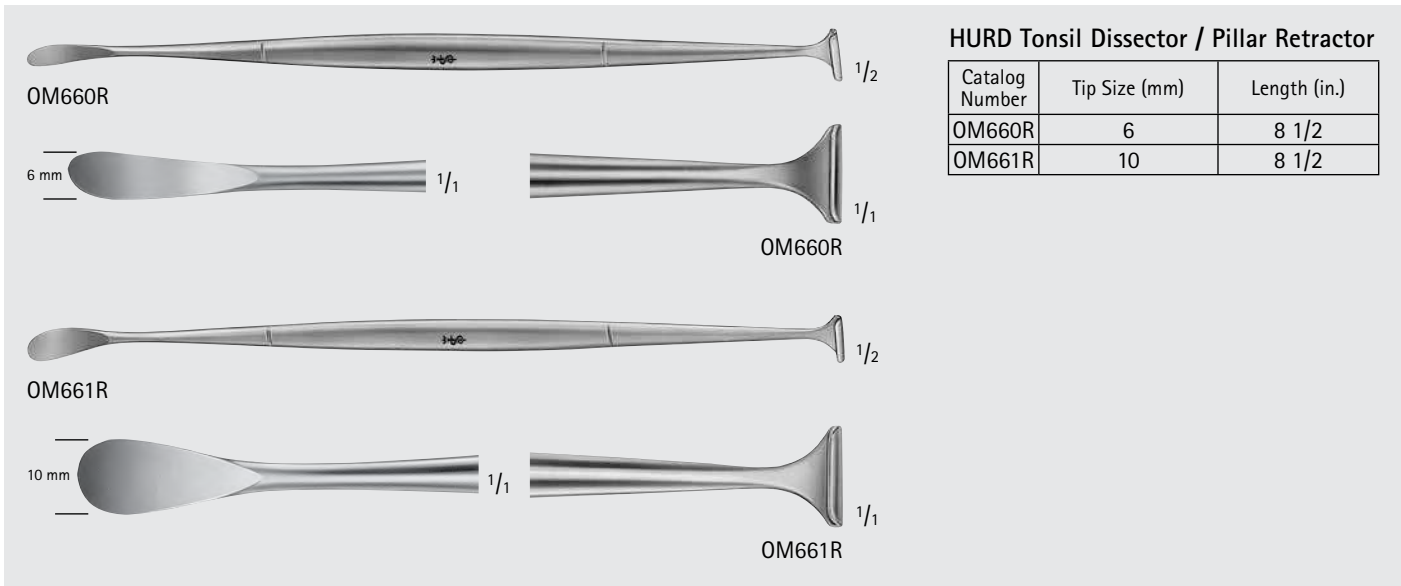

HENKE Tonsil Dissector

Catalog Number	Tip Size (mm)	Length (in.)
OM668R	12	9 1/4

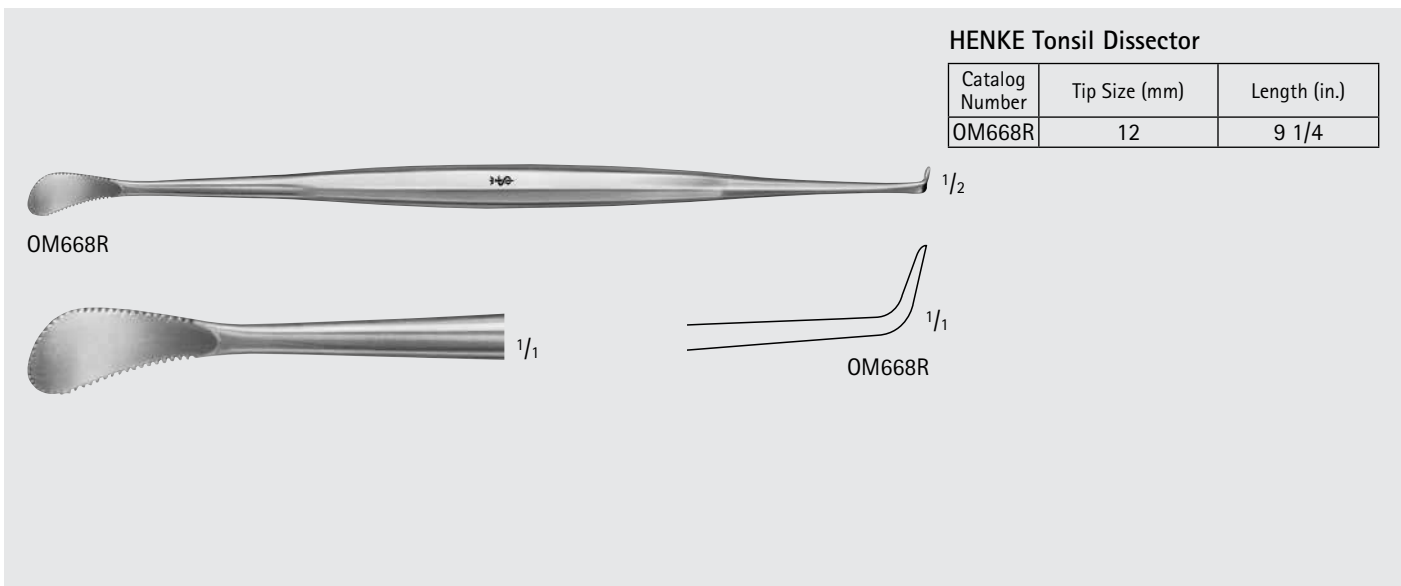

LOTHROP Tonsil Knife and Dissector

Catalog Number	Length (in.)
MA289R	8 1/4

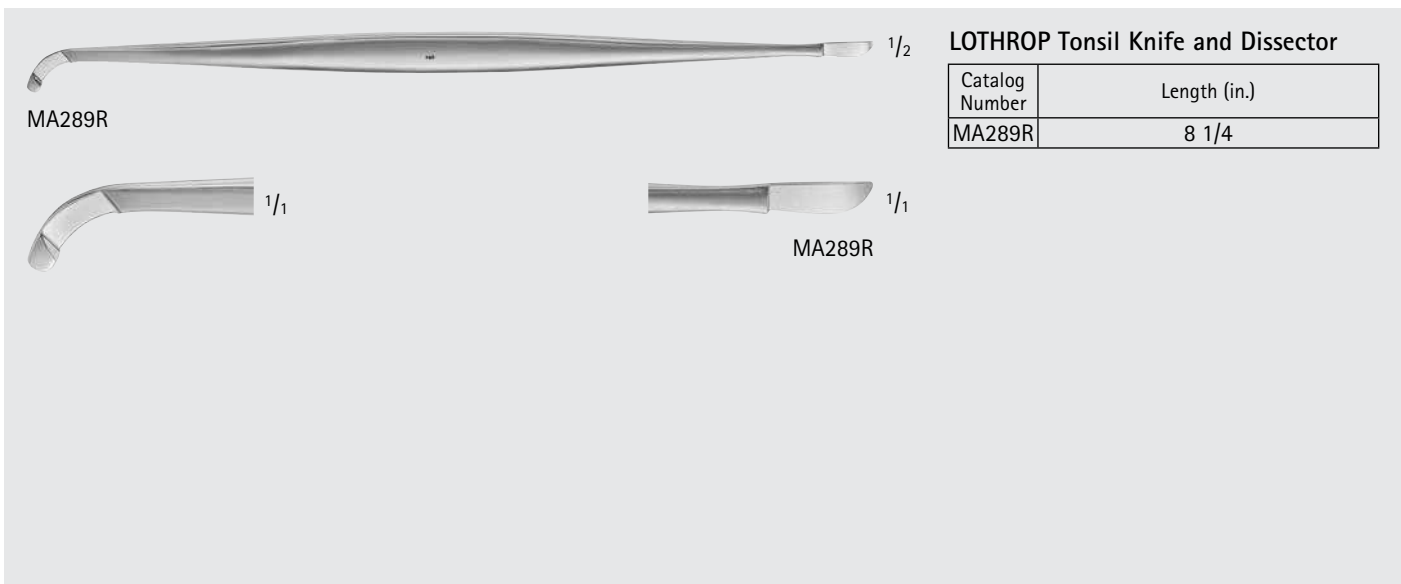



ENT
ORAL

INCHES

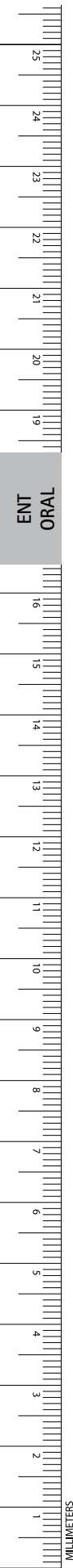

ENT-ORAL

Adenotomes/Tonsil Snares/Wires



OM391R-OM398R

LA FORCE Adenotome

Catalog Number	Size (#)	Description	Length (in.)
OM391R	1	-	9 1/4
OM392R	2	-	9 1/4
OM393R	3	-	9 1/4
OM396R	-	SPARE BLADE F/ OM391R	-
OM397R	-	SPARE BLADE F/ OM392R	-
OM398R	-	SPARE BLADE F/ OM393R	-



OM396R



1/1

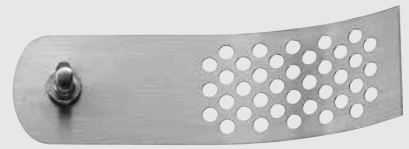

OM397R



1/1

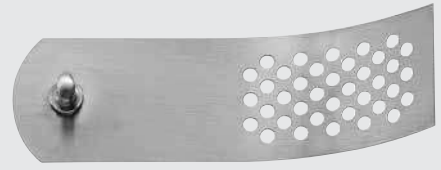

OM398R



1/1

EVES Tonsil Snare W/ 25 Gauge Wire

Catalog Number	Description	Length (in.)
OM760R	W/O RATCHET	9 3/4
OM761R	W/ RATCHET	9 3/4

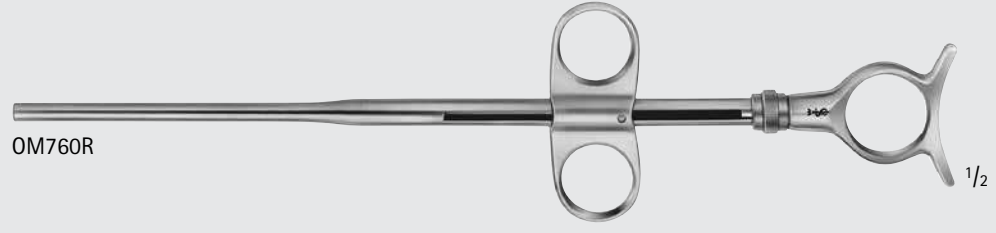

OM760R

1/2



OM761R

1/2

LEWIS Tonsil Snare

Catalog Number	Description	Length (in.)
MA714R	INCLUDES 12 #8 SNARE WIRES	10 1/4

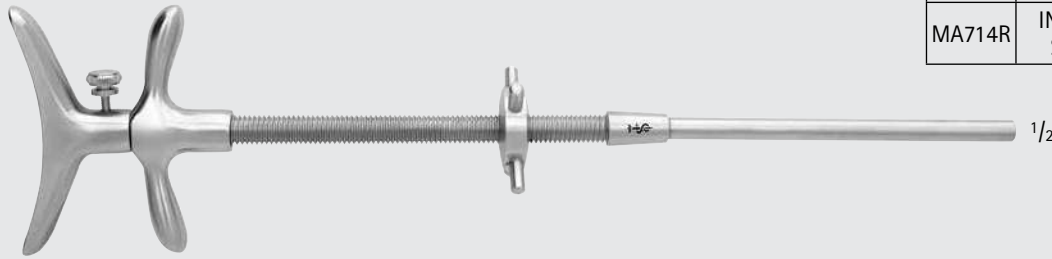

MA714R

SAGE Tonsil Snare

Catalog Number	Description	Length (in.)
MA493R	W/ SNARE WIRES	11
MA490R	12 #6 SNARE WIRES	4

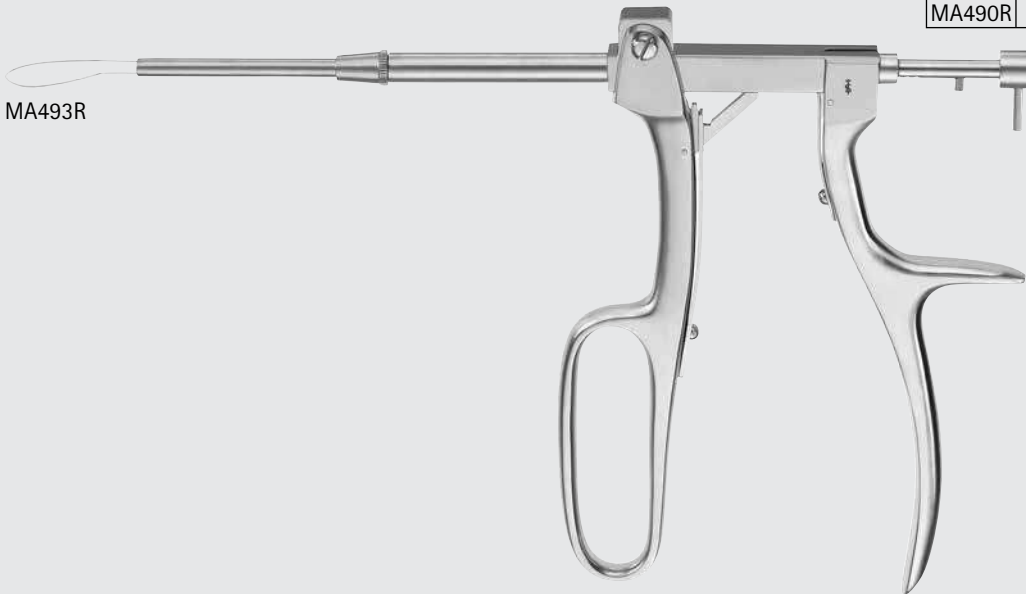

MA493R



MA490R



INCHES

ENT-ORAL

Tonsil Snares/Wires/Adenotomes

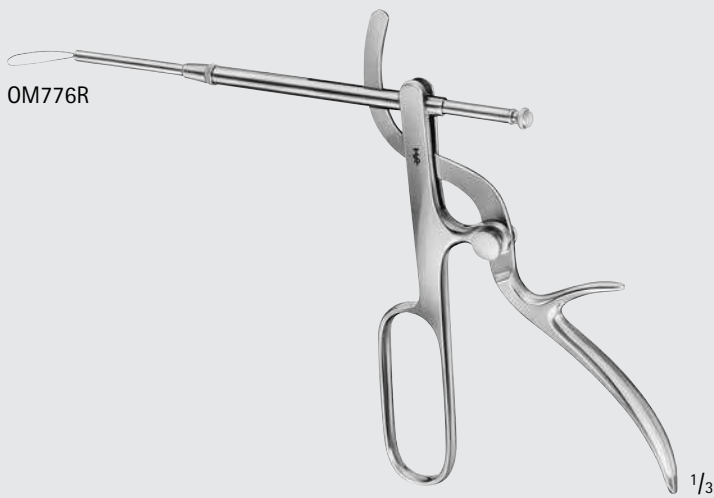
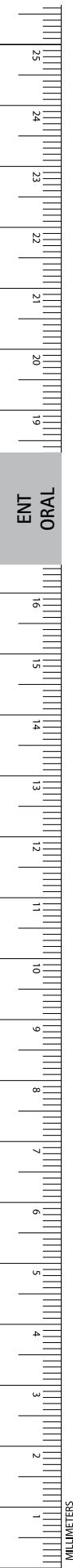

OM776R



OM781R

TYDING Tonsil Snare

Catalog Number	Description
OM781R	-
OM776R	TIP ONLY, STR

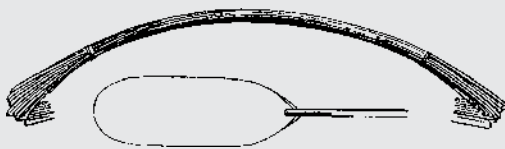

OM750R-OM751R



MA490R

Tonsil Snare Wire

Catalog Number	Diameter (mm)	Size (#)	Sales Unit	Length (mm)
MA490R	1.4	6	12/BOX	100
OM750R	0.3	7	12/BOX	100
OM751R	0.5	8	12/BOX	100

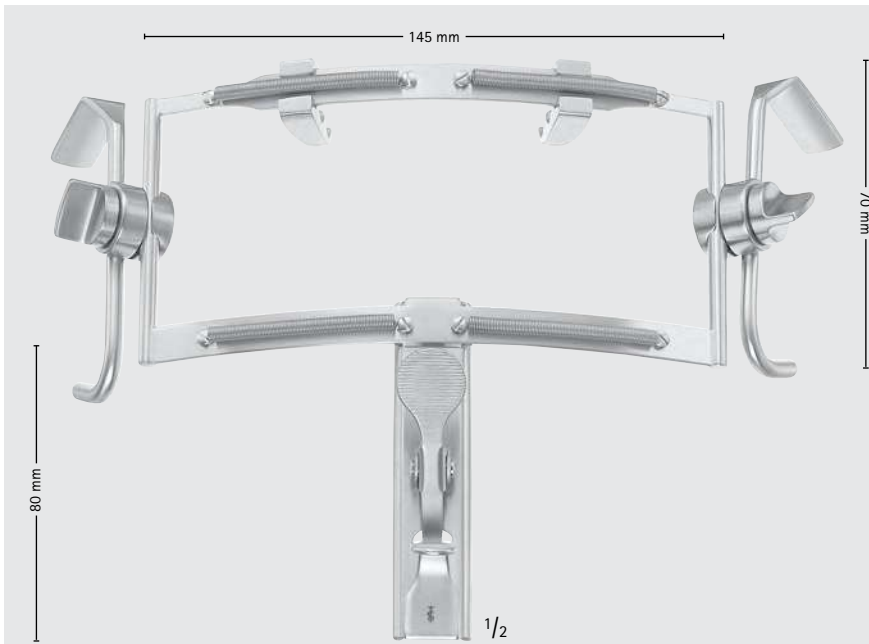

DINGMAN Mouth Gag

Catalog Number	Description
MA299R	COMPLETE SET WITH 3 BLADES AND FRAME

MA299R Includes:
1 Mouth Gag OM105R,
1 Blade of each OM171R, OM172R, OM177R

MA299R



MOLT Mouth Gag, Pediatric

Catalog Number	Description	Length (in.)	Length (m)
OM038R	-	4	-
TA009706	SPARE SILICONE TUBE ONLY, LATEX-FREE	-	1

TA009706 Protective covers for OM038R and OM040R available as silicone tubing which may be cut to length

OM038R



DOYEN-COLLIN Mouth Gag

Catalog Number	Description	Length (in.)	Length (m)
OM040R	-	4 3/4	-
TA009706	SPARE SILICONE TUBE ONLY, LATEX-FREE	-	1

TA009706 Protective covers for OM038R and OM040R available as silicone tubing which may be cut to length

OM040R, TA009706



ENT
ORAL

INCHES

ENT-ORAL
Mouth Gags

DOYEN-JANSEN Mouth Gag

Catalog Number	Description	Length (in.)	Length (m)
OM041R	-	5 1/2	-
TA005771	SPARE SILICONE TUBE ONLY, LATEX-FREE	-	1

TA005771 Protective covers for OM041R available as silicone tubing which may be cut to length

DENHARDT Mouth Gag

Catalog Number	Length (in.)
OM047R	5

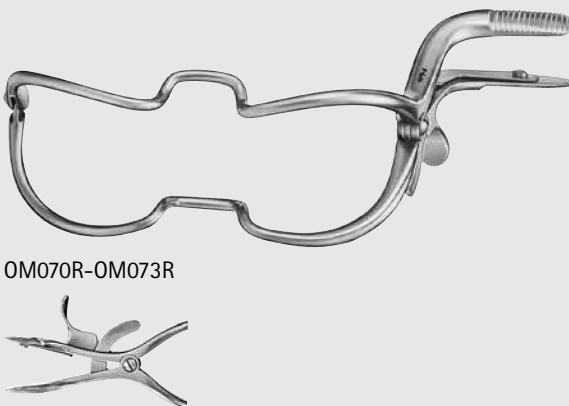
WHITEHEAD-JENNINGS Mouth Gag

Catalog Number	Length (in.)
OM070R	3 1/2
OM071R	4 1/4
OM072R	5 1/8
OM073R	6

Teeth Protector, Latex-Free Rubber

Catalog Number	Size
OP299	ADOLESCENT AND ADULT

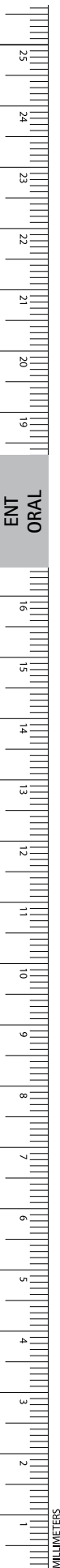



MA307R



MA304R



MA305R



MA306R

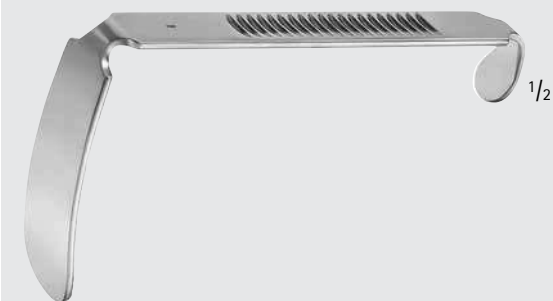

MA308R

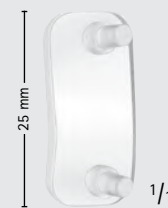

OM170

DAVIS Mouth Gag

Catalog Number	Blade Size (mm)	Size (#)	Description	Length (in.)
MA302R	-	-	COMPLETE SET, RIGHT	-
MA303R	-	-	COMPLETE SET, LEFT	-
MA307R	-	-	RIGHT FRAME ONLY	6
MA304R	20 x 34	1	BLADE	5 1/4
MA305R	23 x 64	2	BLADE	5 1/4
MA306R	25 x 79	3	BLADE	5 1/4
MA308R	25 x 85	3 1/2	BLADE	5 1/8
MA309R	25 x 95	4	BLADE	5 1/8
MA310R	25 x 106	5	BLADE	5 1/8
OM170	SILICONE INSERT			

MA302R Includes:

1 Blades w/ Tube of each MA304R, MA307R, OM112R, MA315R, OM114R, OM115R

MA303R Includes:

1 Blades w/ Tube of each OM116R, MA304R, OM112R, MA315R, OM114R, OM115R

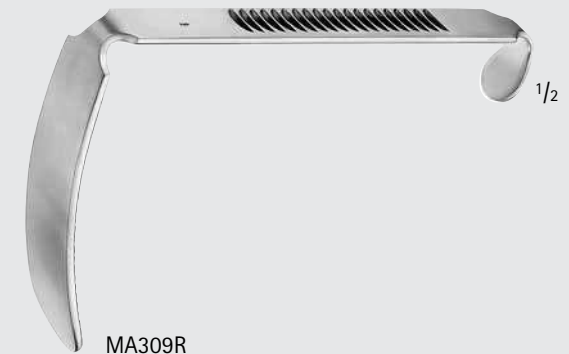

MA309R



MA310R



ENT ORAL

INCHES

ENT-ORAL

Mouth Gags



MA315R



MA319R

DAVIS Mouth Gag W/ Tube

Catalog Number	Blade Size (mm)	Size (#)
MA315R	24 x 80	3
MA319R	25 x 90	3

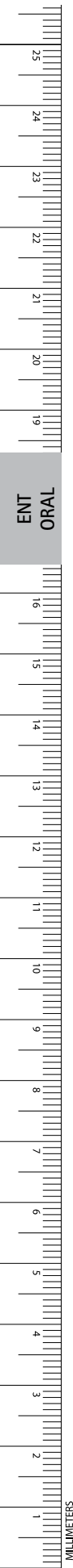

DAVIS-BOYLE Mouth Gag

Catalog Number	Blade Size (mm)	Size	Description	Length (in.)
OM118R	-	CHILD	FRAME ONLY	5 1/4
OM119R	-	TEEN	FRAME ONLY	5 3/4
OM116R	-	ADULT	FRAME ONLY	6 3/4
OM112R	25 x 62	-	BLADE	-
OM113R	25 x 75	-	BLADE	-
OM114R	25 x 92	-	BLADE	-
OM115R	25 x 108	-	BLADE	-
OM170	SILICONE INSERT			



OM118R



OM119R



OM116R



OM112R-OM115R

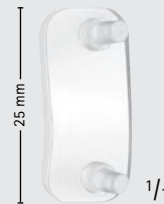

OM170

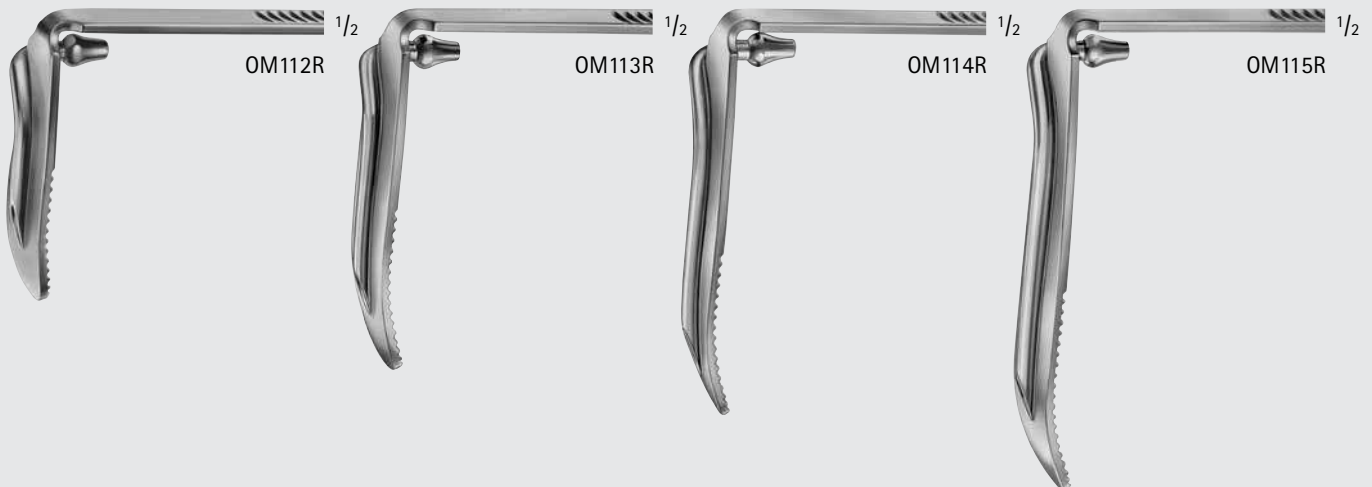

OM112R

OM113R

OM114R

OM115R

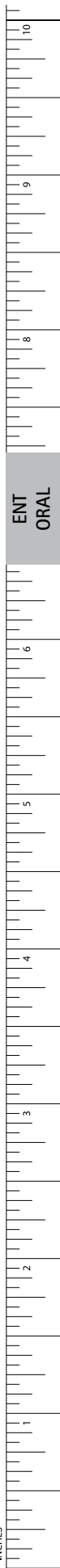

ENT
ORAL

INCHES

ENT-ORAL

Mouth Gags

DAVIS-MEYER Tongue Depressor Frame

Catalog Number	Description
OM169R	FRAME, COMPLETE
OM170	SILICONE INSERT
OM179R	PALATE BLADE



OM169R



1/1



1/1

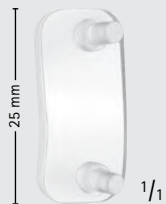

OM170



1/2

OM179R

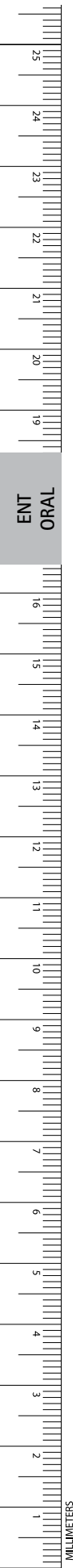

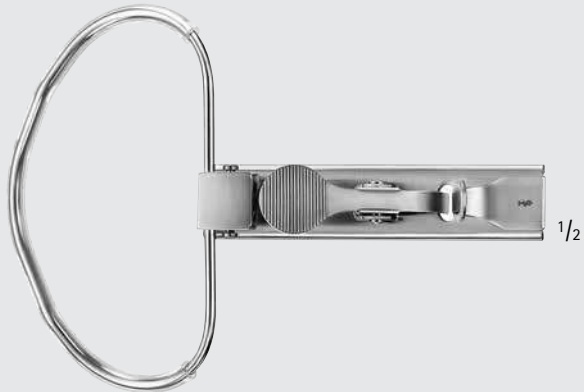

MA311R



MA312R-MA314R

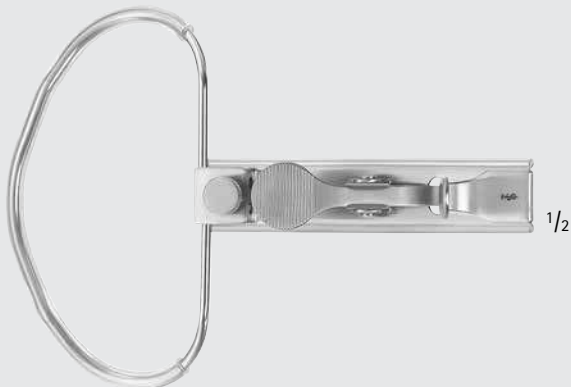

OM104R



MB595R-MB600R

MCIVOR Mouth Gag

Catalog Number	Blade Size (mm)	Size (#)	Description	Length (in.)
MA311R	-	-	COMPLETE WITH FRAME AND 3 TONGUE BLADES	-
MA312R	22 x 69	1	BLADE	5 3/8
MA313R	24 x 90	2	BLADE	5 3/8
MA314R	25 x 100	3	BLADE	5 3/8
OM104R	-	-	FRAME F/ TONGUE DEPRESSOR	5 1/2
OM104201	-	-	REPLACEMENT TUBE F/ OM104R	-
OM101R	25 x 55	-	BLADE	-
OM102R	25 x 62	-	BLADE	-
OM103R	25 x 75	-	BLADE	-
MB595R	57 x 23	2	BLADE, RIGHT	-
MB596R	72 x 27	3	BLADE, RIGHT	-
MB597R	88 x 33	4	BLADE, RIGHT	-
MB598R	57 x 23	2	BLADE, LEFT	-
MB599R	72 x 27	3	BLADE, LEFT	-
MB600R	88 x 33	4	BLADE, LEFT	-
MA301R	97 x 36	5	BLADE, LEFT	-
MA300R	97 x 36	5	BLADE, RIGHT	-



OM101R-OM103R



MA300R-MA301R

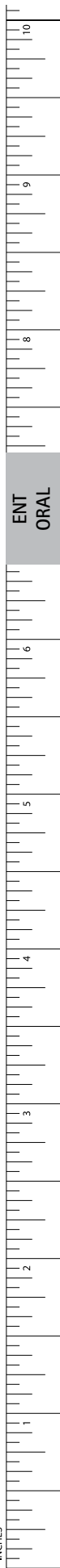

ENT
ORAL

INCHES

ENT-ORAL

Mouth Gags

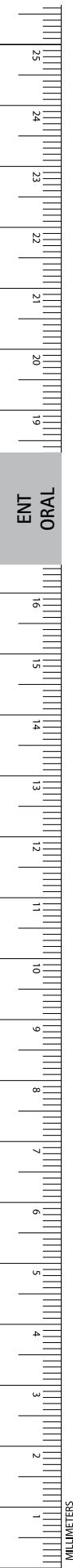

OM171R-OM178R

RUSSEL-DAVIS Tongue Blade

Catalog Number	Blade Size (mm)
OM171R	29 x 67
OM172R	33 x 75
OM173R	38 x 85
OM174R	40 x 92
OM175R	46 x 100
OM176R	18 x 57
OM177R	22 x 67
OM178R	25 x 75



OM171R



OM172R



OM173R



OM174R



OM175R



OM176R



OM177R



OM178R

GAST Tongue Blade

Catalog Number	Blade Size (mm)
OM181R	28 x 64
OM182R	34 x 74
OM183R	38 x 87



OM181R-OM183R



OM181R

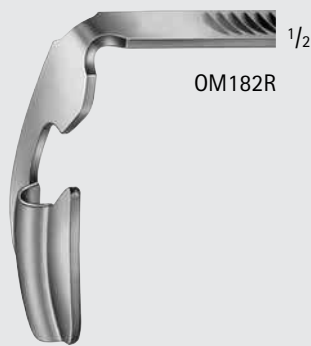

OM182R



OM183R

DRAFFIN Chest Support, W/ 4 Height Rings

Catalog Number	Length (in.)
OM186R	18 7/8

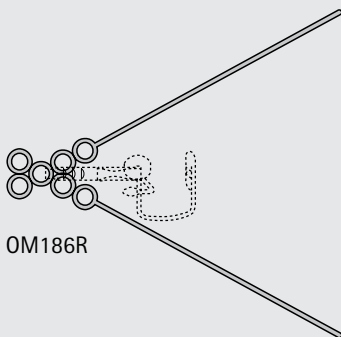

OM186R

MAGAURAN Plate, F/ Holding OM186R

Catalog Number	Length (in.)
OM187R	16

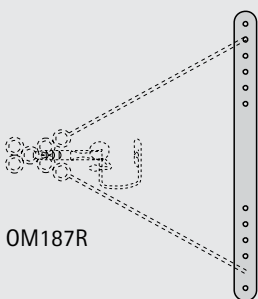

OM187R

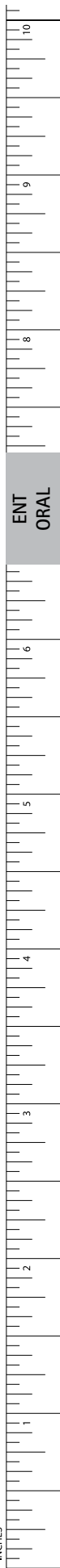

INCHES

ENT-ORAL

Tonsil Knives

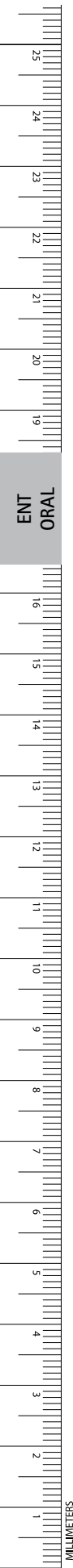

OM681R



OM681R

ABRAHAM Tonsil Knife

Catalog Number	Length (in.)
OM681R	8 3/4



OM688R



OM688R

FISHER Tonsil Knife

Catalog Number	Length (in.)
OM688R	8

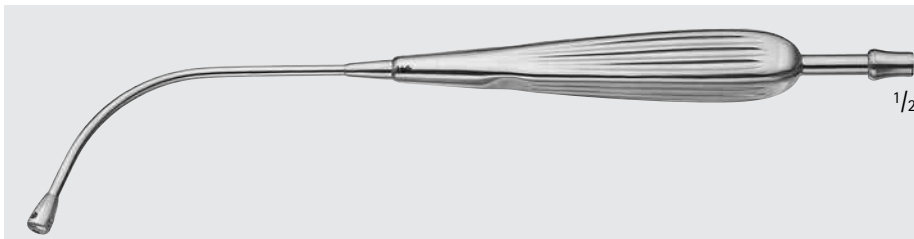
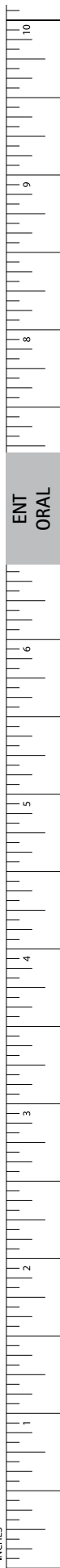

ANDREWS Pynchon Suction Tube

Catalog Number	Description	Length (in.)
MD613	-	9
MD613001	TIP ONLY F/ MD613	-

MD613



MD613001

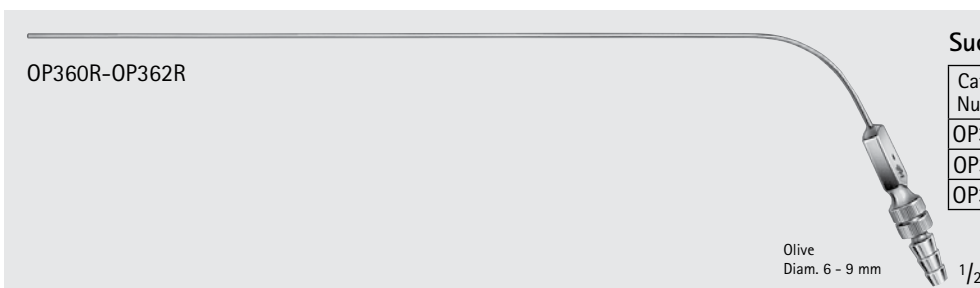

OP360R-OP362R

Suction Tube, W/ Finger Cut-Off

Catalog Number	Tip Size (mm)	Working Length (in.)
OP360R	2.0	9 3/4
OP361R	2.5	9 3/4
OP362R	3.0	9 3/4

Olive
Diam. 6 - 9 mm

JACKSON Velvet Eye Aspirating Tube

Catalog Number	Diameter (mm)	Length (in.)
MB366R	4.0	10
MB367R	4.0	16 3/8
MB368R	4.0	22
MB369R	4.0	18 1/8

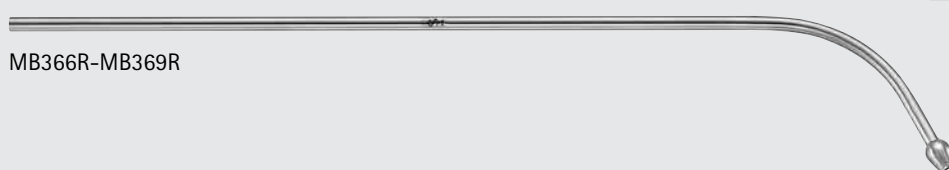

MB366R-MB369R

ENT-ORAL

Curettes



OM471R-OM474R

BARNHILL Adenoid Curette

Catalog Number	Tip Size (mm)	Length (in.)
OM471R	11	7 7/8
OM472R	13	7 7/8
OM473R	15	7 7/8
OM474R	17	7 7/8

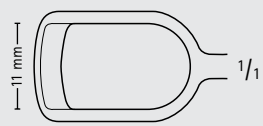

OM471R

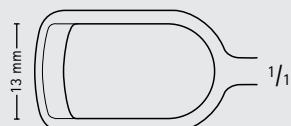

OM472R



OM473R

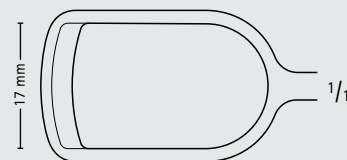

OM474R



OM451R-OM456R

BECKMANN Adenoid Curette

Catalog Number	Tip Size (mm)	Length (in.)
OM451R	9.25	7 7/8
OM452R	11.5	7 7/8
OM453R	12	7 7/8
OM454R	13	7 7/8
OM455R	15.5	7 7/8
OM456R	16	7 7/8
OM500R	10	8 3/4
OM501R	12	8 3/4
OM502R	14	8 3/4
OM503R	16	8 3/4
OM504R	18	8 3/4
OM505R	20	8 3/4

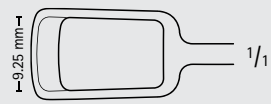

OM451R

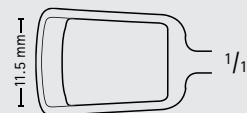

OM452R

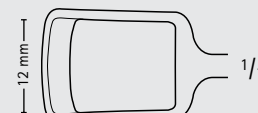

OM453R



OM454R



OM455R



OM456R



OM500R-OM505R



OM500R



OM501R



OM502R

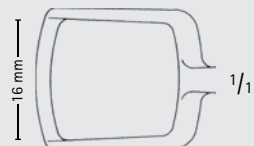

OM503R



OM504R



OM505R

ENT ORAL



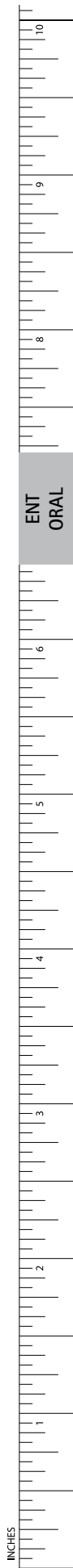

ENT
ORAL



JONES Adenoid Curette

Catalog Number	Tip Size (mm)	Size (#)	Size	Length (in.)
MA656R	4	1	INFANT	8 3/4
MA655R	6	2	CHILD	8 7/8
MA654R	8	3	ADULT	8 7/8



MIDDLETON Adenoid Curette

Catalog Number	Tip Size (mm)	Length (in.)
MA291R	7	8 7/8

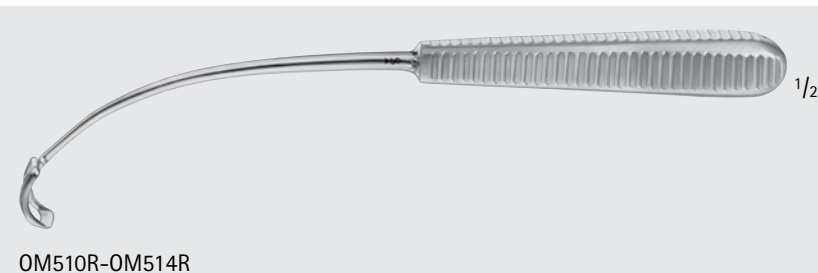

NEGUS Adenoid Curette

Catalog Number	Tip Size (mm)	Length (in.)
OM510R	10	7 7/8
OM511R	12.25	7 7/8
OM512R	14	7 7/8
OM513R	16.5	7 7/8
OM514R	18	7 7/8

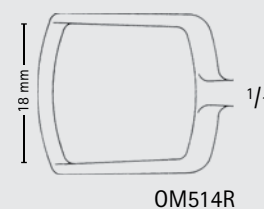
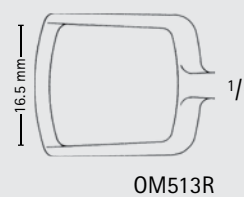
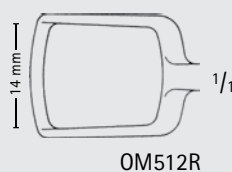
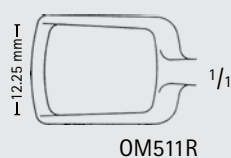
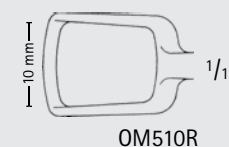

INCHES

ENT-ORAL

Curettes



US149-US150

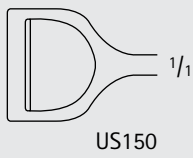
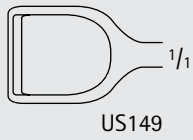

MA066R-MA067R

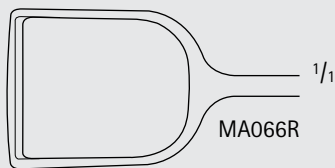
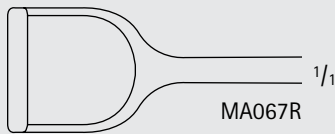

STUBBS Adenoid Curette

Catalog Number	Tip Size (mm)	Size (#)	Length (in.)
US149	11	0	8 1/2
US150	14	1	8 1/2
MA067R	16	2	8 1/2
MA066R	18	3	8 1/2



MB316R



VOGEL Adenoid Curette, Infant

Catalog Number	Tip Size (mm)	Length (in.)
MB316R	7	8 1/2

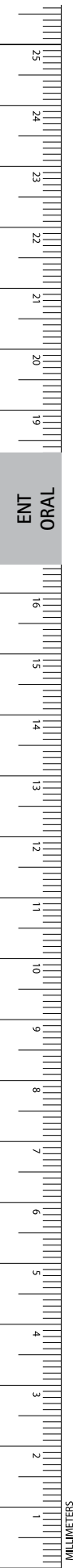

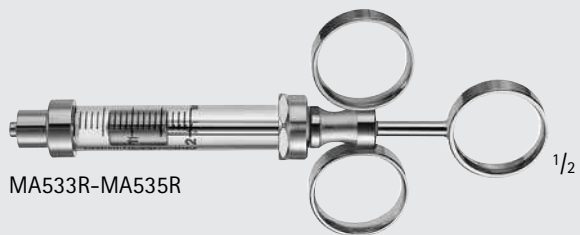

MA533R-MA535R

Syringe

Catalog Number	Diameter (mm)	Volume (cc)	Length (in.)
MA533R	11	3	5 1/2
MA534R	14	5	5 1/2
MA535R	17	10	5 1/2

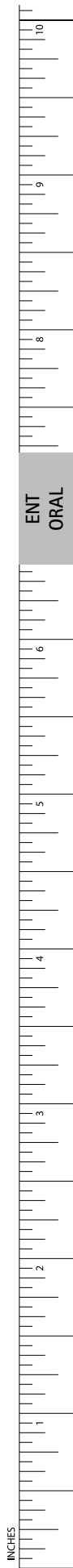

ENT
ORAL

ENT-ORAL

Laryngeal Mirrors

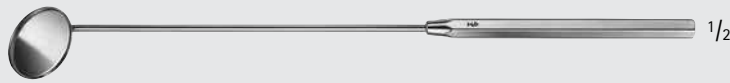

OM078R-OM090R

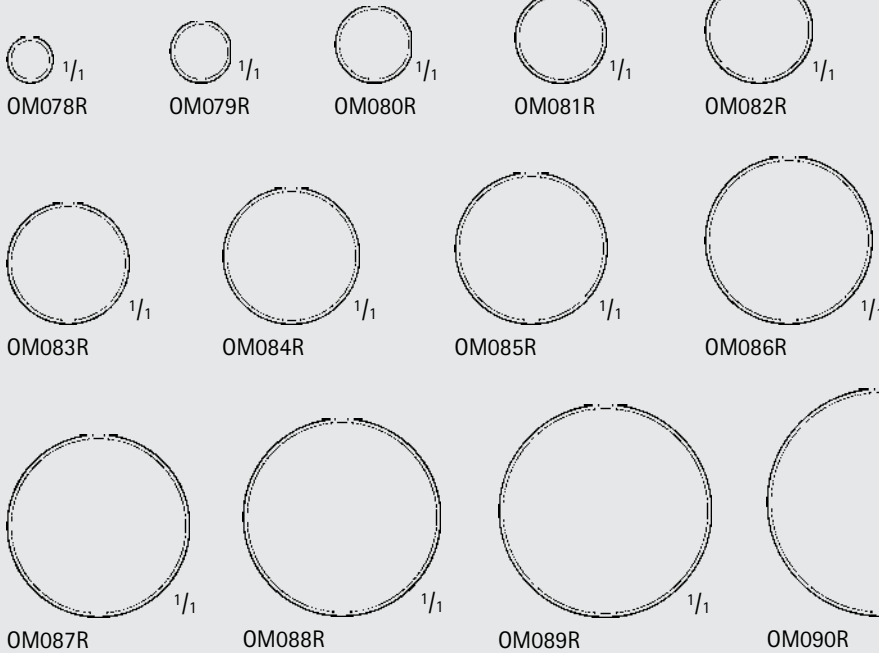

Laryngeal Mirror, Rigid, W/ Hex Handle

Catalog Number	Size (#)	Diameter (mm)	Length (in.)
OM078R	000	6.0	7
OM079R	00	8.0	7
OM080R	0	10.0	7
OM081R	1	12.0	7
OM082R	2	14.0	7
OM083R	3	16.0	7
OM084R	4	18.0	7
OM085R	5	20.0	7
OM086R	6	22.0	7
OM087R	7	24.0	7
OM088R	8	26.0	7
OM089R	9	28.0	7
OM090R	10	30.0	7



AC468R-AC480R



AC481R

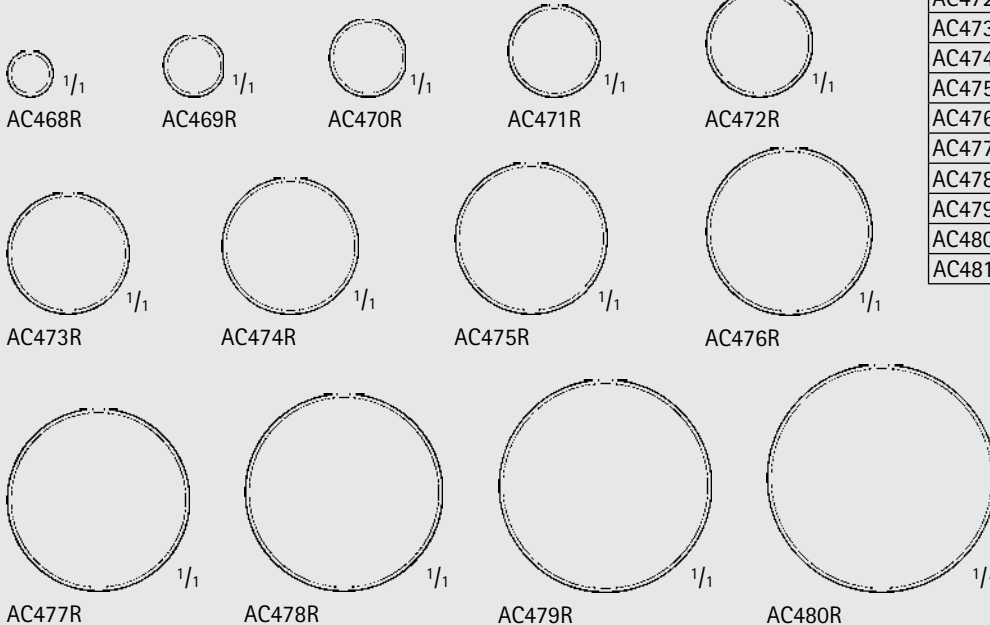

Laryngeal Mirror, Rigid, F/ Handle
AC481R

Catalog Number	Size (#)	Diameter (mm)	Length (in.)
AC468R	000	6.0	4 3/4
AC469R	00	8.0	4 3/4
AC470R	0	10.0	4 3/4
AC471R	1	12.0	4 3/4
AC472R	2	15.0	4 3/4
AC473R	3	16.0	4 3/4
AC474R	4	18.0	4 3/4
AC475R	5	20.0	4 3/4
AC476R	6	22.0	4 3/4
AC477R	7	24.0	4 3/4
AC478R	8	26.0	4 3/4
AC479R	9	28.0	4 3/4
AC480R	10	30.0	4 3/4
AC481R	-	HANDLE	4 1/4





Amalgam Carrier, Double Ended

Catalog Number	Size	Length (in.)
MG574R	MEDIUM / LARGE	7 7/8

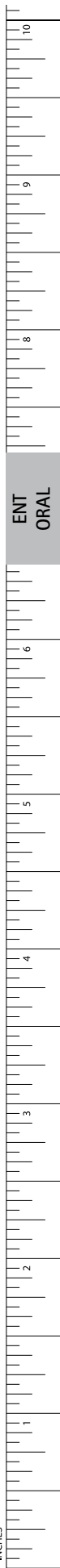



 **Manufacturing Unit -**

***115-A Waryana Industrial Complex, Leather Complex Road,
Jalandhar Punjab, 144021***

 **Sales Office -**

***Plot No. 581- Kakrola Housing Complex, Near Metro Pillar 802,
Dwarka Mor, Delhi, 110078***

 **Our Certifications -**

***UDYAM , ISO 13485, WHO-GMP, ISO 9001:2015, CE , ROHS,
FDA , MD-42, MD-5***

CONTACT US:

 +91- 98141-81255, +91- 98142-62255

 www.alisprofessional.com

 info@royalinternational.org