



ENT-Nasal

Scissors	596 - 614
Trocar, Needles and Needle Holders	615 - 617
Forceps	618 - 649
Nasal Snares and Wires	650
Hooks	651
Retractors	652 - 657
Elevators and Dissectors	658 - 664
Specula	665 - 673
Rasps, Files and Saws	674 - 677
Chisels and Gouges	678 - 679
Osteotomes	680 - 685
Applicators and Probes	686
Knives	687 - 688
Suction and Irrigation	689 - 692
Mallets, Hammers and Tamps	693 - 694
Curettes	695 - 698
Rongeurs	699 - 703

ENT-NASAL

Scissors

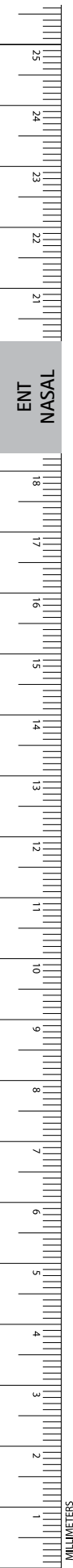

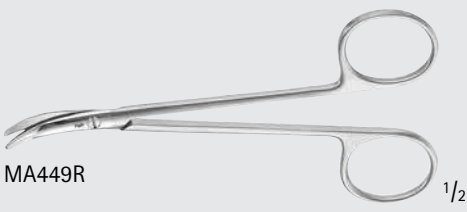

MA449R $\frac{1}{2}$

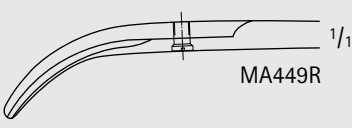

MA449R $\frac{1}{1}$

CINELLI Lower Lateral Scissors

Catalog Number	Blade	Length (in.)
MA449R	STRONG CVD	4 3/8

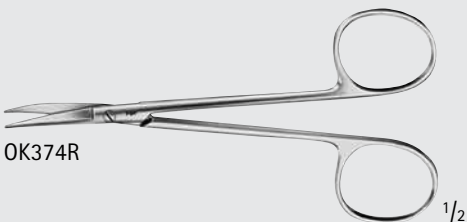

OK374R $\frac{1}{2}$

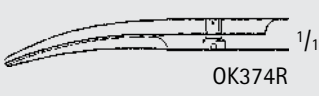

OK374R $\frac{1}{1}$

COTTLE Bulldog Scissors

Catalog Number	Tip	Blade	Length (in.)
OK374R	B/B	CVD	4 1/2

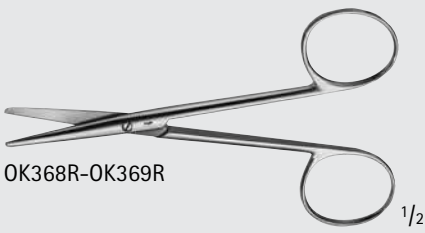

OK368R-OK369R $\frac{1}{2}$

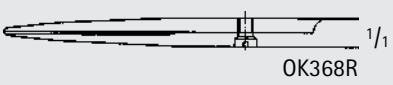

OK368R $\frac{1}{1}$

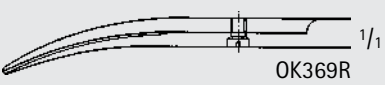

OK369R $\frac{1}{1}$

COTTLE-KNAPP Plastic Scissors

Catalog Number	Tip	Blade	Length (in.)
OK368R	B/B	STR	4 1/8
OK369R	B/B	CVD	4 1/8



OK365R-OK367R $\frac{1}{2}$

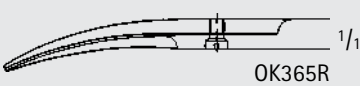

OK365R $\frac{1}{1}$

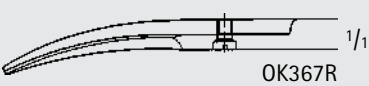

OK367R $\frac{1}{1}$

COTTLE-MASING Plastic Scissors

Catalog Number	Tip	Blade	Length (in.)
OK365R	S/S	CVD	4 1/8
OK367R	B/B	CVD	4 1/8

DAVIS Rhytidectomy Scissors

Catalog Number	Blade	Length (in.)
MA450R	CVD	6 3/4

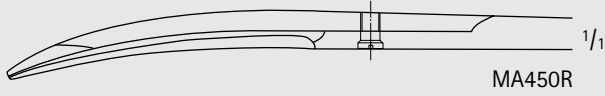
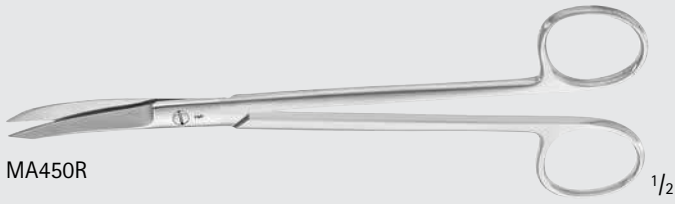

Rhinoplasty Scissors

Catalog Number	Tip	Blade	Length (in.)
MG086R	B/B	FLAT, CVD	5 1/4

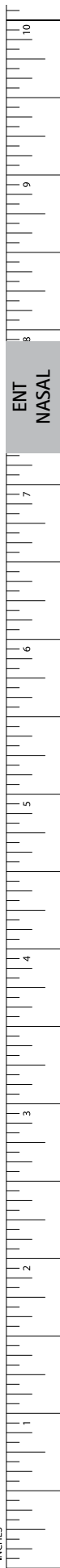
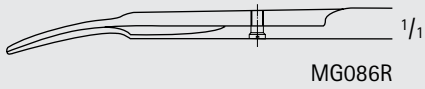
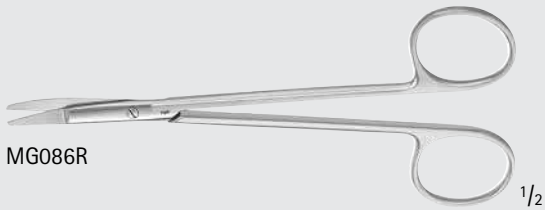

ENT-NASAL

Scissors

MA335R-MA337R

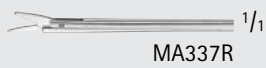
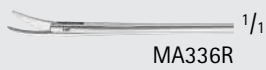

Nasal Scissors, Pediatric

Catalog Number	Blade	Blade Size (mm)	Length (in.)
MA335R	STR	6	4
MA336R	CVD-RIGHT	5.5	4
MA337R	CVD-LEFT	5.5	4

MA318R, MA600R, MA599R

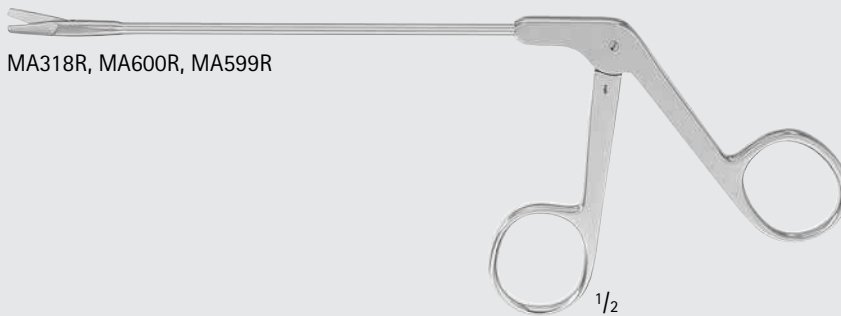

Nasal Scissors, Adult

Catalog Number	Blade	Blade Size (mm)	Working Length (in.)
MA318R	STR	11	5 1/8
MA600R	RIGHT	11	5 1/8
MA599R	LEFT	11	5 1/8

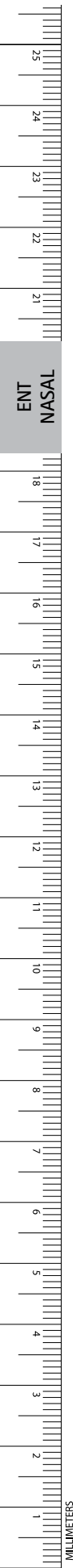



LAKESIDE Nasal Scissors

Catalog Number	Blade	Length (in.)
MA609R	STR	7 1/4

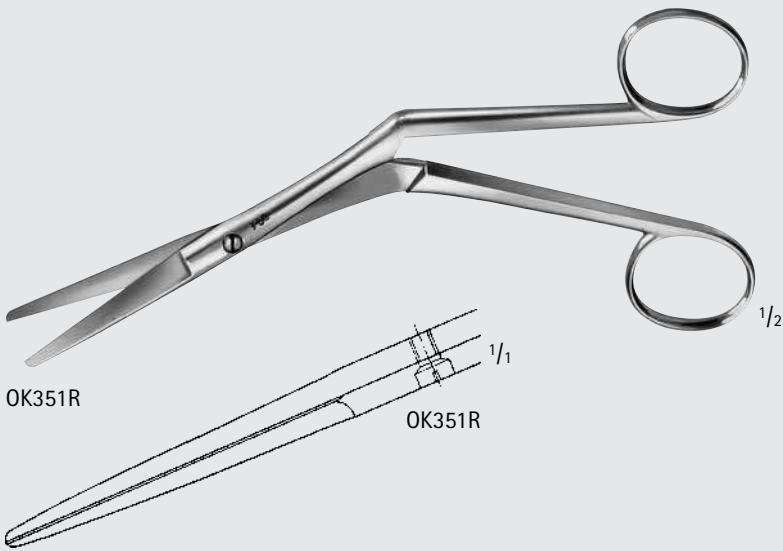

HEYMANN Nasal Scissors

Catalog Number	Tip	Blade	Length (in.)
OK351R	B/B	STR	7 1/2

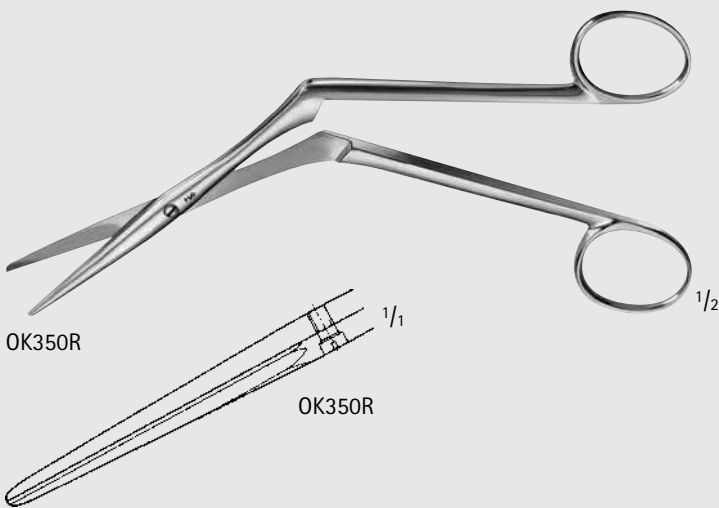

HEYMANN-KNIGHT Nasal Scissors

Catalog Number	Tip	Blade	Length (in.)
OK350R	B/B	STR	6 7/8

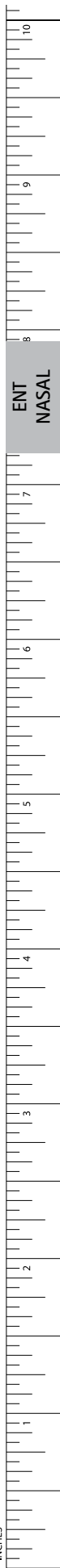

ENT-NASAL

Scissors

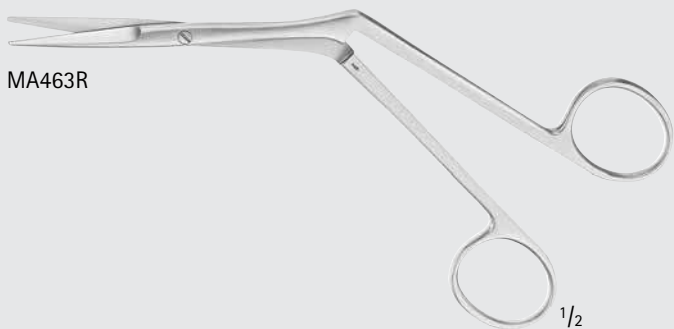

MA463R

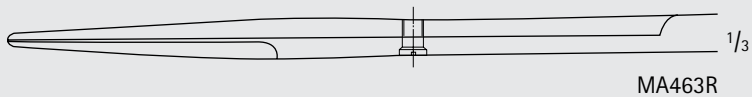

MA463R

KNIGHT Nasal Scissors, Lightweight, Delicate

Catalog Number	Blade	Tip	Length (in.)
MA463R	STR	DEL	6 3/8

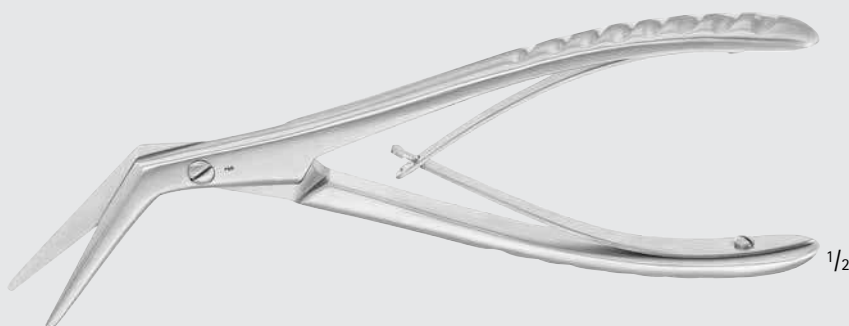

MA611R

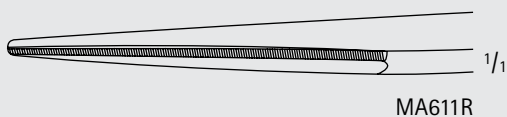

MA611R

JACKSON Nasal Bone Scissors

Catalog Number	Blade	Length (in.)
MA611R	ANG	8 1/2



MA451R

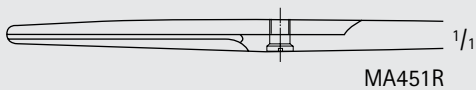

MA451R

Dorsal Scissors

Catalog Number	Tip	Blade	Length (in.)
MA451R	BLUNT	STR	4 3/4

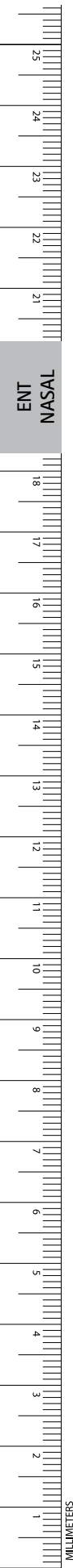

FOMON Dorsal Scissors

Catalog Number	Tip	Blade	Handle	Length (in.)
MA452R	B/B	SERR	ANG	5 3/4
OK370R	B/B	SERR	ANG	5 3/4

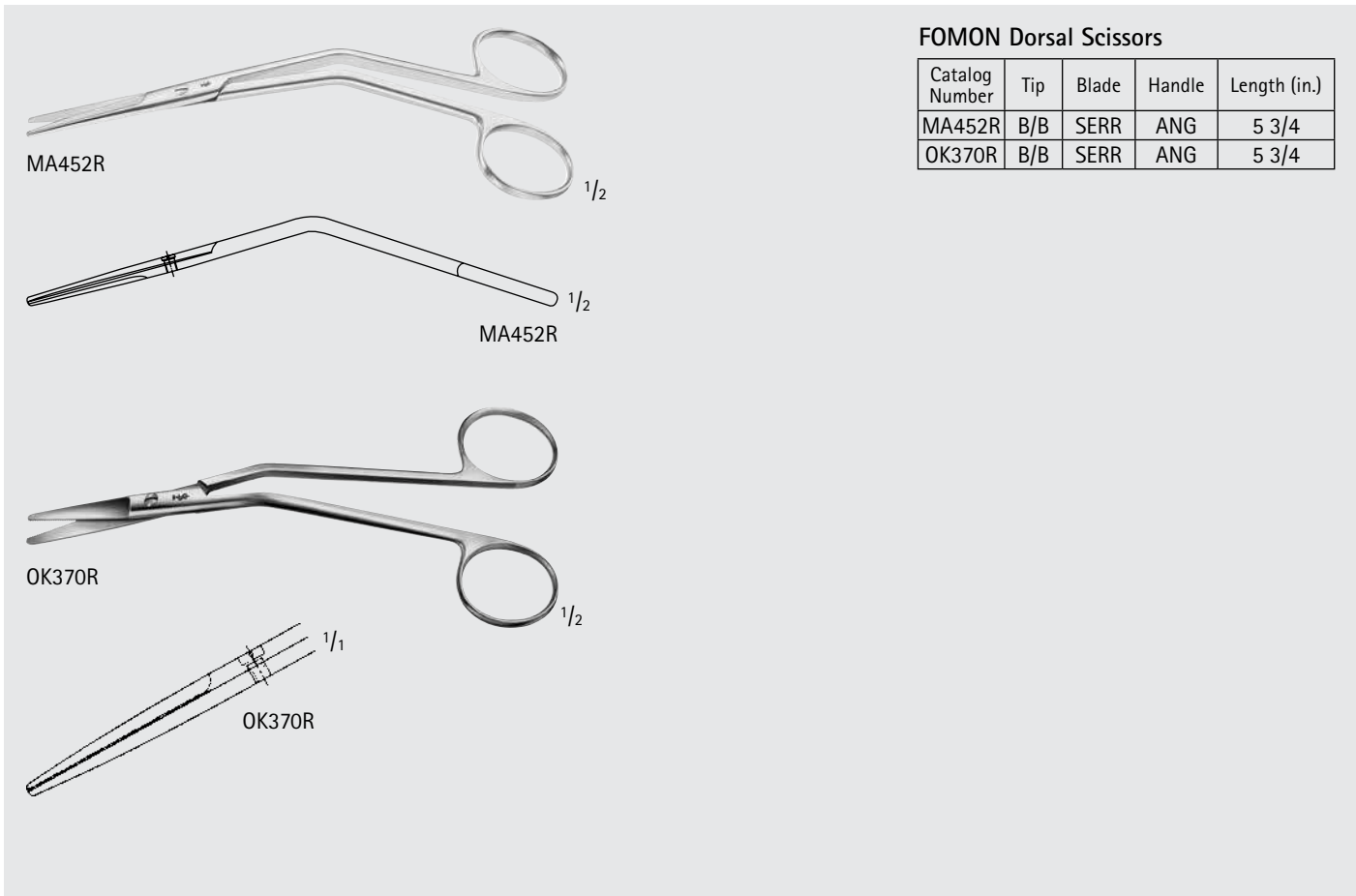

FOMON Lower Lateral Scissors

Catalog Number	Tip	Blade	Length (in.)
OK373R-OK372R	B/B	HEAVY-CVD	4 1/2
OK372R	B/B	HEAVY-CVD	5 1/4

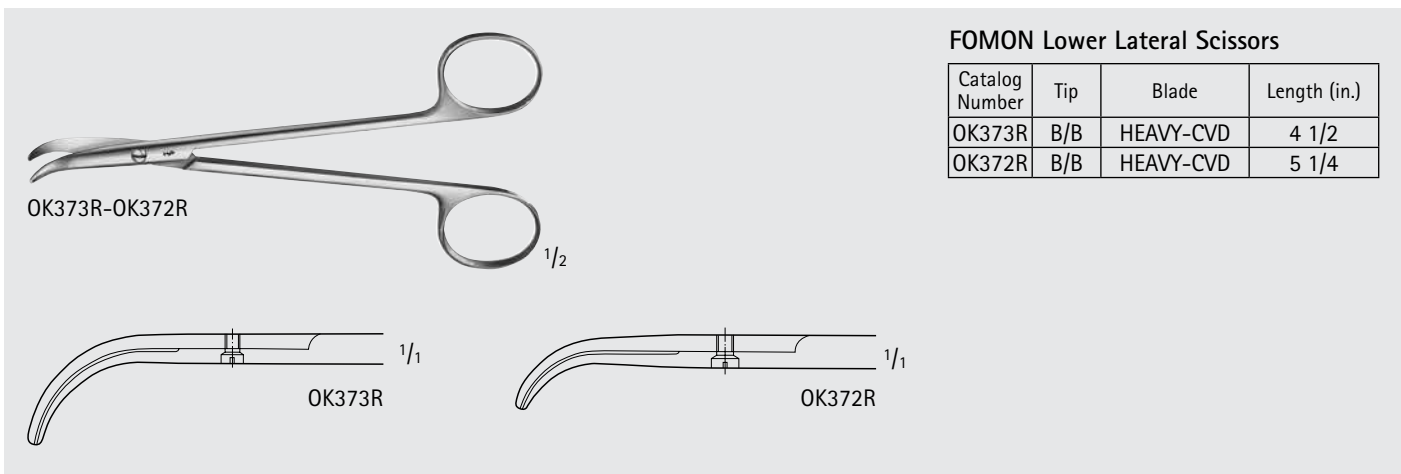

FOMON Saber-Back Scissors

Catalog Number	Tip	Blade	Length (in.)
MB140R	B/B	CVD, SERR	5

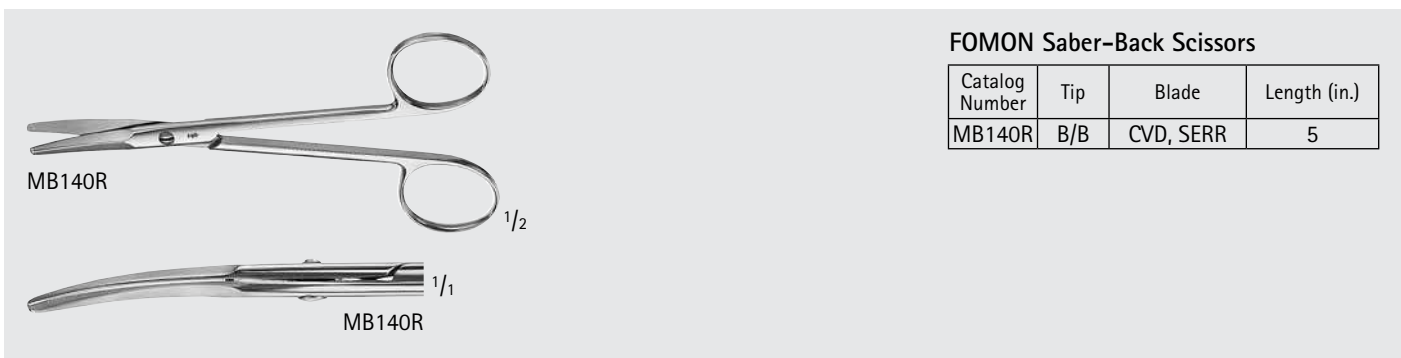
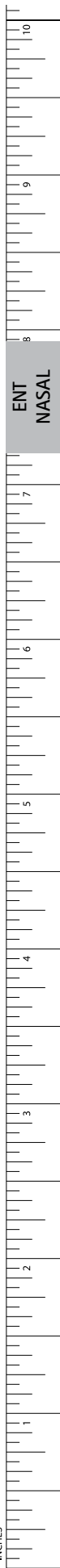
ENT-NASAL

Scissors

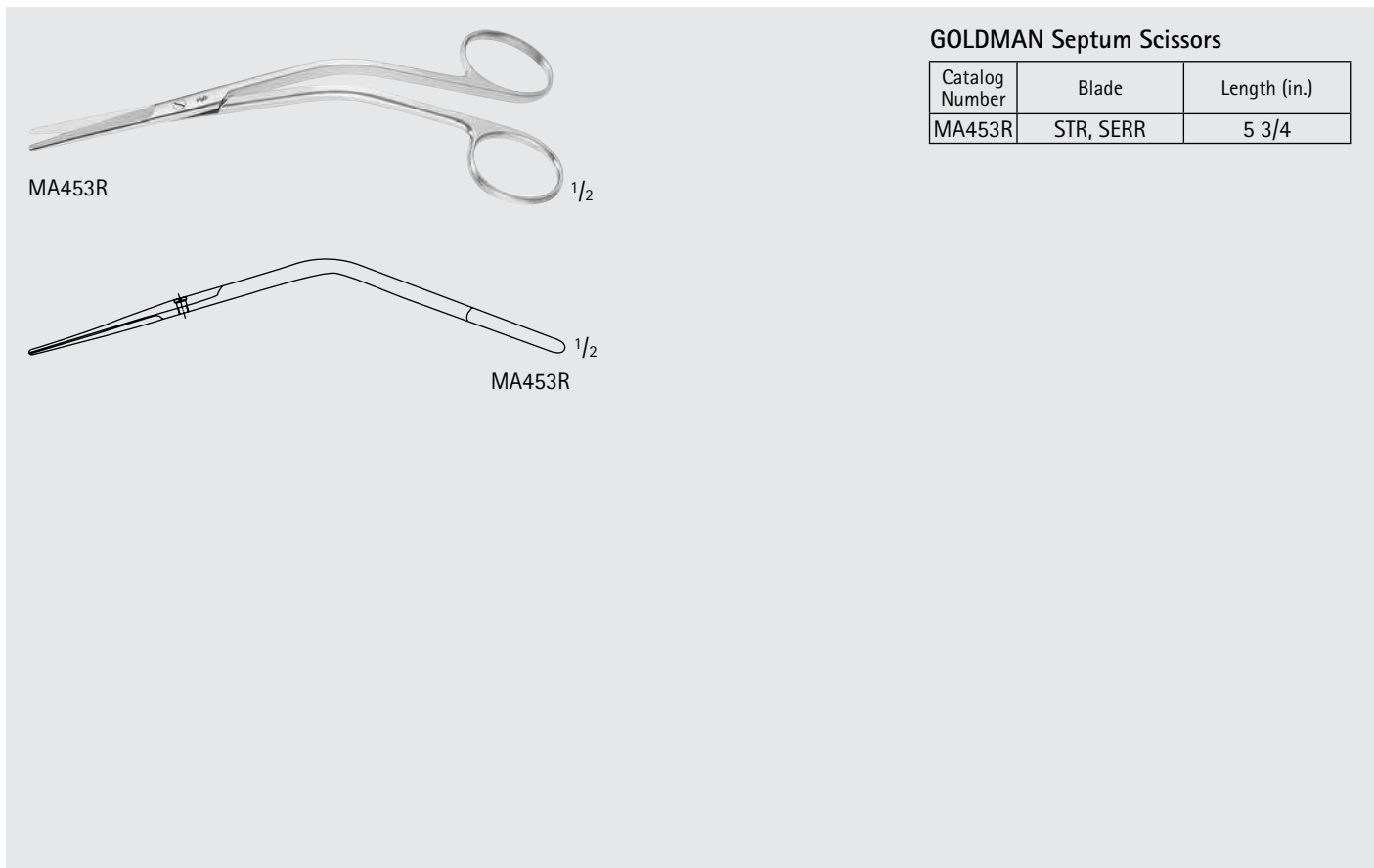
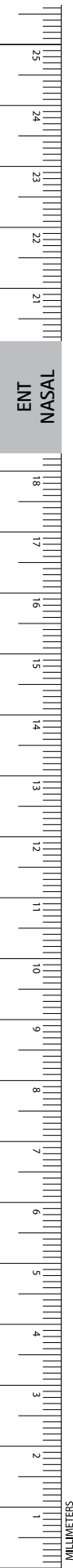

GOLDMAN Septum Scissors

Catalog Number	Blade	Length (in.)
MA453R	STR, SERR	5 3/4

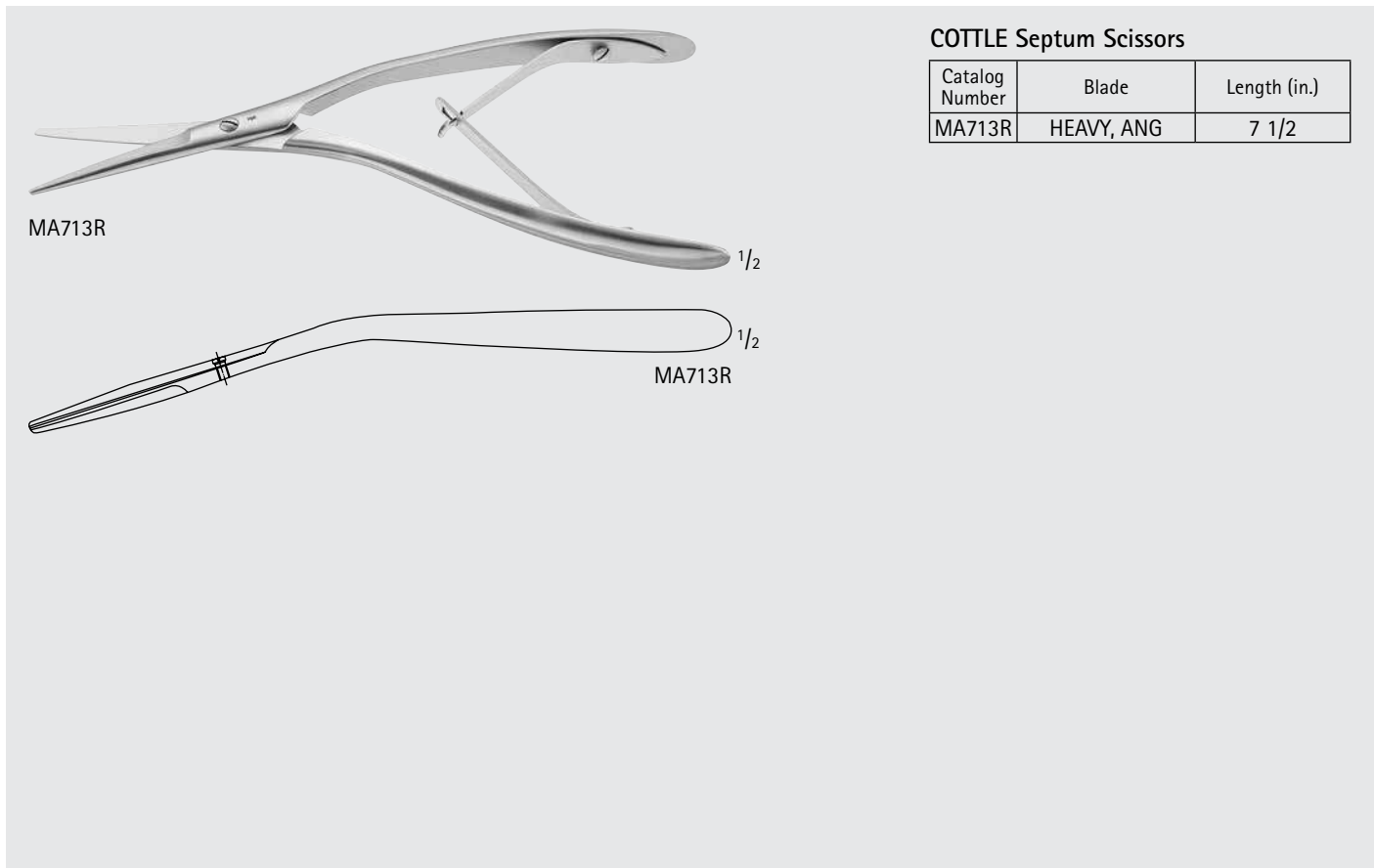

COTTLE Septum Scissors

Catalog Number	Blade	Length (in.)
MA713R	HEAVY, ANG	7 1/2

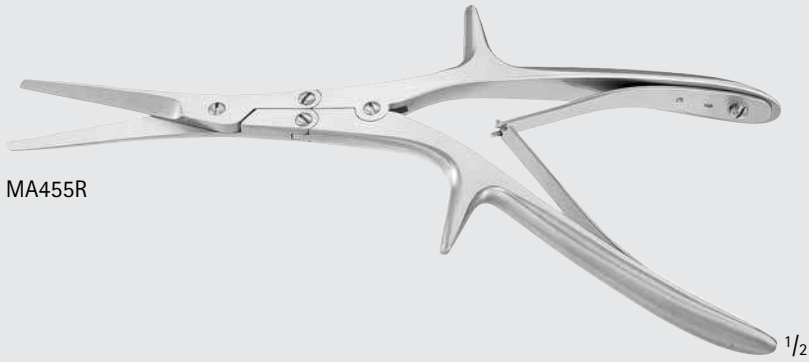

GORNEY Turbinate Scissors, Double Action

Catalog Number	Jaw	Length (in.)
MA455R	SERR	8

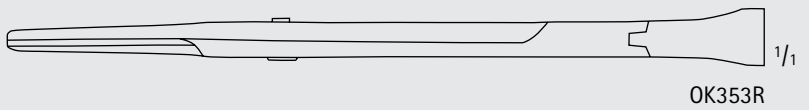
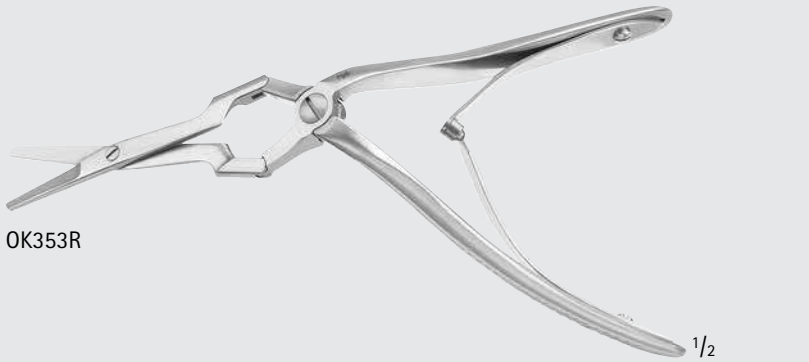

Becker Septum Scissors, Double Joint

Catalog Number	Blade	Length (in.)
OK353R	SERR	7

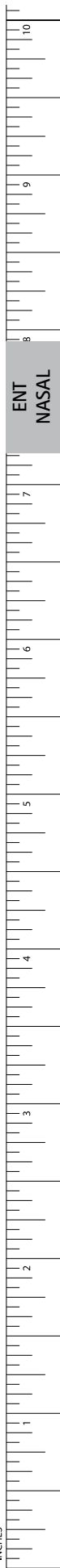

ENT-NASAL

Scissors

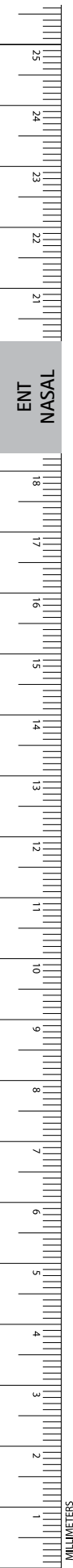
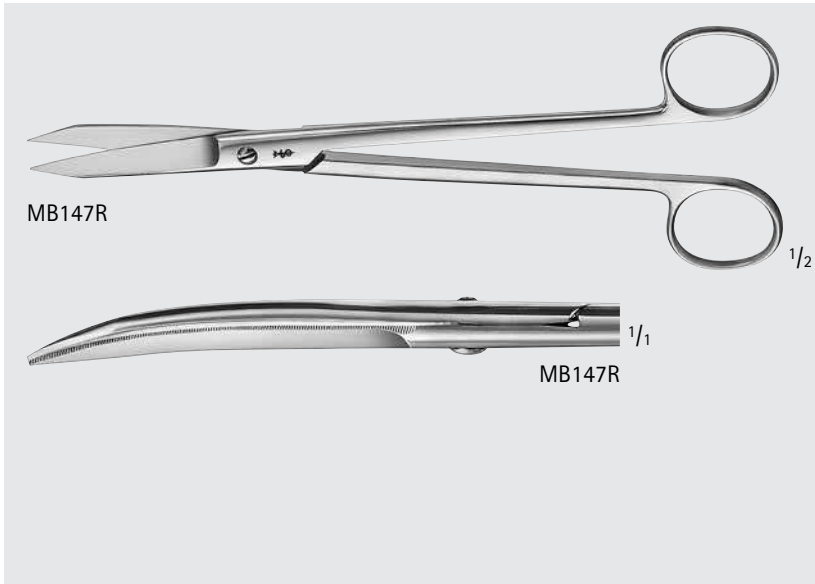
MARTIN Cartilage Scissors

Catalog Number	Blade	Length (in.)
MB147R	CVD, SERR	8

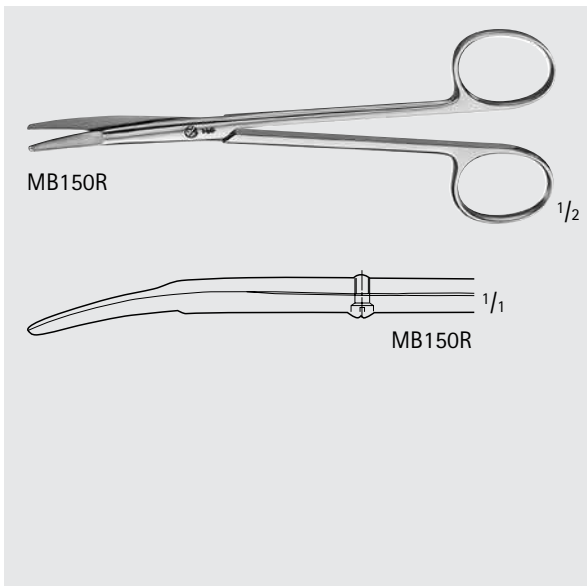

METZENBAUM-LIPSETT Scissors

Catalog Number	Tip	Blade	Length (in.)
MB150R	B/B	CVD	5 1/2

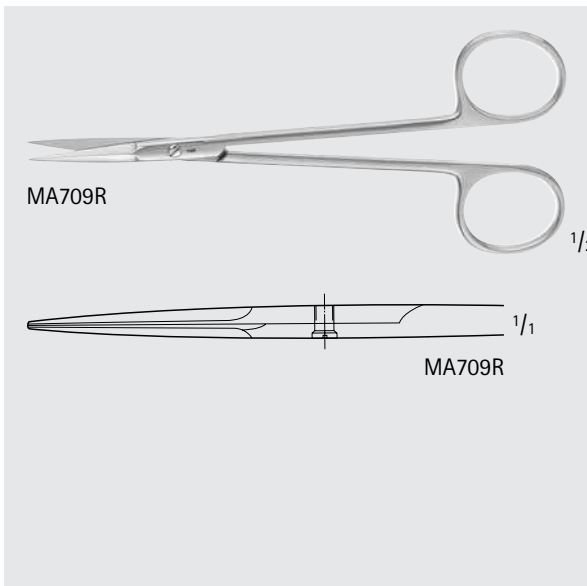

PECK-JOSEPH Scissors

Catalog Number	Blade	Tip Size (mm)	Length (in.)
MA709R	STR, SHARP	42	5 3/4

JOSEPH Scissors, Delicate

Catalog Number	Tip	Blade	Handle	Length (in.)
MB174R	S/S	STR, SERR	ROUND	5 1/2
MB175R	S/S	CVD, SERR	ROUND	5 1/2
BC156R	S/S	STR	ROUND	6
BC157R	S/S	CVD	ROUND	6
BC006R	S/S	STR	SQUARE	6
BC007R	S/S	CVD	SQUARE	6

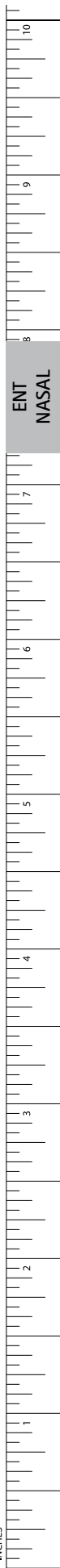
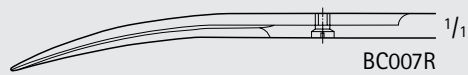
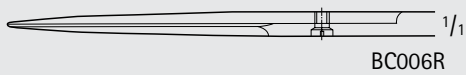
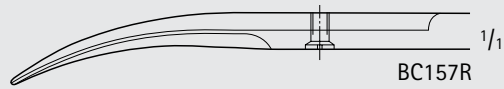
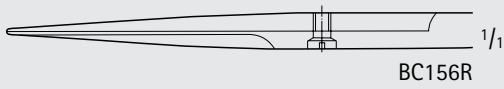
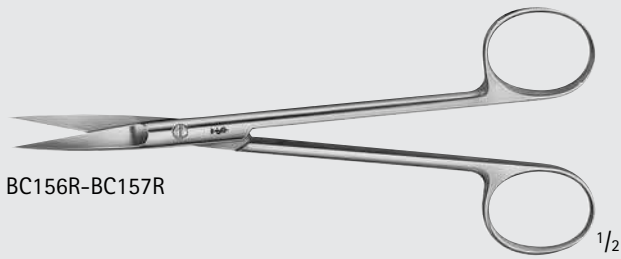
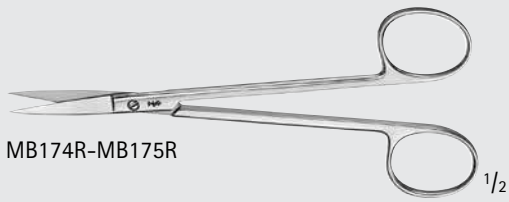

ENT-NASAL

Scissors

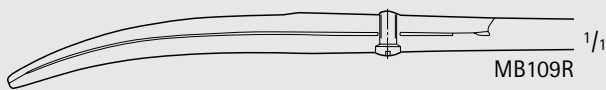
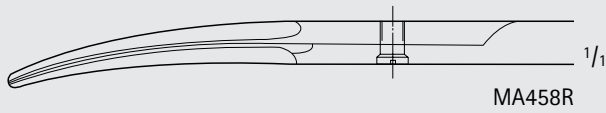
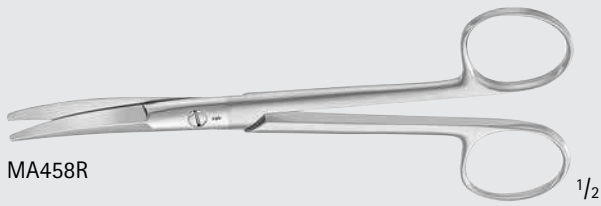

KAYE Facelift Scissors

Catalog Number	Tip	Blade	Length (in.)
MA458R	SEMI-SHARP	CVD, SERR	6
MB109R	SEMI-SHARP	CVD, SERR	7 1/2

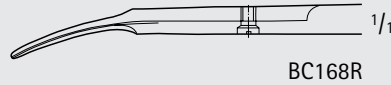
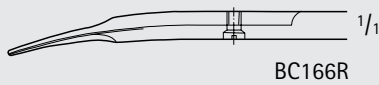
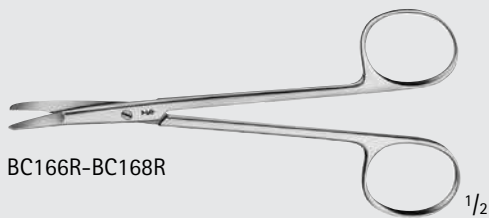

KILNER Scissors

Catalog Number	Tip	Blade	Length (in.)
BC166R	FLAT	CVD	5
BC168R	FLAT	CVD	6

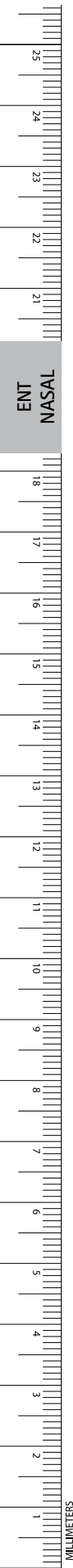

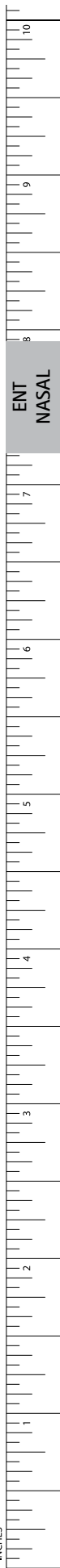

JAMESON Tenotomy Scissors, Delicate

Catalog Number	Tip	Blade	Length (in.)
BC177R	B/B	CVD	6

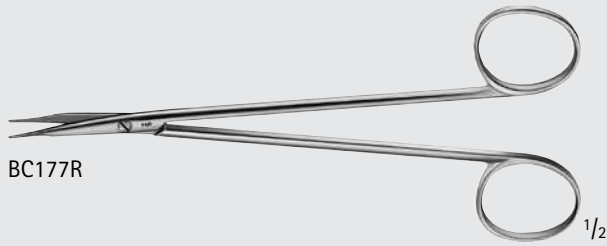

BC177R

1/2

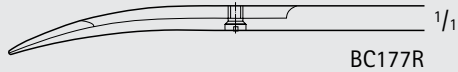

BC177R

1/1

REYNOLDS-JAMESON Tenotomy Scissors, Delicate

Catalog Number	Tip	Blade	Handle	Length (in.)
BC015R	B/B	CVD	SQUARE	5 1/2

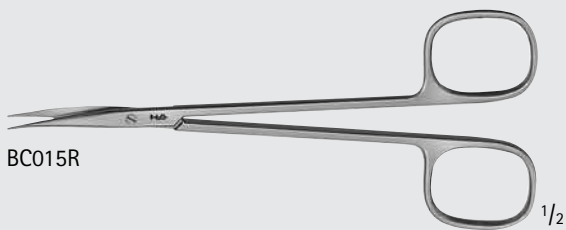

BC015R

1/2

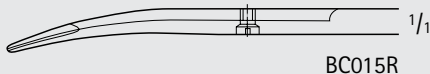

BC015R

1/1

REYNOLDS Tenotomy Scissors, Delicate

Catalog Number	Tip	Blade	Length (in.)
BC180R	B/B	CVD	5 3/4
BC181R	B/B	CVD	6 7/8

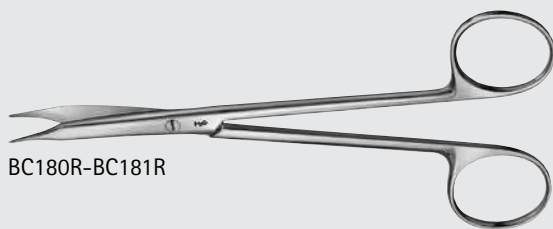

BC180R-BC181R

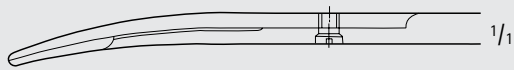

BC180R

1/1

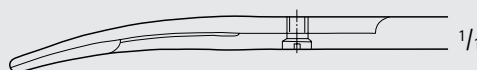

BC181R

1/1

ENT-NASAL

Scissors

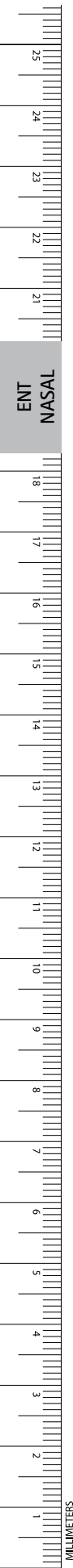
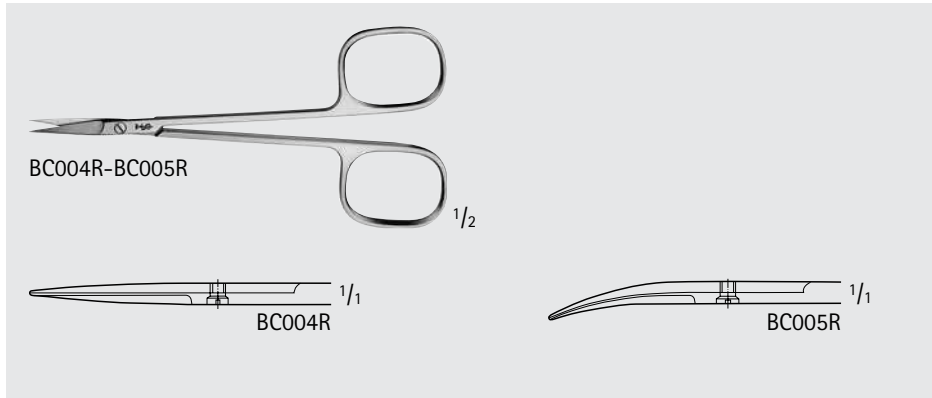



BC004R-BC005R $\frac{1}{2}$

BC004R $\frac{1}{1}$

BC005R $\frac{1}{1}$

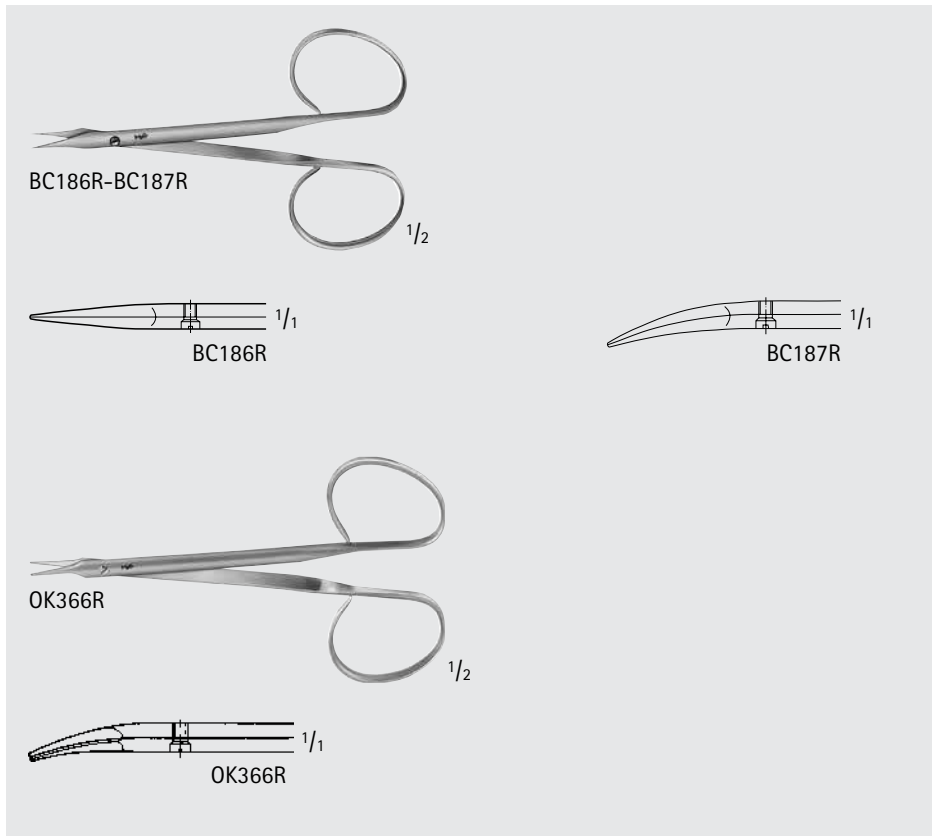
Catalog Number	Tip	Blade	Handle	Length (in.)
BC004R	S/S	STR	SQUARE	4 1/2
BC005R	S/S	CVD	SQUARE	4 1/2



BC186R-BC187R $\frac{1}{2}$

BC186R $\frac{1}{1}$

BC187R $\frac{1}{1}$

OK366R $\frac{1}{2}$

OK366R $\frac{1}{1}$

Catalog Number	Tip	Blade	Handle	Length (in.)
BC186R	S/S	STR	RIBBON	4
BC187R	S/S	CVD	RIBBON	4
OK366R	B/B	CVD	RIBBON	4 1/4

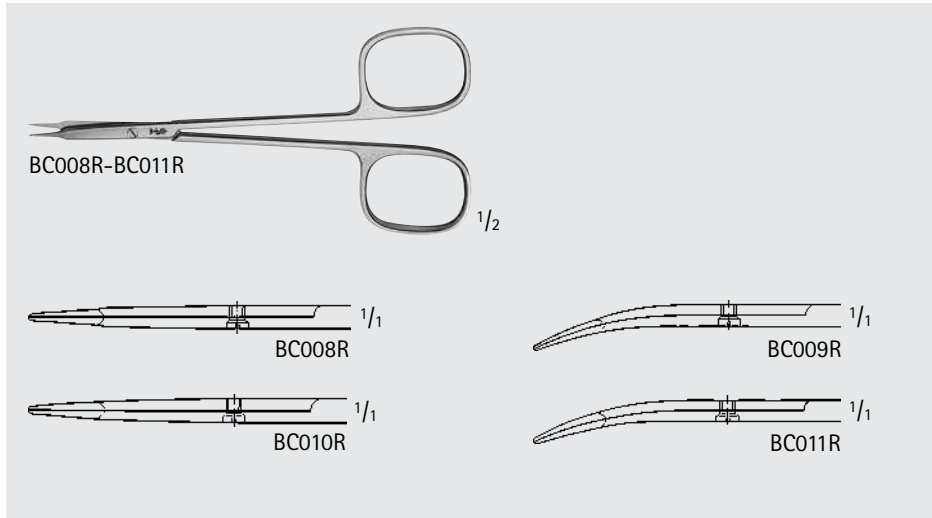

BC008R-BC011R $\frac{1}{2}$

BC008R $\frac{1}{1}$

BC009R $\frac{1}{1}$

BC010R $\frac{1}{1}$

BC011R $\frac{1}{1}$

Catalog Number	Tip	Blade	Handle	Length (in.)
BC008R	S/S	STR	SQUARE	4 1/2
BC010R	B/B	STR	SQUARE	4 1/2
BC009R	S/S	CVD	SQUARE	4 1/2
BC011R	B/B	CVD	SQUARE	4 1/2

STEVENS Tenotomy Scissors

Catalog Number	Tip	Blade	Handle	Length (in.)
BC170R	S/S	STR	ROUND	4 1/4
BC172R	B/B	STR	ROUND	4 1/4
BC194R	B/B	STR	ROUND	5
MA467R	B/B	STR	ROUND	5 3/4
BC171R	S/S	CVD	ROUND	4 1/4
BC173R	B/B	CVD	ROUND	4 1/4
BC195R	B/B	CVD	ROUND	5
MA466R	B/B	CVD	ROUND	5 3/4

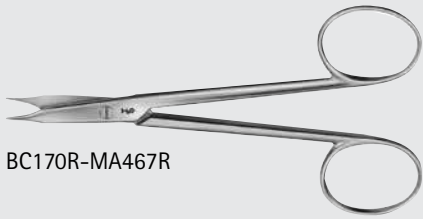

BC170R-MA467R

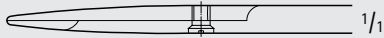

BC170R

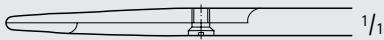

BC172R

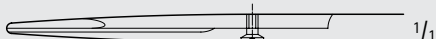

BC194R



MA467R

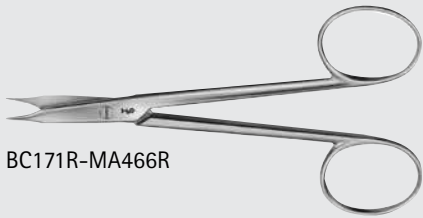

BC171R-MA466R



BC171R



BC173R

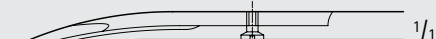

BC195R



MA466R

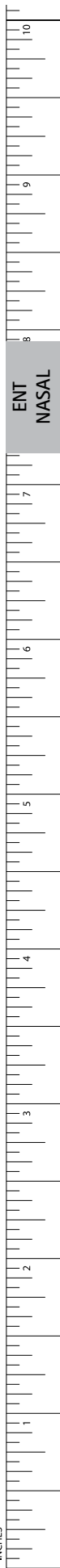

ENT-NASAL

Scissors

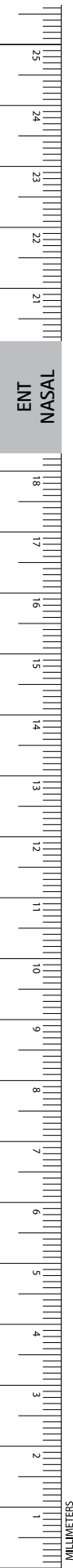

MA470R

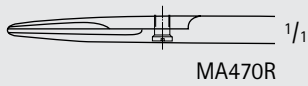

MA470R

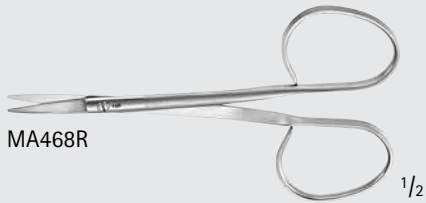

MA468R

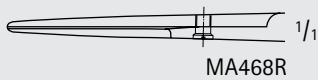

MA468R

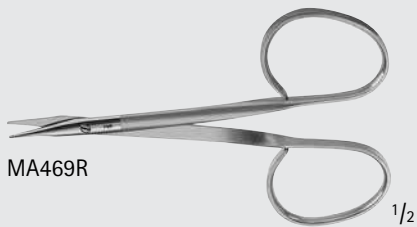

MA469R

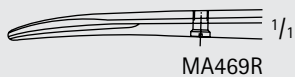

MA469R

STEVENS Tenotomy Scissors

Catalog Number	Tip	Blade	Handle	Weight	Length (in.)
MA470R	B/B	STR	RIBBON	LIGHT	3 3/4
MA468R	B/B	STR	RIBBON	HEAVY	3 7/8
MA469R	B/B	CVD	RIBBON	HEAVY	3 3/4

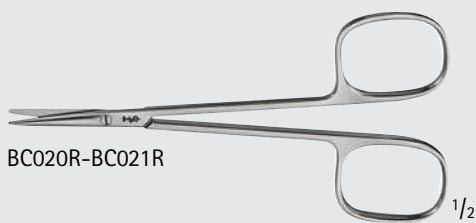

BC020R-BC021R

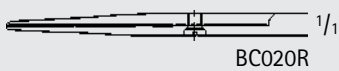

BC020R

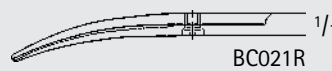

BC021R

Strabismus Scissors, Delicate

Catalog Number	Tip	Blade	Handle	Length (in.)
BC020R	B/B	STR	SQUARE	4 1/2
BC021R	B/B	CVD	SQUARE	4 1/2

DUROTIP Tungsten Carbide Scissors

- Excellent cutting accuracy
- Long working life
- Gold-plated rings

DUROTIP TC FOMON Dorsal Scissors

Catalog Number	Tip	Blade Angle	Length (in.)
MB540R	B/B	30°	5 1/4

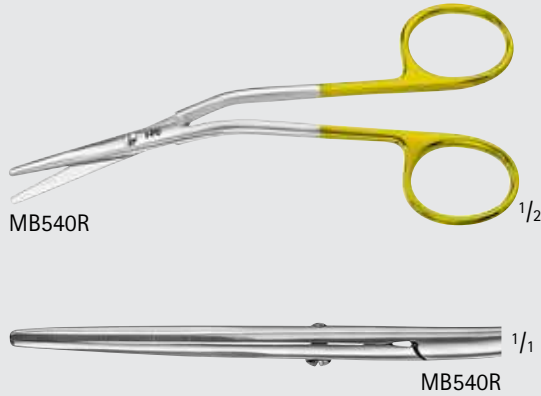

DUROTIP TC Iris Scissors, Delicate

Catalog Number	Tip	Blade	Length (in.)
BC210R	S/S	STR	4 1/4
BC211R	S/S	CVD	4 1/4

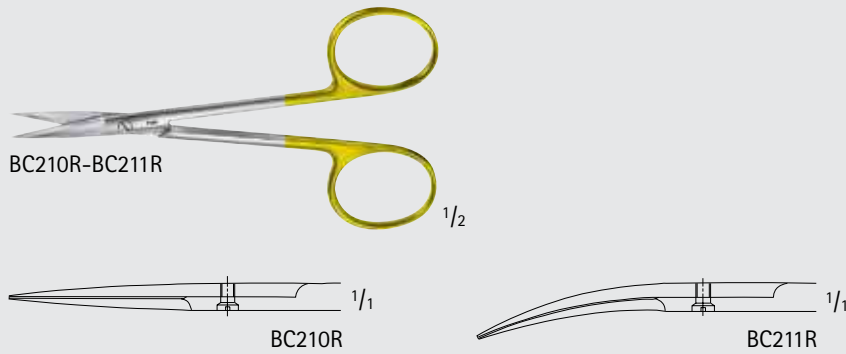

Wavecut

Wavecut scissors have one serrated cutting edge to prevent tissue from slipping. The W after the catalog number indicates the scissors are the wavecut style, e.g. BC211W.

DUROTIP TC Iris Scissors, Wavecut

Catalog Number	Tip	Blade	Length (in.)
BC211W	S/S	CVD	4 1/4

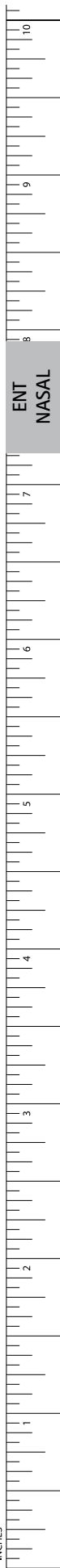
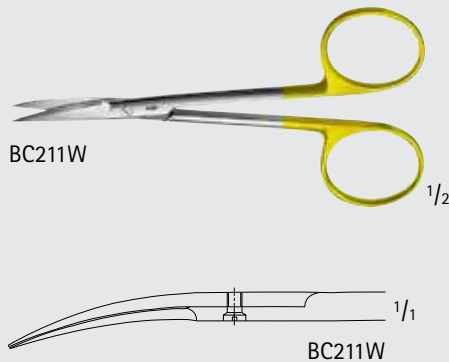

ENT-NASAL
DUROTIP™ TC Scissors

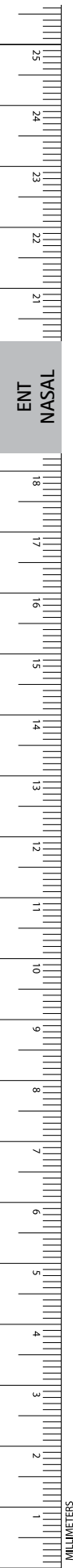
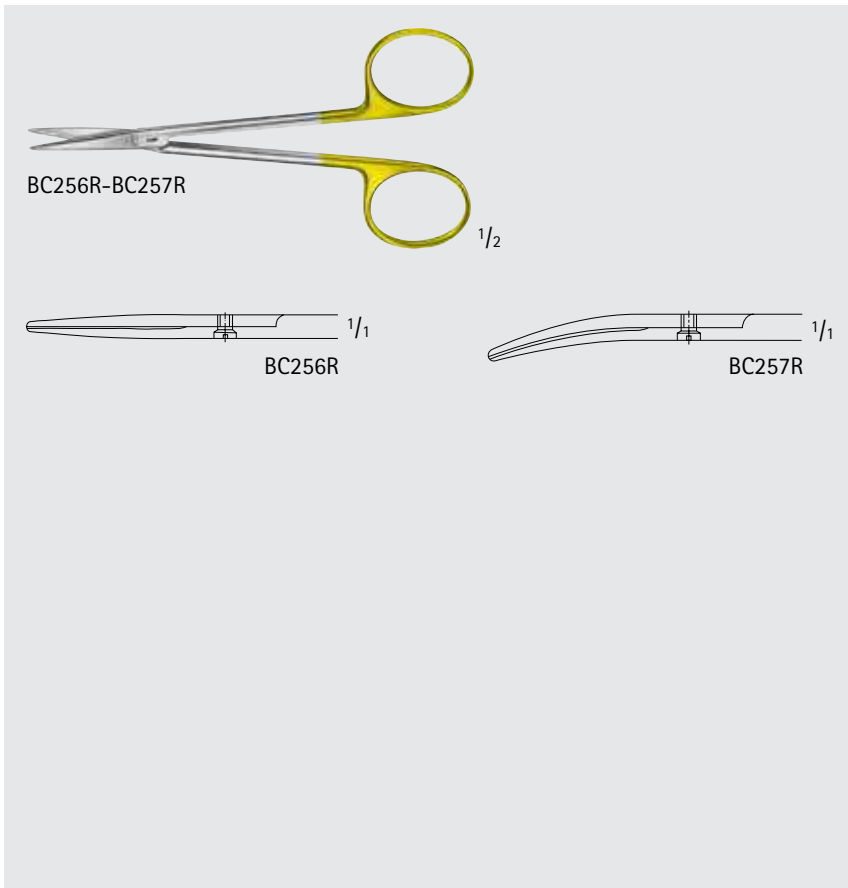
DUROTIP TC Strabismus Scissors, Delicate

Catalog Number	Tip	Blade	Length (in.)
BC256R	B/B	STR	4 1/2
BC257R	B/B	CVD	4 1/2

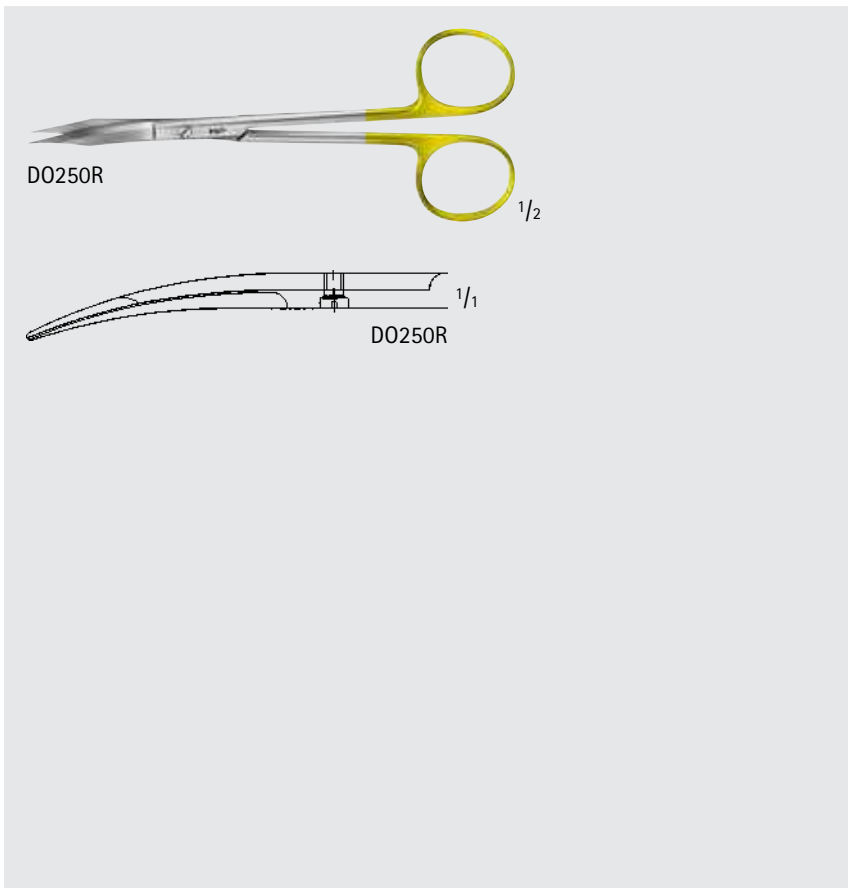

DUROTIP TC GOLDMAN-FOX Tenotomy Scissors, Delicate

Catalog Number	Tip	Blade	Length (in.)
D0250R	S/S	CVD, 1/SERR	5 1/8

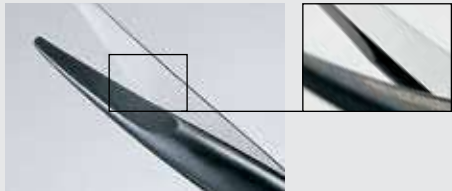

Microtome Edge

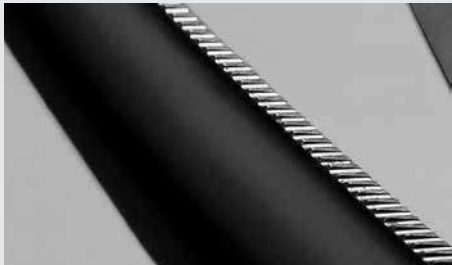

Wavecut

Noir Supreme Cut Scissors

- **Noir**
The combination of the renowned Aesculap Tungsten Carbide technology with the Aesculap Noir coating results in an extremely high surface hardness and therefore high wear resistance in daily hospital use.
- **Microtome edge**
The extremely sharp cutting edge of the scissors blade facilitates gentle cutting of tissue with minimal use of force.
- **Wavecut** helps prevent tissue from slipping out during the cutting process.
- The WB after the catalog number indicates the Noir scissors are the wavecut style, e.g. BC211WB.

For more information about Noir Supreme Cut Scissors see our brochure number DOC637.



Noir Baby METZENBAUM Dissecting Scissors

Catalog Number	Tip	Blade	Length (in.)
BC259B	B/B	CVD	5 3/4
BC259WB	B/B	CVD	5 3/4



Noir Strabismus Dissecting Scissors

Catalog Number	Tip	Blade	Length (in.)
BC257B	B/B	CVD	4 1/2
BC257WB	B/B	CVD	4 1/2

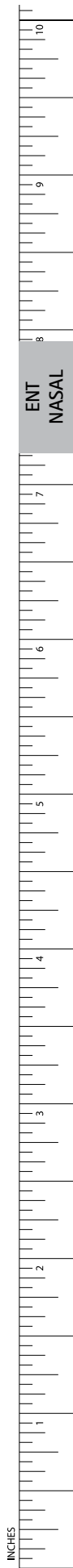

ENT-NASAL

SuperCut Scissors



BC904R, BC906R



BC904R

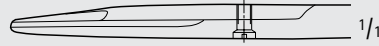

BC906R



BC905R, BC907R

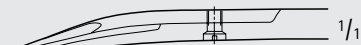

BC905R

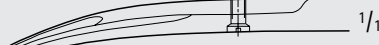

BC907R

STEVENS SuperCut Scissors

Catalog Number	Tip	Tip Size (mm)	Blade	Length (in.)
BC904R	B/B	12	STR	4 1/8
BC906R	B/B	13	STR	4 1/4
BC905R	B/B	12	CVD	4 1/8
BC907R	B/B	13	CVD	4 1/4



BC939R



BC939R

FOMON SuperCut Scissors

Catalog Number	Tip	Blade	Length (in.)
BC939R	B/B	CVD	4 1/2

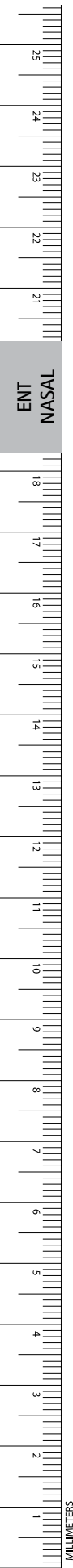

SF812R



Septum Needle W/ Luer Lock, Attachment

Catalog Number	Tip Size (mm)	Length (in.)
SF812R	DIAM. 0.8	3 1/2

MA553R, MA551R, MA552R



Antrum Trocar Needle

Catalog Number	Tip	Size	Length (in.)
MA553R	BEVELED STYLET	14 GA	4 1/4
MA551R	BEVELED STYLET	16 GA	4 1/4
MA552R	BEVELED STYLET	18 GA	4 1/4

MA553R, MA551R, MA552R



MA601R

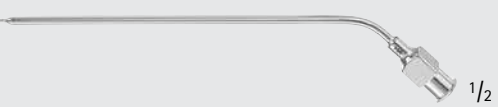

Septum Needle

Catalog Number	Tip	Size	Length (in.)
MA601R	ANG	22	5 3/8

MA554R



COAKLEY Antrum Trocar, with Irrigation Extension

Catalog Number	Length (in.)
MA554R	6 1/4

MA554R



ENT-NASAL

Trocars and Needles



Sinoscopy Trocar and Cannula

Catalog Number	Tip Size (mm)	Length (in.)
MA597R	4	6 1/2
MA598R	5	6 1/2

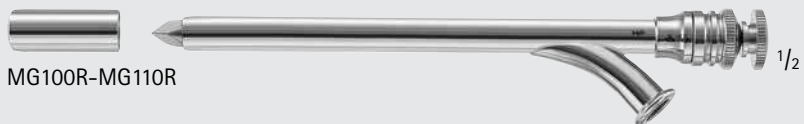

OCHSNER Trocar

Catalog Number	Tip Size (FR)	Length (in.)
MG100R	10	6
MG101R	12	6
MG102R	14	6
MG103R	16	6
MG104R	18	6
MG105R	20	6
MG106R	22	6
MG107R	24	6
MG108R	26	6
MG109R	27	6
MG110R	28	6

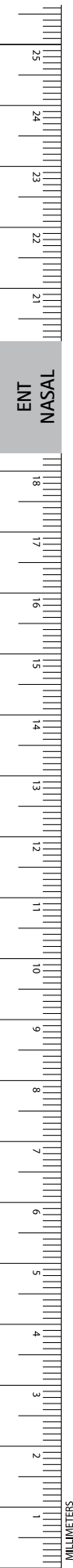

BROWN Needle Holder, Heavy

Catalog Number	Tip Size (mm)	Jaw	Length (in.)
MA362R	13	SERR	5 1/4

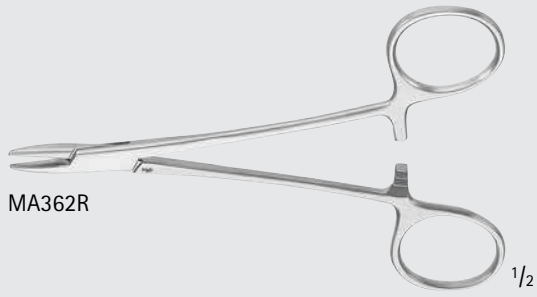

SOFFERMAN Needle Holder

Catalog Number	Tip Size (mm)	Jaw	Working Length (in.)
MA627R	5	STR, SERR	3 5/8

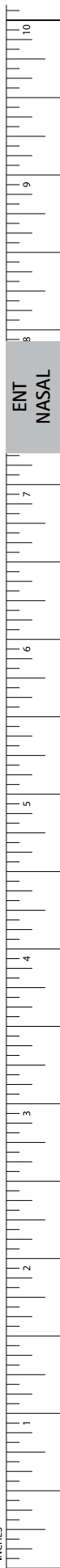

ENT-NASAL

Forceps- Tissue/Dressing/Sponge



MA537R

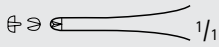

MA537R

CALLISON-ADSON Tissue Forceps, W/ Platform

Catalog Number	Teeth	Length (in.)
MA537R	1 x 2	5



MA070R



BD879R-BD878R

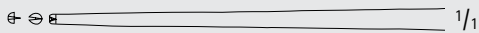

BD879R

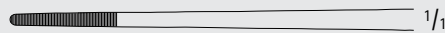

BD878R



MA331R



MA331R



MA070R

LUCAE Bayonet Forceps

Catalog Number	Tip	Teeth	Length (in.)
BD879R	SMOOTH	1 x 2	5 1/2
BD878R	SERR	-	5 1/2
MA331R	SERR	-	6 3/8
MA070R	DEL, SERR	-	5 3/4



BD880R, MB236

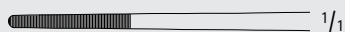

BD880R



MB236

JANSEN Bayonet Forceps

Catalog Number	Tip	Length (in.)
BD880R	SERR	6 1/4
MB236	SERR	6 1/2

ENT
NASAL

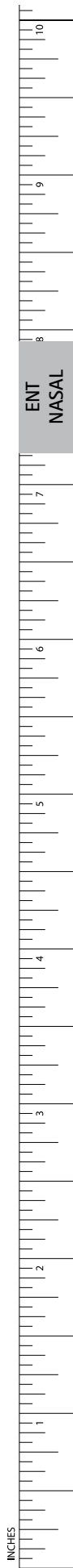

GRUENWALD Bayonet Forceps

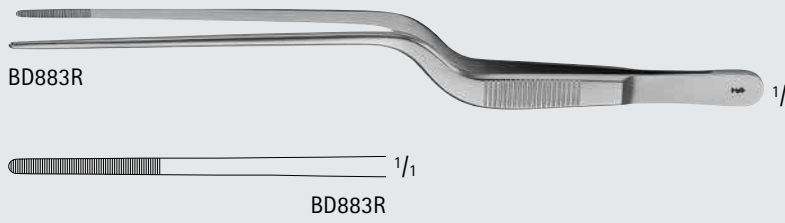

Catalog Number	Tip	Length (in.)
BD883R	SERR	7 7/8

JACOBSON Forceps

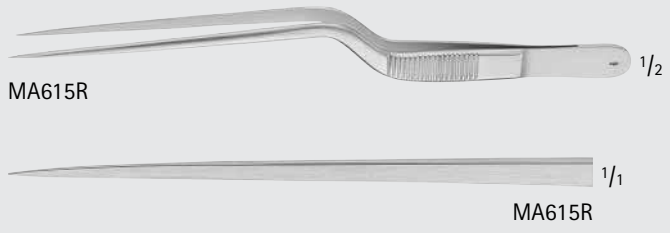

Catalog Number	Tip	Length (in.)
MA615R	SMOOTH, SHARP	6 1/4

Bayonet Forceps

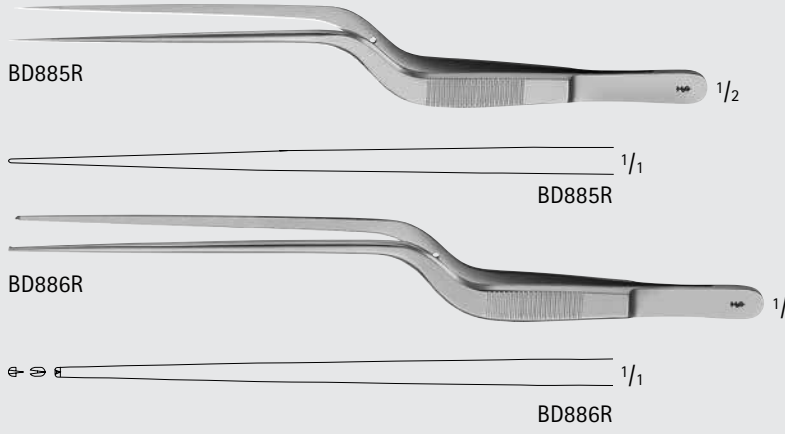

Catalog Number	Tip	Teeth	Length (in.)
BD885R	SMOOTH	-	7 1/4
BD886R	SMOOTH	1 x 2	7 7/8

BROWN-BAHNSON Bayonet Forceps

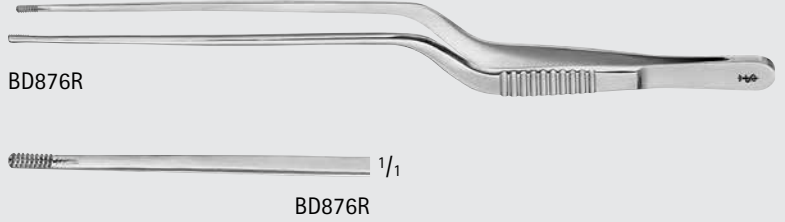

Catalog Number	Tip	Length (in.)
BD876R	SERR	6 1/8

ADSON Bayonet Forceps

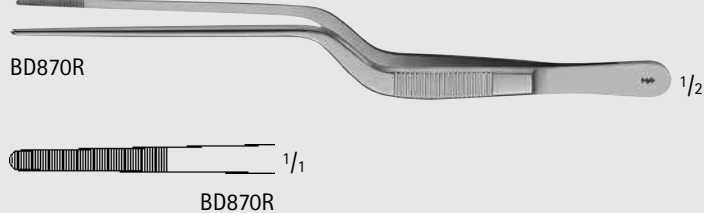

Catalog Number	Tip	Length (in.)
BD870R	SERR	6 7/8

ENT-NASAL

Forceps- Tissue/Dressing/Sponge

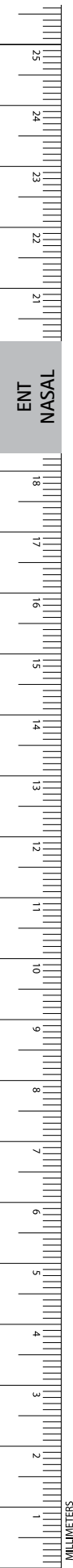

BD904R 1/1
BD904R

WILDE Forceps

Catalog Number	Tip	Length (in.)
BD904R	ANG/SERR	4 1/2



BD900R-BD902R

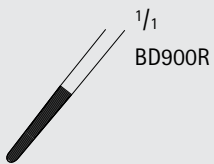

1/1
BD900R

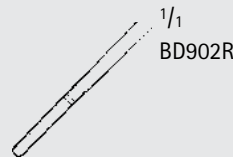

1/1
BD902R

TROELTSCH Bayonet Forceps

Catalog Number	Tip	Length (in.)
BD900R	ANG/SERR	4
BD902R	ANG/SERR	4 1/2
BD910R	ANG/SERR	5 1/2
BD911R	ANG/SERR	6 3/4



BD910R-BD911R

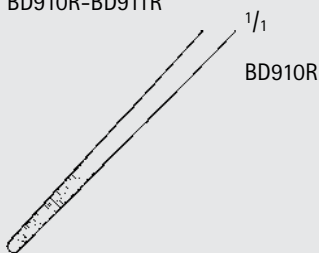

1/1
BD910R

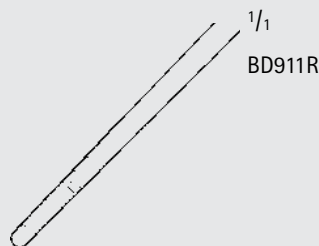

1/1
BD911R

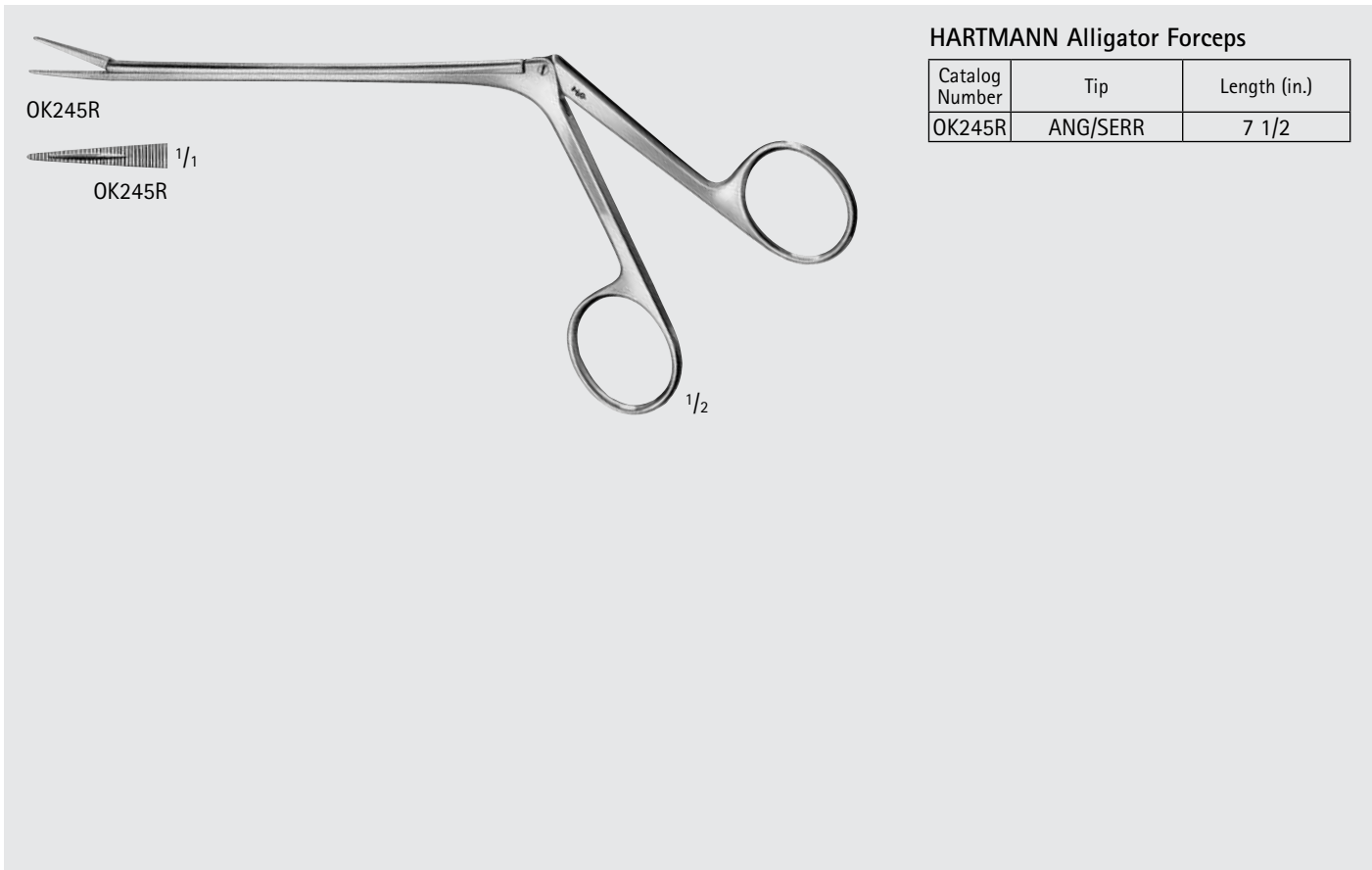

HARTMANN Alligator Forceps

Catalog Number	Tip	Length (in.)
OK245R	ANG/SERR	7 1/2

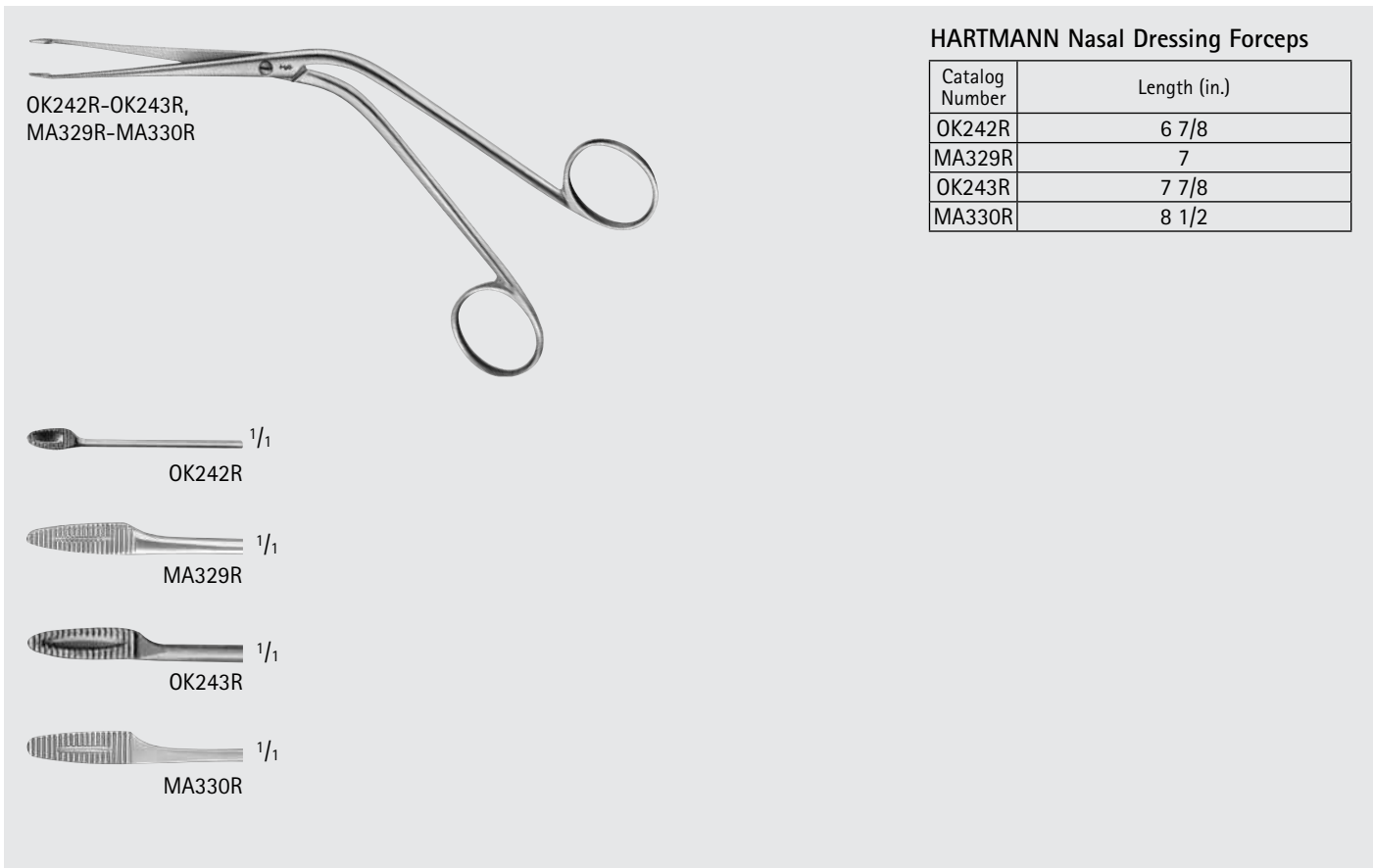

HARTMANN Nasal Dressing Forceps

Catalog Number	Length (in.)
OK242R	6 7/8
MA329R	7
OK243R	7 7/8
MA330R	8 1/2



ENT-NASAL

Forceps- Tissue/Dressing/Sponge

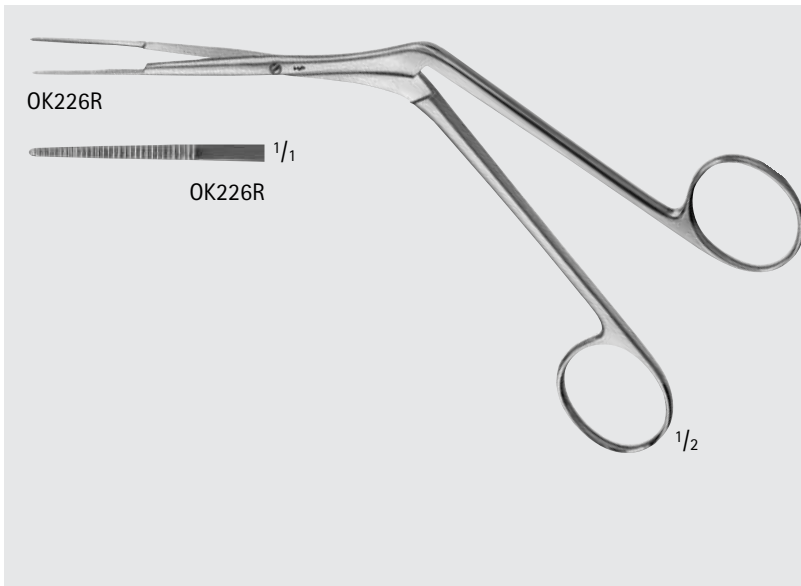
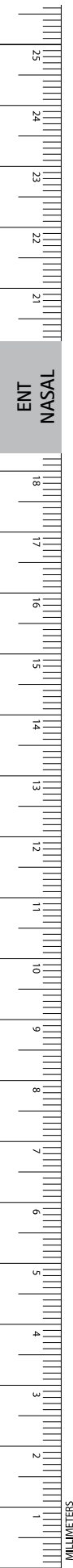

WEST Nasal Dressing Forceps

Catalog Number	Tip	Length (in.)
OK226R	SERR	7 7/8

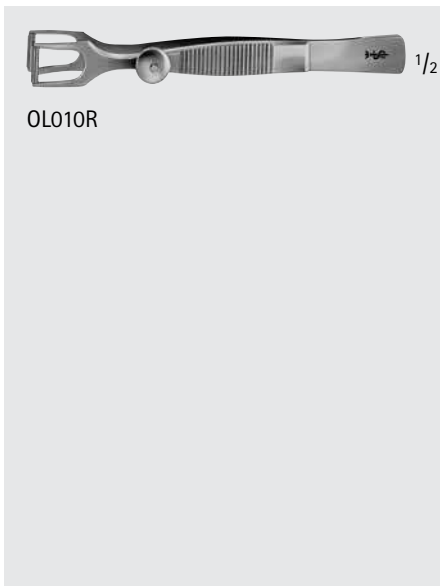

COTTLE Columella Clamp, W/ Fixation Screw

Catalog Number	Length (in.)
OL010R	4

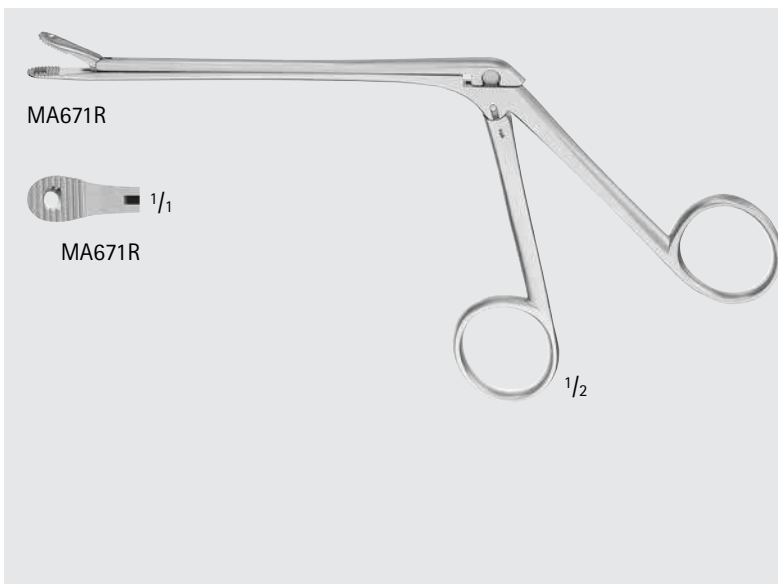

FERRIS-SMITH Fragment Forceps

Catalog Number	Tip Size (mm)	Working Length (in.)	Length (in.)
MA671R	8.2 x 6	4 1/4	7 7/8

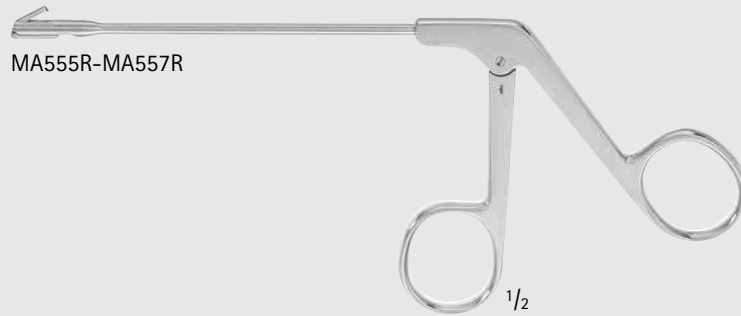

OSTRUM Antrum Backbiting Punch Forceps

Catalog Number	Jaw Size (mm)	Jaw	Working Length (in.)	Length (in.)
MA555R	3 x 7	STR	4 1/4	7 3/4
MA556R	3 x 7	ANG-LEFT	4 1/4	7 3/4
MA557R	3 x 7	ANG-RIGHT	4 1/4	7 3/4



BRUENINGS Septum Forceps

Catalog Number	Size	Length (in.)
OK440R	SMALL	7 1/2
OK441R	MEDIUM	7 1/2
OK442R	LARGE	7 1/2
OK443R	X-LARGE	7 1/2

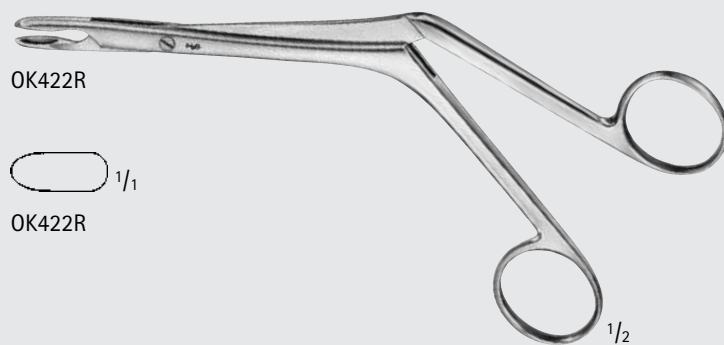
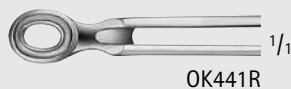

HEYMANN-KNIGHT Septum Forceps

Catalog Number	Jaw	Length (in.)
OK422R	OVAL	7 1/2

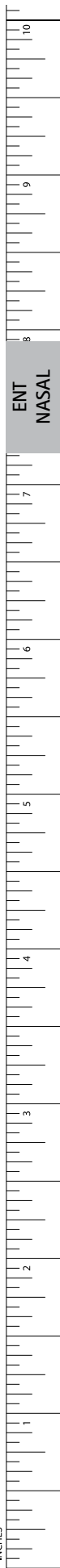
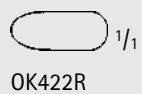

ENT-NASAL

Forceps- Nasal/Polyp/Bone Cutting

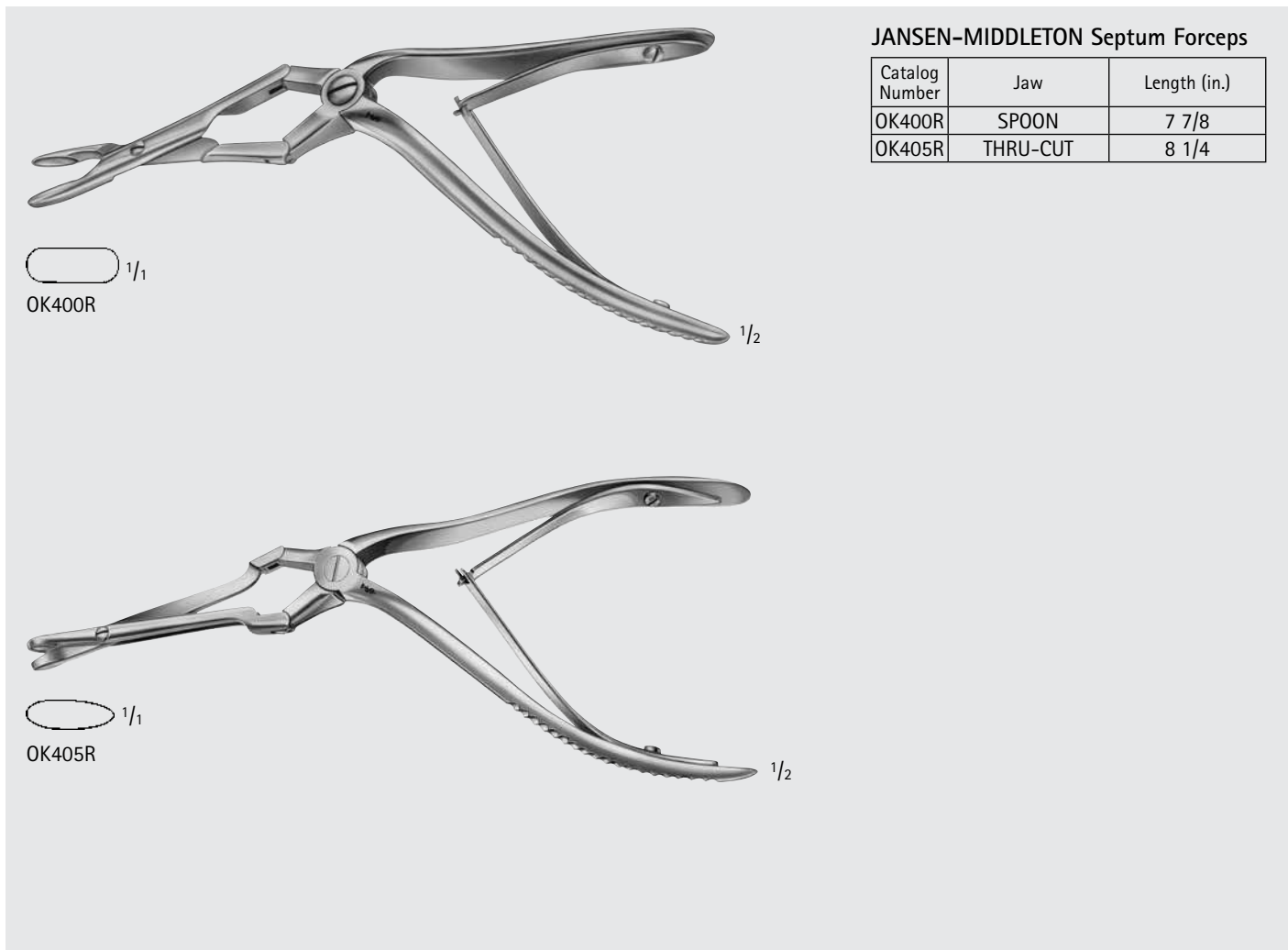
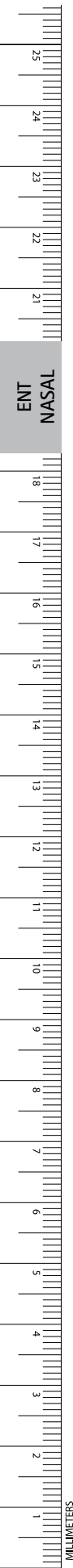

JANSEN-MIDDLETON Septum Forceps

Catalog Number	Jaw	Length (in.)
OK400R	SPOON	7 7/8
OK405R	THRU-CUT	8 1/4

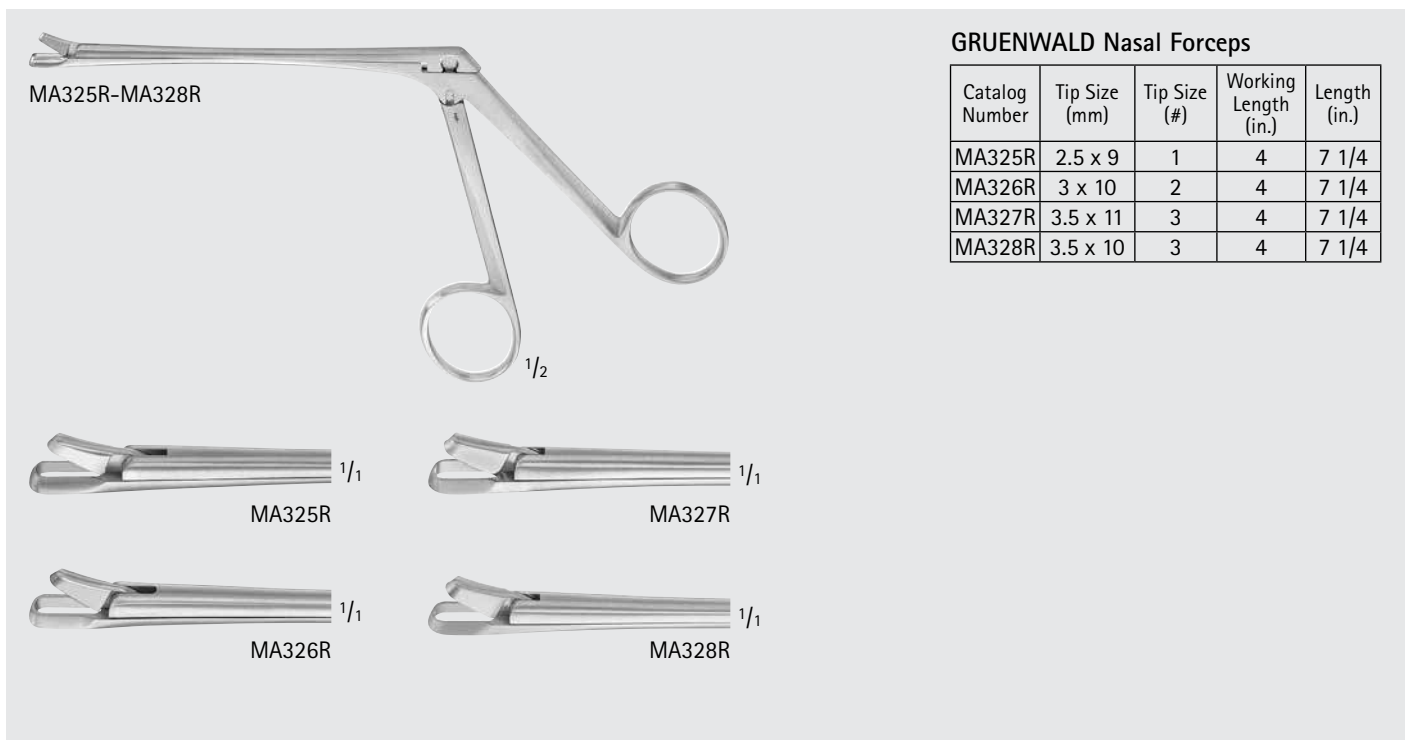

GRUENWALD Nasal Forceps

Catalog Number	Tip Size (mm)	Tip Size (#)	Working Length (in.)	Length (in.)
MA325R	2.5 x 9	1	4	7 1/4
MA326R	3 x 10	2	4	7 1/4
MA327R	3.5 x 11	3	4	7 1/4
MA328R	3.5 x 10	3	4	7 1/4

GRUENWALD-HENKE Nasal Thru-Cut Rongeur

Catalog Number	Jaw	Working Length (in.)
OK612R	SMALL	4 3/4
OK613R	LARGE	4 3/4

OK612R-OK613R

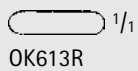
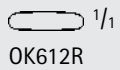

STAMMBERGER Circular Punch Forceps

Catalog Number	Tip	Tip Size (mm)	Working Length (in.)	Length (in.)
MA673R	STR	3.5	7 1/2	9 3/4
MA672R	STR	4.5	7 1/2	9 3/4
MA674R	70° UP	3.5	7 1/4	9 5/8
MA675R	70° UP	4.5	7 1/4	10 1/4

MA673R, MA672R, MA674R, MA675R

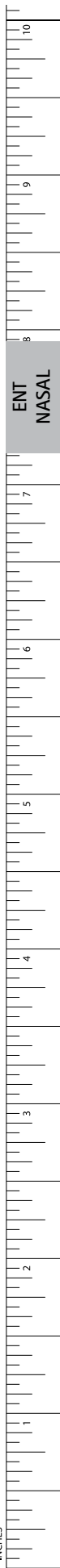
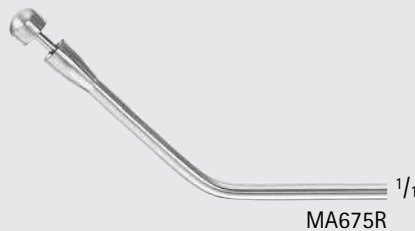
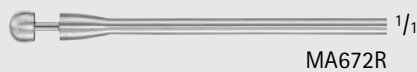
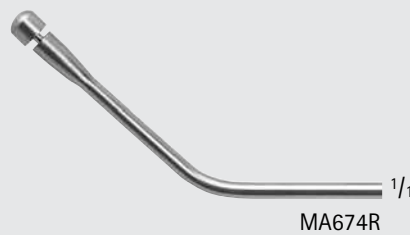
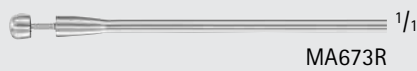
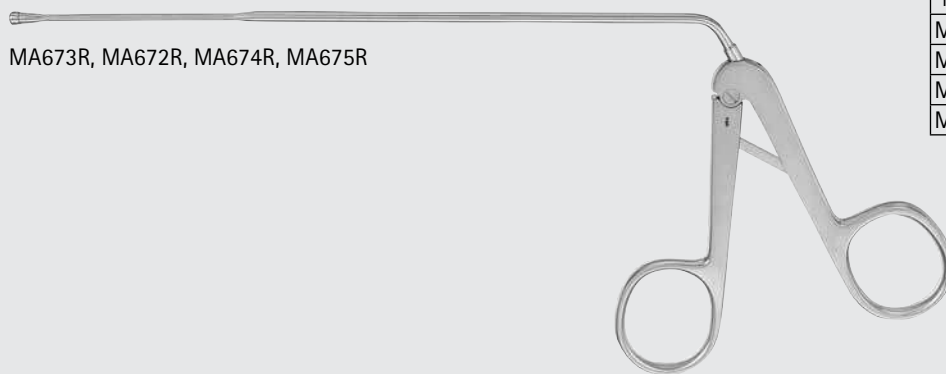

ENT-NASAL

Forceps- Nasal/Polyp/Bone Cutting

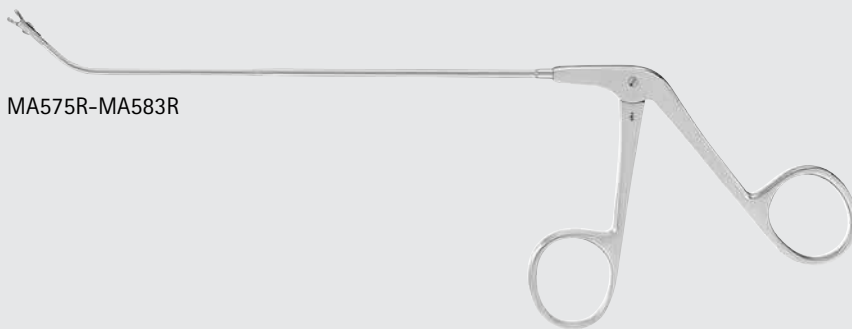
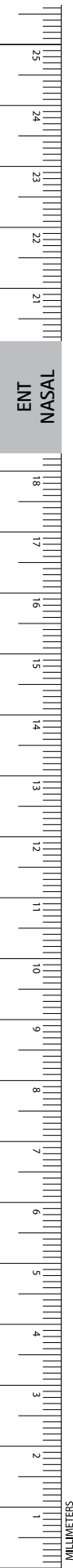

MA575R-MA583R



MA575R, MA577R



MA576R, MA580R

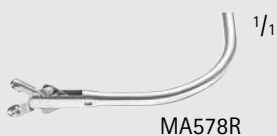

MA578R



MA579R



MA582R



MA581R, MA583R

Giraffe Frontal Sinus Forceps

Catalog Number	Jaw	Cup Size (mm)	Working Length (in.)	Length (in.)
MA575R	ANG 45° VERTICAL CUTTING	2	5 1/2	8 7/8
MA576R	ANG 45° HORIZONTAL CUTTING	2	5 1/2	8 7/8
MA577R	ANG 90° VERTICAL CUTTING	2	5 1/8	8 3/8
MA578R	ANG 90° HORIZONTAL CUTTING	2	5 1/8	8 3/8
MA579R	ANG 45° VERTICAL CUTTING	3	5 1/2	8 7/8
MA581R	ANG 70° VERTICAL CUTTING DOUBLE ACTION	3	5 1/8	8 1/4
MA580R	ANG 90° HORIZONTAL CUTTING	3	5 1/2	8 7/8
MA582R	ANG 70° HORIZONTAL CUTTING DOUBLE ACTION	4	5 1/8	8 1/4
MA583R	ANG 100° HORIZONTAL CUTTING DOUBLE ACTION	4	4 5/8	8 1/4

Giraffe Thru-Cut Sinus Forceps

Catalog Number	Jaw	Cup Size (mm)	Working Length (in.)
MA584R	ANG 70° VERTICAL CUTTING	3 x 6	4 3/4

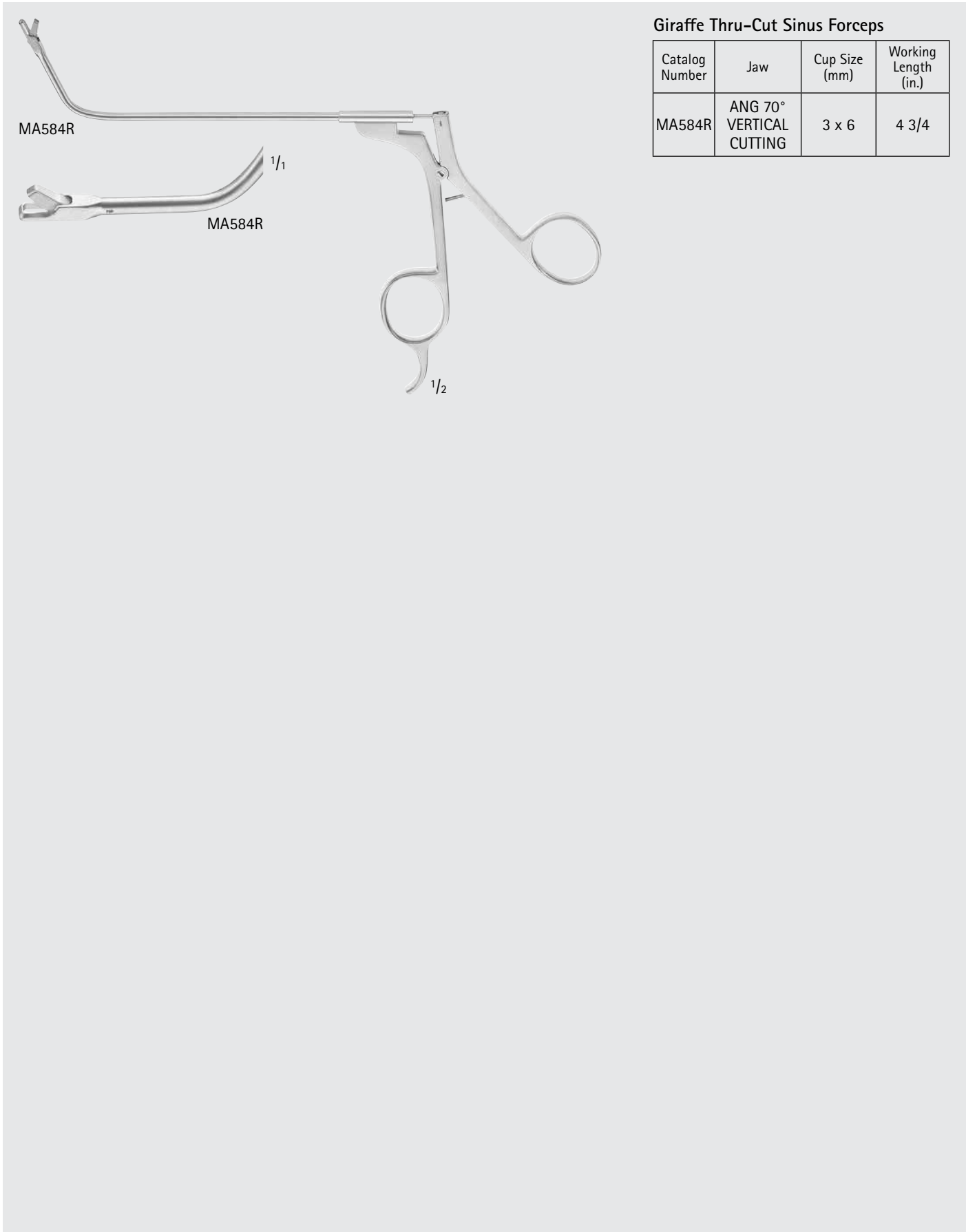

ENT-NASAL

Forceps- Nasal/Polyp/Bone Cutting

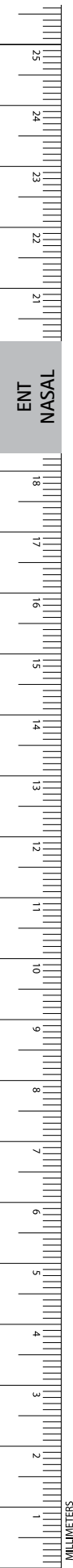

MA585R-MA559R

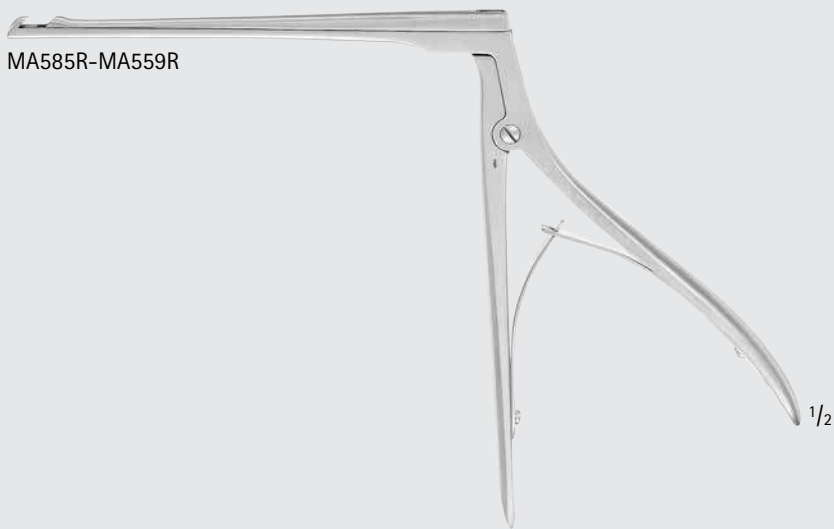

MA585R



MA559R

Antrum Punch Forceps

Catalog Number	Jaw	Tip	Cup Size (mm)	Working Length (in.)	Length (in.)
MA585R	ANG 45° BACKWARD 3 MM	3	4 x 5	5 1/2	8 1/4
MA559R	45° FORWARD 3 MM	3	4 x 5	5 1/2	8 1/4

MA415R

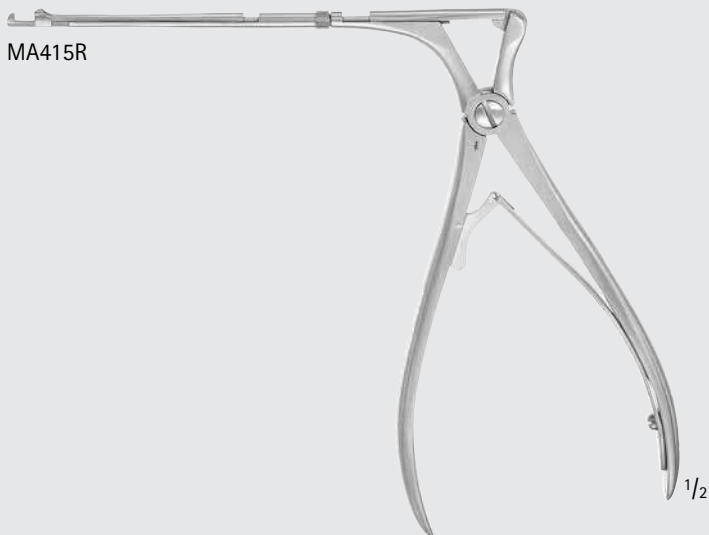

MA415R

MCKENTY Sphenoid Punch Forceps, Rotatable

Catalog Number	Jaw	Working Length (in.)	Length (in.)
MA415R	1.5 x 4	5 3/4	7

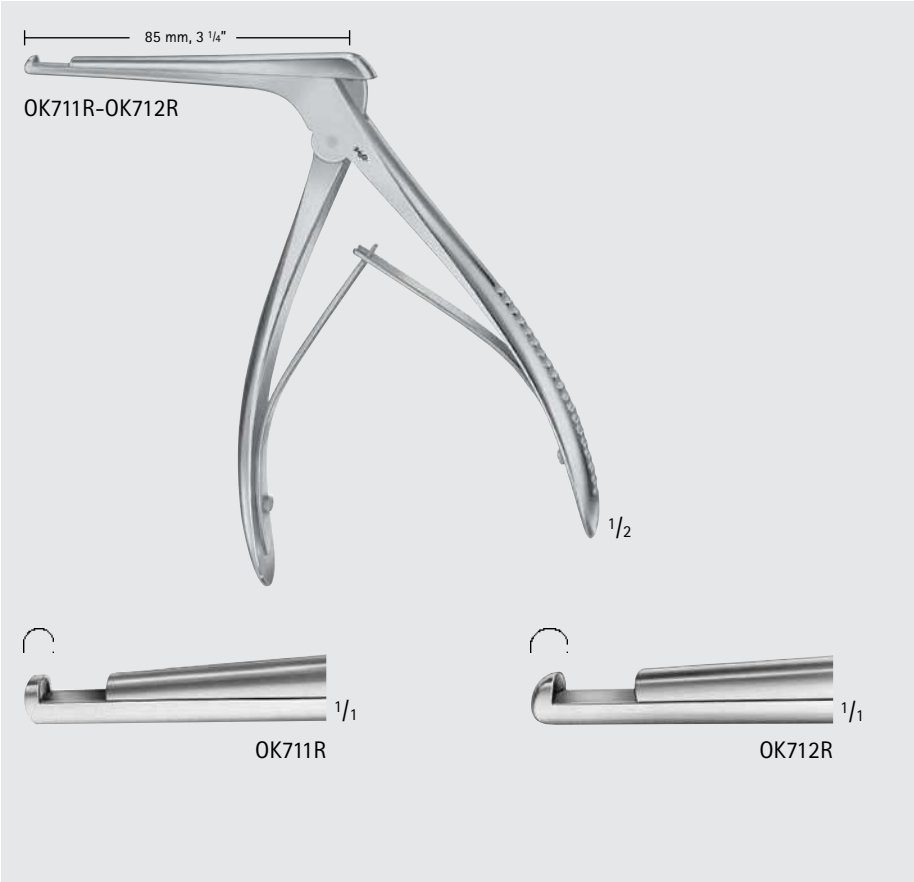

KERRISON Nasal Rongeur

Catalog Number	Jaw Size (mm)	Jaw	Working Length (in.)
OK711R	4.0	90° UP	3 1/4
OK712R	5.0	90° UP	3 3/8

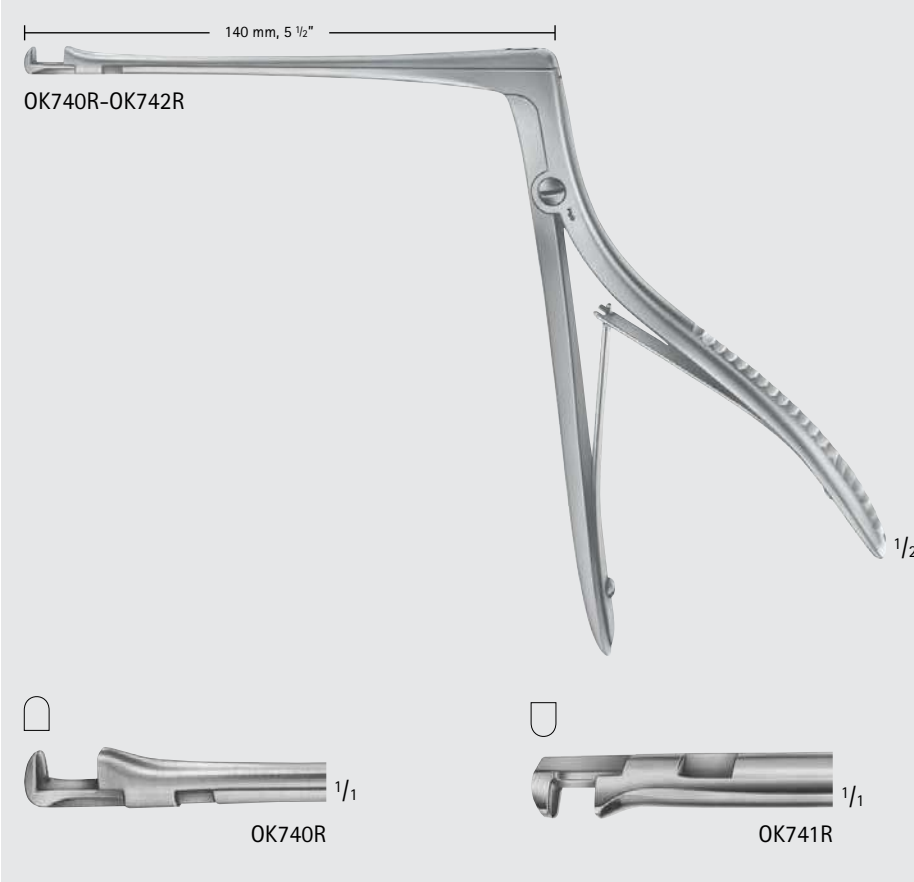

HAJEK-KOFLER Punch

Catalog Number	Jaw Size (mm)	Jaw	Working Length (in.)
OK740R	3.3	90° UP	5 1/2
OK741R	3.3	90° DOWN	5 1/2
OK742R	4.0	90° UP	5 1/2

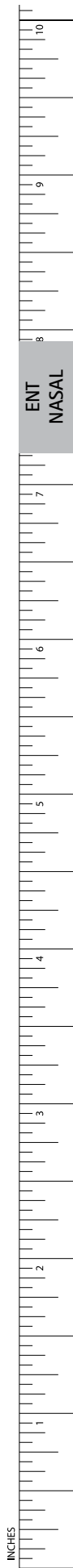

ENT-NASAL

Forceps- Nasal/Polyp/Bone Cutting

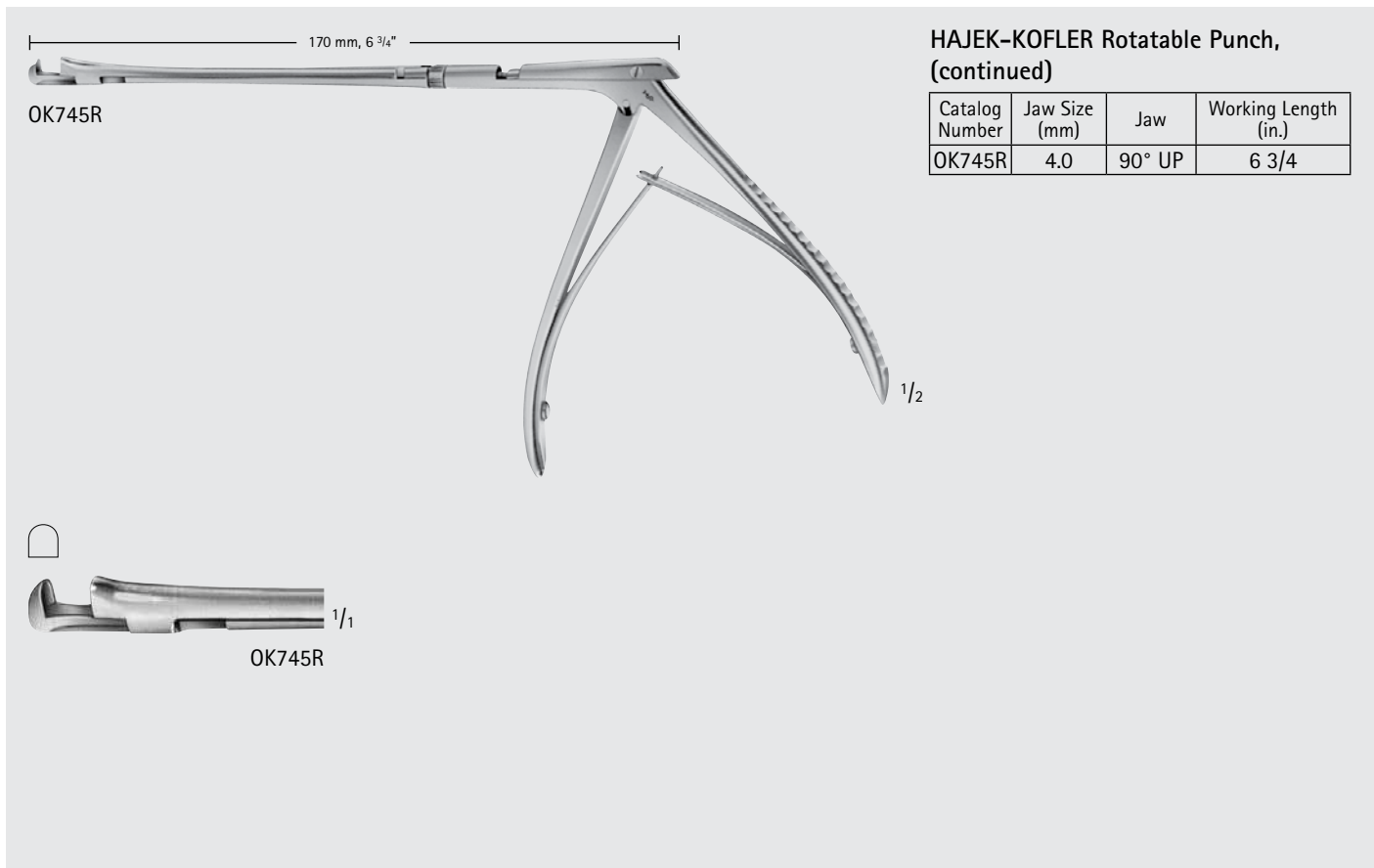
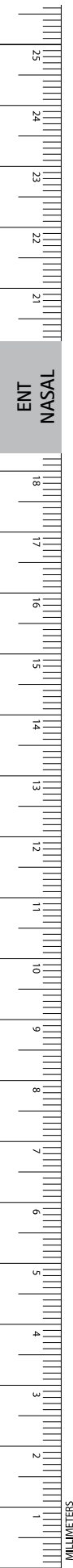

HAJEK-KOFLER Rotatable Punch, (continued)

Catalog Number	Jaw Size (mm)	Jaw	Working Length (in.)
OK745R	4.0	90° UP	6 3/4

OK745R

170 mm, 6 3/4"

1/2

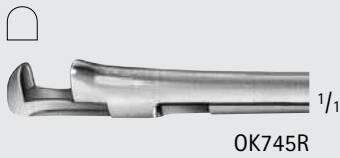

OK745R

1/1

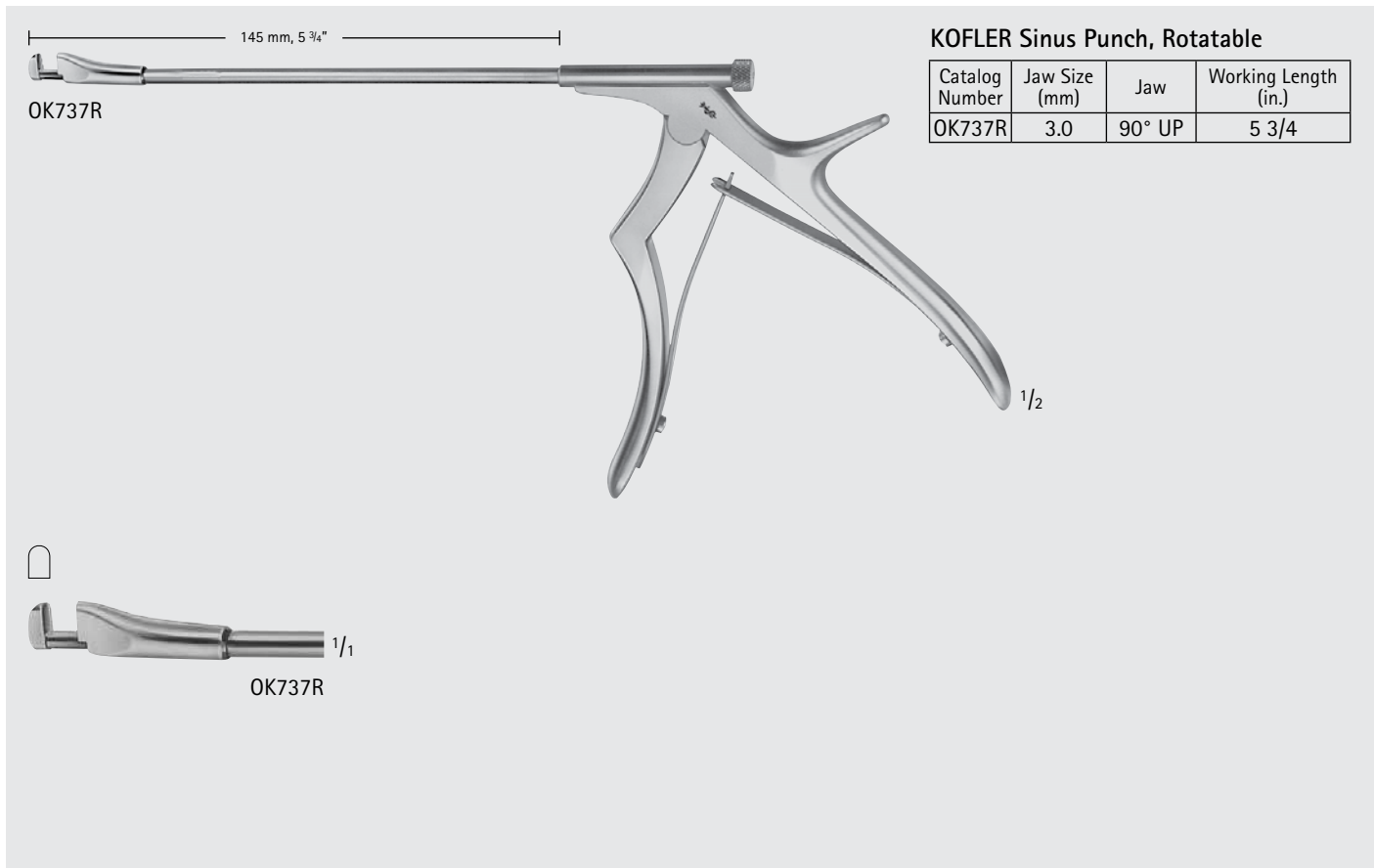

KOFLER Sinus Punch, Rotatable

Catalog Number	Jaw Size (mm)	Jaw	Working Length (in.)
OK737R	3.0	90° UP	5 3/4

OK737R

145 mm, 5 3/4"

1/2



OK737R

1/1



MA340R-MA343R, OK525R-OK526R

TAKAHASHI Nasal Forceps

Catalog Number	Jaw Size (mm)	Jaw	Working Length (in.)
MA342R	2.5	STR	4 3/8
OK525R	3.0	STR	4 3/4
MA340R	3.0	STR	6 3/8
MA343R	4.0	STR	4 3/8
MA341R	4.0	STR	6 3/8
OK526R	3.0	45° UP	4 3/4

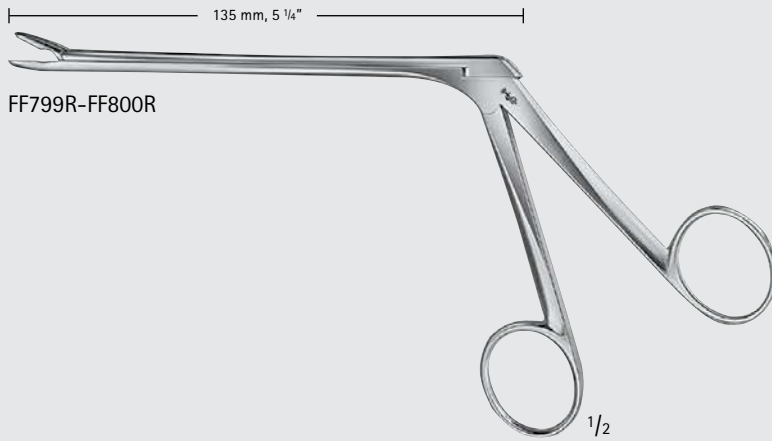
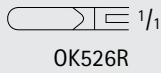
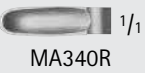
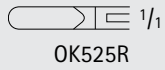
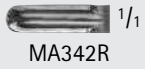

FF799R-FF800R

LOVE-GRUENWALD Rongeur

Catalog Number	Jaw Size (mm)	Jaw	Working Length (in.)
FF799R	2 x 10	STR	5 1/4
FF800R	3 x 10	STR	5 1/4

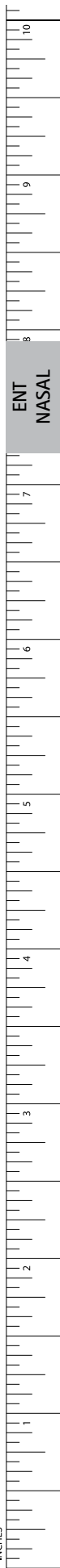
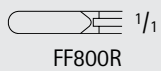
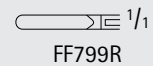

ENT-NASAL

Forceps- Nasal/Polyp/Bone Cutting

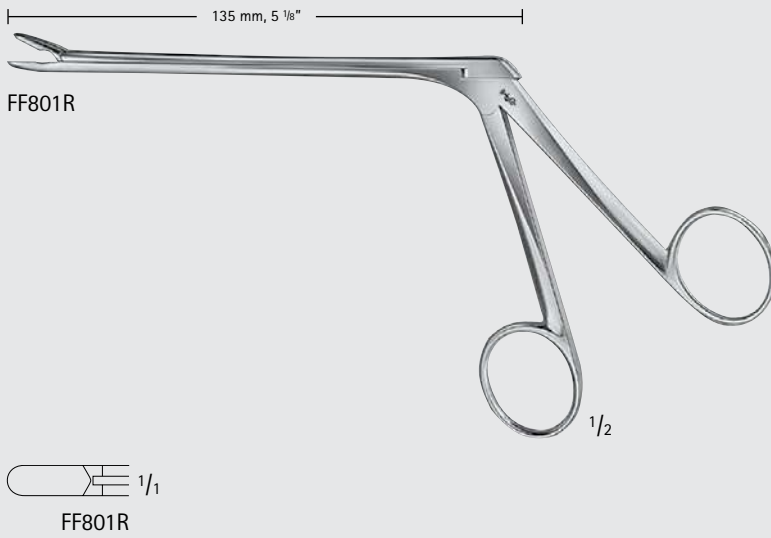

SPURLING Rongeur

Catalog Number	Jaw Size (mm)	Jaw	Working Length (in.)
FF801R	4 x 10	STR	5 1/8

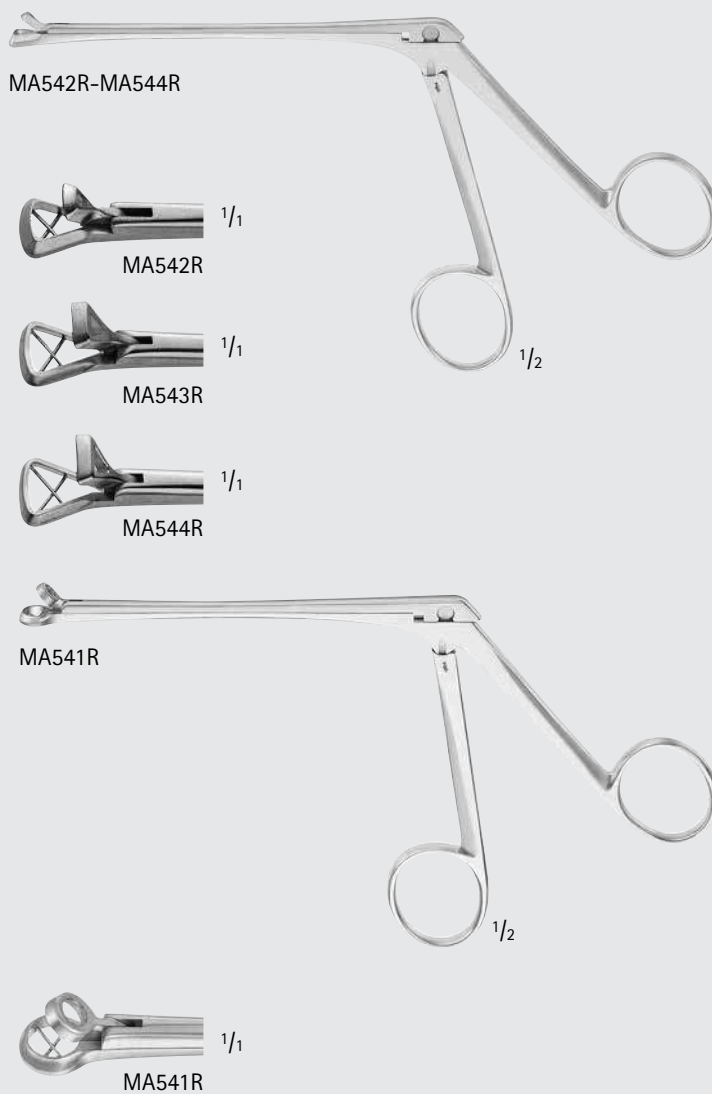

MELTZER Adenoid Punch Forceps

Catalog Number	Tip Size (mm)	Size (#)	Jaw	Working Length (in.)	Length (in.)
MA542R	5 MM BOTTOM BASKET, 4 MM UPPER JAW	0	TRIANGULAR	4 1/2	7 1/4
MA543R	7 MM BOTTOM BASKET, 3 MM UPPER JAW	1	TRIANGULAR	4 1/2	7 1/4
MA544R	9 MM BOTTOM BASKET, 8 MM UPPER JAW	2	TRIANGULAR	4 1/2	7 1/4
MA541R	6 MM BOTTOM BASKET, 5 MM UPPER BITE	1	ROUND	4 1/2	7 1/4

ENT
NASAL

MILLIMETERS

Nasal Biopsy Forceps

Catalog Number	Cup Size (mm)	Tip	Working Length (in.)	Length (in.)
MA676R	2.5 x 4	STR	5	7
MA680R	2.5 x 5	70° UP	4	7
MA678R	2.5 x 6	70° UP	3 1/2	7 1/4

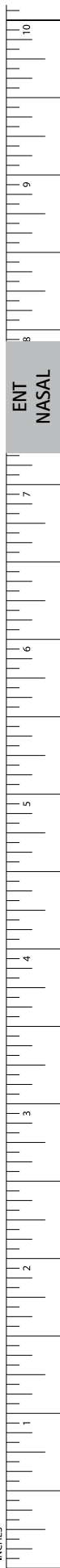
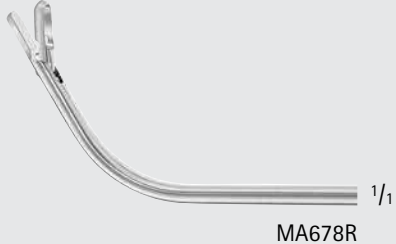
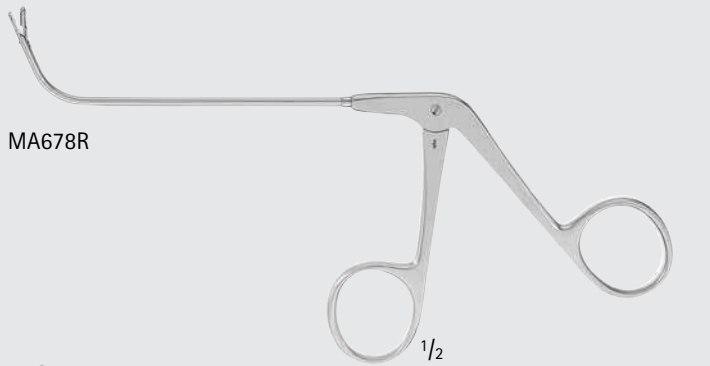
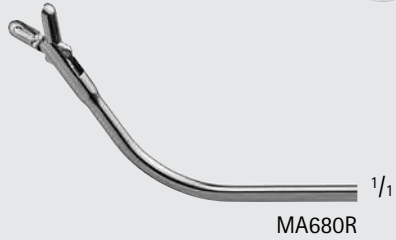
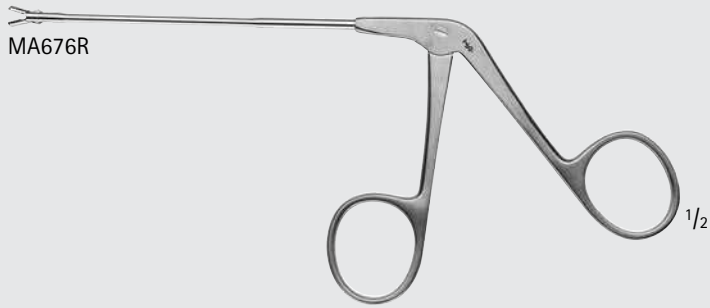

ENT-NASAL

Forceps- Nasal/Polyp/Bone Cutting

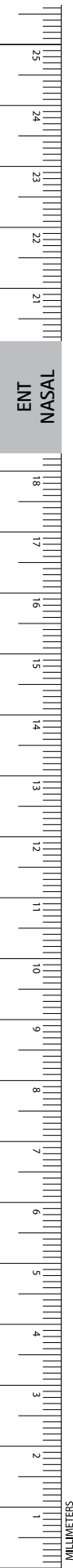

Nasal Suction Forceps

Catalog Number	Jaw Length (mm)	Tip	Tip Size (#)	Working Length (in.)	Length (in.)
MA697R	2.5	STR	00	4	7 1/4
MA699R	3.5	STR	0	4	7 1/4
MA701R	4.5	STR	1	4	7 1/4
MA698R	2.5	45° ANG-UP	00	4 3/4	7 1/4
MA700R	3.5	45° ANG-UP	0	4 1/2	7 3/4





Pediatric Ostrum Antrum Punch Forceps

Catalog Number	Jaw Size (mm)	Jaw	Working Length (in.)	Length (in.)
MA570R	1.5 x 4	STR BACK BITE	4 1/2	8
MA571R	1.5 x 4	RIGHT SIDE BITE	4 1/2	8
MA572R	1.5 x 4	LEFT SIDE BITE	4 1/2	8

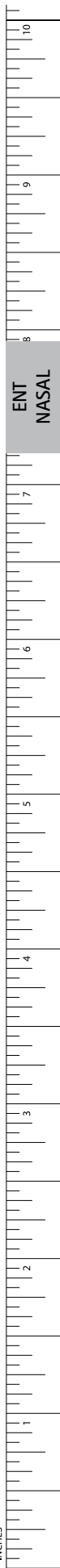

ENT-NASAL

Forceps- Nasal/Polyp/Bone Cutting

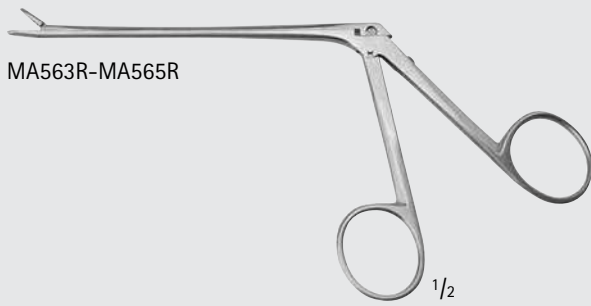

MA563R-MA565R

Ethmoid Forceps, Pediatric

Catalog Number	Jaw Size (mm)	Jaw	Working Length (in.)	Length (in.)
MA563R	3 x 5	STR	4	6 1/8
MA564R	3 x 5	ANG UP 45°	4	6 1/8
MA565R	3 x 5	ANG UP 90°	3 3/4	6 1/8



MA563R



MA564R



MA565R

Rotating Ostrum Antrum Punch Forceps, Backbiting

Catalog Number	Jaw Size (mm)	Size	Jaw	Working Length (in.)	Length (in.)
MA574R	1.5 x 4	Pediatric	ROTATING 360°	4 1/4	8 1/4
MA573R	3 x 7	Adult	ROTATING 360°	4 1/4	8 1/4

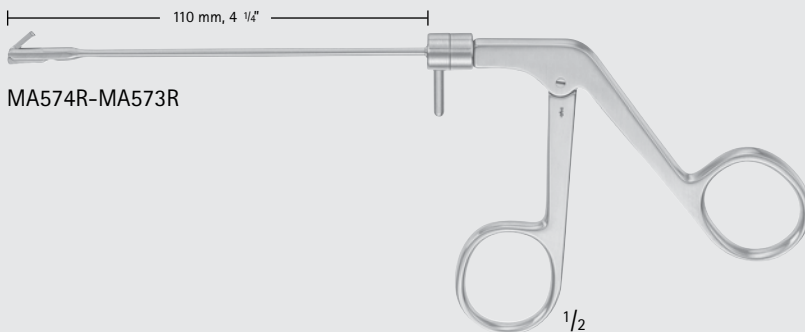

MA574R-MA573R



MA574R



MA573R

ENT
NASAL

MILLIMETERS

RONIS Adenoid Nasal Forceps

Catalog Number	Tip Size (mm)	Tip Size (#)	Jaw	Working Length (in.)	Length (in.)
MA545R	7 MM BASKET	1	TRIANGULAR	5 3/8	8 1/8
MA546R	8 MM BASKET	2	TRIANGULAR	5 3/8	8 1/8

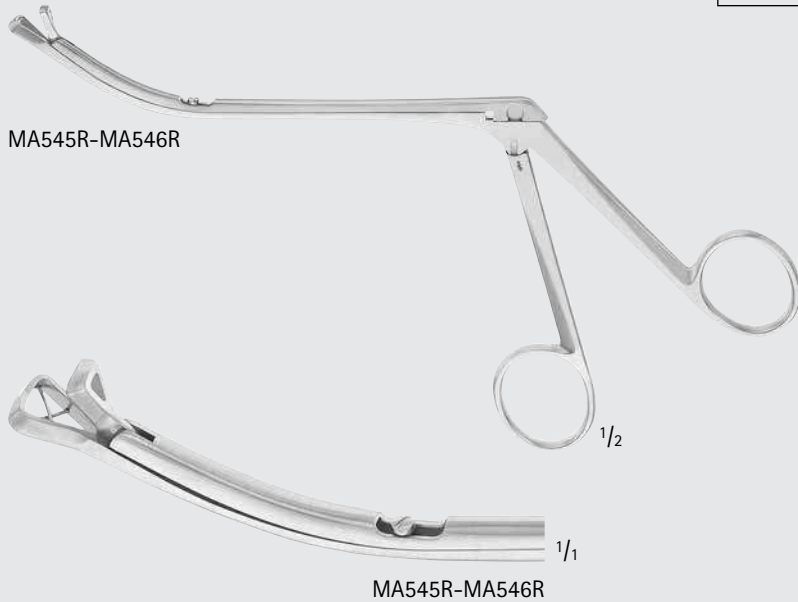

STAMMBERGER Sidecutting Antrum Punch Forceps

Catalog Number	Jaw	Length (in.)
MA568R	LEFT CUT	8 5/8
MA569R	RIGHT CUT	8 5/8

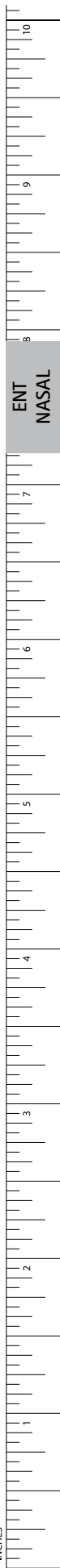
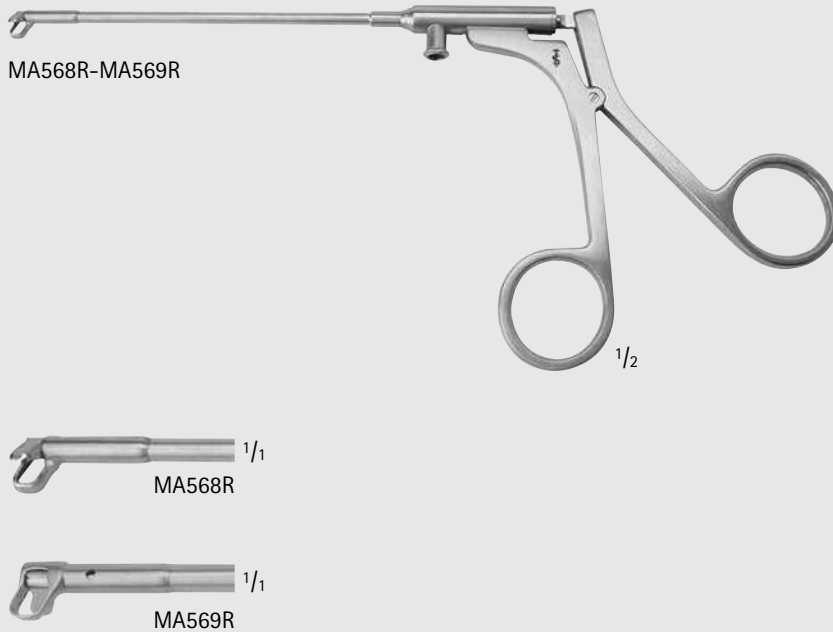

ENT-NASAL

Forceps- Nasal/Polyp/Bone Cutting

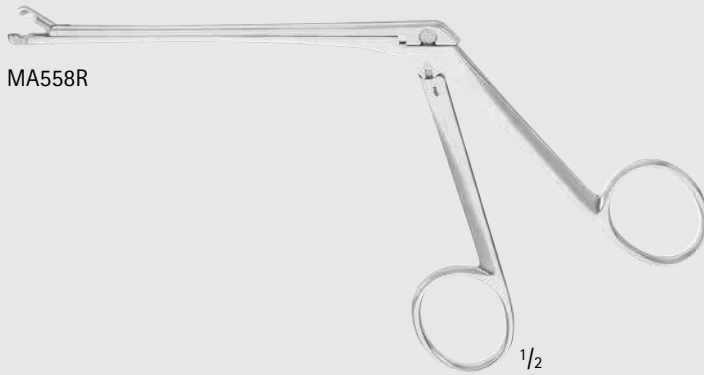

Sinus Cup Forceps

Catalog Number	Cup Size (mm)	Working Length (in.)	Length (in.)
MA558R	3	4 1/2	7

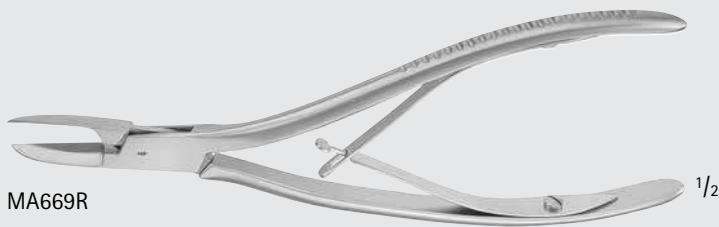

COTTLE Biting Forceps

Catalog Number	Jaw Length (mm)	Jaw	Length (in.)
MA669R	30	ANG	7

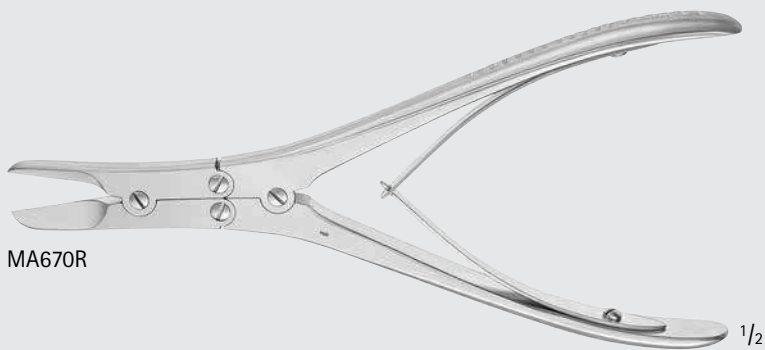

ROWLAND Bone Cutting Forceps, Double Action

Catalog Number	Jaw Length (mm)	Length (in.)
MA670R	25	7 1/4

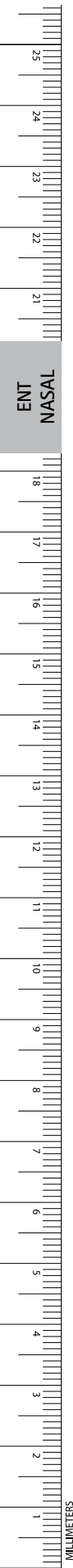

STAMM Bone Cutting Ronguer

Catalog Number	Length (in.)
F0604R	6



F0604R

1/2

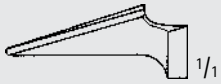

F0604R

1/1

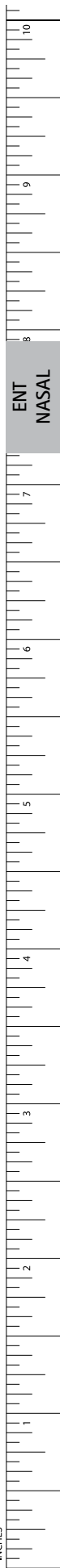

INCHES

ENT-NASAL

Forceps- Nasal/Polyp/Bone Cutting

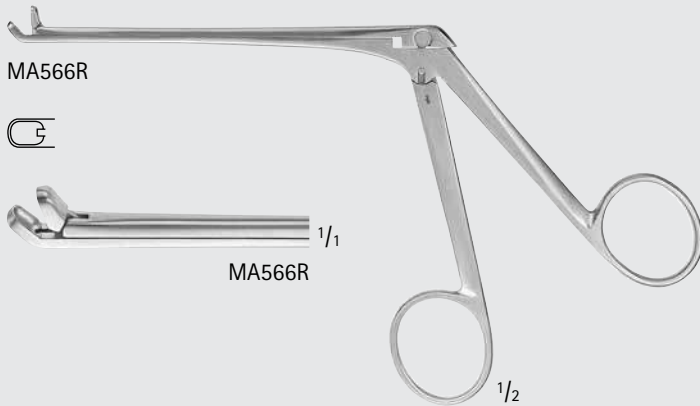
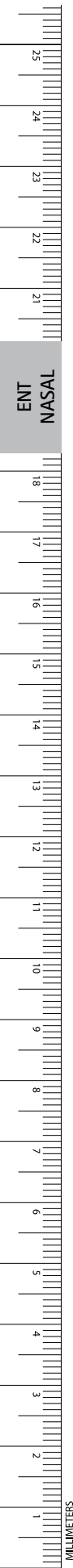

STUEMPEL-VOSS Nasal Forceps

Catalog Number	Cup (mm)	Tip	Working Length (in.)	Length (in.)
MA566R	3 x 5	ANG UP	4 1/4	6 7/8

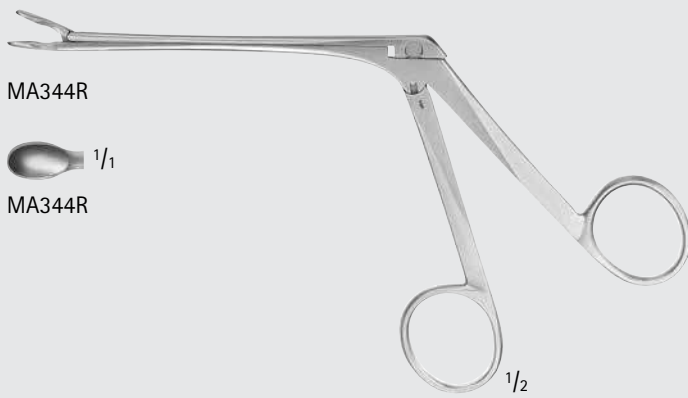

WEIL Nasal Forceps

Catalog Number	Cup (mm)	Tip	Working Length (in.)	Length (in.)
MA344R	5 x 8	STR	4	7 1/8
MA345R	5 x 8	ANG UP	4	7 1/8

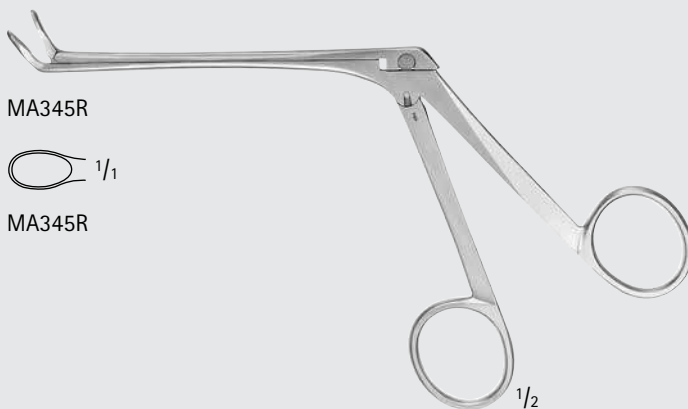

120 mm, 4 3/4"

OK505R-OK509R



WEIL-BLAKESLEY Nasal Forceps

Catalog Number	Jaw Size (mm)	Tip	Tip Size (#)	Working Length (in.)
OK505R	3.0	STR	0	4 3/4
MA320R	3.5	STR	0	4
OK506R	3.6	STR	0	4 3/4
MA321R	4	STR	1	4 1/2
OK507R	4.2	STR	1	4 3/4
OK508R	4.8	STR	2	4 3/4
MA322R	5	STR	2	4 1/2
OK509R	5.6	STR	3	4 3/4
OK520R	3.6	ANG 45° UP	0	4 1/2
MA323R	4	ANG 45° UP	1	4 1/8
OK521R	4.2	ANG 45° UP	1	4 1/2
OK522R	4.8	ANG 45° UP	2	4 1/2
MA324R	4	ANG 90° UP	1	4

110 mm, 4 1/4"

OK520R-OK522R

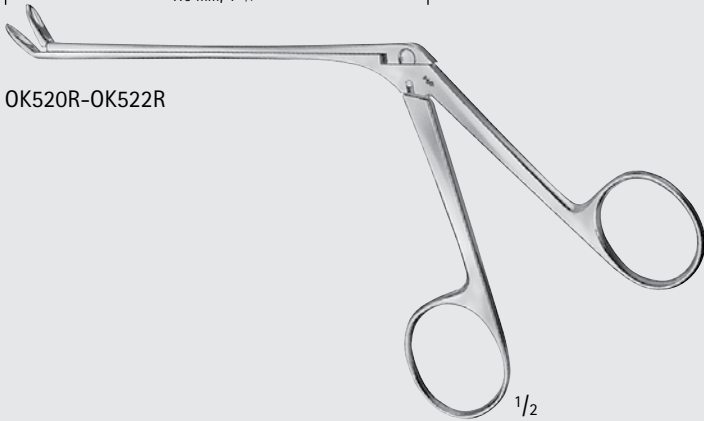

MA324R

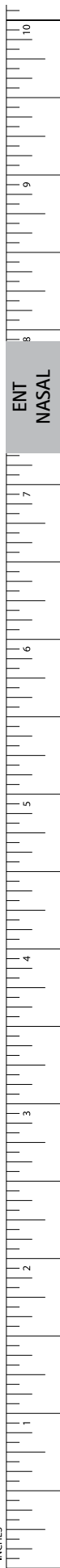
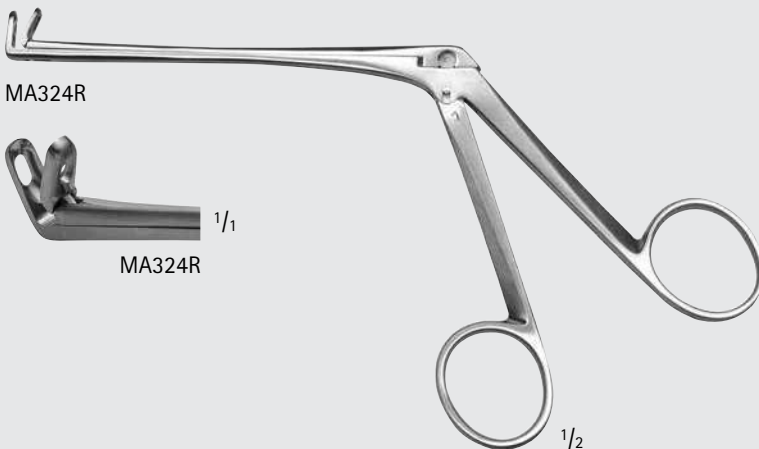

ENT-NASAL

Forceps- Nasal/Polyp/Bone Cutting



1/1

BLAKESLEY Thru-Cut Forceps

Catalog Number	Size	Jaw Size (mm)	Tip	Jaw Size (#)	Working Length (in.)	Length (in.)
MA694R	PEDIATRIC	2.5	STR	00	4 1/4	7
MA695R	PEDIATRIC	2.5	ANG	00	4 1/4	7
MA684R	-	3.5	STR	0	4 1/2	7 3/4
MA686R	-	2.5	ANG UP	00	4 3/8	7 1/4

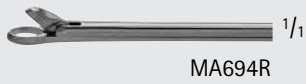

1/1

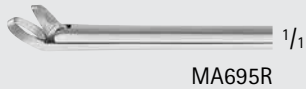

1/1



1/1



1/2



1/1

ENT
NASAL

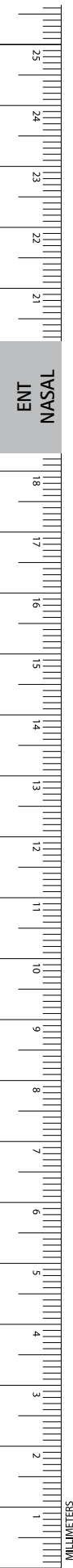

BLAKESLEY-WILDE Nasal Forceps

Catalog Number	Jaw Size (mm)	Tip	Working Length (in.)
OK544R	10 x 3.5	ANG 90° UP	4 1/4
OK545R	13.5 x 3.8	ANG 90° UP	4 1/4
OK546R	14.3 x 5	ANG 90° UP	4 1/4

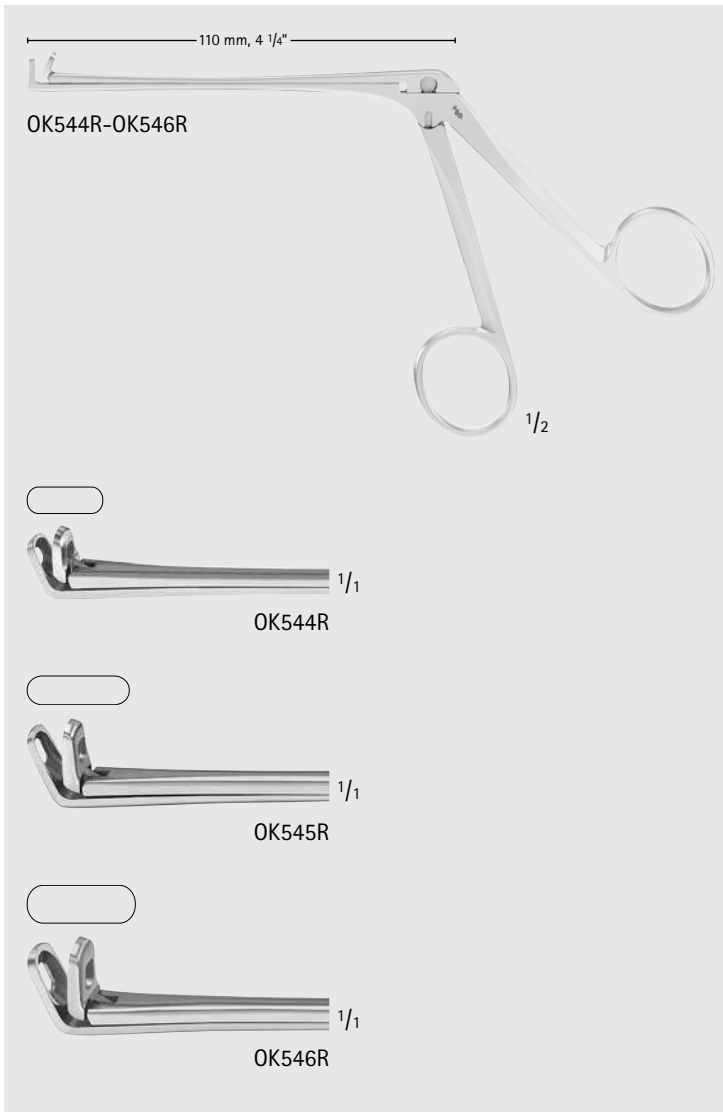

WILDE Ethmoid Nasal Forceps

Catalog Number	Jaw Size (mm)	Tip	Jaw Size (#)	Working Length (in.)
MA567R	3.5 x 12	ANG UP 45°	0	4 3/8

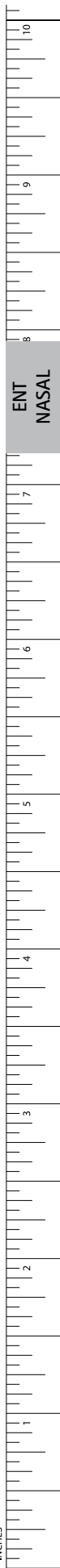
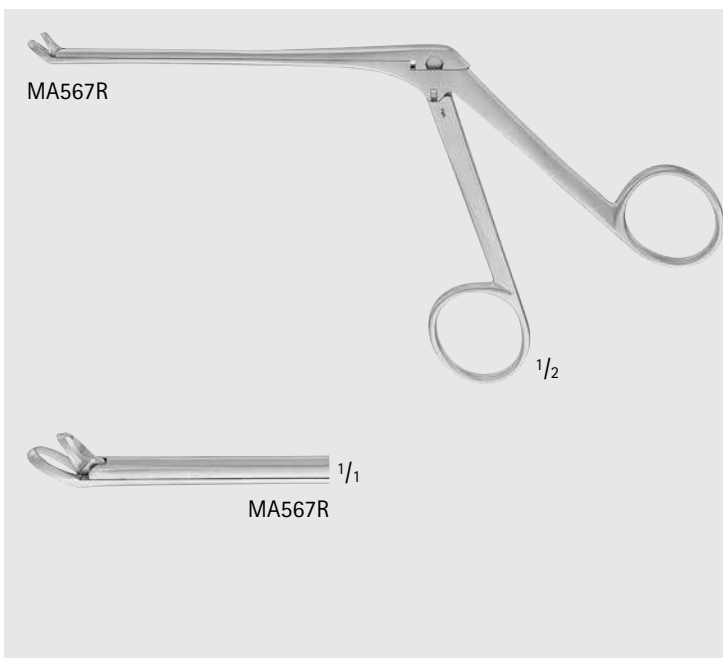

ENT-NASAL

Forceps- Nasal/Polyp/Bone Cutting



WATSON-WILLIAMS Ethmoid Forceps

Catalog Number	Jaw	Tip	Working Length (in.)
MA560R	3 MM THRU CUT JAWS W/ BASKET, ANG UP	ANG UP	5 3/8
OK530R	STR, SERR	STR	4 3/4

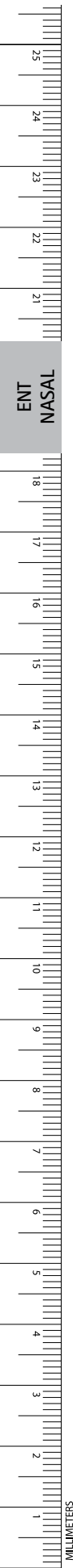

WATSON-WILLIAMS Ethmoid Forceps

Catalog Number	Jaw Size (mm)	Tip	Size	Working Length (in.)
OK527R	5.0	STR	SMALL	4 3/4
OK529R	7.0	STR	MEDIUM	4 3/4
OK531R	9.0	STR	LARGE	4 3/4

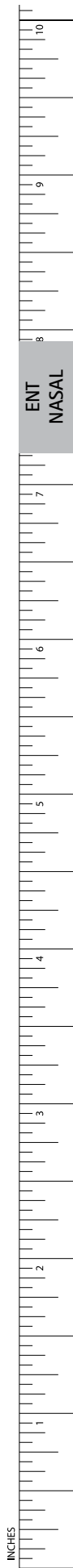
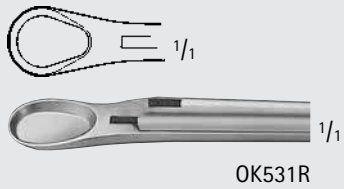
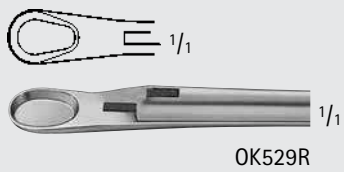
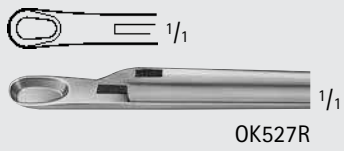
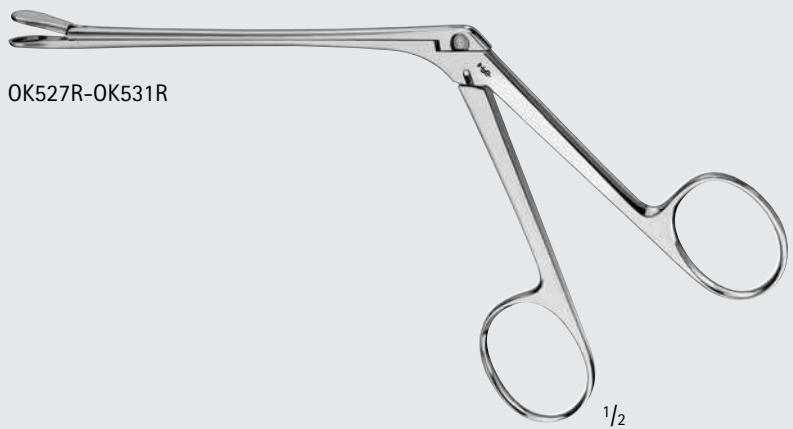

ENT-NASAL

Forceps- Nasal/Polyp/Bone Cutting



WILDE Nasal Forceps

Catalog Number	Jaw Size (mm)	Tip	Working Length (in.)	Length (in.)
MA561R	5 x 10	STR	4 1/2	7 1/4
MA562R	5 x 10	ANG UP	4 1/2	7 1/4

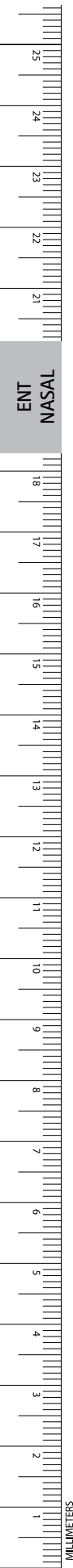
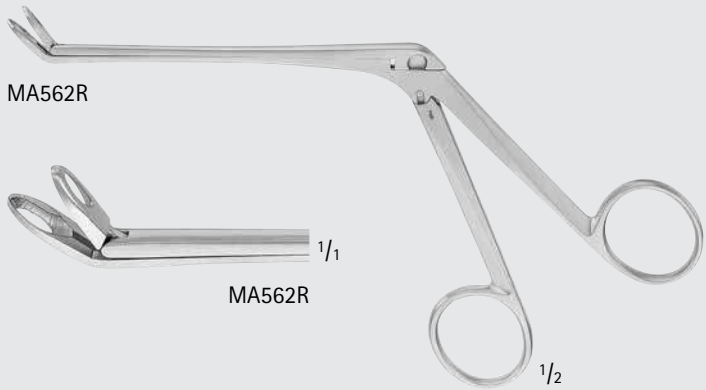

WILDE-Type Backbiter Forceps

Catalog Number	Jaw Size (mm)	Tip	Working Length (in.)	Length (in.)
MA688R	2	STR, ROTATING 360°	4 1/4	8 3/4
MA689R	2	CVD UP	3 1/8	6 7/8
MA690R	2	CVD DOWN	3 1/8	6 7/8

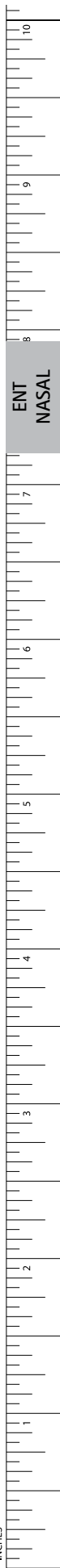
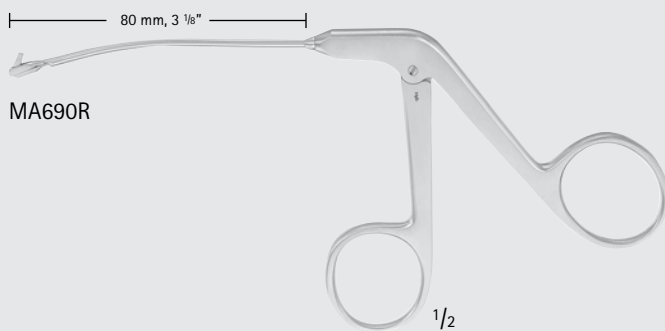
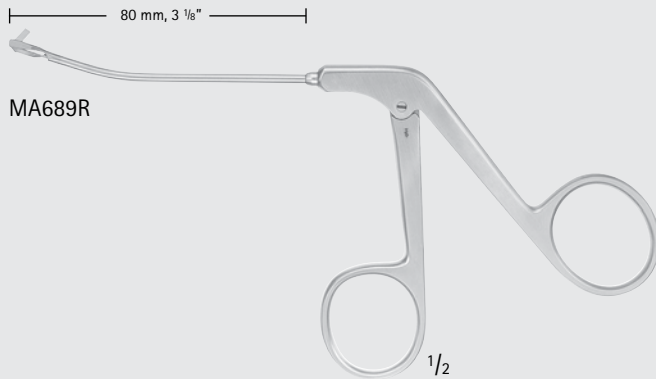
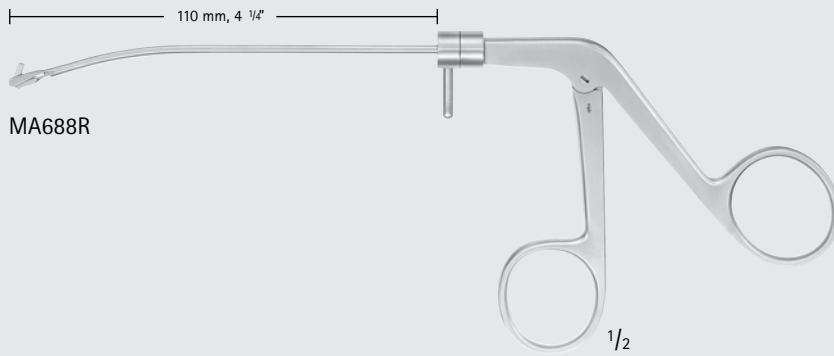

ENT-NASAL

Forceps- Cartilage/Morselizing/Straightening

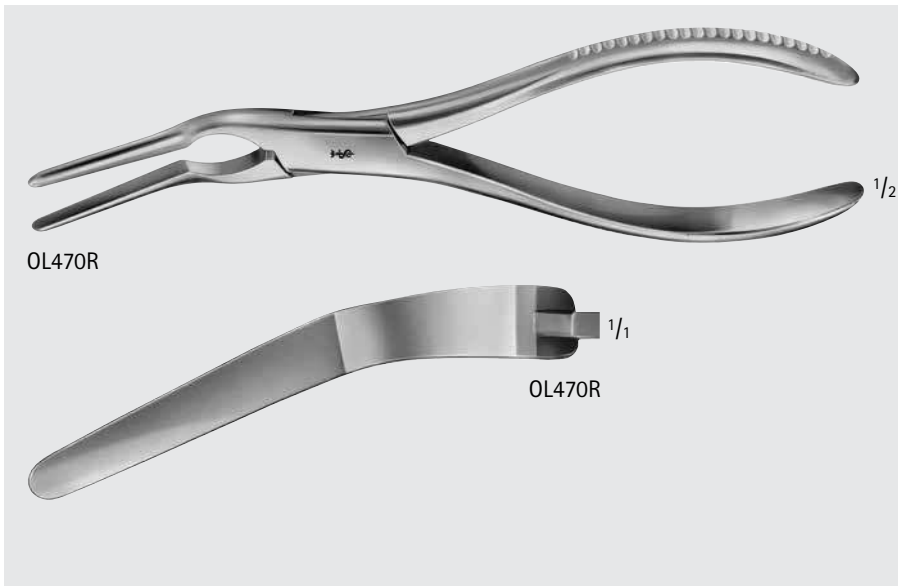
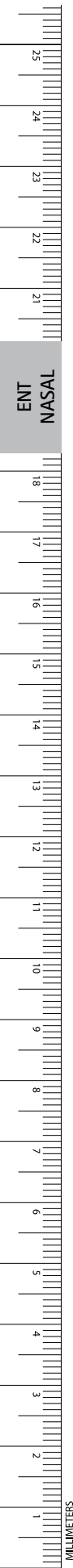

ASH Septum Forceps

Catalog Number	Tip	Length (in.)
OL470R	ANG	8 3/4

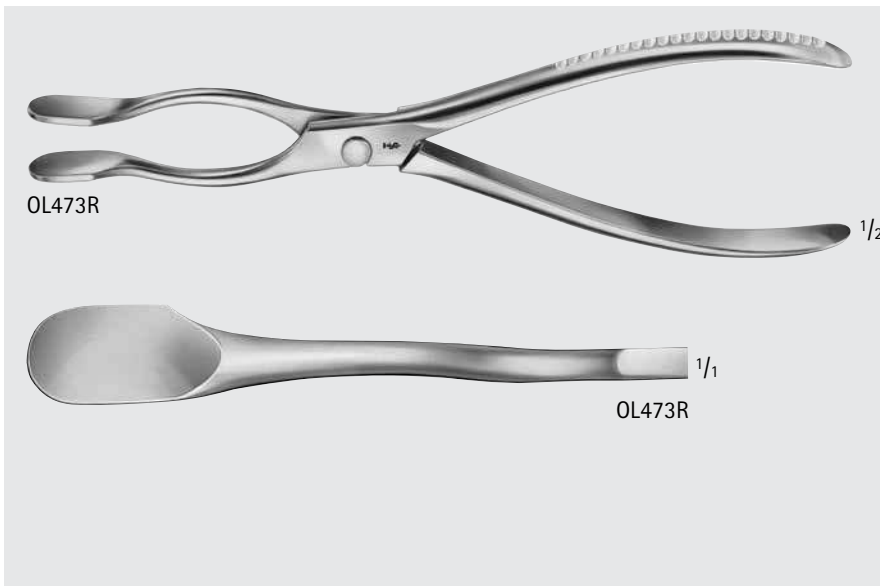

COTTLE-WALSHAM Septum Forceps

Catalog Number	Tip	Length (in.)
OL473R	STR	8 3/4

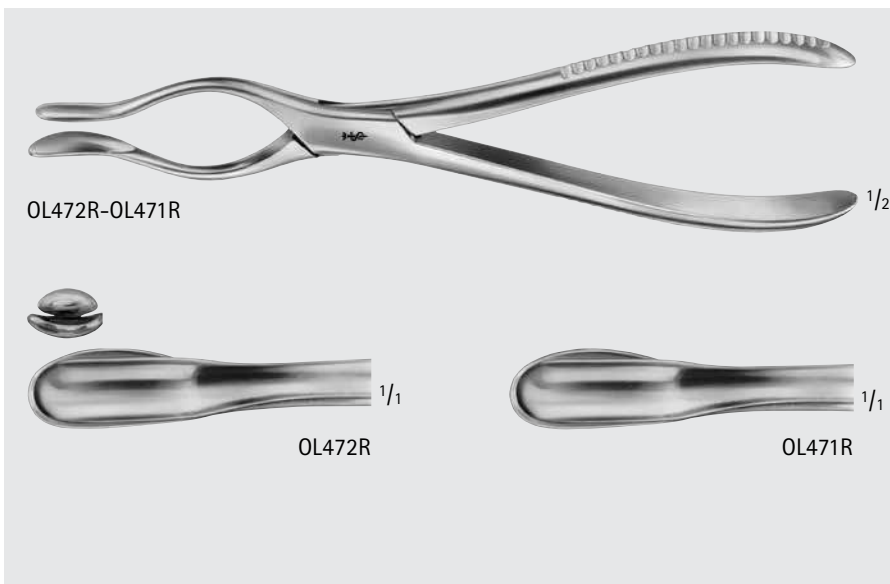

WALSHAM Septum Forceps

Catalog Number	Tip	Length (in.)
OL472R	LEFT	8 3/4
OL471R	RIGHT	8 3/4

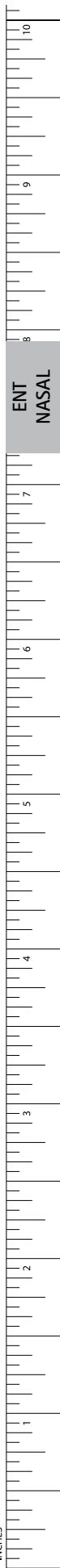
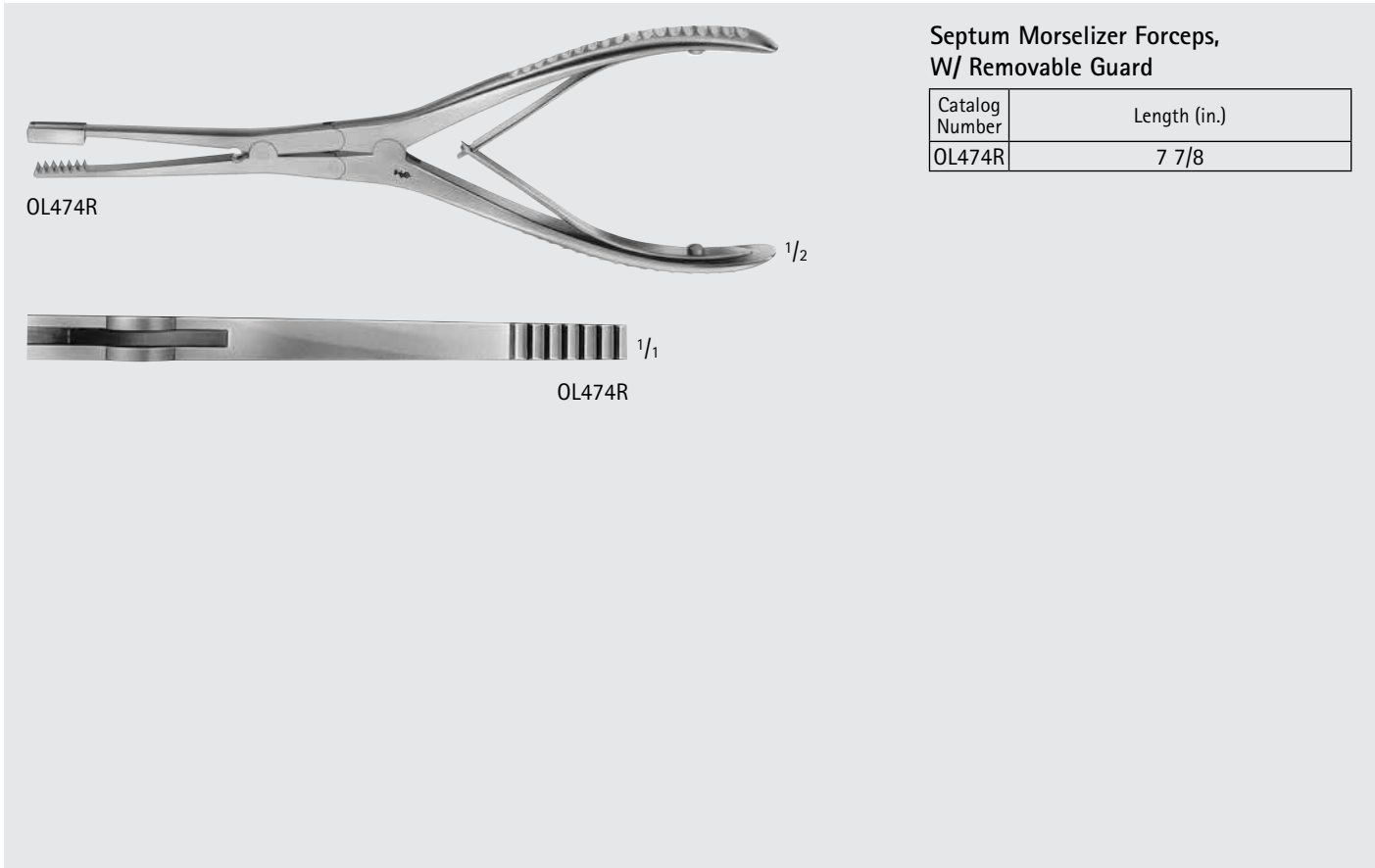

ENT-NASAL

Nasal Snares and Wires

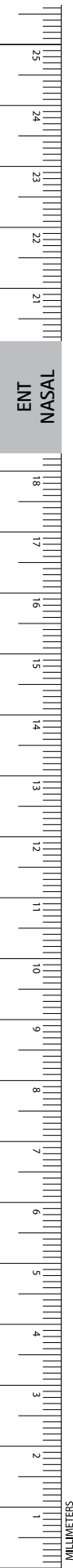

KRAUSE Nasal Polyp Snare, Knee-Shape

Catalog Number	Length (in.)
OK260R	9 3/4



OK260R

WILDE Nasal Polyp Snare

Catalog Number	Tip	Length (in.)
OK270R	BAYO	9 3/4



OK270R

Nasal Snare Wire

Catalog Number	Diameter (mm)	Packaging
OK293R	0.3	100/BOX

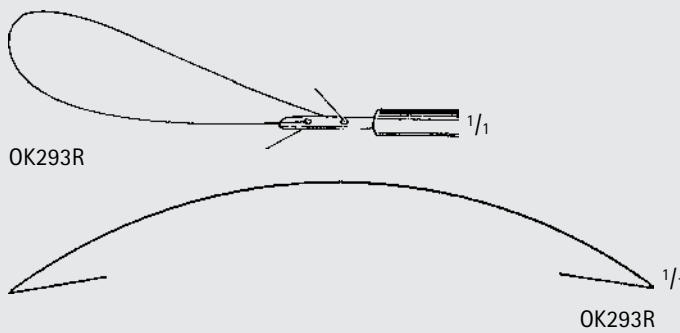

OK293R

OK293R

OL201R 1/2

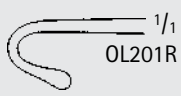

OL201R ^{1/1}

LANGE Fistula Hook

Catalog Number	Tip	Length (in.)
OL201R	BLUNT	9 1/4



MA178R-MA179R 1/2



MA178R ^{1/1}



MA179R ^{1/1}

CONVERSE Skin Hooks

Catalog Number	Size	Length (in.)
MA178R	SMALL	7 1/8
MA179R	LARGE	7 1/8



OL207R 1/2



^{1/1}

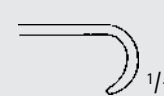

OL207R ^{1/1}

CONVERSE Double Hook

Catalog Number	Blade Size (mm)	Length (in.)
OL207R	7 x 12 / 8 x 12	4 3/4



MA186R 1/2



MA186R ^{1/1}

MILLARD Double Hook W/ Thimble Mount

Catalog Number	Length (in.)
MA186R	3 1/4

ENT-NASAL

Retractors

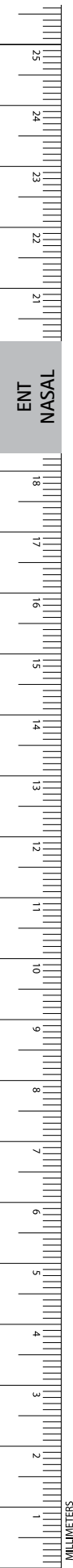

OK099R-MA422R

1/2

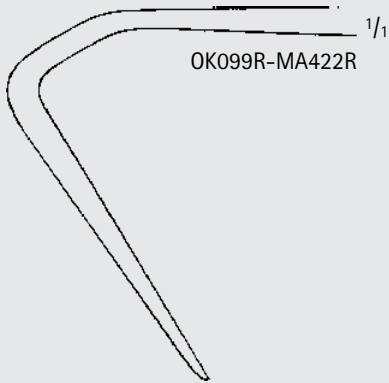

OK099R-MA422R

1/1

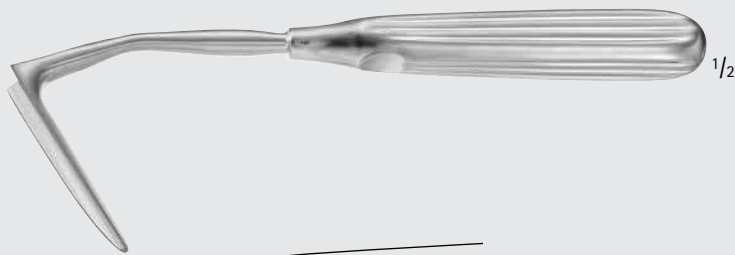

MA423R

1/2

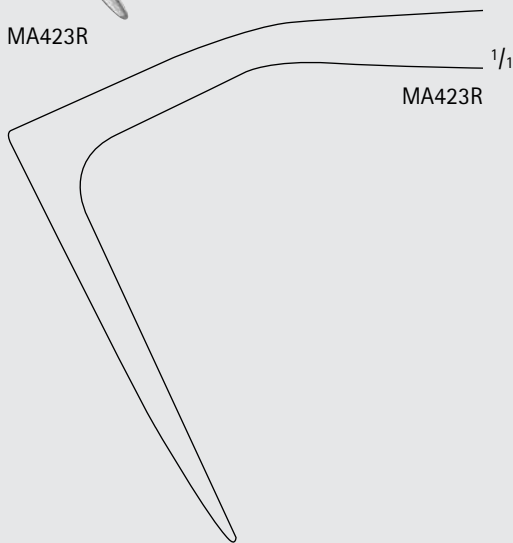

MA423R

1/1

AUFRICHT Nasal Retractor

Catalog Number	Blade Size (mm)	Length (in.)
OK099R	10 x 45	6 7/8
MA422R	10 x 45	7 3/8
MA423R	11 x 60	7 3/8



MA424R

1/2

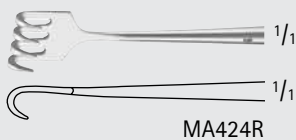

MA424R

1/1

1/1

Blair Retractor

Catalog Number	Tip	Blade End	Tip Size (mm)	Length (in.)
MA424R	SHARP	4 PRONGS	7	5 1/4

CONVERSE Nasal Retractor

Catalog Number	Blade Size (mm)	Length (in.)
MA425R	9 x 18	3 1/4
MA426R	12 x 21	3 1/4
MA427R	12 x 38	3 1/4
MA428R	12 x 53	3 1/4
MB107R	44 x 11	4 1/2



MA425R

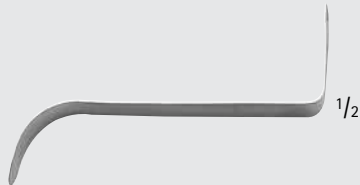

MA426R



MA427R



MA428R



MB107R

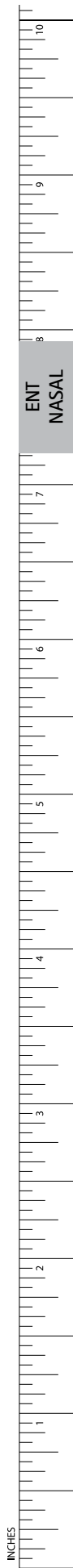

ENT-NASAL

Retractors



MA430R



MA430R

COTTLE Nasal Retractor

Catalog Number	Tip	Blade End	Tip Size (mm)	Length (in.)
MA430R	BLUNT	4 PRONGS	10	5 1/8



OL214R



1/1



OL214R

COTTLE Nasal Retractor, Double Ended

Catalog Number	Blade Size (mm)	Tip	Length (in.)
OL214R	12 x 5 / 4 x 4.5	BALL END/ BLUNT	7 7/8



OL203R-OL204R



OL203R



OL204R

COTTLE Retractor

Catalog Number	Tip	Length (in.)
OL203R	BLUNT/RIGHT SHARP	5 3/4
OL204R	LEFT SHARP/BLUNT	5 3/4

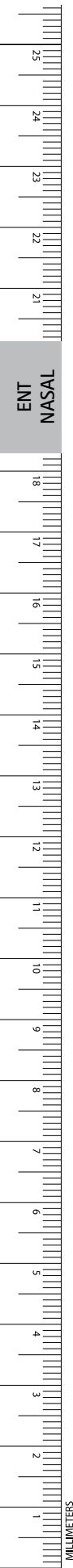



OL212R



OL212R



OL211R



OL211R

COTTLE Alar (MASING) Retractor

Catalog Number	Blade Size (mm)	Length (in.)
OL211R	6 x 12	5 1/2
OL212R	10 x 12	5 1/2



OL202R

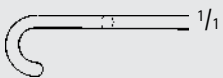

OL202R



MA431R



MA431R

FOMON Retractor

Catalog Number	Tip Size (mm)	Tip	Blade End	Length (in.)
OL202R	12	BLUNT	2 PRONGS	5 3/4
MA431R	13	BALL END	2 PRONGS	6 1/4

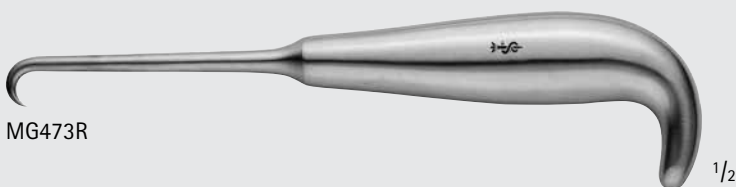

MG473R

GILLIES Bone and Zygoma Hook

Catalog Number	Tip Size (mm)	Length (in.)
MG473R	9	7 1/4

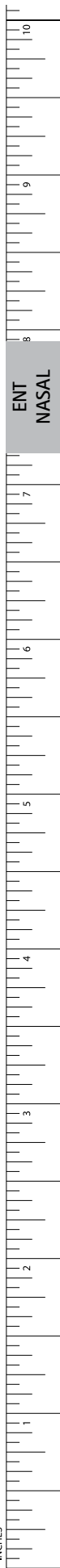

ENT-NASAL

Retractors

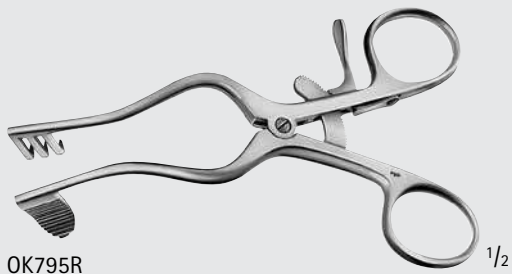

OK795R $\frac{1}{2}$

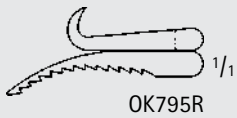

OK795R $\frac{1}{1}$

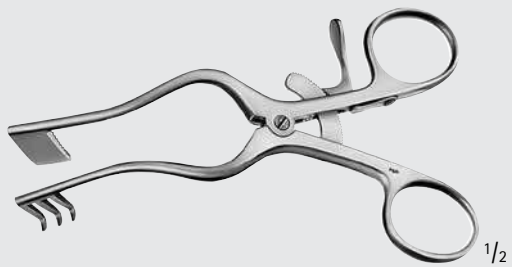

$\frac{1}{2}$

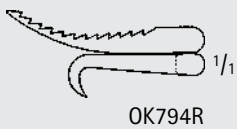

OK794R $\frac{1}{1}$



$\frac{1}{1}$

PERKINS Antrum Retractor

Catalog Number	Right Blade	Left Blade	Length (in.)
OK795R	3 PRONGS	SOLID	5
OK794R	SOLID	3 PRONGS	5

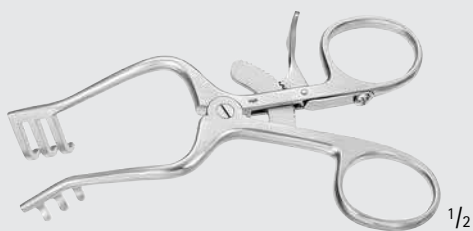

MA438R $\frac{1}{2}$

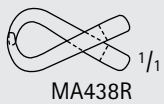

MA438R $\frac{1}{1}$

Baby WEITLANER Retractor

Catalog Number	Tip	Blade End	Length (in.)
MA438R	BLUNT	3 x 3 PRONGS	4 1/4

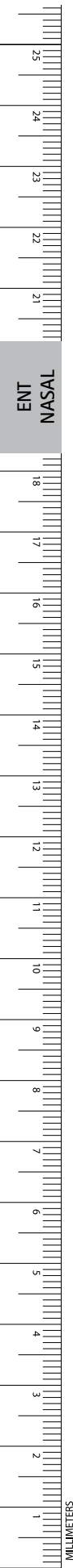



MB054R



MB054R

WULLSTEIN Retractor

Catalog Number	Tip	Blade End	Length (in.)
MB054R	BLUNT	3 x 3 PRONGS	4 1/4

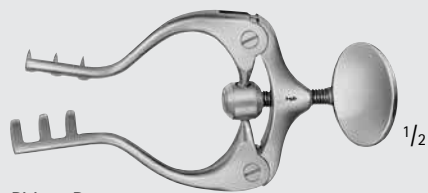

BV030R



BV030R



BV032R



BV032R



BV033R



BV033R

JANSEN Retractor

Catalog Number	Tip	Blade End	Length (in.)
BV030R	SHARP	3 x 3 PRONGS	4
BV032R	BLUNT	3 x 3 PRONGS	4
BV033R	BLUNT	3 x 4 PRONGS	4

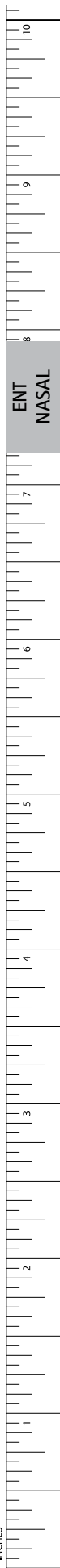

INCHES

ENT-NASAL

Elevators and Dissectors



OL477R

BOIES Nasal Fracture Elevator

Catalog Number	Tip	Length (in.)
OL477R	BLUNT	7



OL479R

GOLDMANN Septum Displacer

Catalog Number	Tip	Length (in.)
OL479R	STR	7 7/8

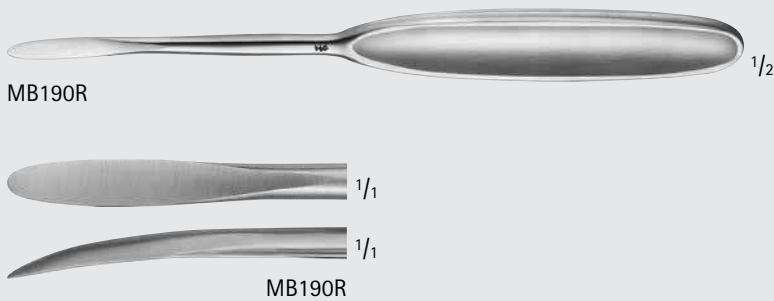

MB190R

MB190R

CUSHING Elevator, Narrow

Catalog Number	Tip Size (mm)	Tip	Length (in.)
MB190R	8	SHARP	7 3/4



MA147R

LEMPERT Elevator

Catalog Number	Tip Size (mm)	Blade	Length (in.)
MA147R	7	CVD	7 1/4

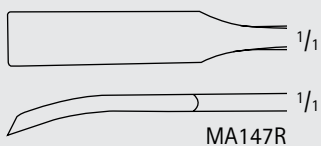

MA147R

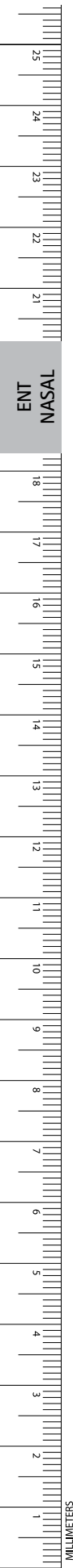



MA145R-MA146R

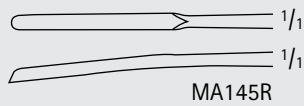

MA145R

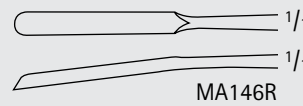

MA146R

LEMPERT Elevator

Catalog Number	Tip	Tip Size (mm)	Length (in.)
MA145R	SLIGHT CVD	2	6 3/4
MA146R	SLIGHT CVD	3	6 3/4
OG163R	STR	3	7 1/2
OG164R	BROAD, SLIGHT CVD	6	7 1/4



OG163R

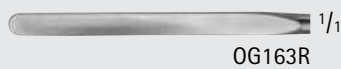

OG163R



OG164R



1/1

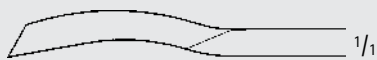

1/1

OG164R



MA290R



MA290R 1/1

KLEINERT-KUTZ Elevator and Dissector, Double Ended

Catalog Number	Tip Size (mm)	Length (in.)
MA290R	2/4	7



OL192R

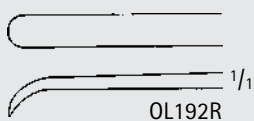

OL192R

MCKENTY Periosteal Elevator

Catalog Number	Tip	Tip Size (mm)	Length (in.)
OL192R	CVD, SHARP	4.0	6

ENT-NASAL

Elevators and Dissectors

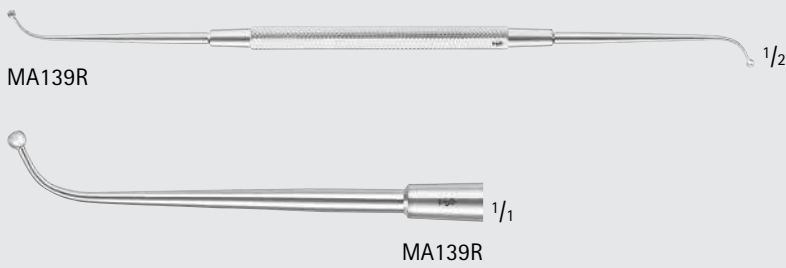

Ball End Elevator, Double Ended

Catalog Number	Blade Shape	Length (in.)
MA139R	ANG	7 1/2

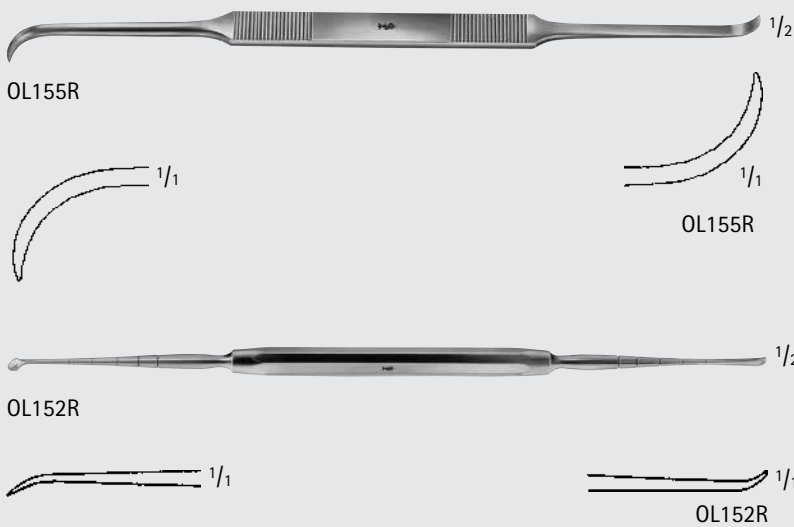

COTTLE Elevator, Double Ended

Catalog Number	Blade	Length (in.)
OL155R	-	7 7/8
OL152R	GRADUATED	7 7/8

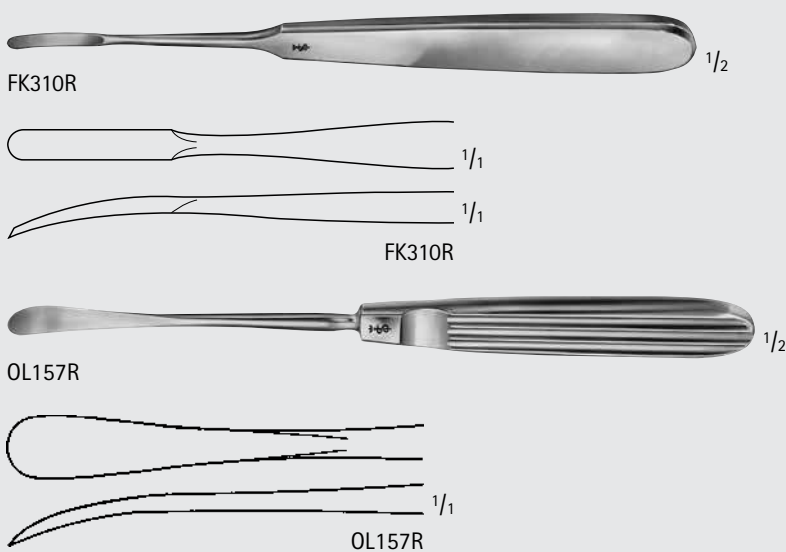

COTTLE Periosteal Elevator

Catalog Number	Tip	Width (mm)	Length (in.)
FK310R	SLIGHTLY CVD	4	7
OL157R	CVD, SHARP	8	7 3/4



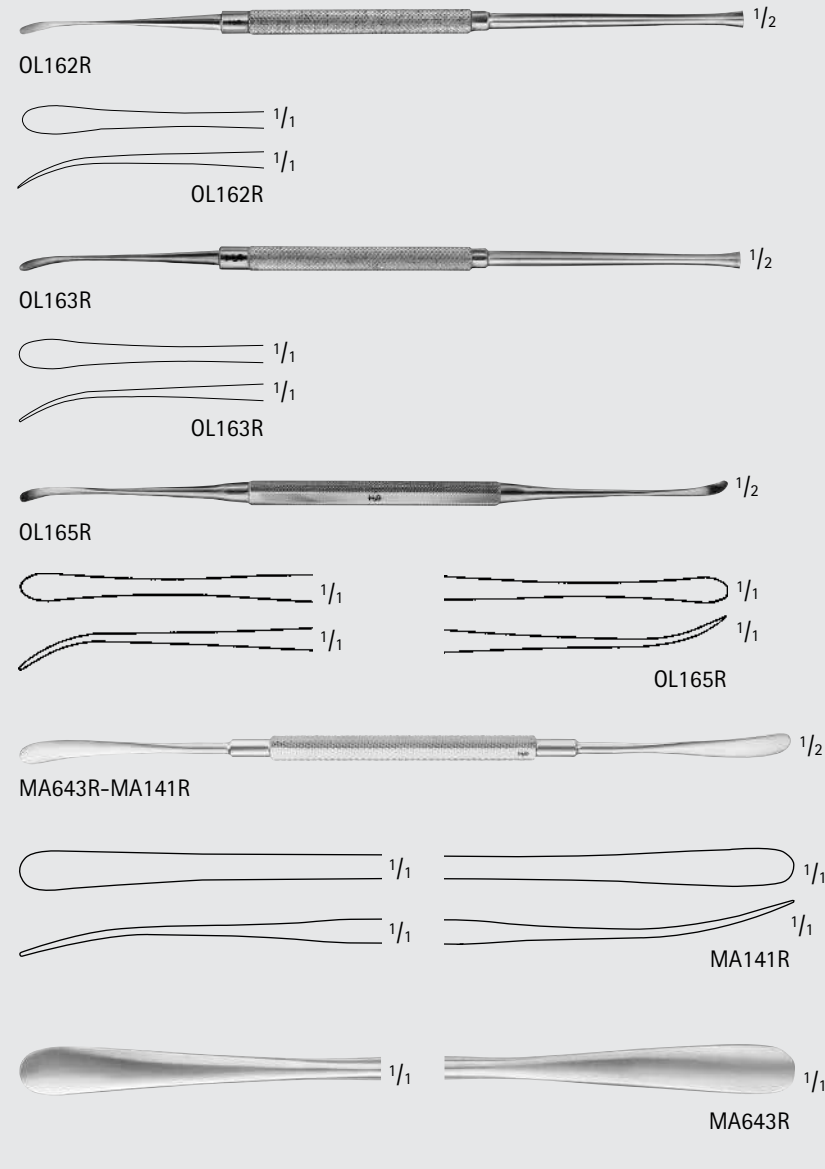
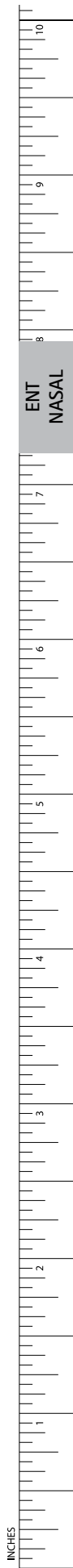

FREER Elevator

Catalog Number	Tip	Tip Size (mm)	Length (in.)
OL162R	SINGLE ENDED SHARP	4	7 1/2
OL163R	SINGLE ENDED BLUNT	4	7 1/2
OL165R	SHARP/BLUNT	4 / 4	7 1/4
MA643R	SHARP/BLUNT	4.5 / 4.5	7 1/2
MA141R	SHARP/BLUNT	6.5	7 1/2

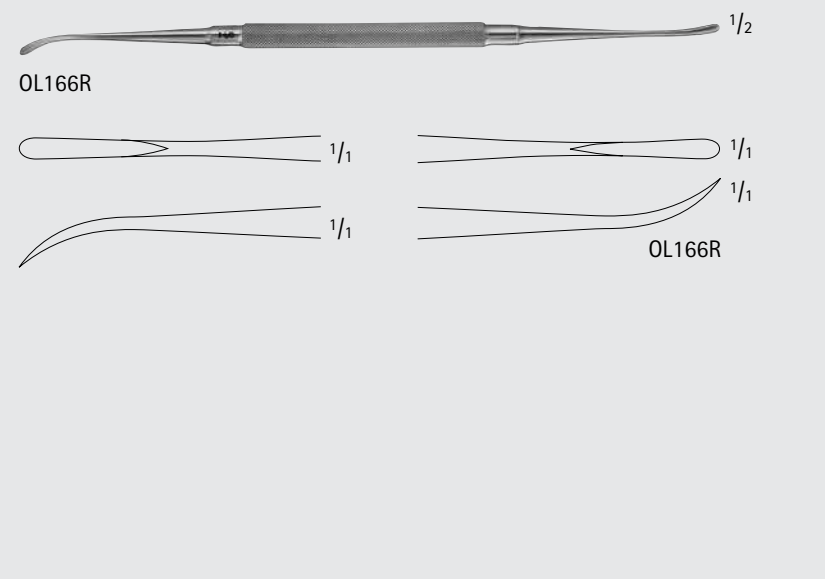

FREER-YASARGIL Elevator

Catalog Number	Tip	Length (in.)
OL166R	SHARP/SHARP	7 1/4

ENT-NASAL

Elevators and Dissectors

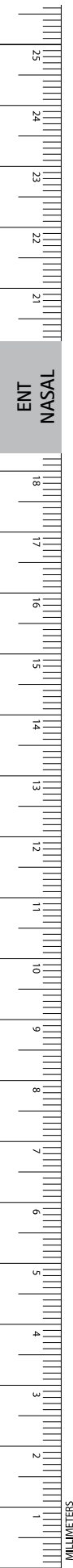
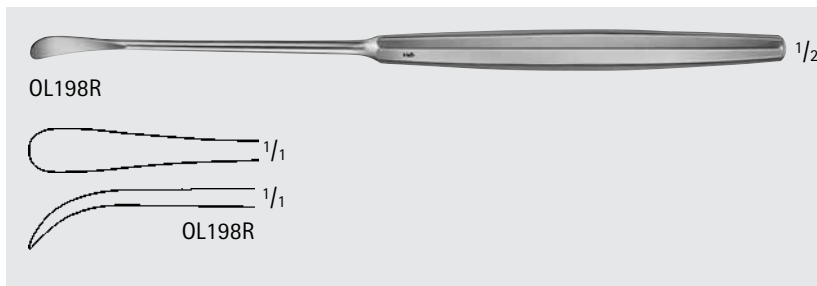
SEWALL Antrum Elevator

Catalog Number	Tip	Tip Size (mm)	Length (in.)
OL198R	BLUNT	5.9	7 7/8

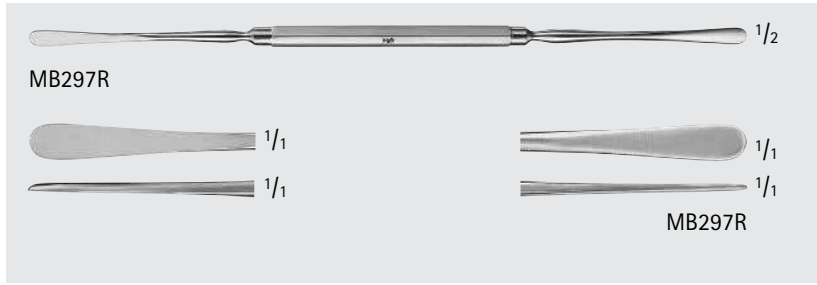

HAJEK-BALLENGER Septum Elevator and Dissector, Double Ended

Catalog Number	Tip	Length (in.)
MB297R	SHARP/BLUNT	7 1/2



COTTLE (MASING) Elevator, Graduated

Catalog Number	Blade	Length (in.)
OL153R	DBL ENDED	7 7/8



PENNINGTON Elevator

Catalog Number	Tip	Length (in.)
OL151R	SHARP/SHARP	8 1/4

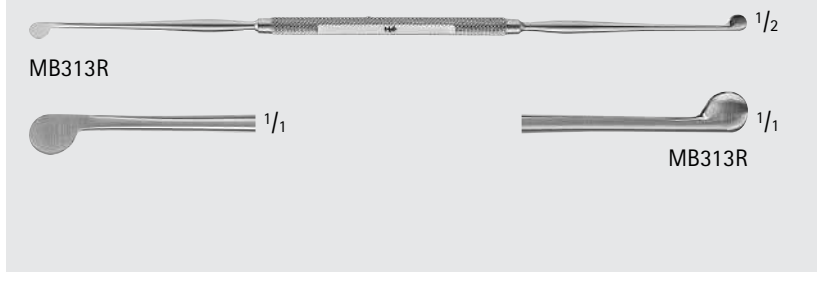

PIERCE Submucous Dissector

Catalog Number	Length (in.)
MB313R	7 1/2

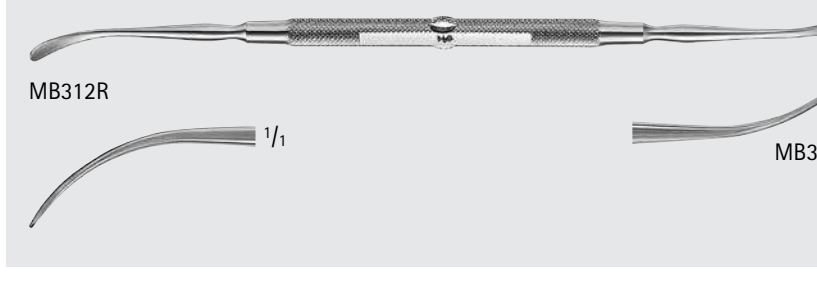

ROGERS Submucous Dissector

Catalog Number	Length (in.)
MB312R	8 3/4

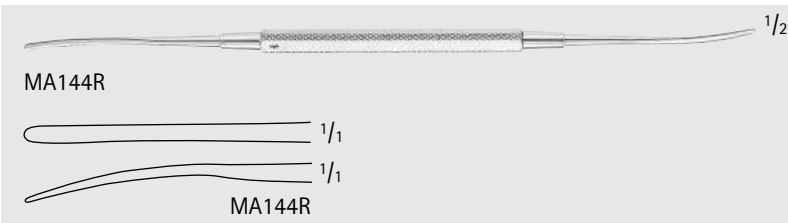

HENNER Elevator, Double Ended

Catalog Number	Tip Size (mm)	Length (in.)
MA144R	2/2	8 1/2

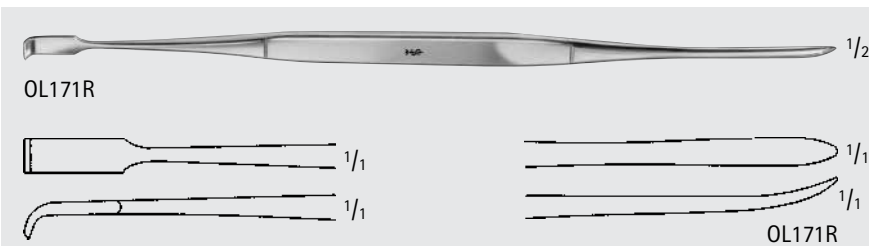

HOWARTH Elevator, Double Ended

Catalog Number	Tip	Length (in.)
OL171R	SHARP/BLUNT	8 1/2

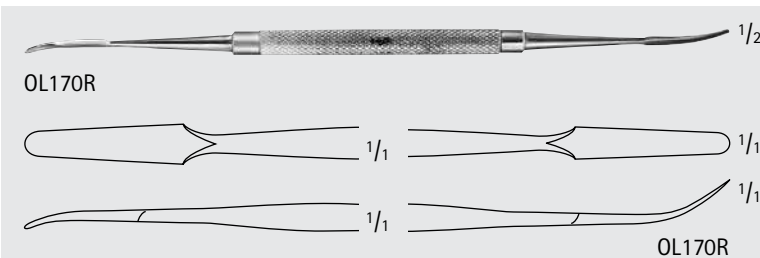

KILLIAN Elevator, Double Ended

Catalog Number	Tip	Length (in.)
OL170R	SHARP/BLUNT	7 1/4

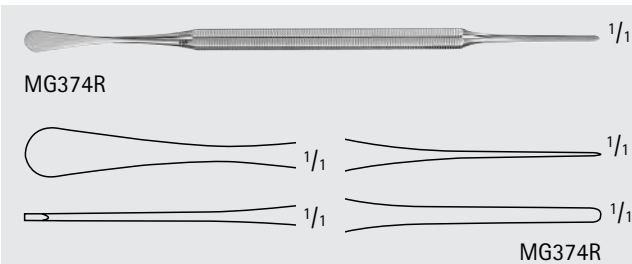

Spatula and Packer, Double Ended

Catalog Number	Length (in.)
MG374R	5 3/4

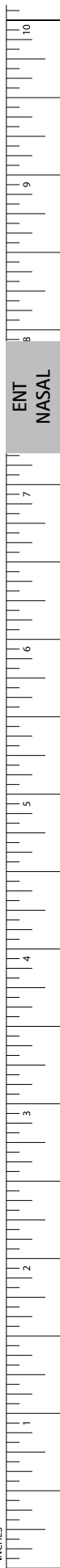

ENT-NASAL

Elevators and Dissectors



OL160R

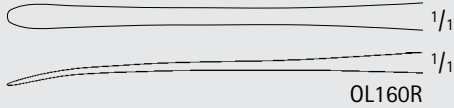

HALLE Elevator

Catalog Number	Tip	Tip Size (mm)	Length (in.)
OL160R	BLUNT	3.3	7



OM307, OM309R, OM308R

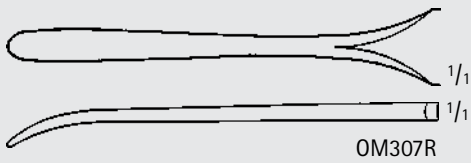

OM307R

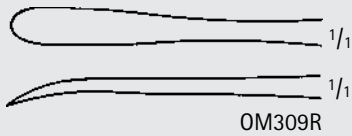

OM309R

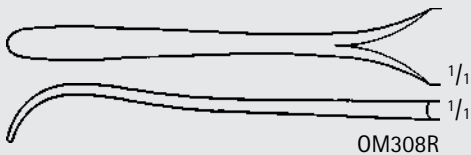

OM308R

KOENIG Elevator

Catalog Number	Tip	Tip Size (mm)	Length (in.)
OM307R	SLIGHTLY CVD	4.5	6 1/8
OM309R	SLIGHTLY CVD	4.5	6 1/8
OM308R	STRONGLY CVD	4.5	6 1/8



MA143R

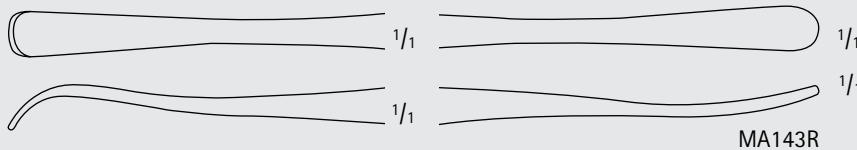

MA143R

OBWEGESER-FREER Elevator

Catalog Number	Tip	Tip Size (mm)	Blade Shape	Length (in.)
MA143R	BLUNT	6	DBL ENDED	8 1/2

ENT
NASAL

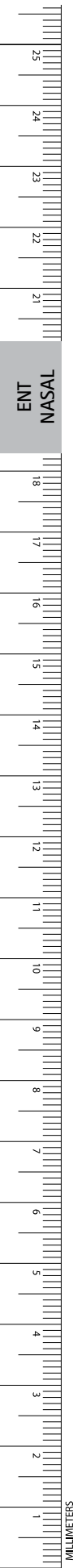

COTTLE Septum Speculum

Catalog Number	Blade Size (mm)	Blade Shape	W/ Set Screw	Length (in.)
OK085R	50 x 6	TAPERED	NO	5 1/4
OK089R	76 x 7	THIN	YES	5 1/4
OK090R	90 x 7	THIN	YES	5 1/4



OK085R

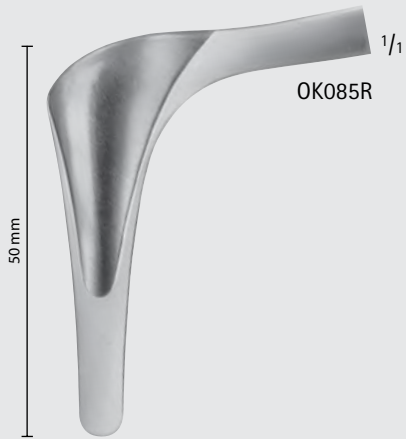

OK089R-OK090R

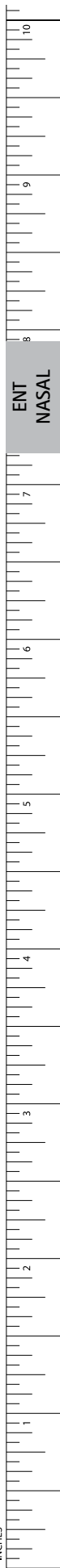
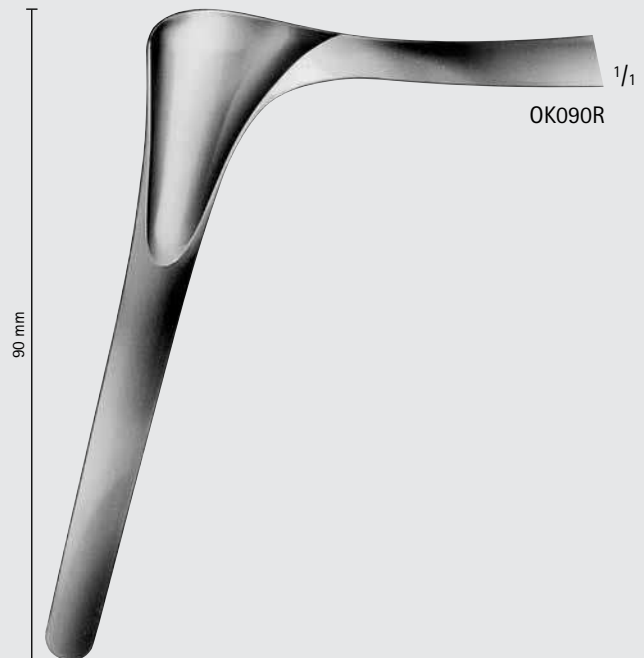
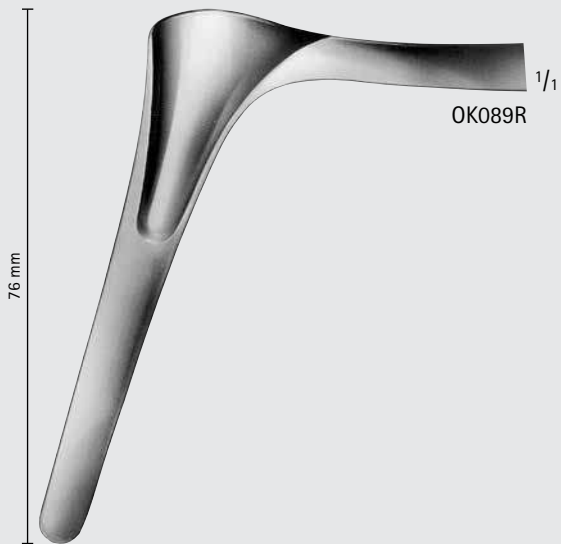

ENT-NASAL

Specula

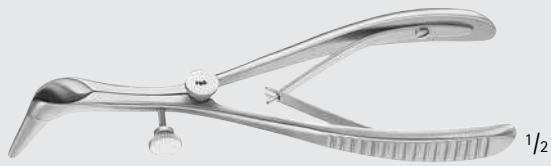

OK105R-OK108R

COTTLE Nasal Speculum

Catalog Number	Blade Size (mm)	Blade Shape	Size (#)	Length (in.)
OK105R	20	Xtra Thin	1	5 1/4
OK106R	38	Xtra Thin	2	5 1/4
OK107R	41	Xtra Thin	3	5 1/4
OK108R	60	Xtra Thin	4	5 1/4

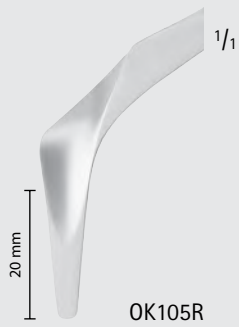

OK105R



OK106R



OK107R



OK108R

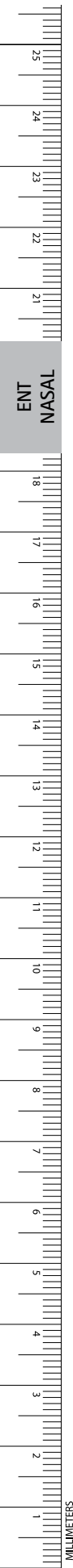

COTTLE Septum Speculum (continued)

Catalog Number	Blade Size (mm)	Blade Shape	Length (in.)
MA346R	50	THIN	5 5/8



MA346R

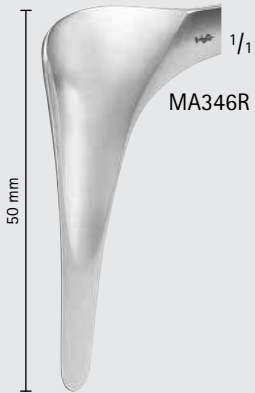

KILLIAN Septum Speculum, Aseptic

Catalog Number	Blade Size (mm)	Length (in.)
OK081R	36 x 7	5 1/2
OK082R	56 x 7	5 1/2
OK083R	75 x 7	5 1/2
OK084R	90 x 7	5 1/2



OK081R-OK084R

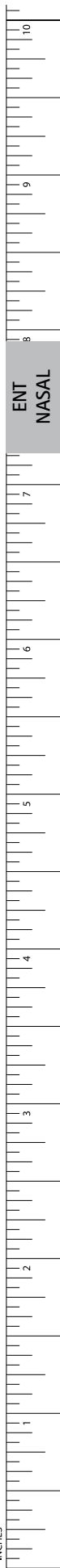
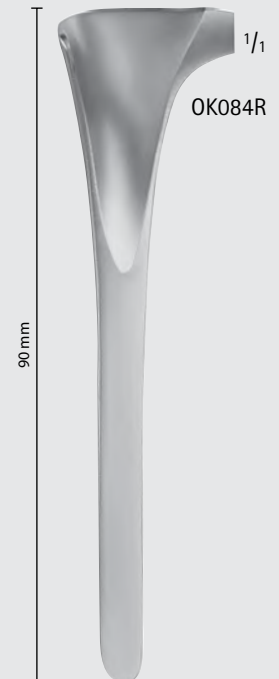
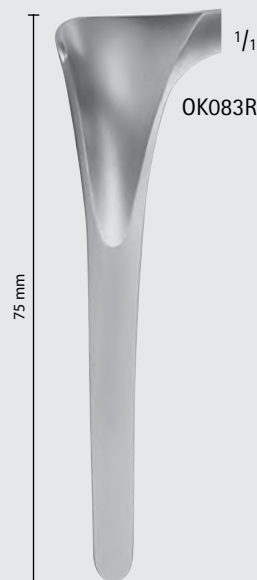
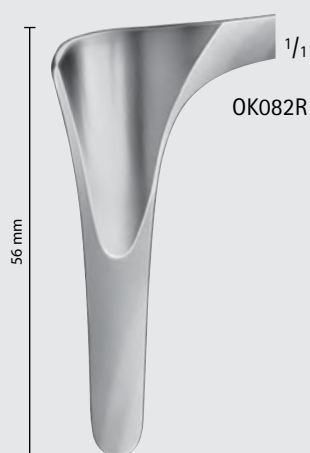
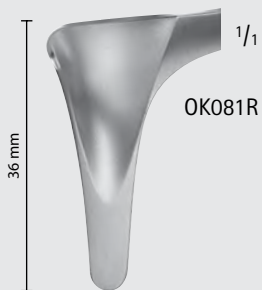

ENT-NASAL

Specula



OK091R-OK094R

KILLIAN Septum Speculum W/ Screw Joint

Catalog Number	Blade Size (mm)	Length (in.)
OK091R	36 x 7	5 3/4
OK092R	56 x 7	5 3/4
OK093R	75 x 7	5 3/4
OK094R	90 x 7	5 3/4

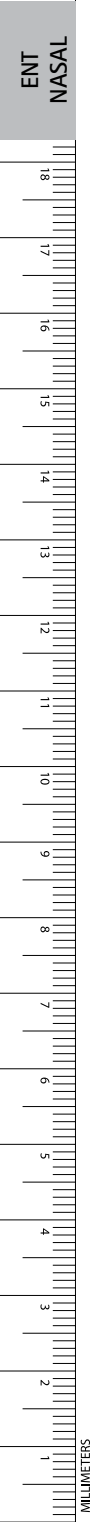
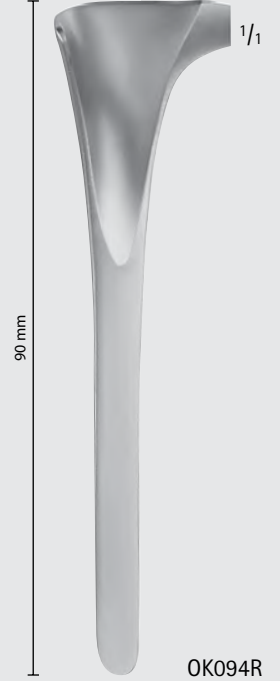
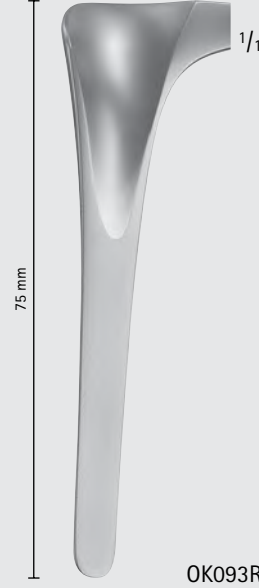
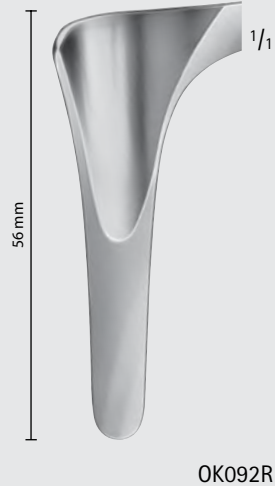
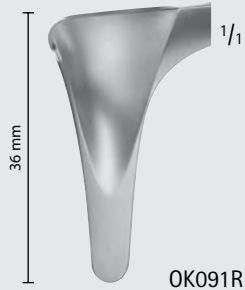

VIENNA Nasal Speculum

Catalog Number	Blade Size	Length (in.)
OK060R	SMALL	5 1/2
OK061R	MEDIUM	5 1/2
OK062R	LARGE	5 1/2

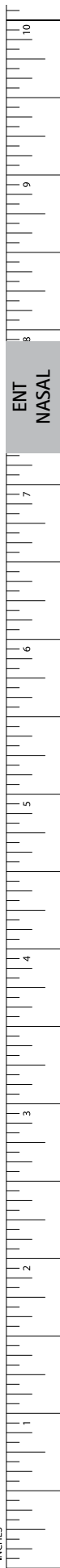
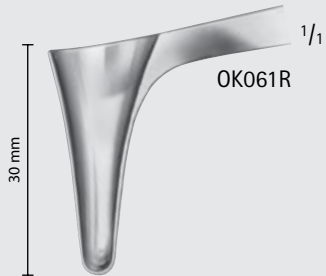
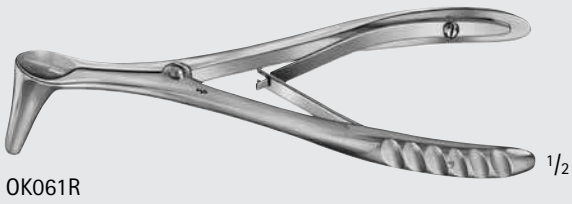
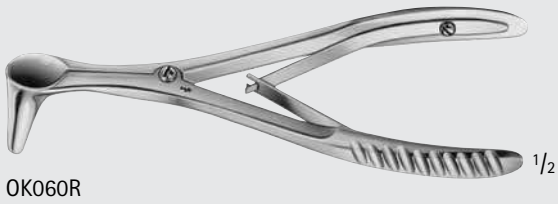

ENT-NASAL

Specula

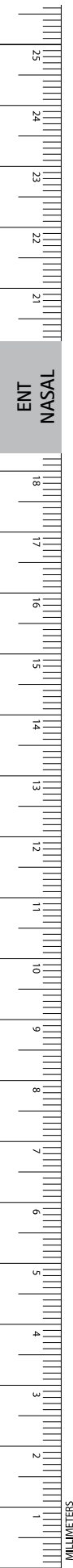
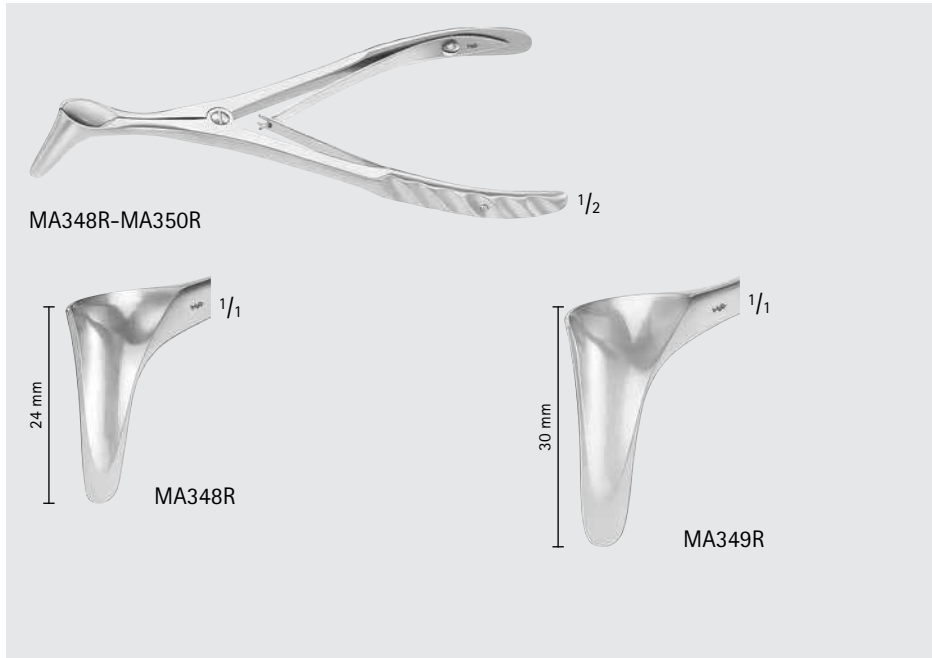
VIENNA Nasal Speculum (continued)

Catalog Number	Blade Size (mm)	Tip Size (mm)	Length (in.)
MA348R	24	1	5 1/4
MA349R	30	3	5 1/4
MA350R	34	4	5 1/4

MA348R-MA350R $1/2$

MA348R $1/1$ 24 mm

MA349R $1/1$ 30 mm

MA350R $1/1$ 34 mm

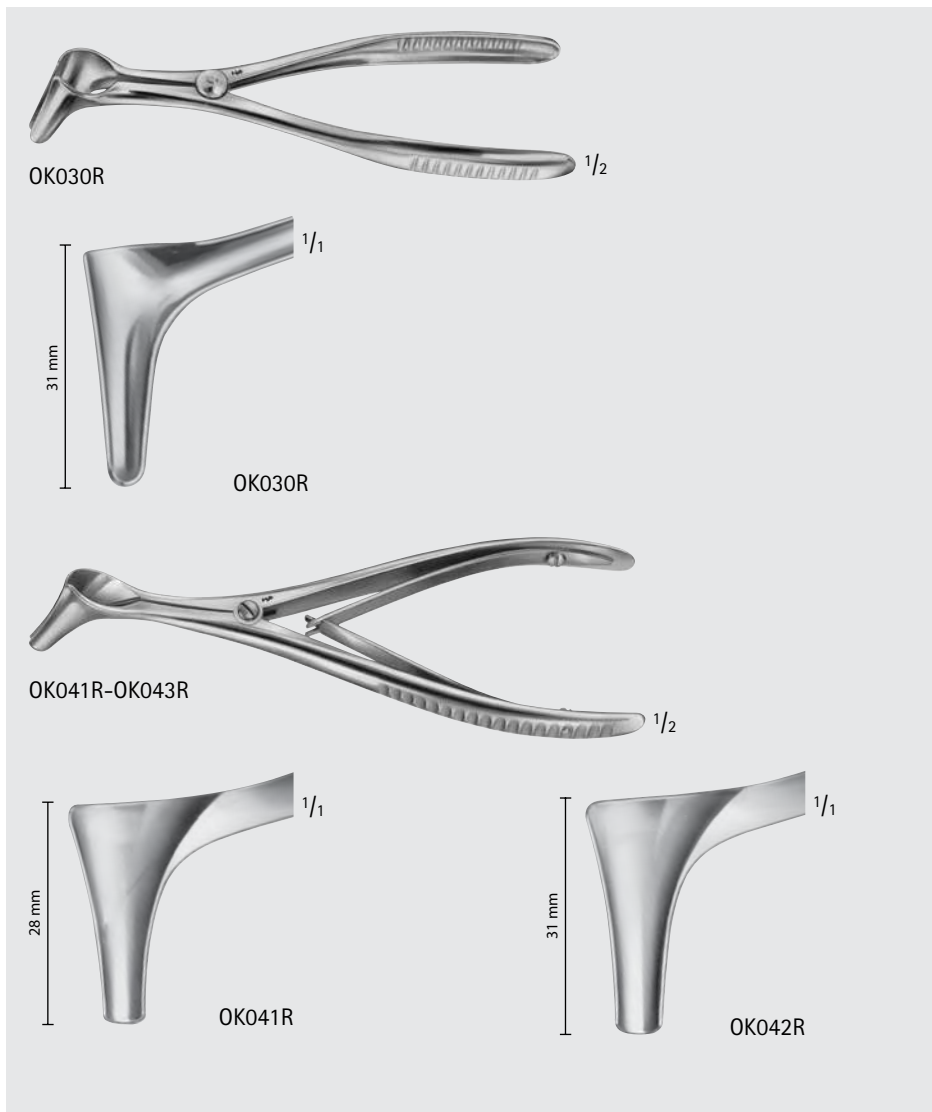

HARTMANN Nasal Speculum

Catalog Number	Blade Size	Length (in.)
OK030R	LIGHT	5 3/4
OK041R	SMALL	6 1/4
OK042R	MEDIUM	6 1/4
OK043R	LARGE	6 1/4

OK030R $1/2$

OK030R $1/1$ 31 mm

OK041R-OK043R $1/2$

OK041R $1/1$ 28 mm

OK042R $1/1$ 31 mm

OK043R $1/1$ 32 mm



OK047R-OK049R

HARTMANN-HALLE Nasal Speculum W/ Screw Joint

Catalog Number	Blade Size	Length (in.)
OK047R	SMALL	6 1/8
OK048R	MEDIUM	6 1/8
OK049R	LARGE	6 1/8

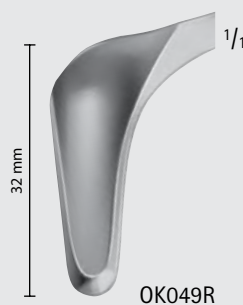
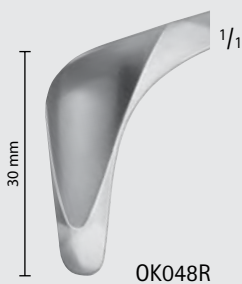
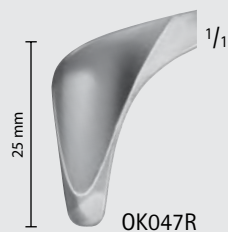

OK051R-OK052R

TIECK-HALLE Nasal Speculum W/ Screw Joint, Pediatric

Catalog Number	Blade Size	Length (in.)
OK051R	SMALL	5 1/4
OK052R	LARGE	5 1/4

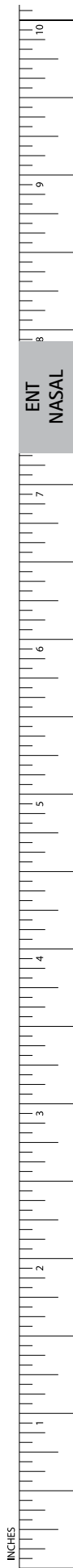

ENT-NASAL

Specula

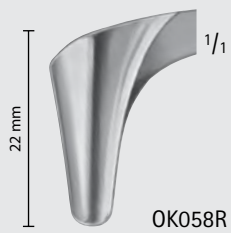

BECKMANN Nasal Speculum W/ Screw Joint, Pediatric

Catalog Number	Blade Size	Blade Shape	Length (in.)
OK053R	SMALL	LAT-CVD	5 1/2
OK058R	MEDIUM	LAT-CVD	6

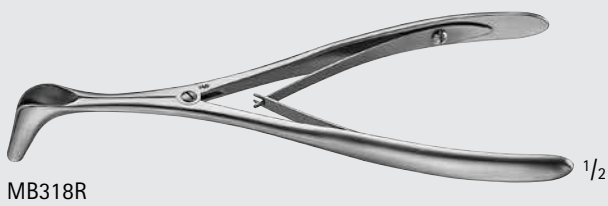

SONNENSCHN Nasal Speculum

Catalog Number	Blade Size	Length (in.)
MB318R	MEDIUM	6

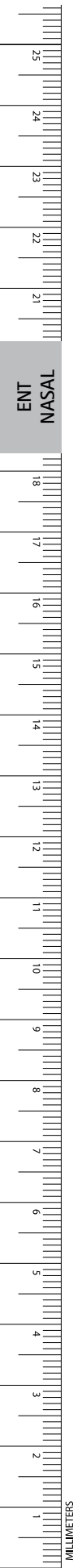



OK100R-OK102R

CUSHING-LANDOLT Transsphenoidal Speculum

Catalog Number	Blade Size (mm)	Length (in.)
OK100R	70 x 15	-
OK101R	90 x 15	-
OK102R	110 x 15	-
OK103R	SPREADER FOR OK100R-OK102R	8 1/4



OK103R



FF589R-FF591R

PAPAVERO-HARTMANN (CASPAR) Transsphenoidal Speculum, Slim, W/ Key

Catalog Number	Blade Size (mm)	Description	Length (in.)
FF589R	80 x 11	-	-
FF590R	90 x 13	-	-
FF591R	100 x 15	-	-
TE749R	-	HEX KEY	-
FF595R	34 x 9	SPREADER FOR FF589R-FF591R	5 1/2



TE749R



FF595R



FF595R

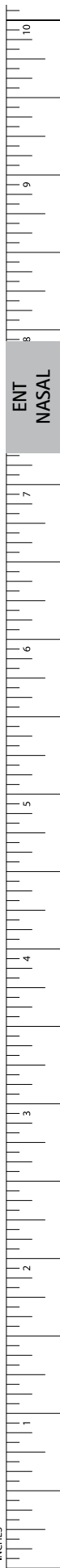

ENT-NASAL

Rasps, Files and Saws

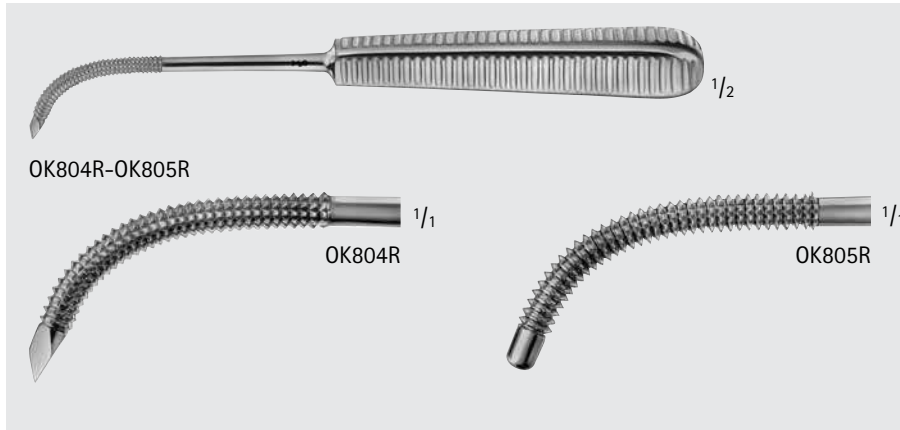
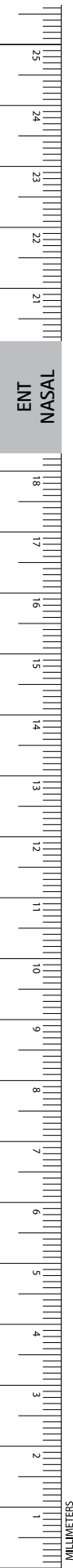

Antrum Rasp

Catalog Number	Tip	Length (in.)
OK804R	SHARP	7
OK805R	BLUNT	7



WEINER Antrum Rasp Trocar

Catalog Number	Tip	Length (in.)
MA421R	EXTRA SMALL, TROCAR	7 3/8

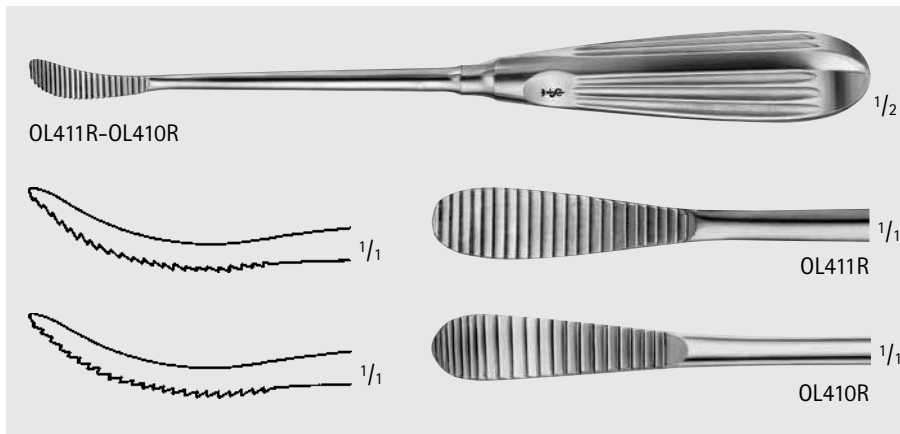

AUFRICHT Nasal Rasp

Catalog Number	Tip Size (mm)	Tip	Length (in.)
OL411R	9	DOWN-CUT	8 3/4
OL410R	9	UP-CUT	8 3/4

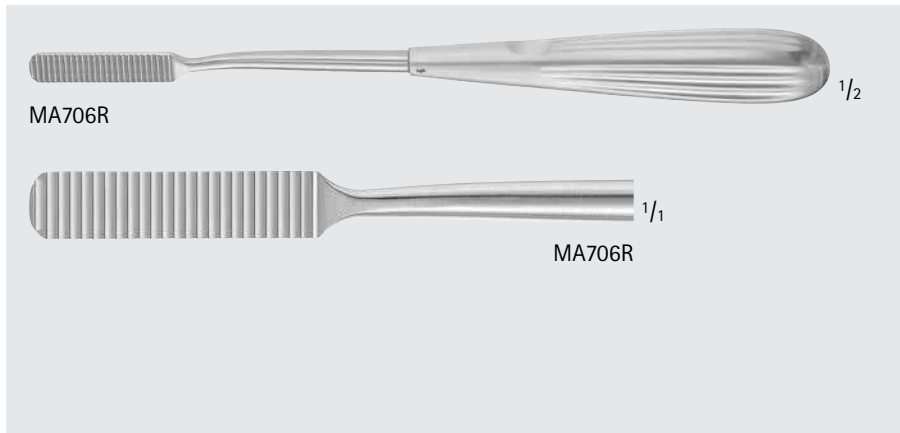

COTTLE Rasp

Catalog Number	Tip	Length (in.)
MA706R	DOWN CUTTING	8 1/4



MA417R-MA416R



MA417R



MA416R

Diamond Dust Rasp

Catalog Number	Tip	Length (in.)
MA417R	STR	7 3/8
MA416R	CVD	7 3/8



OL405R

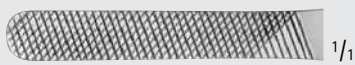

1/1

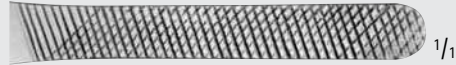

1/1

OL405R



OL406R



1/1



1/1

OL406R



MG584R

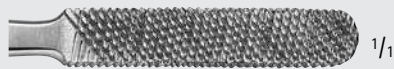
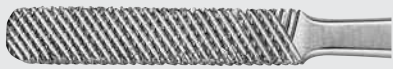

1/1

MG584R



MA418R

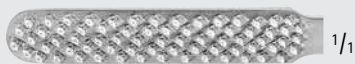

1/1



1/1

MA418R

FOMON Bone Rasp, Double Ended

Catalog Number	Tip Size (mm)	Tip	Length (in.)
OL405R	6.5 / 7.5	X-SERR Fine/Coarse	8 1/2
OL406R	6.5 / 7.5	Fine/Coarse	8 1/2
MG584R	8/8	FLAT, CONVEX FINE, COARSE	8 1/2
MA418R	7.5 / 7.5	Coarse/ Xtra-Coarse	8 3/8



OL412R



1/1



1/2

OL412R

GALLAHER File Rasp, Coarse

Catalog Number	Tip Size (mm)	Length (in.)
OL412R	6.5	7 1/2

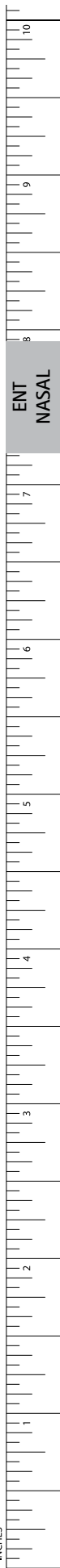

ENT-NASAL

Rasps, Files and Saws



OL448R



OL451R

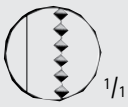

OL452R

JOSEPH Nasal Saw, Bayonet

Catalog Number	Blade Shape	Length (in.)
OL448R	STR	7 3/4
OL451R	CVD RIGHT	7 3/4
OL452R	CVD LEFT	7 3/4



OL401R-OL403R



OL401R



OL403R

JOSEPH Nasal Saw

Catalog Number	Tip	Tip Size (mm)	Length (in.)
OL401R	FINE-SERR	7.5	6 1/2
OL403R	COARSE-SERR	9	6 1/2



OL408R-OL409R

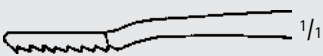

OL408R



OL409R

LEWIS Bone Rasp

Catalog Number	Tip	Tip Size (mm)	Length (in.)
OL408R	FINE-SERR DOWN-STROKE	8	6 7/8
OL409R	COARSE-SERR DOWN-STROKE	8	6 7/8

ENT
NASAL

MILLIMETERS

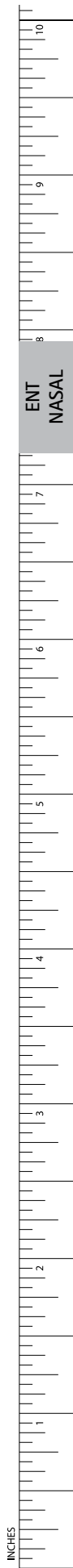

MB110R



MB110R

MALTZ-ANDERSON Nasal Rasp

Catalog Number	Tip Size (mm)	Length (in.)
MB110R	5.7	6 1/2



OL407R

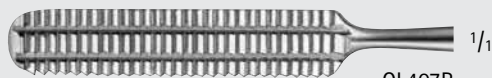

OL407R

MALTZ Bone Rasp

Catalog Number	Tip Size (mm)	Tip	Length (in.)
OL407R	9	DOWN-STROKE	6 1/2
MA419R	33	DOWN-STROKE	6 1/2
MA420R	33	UP STROKE	6 1/2



MA419R



MA419R



MA420R



MA420R



MB330R



MB330R

PARKES Nasal Rasp

Catalog Number	Tip Size (mm)	Length (in.)
MB330R	8	7 7/8

ENT-NASAL

Chisels and Gouges

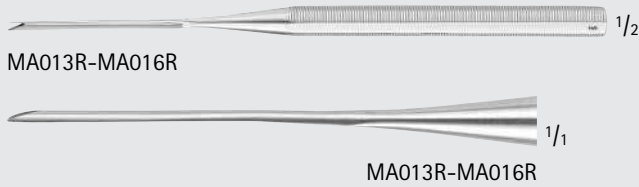

BALLENGER Chisel, V-shaped

Catalog Number	Tip Size (mm)	Length (in.)
MA013R	2	5 7/8
MA014R	4	5 7/8
MA016R	8	5 7/8



BALLENGER Septum Gouge

Catalog Number	Tip Size (mm)	Length (in.)
OL318R	6	6

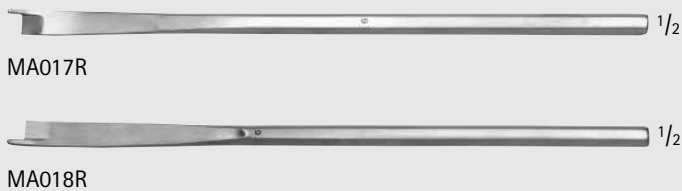

CONVERSE Guarded Chisel

Catalog Number	Tip Size (mm)	Blade Shape	Length (in.)
MA017R	6	CVD RIGHT	7 1/2
MA018R	6	CVD LEFT	7 1/2

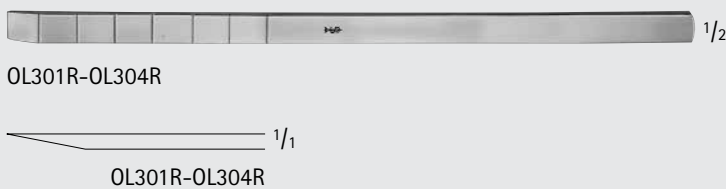

COTTLE Chisel W/ Depth Marks

Catalog Number	Tip Size (mm)	Length (in.)
OL301R	4	7
OL302R	7	7
OL303R	9	7
OL304R	12	7

ENT
NASAL

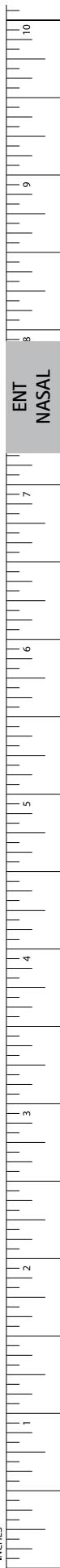

OL311R

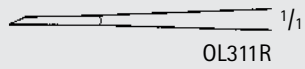

OL311R



OL314R



OL314R

FREER Chisel

Catalog Number	Tip Size (mm)	Blade Shape	Length (in.)
OL311R	4	STR	6 1/4
OL314R	4	CVD	6 1/4



FF610R

PAPAVERO Bayonet Chisel

Catalog Number	Tip Size (mm)	Length (in.)
FF610R	4	8 3/4



OL316R

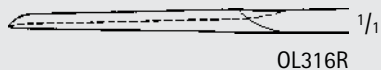

OL316R

FREER Septum Gouge

Catalog Number	Tip Size (mm)	Length (in.)
OL316R	4	6



OL336R



OL336R

KILLIAN Septum Gouge, Bayonet

Catalog Number	Tip Size (mm)	Length (in.)
OL336R	6	6 3/4



MB108R, MA629R



MB108R, MA629R

PARKES Hump Gouge, Double Guard

Catalog Number	Tip Size (mm)	Blade Shape	Length (in.)
MB108R	10	STR	7
MA629R	6	STR	7

ENT-NASAL

Osteotomes



MA382R

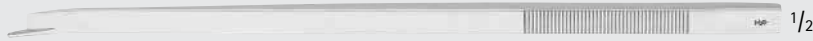

MA381R

ANDERSON-NEIVERT Osteotome

Catalog Number	Tip Size (mm)	Blade Shape	Length (in.)
MA382R	5	CVD RIGHT	8
MA381R	5	CVD LEFT	8



MB590R-MB594R

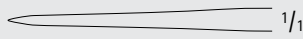

MB590R-MB594R

CHERRY Osteotome

Catalog Number	Tip Size (mm)	Length (in.)
MB590R	3	8
MB591R	4	8
MB592R	5	8
MB593R	6	8
MB594R	7	8



MA369R

CINELLI Osteotome, Double Guard

Catalog Number	Tip Size (mm)	Blade Shape	Length (in.)
MA369R	10	CVD	6 1/8

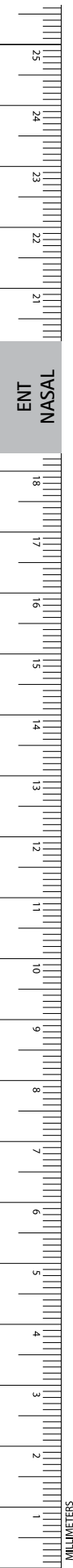

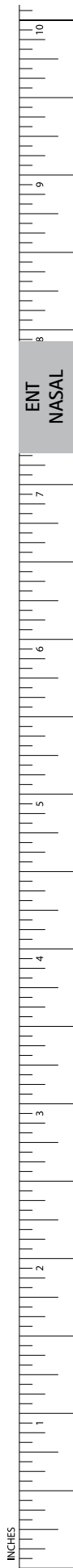

OL326R-OL329R



OL326R



OL327R



OL328R



OL329R

CINELLI Osteotome, Double Guard

Catalog Number	Tip Size (mm)	Blade	Length (in.)
OL326R	10	STR	6 1/4
OL327R	12	STR	6 1/4
OL328R	14	STR	6 1/4
OL329R	16	STR	6 1/4



MB398R-MB403R



MB398R-MB403R

CONVERSE Osteotome

Catalog Number	Tip Size (mm)	Length (in.)
MB398R	2	7
MB399R	4	7
MB400R	6	7
MB401R	8	7
MB402R	10	7
MB403R	12	7

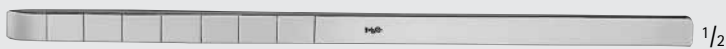

OL294R-OL300R

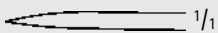

OL294R-OL300R

COTTLE Osteotome, W/ Depth Mark

Catalog Number	Tip Size (mm)	Length (in.)
OL294R	4	7
OL296R	6	7
OL298R	8	7
OL299R	10	7
OL300R	12	7

ENT-NASAL

Osteotomes

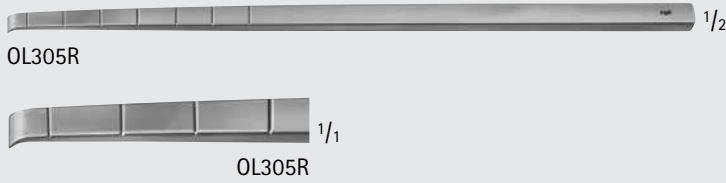

COTTLE Osteotome, Curved

Catalog Number	Tip Size (mm)	Length (in.)
OL305R	6	7

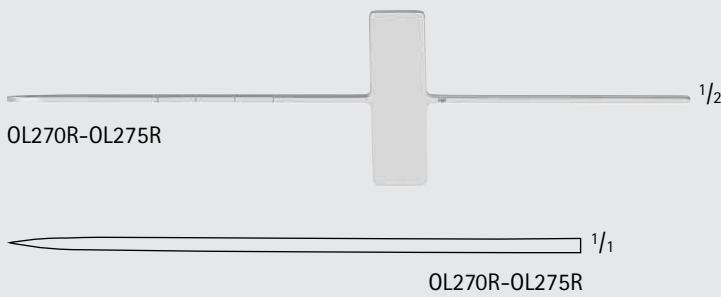

COTTLE Osteotome W/ Cross Bar

Catalog Number	Tip Size (mm)	Blade Shape	Length (in.)
OL270R	2	STR	7
OL271R	4	STR	7
OL272R	6	STR	7
OL273R	7	STR	7
OL274R	9	STR	7
OL275R	12	STR	7



TESSIER Osteotome

Catalog Number	Tip Size (mm)	Blade Shape	Length (in.)
OL360R	2.5	STR	6 1/4
OL361R	3.5	STR	6 1/4
OL362R	5	STR	6 1/4
OL366R	7	STR	6 1/4
OL368R	10	STR	6 1/4
OL370R	14	STR	6 1/4
OL371R	18	STR	6 1/4
OL363R	5	CVD	6 1/4
OL367R	7	CVD	6 1/4
OL369R	10	CVD	6 1/4

ENT
NASAL

1
2
3
4
5
6
7
8
9
10
11
12
13
14
15
16
17
18
19
20
21
22
23
24
25
MILLIMETERS

DAUTREY Osteotome

Catalog Number	Tip Size (mm)	Blade Shape	Length (in.)
OL344R	4	STR	6 3/4
OL345R	6	STR	6 3/4
OL346R	6	SLIGHTLY CVD	6 3/4
OL347R	6	STRONGLY CVD	6 3/4
OL348R	8	STR	6 3/4
OL349R	8	SLIGHTLY CVD	6 3/4
OL350R	8	STRONGLY CVD	6 3/4

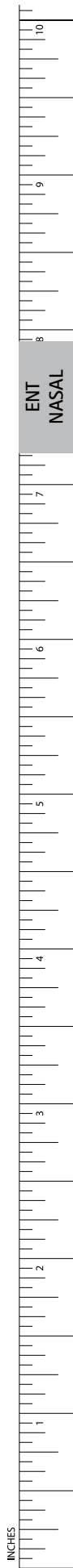
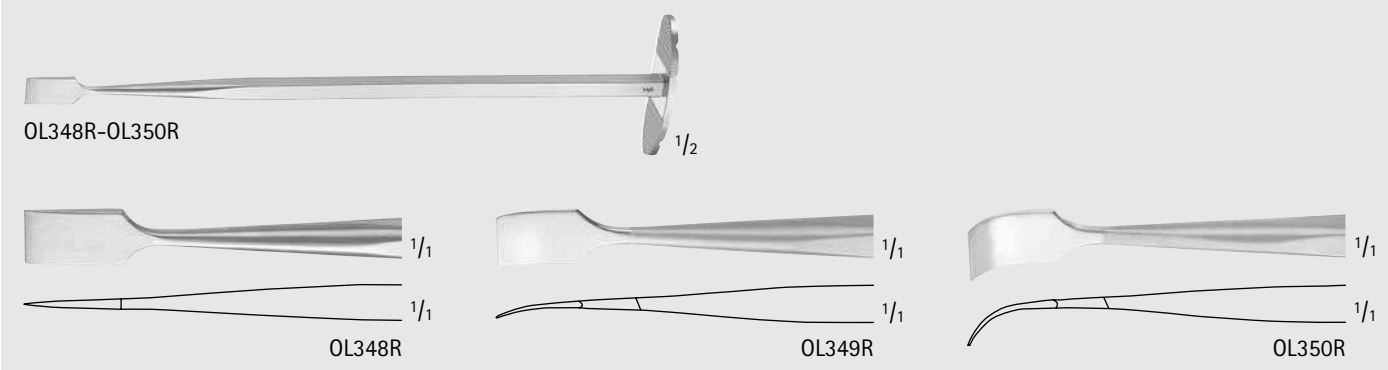
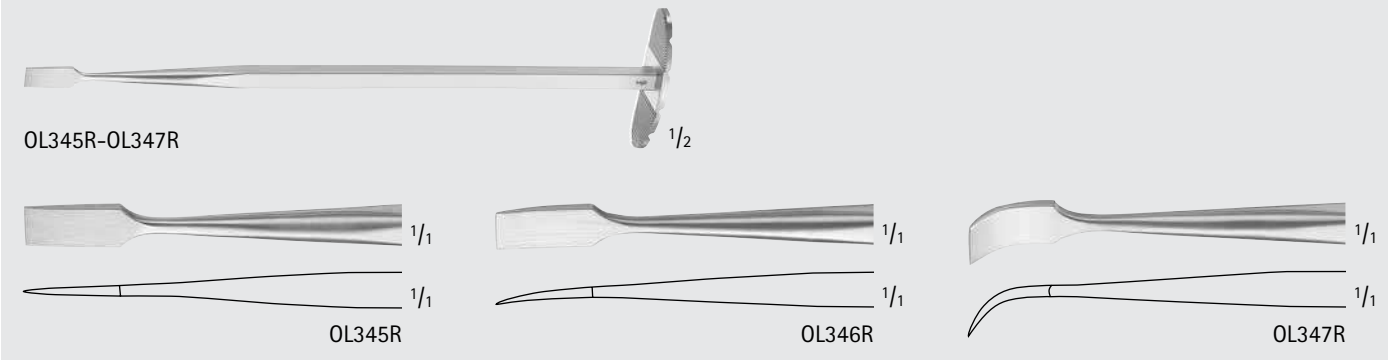
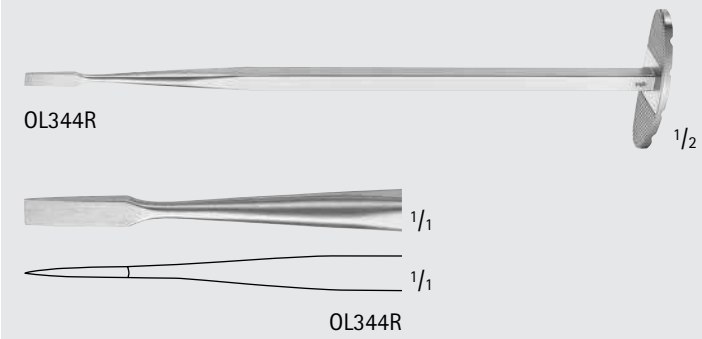

ENT-NASAL

Osteotomes



OL338R-OL339R

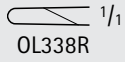

OL338R

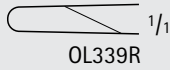

OL339R

FOMON Osteotome, Single Guard

Catalog Number	Tip Size (mm)	Length (in.)
OL338R	5	6 3/4
OL339R	8	6 3/4



OL323R



OL321R



OL322R

MASING Osteotome, Single Guard

Catalog Number	Blade	Length (in.)
OL323R	STR	6 7/8
OL321R	LEFT-CVD	6 7/8
OL322R	RIGHT-CVD	6 7/8



MA332R



MA333R



MA334R

OBEWESGESER Nasal Osteotome

Catalog Number	Tip Size (mm)	Length (in.)
MA332R	6	7 1/4
MA333R	8	7 1/4
MA334R	4	7 1/2

ENT
NASAL



MB404R-MB373R



MB404R-MB373R

Osteotome W/ Hexagonal Handle

Catalog Number	Tip Size (mm)	Length (in.)
MB404R	2	6 1/4
MB405R	3	6 1/4
MB406R	4	6 1/4
MB407R	5	6 1/4
MB408R	6	6 1/4
MB409R	7	6 1/4
MB410R	8	6 1/4
MB411R	9	6 1/4
MB412R	10	6 1/4
MB413R	11	6 1/4
MB373R	12	6 1/4



MA384R

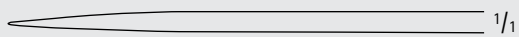

MA384R

RUBIN Osteotome, W/ Finger Grip

Catalog Number	Tip Size (mm)	Length (in.)
MA384R	14	6 1/4
MB388R	10	6 1/2
MB389R	14	6 1/2



MB388R



MB389R

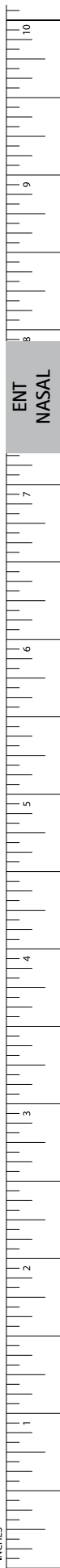

ENT-NASAL

Applicators and Probes

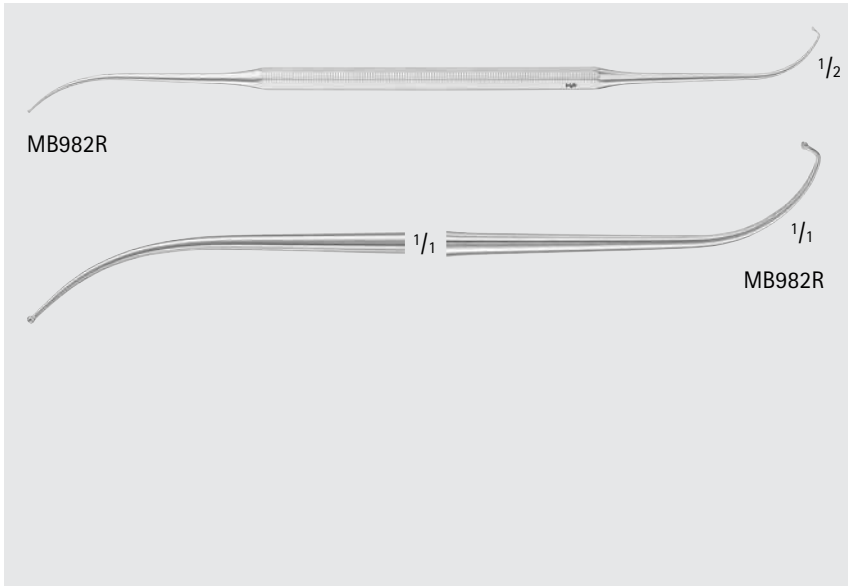
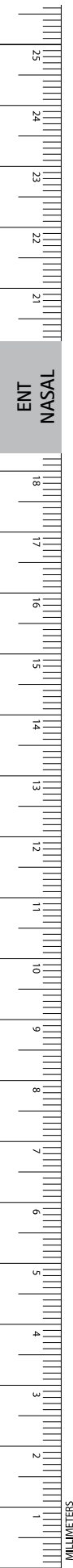

Frontal Ostium Seeker Probe, Double Ended

Catalog Number	Tip	Length (in.)
MB982R	CVD RIGHT, ANG	8 1/4

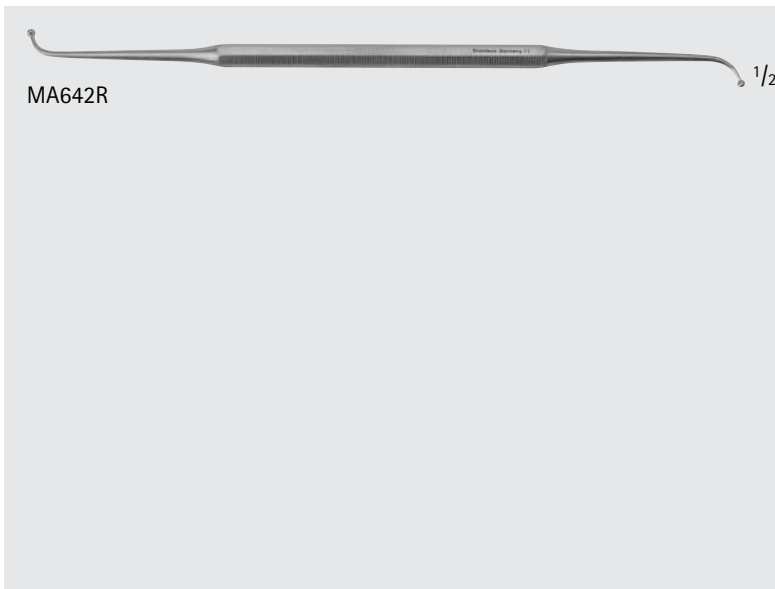

Maxillary Sinus Seeker Probe, Double Ended

Catalog Number	Tip	Tip Size (mm)	Length (in.)
MA642R	BALL	1.5 / 2	7 1/2

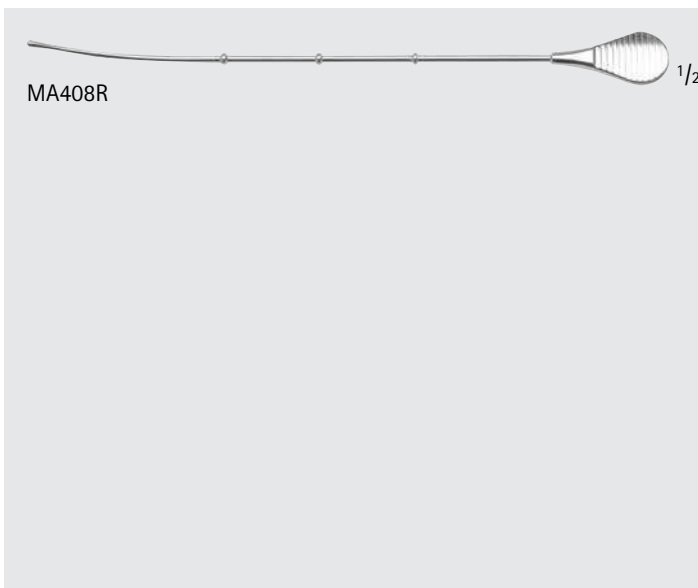

SKILLERN Sinus Probe

Catalog Number	Tip	Length (in.)
MA408R	MALLEABLE W/ BEADS AT 50, 70, AND 90 MM	6 3/4



OL354R-OL356R

1/2



OL354R

1/1



OL355R

1/1



OL356R

1/1

BALLEGER Swivel Knife, Bayonet

Catalog Number	Blade Size (mm)	Length (in.)
OL354R	4 x 3	8 1/4
OL355R	5 x 4	8 1/4
OL356R	6 x 5	8 1/4



MA205R-MA207R

1/2



MA205R-MA207R

1/1



MB119R-MB118R

1/2



MB119R

1/1



MB118R

1/1

BALLEGER Swivel Knife, Straight

Catalog Number	Blade Width (mm)	Length (in.)
MA205R	3	7 1/2
MB119R	3	7 3/4
MB118R	4	7 3/4
MA207R	5	7 1/2



OL109R

1/2



OL109R

1/1

CONVERSE Septum Knife, Button End

Catalog Number	Blade	Length (in.)
OL109R	CVD	6



OL113R

1/2



OL113R

1/1

COTTLE Septum Knife, Round End

Catalog Number	Blade	Length (in.)
OL113R	STR	5 1/2

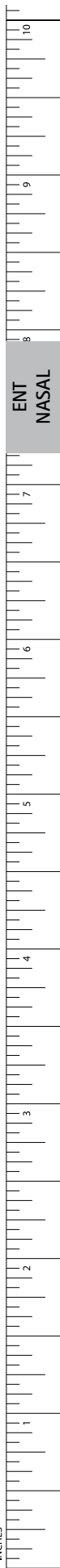



ENT-NASAL

Knives

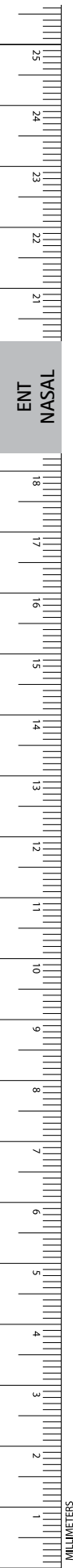

OL120R



OL120R



MA212R



MA212R



MA211R

FREER Septum Knife

Catalog Number	Blade Shape	Blade Size (mm)	Length (in.)
OL120R	"D" SHAPED	3	6
MA212R	"D" SHAPED	3	6 1/8
MA211R	ANG	5 x 8	7



OL111R



OL111R



OL107R



OL107R

JOSEPH Knife, Button End

Catalog Number	Tip	Length (in.)
OL111R	STR	5 1/2
OL107R	CVD	6 7/8



OL102R-OL104R



OL102R



OL104R

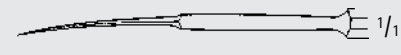

OL104R

JOSEPH Knife, Double Edge

Catalog Number	Blade	Blade Size (mm)	Length (in.)
OL102R	STR	5 x 23	5 3/4
OL104R	CVD	5 x 23	5 3/4

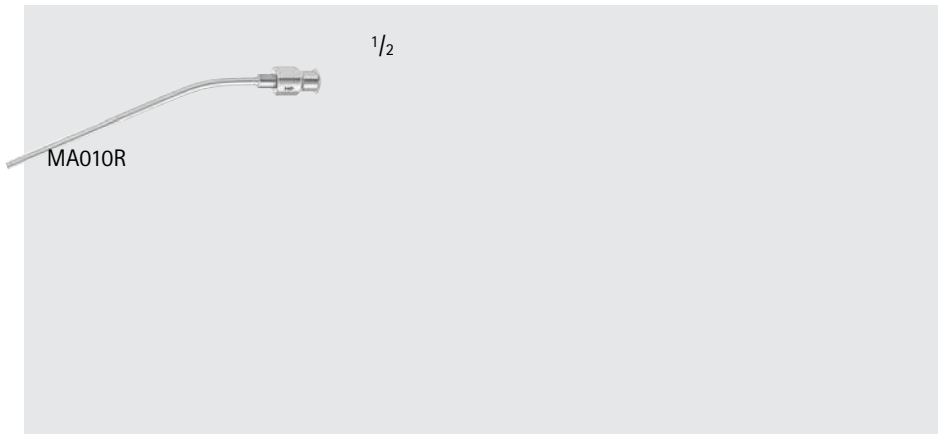

MA010R

1/2

Suction Tube, Angled

Catalog Number	Tip	Tip Size (Gauge)	Length (in.)
MA010R	ANG	13	3

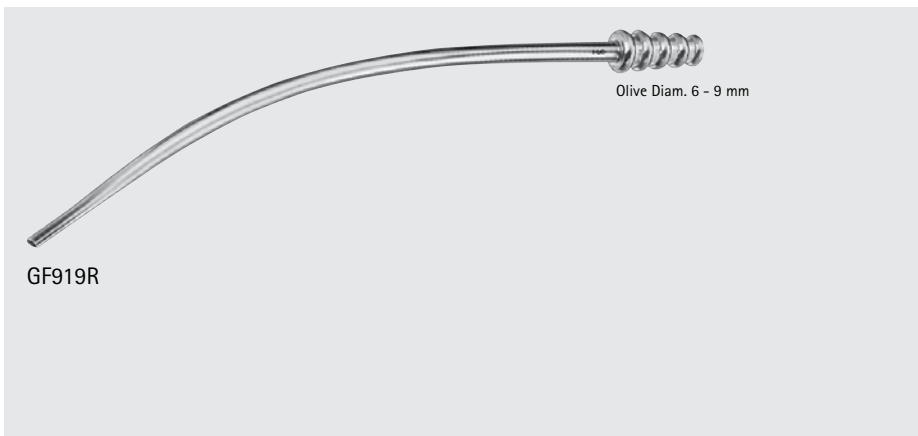

GF919R

Olive Diam. 6 - 9 mm

Nasal Suction Tube W/ Luer Hub, Tapered

Catalog Number	Tip Size (mm)	Length (in.)
GF919R	5	7

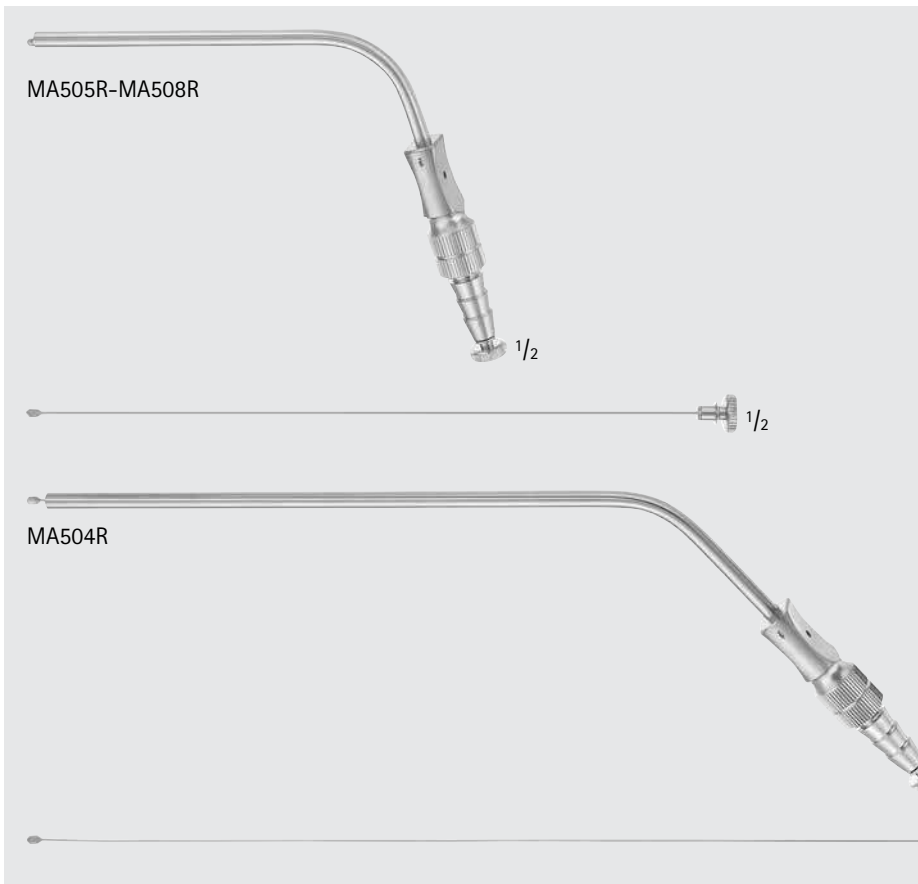

MA505R-MA508R

1/2

1/2

MA504R

1/2

1/2

FERGUSON-FRAZIER Suction Tube

Catalog Number	Tip	Tip Size (FR)	Working Length (in.)	Length (in.)
MA505R	ANG	8	7 7/8	10 1/4
MA506R	ANG	10	7 7/8	10 1/4
MA508R	ANG	14	4	6 1/2
MA504R	ANG	14	5 7/8	8

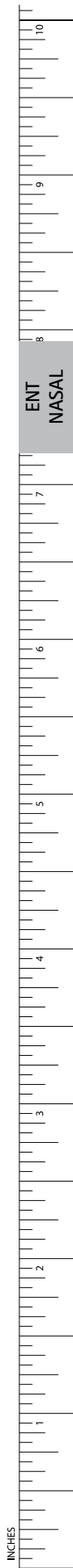

ENT-NASAL

Suction and Irrigation

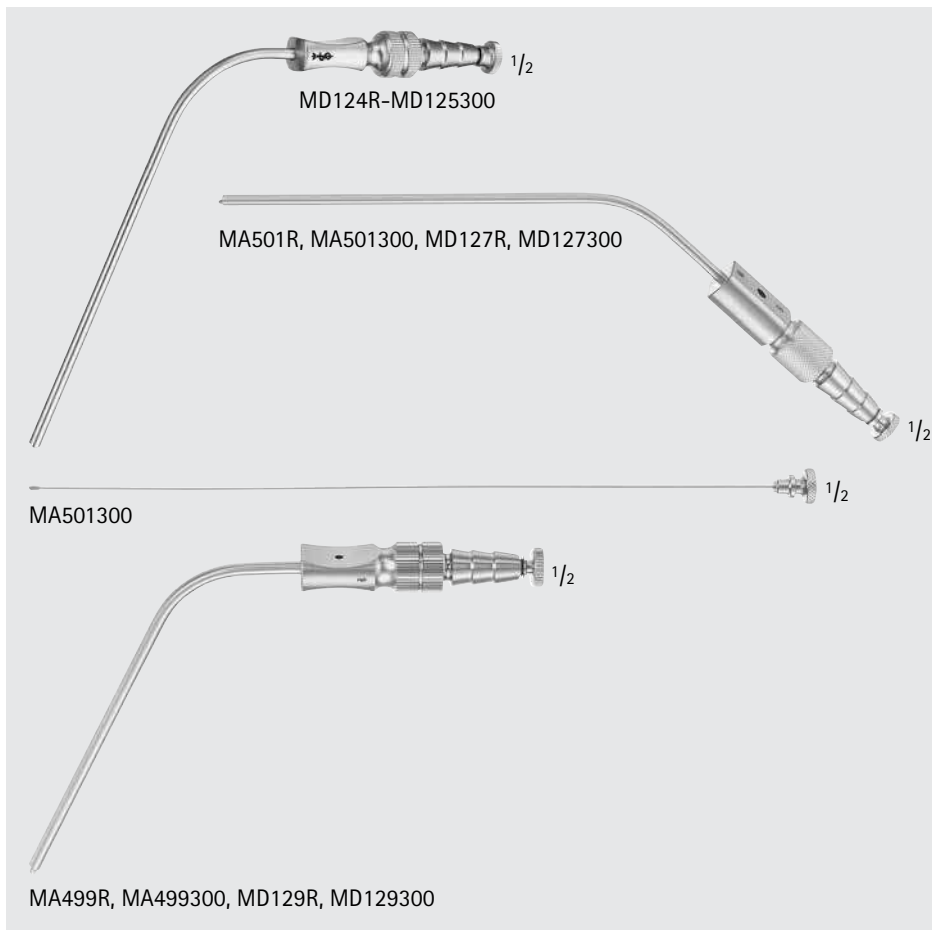
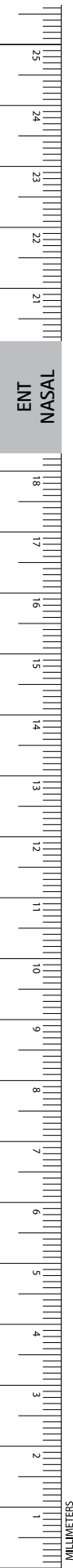

FRAZIER Suction Tube

Catalog Number	Tip Size (FR)	Description	Working Length (in.)
MD124R	7		4 1/4
MD124300	7	SUCTION STYLET W/ OLIVE TIP FOR MD124R	
MD125R	8		4 1/4
MD125300	8	SUCTION STYLET W/ OLIVE TIP FOR MD125R	
MA501R	9		4 1/4
MA501300		SUCTION STYLET W/ OLIVE TIP FOR MA501R	
MD127R	10		4 1/4
MD127300	10	SUCTION STYLET W/ OLIVE TIP FOR MD127R	
MA499R	11		4 1/4
MA499300	11	SUCTION STYLET W/ OLIVE TIP FOR MA499R	
MD129R	12		4 1/4
MD129300	12	SUCTION STYLET W/ OLIVE TIP FOR MD129R	

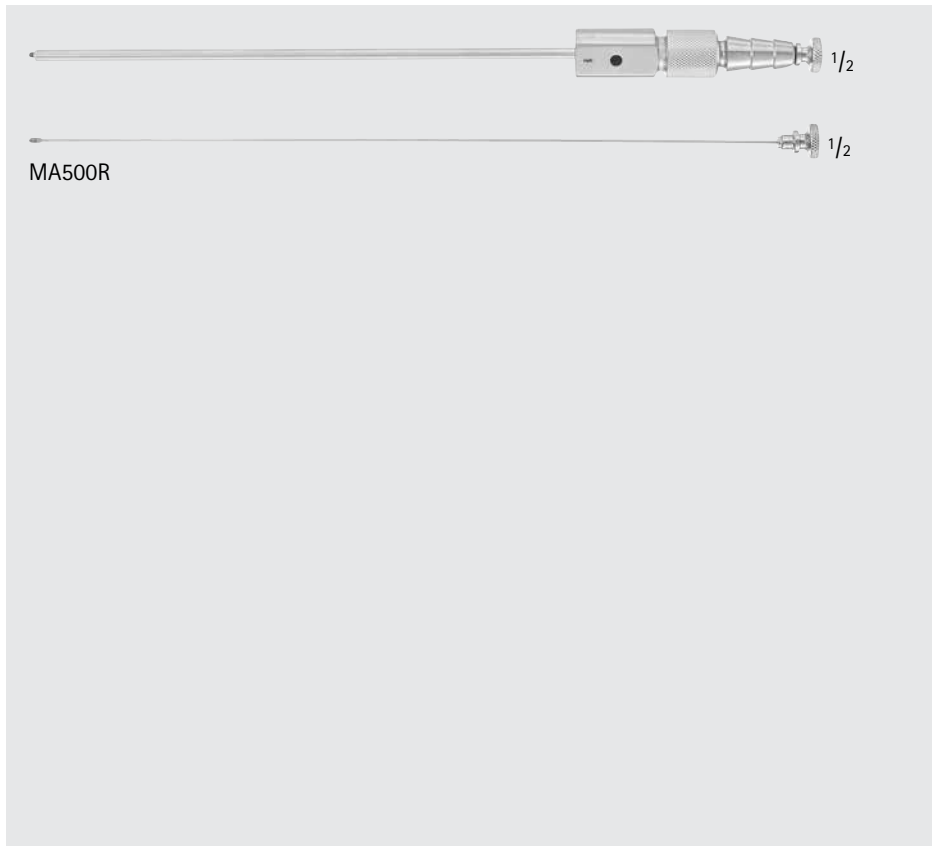

FRAZIER Suction Tube, Straight

Catalog Number	Tip	Working Length (in.)	Length (in.)
MA500R	STR	5 1/2	6 7/8



FRAZIER Suction Tube W/ Luer Hub

Catalog Number	Tip Size (FR)	Length (in.)
GF923R	9	7
GF925R	15	7

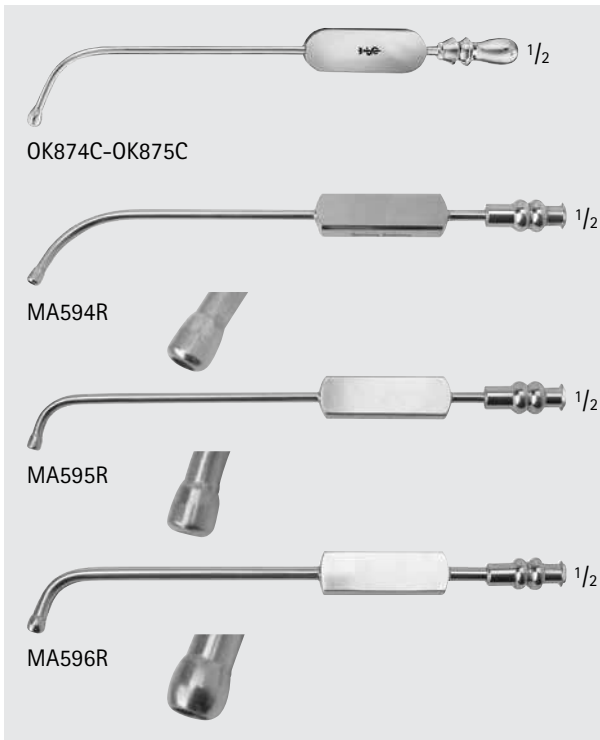

EICKEN Antrum Suction Tube, Bulbous

Catalog Number	Tip	Diameter (mm)	Length (in.)
OK874C	SMALL	2.5	5 1/8
OK875C	LARGE	3	5 1/8
MA594R	LONG CURVE	3	5 5/8
MA595R	SHORT CURVE	3	5 5/8
MA596R	SHORT CURVE	4	5 5/8

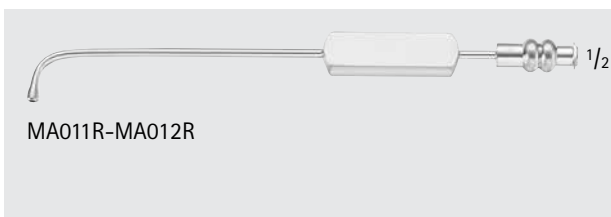

KILLIAN Antrum Cannula

Catalog Number	Tip Size	Tip Size (#)	Length (in.)
MA011R	SMALL	1	5
MA012R	LARGE	2	5

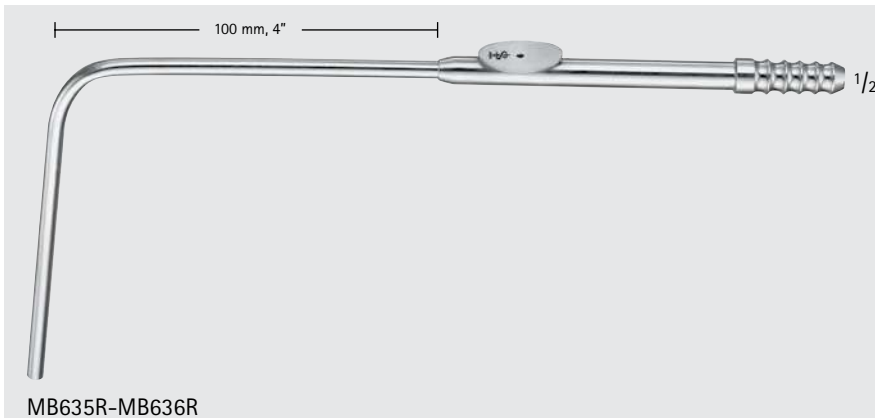

SACHS Suction Tube

Catalog Number	Tip Size	Length (in.)
MB635R	SMALL	8 1/2
MB636R	LARGE	8 1/2

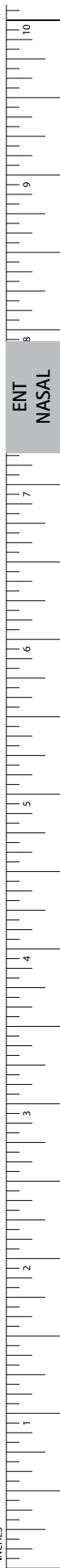

ENT-NASAL

Suction and Irrigation



OL168R

Olive Diam. 6 - 10 mm

GORNEY Suction Dissector, Elevator

Catalog Number	Tip Size (mm)	Length (in.)
OL168R	6-10	7
MA142R	3	8 1/2

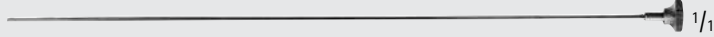

MA142R



OK900

HAJEK Irrigating Cannula

Catalog Number	Diameter (mm)	Length (in.)
OK900	3.5	6 1/2



MA607R

HOUSE Cutoff Adapter

Catalog Number	Tip	Tip Size (mm)
MA607R	TUBING END	4

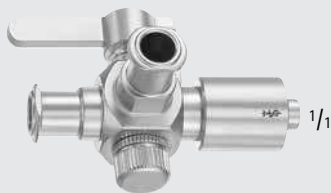

MA716R

Stopcock Luer Adapter, Female to Male

Catalog Number	Description
MA716R	FEMALE TO MALE LUER LOCK W/ FEMALE RIGHT



MA715R

Luer Adapter

Catalog Number	Description
MA715R	MALE LUER LOCK-TO-HOSE

ENT
NASAL



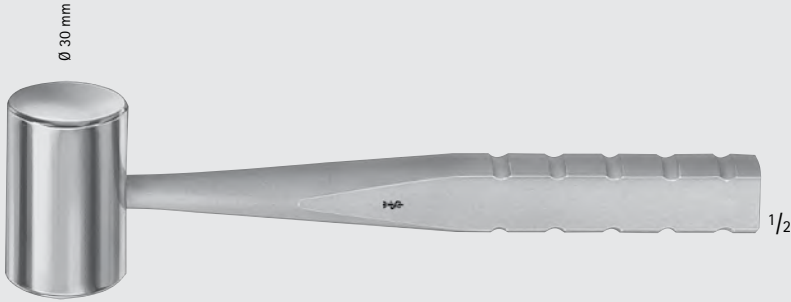

Ø 30 mm

FLO38R

1/2

COTTLE Mallet, Flat/Round, 235gr

Catalog Number	Diameter (mm)	Length (in.)
FLO38R	30	7 1/4

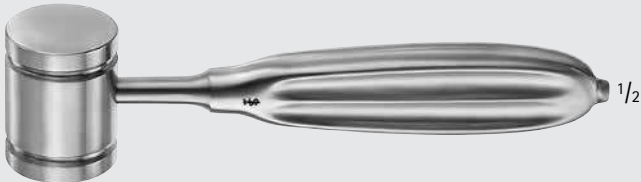

MB303R

1/2

CRANE Mallet

Catalog Number	Diameter (mm)	Length (in.)
MB303R	32	6 1/4



Ø 25 mm

DF114R

1/2

Mallet, 155gr

Catalog Number	Diameter (mm)	Length (in.)
DF114R	25	7 1/2

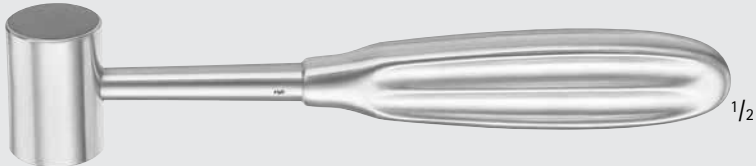

MA239R

1/2

Lead Mallet

Catalog Number	Diameter (mm)	Handle	Description	Length (in.)
MA239R	25	LARGE	LEAD FILLED	7 1/16



ENT-NASAL

Mallets, Hammers and Tamps

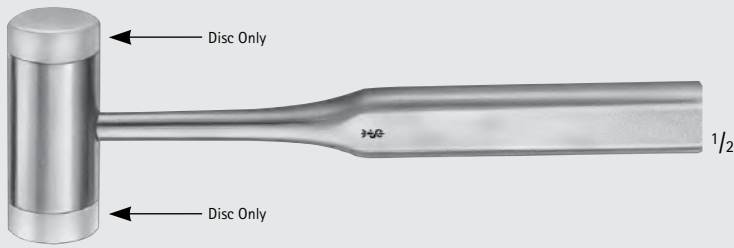

FL036R-FL037

Mallet W/ Removable Nylon Discs, 135gr

Catalog Number	Description	Diameter (mm)	Length (in.)
FL036R	COMPLETE	25	7 1/4
FL037	NYLON SPARE DISCS, F/FL036R, 2/SET	25	

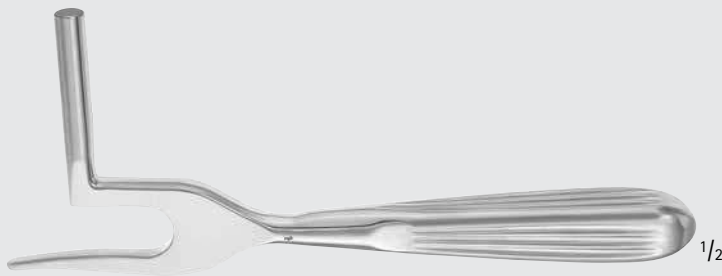

MA338R

QUISLING Intranasal Hammer

Catalog Number	Length (in.)
MA338R	6 3/4



FL093R-FL096R

Bone Tamp

Catalog Number	Diameter (mm)	Length (in.)
FL093R	3	6 1/4
FL094R	5	6 1/4
FL095R	7	6 1/4
FL096R	9	6 1/4



FL093R



FL094R



FL095R



FL096R

ENT
NASAL

MILLIMETERS



MA589R-MA593R



FK651R-FK654R

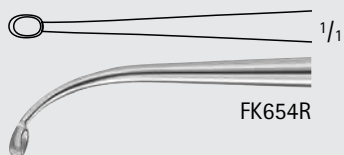

Antrum Curette

Catalog Number	Tip	Tip Size (mm)	Length (in.)
MA589R	OBLONG	-	7 1/2
MA588R	OVAL CUP	7 x 11	7 1/2
MA592R	OVAL CUP	8 x 11	7 1/2
MA593R	OVAL CUP	9 x 13	7 1/2
FK651R	OVAL CUP, ANG	9.5 x 4	7 1/2
FK652R	OVAL CUP, ANG	6 x 3	7 1/2
FK653R	55° CVD	6 x 3	7 1/2
FK654R	90° CVD	6 x 3	7 1/2
MA591R	BACKWARD CUTTING	7 x 10	7 1/2
MA590R	FORWARD CUTTING	7 x 10	7 1/2

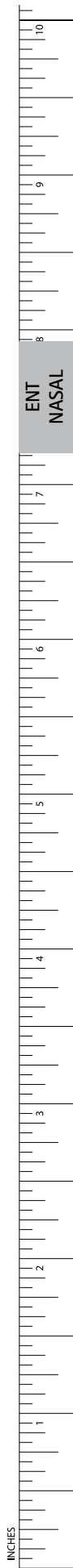

ENT-NASAL

Curettes



FK817R

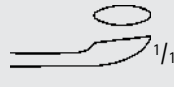

FK817R

BARTH Bone Curette, Double Ended

Catalog Number	Tip Size (mm)	Length (in.)
FK817R	2.3 x 6.0 / 2.7 x 7.0	7



OK811R-OK816R



OK811R



OK812R



OK813R



OK814R



OK815R

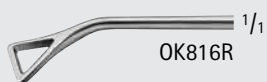

OK816R

COAKLEY Antrum Curette

Catalog Number	Blade	Size (#)	Length (in.)
MB799R	-	SET OF 6 INCLUDES OK811R-OK816R	-
OK811R	SLIGHT ANG	1	6 3/4
OK812R	45°	2	6 3/4
OK813R	REV ANG	3	6 3/4
OK814R	SLIGHT ANG	4	6 3/4
OK815R	45°	5	6 3/4
OK816R	45°	6	6 3/4

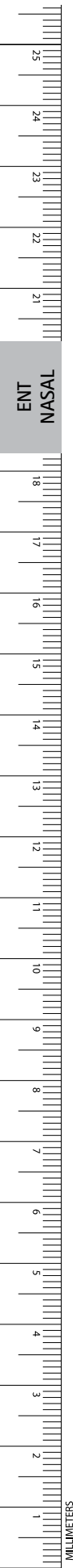

ENT
NASAL

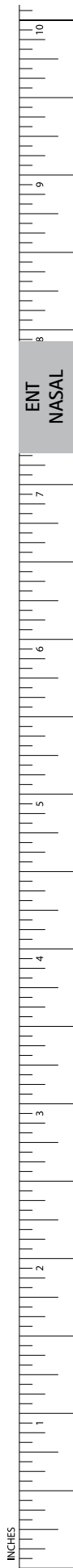

FK813R

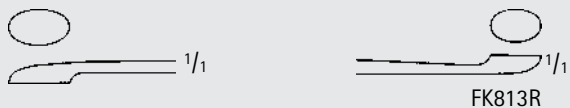

JACOBSON Bone Curette, Double Ended

Catalog Number	Tip Size (mm)	Length (in.)
FK813R	4.3 x 6.5 / 4.5 x 8.5	5 1/2



FK803R

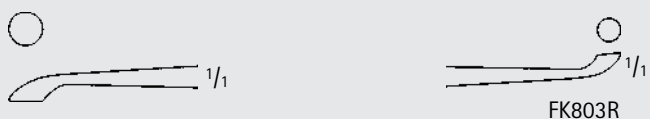

JANSEN Bone Curette, Double Ended

Catalog Number	Diameter (mm)	Length (in.)
FK803R	4.3 / 3.6	6 1/4



FK840R

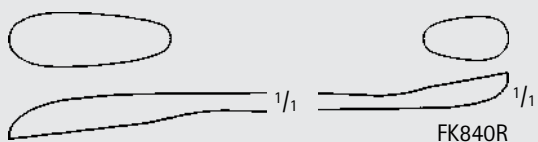

VOLKMANN Bone Curette, Double Ended

Catalog Number	Tip Size (mm)	Length (in.)
FK840R	7.5 x 21.0 / 6.0 x 11.0	5 1/8
FK842R	7.5 x 21.0 / 6.0 x 11.0	6 3/4



FK842R

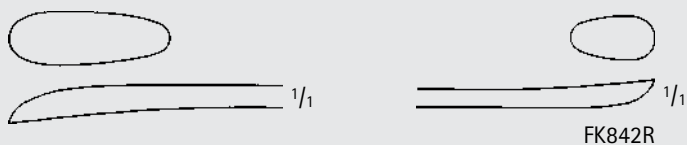

FK814R

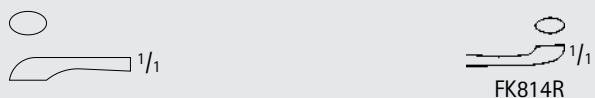

WILLIGER Bone Curette, Double Ended

Catalog Number	Tip Size (mm)	Length (in.)
FK814R	2.0 x 3.5 / 3.0 x 4.5	5 3/4

ENT-NASAL

Curettes

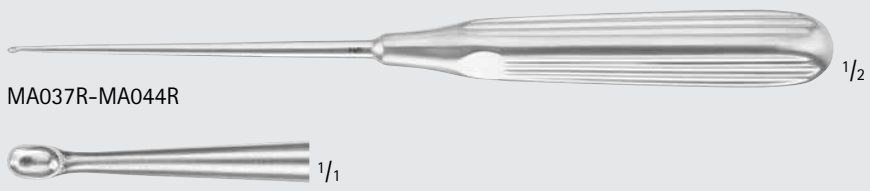

LEMPERT Bone Curette

Catalog Number	Size (#)	Length (in.)
MA037R	000000	8
MA038R	00000	8
MA039R	0000	8
MA044R	2	8

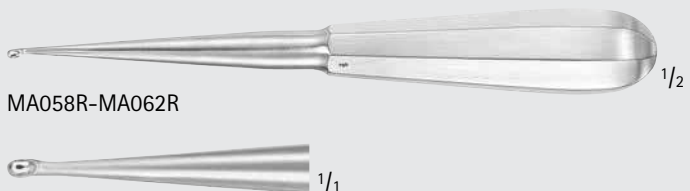

SPRATT Mastoid Curettes

Catalog Number	Tip Size (mm)	Size (#)	Length (in.)
MA058R	2.5 x 4	00	6 1/2
MA059R	3 x 5	0	6 1/2
MA060R	3.5 x 6	1	6 1/2
MA061R	4.5 x 8	3	6 1/2
MA062R	5.5 x 9	4	6 1/2

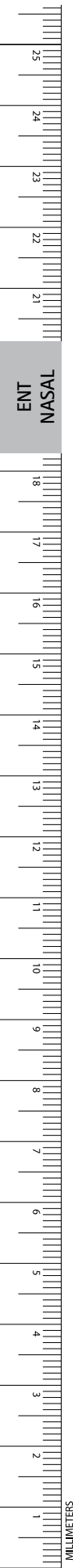
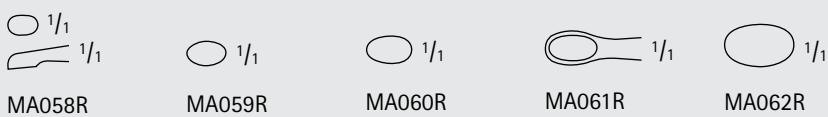

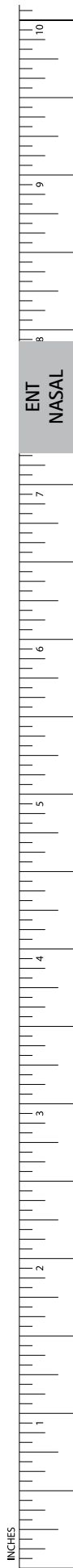

ALEXANDER Bone Rongeur

Catalog Number	Jaw Size (mm)	Jaw	Length (in.)
FO440R	3.2 x 27	ANG	5 1/2



FO440R



FO440R

BANE-HARTMANN Bone Rongeur

Catalog Number	Jaw Size (mm)	Jaw	Length (in.)
FO457R	4.0 x 32	CVD	6 7/8

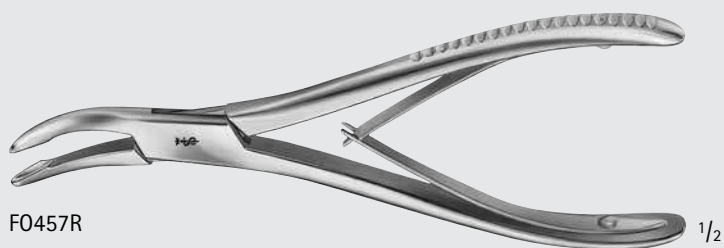

FO457R



FO457R

BEYER Bone Rongeur

Catalog Number	Jaw Size (mm)	Jaw	Handle	Length (in.)
FO453R	3.2 x 32	CVD	Single Action	7
FO514R	4.0 x 30	CVD	Double Action	7

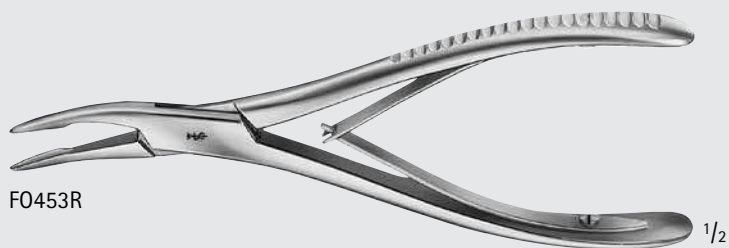

FO453R



FO453R

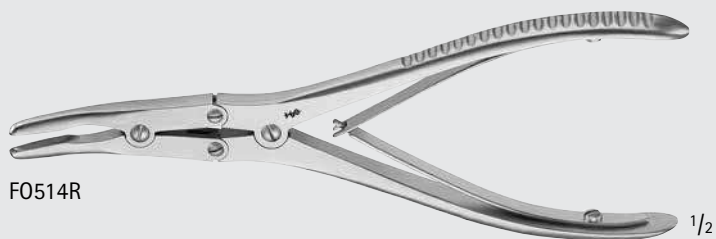

FO514R



FO514R

ENT-NASAL

Rongeurs

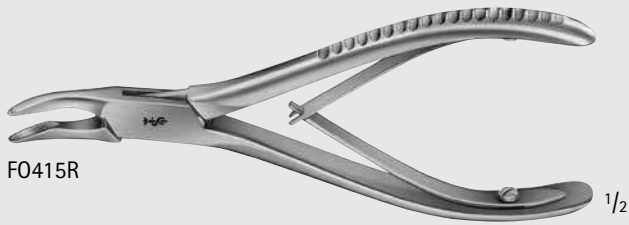

FO415R



FO415R

BLUMENTHAL Bone Rongeur

Catalog Number	Jaw Size (mm)	Jaw	Length (in.)
FO415R	3.5 x 25	CVD	6 1/8

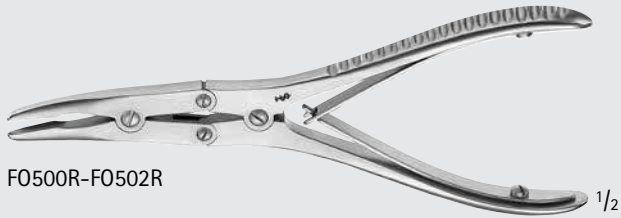

FO500R-FO502R



FO500R



FO502R

BOEHLER Bone Rongeur, Double Action

Catalog Number	Jaw Size (mm)	Jaw	Jaw End	Length (in.)
FO500R	3.0 x 27	CVD	NARR	6 1/8
FO502R	3.5 x 30	CVD	WIDE	6 1/8

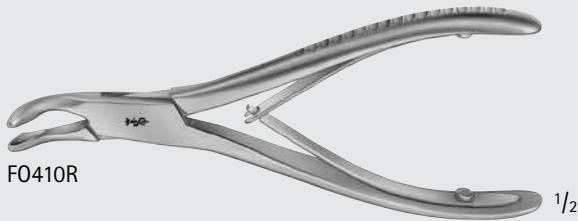

FO410R



FO410R

Bone Rongeur

Catalog Number	Jaw Size (mm)	Jaw	Length (in.)
FO410R	3.8 x 19	CVD	5 1/2

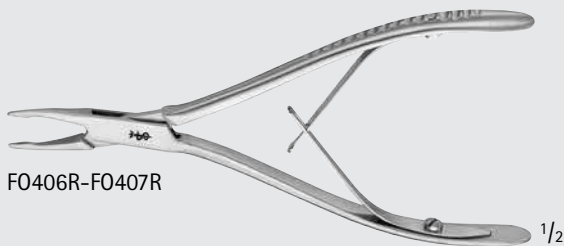

FO406R-FO407R



FO406R



FO407R

FRIEDMANN Micro Rongeur

Catalog Number	Jaw Size (mm)	Jaw	Length (in.)
FO406R	1.3 x 19	STR	5 1/2
FO407R	1.3 x 20	CVD	5 1/2

ENT
NASAL

MILLIMETERS

JANSEN Bone Rongeur

Catalog Number	Jaw Size (mm)	Jaw	Length (in.)
FO430R	4.2 x 35	STR	6 7/8
FO432R	4.5 x 30	CVD	6 7/8
FO442R	3.8 x 37	ANG	7 1/2

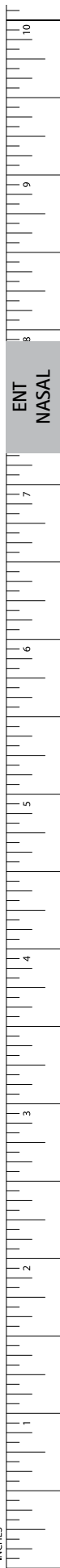
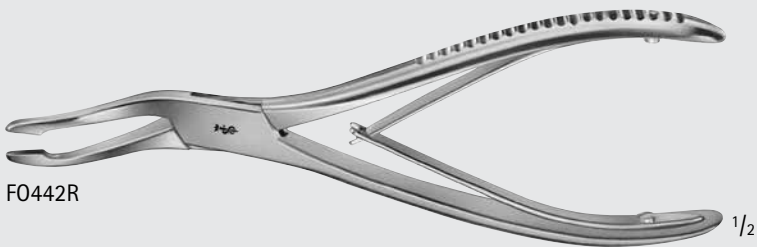

ENT-NASAL

Rongeurs

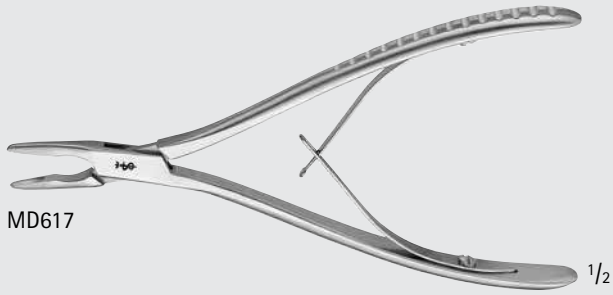
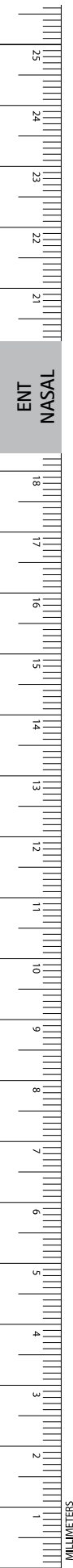

MD617

1/2



MD617

1/1

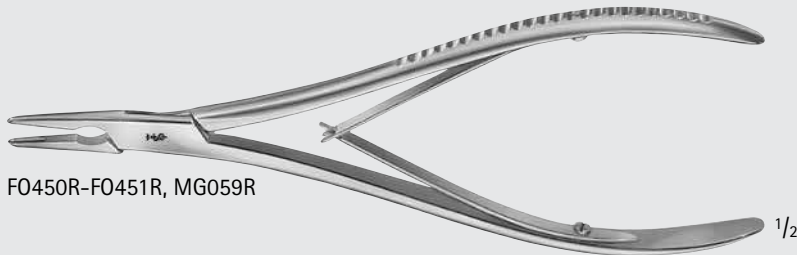

FO450R-FO451R, MG059R

1/2



FO450R

1/1



MG059R

1/1



FO451R

1/1

LEMPERT Bone Rongeur

Catalog Number	Jaw Size (mm)	Jaw	Length (in.)
MD617	2.0 x 23	DEL, STR	6 1/2
FO450R	2.2 x 27	STR	7 7/8
MG059R	2.5 x 30	CVD	6 1/4
FO451R	2.2 x 27	CVD	7 7/8

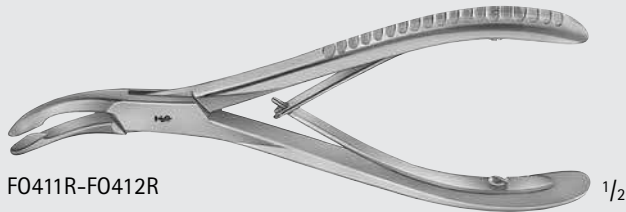

FO411R-FO412R

1/2



FO411R

1/1



FO412R

1/1

LUER Bone Rongeur

Catalog Number	Jaw Size (mm)	Jaw	Length (in.)
FO411R	4.2 x 20	CVD	6
FO412R	4.2 x 26	STRONG CVD	6 1/8

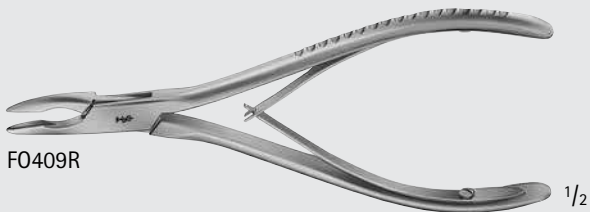

FO409R

1/2



FO409R

1/1

LUER-FRIEDMANN Bone Rongeur

Catalog Number	Jaw Size (mm)	Jaw	Length (in.)
FO409R	2.2 x 22	CVD	5 3/4

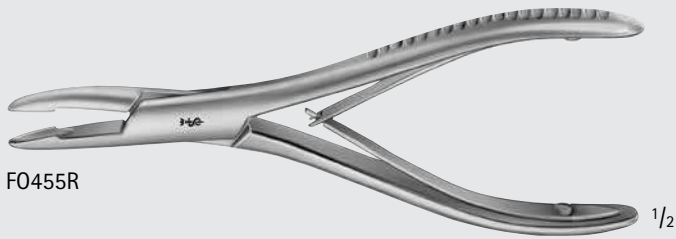

FO455R

1/2



1/1

FO455R

MEAD Bone Rongeur

Catalog Number	Jaw Size (mm)	Jaw	Length (in.)
FO455R	3.5 x 30	CVD	6 1/2

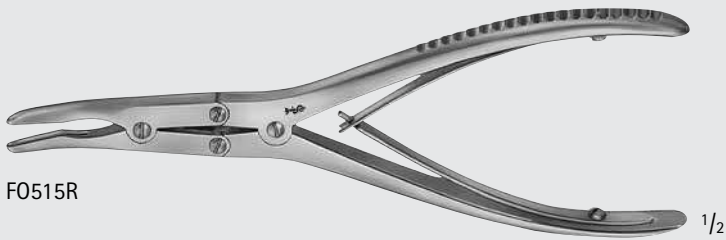

FO515R

1/2



1/1

FO515R

ZAUFAL-JANSEN Bone Rongeur, Double Action

Catalog Number	Jaw Size (mm)	Jaw	Length (in.)
FO515R	4.5 x 29	CVD	7

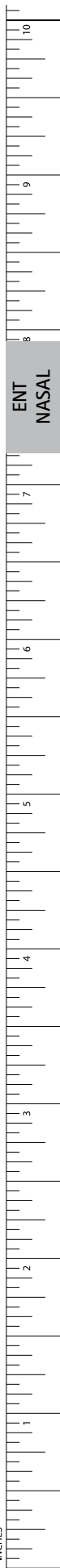

INCHES



Manufacturing Unit -

***115-A Waryana Industrial Complex, Leather Complex Road,
Jalandhar Punjab, 144021***



Sales Office -

***Plot No. 581- Kakrola Housing Complex, Near Metro Pillar 802,
Dwarka Mor, Delhi, 110078***



Our Certifications -

***UDYAM , ISO 13485, WHO-GMP, ISO 9001:2015, CE , ROHS,
FDA , MD-42, MD-5***

CONTACT US:



+91- 98141-81255, +91- 98142-62255



www.alisprofessional.com



info@royalinternational.org