



## Cardiovascular

Scissors .....	328 - 356
Needle Holders .....	357 - 370
Forceps .....	371 - 377
Titanium Forceps and Clamps .....	378 - 389
Forceps and Clamps .....	390 - 399
Vascular Clamps .....	400 - 481
Bulldog and Micro Vessel Clamps .....	482 - 490
Vessel Instruments .....	491 - 493
Specialty CV/Thoracic Instruments and Retractors ..	494 - 507
Retractors .....	508 - 517
Rib Spreaders .....	518 - 533

# Cardiovascular

## Scissors

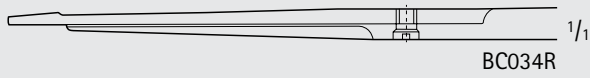
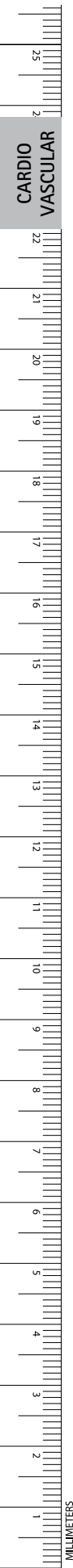

### Vessel Scissors

Catalog Number	Tip	Blade	Length (in.)
BC034R	B/B	1-PROBE-PT	5 3/4

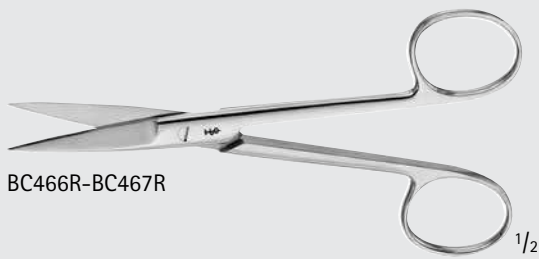

### MAYO Operating Scissors

Catalog Number	Tip	Blade	Length (in.)
BC466R	S/S	STR	5 1/2
BC467R	S/S	CVD	5 1/2

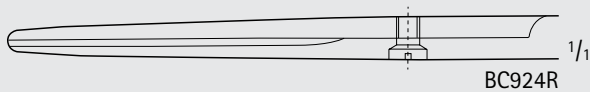
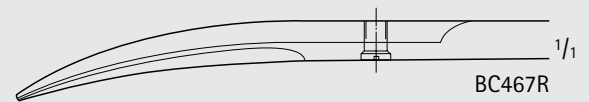

### MAYO SuperCut Scissors, Delicate

Catalog Number	Tip	Blade	Length (in.)
BC924R	B/B	STR	6 1/2
BC925R	B/B	CVD	6 1/2

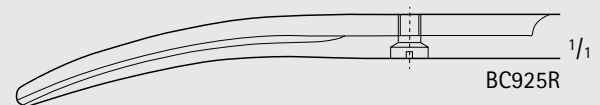



**CHURCH Scissors, Beveled**

Catalog Number	Tip	Blade	Length (in.)
MB618R	B/B	STR	7
MB619R	B/B	CVD	7

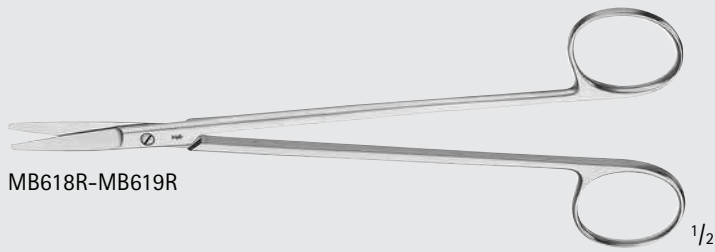

MB618R-MB619R

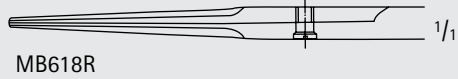

MB618R

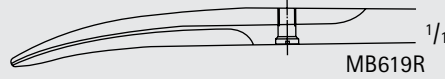

MB619R

**DEBAKEY Arteriotomy Scissors**

Catalog Number	Tip	Blade	Length (in.)
BC629R	B/B	CVD	6 7/8

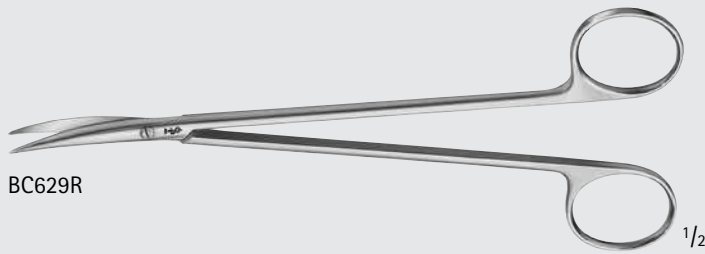

BC629R

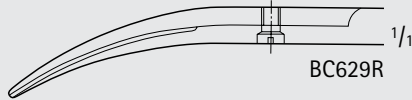

BC629R

**THOREK Scissors**

Catalog Number	Tip	Blade	Length (in.)
BC636R	B/B	HEAVY-CVD	7

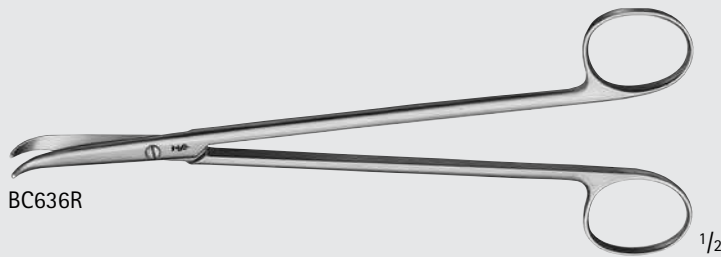

BC636R

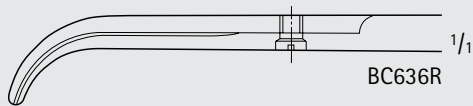

BC636R

**SCHMIEDEN-TAYLOR Dura Scissors**

Catalog Number	Tip	Blade	Length (in.)
BC660R	1 BALL-PT	ANG	6 1/8

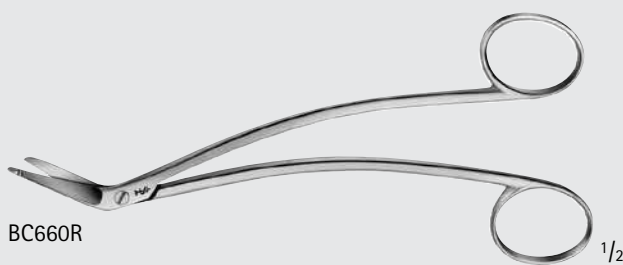

BC660R

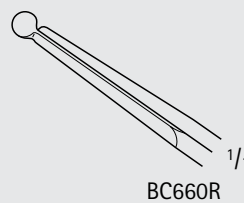

BC660R

# Cardiovascular

## Scissors

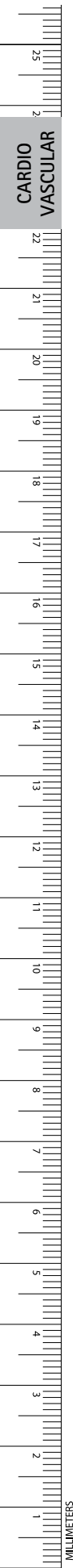

CARDIO  
VASCULAR

### SATINSKY Vena Cava Scissors

Catalog Number	Blade	Length (in.)
BC641R	CVD	9 5/8

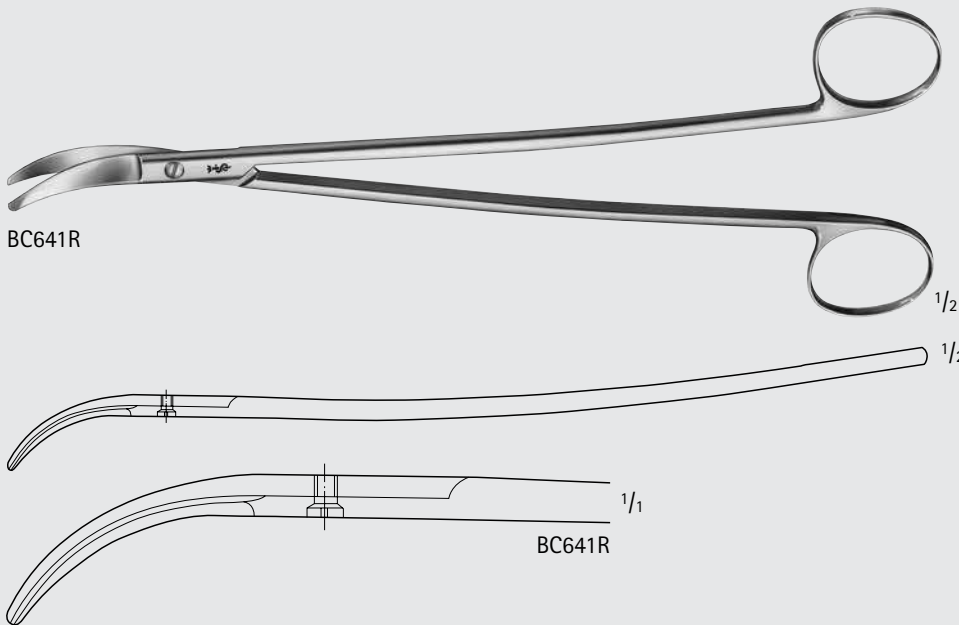

### STRULLY Scissors

Catalog Number	Tip	Blade	Length (in.)
BC644R	S/S	CVD	8 3/4

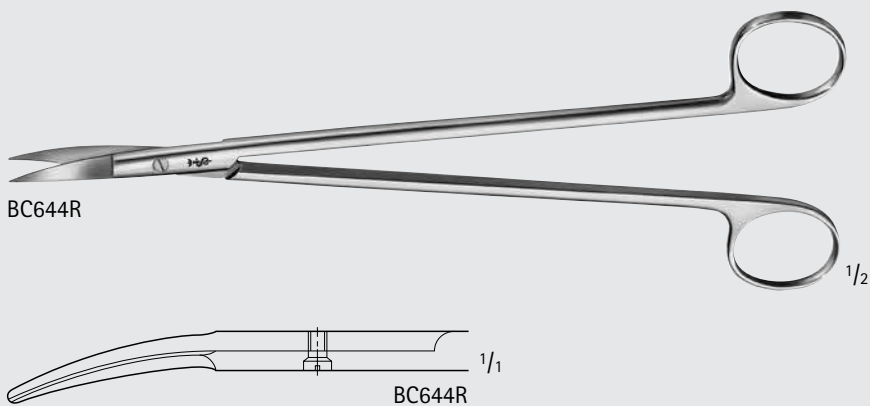

### STRULLY Scissors

Catalog Number	Tip	Blade	Length (in.)
BC645R	PROBE	CVD	8 3/4

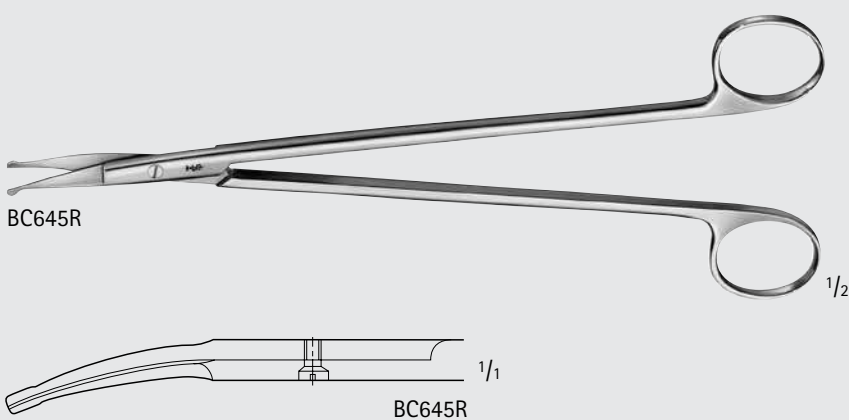





**POTTS-SMITH Dissecting Scissors**

Catalog Number	Tip	Blade	Length (in.)
MG381R	B/B	CVD	5 1/2
BC643R	B/B	CVD	7 1/2
BC191R	B/B	CVD	9
US145	B/B	CVD	11 1/4

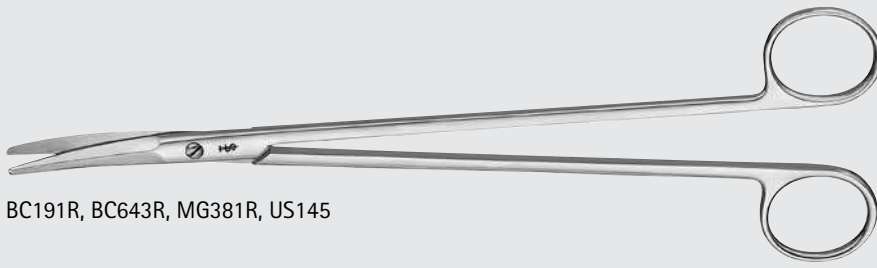

BC191R, BC643R, MG381R, US145

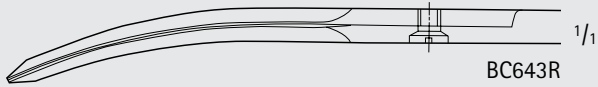
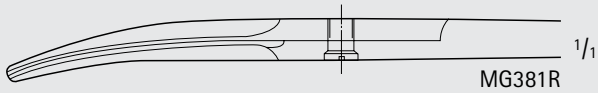

**MORSE Scissors**

Catalog Number	Tip	Blade	Length (in.)
BC196R	S/S	CVD	6 7/8

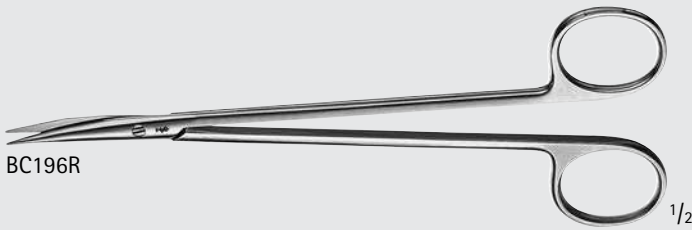

**HOHENFELLNER Scissors**

Catalog Number	Tip	Blade	Length (in.)
BC638R	B/B	CVD	8 7/8
BC639R	B/B	CVD	10

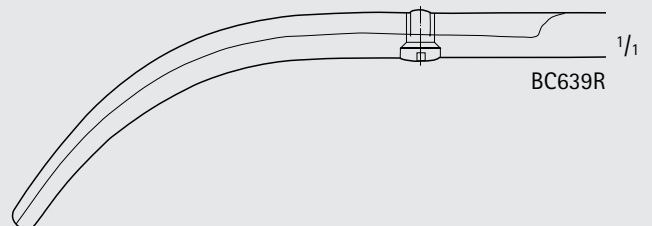
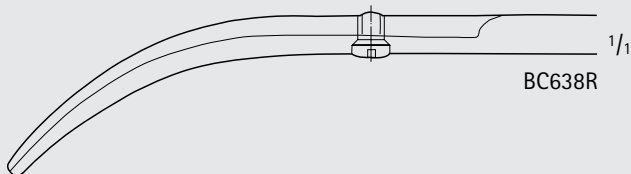
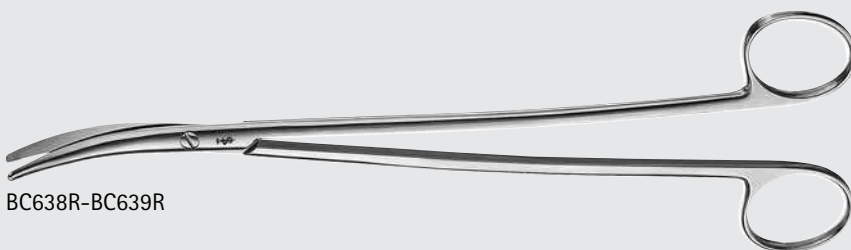

# Cardiovascular

## Scissors

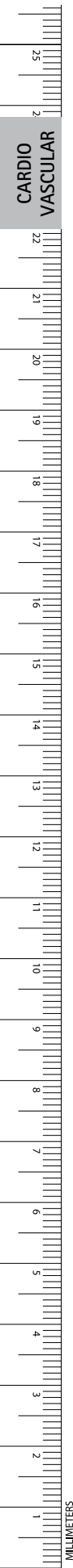

**JAMESON-METZENBAUM Scissors**

Catalog Number	Tip	Blade	Length (in.)
MG383R	S/S	CVD	9

MG383R  $\frac{1}{2}$

MG383R  $\frac{1}{1}$

**LILLEHEI-POTTS Tenotomy Scissors**

Catalog Number	Tip	Blade	Length (in.)
MG382R	S/S	CVD	7

MG382R  $\frac{1}{2}$

MG382R  $\frac{1}{1}$

**JAMESON Tenotomy Scissors, Delicate**

Catalog Number	Tip	Blade	Length (in.)
BC177R	B/B	CVD	6

BC177R  $\frac{1}{2}$

BC177R  $\frac{1}{1}$

POTTS Tenotomy Scissors

Catalog Number	Tip	Blade	Length (in.)
BC178R	B/B	CVD	6 7/8
BC179R	B/B	CVD	8

BC178R-BC179R

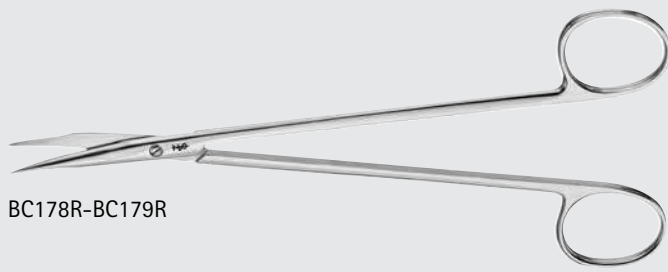

JAMESON SuperCut Scissors, Delicate

Catalog Number	Tip	Blade	Length (in.)
BC911R	B/B	CVD	5 1/8
BC915R	B/B	CVD	6
BC919R	B/B	CVD	7

BC911R, BC915R, BC919R



INCHES

# Cardiovascular

## Delicate Scissors

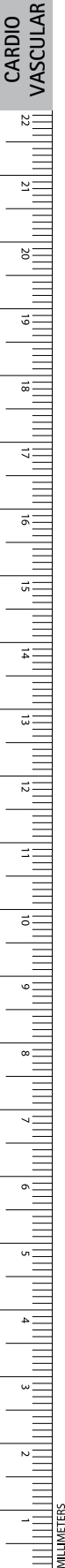

**METZENBAUM SuperCut Scissors**

Catalog Number	Tip	Blade	Length (in.)
BC936R	B/B	STR	7
BC937R	B/B	CVD	7

BC936R-BC937R

1/2

BC936R 1/1

BC937R 1/1

**METZENBAUM SuperCut Scissors**

Catalog Number	Tip	Blade	Length (in.)
BC945R	B/B	CVD	9
BC947R	B/B	CVD	10 1/4
BC949R	B/B	CVD	11 1/4
BC951R	B/B	CVD	11 3/4
BC953R	B/B	CVD	14

BC945R-BC953R

1/2

BC945R 1/1

BC947R 1/1

BC949R 1/1

BC951R 1/1

BC953R 1/1

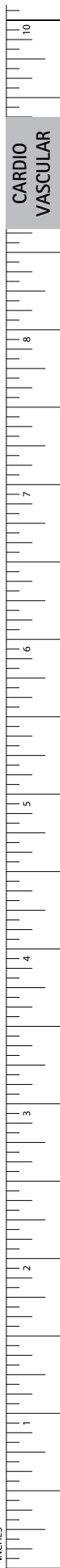

**GORNEY Scissors**

Catalog Number	Tip	Blade	Length (in.)
BC188R	B/B	STR	7 3/4
BC189R	B/B	SLIGHT-CVD	7 3/4



BC188R-BC189R

1/2

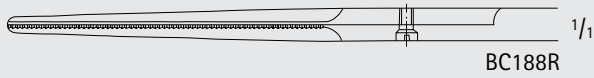

BC188R

1/1

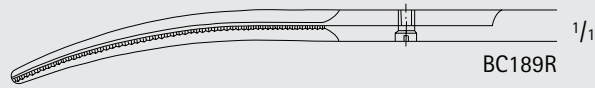

BC189R

1/1

**COOLEY Cardiovascular Scissors**

Catalog Number	Tip	Blade	Length (in.)
BC597R	B/B	CVD	7 1/2
BC599R	B/B	CVD	9

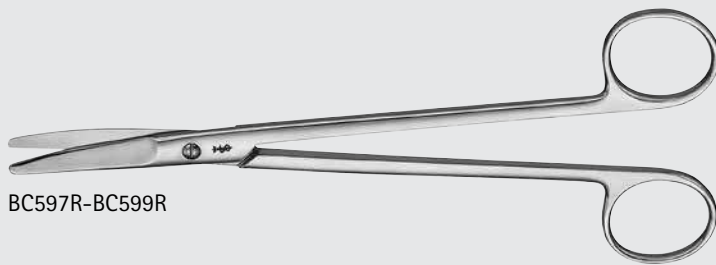

BC597R-BC599R

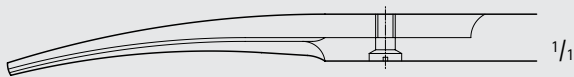

BC597R-BC599R

1/1

**POTTS-SMITH Lateral Angle Scissors**

Catalog Number	Tip	Blade Angle	Blade Length (mm)	Length (in.)
BC646R	S/S	55°	19	7

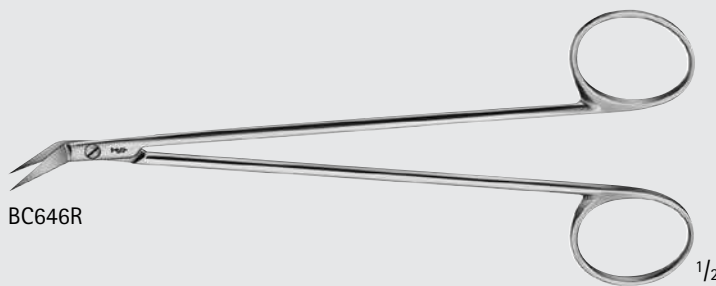

BC646R

1/2

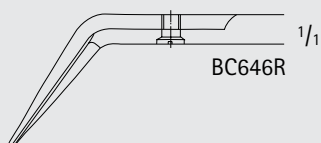

BC646R

1/1

# Cardiovascular

## Delicate Scissors

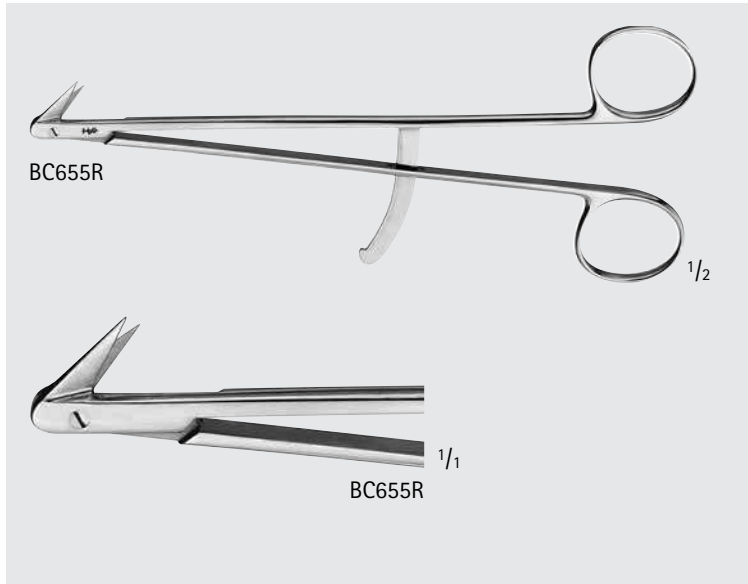
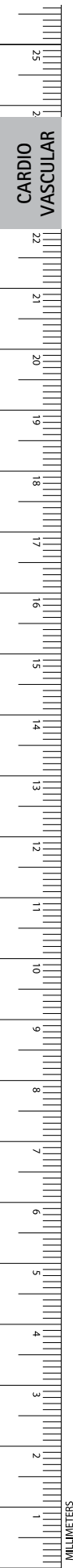

### POTTS-SMITH Reverse Scissors

Catalog Number	Tip	Blade Angle	Handle	Length (in.)
BC655R	S/S	130°	W/ STABILIZING BAR	7

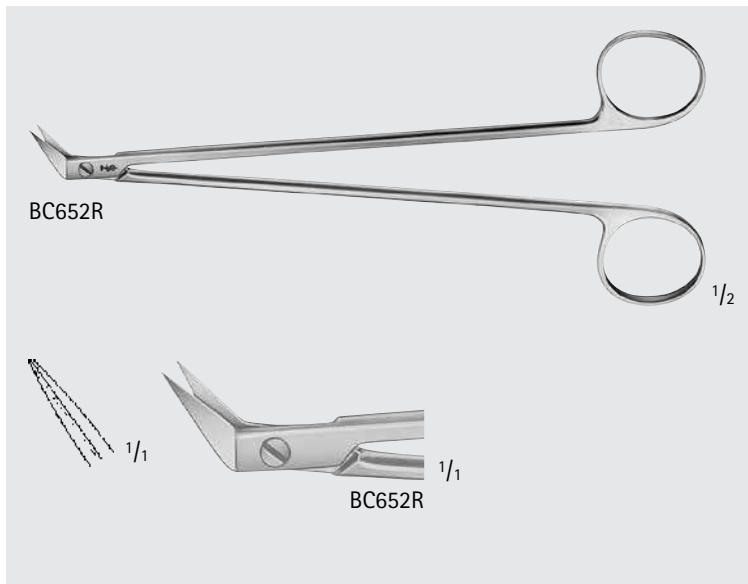

### POTTS-SMITH Vessel Scissors

Catalog Number	Tip	Blade Angle	Blade Length (mm)	Length (in.)
BC652R	S/S	60°	10	6 7/8

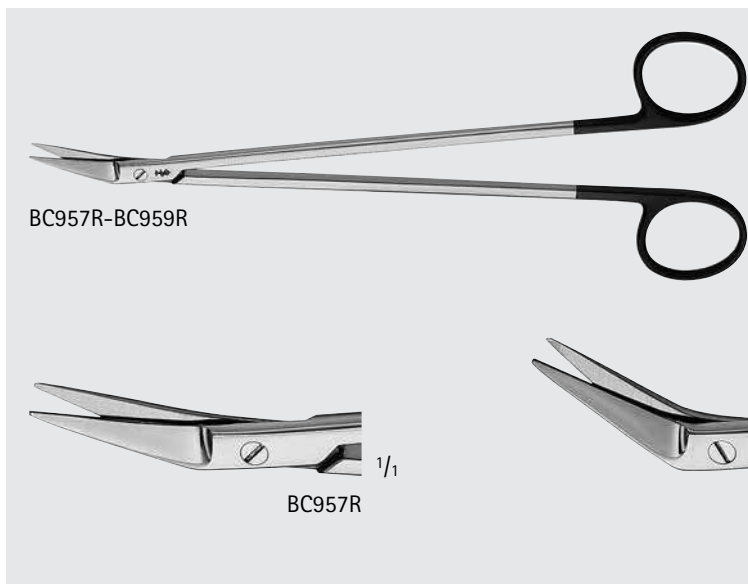

### POTTS-SMITH SuperCut Scissors

Catalog Number	Tip	Blade Angle	Blade Length (mm)	Length (in.)
BC957R	B/B	25°	22	7 1/2
BC958R	B/B	45°	20	7 1/4
BC959R	B/B	60°	19	7



**POTTS-DE MARTEL Scissors**

Catalog Number	Tip	Blade Angle	Blade Length (mm)	Length (in.)
BC647R	S/S	30°	21	7 1/4
BC648R	S/S	45°	21	7 1/4
BC649R	S/S	60°	21	7 1/4
BC650R	S/S	60°	21	8 3/4

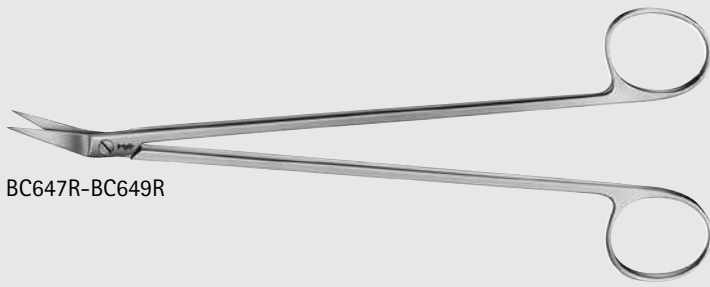

BC647R-BC649R

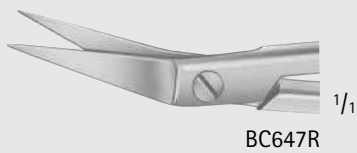

BC647R



BC648R



BC649R

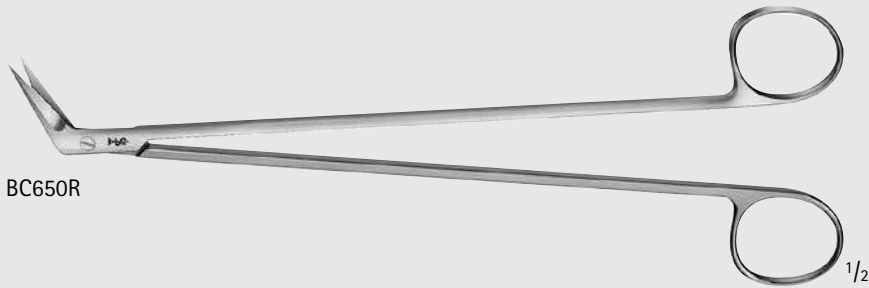

BC650R

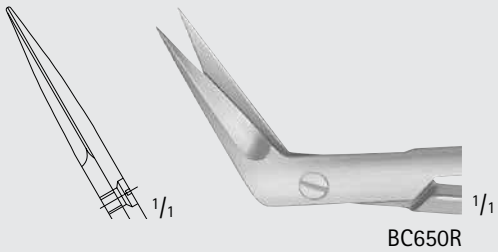

BC650R

**MILLS Scissors**

Catalog Number	Tip	Blade	Blade Length (mm)	Length (in.)
BC651R	1 BALL-POINT	60°	23	8 3/4

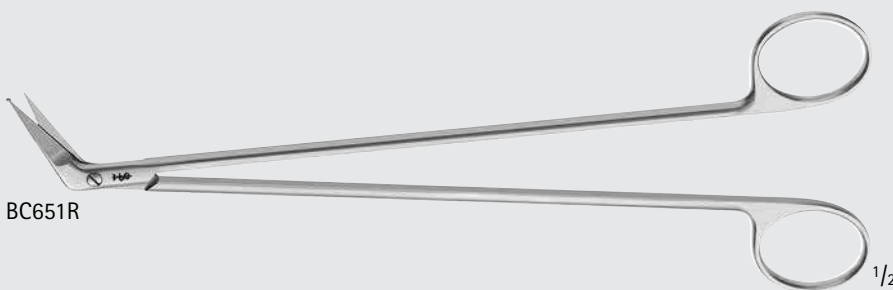

BC651R

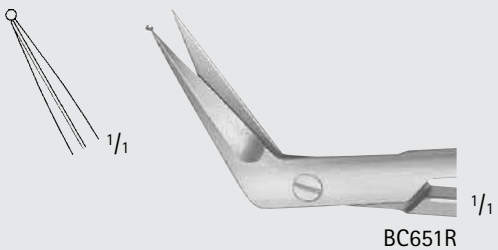

BC651R

# Cardiovascular

## Delicate Scissors

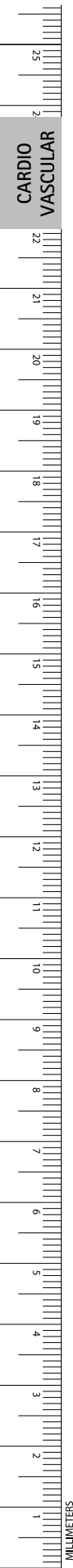

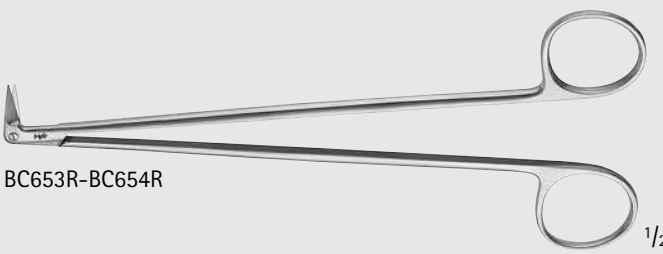

BC653R-BC654R 1/2



BC653R 1/1



BC654R 1/1

### DIETHRICH Vessel Scissors

Catalog Number	Tip	Blade Angle	Blade Length (mm)	Length (in.)
BC653R	S/S	90°	12	6 3/4
BC654R	S/S	120°	10	6 3/4

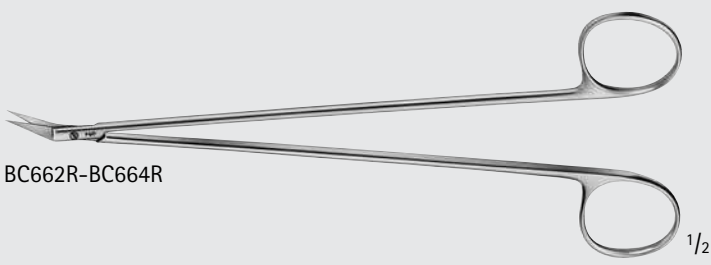

BC662R-BC664R 1/2

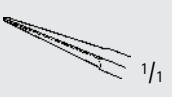

BC662R 1/1



BC663R 1/1

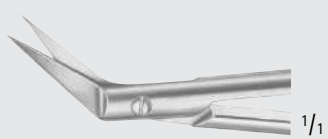

BC664R 1/1

### DIETHRICH-HEGEMANN Vessel Scissors

Catalog Number	Tip	Blade Angle	Blade Length (mm)	Length (in.)
BC662R	S/S	25°	15	7
BC663R	S/S	45°	15	7
BC664R	S/S	60°	15	7

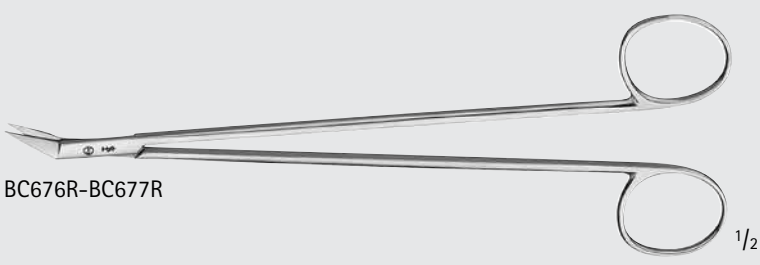

BC676R-BC677R 1/2



BC676R 1/1



BC677R 1/1

### DIETHRICH Coronary Artery Scissors

Catalog Number	Tip	Blade Angle	Blade Length (mm)	Length (in.)
BC676R	S/S	25°	13	7 1/4
BC677R	S/S	45°	14	7 1/4





**COOLEY Arteriotomy Scissors**

Catalog Number	Tip	Blade Angle	Blade Length (mm)	Length (in.)
BC678R	B/B	30°	21.5	8 7/8
BC679R	B/B	30°	21.5	10 3/4

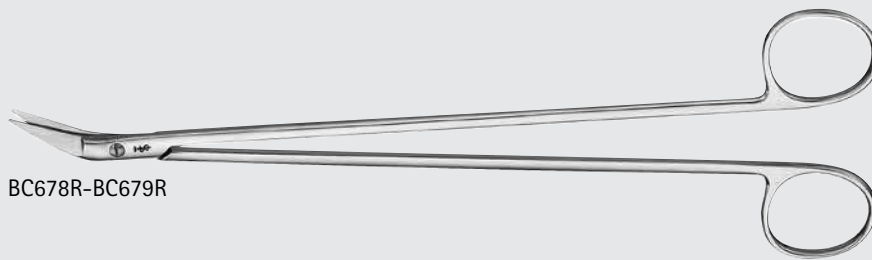

BC678R-BC679R



BC678R



BC679R

**DEBAKEY Vessel Scissors**

Catalog Number	Tip	Blade Angle	Blade Length (mm)	Length (in.)
BC656R	S/S	45°	18	6 1/8
BC657R	S/S	60°	18	6 1/8

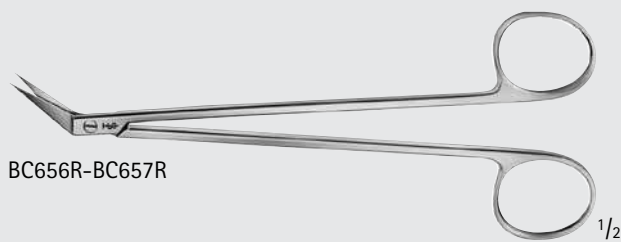

BC656R-BC657R

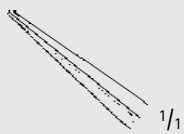

1/1



BC656R



BC657R

**DEBAKEY Offset Scissors, S-Shaped**

Catalog Number	Tip	Blade Angle	Blade Length (mm)	Length (in.)
BC669R	S/S	45°	24	6 1/8

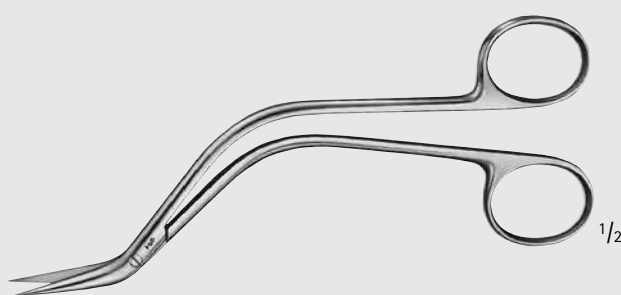

BC669R

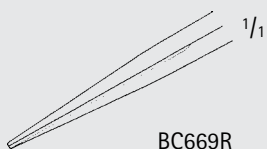

BC669R

# Cardiovascular

## Delicate Scissors

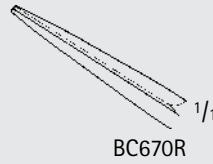
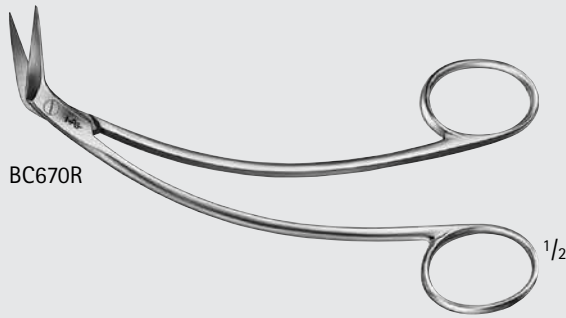
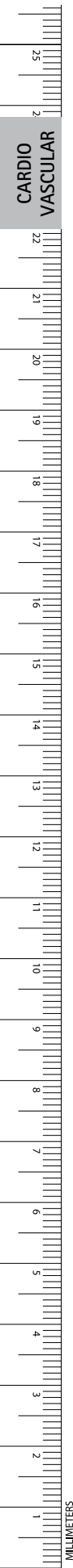

### FAVOLORO Artery Scissors

Catalog Number	Tip	Blade Angle	Blade Length (mm)	Length (in.)
BC670R	S/S	45°	20	5 1/2

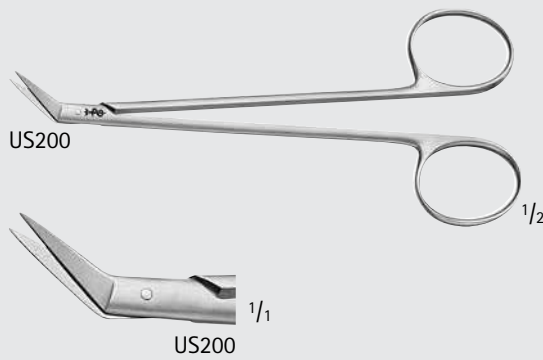

### POTTS Vascular Scissors

Catalog Number	Tip	Blade Angle	Blade Length (mm)	Length (in.)
US200	S/S	45°	13	5 1/4

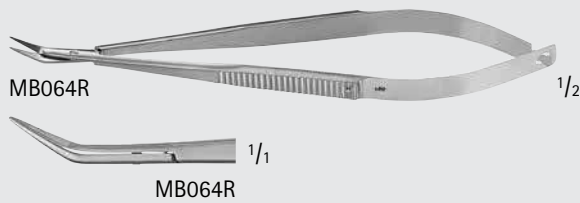

### Valve Leaflet Excision Scissors

Catalog Number	Tip	Blade Angle	Length (in.)
MB064R	B/B	45°	5 3/4

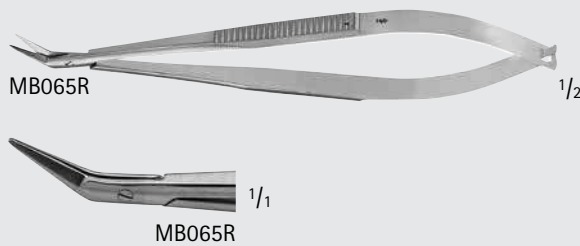

### POTTS Arteriotomy Scissors

Catalog Number	Tip	Blade Angle	Length (in.)
MB065R	B/B	60°	5 3/8

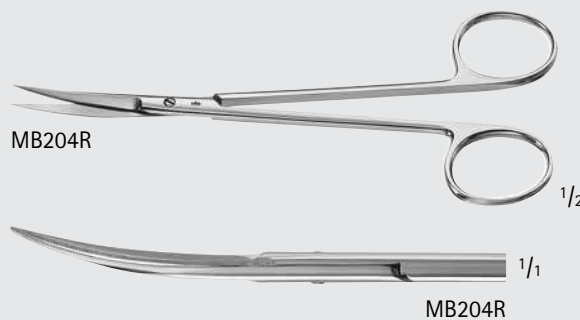

### COOLEY Neonatal Scissors

Catalog Number	Tip	Blade	Length (in.)
MB204R	S/S	CVD	5 3/4



DIETHRICH-POTTS Micro Scissors

Catalog Number	Tip	Blade	Blade Angle	Blade Length (mm)	Length (in.)
BC515R	S/S	X-DEL	25°	8	7
BC516R	S/S	X-DEL	45°	8	7
BC517R	S/S	X-DEL	60°	8	7
BC518R	S/S	X-DEL	90°	8	7
BC519R	S/S	X-DEL	125°	8	7
BC531R	S/S	DEL	25°	10	7
BC532R	S/S	DEL	45°	10	7
BC533R	S/S	DEL	60°	10	7
BC534R	S/S	DEL	90°	10	7
BC535R	S/S	DEL	125°	10	7
BC522R	S/S	FINE	25°	12	7
BC523R	S/S	FINE	45°	12	7
BC524R	S/S	FINE	60°	12	7
BC525R	S/S	FINE	90°	12	7
BC526R	S/S	FINE	125°	12	7

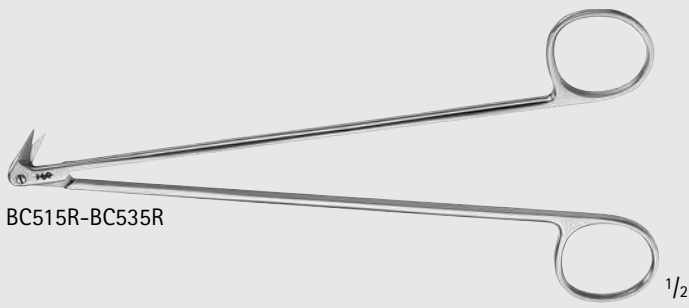

Blade Length: 8 MM

Blade Length: 10 MM

Blade Length: 12 MM

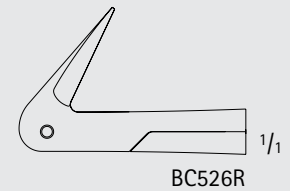
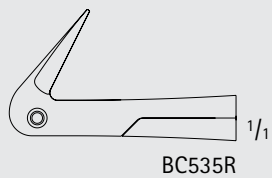
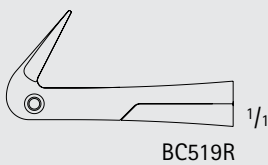
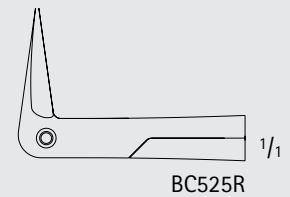
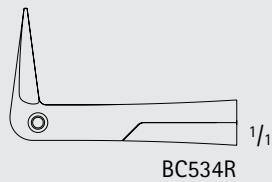
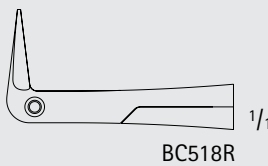
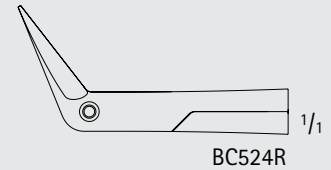
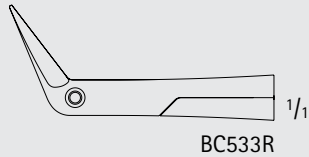
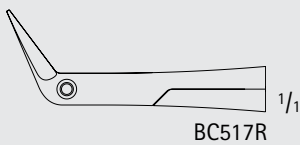
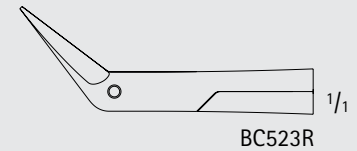
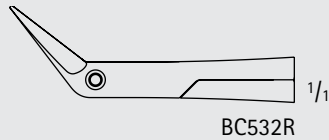
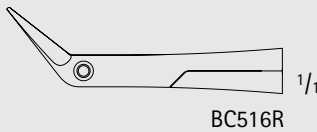
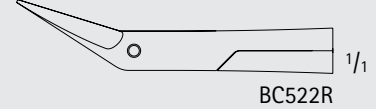
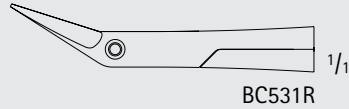
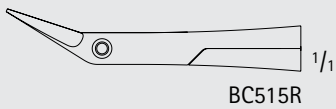

# Cardiovascular

## Scissors

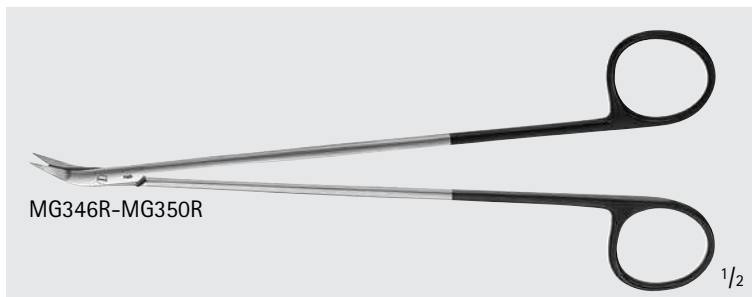
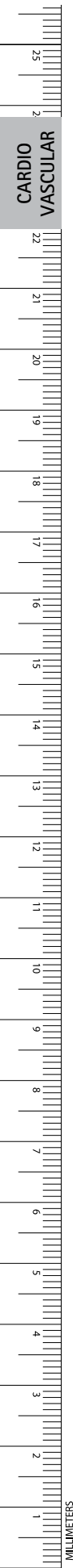

### DIETHRICH SuperCut Scissors

Catalog Number	Tip	Blade	Length (in.)
MG346R	S/S	25°	7
MG347R	S/S	45°	7
MG348R	S/S	60°	7
MG349R	S/S	90°	7
MG350R	S/S	125°	7



**DUROTIP TC Tungsten Carbide Scissors**

- Excellent cutting accuracy
- Long working life
- Gold-plated rings

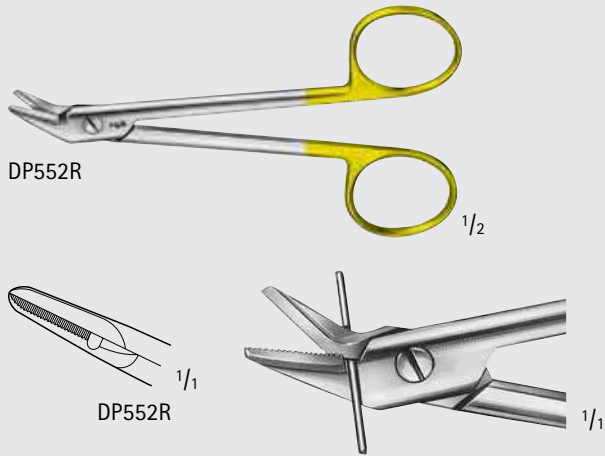

**DUROTIP TC Wire Cutting Scissors**

Catalog Number	Blade	For Wire Size	Length (in.)
DP552R	1-SERR	SOFT, UP TO 1.2 MM AND HARD, UP TO 0.8 MM	4 3/4

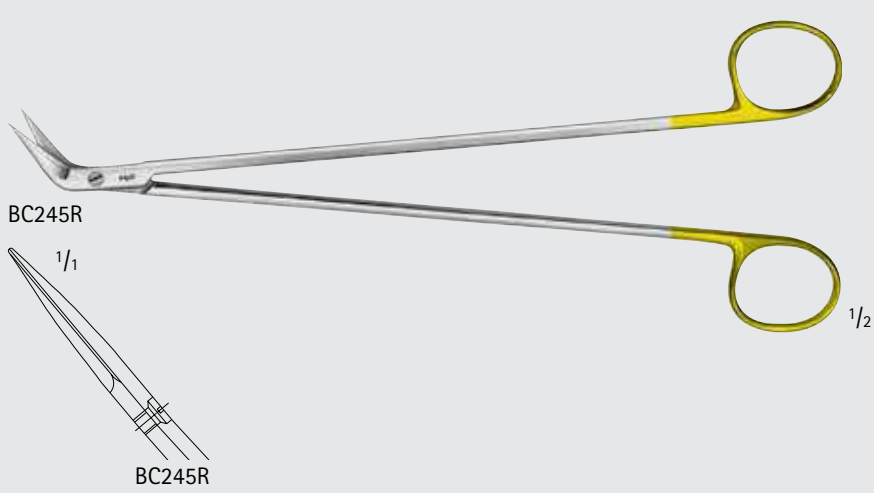

**DUROTIP TC DEBAKEY Vascular Scissors**

Catalog Number	Tip	Blade Angle	Blade Length (mm)	Length (in.)
BC245R	S/S	60°	21	8 3/4

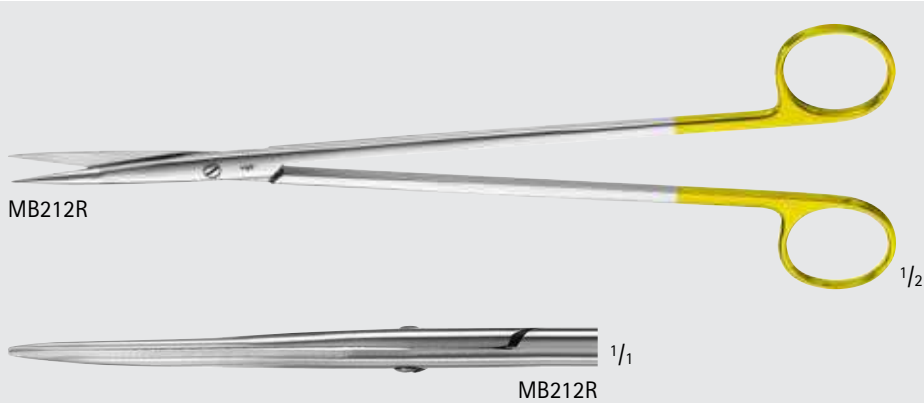

**DUROTIP TC DEMARTEL Vascular Scissors**

Catalog Number	Tip	Blade	Length (in.)
MB212R	S/S	CVD	6 3/4

# Cardiovascular

## DUROTIP™ TC Scissors

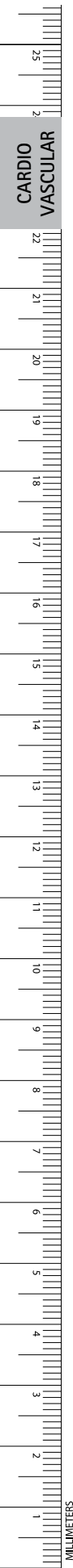

CARDIO  
VASCULAR



BC258R-BC259R

1/2

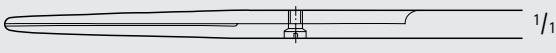

1/1

BC258R

**DUROTIP TC Baby METZENBAUM Dissecting Scissors, Delicate**

Catalog Number	Tip	Blade	Length (in.)
BC258R	B/B	STR	5 3/4
BC259R	B/B	CVD	5 3/4

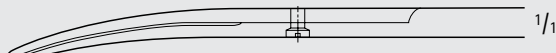

1/1

BC259R

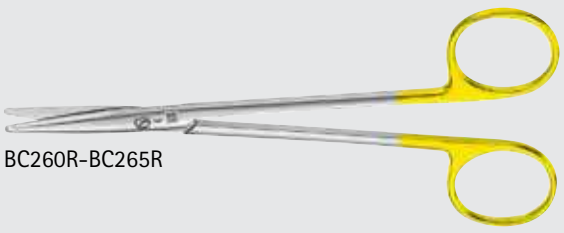

BC260R-BC265R

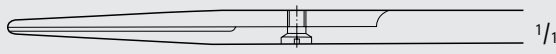

1/1

BC260R

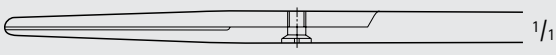

1/1

BC262R



BC287R

1/2

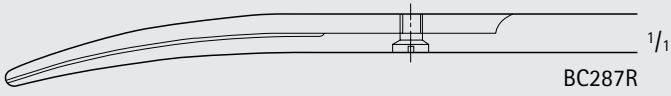

1/1

BC287R

**DUROTIP TC METZENBAUM Dissecting Scissors**

Catalog Number	Tip	Blade	Length (in.)
BC260R	B/B	STR	5 3/4
BC262R	B/B	STR	7
BC261R	B/B	CVD	5 3/4
BC263R	B/B	CVD	7
BC265R	B/B	CVD	7 7/8
BC287R	B/B	CVD	9

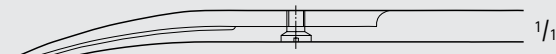

1/1

BC261R

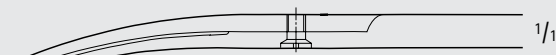

1/1

BC263R

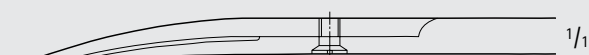

1/1

BC265R

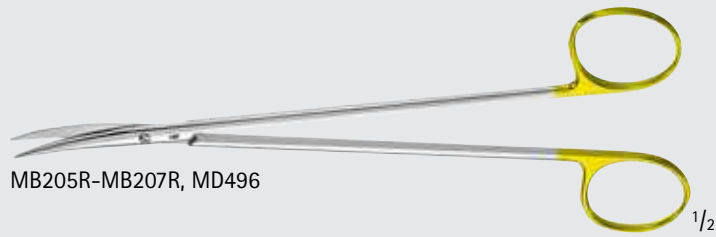

MB205R-MB207R, MD496

1/2

**DUROTIP TC METZENBAUM Dissecting Scissors, Delicate**

Catalog Number	Tip	Blade	Length (in.)
MB205R	S/S	STR	9 1/4
MB207R	S/S	CVD	5 3/4
MD496	S/S	CVD	7
MB206R	S/S	CVD	9 1/4



MB205R

1/1

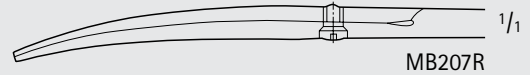

MB207R

1/1



MD496

1/1

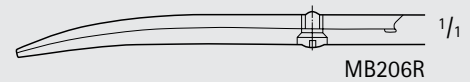

MB206R

1/1

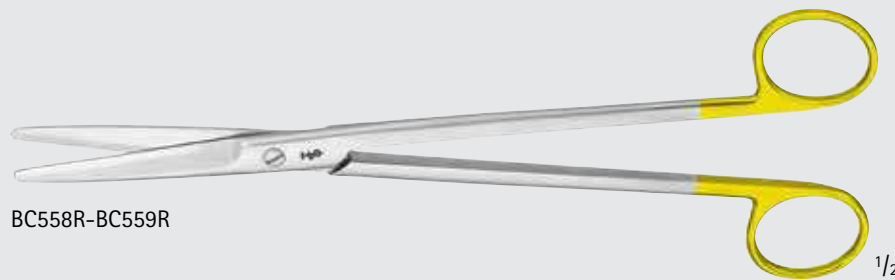

BC558R-BC559R

1/2

**DUROTIP TC MAYO Dissecting Scissors**

Catalog Number	Tip	Blade	Length (in.)
BC558R	B/B	STR	9
BC559R	B/B	CVD	9

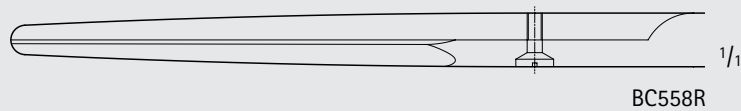

BC558R

1/1

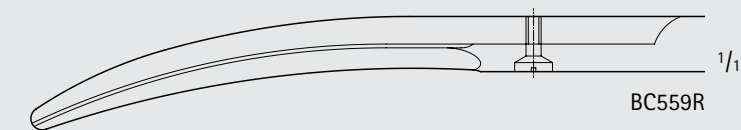

BC559R

1/1

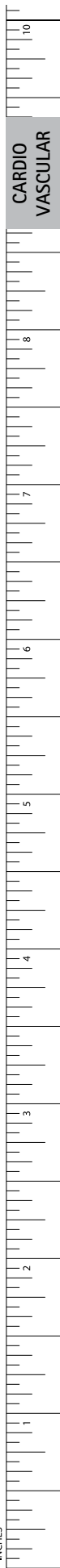

# Cardiovascular

## DUROTIP™ TC Scissors



Wavecut

- Wavecut scissors have one serrated cutting edge to prevent tissue from slipping. The W after the item number indicates the scissors are the wavecut style, e.g. BC211W.

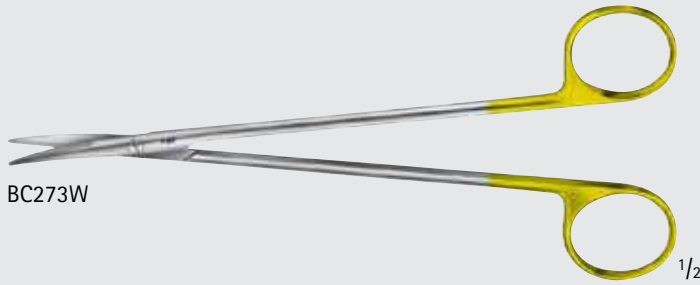

BC273W

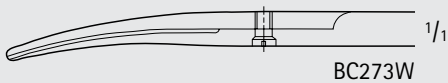

BC273W

### DUROTIP TC TOENNIS-ADSON Wavecut Dissecting Scissors

Catalog Number	Tip	Blade	Length (in.)
BC273W	B/B	CVD	6 7/8



BC259W

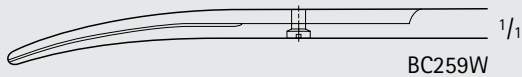

BC259W

### DUROTIP TC Baby METZENBAUM Wavecut Dissecting Scissors, Delicate

Catalog Number	Tip	Blade	Length (in.)
BC259W	B/B	CVD	5 3/4

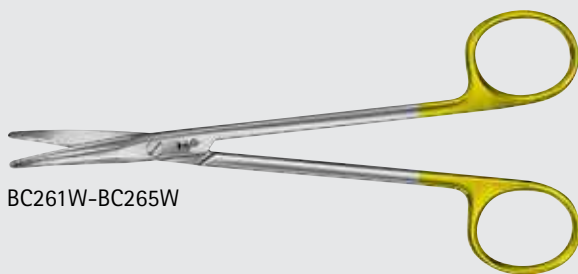

BC261W-BC265W

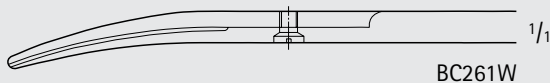

BC261W

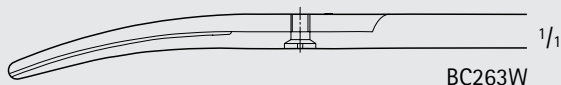

BC263W

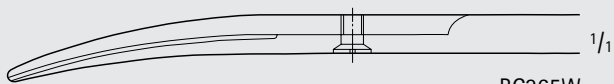

BC265W

### DUROTIP TC METZENBAUM Wavecut Dissecting Scissors

Catalog Number	Tip	Blade	Length (in.)
BC261W	B/B	CVD	5 3/4
BC263W	B/B	CVD	7
BC265W	B/B	CVD	7 7/8

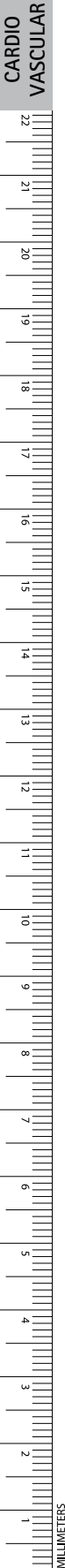





**DUROTIP TC NELSON-METZENBAUM  
Wavecut Dissecting Scissors**

Catalog Number	Tip	Blade	Length (in.)
BC267W	B/B	CVD	9
BC279W	B/B	CVD	10 1/4
BC281W	B/B	CVD	11

BC267W-BC281W

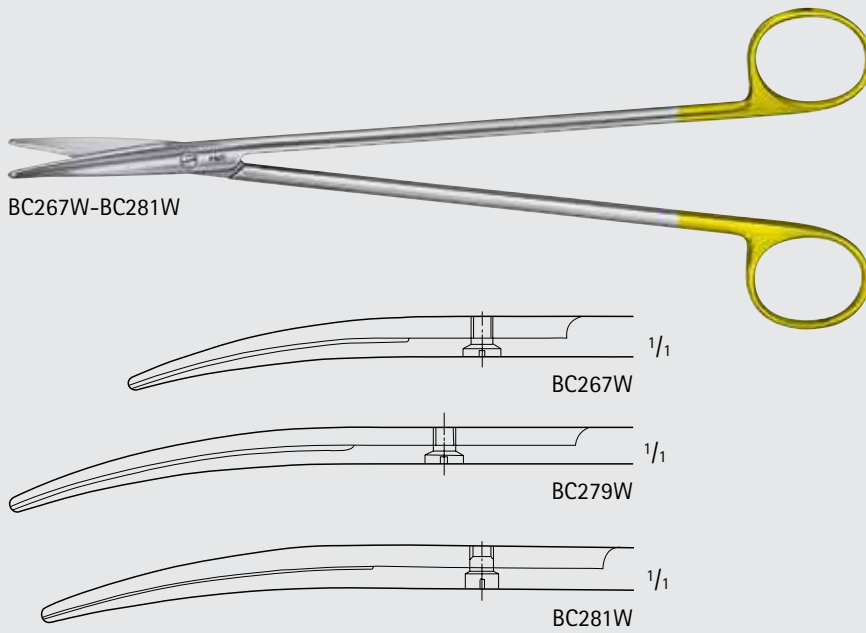

**DUROTIP TC METZENBAUM Wavecut  
Dissecting Scissors, Delicate**

Catalog Number	Tip	Blade	Length (in.)
BC271W	B/B	CVD	7
BC275W	B/B	CVD	7 7/8
BC277W	B/B	CVD	9

BC271W-BC277W

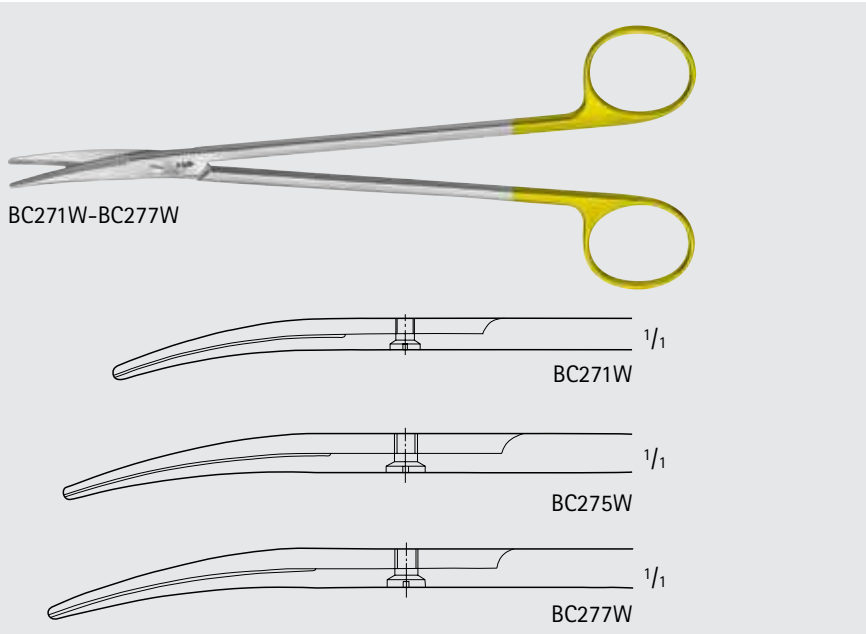

**DUROTIP TC METZENBAUM Wavecut  
Dissecting Scissors, Heavy**

Catalog Number	Tip	Blade	Length (in.)
BC287W	B/B	CVD	9

BC287W

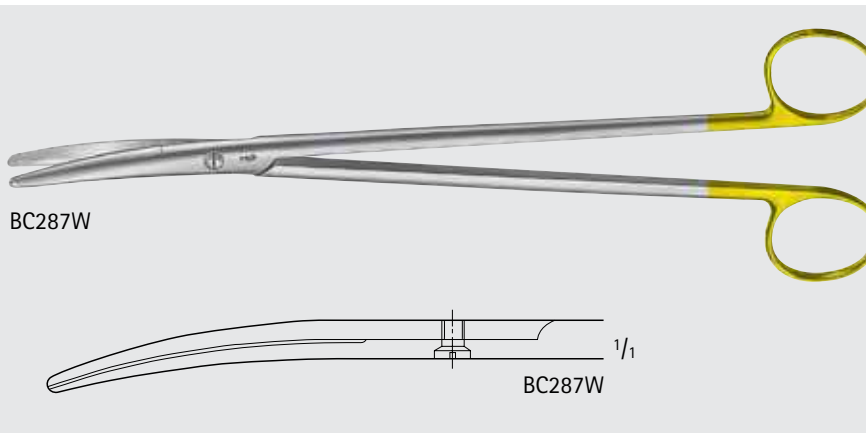

# Cardiovascular

## DUROTIP™ TC Scissors

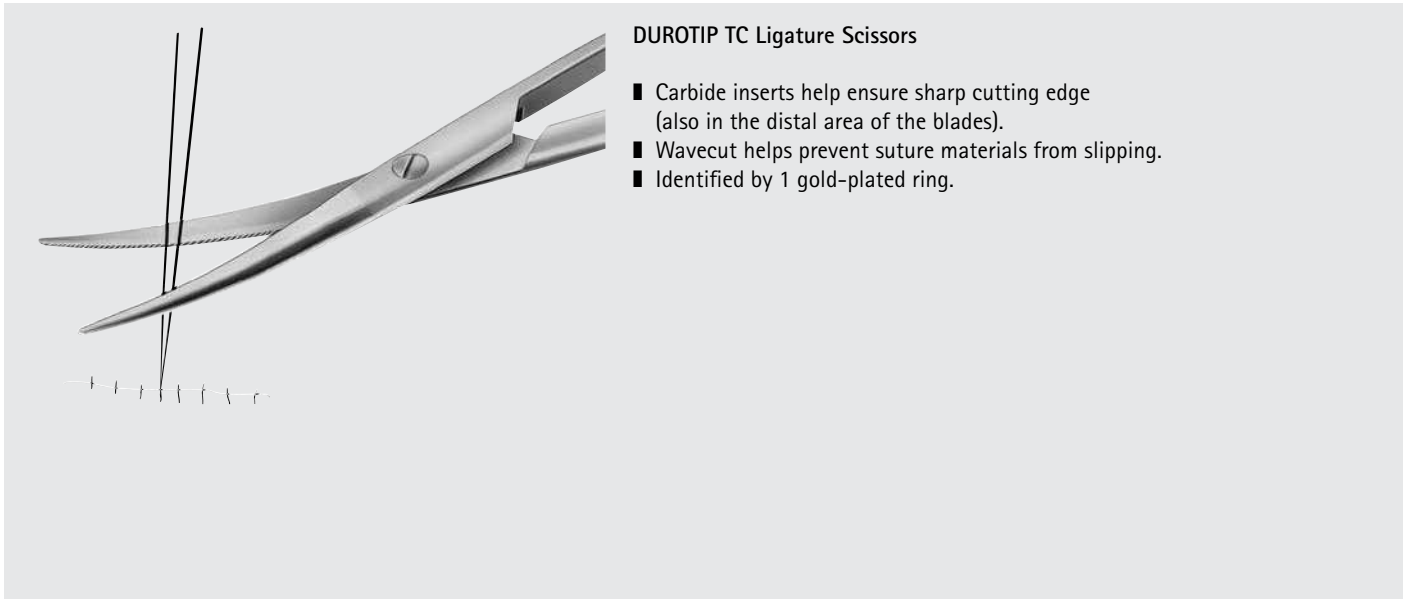

**DUROTIP TC Ligature Scissors**

- Carbide inserts help ensure sharp cutting edge (also in the distal area of the blades).
- Wavecut helps prevent suture materials from slipping.
- Identified by 1 gold-plated ring.

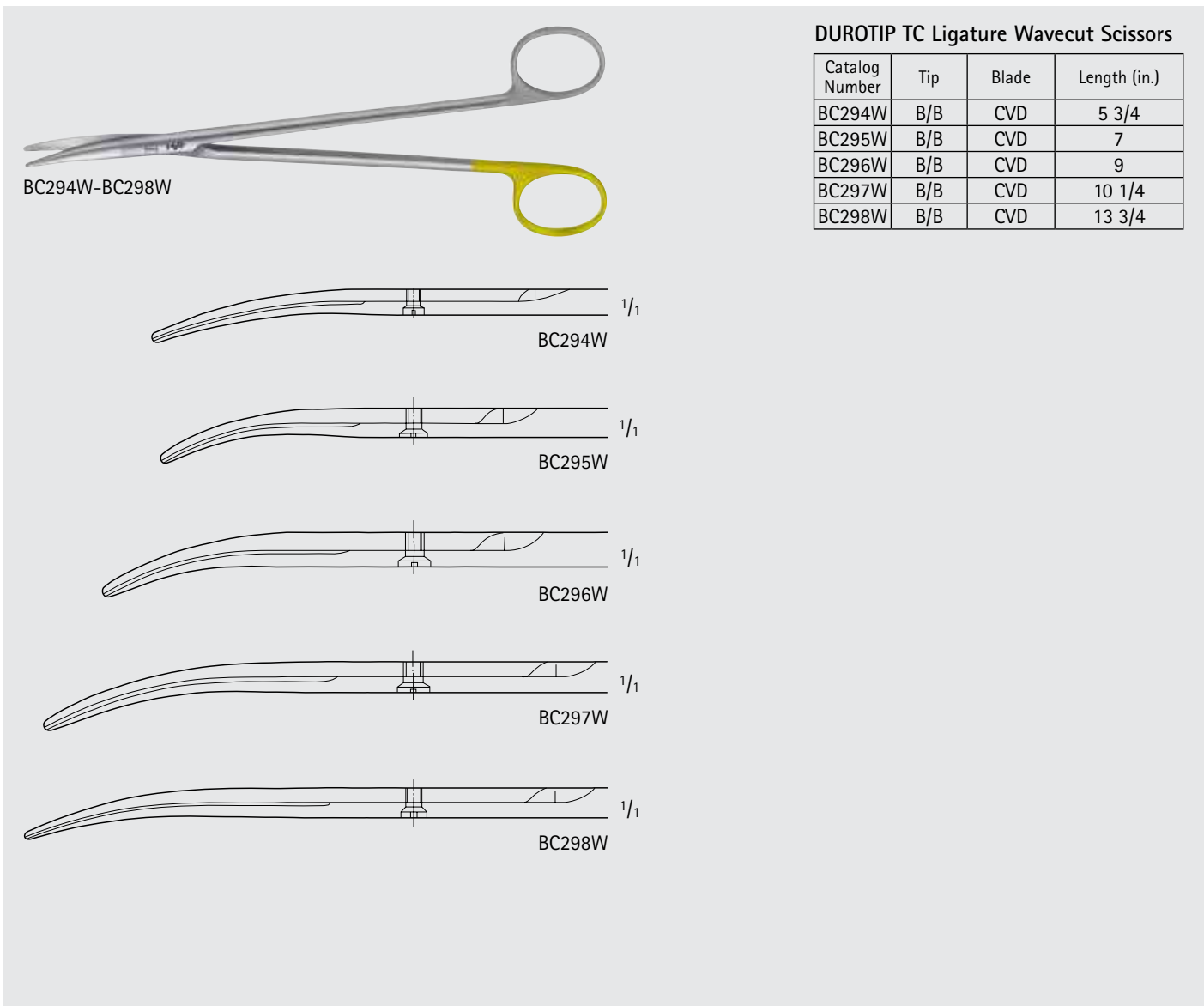

BC294W-BC298W

**DUROTIP TC Ligature Wavecut Scissors**

Catalog Number	Tip	Blade	Length (in.)
BC294W	B/B	CVD	5 3/4
BC295W	B/B	CVD	7
BC296W	B/B	CVD	9
BC297W	B/B	CVD	10 1/4
BC298W	B/B	CVD	13 3/4

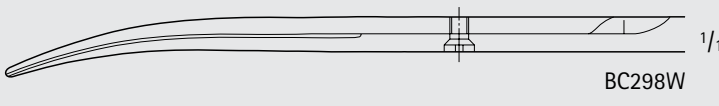
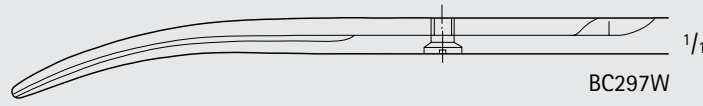
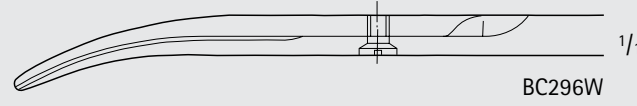
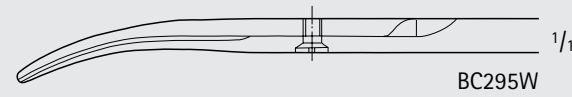
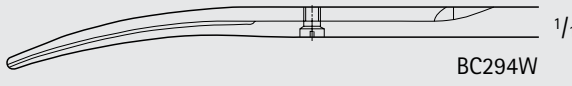

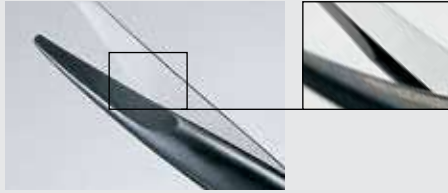

Microtome Edge

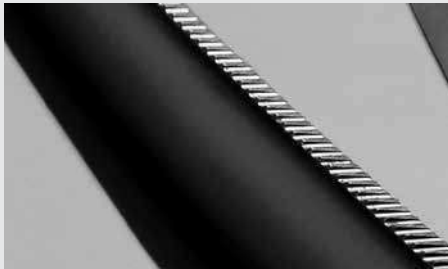

Wavecut

### Noir Supreme Cut Scissors

■ **Noir**

The combination of the renowned Aesculap Tungsten Carbide technology with the Aesculap Noir coating results in an extremely high surface hardness and therefore high wear resistance in daily hospital use.

■ **Microtome edge**

The extremely sharp cutting edge of the scissors blade facilitates gentle cutting of tissue with minimal use of force.

■ **Wavecut helps prevent tissue from slipping out during the cutting process.**

■ **The WB after the item number indicates the Noir scissors are the wavecut style, e.g. BC211WB.**

For more information about Noir Supreme Cut Scissors see our brochure number DOC637.



BC252B-BC253WB

1/2



1/1

BC252B



1/1

BC253B, BC253WB

### Noir MAYO Dissecting Scissors

Catalog Number	Tip	Blade	Length (in.)
BC252B	B/B	STR	6 3/4
BC253B	B/B	CVD	6 3/4
BC253WB	B/B	CVD	6 3/4



BC284B-BC284WB

1/2



1/1

BC284B-BC284WB

### Noir MAYO-LEXER Dissecting Scissors

Catalog Number	Tip	Blade	Length (in.)
BC284B	B/B	CVD	6 1/2
BC284WB	B/B	CVD	6 1/2

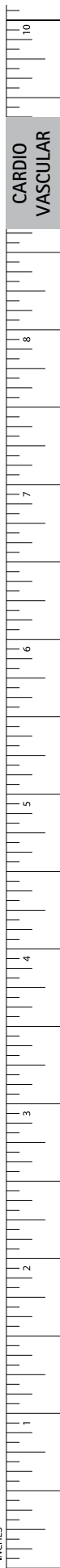

# Cardiovascular

## Noir™ Supreme Cut Scissors

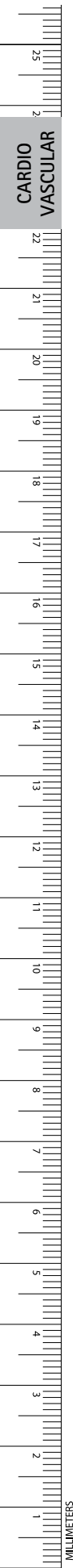



BC283B-BC283WB 1/2



BC283B-BC283WB 1/1

### Noir LEXER Dissecting Scissors

Catalog Number	Tip	Blade	Length (in.)
BC283B	B/B	DEL, CVD	6 1/2
BC283WB	B/B	DEL, CVD	6 1/2



BC210B-BC211WB 1/2



BC210B 1/1



BC211B, BC211WB 1/1

### Noir Iris Dissecting Scissors

Catalog Number	Tip	Blade	Length (in.)
BC210B	S/S	STR	4 1/4
BC211B	S/S	CVD	4 1/4
BC211WB	S/S	CVD	4 1/4



BC273B-BC273WB 1/2



BC273B-BC273WB 1/1

### Noir TOENNIS-ADSON Dissecting Scissors

Catalog Number	Tip	Blade	Length (in.)
BC273B	B/B	DEL, CVD	6 7/8
BC273WB	B/B	DEL, CVD	6 7/8

Noir METZENBAUM Dissecting Scissors

Catalog Number	Tip	Blade	Length (in.)
BC261B	B/B	CVD	5 3/4
BC261WB	B/B	CVD	5 3/4
BC263B	B/B	CVD	7
BC263WB	B/B	CVD	7
BC271B	B/B	DEL, CVD	7
BC271WB	B/B	DEL, CVD	7
BC265B	B/B	CVD	7 7/8
BC265WB	B/B	CVD	7 7/8
BC275B	B/B	DEL, CVD	7 7/8
BC275WB	B/B	DEL, CVD	7 7/8
BC267B	B/B	CVD	9
BC267WB	B/B	CVD	9
BC277B	B/B	DEL, CVD	9
BC277WB	B/B	DEL, CVD	9

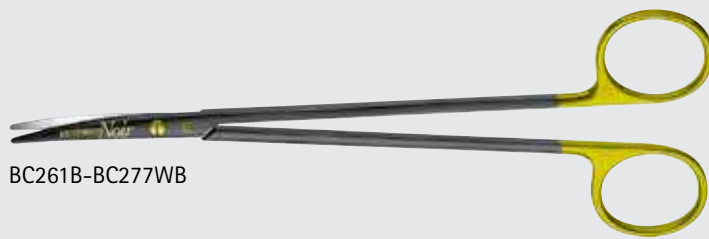

BC261B-BC277WB



BC261B, BC261WB



BC263B, BC263WB



BC271B, BC271WB



BC265B, BC265WB



BC275B, BC275WB



BC267B, BC267WB



BC277B, BC277WB

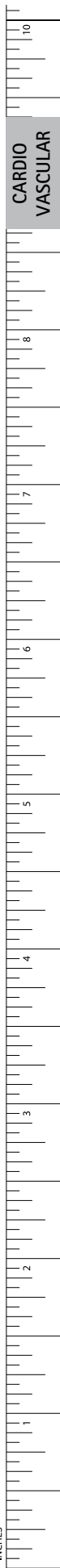

# Cardiovascular

## Noir™ Supreme Cut Scissors

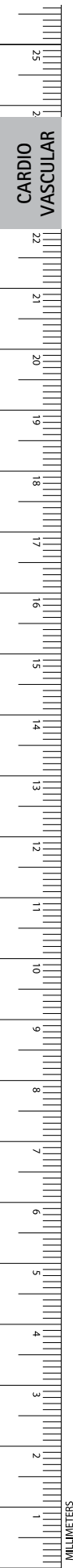

### Noir NELSON-METZENBAUM Dissecting Scissors

Catalog Number	Tip	Blade	Length (in.)
BC279B	B/B	DEL, CVD	10 1/4
BC279WB	B/B	DEL, CVD	10 1/4
BC281B	B/B	DEL, CVD	11
BC281WB	B/B	DEL, CVD	11

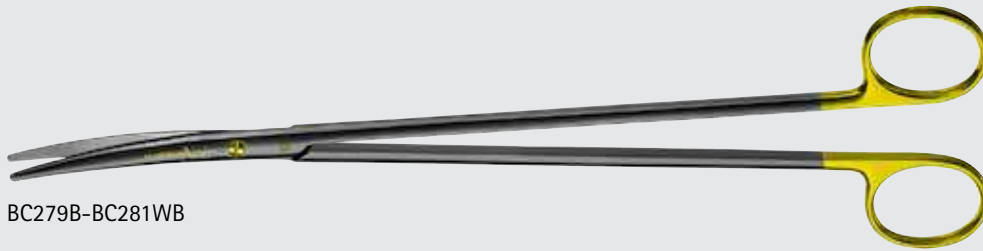

BC279B-BC281WB



BC279B, BC279WB



BC281B, BC281WB



FD020R-FD021R

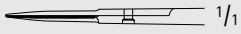

FD020R

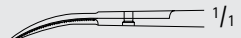

FD021R

**MILLES Micro Scissors**

Catalog Number	Tip	Blade	Handle	Length (in.)
FD020R	S/S	STR, SERR	FLAT, SERR	6 1/4
FD021R	S/S	CVD, SERR	FLAT, SERR	6 1/4

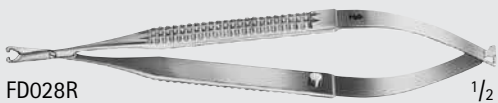

FD028R

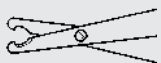
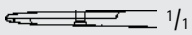

FD028R

**MILLES Micro Scissors**

Catalog Number	Tip	Blade	Handle	Length (in.)
FD020R	S/S	STR, SERR	FLAT, SERR	6 1/4
FD021R	S/S	CVD, SERR	FLAT, SERR	6 1/4

**BIEMER Vein Scissors**

Catalog Number	Blade	Handle	Length (in.)
FD028R	STR	FLAT, SERR	5 1/8

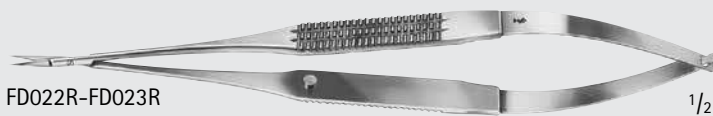

FD022R-FD023R

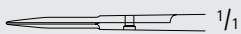

FD022R

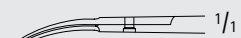

FD023R

**YASARGIL Micro Vessel Scissors**

Catalog Number	Blade	Handle	Length (in.)
FD022R	STR	FLAT, SERR	7 1/4
FD023R	CVD	FLAT, SERR	7 1/4

# Cardiovascular

## Micro Scissors

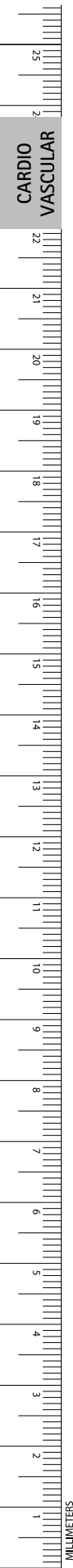

FM430R-FM474R

1/2

**Blade: STR**

**Blade: 25°**

**Blade: 45°**



FM444R

1/1



FM431R

1/1



FM432R

1/1



FM442R

1/1



FM437R

1/1



FM438R

1/1

**Blade: CVD**



FM430R

1/1

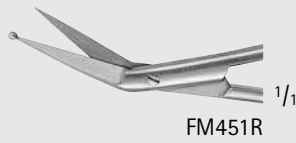

FM451R

1/1



FM452R

1/1



FM436R

1/1



FM470R

1/1



FM471R

1/1

**Blade: 60°**

**Blade: 90°**

**Blade: 125°**



FM433R

1/1



FM434R

1/1



FM435R

1/1



FM439R

1/1



FM440R

1/1



FM441R

1/1



FM453R

1/1

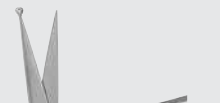

FM454R

1/1



FM455R

1/1



FM472R

1/1



FM473R

1/1



FM474R

1/1

### Micro Scissors, Flat Handle

Catalog Number	Tip	Blade	Blade Angle	Blade Length (mm)	Length (in.)
FM444R	S/S	X-DEL	STR	7	6 1/2
FM430R	S/S	X-DEL	CVD	7	6 1/2
FM431R	S/S	X-DEL	25°	7	6 1/2
FM432R	S/S	X-DEL	45°	7	6 1/2
FM433R	S/S	X-DEL	60°	7	6 1/2
FM434R	S/S	X-DEL	90°	7	6 1/2
FM435R	S/S	X-DEL	125°	7	6 1/2
FM442R	S/S	DEL	STR	10	6 1/2
FM436R	S/S	DEL	CVD	10	6 1/2
FM437R	S/S	DEL	25°	10	6 1/2
FM438R	S/S	DEL	45°	10	6 1/2
FM439R	S/S	DEL	60°	10	6 1/2
FM440R	S/S	DEL	90°	10	6 1/2
FM441R	S/S	DEL	125°	10	6 1/2
FM451R	S/1 BALL-PT	FINE	25°	15	6 1/2
FM452R	S/1 BALL-PT	FINE	45°	15	6 1/2
FM453R	S/1 BALL-PT	FINE	60°	15	6 1/2
FM454R	S/1 BALL-PT	FINE	90°	15	6 1/2
FM455R	S/1 BALL-PT	FINE	125°	15	6 1/2
FM470R	S/S	FINE	25°	15	6 1/2
FM471R	S/S	FINE	45°	15	6 1/2
FM472R	S/S	FINE	60°	15	6 1/2
FM473R	S/S	FINE	90°	15	6 1/2
FM474R	S/S	FINE	125°	15	6 1/2



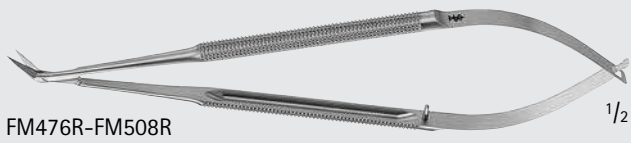

Blade: STR



Blade: 25°



Blade: 45°



Blade: CVD



Blade: 60°



Blade: 90°



Blade: 125°

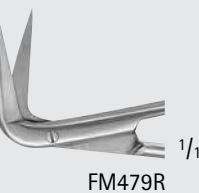
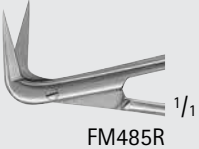

Micro Scissors, Round Handle

Catalog Number	Tip	Blade	Blade Angle	Blade Length (mm)	Length (in.)
FM503R	S/S	X-DEL	CVD	7	6 1/2
FM504R	S/S	X-DEL	25°	7	6 1/2
FM505R	S/S	X-DEL	45°	7	6 1/2
FM506R	S/S	X-DEL	60°	7	6 1/2
FM507R	S/S	X-DEL	90°	7	6 1/2
FM508R	S/S	X-DEL	125°	7	6 1/2
FM488R	S/S	DEL	STR	10	6 1/2
FM481R	S/S	DEL	CVD	10	6 1/2
FM482R	S/S	DEL	25°	10	6 1/2
FM483R	S/S	DEL	45°	10	6 1/2
FM484R	S/S	DEL	60°	10	6 1/2
FM485R	S/S	DEL	90°	10	6 1/2
FM486R	S/S	DEL	125°	10	6 1/2
FM489R	S/1 BALL-PT	DEL	25°	10	6 1/2
FM490R	S/1 BALL-PT	DEL	45°	10	6 1/2
FM491R	S/1 BALL-PT	DEL	60°	10	6 1/2
FM492R	S/1 BALL-PT	DEL	90°	10	6 1/2
FM493R	S/1 BALL-PT	DEL	125°	10	6 1/2
FM476R	S/S	FINE	25°	15	6 1/2
FM477R	S/S	FINE	45°	15	6 1/2
FM478R	S/S	FINE	60°	15	6 1/2
FM479R	S/S	FINE	90°	15	6 1/2
FM480R	S/S	FINE	125°	15	6 1/2



# Cardiovascular

## Special CV Scissors

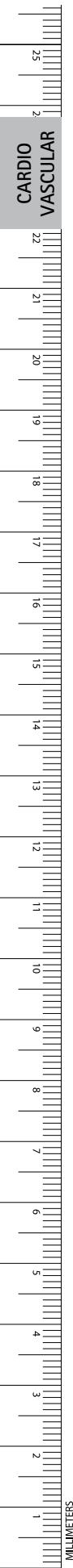

FD056R-FD057R

### NAGEL Micro Scissors

Catalog Number	Tip	Blade	Length (in.)
FD056R	S/S	45°	7 7/8
FD057R	PROBE	45°	7 7/8

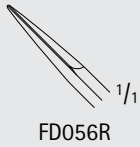

FD056R

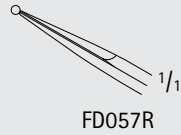

FD057R



FD059R

### DEBAKEY Circumflex Micro Scissors

Catalog Number	Tip	Blade	Length (in.)
FD059R	S/S	125°	7 1/2



FD059R



FD100R-FD103R

### Micro Scissors

Catalog Number	Tip	Blade	Handle	Length (in.)
FD100R	S/S	STR	ROUND	5 3/4
FD101R	S/S	CVD	ROUND	5 3/4
FD103R	B/B	CVD	ROUND	5 3/4

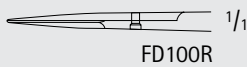

FD100R

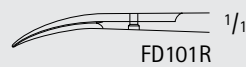

FD101R



FD103R



FD105R-FD108R

### Micro Vessel Scissors

Catalog Number	Tip	Blade	Length (in.)
FD105R	S/S	STR	7 1/2
FD106R	S/S	CVD	7 1/2
FD107R	S/S	DEL, STR	7 1/2
FD108R	S/S	DEL, CVD	7 1/2

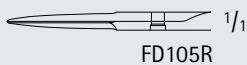

FD105R

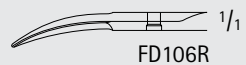

FD106R

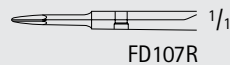

FD107R

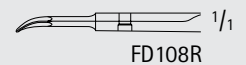

FD108R

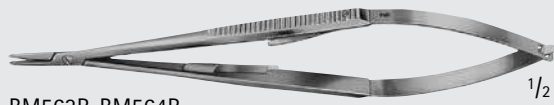

BM563R-BM564R

**CASTROVIEJO Micro Needle Holder,  
W/ Catch**

Catalog Number	Tip	Jaw	Length (in.)
BM563R	STR	SMOOTH	5 3/4
BM564R	CVD	SMOOTH	5 3/4

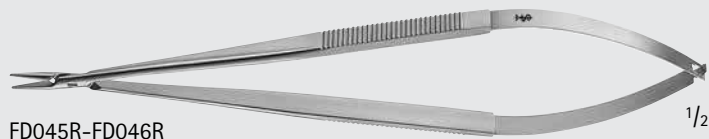
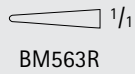

FD045R-FD046R

**JACOBSON Micro Needle Holder**

Catalog Number	Handle	Jaw	Length (in.)
FD045R	W/O CATCH	SMOOTH	7 1/4
FD046R	W/ CATCH	SMOOTH	7 1/4



FD048R

**Micro Needle Holder, W/ Catch**

Catalog Number	Jaw	Length (in.)
FD048R	SMOOTH	7 7/8

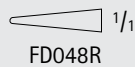

FD076R-FD079R

**Micro Needle Holder, W/O Catch**

Catalog Number	Tip	Jaw	Length (in.)
FD076R	STR	SMOOTH	6 1/4
FD079R	CVD	SMOOTH	6 1/4



FD080R-FD081R

**Micro Needle Holder, W/O Catch**

Catalog Number	Tip	Jaw	Length (in.)
FD080R	STR	SMOOTH	7 1/4
FD081R	CVD	SMOOTH	7 1/4

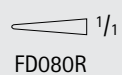

# Cardiovascular

## Micro Needle Holders

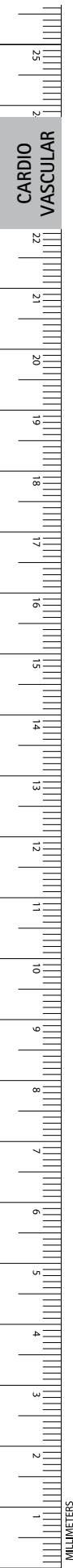

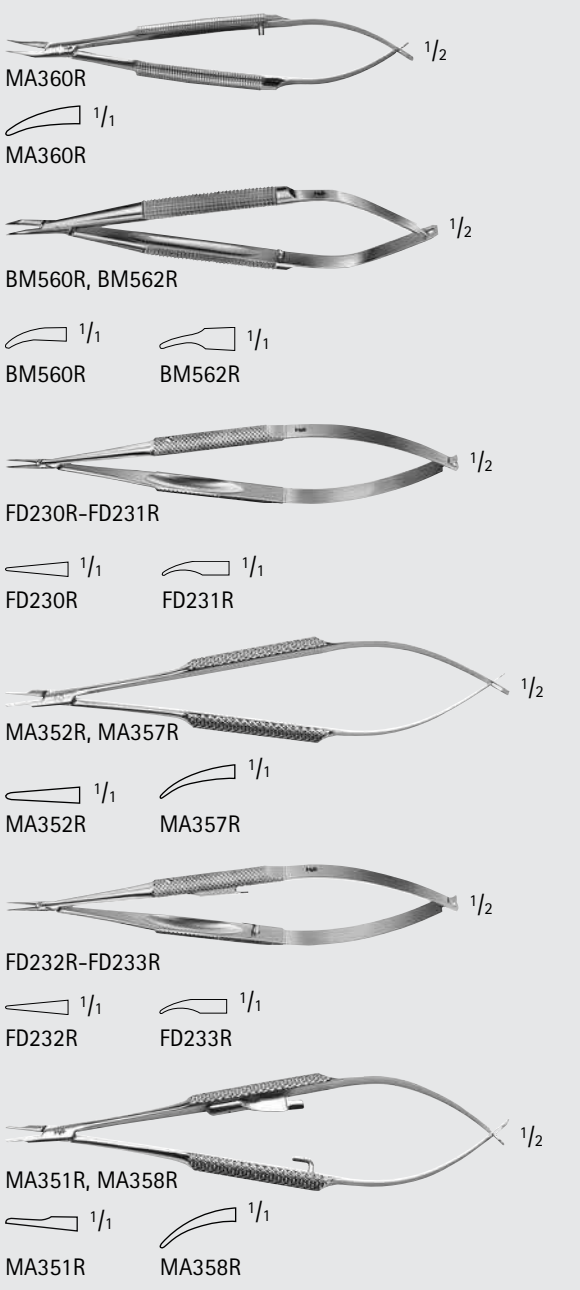

**Micro Needle Holder, Bayonet-Shaped**

Catalog Number	Tip	Length (in.)
FD120R	CVD-UP	7 3/4

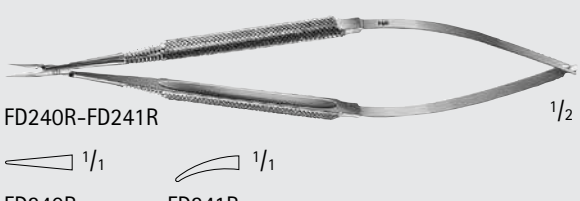

**BARRAQUER Micro Needle Holder, Round Knurled Handle**

Catalog Number	Tip	Handle	Length (in.)
FD230R	STR	W/O CATCH	4 3/4
MA352R	STR	W/O CATCH	5 1/4
BM562R	CVD, DEL	W/O CATCH	4 3/4
MA360R	CVD	W/O CATCH	4 1/4
BM560R	CVD	W/O CATCH	4 1/2
FD231R	CVD	W/O CATCH	4 3/4
MA357R	CVD	W/O CATCH	5 1/4
FD232R	STR	W/ CATCH	4 3/4
MA351R	STR	W/ CATCH	5 1/4
FD233R	CVD	W/ CATCH	4 3/4
MA358R	CVD	W/ CATCH	5 1/4



**REILL Micro Needle Holder, W/O Catch**

Catalog Number	Tip	Jaw	Length (in.)
FD240R	STR	SMOOTH	6
FD241R	CVD	SMOOTH	6



FD242R-FD243R

1/2



FD242R

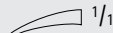

FD243R

Micro Needle Holder, Round Knurled Handle W/ Catch

Catalog Number	Tip	Jaw	Length (in.)
FD242R	STR	SMOOTH	6
FD243R	CVD	SMOOTH	6



FD244R-FD245R

1/2



FD244R



FD245R

Micro Needle Holder, Round Knurled Handle W/O Catch

Catalog Number	Tip	Jaw	Length (in.)
FD244R	STR	SMOOTH	7 1/4
FD245R	CVD	SMOOTH	7 1/4

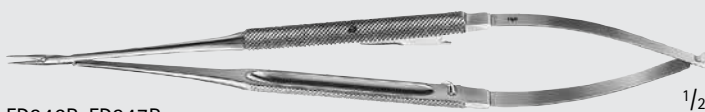

FD246R-FD247R

1/2

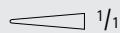

FD246R

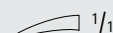

FD247R

Micro Needle Holder, Round Knurled Handle W/ Catch

Catalog Number	Tip	Jaw	Length (in.)
FD246R	STR	SMOOTH	7 1/4
FD247R	CVD	SMOOTH	7 1/4



FM392R

1/2



FM392R

Round Knurled Handle Micro Needle Holder, W/ Catch

Catalog Number	Tip	Jaw	Length (in.)
FM392R	STR	SMOOTH	9



FM021R

1/2



FM021R

MUELLER Micro Needle Holder, Plastic Handle W/ Catch

Catalog Number	Tip	Length (in.)
FM021R	CVD	5 3/4

# Cardiovascular

## DUROGRIP™ TC Micro Needle Holders

Aesculap features Needle Holders with Tungsten Carbide (TC) inserts. A smooth jaw and three different serration patterns are available, depending on the size of the suture needle.

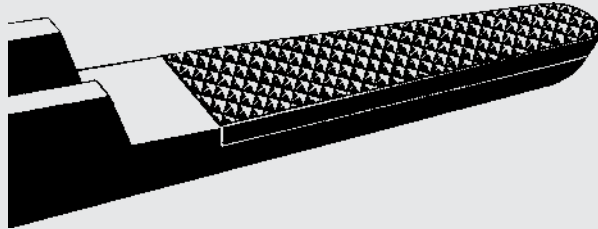
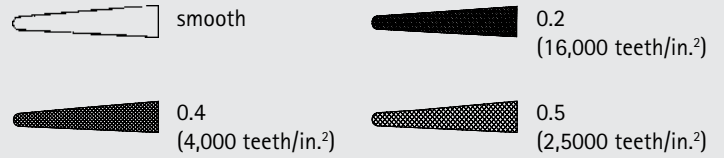

We recommend carbide inserts as follows:

Jaw Surface	Suture Material
Smooth	9/0 - 11/0
0.2 mm pitch of serration	6/0 - 10/0
0.4 mm pitch of serration	4/0 - 6/0
0.5 mm pitch of serration	up to 3/0

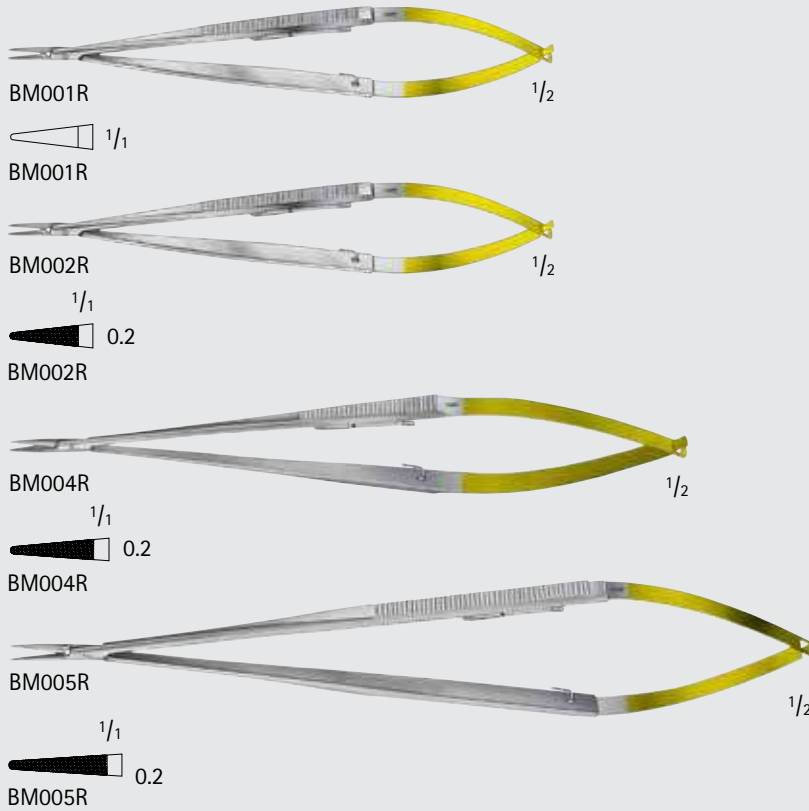

### DUROGRIP TC CASTROVIEJO Micro Needle Holder, Flat Handle

Catalog Number	Jaw	Length (in.)
BM001R	SMOOTH	5 3/4
BM002R	SERR	5 3/4
BM004R	SERR	7
BM005R	SERR	8 1/2

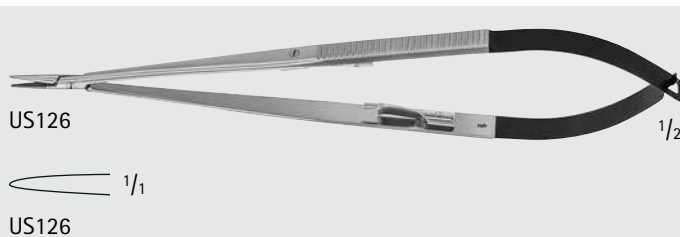

### DUROGRIP TC SPENCER Coronary Needle Holder

Catalog Number	Jaw	Length (in.)
US126	SMOOTH	7







MB362R 1/2



MB362R

Catalog Number	Jaw	Length (in.)
MB362R	SERR	8 3/4



MB214R 1/2

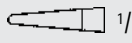

MB214R

Catalog Number	Jaw	Length (in.)
MB214R	SMOOTH	7 1/4

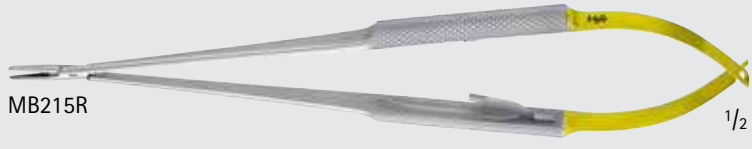

MB215R 1/2

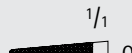

MB215R

Catalog Number	Jaw	Length (in.)
MB215R	SERR	8



FM388R-FM390R



FM388R



FM390R

Catalog Number	Jaw	Length (in.)
FM388R	SERR	7
FM390R	SERR	7 7/8



MG070R 1/2



MG070R

Catalog Number	Jaw	Length (in.)
MG070R	SERR	10 1/2

# Cardiovascular

## Dia Dust™ Micro Needle Holders



■ Dia Dust diamond dust coating ensures an even harder and more wear resistant surface on the inside of the jaws. The structure of the Dia Dust coating enables a reliable grip for fine needles, sutures, and tissue.

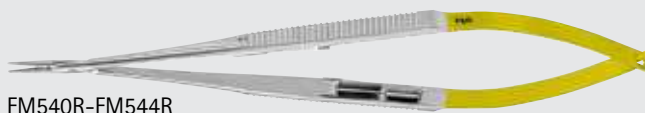

FM540R-FM544R



FM540R



FM541R-FM544R

### Dia Dust Micro Needle Holder, Flat Handle W/ Catch

Catalog Number	Tip	Suture Size	Length (in.)
FM540R	STR	7/0 AND SMALLER	6 3/4
FM541R	STR	5/0 AND SMALLER	5 3/4
FM542R	STR	5/0 AND SMALLER	7 1/4
FM543R	STR	5/0 AND SMALLER	8 1/4
FM544R	STR	5/0 AND SMALLER	9



FM545R-FM549R



FM545R-FM549R

1/2

### Dia Dust Micro Needle Holder, Flat Handle W/O Catch

Catalog Number	Tip	Suture Size	Length (in.)
FM545R	STR	7/0 AND SMALLER	6 3/4
FM546R	STR	5/0 AND SMALLER	5 3/4
FM547R	STR	5/0 AND SMALLER	7 1/4
FM548R	STR	5/0 AND SMALLER	8 1/4
FM549R	STR	5/0 AND SMALLER	9

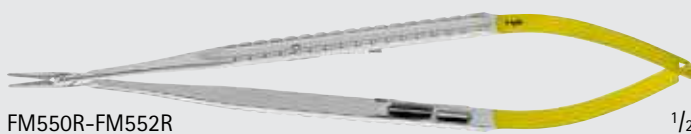

FM550R-FM552R



FM550R-FM552R

1/2

### Dia Dust Micro Needle Holder, Flat Knurled Handle W/ Catch

Catalog Number	Tip	Suture Size	Length (in.)
FM550R	STR	5/0 AND SMALLER	7 1/4
FM551R	STR	5/0 AND SMALLER	8 1/4
FM552R	STR	5/0 AND SMALLER	9

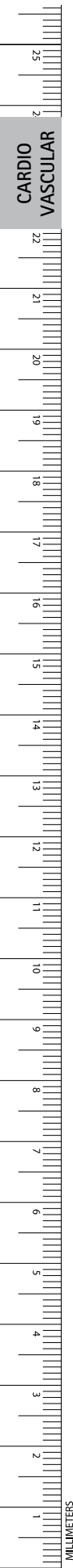



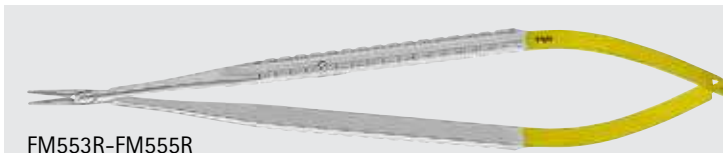
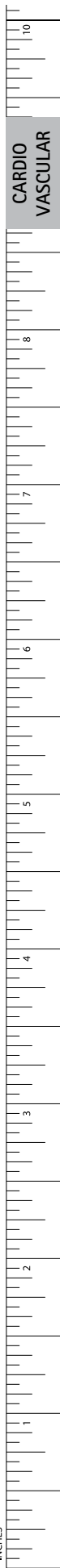

FM553R-FM555R



FM553R-FM555R

**Dia Dust Micro Needle Holder, Flat Knurled Handle W/O Catch**

Catalog Number	Tip	Suture Size	Length (in.)
FM553R	STR	5/0 AND SMALLER	7 1/4
FM554R	STR	5/0 AND SMALLER	8 1/4
FM555R	STR	5/0 AND SMALLER	9

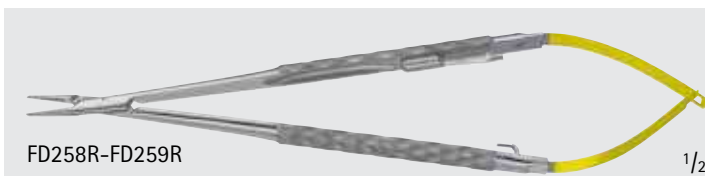

FD258R-FD259R



FD258R



FD259R

**Dia Dust Micro Needle Holder, Golf Ball Handle Design**

Catalog Number	Tip	Suture Size	Length (in.)
FD258R	STR	7/0 AND SMALLER	7
FD259R	CVD	7/0 AND SMALLER	7



FM218R-FM230R



FM218R-FM230R

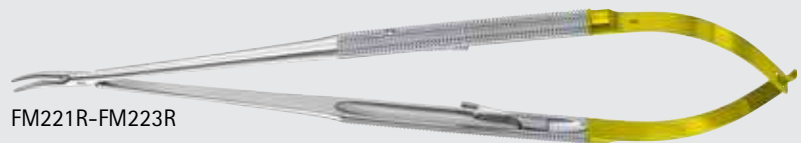

FM221R-FM223R



FM221R-FM223R

**Dia Dust Micro Needle Holder, Round Handle W/ Catch**

Catalog Number	Tip	Suture Size	Length (in.)
FM218R	STR	4/0 AND SMALLER	7 1/4
FM228R	STR	4/0 AND SMALLER	8 1/4
FM230R	STR	4/0 AND SMALLER	9
FM221R	CVD	4/0 AND SMALLER	8 1/4
FM223R	CVD	4/0 AND SMALLER	9

# Cardiovascular

## Dia Dust™ Micro Needle Holders

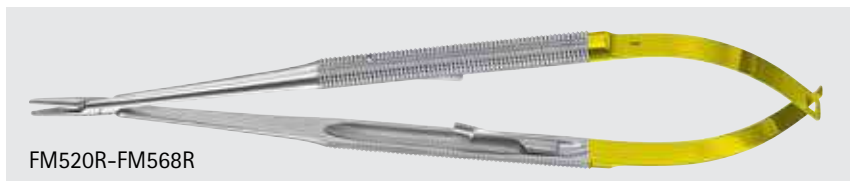
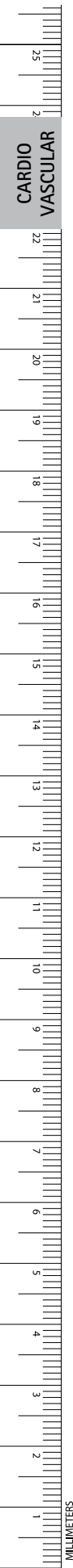

FM520R-FM568R



FM520R, FM521R, FM563R, FM565R, FM567R



FM522R, FM523R, FM564R, FM566R, FM568R

### Dia Dust Micro Needle Holder, Round Handle W/ Catch

Catalog Number	Tip	Suture Size	Length (in.)
FM520R	STR	7/0 AND SMALLER	4 3/4
FM521R	STR	7/0 AND SMALLER	6 1/4
FM563R	STR	7/0 AND SMALLER	7 1/4
FM565R	STR	7/0 AND SMALLER	8 1/4
FM567R	STR	7/0 AND SMALLER	9
FM522R	STR	5/0 AND SMALLER	5 3/4
FM523R	STR	5/0 AND SMALLER	6 1/4
FM564R	STR	5/0 AND SMALLER	7 1/4
FM566R	STR	5/0 AND SMALLER	8 1/4
FM568R	STR	5/0 AND SMALLER	9



FM524R-FM533R



FM524R-FM527R, FM532R



FM528R-FM531R, FM533R

### Dia Dust Micro Needle Holder, Round Handle W/O Catch

Catalog Number	Tip	Suture Size	Length (in.)
FM524R	STR	7/0 AND SMALLER	4 3/4
FM525R	STR	7/0 AND SMALLER	6 1/4
FM526R	STR	7/0 AND SMALLER	7 1/4
FM527R	STR	7/0 AND SMALLER	8 1/4
FM532R	STR	7/0 AND SMALLER	9
FM528R	STR	5/0 AND SMALLER	5 3/4
FM529R	STR	5/0 AND SMALLER	6 1/4
FM530R	STR	5/0 AND SMALLER	7 1/4
FM531R	STR	5/0 AND SMALLER	8 1/4
FM533R	STR	5/0 AND SMALLER	9

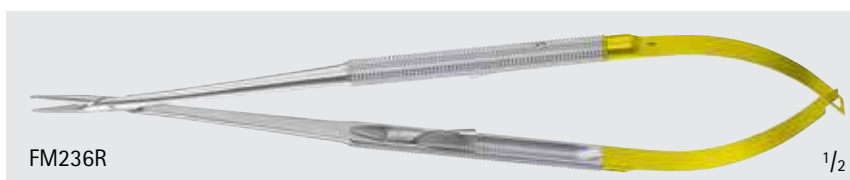

FM236R



1/2

### Dia Dust Micro Needle Holder, Round Handle W/ Catch

Catalog Number	Tip	Suture Size	Length (in.)
FM236R	STR	5/0 AND SMALLER	8 1/4

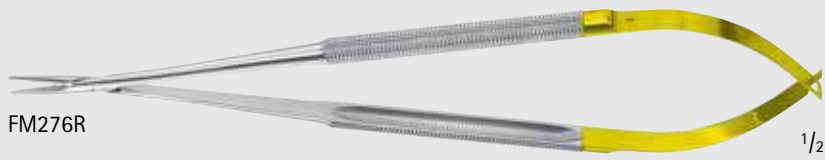



FM276R 1/2

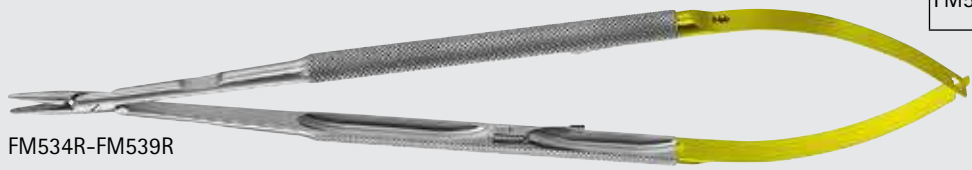

FM276R

Catalog Number	Tip	Suture Size	Length (in.)
FM276R	STR	5/0 AND SMALLER	8 1/4



FM534R-FM539R



FM534R-FM539R

Catalog Number	Tip	Description	Length (in.)
FM538R	STR	2/0 AND SMALLER	7 1/2
FM539R	STR	2/0 AND SMALLER	9
FM534R	STR	2/0 AND SMALLER	9 3/4



FM535R-FM537R



FM535R-FM537R

Catalog Number	Tip	Suture Size	Length (in.)
FM535R	STR	2/0 AND SMALLER	7 1/2
FM536R	STR	2/0 AND SMALLER	9
FM537R	STR	2/0 AND SMALLER	9 3/4

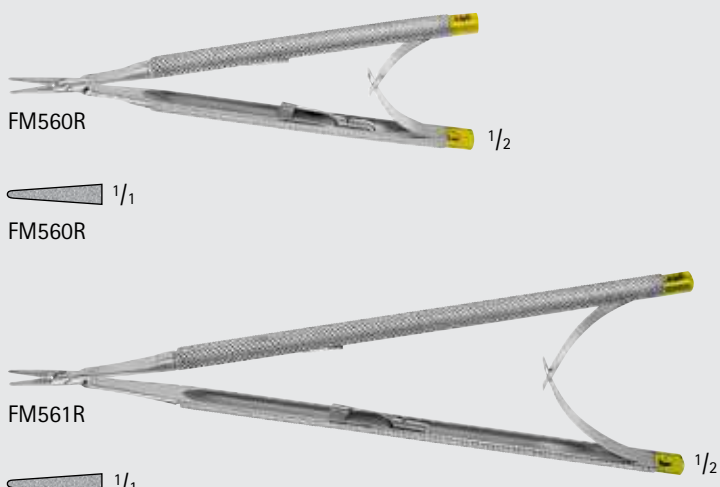

FM560R 1/2



FM560R

FM561R 1/2



FM561R

Catalog Number	Tip	Suture Size	Length (in.)
FM560R	STR	5/0 AND SMALLER	5
FM561R	STR	5/0 AND SMALLER	7

# Cardiovascular

## Titanium Micro Needle Holders

### Aesculap Titanium Micro Instruments

- The extremely light Titanium material is an advantage for lengthy cardiac and vascular operations. This helps to carry on operating over longer time periods with minimum fatigue.
- The non-magnetic material makes working with particularly fine needles easier for you.
- Non-reflecting surface finish.
- Incomparable operating sensitivity: the Aesculap golf ball handle design.
- Unmistakable identification: the Aesculap color code.

For more information about Titanium Micro Instruments see our brochure number DOC890.



All needle holder jaws are coated with Aesculap Dia Dust™ diamond dust coating. This coating ensures that the inner surfaces provide the best possible performance in hardness and wear resistance. The texture of the jaws greatly increases its surface area, allowing you to grasp fine needles, sutures and soft tissue safely and securely. The needle quickly aligns itself in an ideal position in the rough surface. This results in a perfect grip that quite simply prevents any needle slippage.

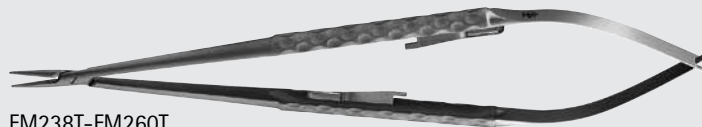

FM238T-FM260T



FM258T-FM260T



FM238T-FM240T

### Titanium Micro Needle Holder, Golf Ball Handle Design W/ Catch

Catalog Number	Tip	Suture Size	Handle Color	Length (in.)
FM258T	STR	7/0 AND SMALLER	GREEN	7 1/4
FM259T	STR	7/0 AND SMALLER	GREEN	8 1/4
FM260T	STR	7/0 AND SMALLER	GREEN	9
FM238T	STR	5/0 AND SMALLER	BLUE	7 1/4
FM239T	STR	5/0 AND SMALLER	BLUE	8 1/4
FM240T	STR	5/0 AND SMALLER	BLUE	9

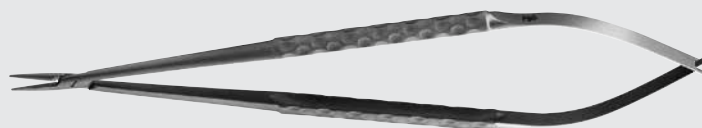

FM232T-FM254T



FM252T-FM254T



FM232T-FM234T

### Titanium Micro Needle Holder, Golf Ball Handle Design W/O Catch

Catalog Number	Tip	Suture Size	Handle Color	Length (in.)
FM252T	STR	7/0 AND SMALLER	GREEN	7 1/4
FM253T	STR	7/0 AND SMALLER	GREEN	8 1/4
FM254T	STR	7/0 AND SMALLER	GREEN	9
FM232T	STR	5/0 AND SMALLER	BLUE	7 1/4
FM233T	STR	5/0 AND SMALLER	BLUE	8 1/4
FM234T	STR	5/0 AND SMALLER	BLUE	9

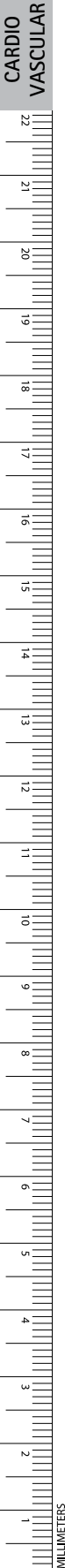



**Dia Dust RYDER Needle Holder**

Catalog Number	Tip	Suture Size	Length (in.)
BM301R	X-DEL	5/0 AND SMALLER	5 1/2
BM302R	X-DEL	5/0 AND SMALLER	7
BM325R	X-DEL	5/0 AND SMALLER	6 1/4
BM327R	X-DEL	5/0 AND SMALLER	8 3/4
BM328R	X-DEL	5/0 AND SMALLER	9 3/4

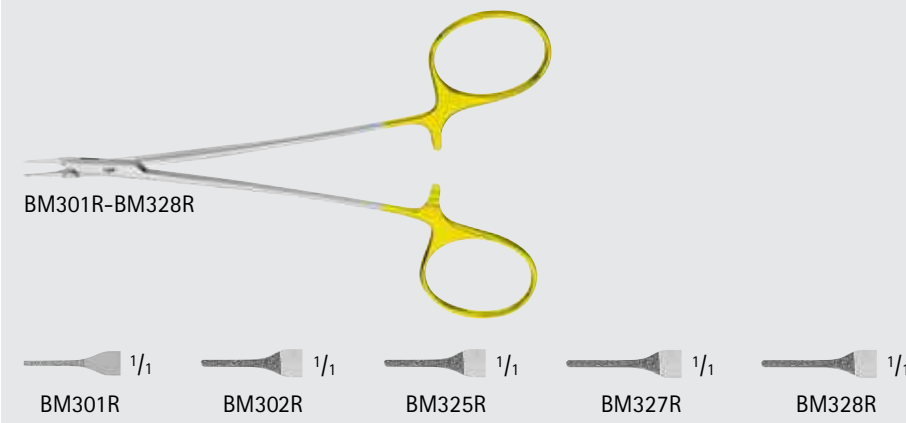

**Titanium Dia Dust RYDER Needle Holder**

Catalog Number	Tip	Suture Size	Length (in.)
BM385T	X-DEL	5/0 AND SMALLER	6 1/4
BM386T	X-DEL	5/0 AND SMALLER	7
BM387T	X-DEL	5/0 AND SMALLER	8 1/4

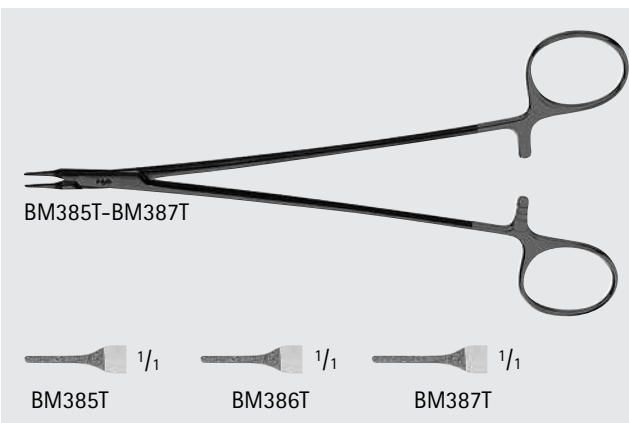

**DUROGRIP TC DEBAKEY Needle Holder, Offset**

Catalog Number	Jaw	Length (in.)
BM051R	SERR	7 3/4
BM052R	SERR	9 5/8

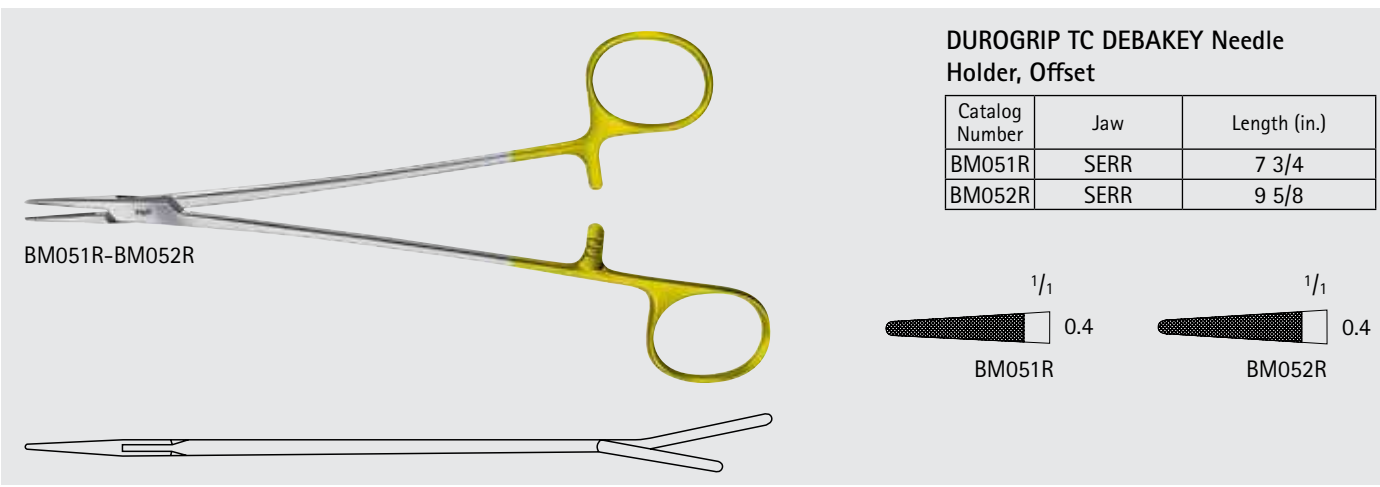

**DUROGRIP TC Microvascular Needle Holder**

Catalog Number	Jaw	Length (in.)
MG071R	SERR	6

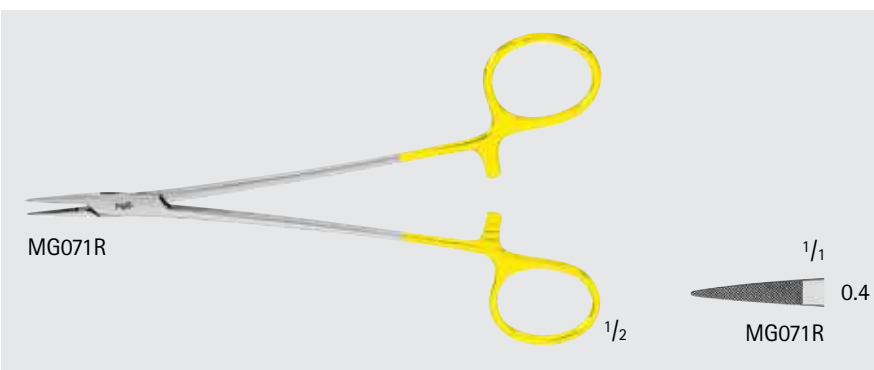

# Cardiovascular

## DUROGRIP™ TC Needle Holders

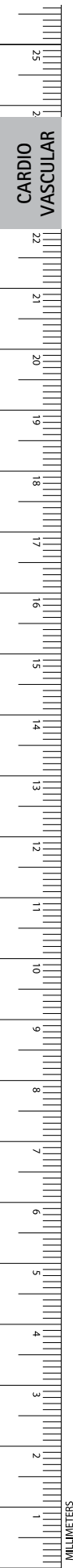

### DUROGRIP TC DEBAKEY Needle Holder

Catalog Number	Tip	Jaw	Length (in.)
BM032R	DEL	SERR	6
BM033R	DEL	SERR	6 1/2
BM035R	DEL	SERR	7
BM034R	DEL	SERR	8 1/4
BM036R	DEL	SERR	9
BM037R	DEL	SERR	10 1/4
BM038R	DEL	SERR	12
BM063R	X-DEL	SERR	6 1/2
BM064R	X-DEL	SERR	8 1/4
BM040R	X-DEL	SERR	12

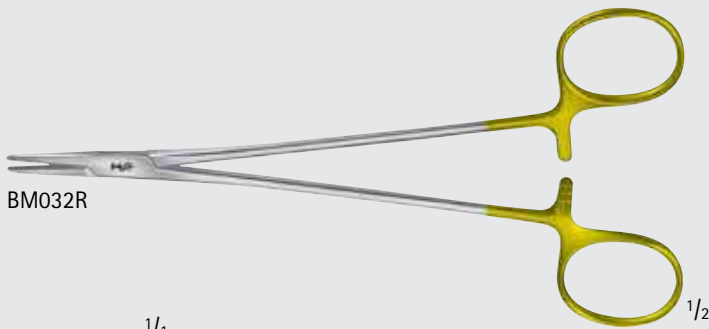

BM032R

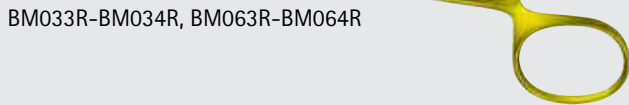
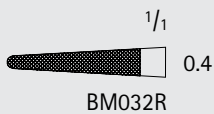

BM033R-BM034R, BM063R-BM064R



BM033R

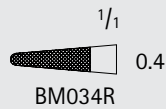

BM034R



BM063R

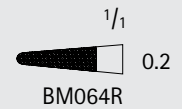

BM064R

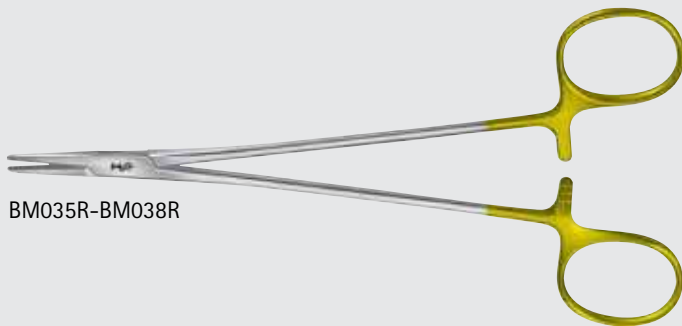

BM035R-BM038R

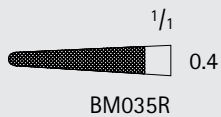

BM035R

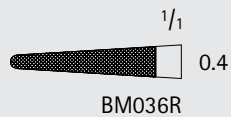

BM036R

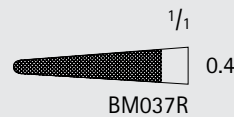

BM037R

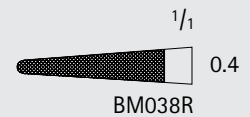

BM038R

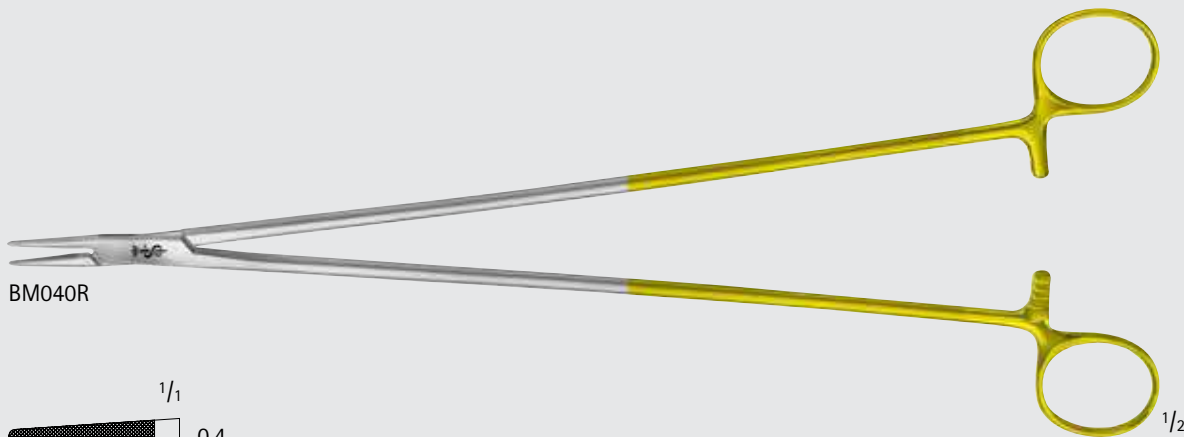

BM040R

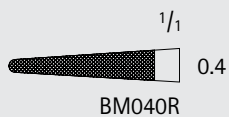

BM040R

DUROGRIP TC RYDER Needle Holder

Catalog Number	Tip	Jaw	Length (in.)
BM054R	X-DEL	SERR	5 1/4
BM055R	X-DEL	SERR	6 1/8
BM056R	X-DEL	SERR	6 7/8
BM057R	X-DEL	SERR	8 1/4
BM058R	X-DEL	SERR	9
BM044R	DEL	SERR	5 1/4
BM045R	DEL	SERR	6 7/8
BM046R	DEL	SERR	7 3/4
BM047R	DEL	SERR	10 1/2
BM074R	DEL	SMOOTH	6
BM075R	DEL	SMOOTH	7
BM076R	DEL	SMOOTH	8 7/8

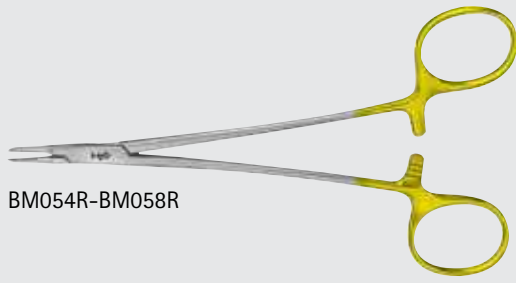

BM054R-BM058R

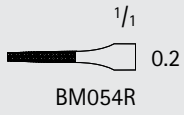

BM054R

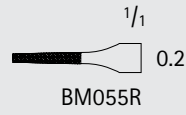

BM055R

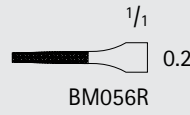

BM056R

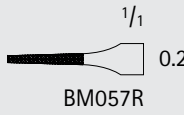

BM057R

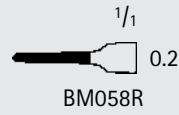

BM058R

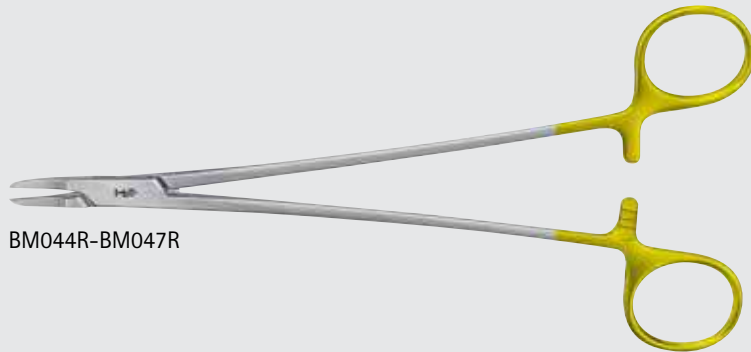

BM044R-BM047R

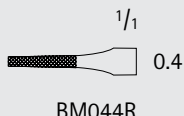

BM044R



BM045R

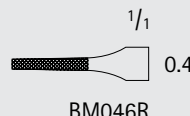

BM046R

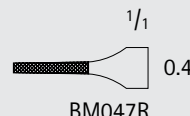

BM047R

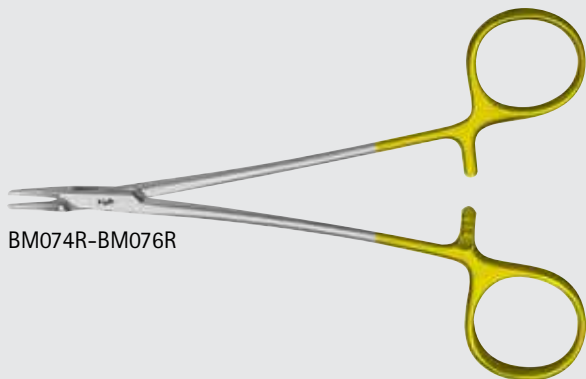

BM074R-BM076R



BM074R

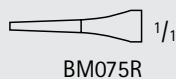

BM075R

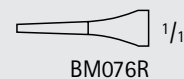

BM076R

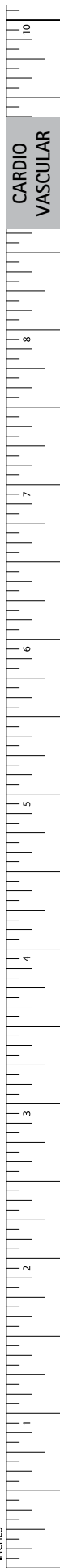

# Cardiovascular

## DUROGRIP™ TC Needle Holders

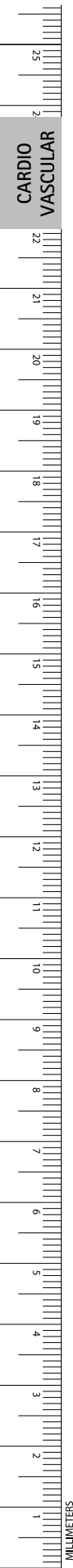

CARDIO  
VASCULAR

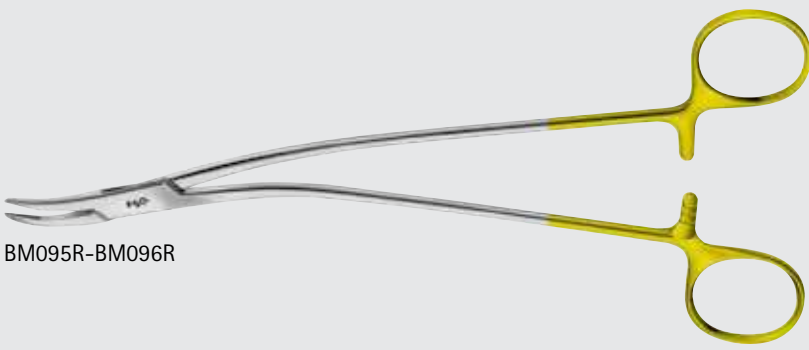

BM095R-BM096R

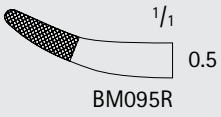

1/1  
0.5  
BM095R

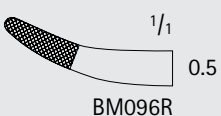

1/1  
0.5  
BM096R

Catalog Number	Tip	Jaw	Length (in.)
BM095R	CVD	SERR	8 1/4
BM096R	CVD	SERR	9

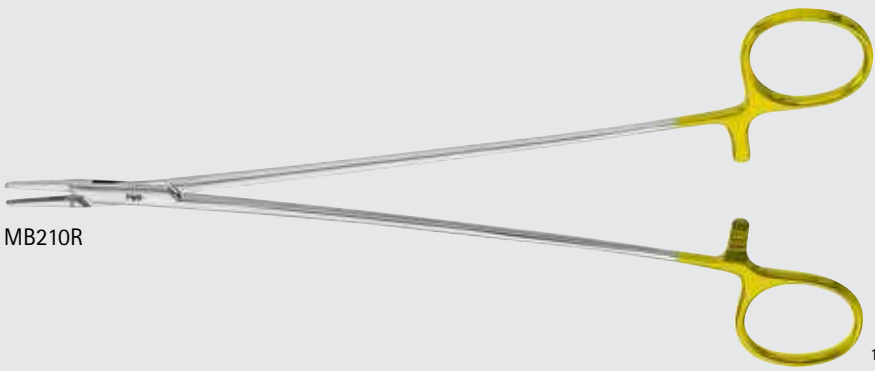

MB210R



1/1  
MB210R

Catalog Number	Jaw	Length (in.)
MB210R	SERR	9



**DEBAKEY Tissue Forceps**

Catalog Number	Tip Size (mm)	Length (in.)
MB062R	2	14
MB915R	2	16
MB916R	3	16



MB062R-MB916R



**WHEELER Vessel Forceps**

Catalog Number	Tip	Length (in.)
MG440R	SERR	6



MG440R



**GERALD Dressing Forceps, Delicate**

Catalog Number	Tip	Jaw	Length (in.)
BD228R	STR	SERR	6 7/8
BD230R	STR	SERR	9
BD229R	CVD	SERR	6 7/8



BD228R-BD230R

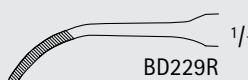
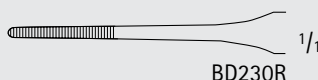
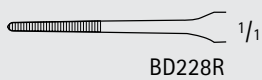

**GERALD Tissue Forceps, Delicate**

Catalog Number	Tip	Teeth	Length (in.)
BD662R	STR	1 x 2	6 7/8
BD664R	STR	1 x 2	9
BD663R	CVD	1 x 2	6 7/8



BD662R-BD664R

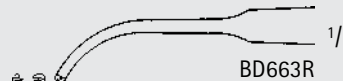
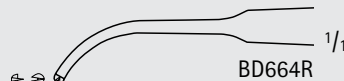
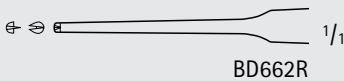

**SELMAN Tissue Forceps**

Catalog Number	Length (in.)
BD750R	6 1/8
MB795R	7 7/8
MG078R	9 3/4



BD750R, MB795R, MG078

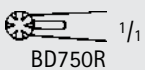

# Cardiovascular

## Forceps

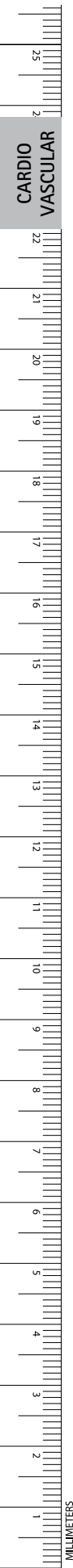
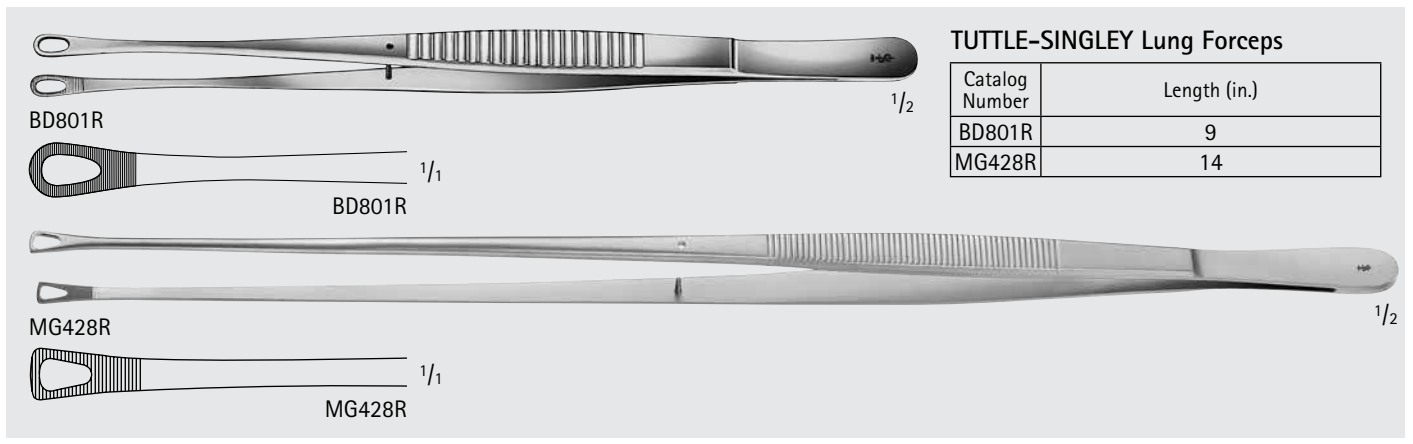
**TUTTLE-SINGLEY Lung Forceps**

Catalog Number	Length (in.)
BD801R	9
MG428R	14

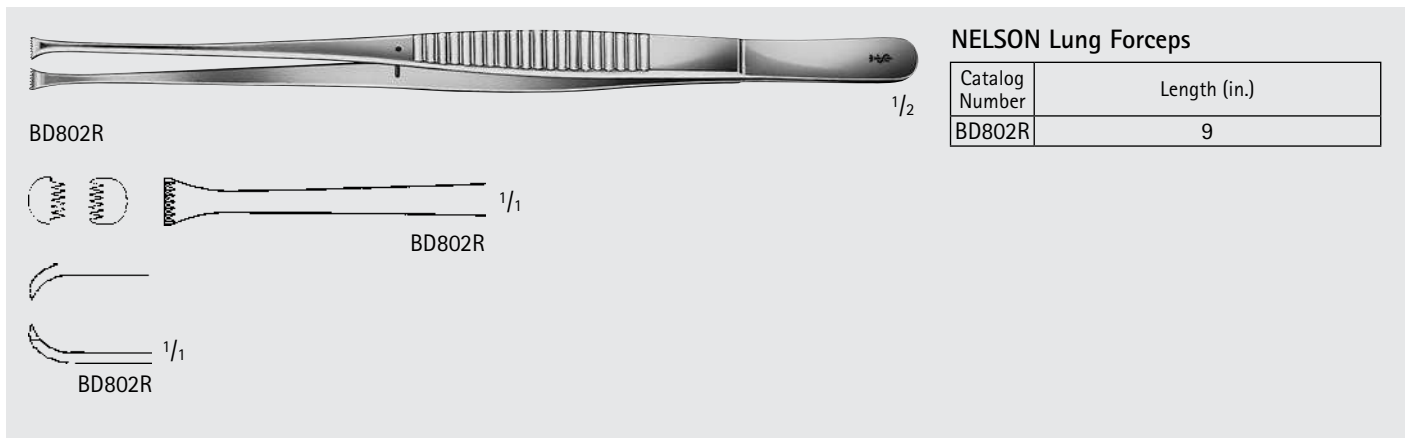

**NELSON Lung Forceps**

Catalog Number	Length (in.)
BD802R	9

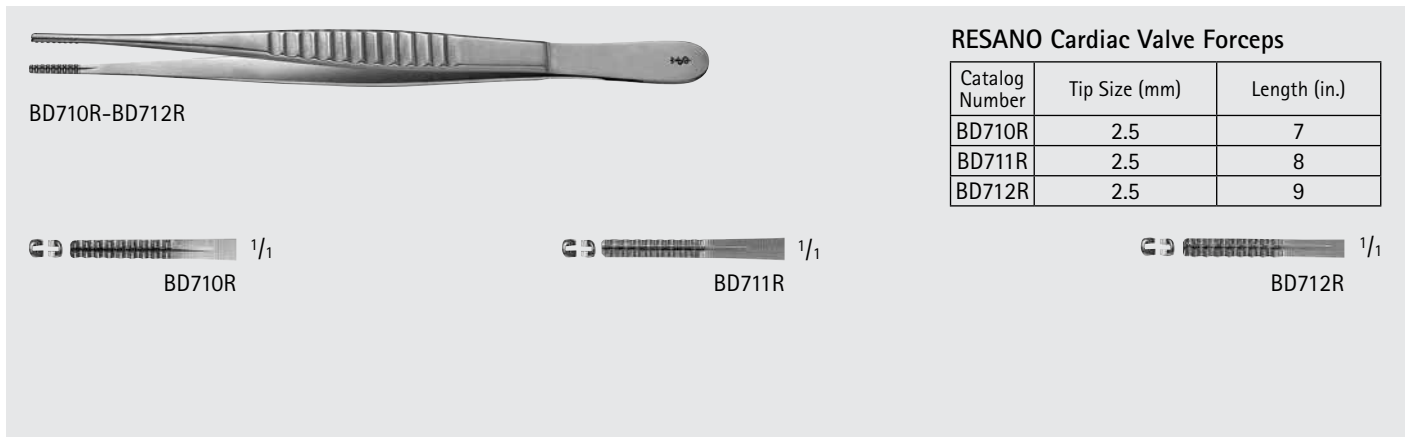

**RESANO Cardiac Valve Forceps**

Catalog Number	Tip Size (mm)	Length (in.)
BD710R	2.5	7
BD711R	2.5	8
BD712R	2.5	9

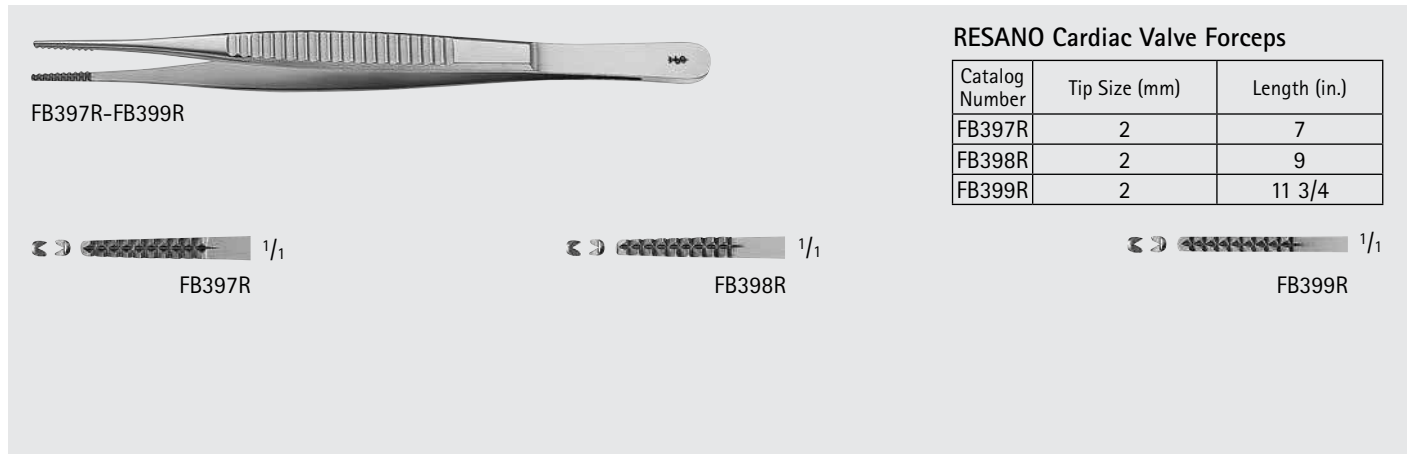

**RESANO Cardiac Valve Forceps**

Catalog Number	Tip Size (mm)	Length (in.)
FB397R	2	7
FB398R	2	9
FB399R	2	11 3/4

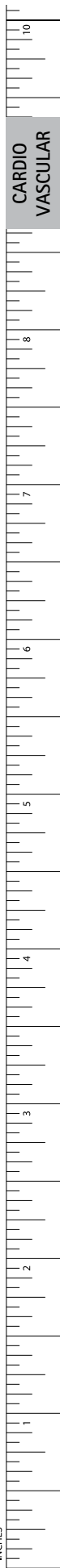

**GERALD Micro Forceps, Flat Handle**

Catalog Number	Tip	Length (in.)
BD190R	SERR	7
BD197R	SERR	9 3/4



BD190R-BD197R

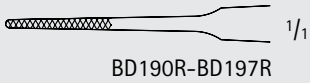

**GERALD Micro Forceps, Flat Handle**

Catalog Number	Tip	Length (in.)
BD191R	DEBAKEY	7
BD195R	DEBAKEY	7 7/8



BD191R-BD195R

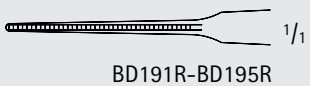

**Micro Suture Forceps, W/ Platform**

Catalog Number	Tip Size (mm)	Length (in.)
BD338R	0.3	4 3/4
BD264R	0.5	7 1/4



BD338R

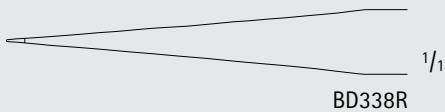

BD264R

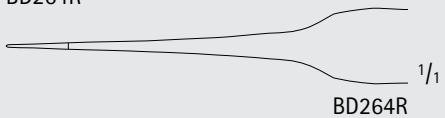

**MUELLER Micro Forceps, Plastic Handle**

Catalog Number	Teeth	Length (in.)
FM033R	-	6 1/4
FM034R	1 x 2	6 1/4



FM033R



FM033R



FM034R



FM034R

# Cardiovascular

## Forceps

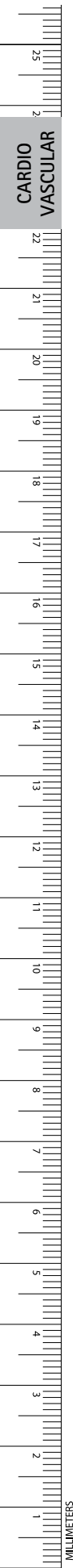

FM035R



FM035R

### MUELLER Micro Ring Forceps, Plastic Handle

Catalog Number	Diam. of Ring (mm)	Length (in.)
FM035R	1.2	6 1/4



FM036R



FM036R

### MUELLER Micro Forceps, Plastic Handle, W/ Platform

Catalog Number	Length (in.)
FM036R	6 1/4



FM063R

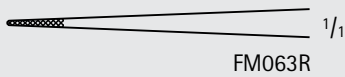

FM063R

### Micro Forceps, Round Handle

Catalog Number	Tip	Counter-balance	Length (in.)
FM063R	CROSS-SERR	NO	7 7/8



FM590R-FM591R



FM590R

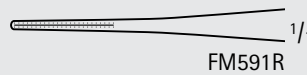

FM591R

### Micro Forceps, Round Handle

Catalog Number	Tip	Counter-balance	Length (in.)
FM590R	DEBAKEY	NO	7 1/4
FM591R	DEBAKEY	NO	8 1/4
FM592R	DEBAKEY	YES	7 1/4
FM600R	DEBAKEY	YES	8 1/4



FM592R-FM600R

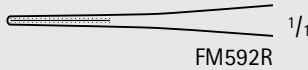

FM592R

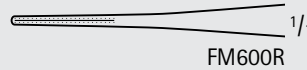

FM600R



BD154R



BD154R

### DUROGRIP TC (POTTS-SMITH) Thumb Forceps

Catalog Number	Tip	Length (in.)
BD154R	X-SERR	5 3/4

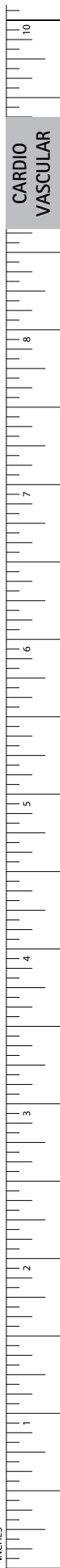

■ The Dia Dust diamond dust coating ensures an even harder and more wear resistant surface on the inside of the jaws. The structure of the Dia Dust coating enables a reliable grip for fine needles, sutures, and tissue.



BD192R-BD193R

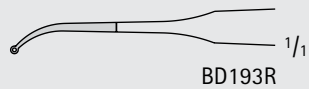
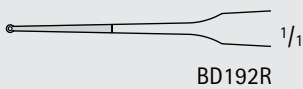

**Dia Dust GERALD Micro Ring Forceps, Flat Handle**

Catalog Number	Diam. of Ring (mm)	Tip	Length (in.)
BD192R	1.0	STR	7
BD193R	1.0	CVD	7



BD194R-BD196R

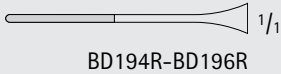

**Dia Dust GERALD Micro Forceps, Flat Handle**

Catalog Number	Tip	Tip Size (mm)	Length (in.)
BD194R	STR	1.0	7
BD196R	STR	1.0	7 7/8



BD200R-BD201R



BD200R-BD201R

**Dia Dust THUMB Forceps, Flat Handle**

Catalog Number	Tip	Tip Size (mm)	Length (in.)
BD200R	STR	1.0	7
BD201R	STR	1.0	8 1/4



FD253R

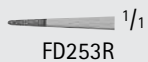

**Dia Dust Micro Forceps W/ Platform**

Catalog Number	Tip	Counter-balance	Length (in.)
FD253R	STR	NO	7

# Cardiovascular

## Dia Dust™ Forceps

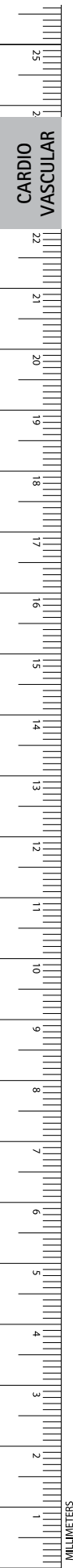

CARDIO  
VASCULAR



FM053R-FM054R



FM053R-FM054R

### Dia Dust Micro Ring Forceps, Round Handle

Catalog Number	Diam. of Ring (mm)	Tip	Counter-balance	Length (in.)
FM053R	2.5	STR	NO	7
FM054R	2.5	STR	NO	7 7/8

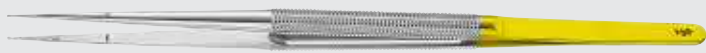

FM597R-FM598R

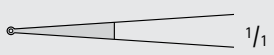

FM597R-FM598R



FM587R

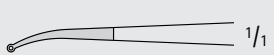

FM587R

### Dia Dust Micro Ring Forceps, Round Handle

Catalog Number	Diam. of Ring (mm)	Tip	Counter-balance	Length (in.)
FM597R	1.0	STR	NO	7 1/4
FM598R	1.0	STR	NO	8 1/4
FM587R	1.0	CVD	NO	7 1/4



FM582R-FM584R



FM582R-FM584R

### Dia Dust Micro Ring Forceps, W/ Platform, Round Handle

Catalog Number	Diam. of Ring (mm)	Tip	Counter-balance	Length (in.)
FM582R	1.0	STR	NO	7 1/4
FM584R	1.0	STR	NO	8 1/4



FM586R-FM588R



FM586R-FM588R

### Dia Dust Micro Forceps, W/ Platform, Round Handle

Catalog Number	Tip	Counter-balance	Length (in.)
FM586R	STR	NO	7 1/4
FM588R	STR	NO	8 1/4



**Dia Dust Micro Ring Forceps, Round Handle**

Catalog Number	Diam. of Ring (mm)	Tip	Counter-balance	Length (in.)
FM570R	1.0	STR	YES	6
FM572R	1.0	STR	YES	7 1/4
FM574R	1.0	STR	YES	8 1/4
FM576R	1.0	STR	YES	9
FM596R	1.0	STR	YES	9 3/4
FM579R	2.0	STR	YES	7 1/4
FM571R	1.0	CVD	YES	6
FM573R	1.0	CVD	YES	7 1/4
FM575R	1.0	CVD	YES	8 1/4
FM577R	1.0	CVD	YES	9
FM595R	1.0	CVD	YES	9 3/4

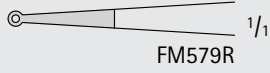
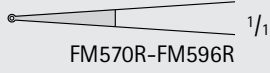

FM571R-FM595R

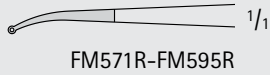

**Dia Dust Micro Forceps, W/ Platform, Round Handle**

Catalog Number	Tip	Counter-balance	Length (in.)
FM578R	STR	YES	6
FM580R	STR	YES	7 1/4
FM599R	STR	YES	8 1/4
FM594R	STR	YES	9 3/4
FM581R	CVD	YES	6
FM583R	CVD	YES	7 1/4
FM585R	CVD	YES	8 1/4
FM593R	CVD	YES	9 3/4

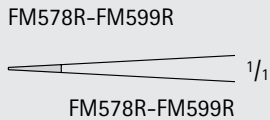
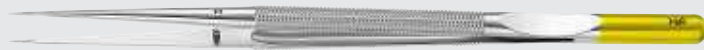

FM581R-FM593R

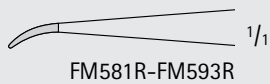

# Cardiovascular

## Titanium Forceps

### Aesculap Titanium Micro Instruments

- The extremely light Titanium material is an advantage for lengthy cardiac and vascular operations. This helps to carry on operating over longer time periods with minimum fatigue.
- Non-reflecting surface finish - for optimal glare reduction.
- The Aesculap golf ball handle design - gives incomparable operating sensitivity.
- The Aesculap color code - provides unmistakable instrument identification.



All titanium forceps jaws are coated with Aesculap Dia Dust™ diamond dust coating. This coating ensures that the inner surfaces provide the best possible performance in hardness and wear resistance. The texture of the jaws greatly increases its surface area, allowing you to grasp sutures and soft tissue safely and securely.

For more information about Titanium Micro Instruments see our brochure number **DOC890**.



FM317T-FM319T



FM317T-FM319T

### Titanium Micro Ring Forceps, Golf Ball Handle

Catalog Number	Diam. of Ring (mm)	Tip	Handle Color	Counter-balance	Length (in.)
FM317T	1.0	DIA DUST	BLUE	NO	7 1/4
FM318T	1.0	DIA DUST	BLUE	NO	8 1/4
FM319T	1.0	DIA DUST	BLUE	NO	9



FM327T-FM329T



FM327T-FM329T

### Titanium Micro Forceps, W/ Platform, Golf Ball Handle

Catalog Number	Tip	Handle Color	Counter-balance	Length (in.)
FM327T	DIA DUST	GREEN	NO	7 1/4
FM328T	DIA DUST	GREEN	NO	8 1/4
FM329T	DIA DUST	GREEN	NO	9



FM337T-FM339T



FM337T-FM339T

### Titanium Micro Forceps, Golf Ball Handle

Catalog Number	Tip	Handle Color	Counter-balance	Length (in.)
FM337T	DEBAKEY	PURPLE	NO	7 1/4
FM338T	DEBAKEY	PURPLE	NO	8 1/4
FM339T	DEBAKEY	PURPLE	NO	9

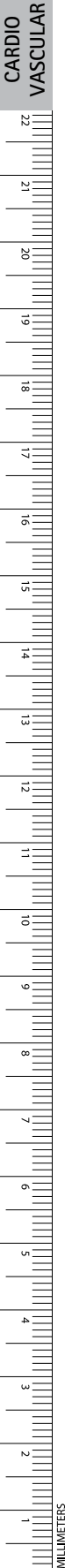





**Titanium Standard Forceps**

- Non-reflecting surface finish.
- Fatigue-free lightness.
- Blue handle for definite identification of an Aesculap Titanium Instrument.

For more information about Titanium forceps see our brochure number **DOC890**.

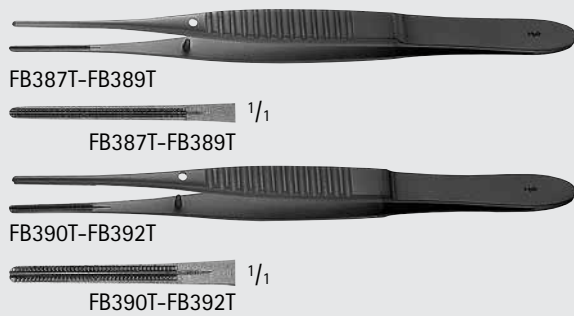

**Titanium DEBAKEY Atraumatic Forceps**

Catalog Number	Tip Size (mm)	Length (in.)
FB387T	1.5	5 3/4
FB388T	1.5	7 3/4
FB389T	1.5	9 1/2
FB390T	2.5	5 3/4
FB391T	2.5	7 3/4
FB392T	2.5	9 1/2



**Titanium Micro ADSON Dissecting Forceps**

Catalog Number	Tip	Length (in.)
BD221T	SERR	4 3/4

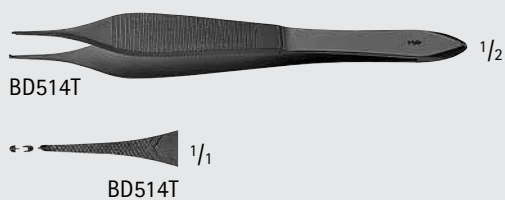

**Titanium Micro ADSON Tissue Forceps, Delicate**

Catalog Number	Tip	Teeth	Length (in.)
BD514T	SERR	1 x 2	4 3/4

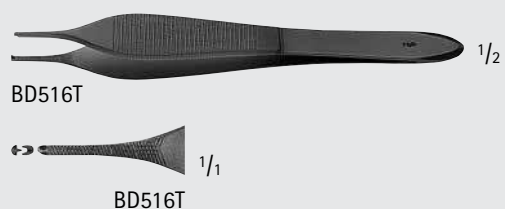

**Titanium Micro ADSON Tissue Forceps**

Catalog Number	Tip	Teeth	Length (in.)
BD516T	SERR	1 x 2	4 3/4

# Cardiovascular

## Titanium Forceps

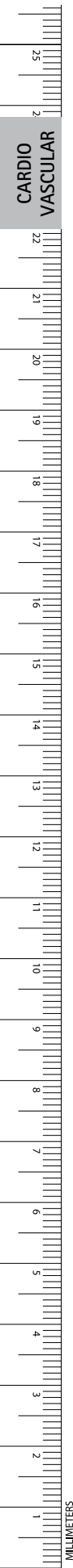

BD227T

1/2



BD227T

1/1

### Titanium GERALD Dissecting Forceps, Delicate

Catalog Number	Tip	Length (in.)
BD227T	SERR	6 3/4



BD657T

1/2



BD657T

1/1

### Titanium GERALD Tissue Forceps

Catalog Number	Tip	Teeth	Length (in.)
BD657T	SERR	1 x 2	6 3/4



BD715T

1/2



BD715T

1/1

### Titanium RESANO Grasping Forceps

Catalog Number	Tip	Length (in.)
BD715T	SERR	9



Titanium Ringhandled Instruments

- Non-reflecting surface finish.
- Fatigue-free lightness.
- Blue rings for definite identification of an Aesculap Titanium Instrument.

For more information about Titanium Ringhandled Instruments see our brochure number DOC890.

Titanium DEBAKEY Atraumatic  
Vascular Clamp

Catalog Number	Jaw	Jaw Length (mm)	Length (in.)
FC320T	STR	70	9

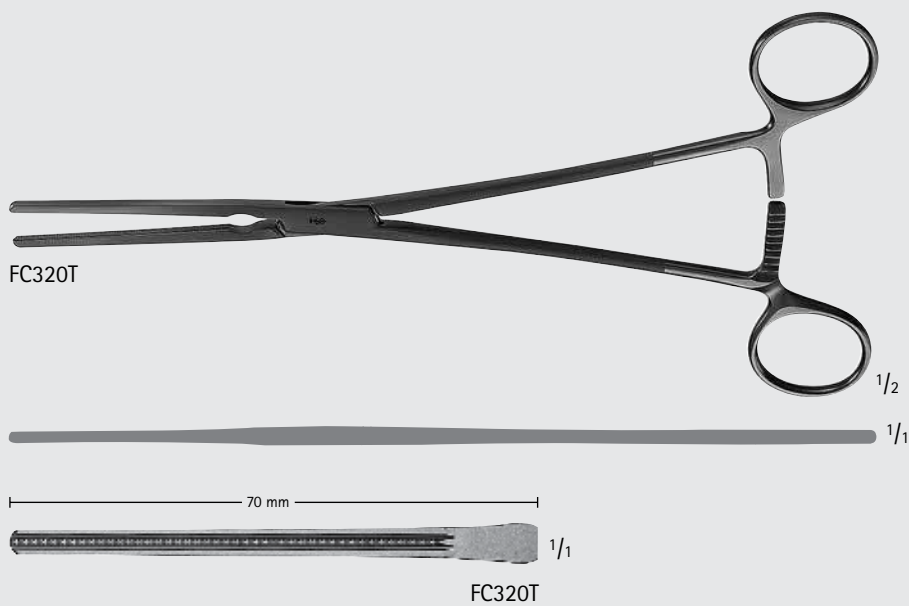

Titanium DEBAKEY Atraumatic  
Vascular Clamp

Catalog Number	Jaw	Jaw Length (mm)	Shaft	Length (in.)
FC321T	STR	60	ANG	8 1/2

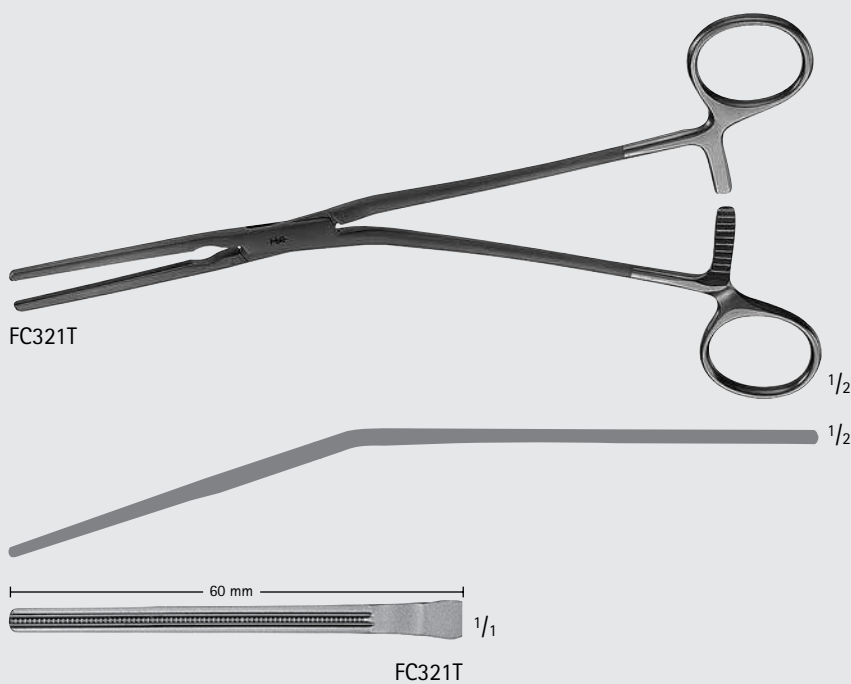

# Cardiovascular

## Titanium Clamps

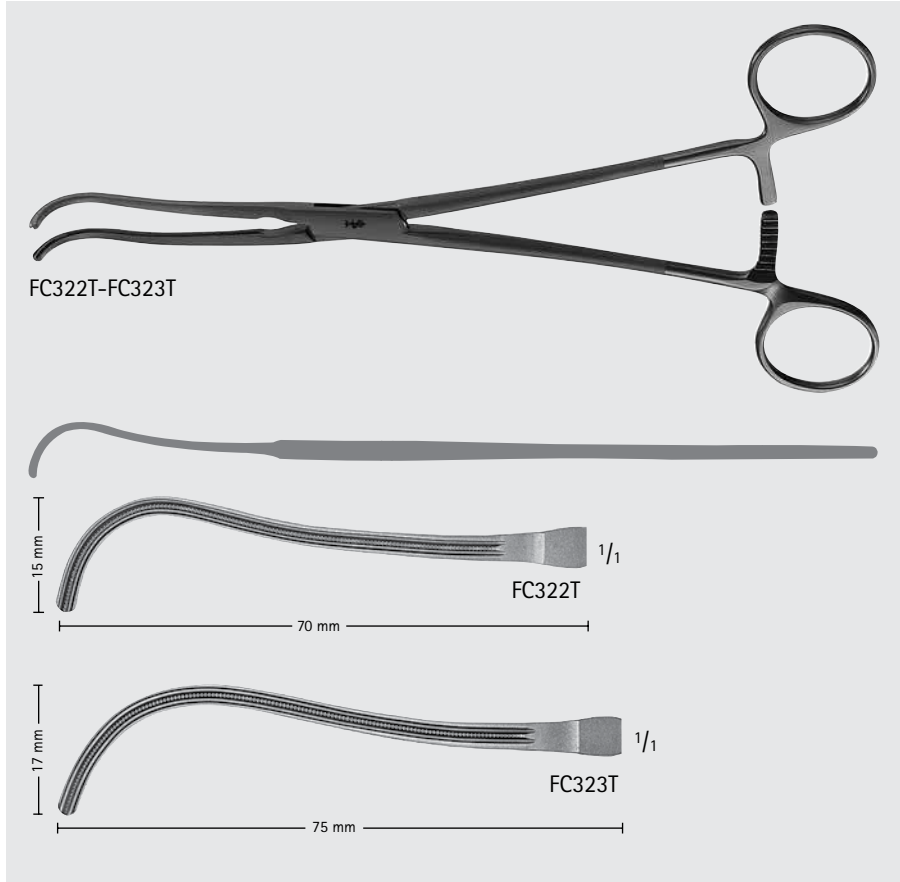
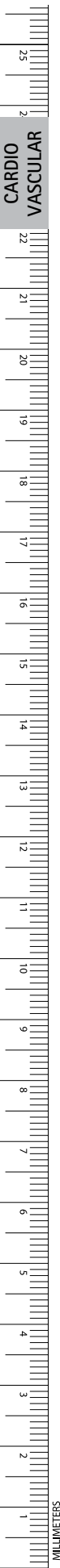

### Titanium DEBAKEY Atraumatic Vascular Clamp

Catalog Number	Jaw	Jaw Length (mm)	Length (in.)
FC322T	CVD	70	8 7/8
FC323T	CVD	75	9 5/8

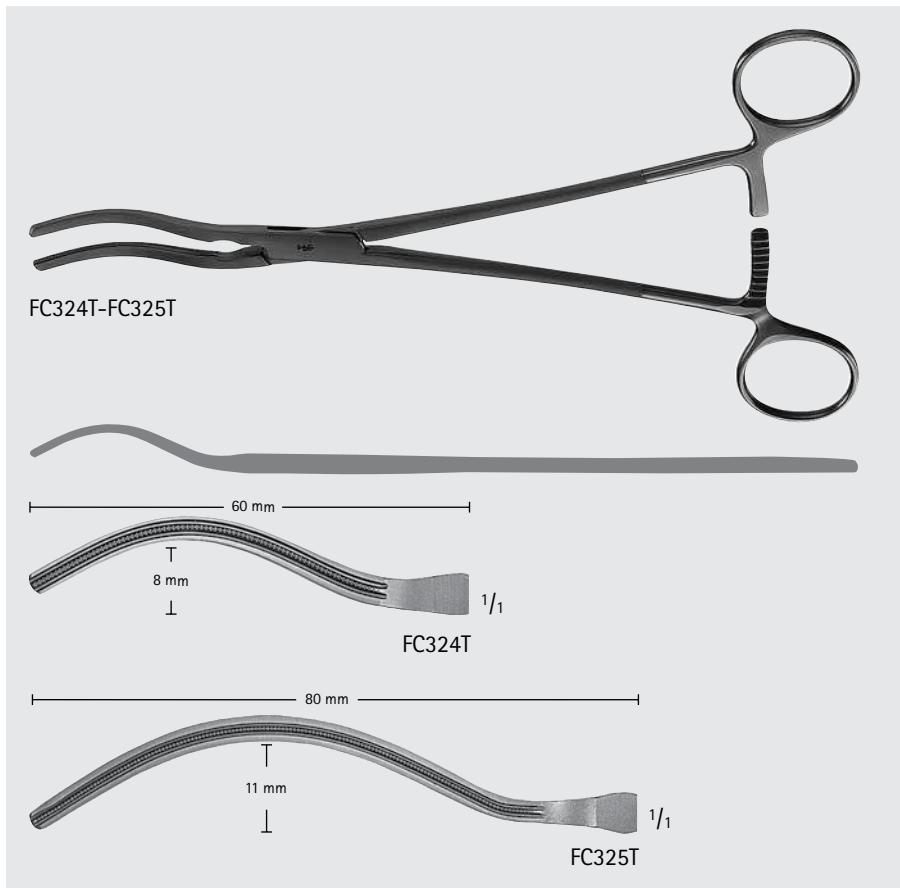

### Titanium GLOVER Atraumatic Vascular Clamp

Catalog Number	Jaw	Jaw Length (mm)	Length (in.)
FC324T	CVD	60	8 3/4
FC325T	CVD	80	10 5/8

Titanium LAMBERT-KAY Atraumatic  
Vascular Clamp

Catalog Number	Jaw Angle	Jaw Length (mm)	Shaft	Length (in.)
FC326T	MULTI	45	ANG	7 3/4

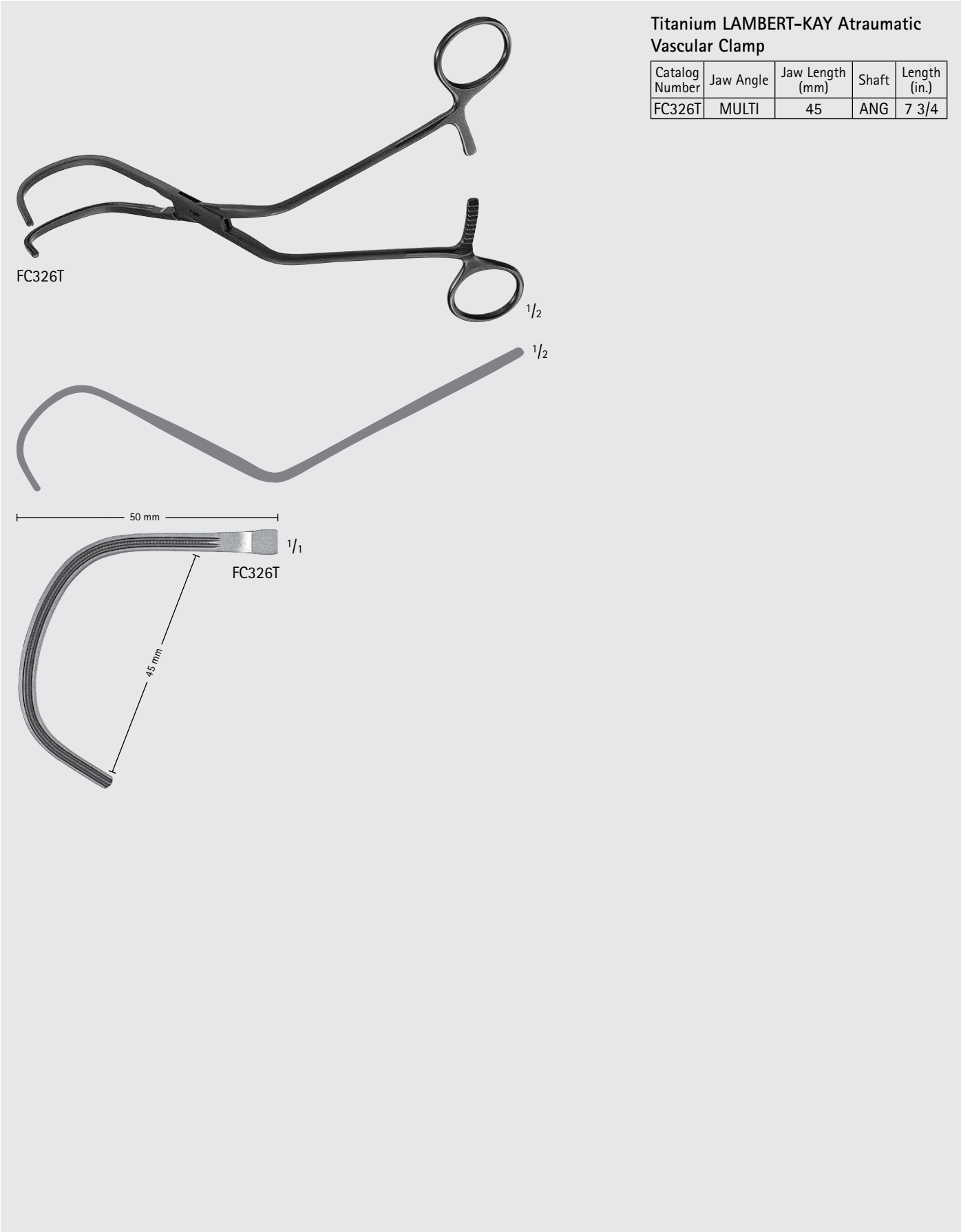



# Cardiovascular

## Titanium Clamps

### Titanium DEBAKEY Atraumatic Vascular Clamp

Catalog Number	Jaw	Length (in.)
FC327T	SLIGHT-CVD	12 1/4
FC328T	SLIGHT-CVD	12 1/2

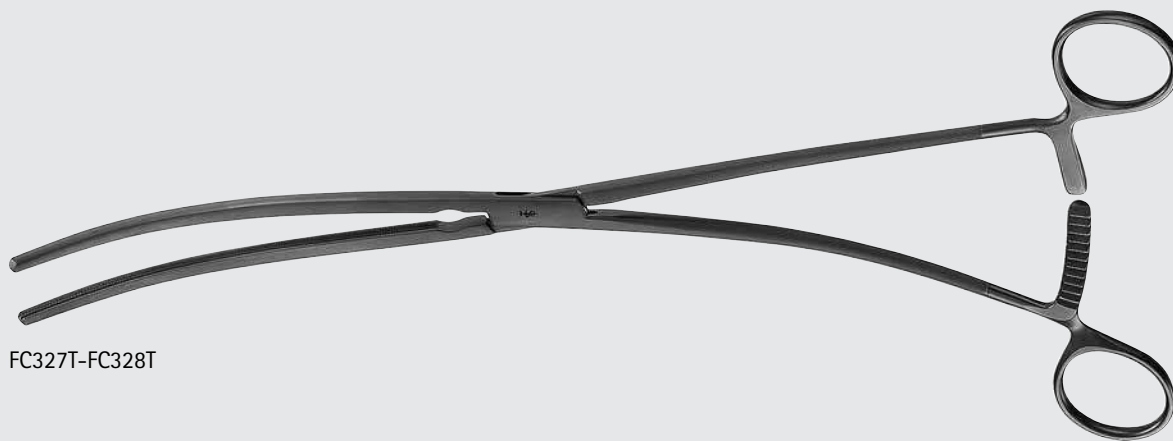

FC327T-FC328T

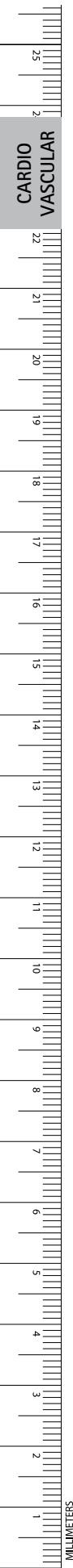
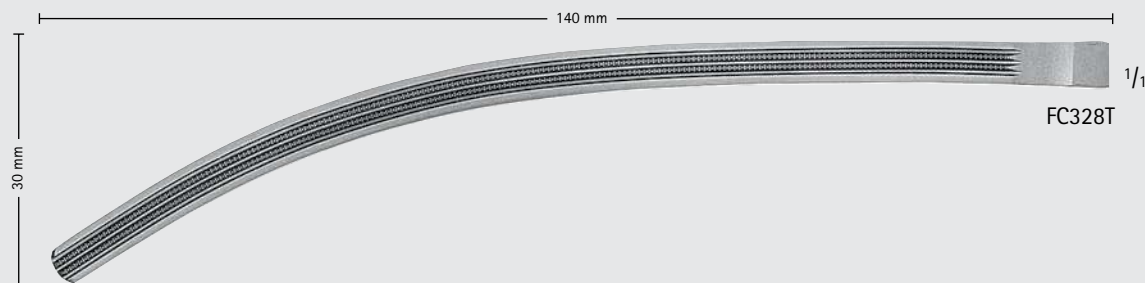
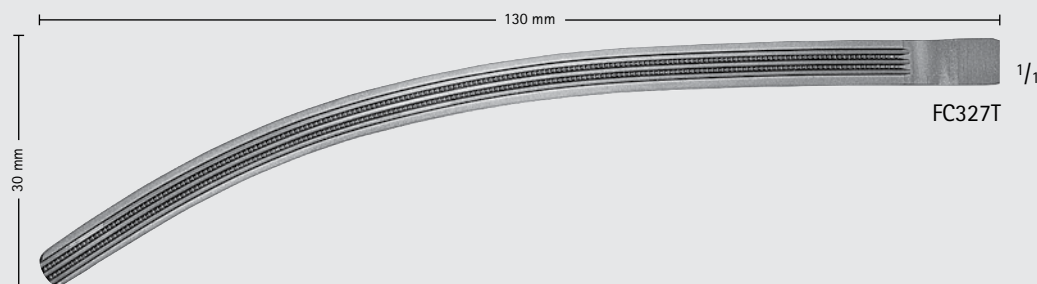
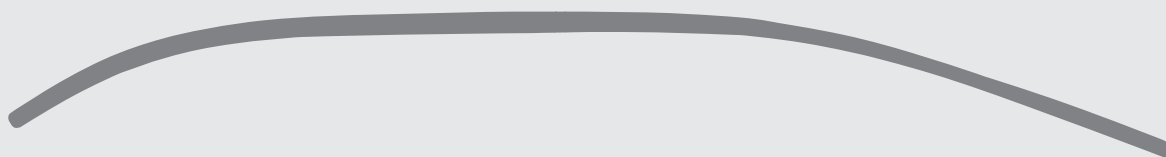

Titanium DEBAKEY Atraumatic  
Vascular Clamp

Catalog Number	Jaw	Shaft	Length (in.)
FC331T	CVD	ANG	7 3/4
FC330T	ANG	ANG	7



FC330T-FC331T

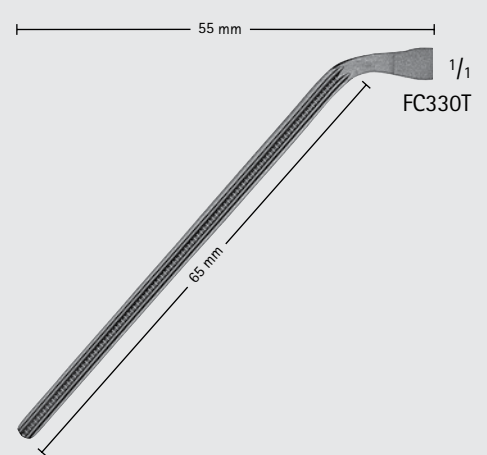
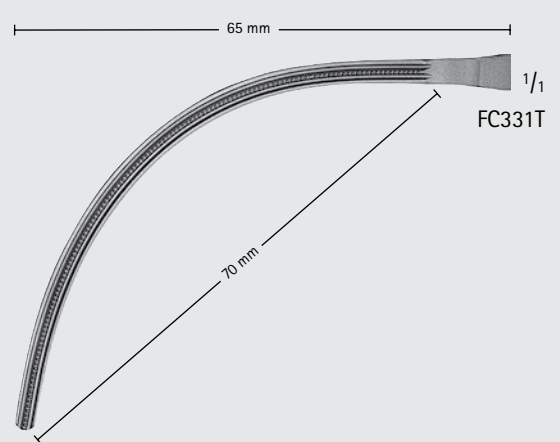

Cardiovascular  
Titanium Clamps

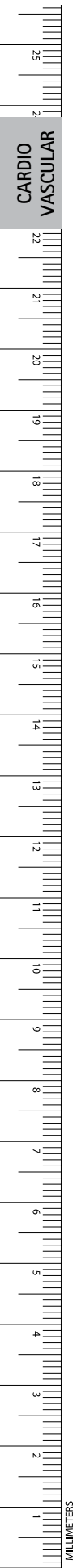

Titanium DEBAKEY Atraumatic  
Vascular Clamp

Catalog Number	Jaw	Length (in.)
FC329T	HEAVY-CVD	10 1/4

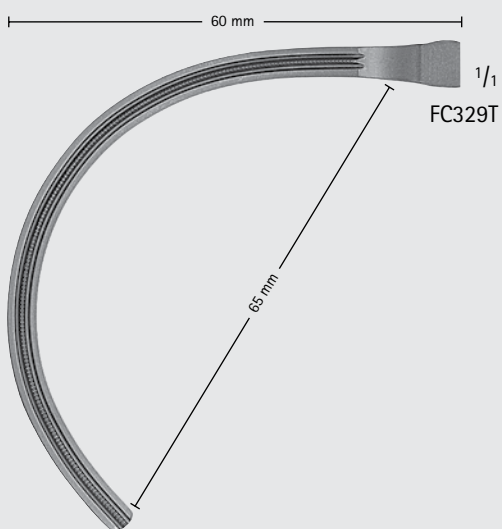
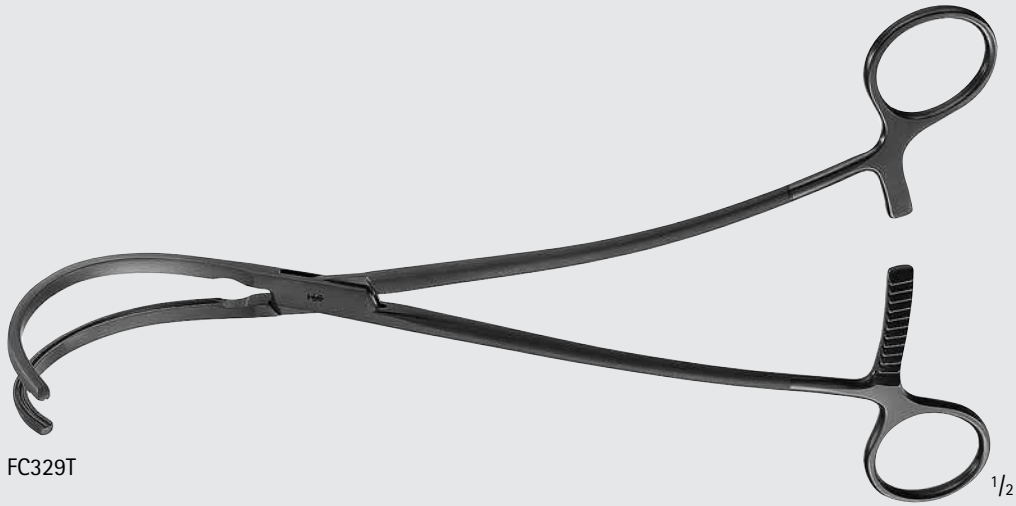



Titanium DEBAKEY Atraumatic  
Vascular Clamp

Catalog Number	Jaw	Shaft	Length (in.)
FC332T	ANG	ANG	9 1/2
FC333T	ANG	ANG	8 1/2



FC332T-FC333T

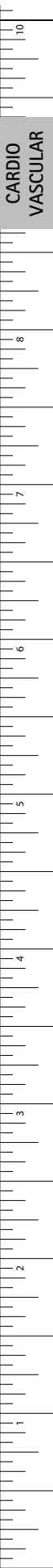
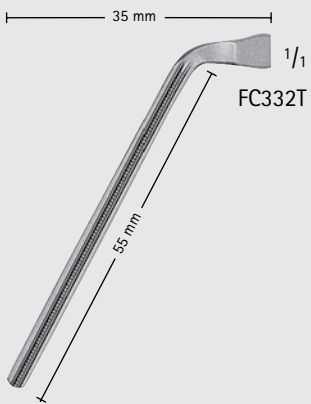

INCHES

# Cardiovascular

## Titanium Clamps

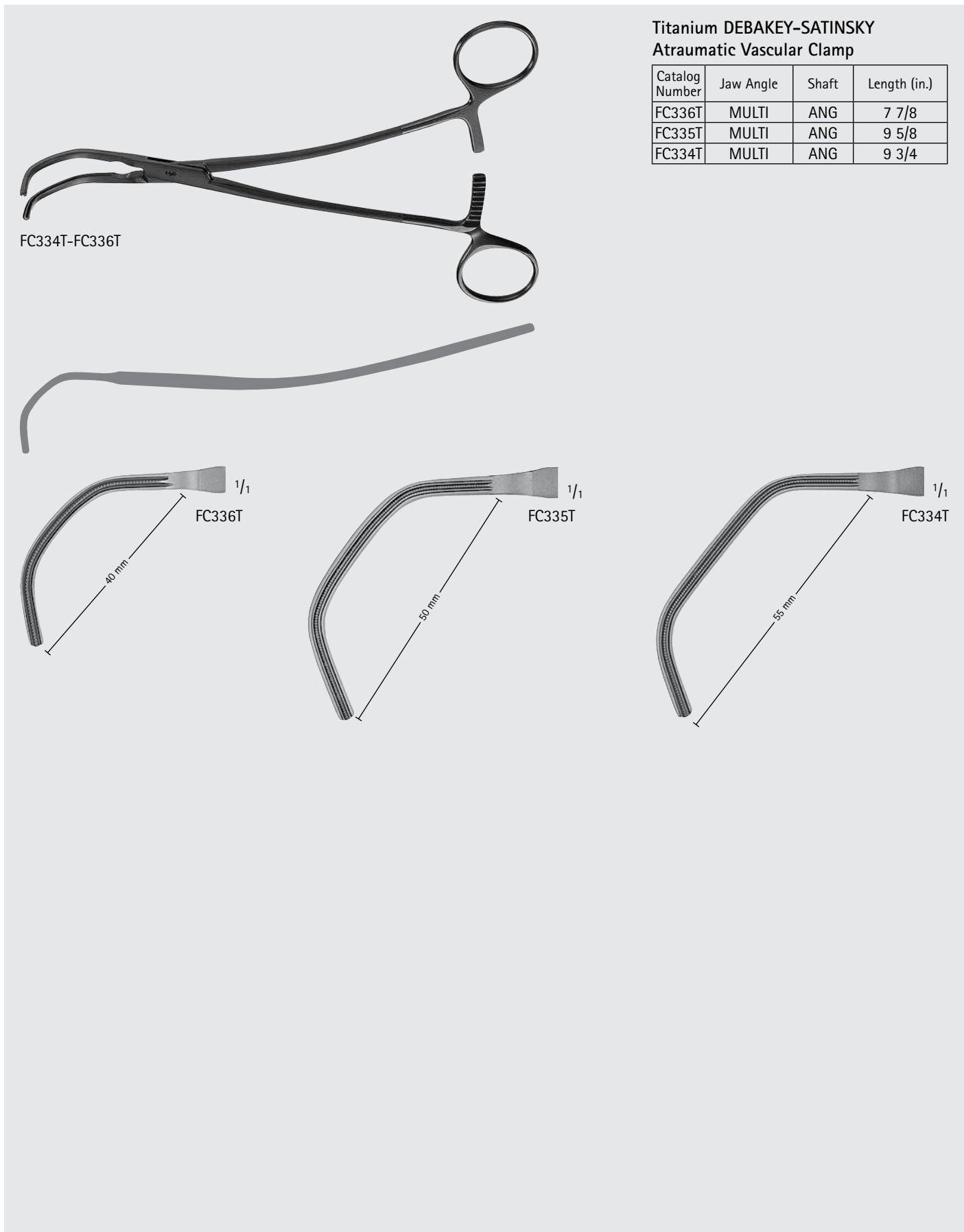
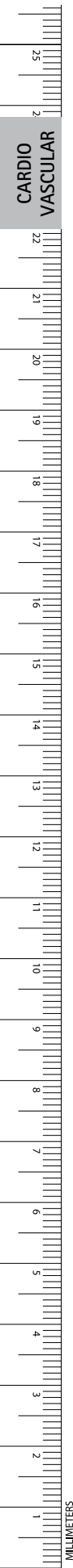

### Titanium DEBAKEY-SATINSKY Atraumatic Vascular Clamp

Catalog Number	Jaw Angle	Shaft	Length (in.)
FC336T	MULTI	ANG	7 7/8
FC335T	MULTI	ANG	9 5/8
FC334T	MULTI	ANG	9 3/4

FC334T-FC336T

FC336T

40 mm

FC335T

50 mm

FC334T

55 mm

Titanium DEBAKEY Atraumatic  
Pediatric Vascular Clamp

Catalog Number	Jaw Angle	Length (in.)
FC337T	STR	4 1/4
FC338T	30°	4 1/4
FC339T	45°	4 1/4
FC340T	60°	4 1/4
FC341T	MULTI	3 3/4
FC342T	MULTI	4
FC343T	MULTI	4

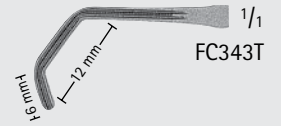
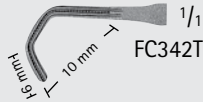
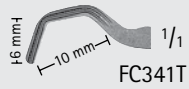
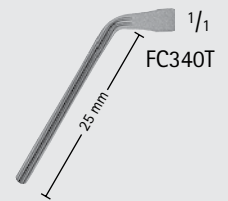
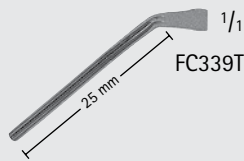
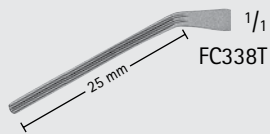
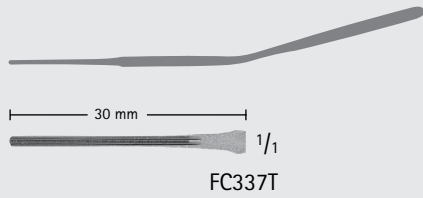
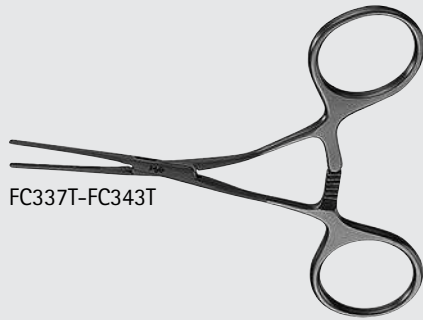

Cardiovascular  
Forceps and Clamps

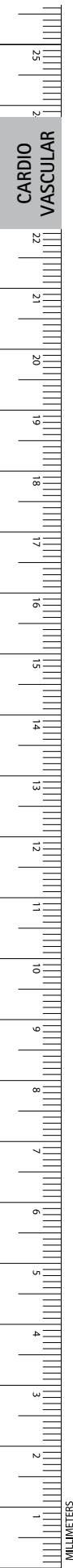

Chest Tube Passer

Catalog Number	Description	Length (in.)
MG578R	W/O RATCHET	9 3/4
MG589R	W/O RATCHET	14
MG588R	W/ RATCHET	9 3/4



MG578R, MG589R



MG578R, MG589R



MG588R



MG588R



**Tubing Clamp**

Catalog Number	Jaw	Length (in.)
AN909R	SMOOTH	6 1/2
MD452R	SERR	6
MD453R	SERR	7
MD454R	SERR	7 7/8

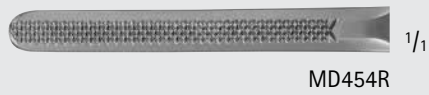
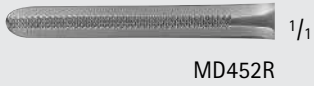
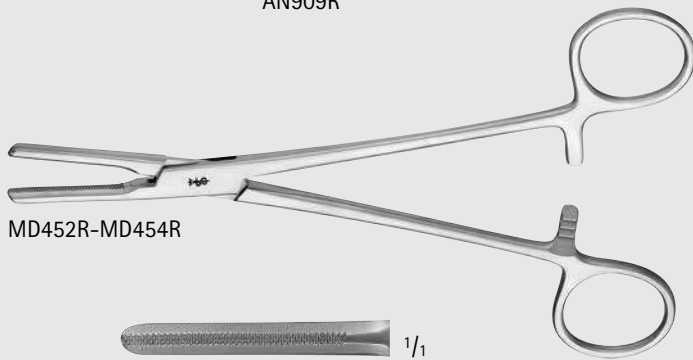

**Tubing Clamp, W/ Guard**

Catalog Number	Jaw	Length (in.)
MD652	SERR	6
MD653	SERR	7
MD654	SERR	7 7/8

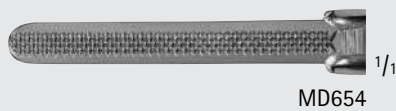
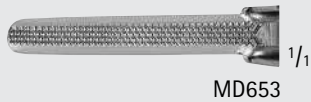
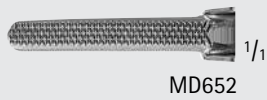
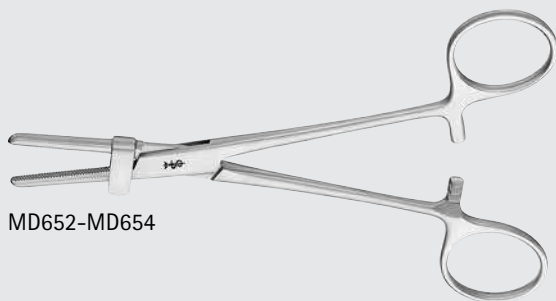

# Cardiovascular

## Forceps and Clamps



CARDIO  
VASCULAR

### SAROT Forceps, Delicate

Catalog Number	Teeth	Length (in.)
BH224R	-	9 1/2
BH234R	1 x 2	9 1/2

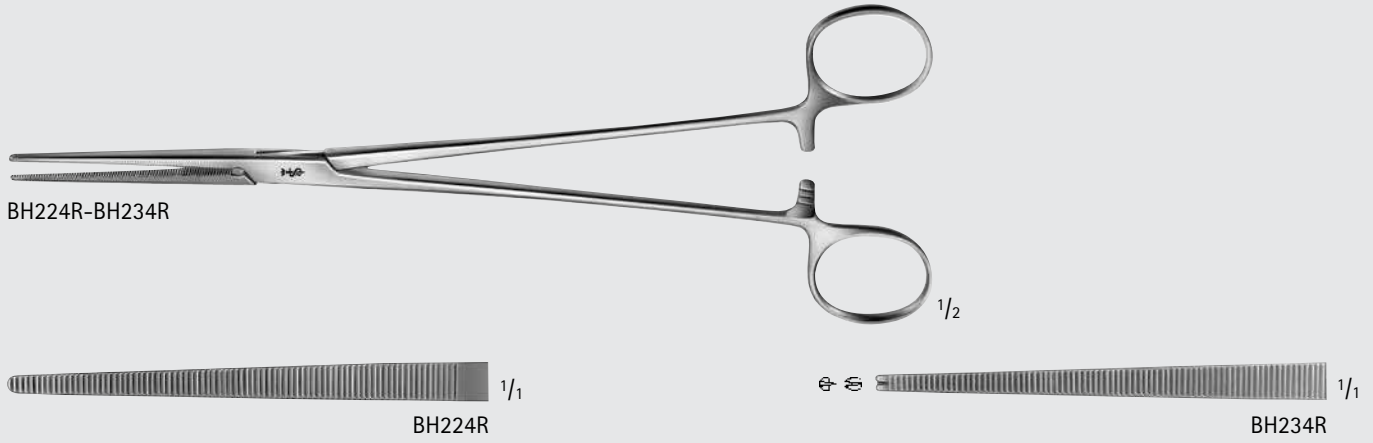

### CRAFOORD Forceps, Delicate

Catalog Number	Jaw	Length (in.)
BH225R	CVD	9 5/8

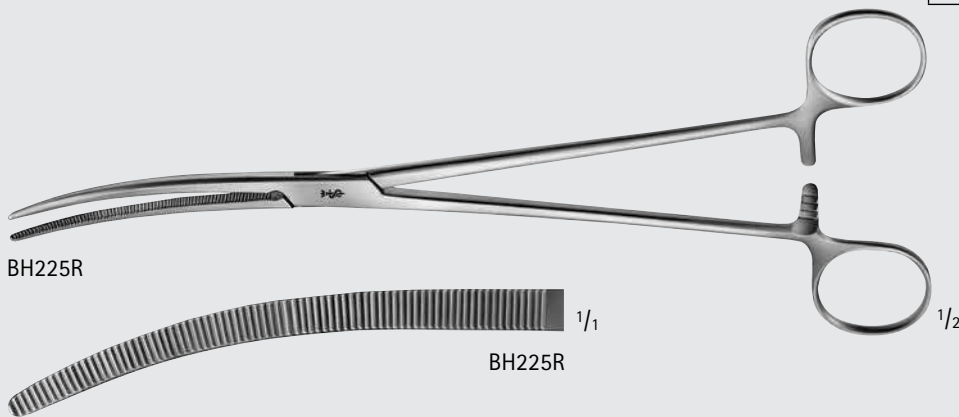

### HOLLE Forceps, Delicate

Catalog Number	Jaw	Length (in.)
BJ037R	CVD	5 3/4
BJ038R	CVD	7 1/4
BJ039R	CVD	9 1/4

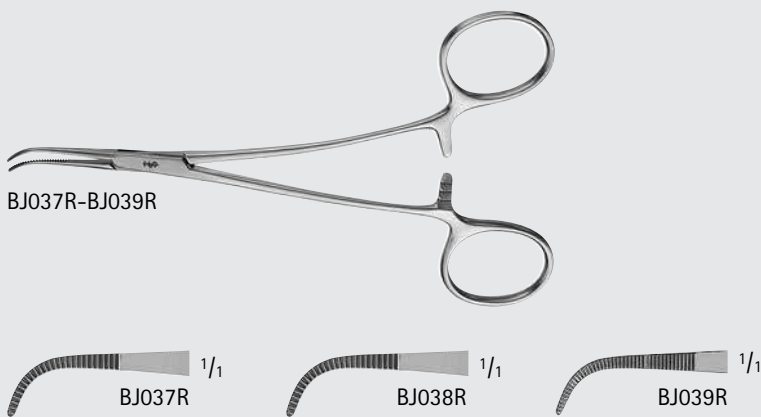

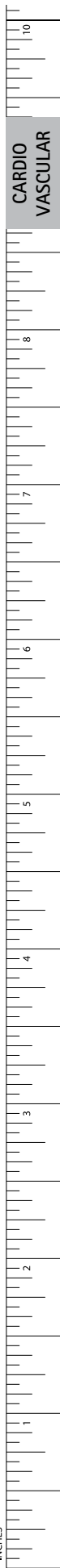

**COLLER Artery Forceps**

Catalog Number	Jaw Angle	Length (in.)
MG421R	90°	9 1/2

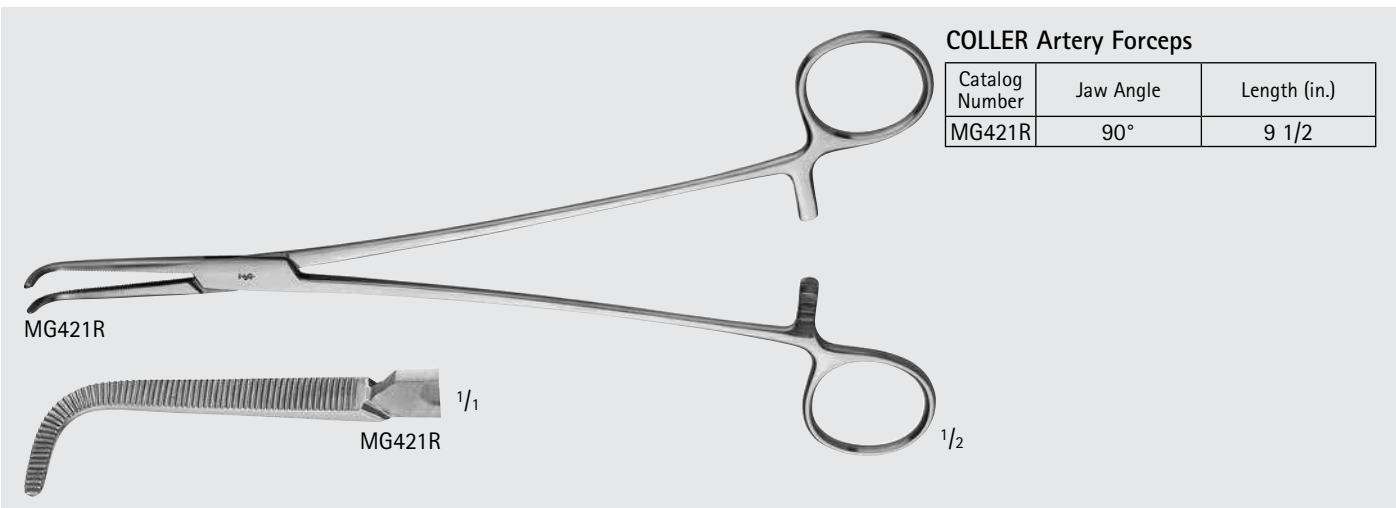

**SAROT Intrathoracic Artery Forceps**

Catalog Number	Jaw	Length (in.)
BH226R	SLIGHT-CVD	9 3/4

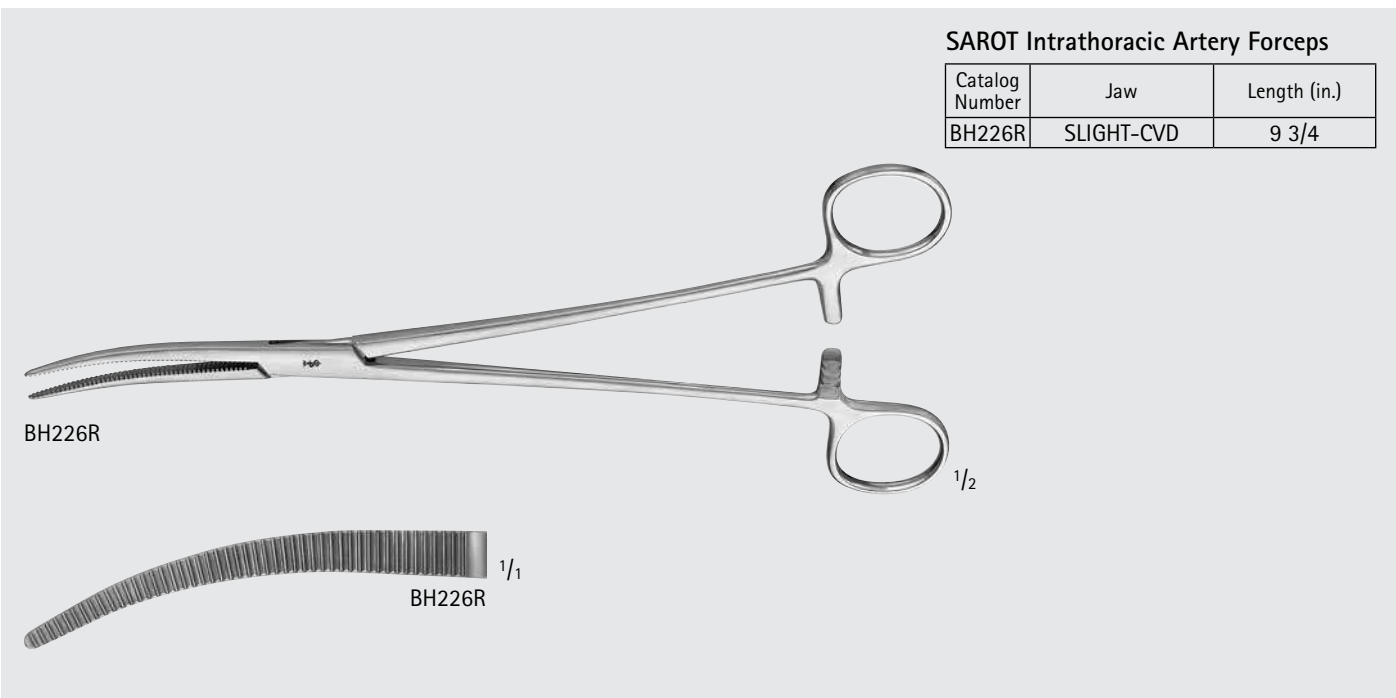

**JULIAN Thoracic Artery Forceps**

Catalog Number	Jaw	Length (in.)
BH233R	CVD	9 1/4

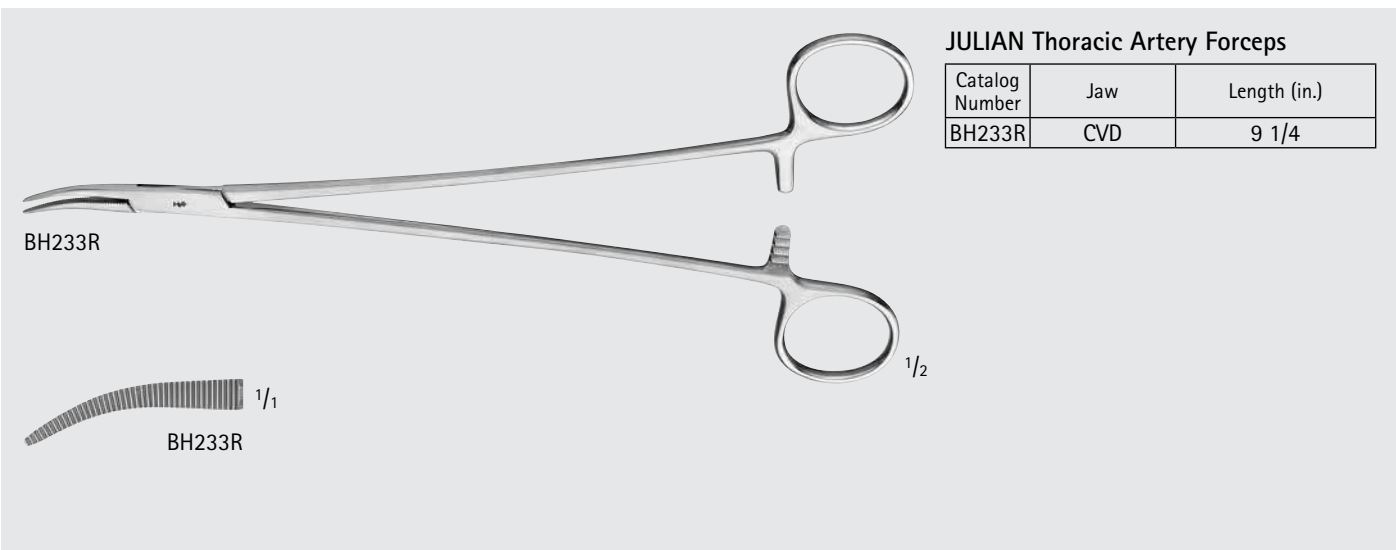

# Cardiovascular

## Forceps and Clamps

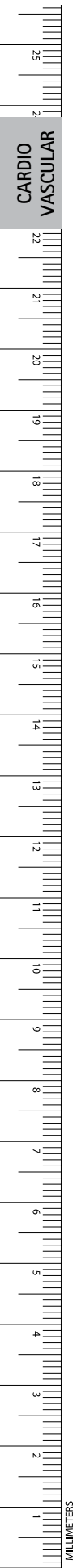
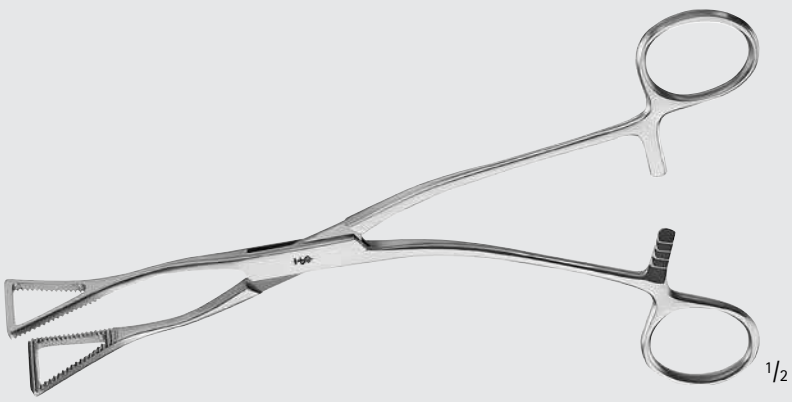



**LOVELACE Lung Forceps**

Catalog Number	Length (in.)
MB056R	8

MB056R  $\frac{1}{2}$

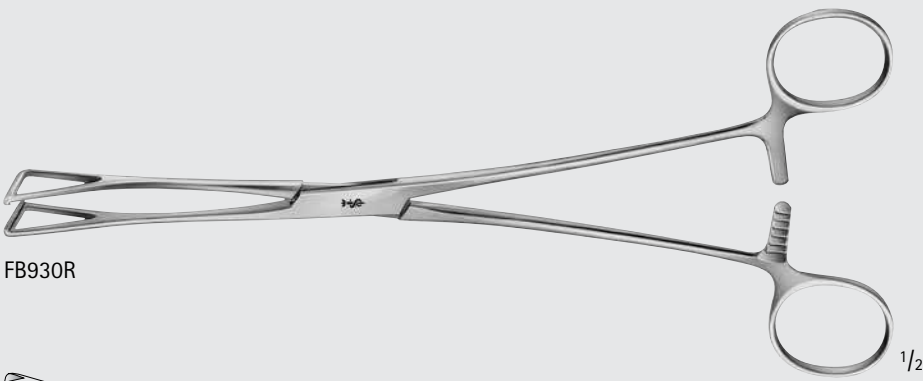
MB056R  $\frac{1}{1}$



**DUVAL Lung Forceps**

Catalog Number	Length (in.)
FB930R	9

FB930R  $\frac{1}{2}$

FB930R  $\frac{1}{1}$

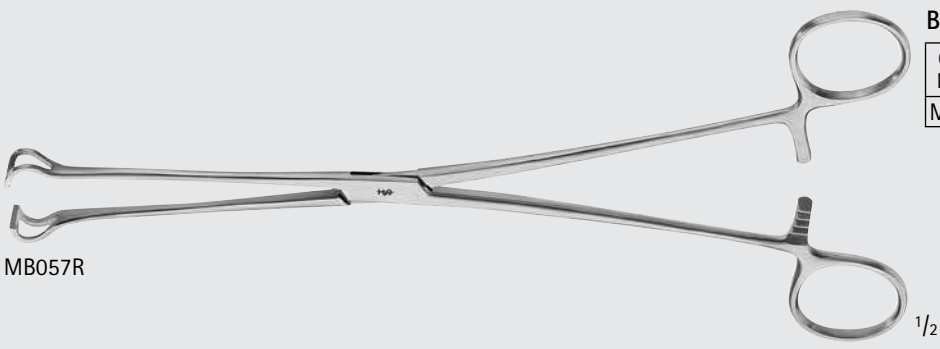

**BABCOCK Thoracic Tissue Forceps**

Catalog Number	Length (in.)
MB057R	9 1/2

MB057R  $\frac{1}{2}$

MB057R  $\frac{1}{1}$



Thoracoscopy Forceps

Catalog Number	Jaw	Jaw Length (mm)	Length (in.)
MB458R	STR, LONG	158	12 1/2
MB296R	CVD, LONG	158	12 1/4

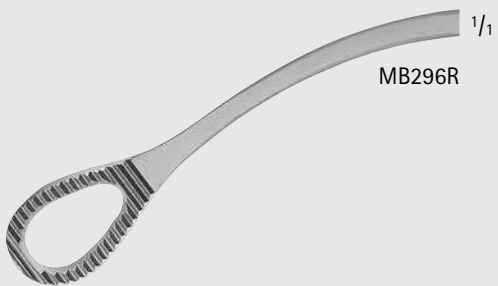
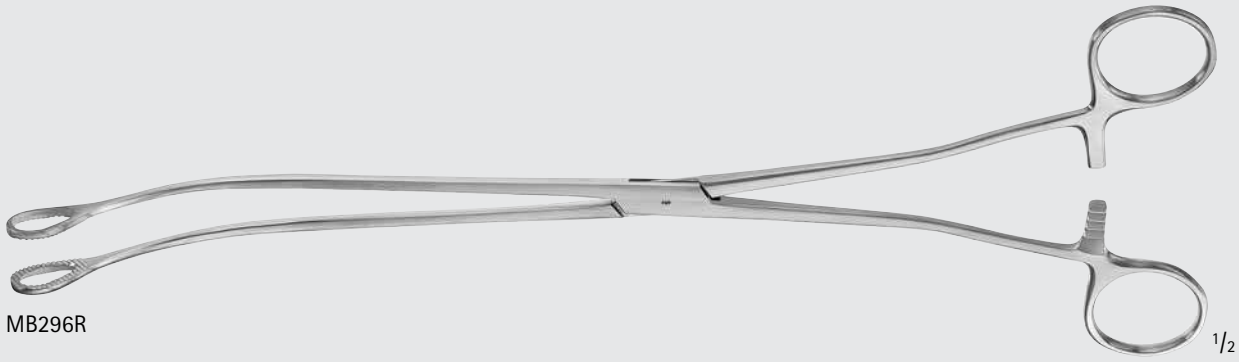
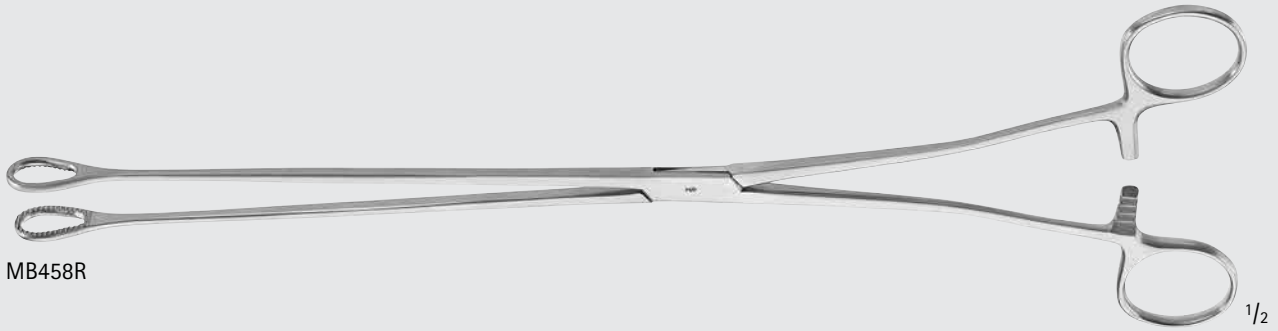

Cardiovascular  
Forceps and Clamps



ROCHESTER-OCHSNER Artery Forceps

Catalog Number	Jaw	Teeth	Length (in.)
MB172R	STR	1 x 2	14

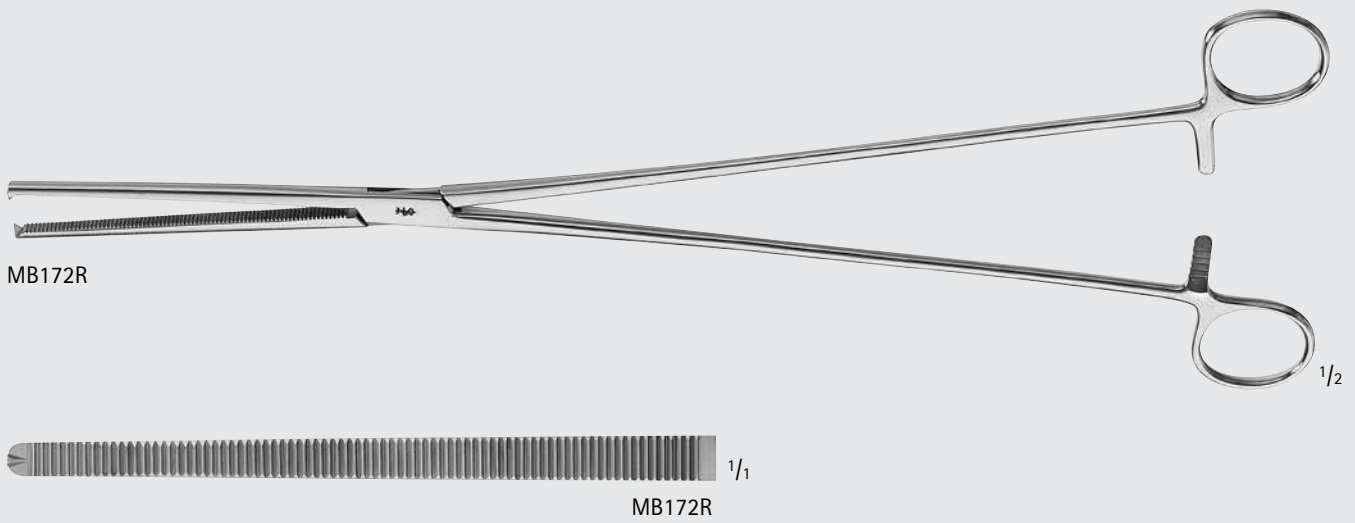

CARMALT Artery Forceps, Longitudinal Serrations

Catalog Number	Jaw	Length (in.)
MB182R	SLIGHT-CVD	12

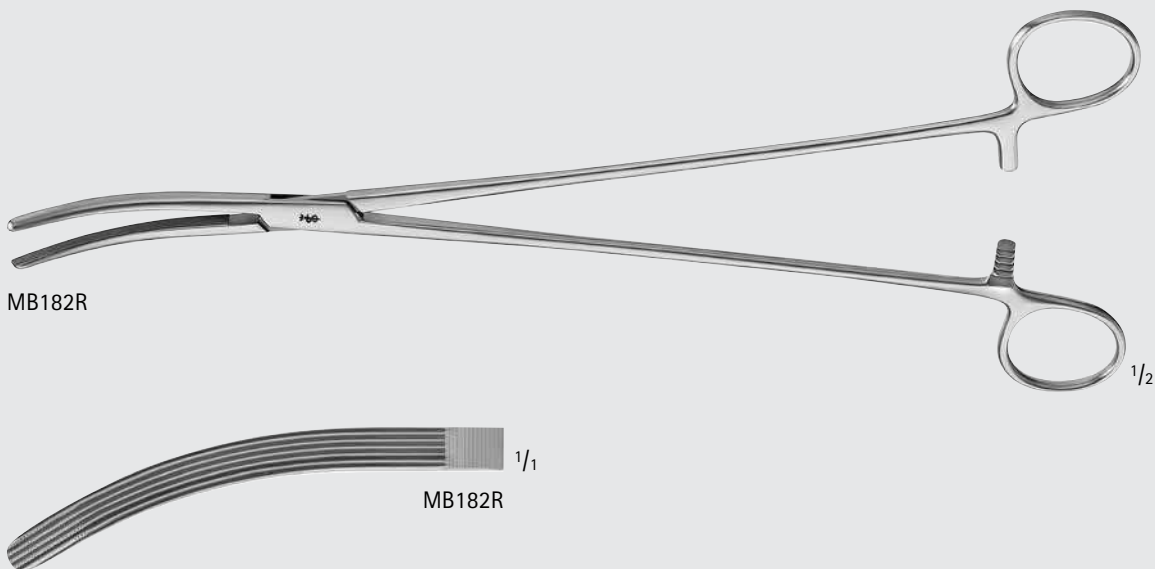

**COOLEY Bronchus Clamp**

Catalog Number	Jaw	Length (in.)
MG449R	ANG	8 1/4

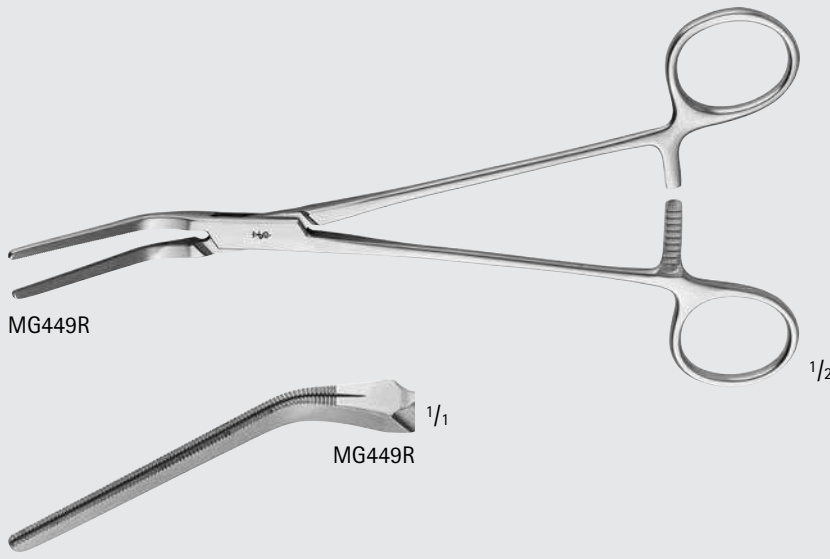

**Bronchus Clamp, Longitudinal Serrations**

Catalog Number	Jaw Angle	Jaw Length (mm)	Length (in.)
FB954R	90°	60	9
FB955R	90°	80	9

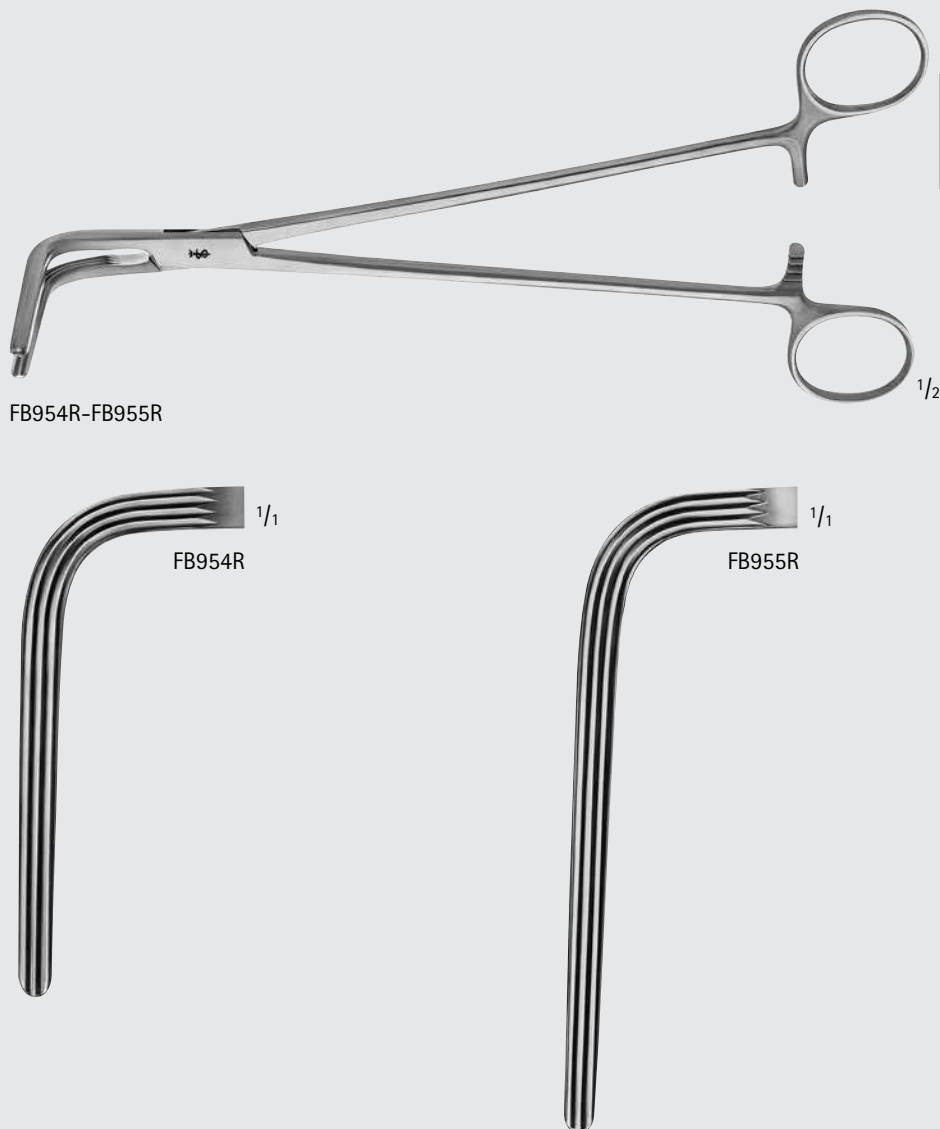

# Cardiovascular

## Forceps and Clamps

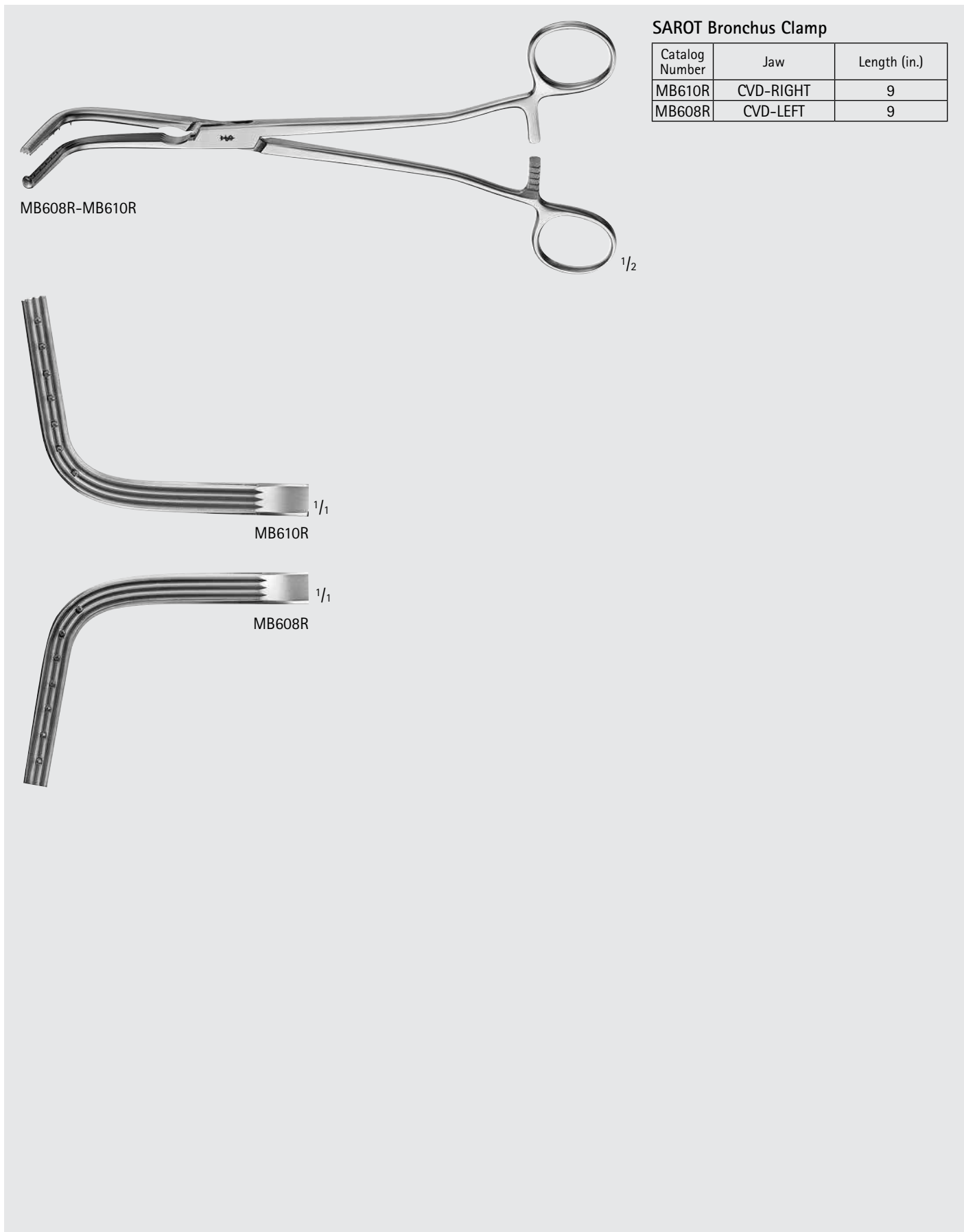
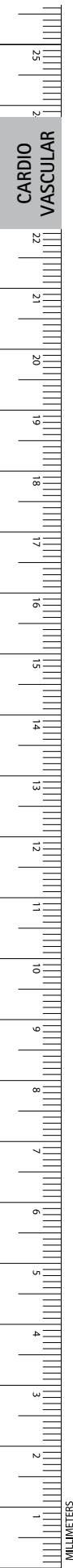

### SAROT Bronchus Clamp

Catalog Number	Jaw	Length (in.)
MB610R	CVD-RIGHT	9
MB608R	CVD-LEFT	9

MB608R-MB610R

1/2

MB610R

1/1

MB608R

1/1



**FOGARTY-Type Clamp**

Catalog Number	Jaw	Jaw Length (mm)	Length (in.)
MB091R	STR	33	6 1/2
MB070R	STR	61	11 5/8
MB096R	STR	86	12 1/4
MB092R	ANG	33	4 5/8
MB094R	ANG	61	8 1/2
MB093R	ANG	61	8 3/4
MB095R	ANG	86	9 1/4

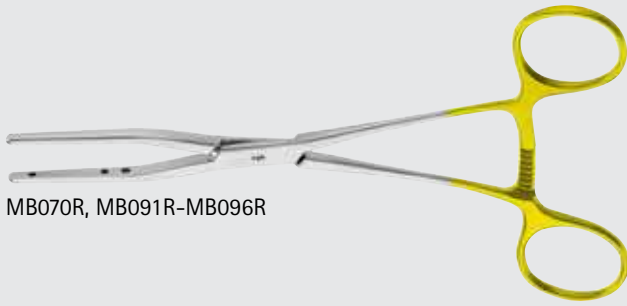

MB070R, MB091R-MB096R



MB092R



MB093R



MB094R

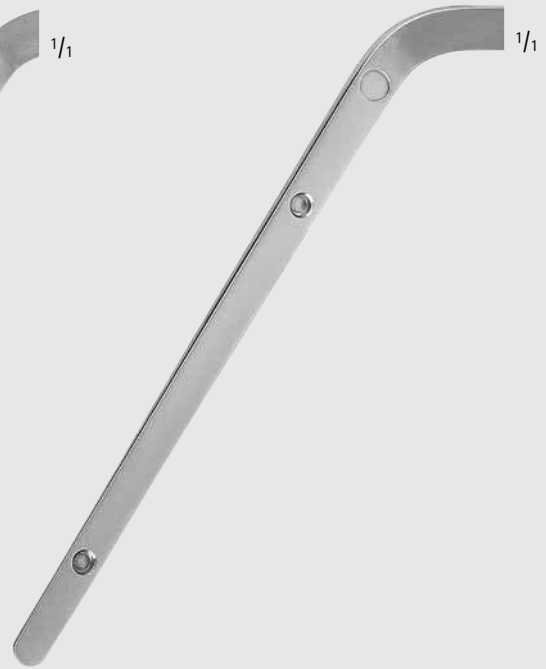

MB095R



MB091R



MB070R



MB096R

**FOGARTY-Type Spring Clip Applicator**

Catalog Number	Teeth	Length (in.)
MB097R	1 x 2	7 1/4

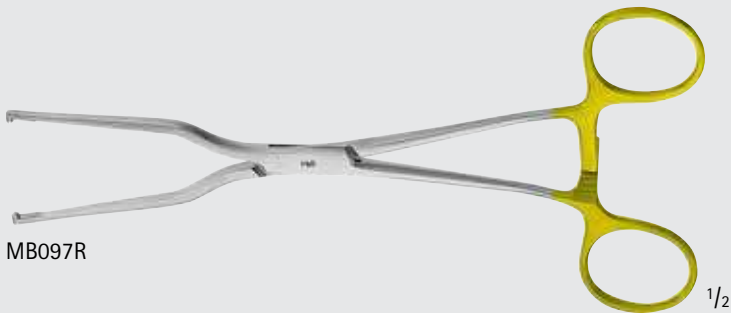

MB097R



MB097R

Cardiovascular  
Vascular Clamps

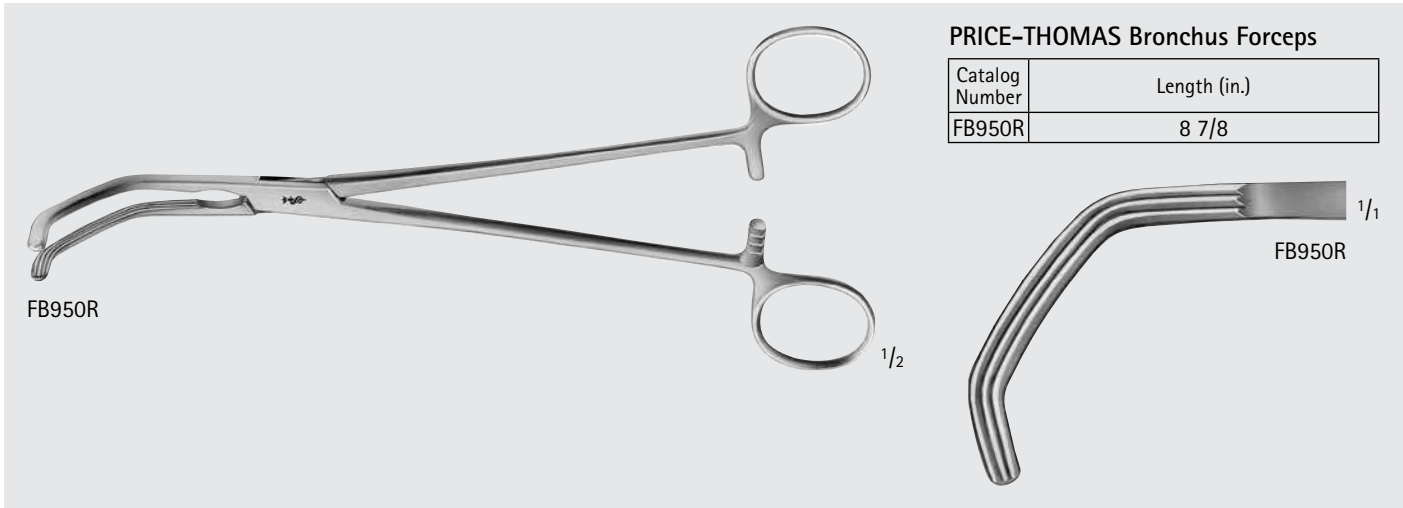
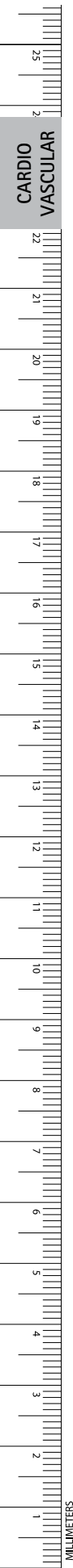

PRICE-THOMAS Bronchus Forceps

Catalog Number	Length (in.)
FB950R	8 7/8

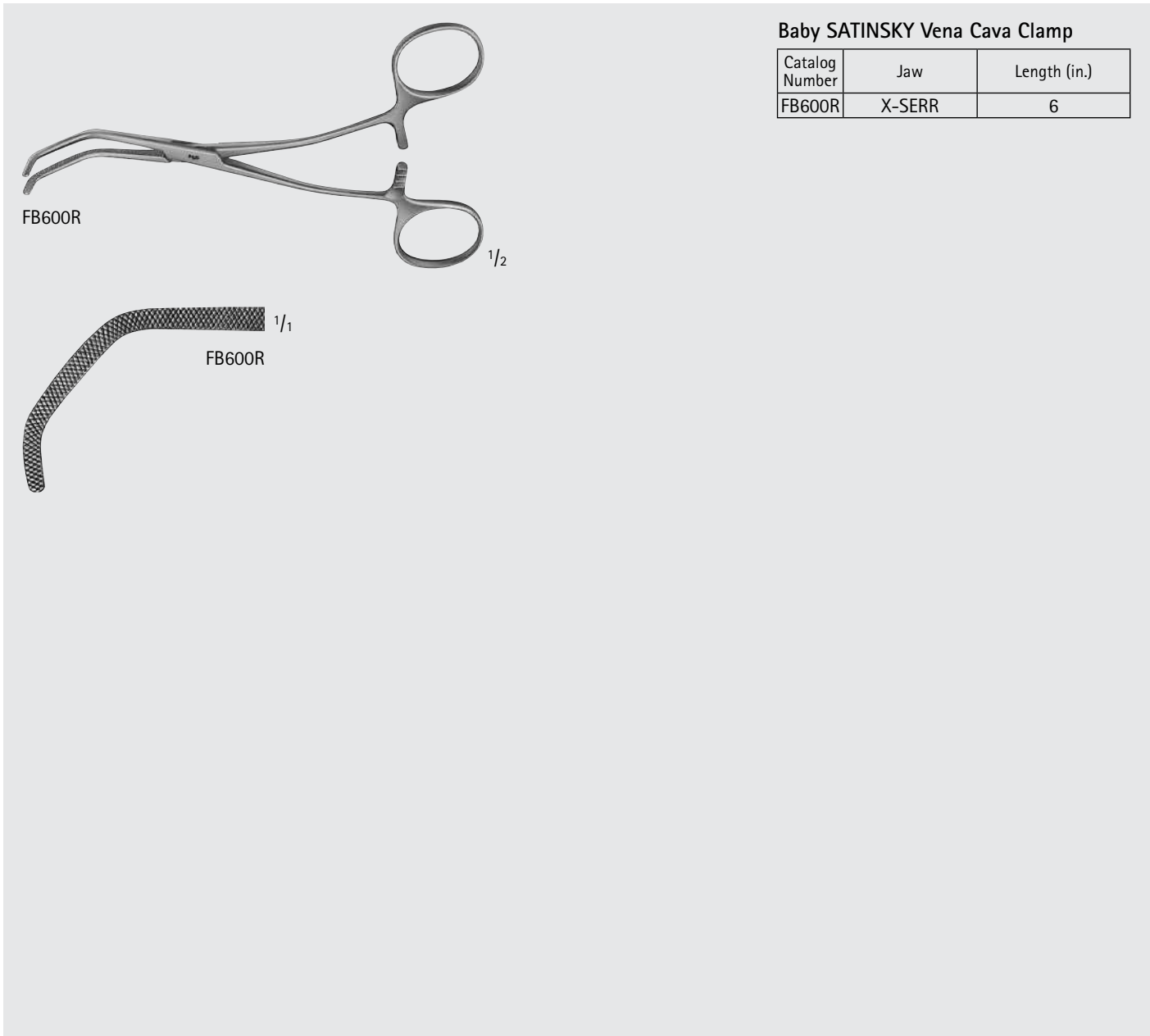

Baby SATINSKY Vena Cava Clamp

Catalog Number	Jaw	Length (in.)
FB600R	X-SERR	6

SATINSKY Vena Cava Clamp

Catalog Number	Jaw	Jaw Size	Shaft	Length (in.)
FB602R	ANG, X-SERR	LARGE	STR	10 1/2
FB604R	ANG, X-SERR	SMALL	LIGHT-CVD	10 1/2
FB605R	ANG, X-SERR	LARGE	LIGHT-CVD	10 1/2

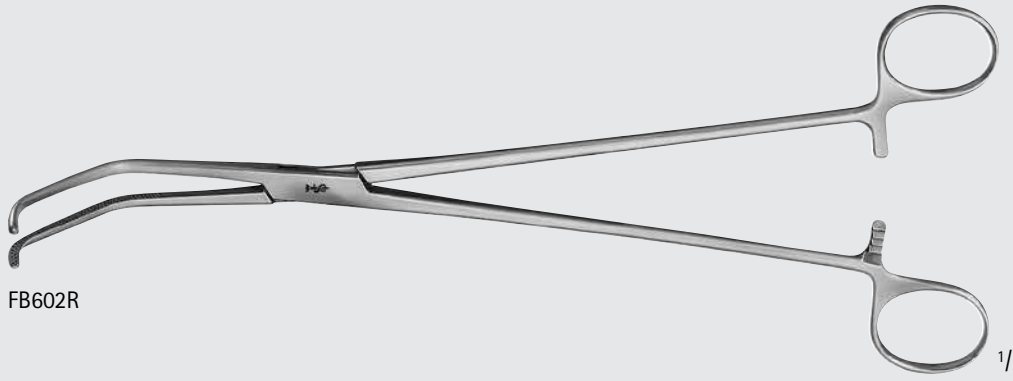

FB602R

1/2

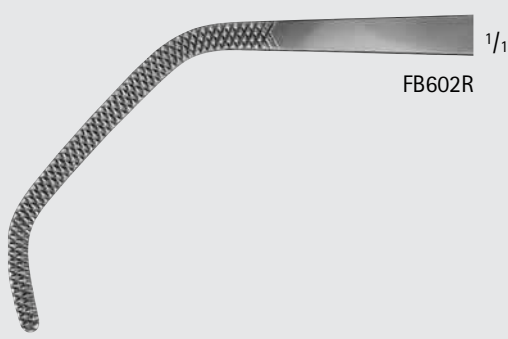

FB602R

1/1



FB604R-FB605R

1/2

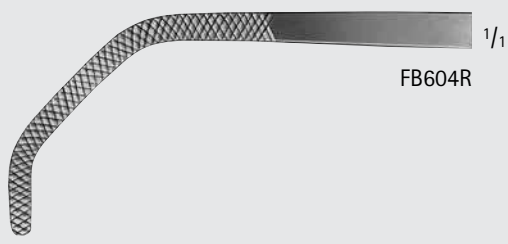

FB604R

1/1

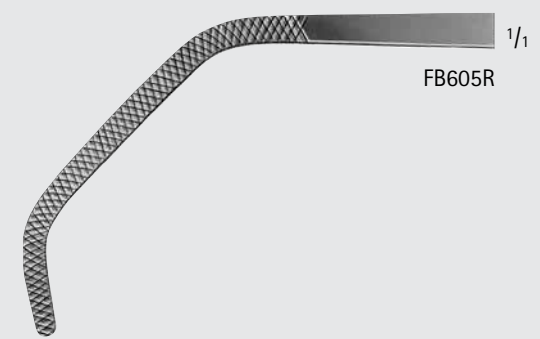

FB605R

1/1

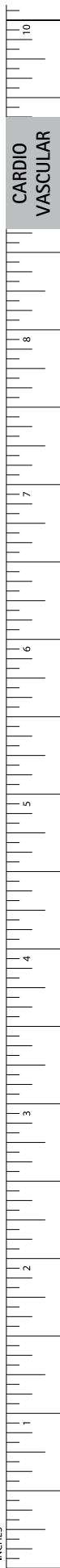

# Cardiovascular

## Vascular Clamps

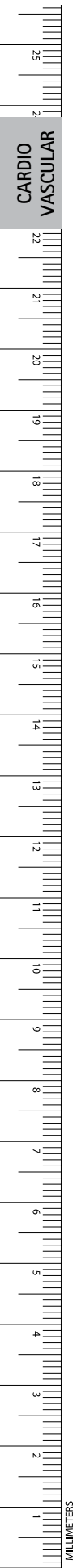

CARDIO  
VASCULAR

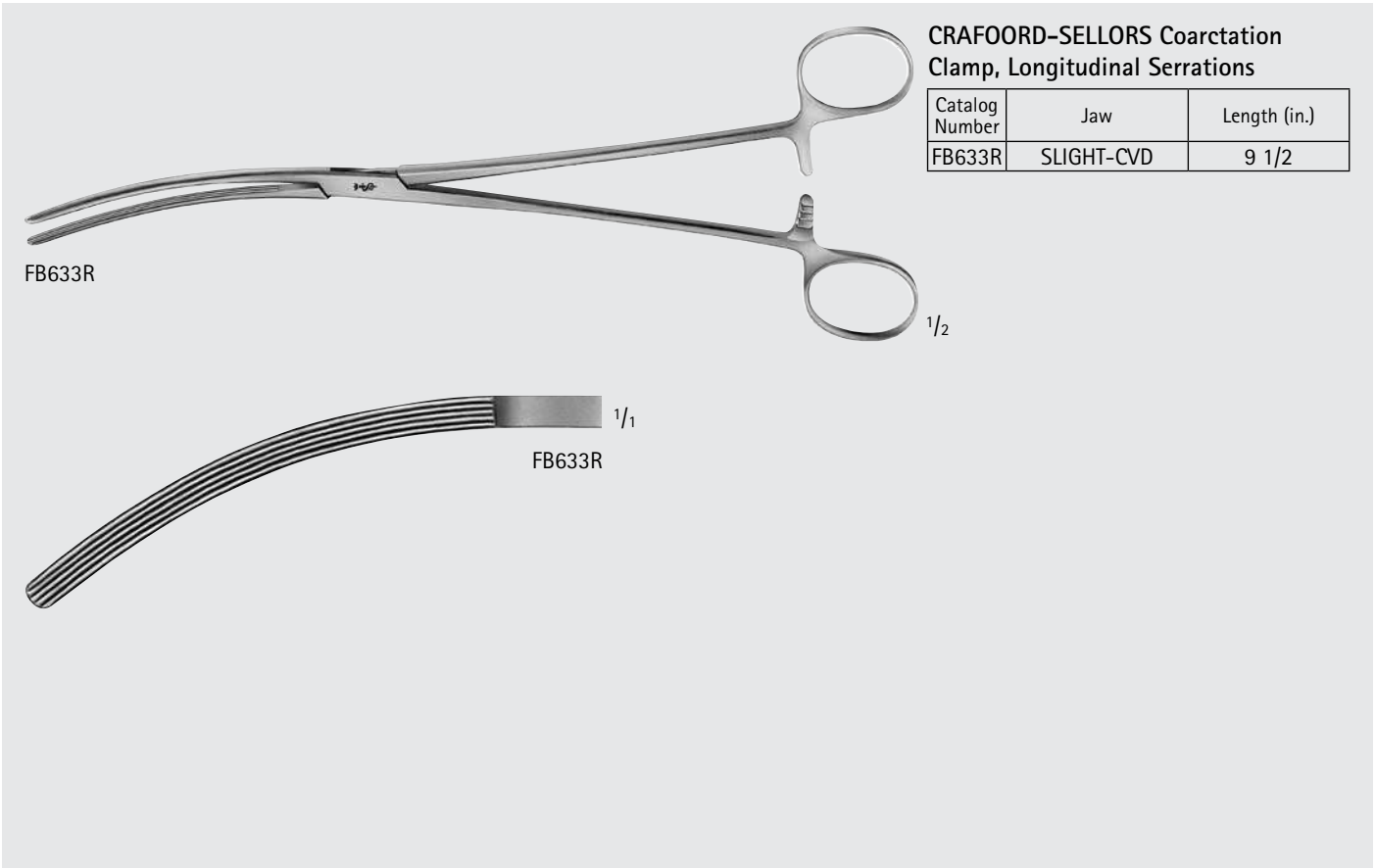

**CRAFOORD-SELLORS Coarctation Clamp, Longitudinal Serrations**

Catalog Number	Jaw	Length (in.)
FB633R	SLIGHT-CVD	9 1/2

FB633R

1/2

FB633R

1/1

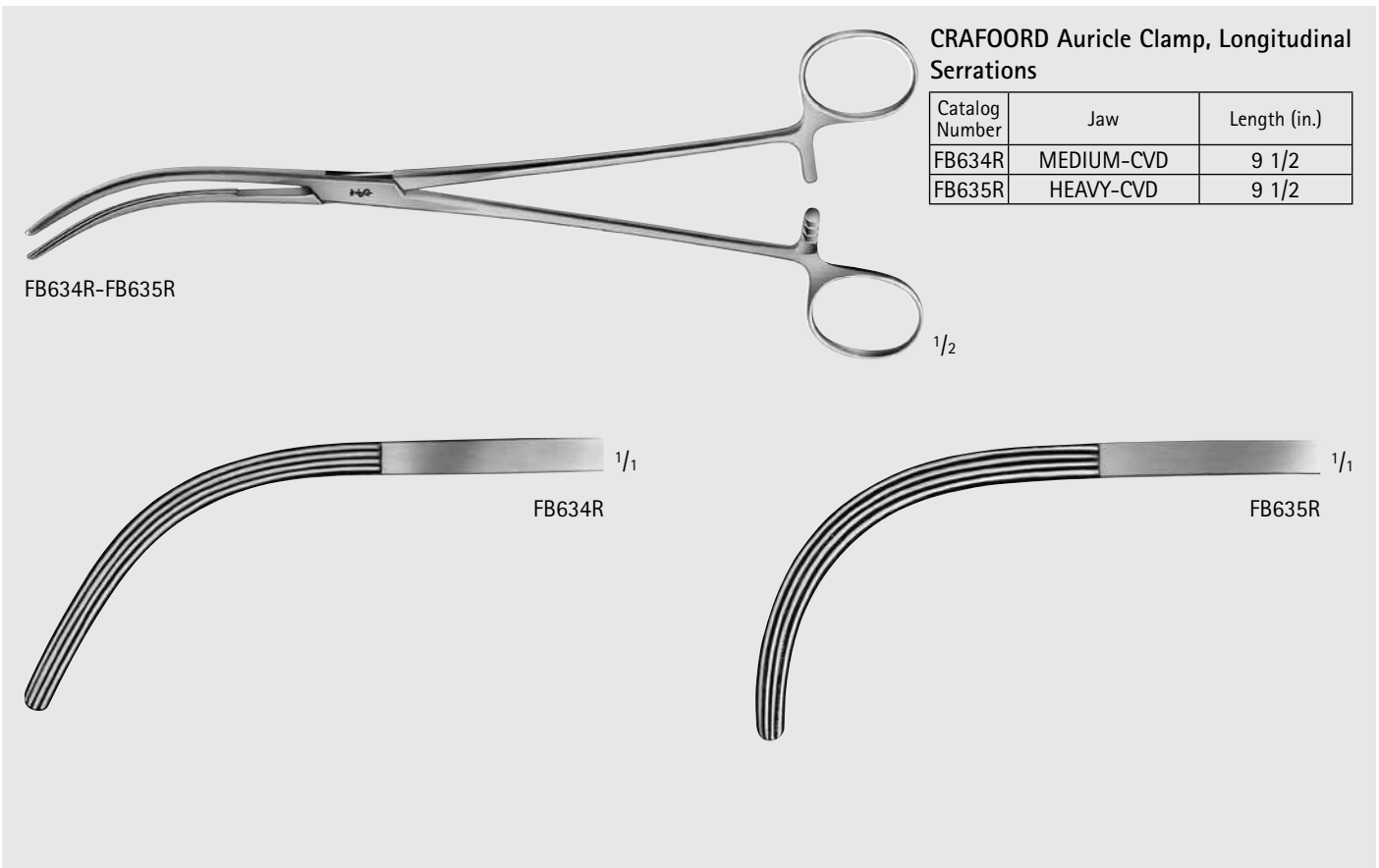

**CRAFOORD Auricle Clamp, Longitudinal Serrations**

Catalog Number	Jaw	Length (in.)
FB634R	MEDIUM-CVD	9 1/2
FB635R	HEAVY-CVD	9 1/2

FB634R-FB635R

1/2

FB634R

1/1

FB635R

1/1



**SEMB Suture Forceps**

Catalog Number	Jaw	Length (in.)
FB961R	HEAVY-CVD	9 1/2

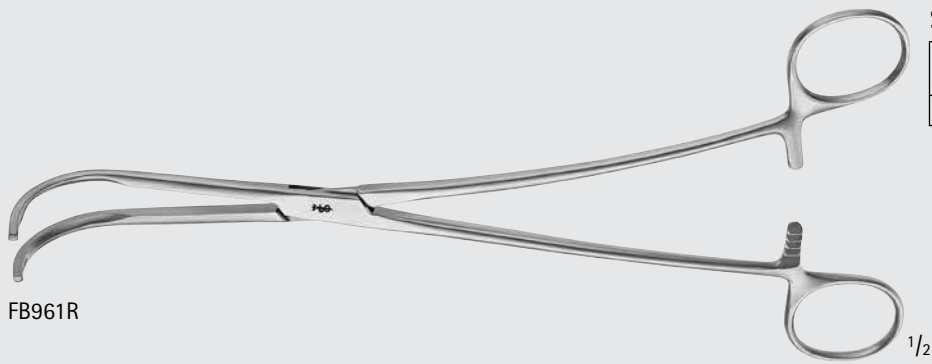

FB961R

1/2



FB961R

1/1

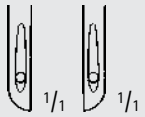

1/1

1/1

**HALLMAN Tunnelling Forceps**

Catalog Number	Jaw	Length (in.)
MG075R	SERR RING	13 1/2

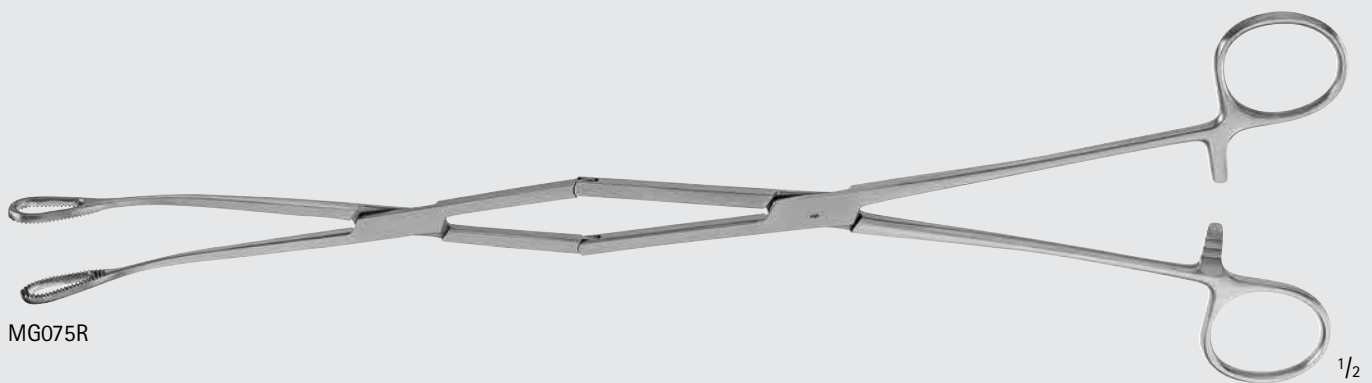

MG075R

1/2



MG075R

1/1

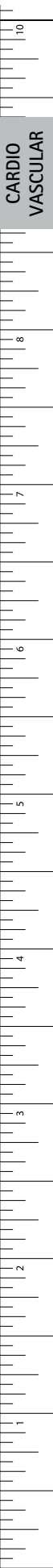

# Cardiovascular

## Vascular Clamps

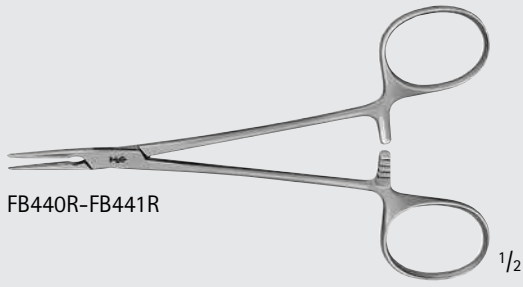
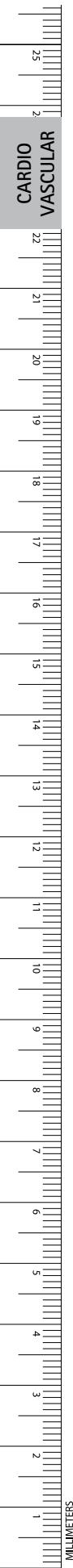

FB440R-FB441R



FB440R



FB441R

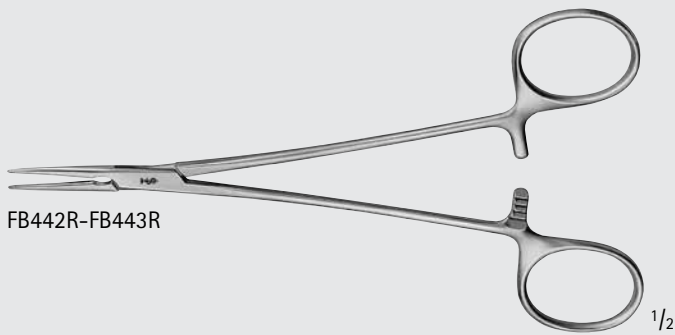

FB442R-FB443R



FB442R



FB443R

### DEBAKEY Mosquito Atraumatic Forceps

Catalog Number	Jaw	Jaw Length (mm)	Length (in.)
FB440R	STR	20	5
FB442R	STR	27	6 1/2
FB441R	CVD	20	5
FB443R	CVD	27	6 1/2

DEBAKEY-BAINBRIDGE Atraumatic  
Forceps

Catalog Number	Jaw	Jaw Length (mm)	Length (in.)
FB446R	STR	40	6 1/8
FB448R	STR	65	7
FB447R	CVD	40	6 1/8
FB449R	CVD	65	7

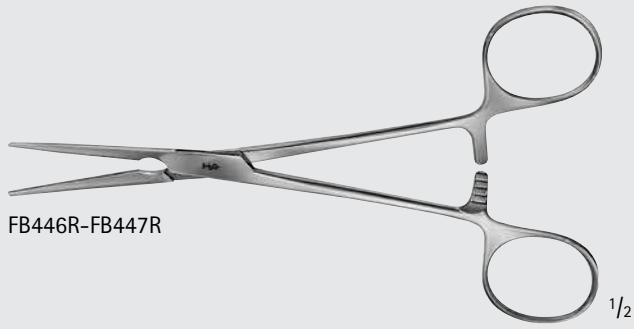

FB446R-FB447R

1/2



FB446R



FB447R

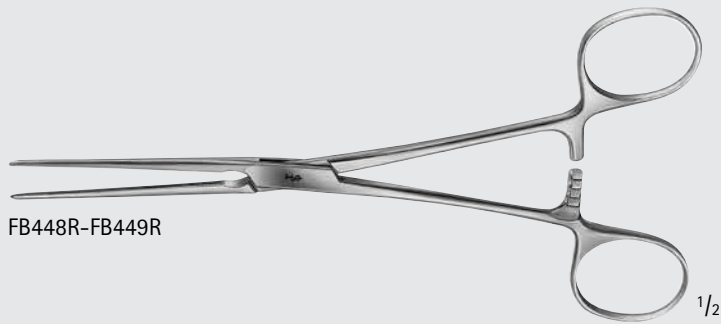

FB448R-FB449R

1/2



FB448R



FB449R

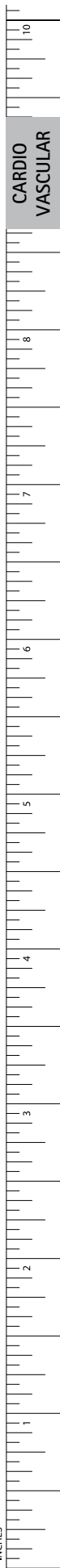

INCHES

# Cardiovascular

## Vascular Clamps

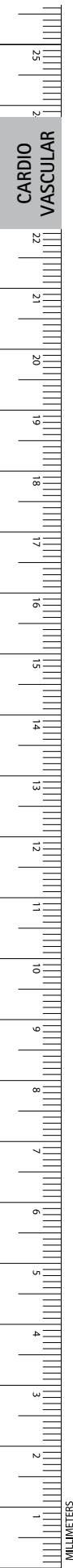

### DEBAKEY-HARKEN Atraumatic Vascular Clamps

Catalog Number	Tip Size (#)	Jaw	Jaw Length (mm)	Length (in.)
FB521R	1	CVD	86	10
FB522R	2	CVD	86	9 5/8
FB523R	3	CVD	86	9 5/8
FB524R	4	CVD	86	9 3/4

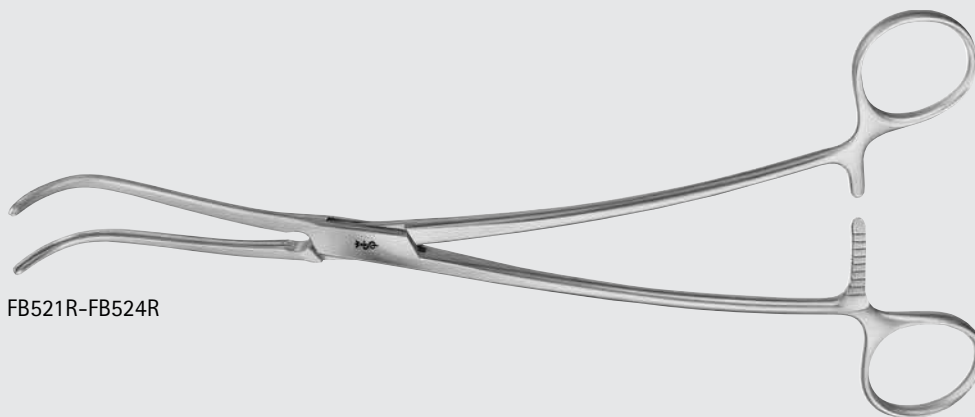

FB521R-FB524R



FB521R

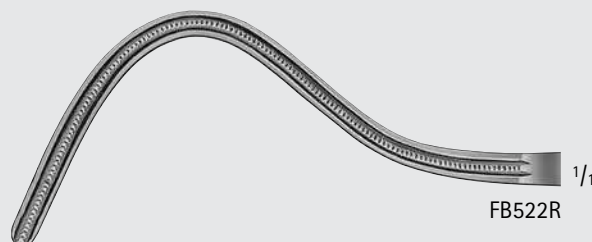

FB522R

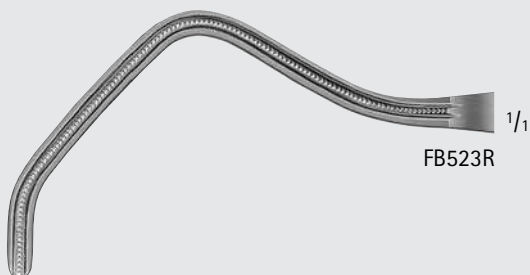

FB523R

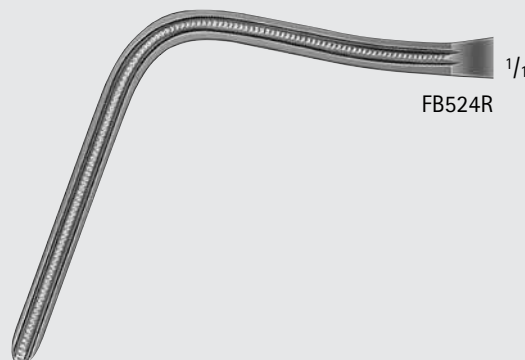

FB524R

DEBAKEY-PEAN Atraumatic Forceps

Catalog Number	Jaw	Jaw Length (mm)	Length (in.)
FB526R	STR	60	7 7/8
FB532R	STR	89	10 1/2
FB534R	STR	99	11
FB527R	CVD	60	7 7/8
FB533R	CVD	89	10 1/4
FB535R	CVD	99	10 3/4



FB526R-FB535R



FB526R



FB532R



FB534R



FB527R



FB533R

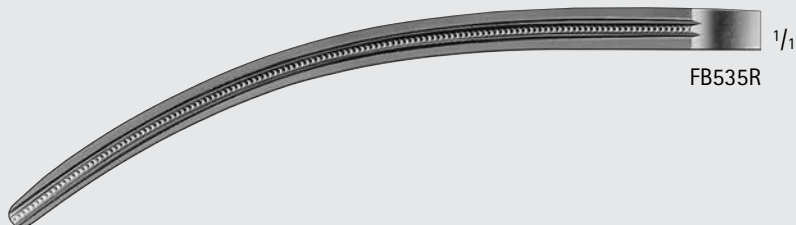

FB535R



INCHES

# Cardiovascular

## Vascular Clamps



CARDIO  
VASCULAR

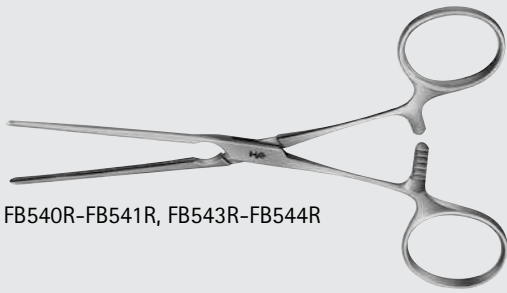

FB540R-FB541R, FB543R-FB544R

### DEBAKEY Atraumatic Ring Handle Bulldog Clamp

Catalog Number	Jaw Angle	Jaw Length (mm)	Length (in.)
FB540R	STR	53	5 1/8
FB541R	CVD	53	5
FB542R	CVD*	53	5
FB543R	45°	53	5
FB544R	90°	53	4 1/8

\*Instrument is S-Shaped

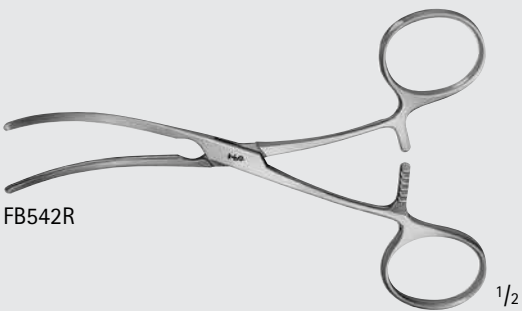
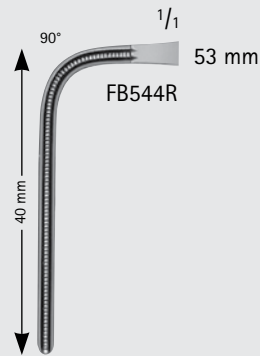
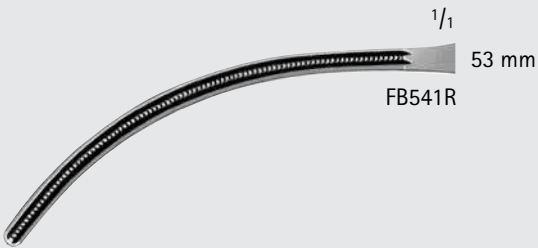
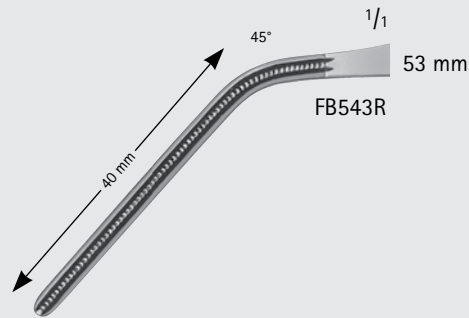

FB542R

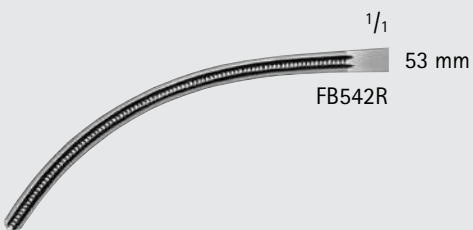

FB542R



**DEBAKEY Atraumatic Multi-Purpose Clamp, Curved**

Catalog Number	Jaw Length (mm)	Length (in.)
FB557R	31	6 1/2
FB558R	40	6 3/4

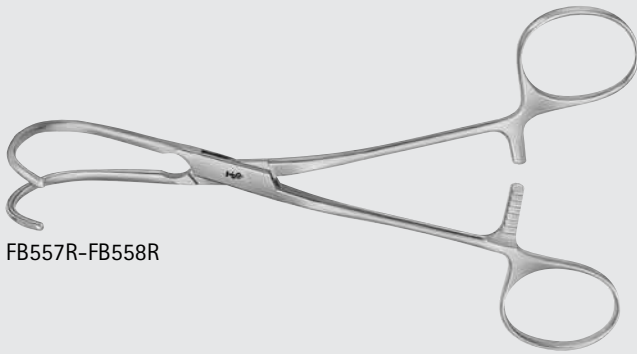

FB557R-FB558R

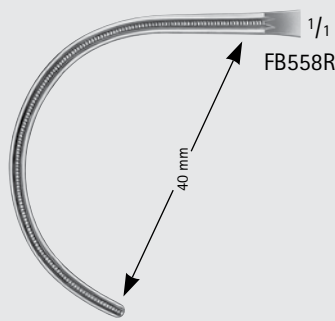
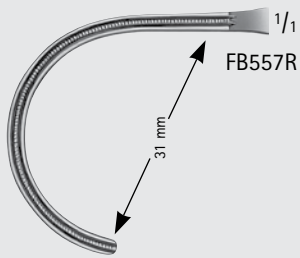

**COOLEY Atraumatic Pediatric Vascular Clamp**

Catalog Number	Jaw Angle	Jaw Length (mm)	Length (in.)
FB563R	MULTI	24	6 1/4

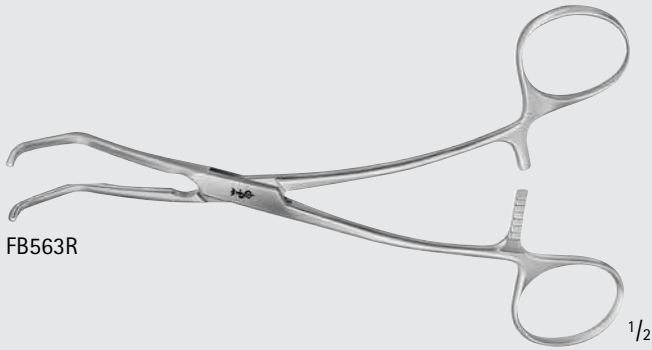

FB563R

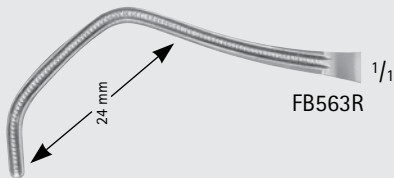

Cardiovascular  
Vascular Clamps

COOLEY Atraumatic Pediatric  
Vascular Clamp (continued)

Catalog Number	Jaw Angle	Jaw Length (mm)	Length (in.)
FB741R	25°	38	5 3/4
FB567R	30°	30	6 1/2
FB568R	60°	30	6 1/4
FB569R	90°	30	6
FB570R	MULTI	90	7 7/8

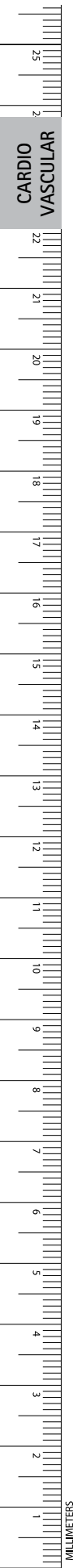
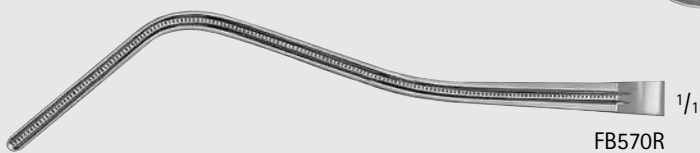
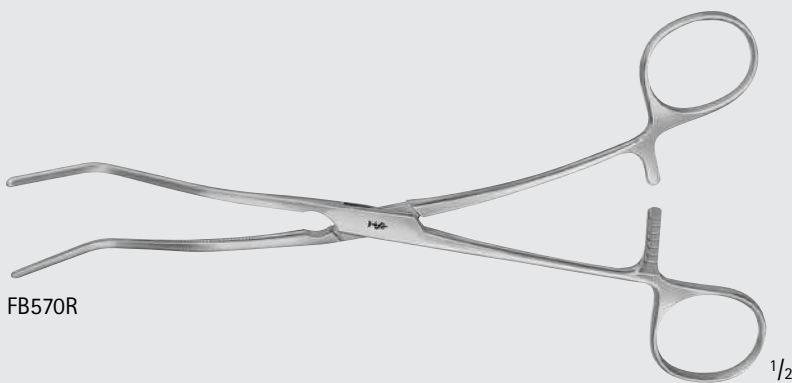
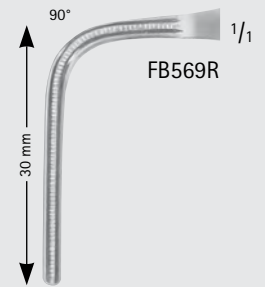
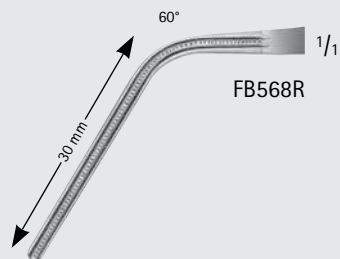
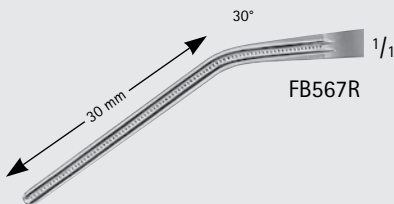
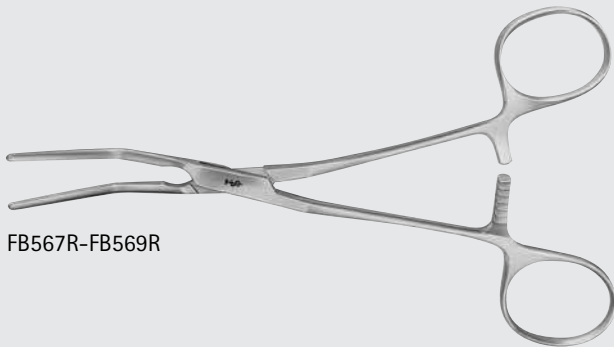
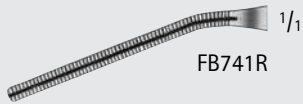
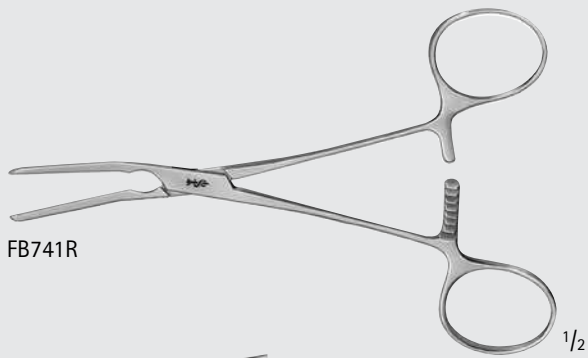



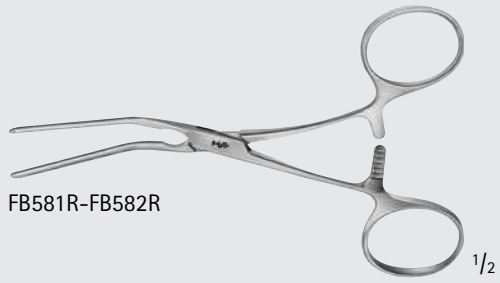

FB581R-FB582R

**CASTANEDA Atraumatic Neonatal  
Clamp, Angled**

Catalog Number	Jaw Angle	Jaw Length (mm)	Length (in.)
FB581R	30°	33	4 3/4
FB582R	45°	31	4 3/4

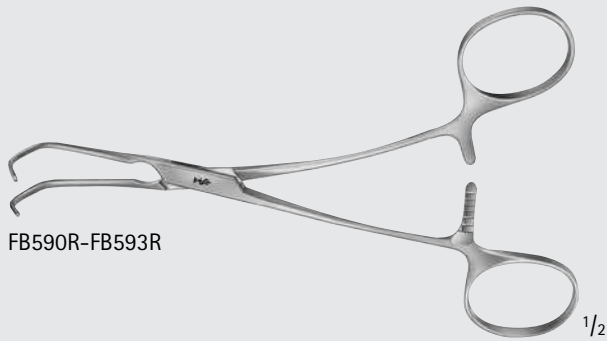
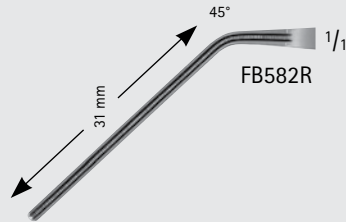
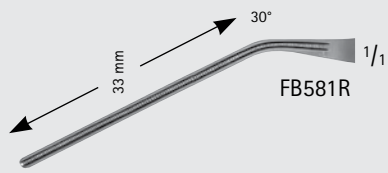

FB590R-FB593R

**CASTANEDA Atraumatic Neonatal  
Clamp**

Catalog Number	Jaw Angle	Jaw Length (mm)	Length (in.)
FB593R	CVD	15	6 1/8
FB590R	MULTI	18	6 1/8
FB591R	MULTI	23	6 1/8
FB592R	MULTI	25	6 1/8

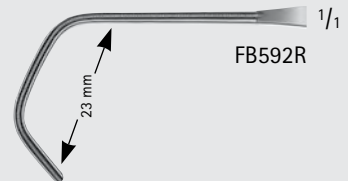
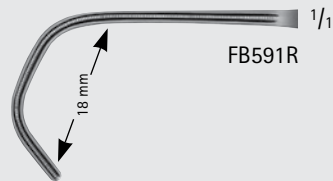
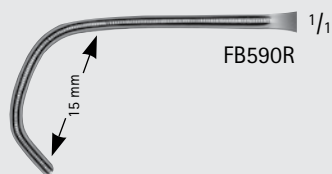
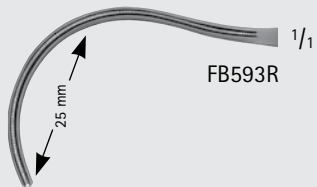

# Cardiovascular

## Vascular Clamps

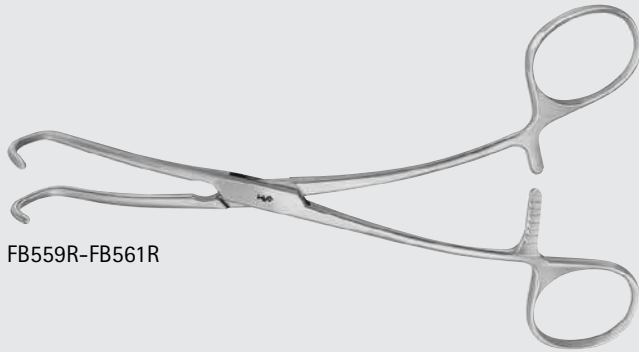
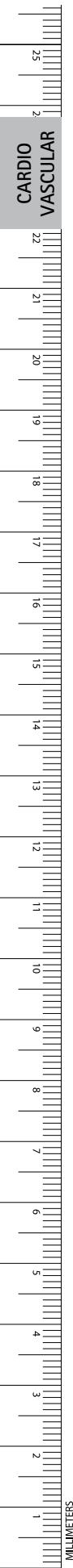

FB559R-FB561R

### DERRA Atraumatic Pediatric Forceps

Catalog Number	Jaw Angle	Jaw Length (mm)	Length (in.)
FB559R	MULTI	16	6 3/4
FB560R	MULTI	20	6 3/4
FB561R	MULTI	26	6 7/8



FB559R



FB560R

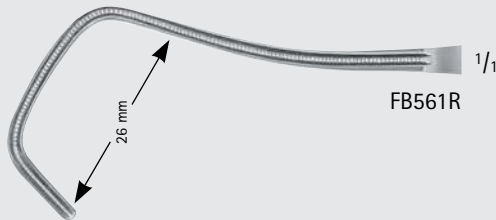

FB561R

LELAND-JONES Atraumatic Peripheral  
Clamp

Catalog Number	Jaw Angle	Jaw Length (mm)	Length (in.)
FB469R	STR	77	7 3/4
FB468R	15°	65	7 1/2
FB467R	30°	65	7 1/2

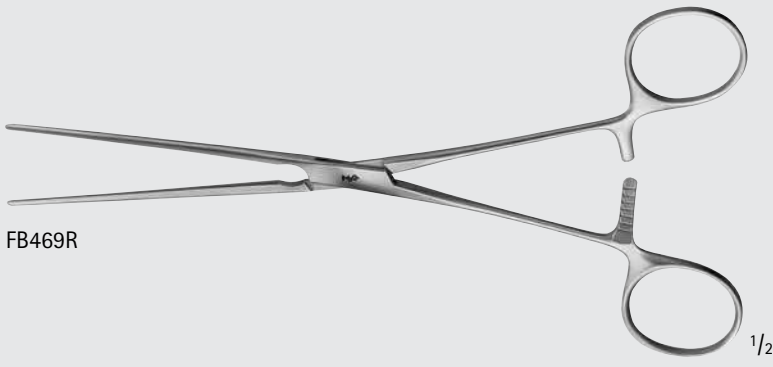

FB469R

1/2



1/1

77 mm

FB469R

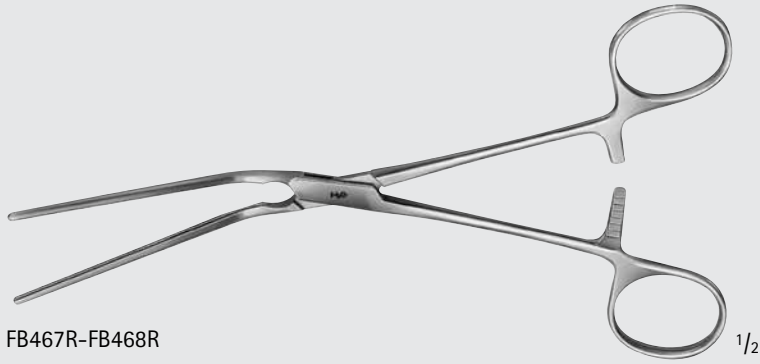

FB467R-FB468R

1/2

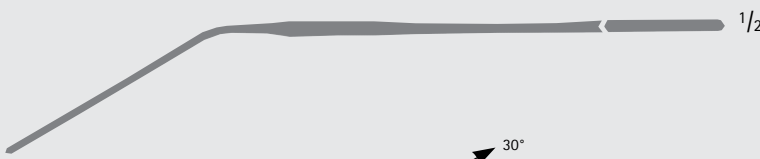

1/2

FB467R

1/1

65 mm

30°

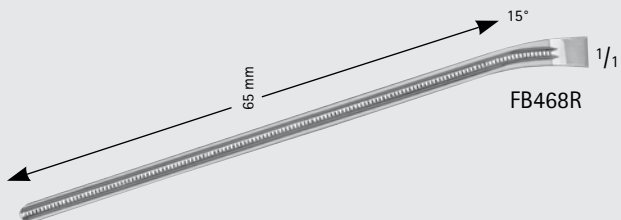

FB468R

1/1

65 mm

15°

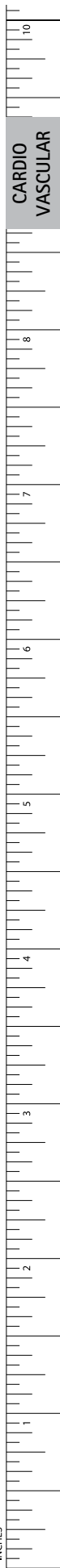

INCHES

# Cardiovascular

## Vascular Clamps

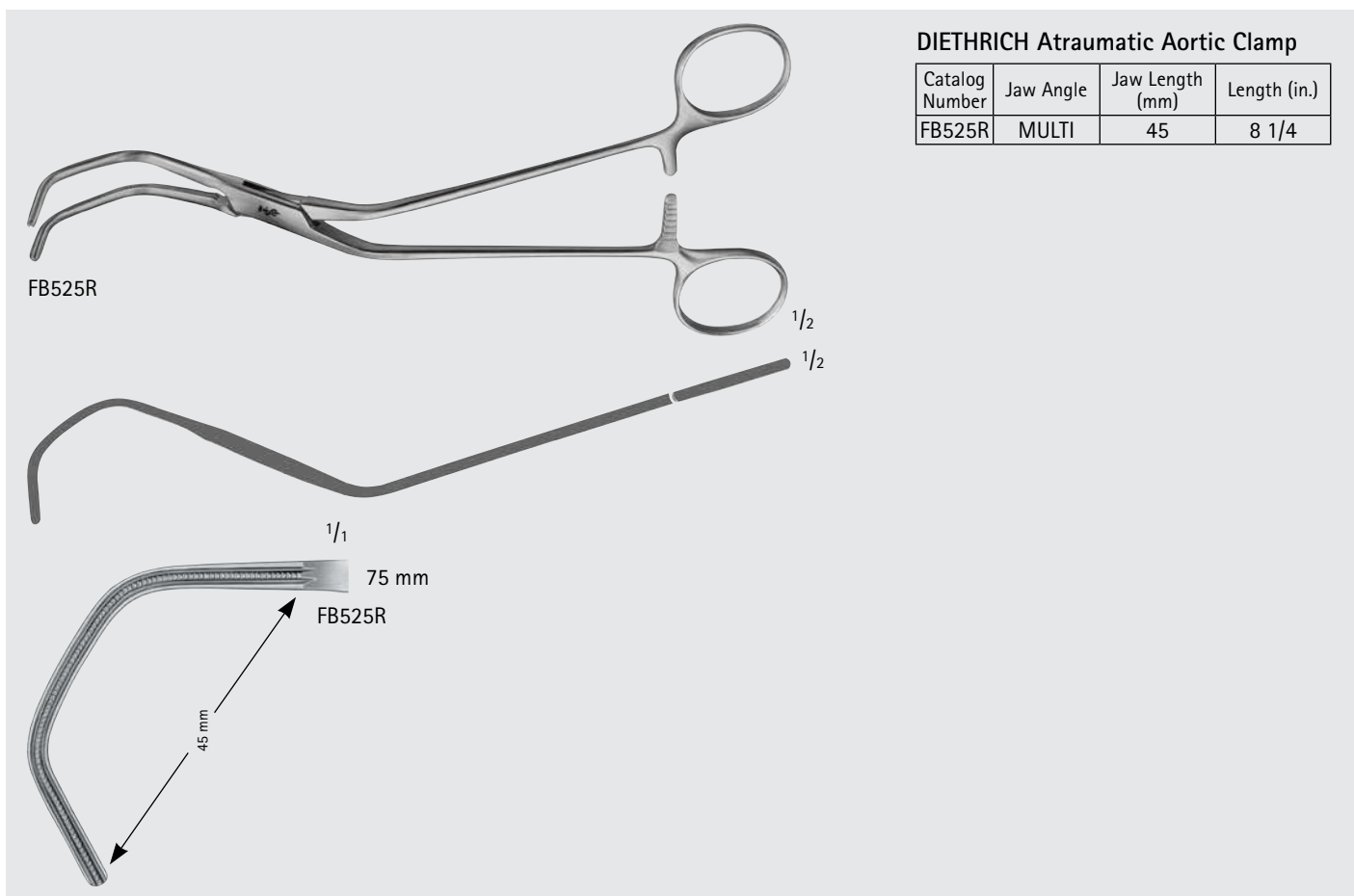
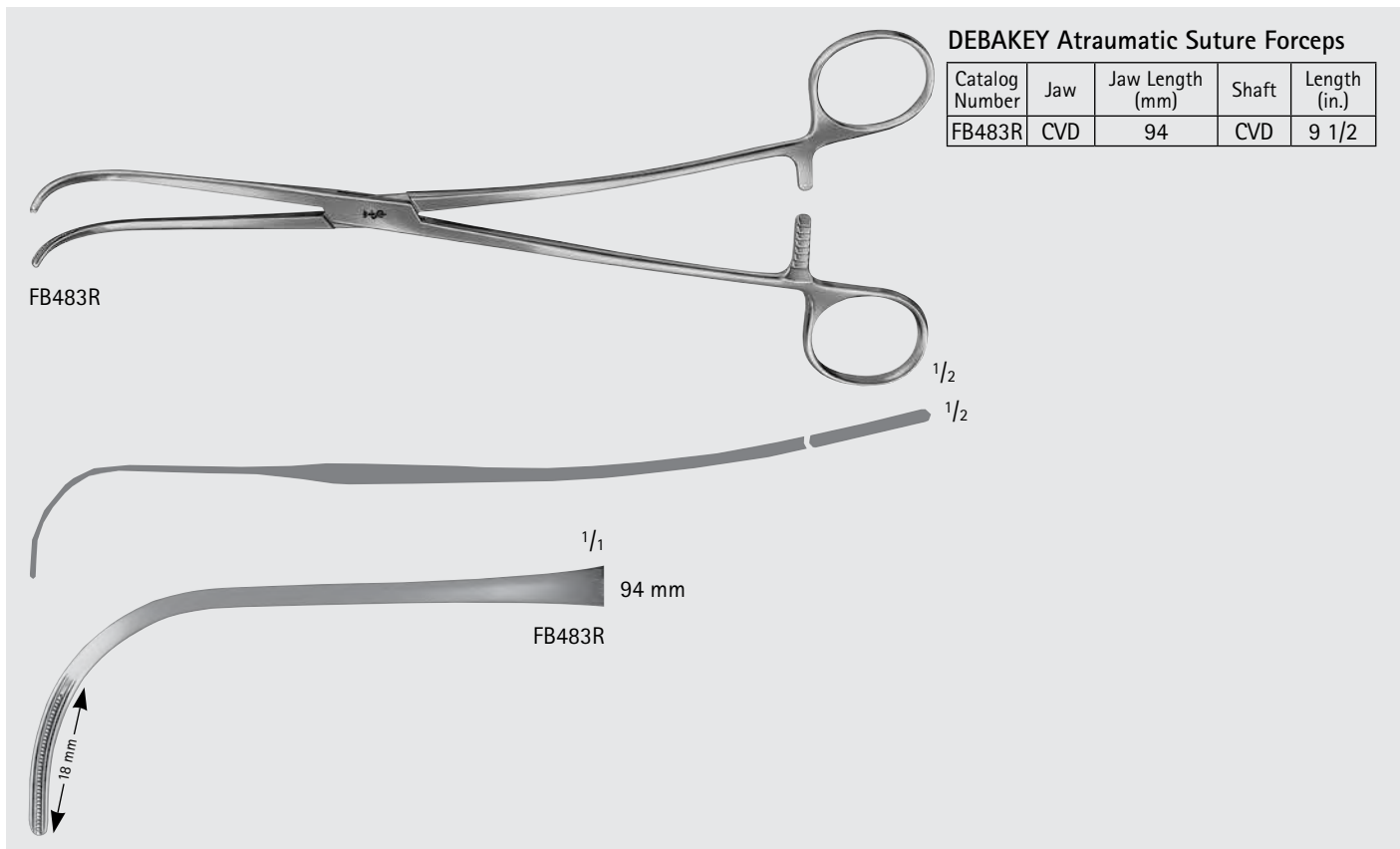
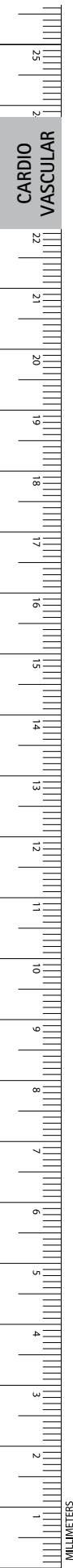

DEBAKEY Atraumatic Forceps

Catalog Number	Jaw	Jaw Length (mm)	Length (in.)
FB484R	C-CURVE	77	7 1/2
FB498R	C-CURVE	51	8 1/4
FB485R	D-CURVE	80	9
FB499R	D-CURVE	75	9

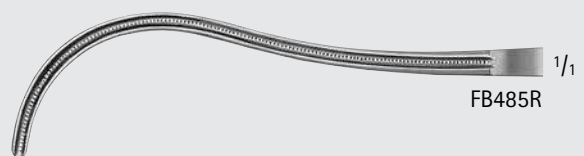
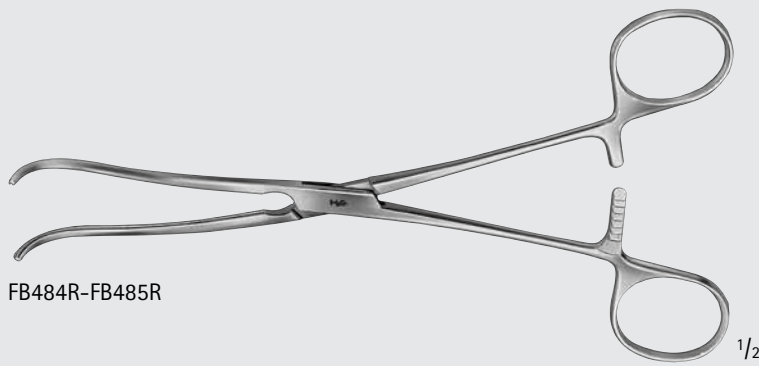

HENLY Atraumatic Clamp

Catalog Number	Jaw Length (mm)	Length (in.)
FB617R	75	7 7/8

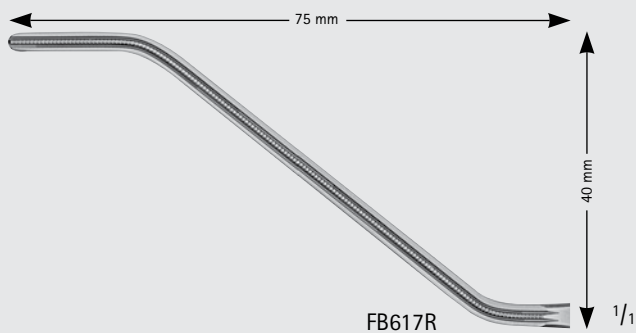
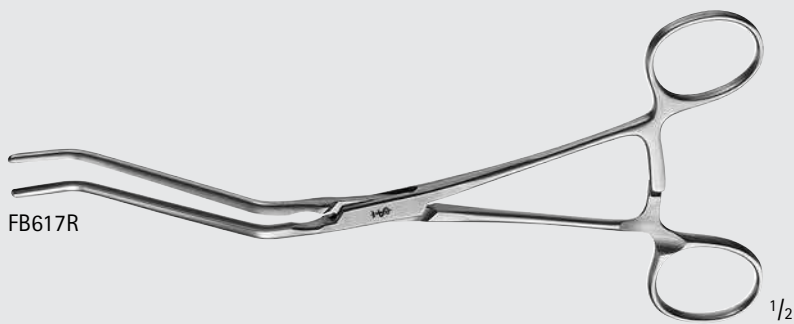

Cardiovascular  
Vascular Clamps

DEBAKEY-RUMEL Atraumatic Forceps

Catalog Number	Jaw	Jaw Length (mm)	Length (in.)
FB486R	SIGHT-CVD	81	9 3/4
FB487R	CVD	81	9 5/8

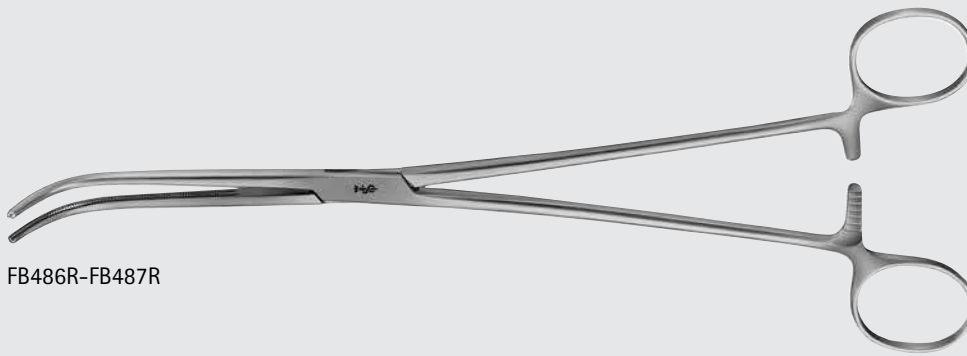

FB486R-FB487R

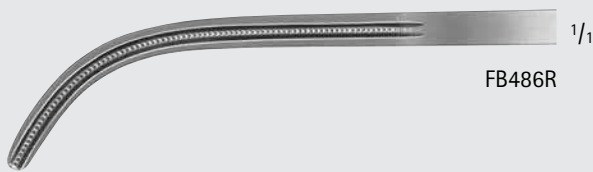

FB486R



FB487R

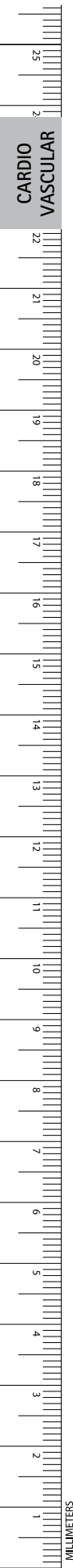

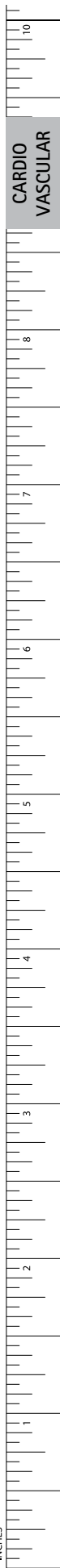

LEES Atraumatic Bronchus Clamp

Catalog Number	Jaw Angle	Jaw Length (mm)	Length (in.)
FB573R	90°	42	8 3/4

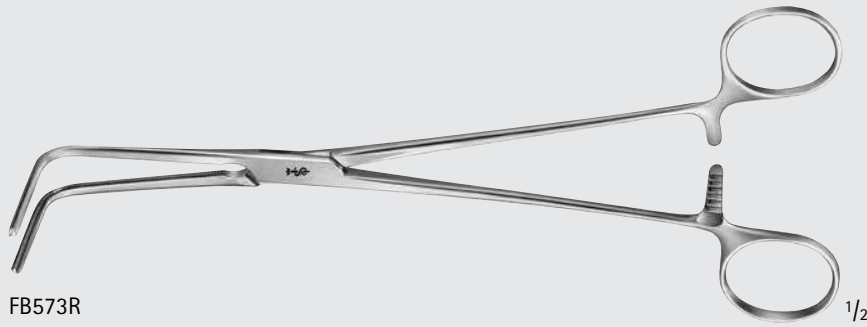

FB573R

1/2



90°

42 mm

1/1

FB573R

LEES Atraumatic Bronchus Clamp

Catalog Number	Jaw Angle	Jaw Length (mm)	Shaft	Length (in.)
FB574R	ANG	40	CVD	9 5/8

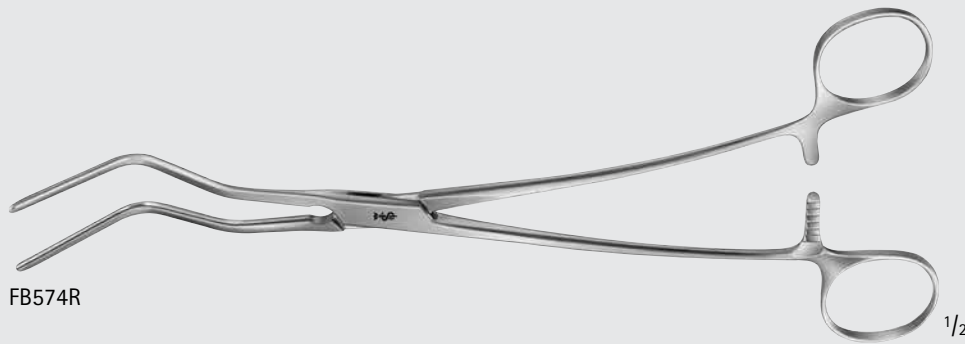

FB574R

1/2

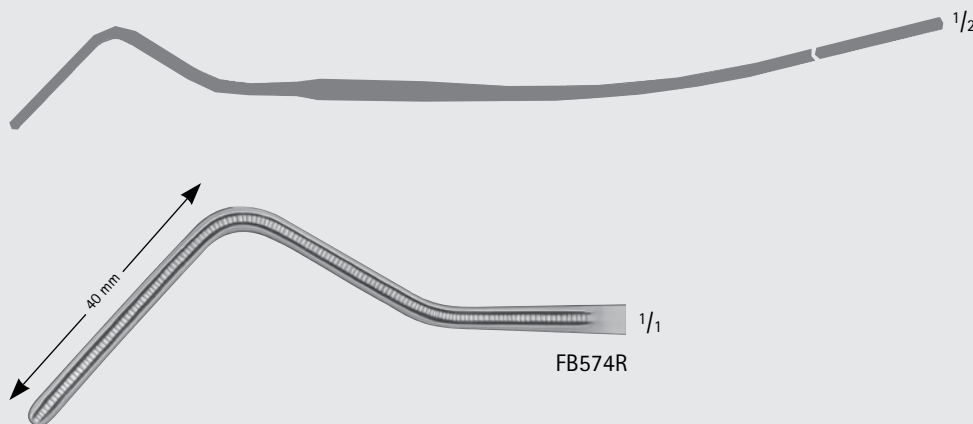

40 mm

1/1

FB574R

# Cardiovascular

## Vascular Clamps

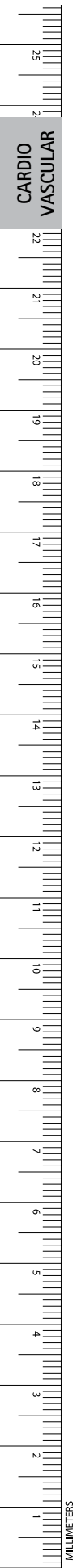

### DEBAKEY Atraumatic Multi-Purpose Clamp

Catalog Number	Jaw Angle	Jaw Length (mm)	Length (in.)
FB510R	60°	40	9 1/2
FB511R	60°	55	8 3/4
FB512R	60°	65	11
FB513R	60°	100	12

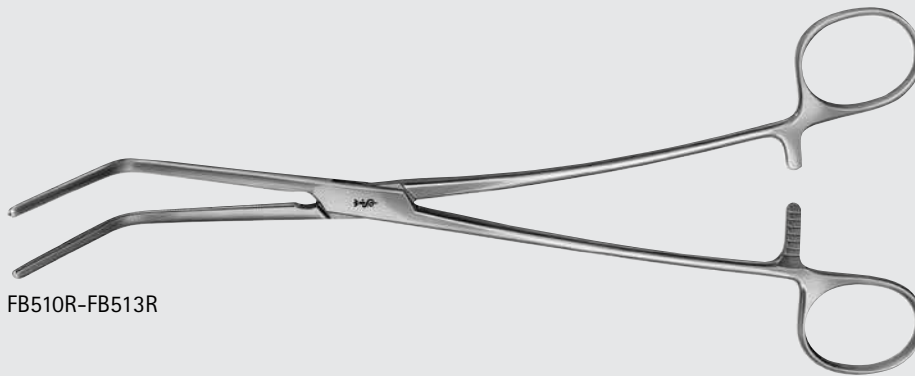

FB510R-FB513R

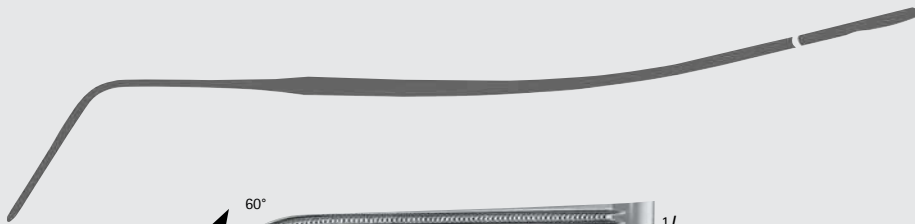

FB510R

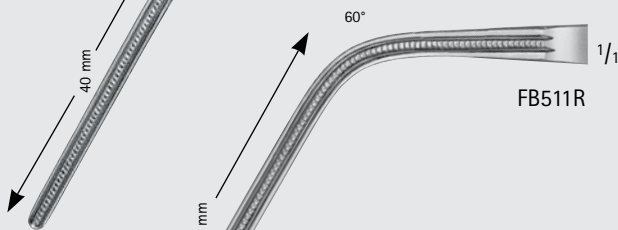

FB511R

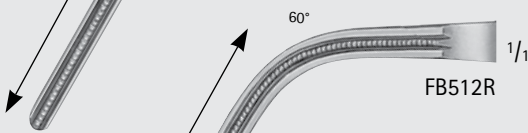

FB512R

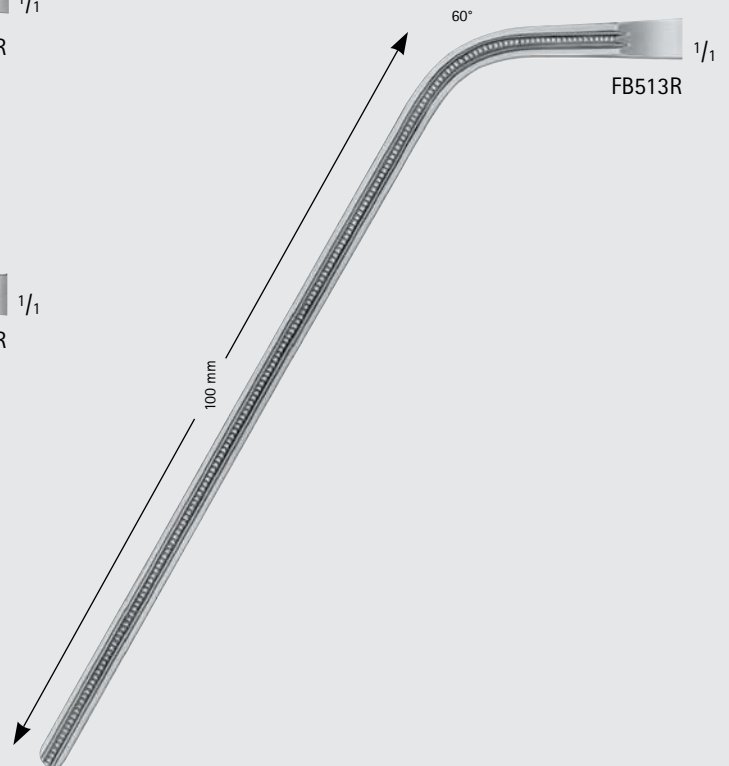

FB513R



DEBAKEY Atraumatic Multi-Purpose  
Clamp

Catalog Number	Jaw Angle	Jaw Length (mm)	Length (in.)
FB515R	90°	45	8 7/8
FB516R	90°	55	8 1/4
FB517R	90°	72	10
FB518R	90°	108	10 3/4

FB515R-FB518R

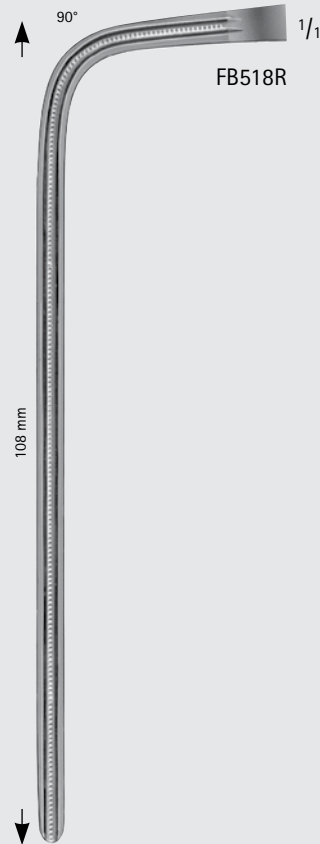
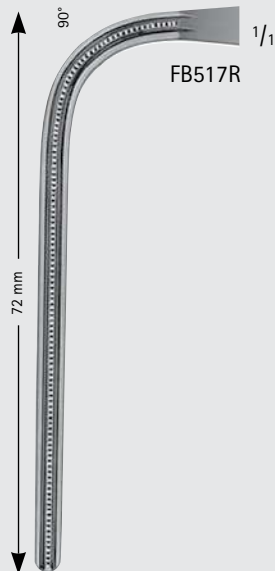
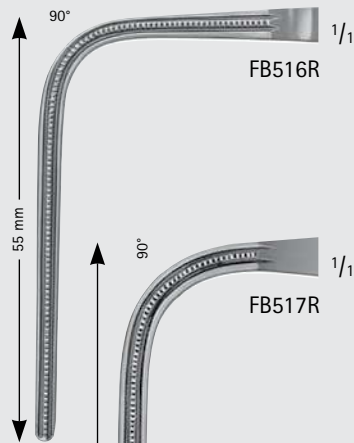
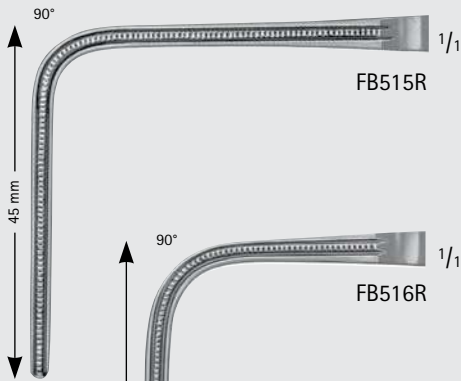
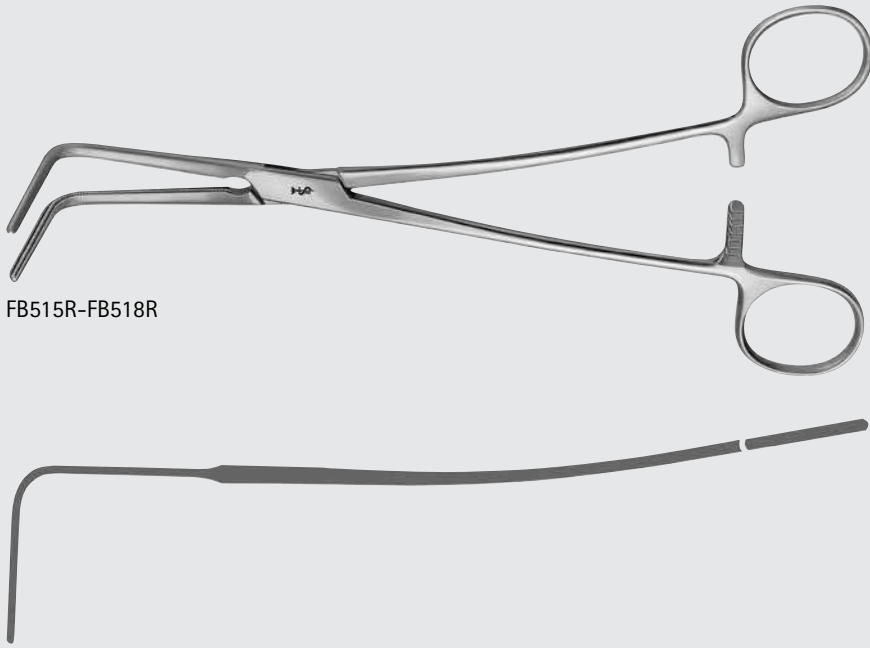

# Cardiovascular

## Vascular Clamps

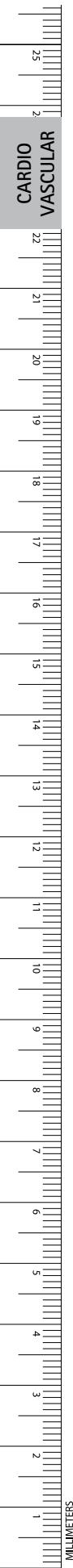

**LEMOLE-STRONG Atraumatic Clamp, Angled Shaft**

Catalog Number	Jaw Size (mm)	Length (in.)
FB618R	40 x 15	7 7/8
FB619R	45 x 20	7 7/8

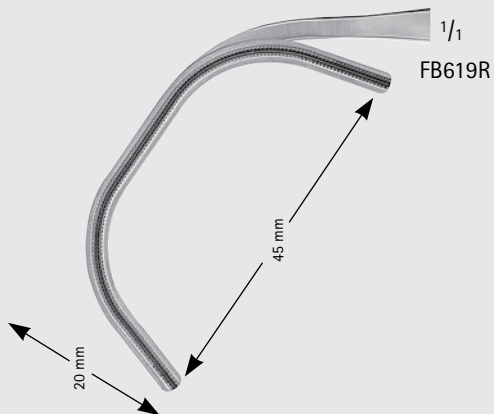
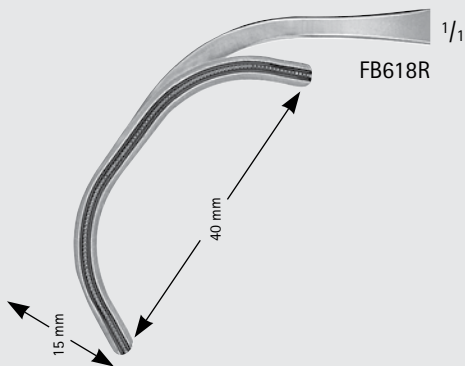

**STRONG Aorta Clamp, Straight Shaft**

Catalog Number	Jaw	Length (in.)
MG074R	CVD	7 7/8

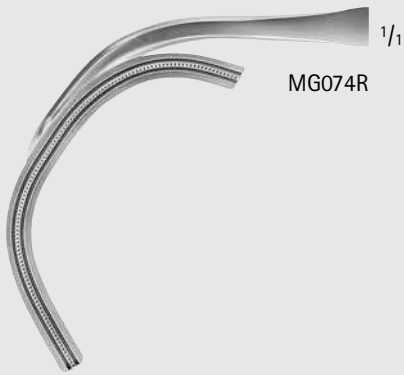
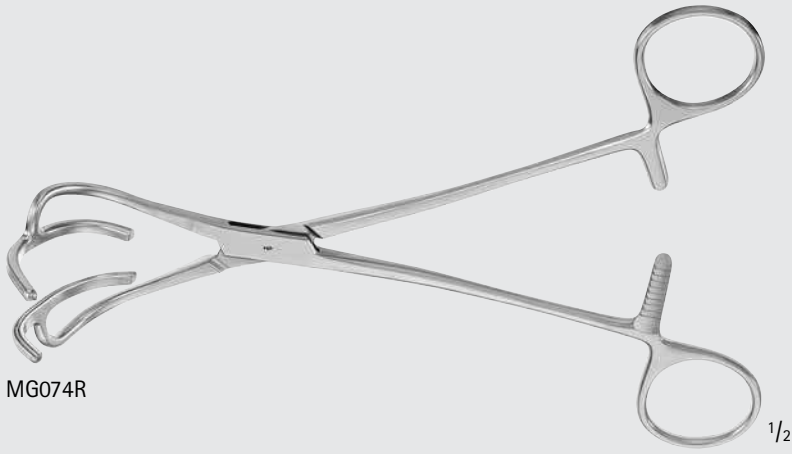

# Cardiovascular

## Vascular Clamps

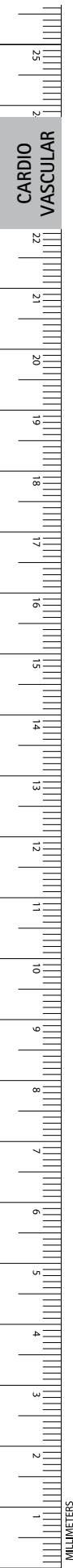

### WYLIE Hypogastric Clamp

Catalog Number	Jaw	Jaw Length (mm)	Shaft	Length (in.)
MB241	CVD	70	ANG	8 1/2
MB240	CVD	75	ANG	9 3/4



MB240-MB241

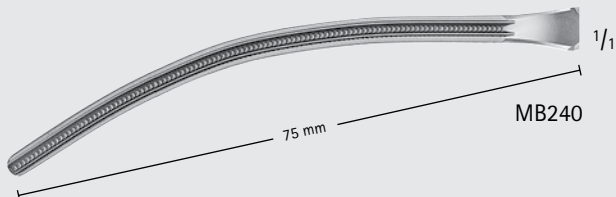
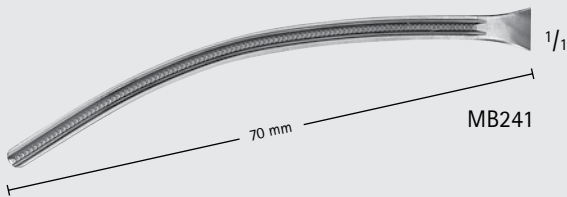

WYLIE Atraumatic Clamp

Catalog Number	Jaw	Length (in.)
FB669R	HEAVY-CVD	8 3/4
FB670R	CVD-BACK	9



FB669R-FB670R

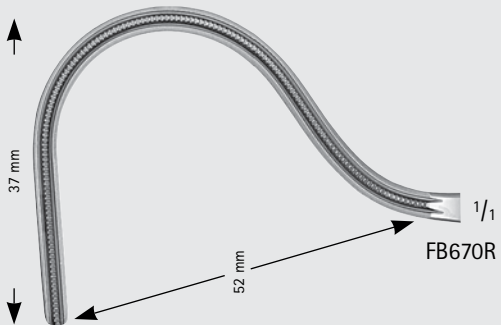
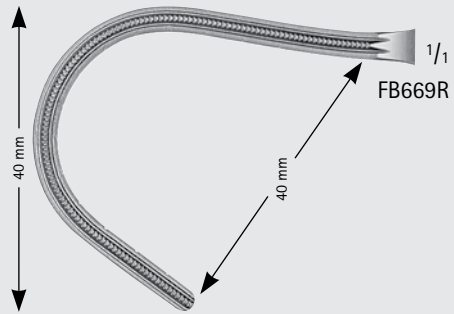

# Cardiovascular

## Vascular Clamps

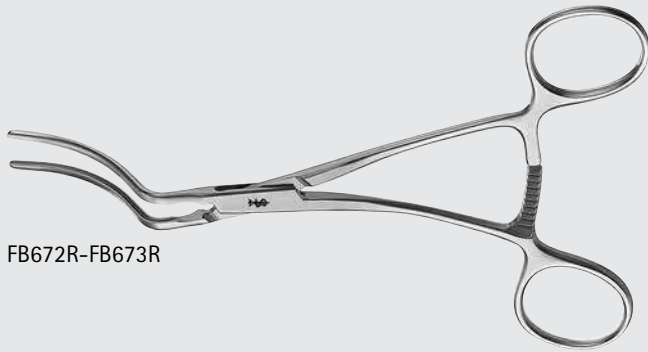
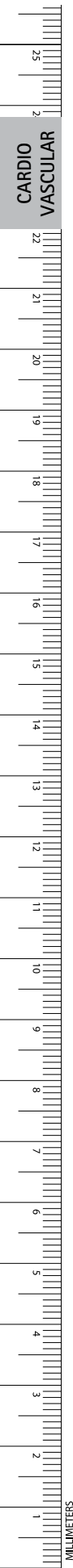

FB672R-FB673R

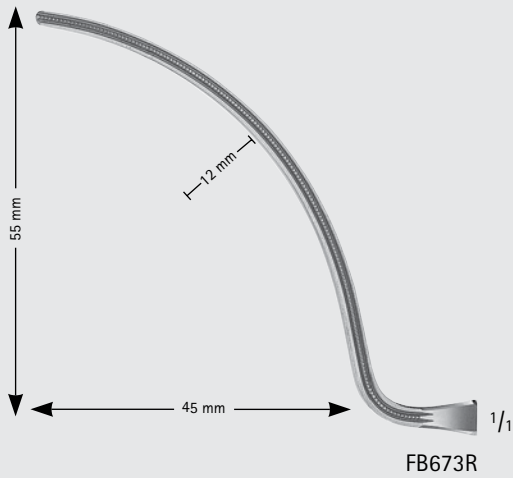
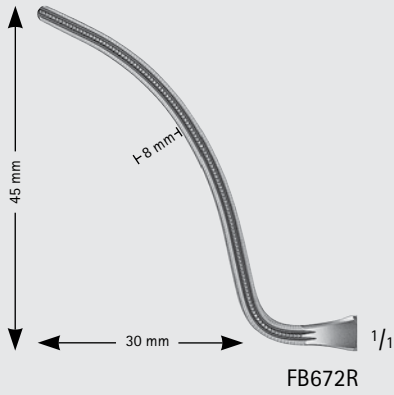

### WYLIE Atraumatic Clamp

Catalog Number	Jaw	Length (in.)
FB672R	CVD-UP	6 1/4
FB673R	CVD-UP	7

WYLIE Atraumatic Clamp

Catalog Number	Jaw	Length (in.)
FB674R	CVD-DOWN	6
FB675R	CVD-DOWN	6 1/2

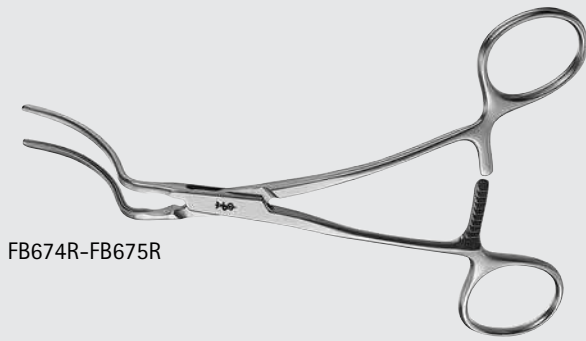

FB674R-FB675R

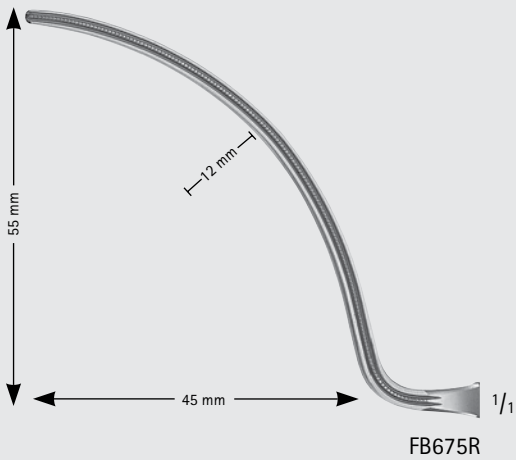
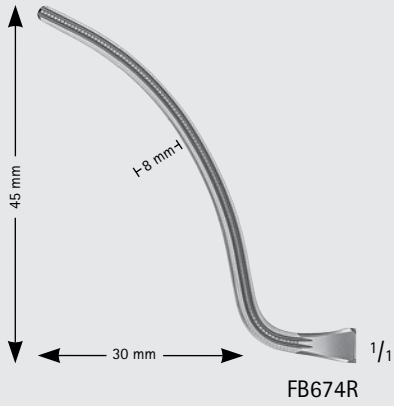

INCHES

# Cardiovascular

## Vascular Clamps

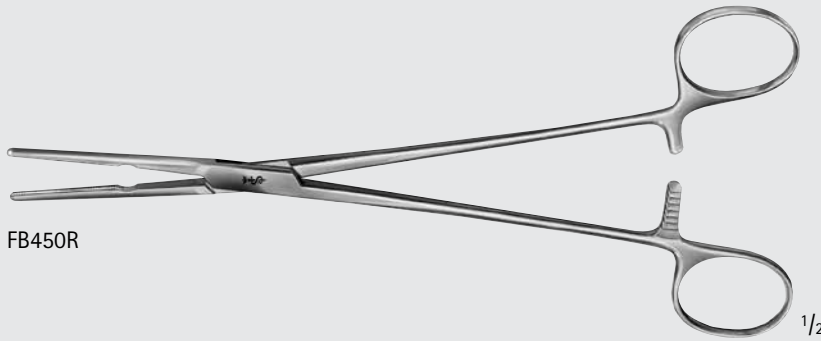
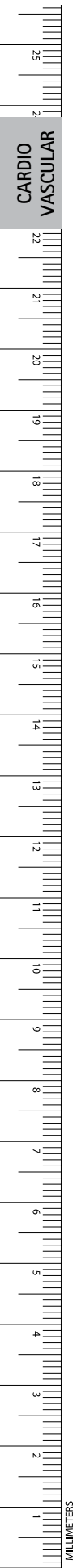

FB450R

1/2



FB450R

### DEBAKEY Atraumatic Patent Ductus Clamp

Catalog Number	Jaw Length (mm)	Shaft	Length (in.)
FB450R	51	STR	8 1/4
FB451R	51	ANG	8 1/4

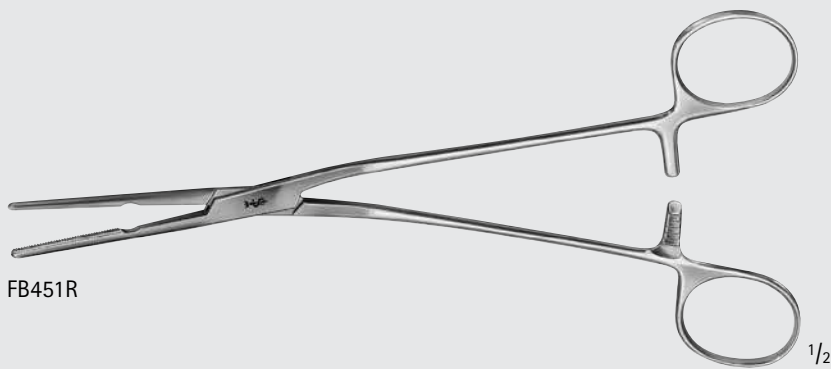

FB451R

1/2

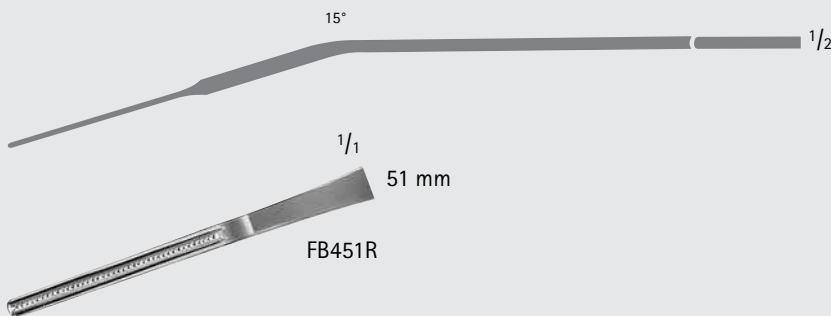

FB451R



DEBAKEY Atraumatic Coarctation  
Clamp

Catalog Number	Jaw Length (mm)	Shaft	Length (in.)
FB453R	41	ANG	7 7/8
FB553R	50	ANG	6 1/2
FB455R	65	ANG	8 7/8
FB457R	80	ANG	9 1/2



FB453R-FB457R



15°



FB453R

1/1

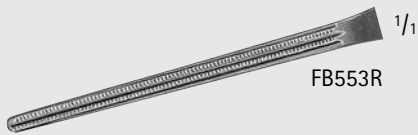

FB553R

1/1

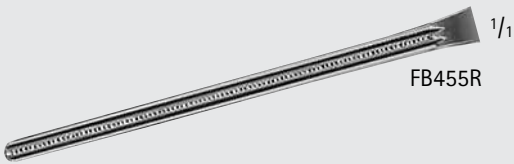

FB455R

1/1

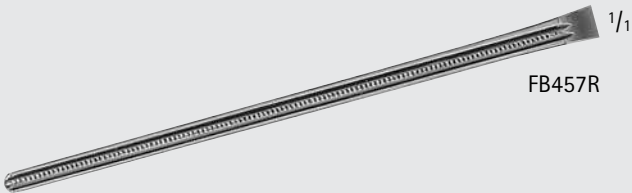

FB457R

1/1



INCHES

# Cardiovascular

## Vascular Clamps

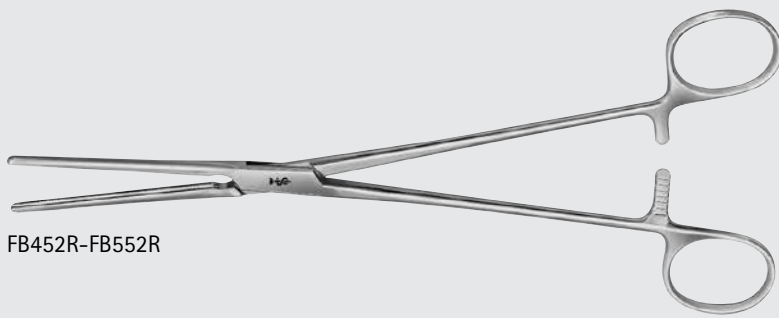
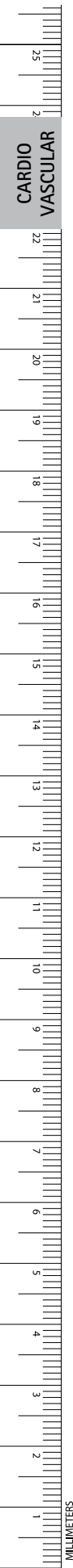

FB452R-FB552R

### DEBAKEY Atraumatic Coarctation Clamp

Catalog Number	Jaw	Jaw Length (mm)	Length (in.)
FB452R	STR	41	8
FB552R	STR	50	6 3/4
FB454R	STR	65	8 7/8
FB456R	STR	80	9 1/2



FB452R



FB552R



FB454R



FB456R



MG423R

1/2

### NOON AV Fistula Clamp

Catalog Number	Jaw Angle	Length (in.)
MG423R	50°	4 3/4

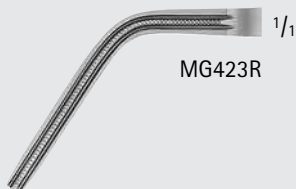

MG423R

1/1

GLOVER Atraumatic Clamp

Catalog Number	Jaw	Jaw Length (mm)	Length (in.)
FB458R	CVD	65	8 1/2
FB460R	SPOON SHAPED	60	8 3/4
FB550R	SPOON SHAPED	70	9 5/8
FB459R	CVD	86	9 5/8
FB461R	FULL-CVD	47	7 3/4
FB462R	FULL-CVD	63	8 1/4



FB458R-FB550R

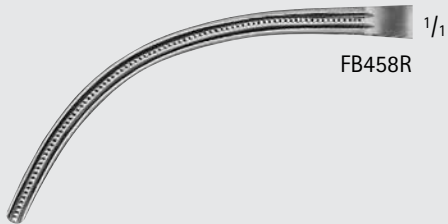

FB458R

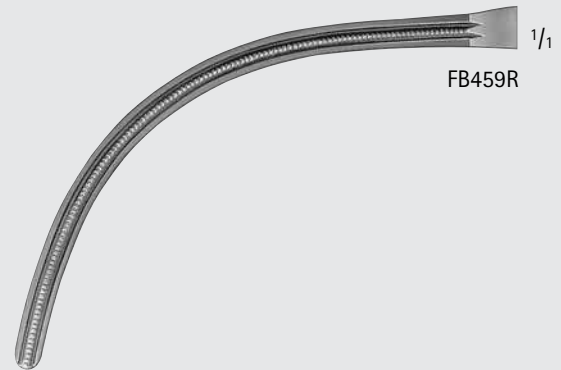

FB459R



FB460R

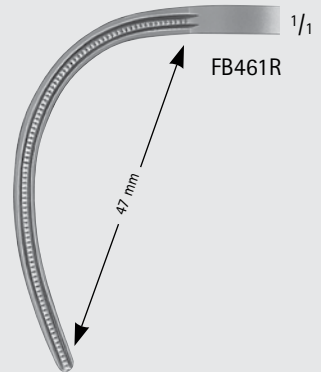

FB461R



FB550R

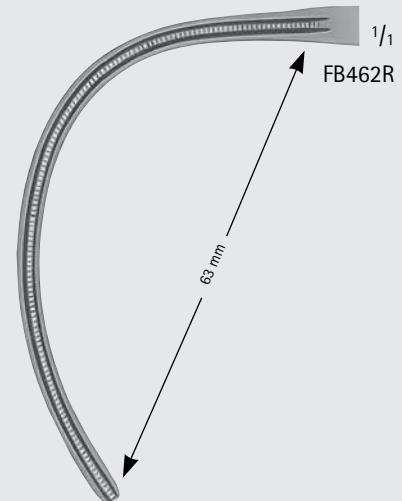

FB462R



# Cardiovascular

## Vascular Clamps

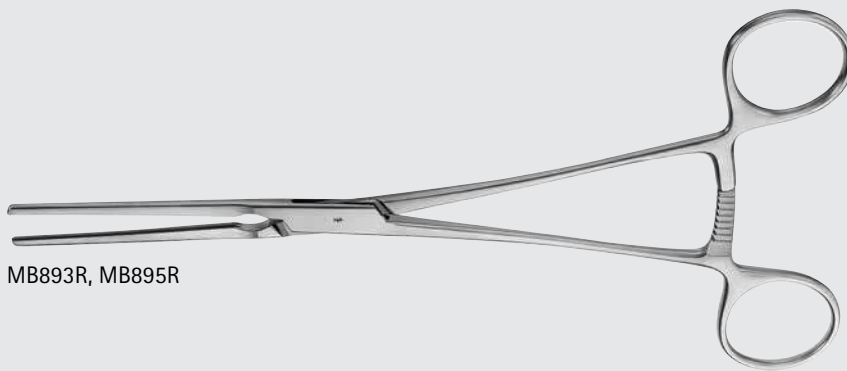
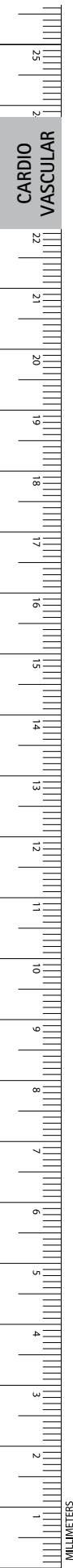

MB893R, MB895R



MB893R



MB895R

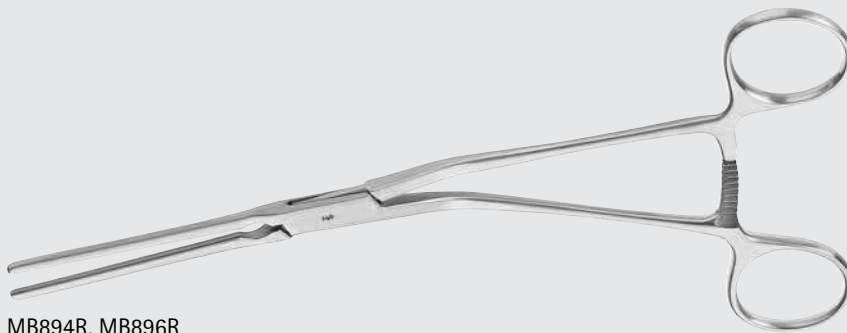

MB894R, MB896R



MB894R



MB896R

### GLOVER Coarctation Clamp

Catalog Number	Jaw	Jaw Length (mm)	Length (in.)
MB893R	STR	60	9
MB895R	STR	70	10 1/4
MB894R	ANG	60	8 3/4
MB896R	ANG	70	10

GREGORY Atraumata Profunda Clamp

Catalog Number	Jaw	Jaw Length (mm)	Length (in.)
MG014R	X-SMALL	29	5
MB750R	SMALL	57	5 3/4
MB751R	MEDIUM	62	7
MB752R	LARGE	75	7 3/4

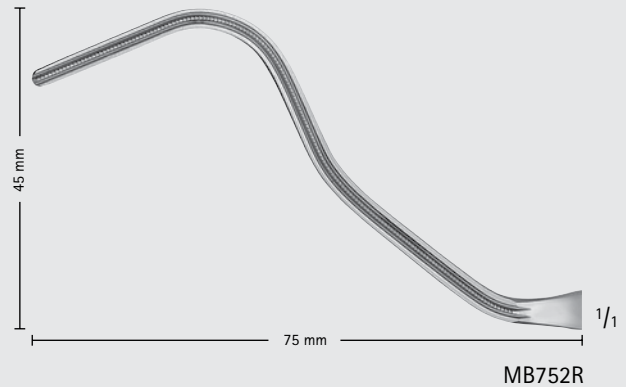
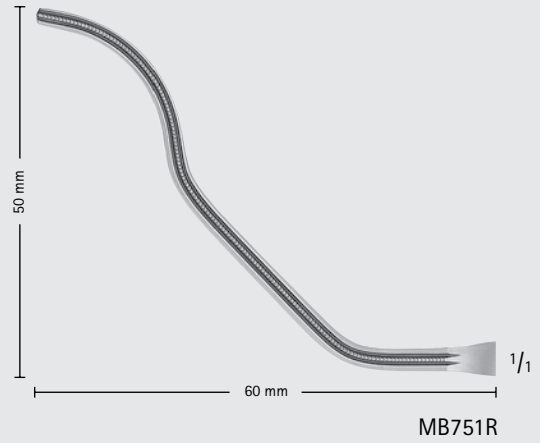
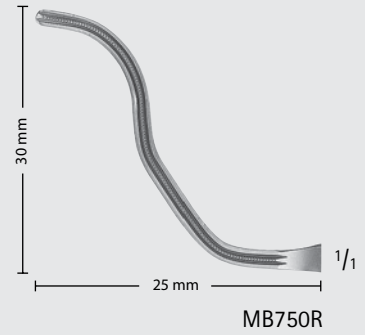
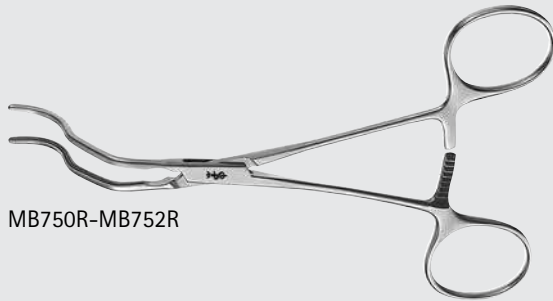
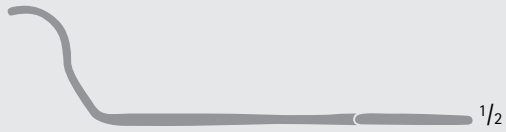
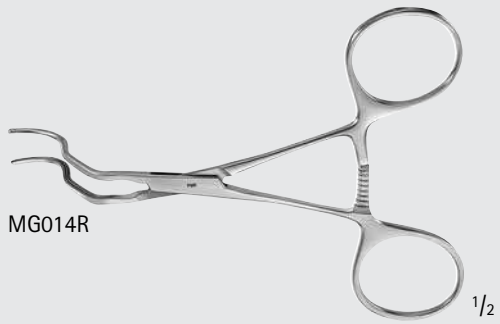

# Cardiovascular

## Vascular Clamps

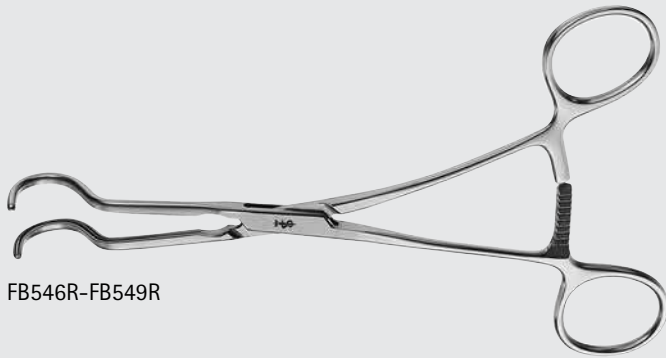
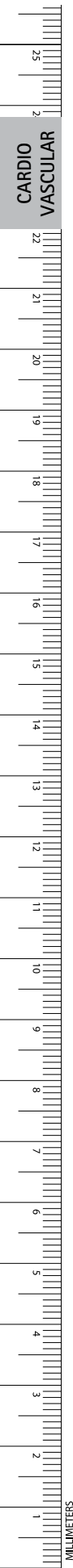

FB546R-FB549R

### DALE Femoral Popliteal Clamp

Catalog Number	Jaw	Length (in.)
FB546R	SMALL	6 7/8
FB547R	MEDIUM	7
FB548R	LARGE	7
FB549R	-	7

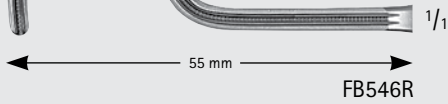

FB546R

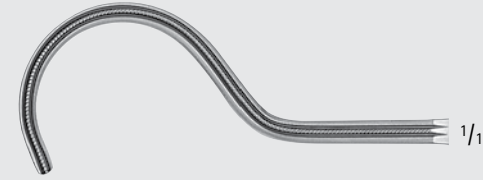

FB547R

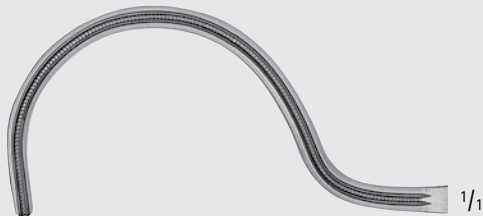

FB548R

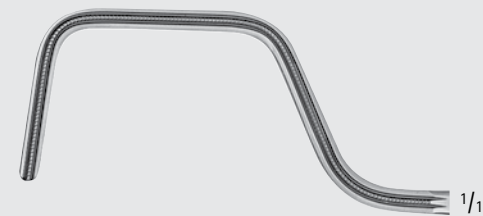

FB549R

SELMAN Vessel Forceps

Catalog Number	Jaw	Jaw Length (mm)	Length (in.)
MG361R	STR, COOLEY SERR	25	5 1/4
MG362R	ANG, COOLEY SERR	25	5 1/4

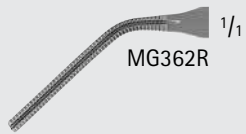
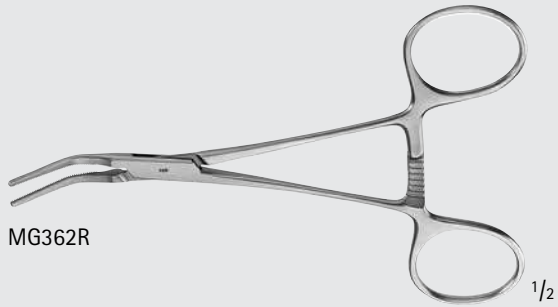
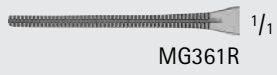
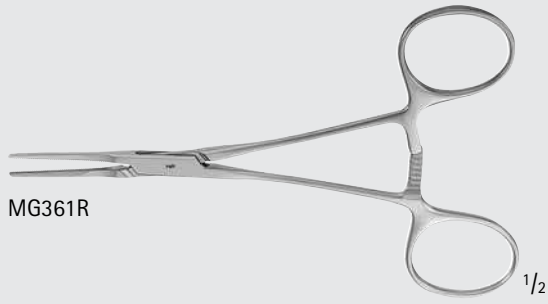

Cardiovascular  
Vascular Clamps

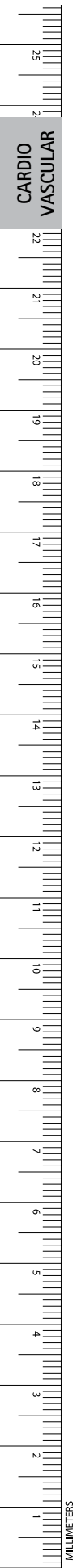

**CHERRY Clamp**

Catalog Number	Jaw	Teeth	Shaft	Length (in.)
MG368R	CVD	2 x 3	60° ANG	12 3/8

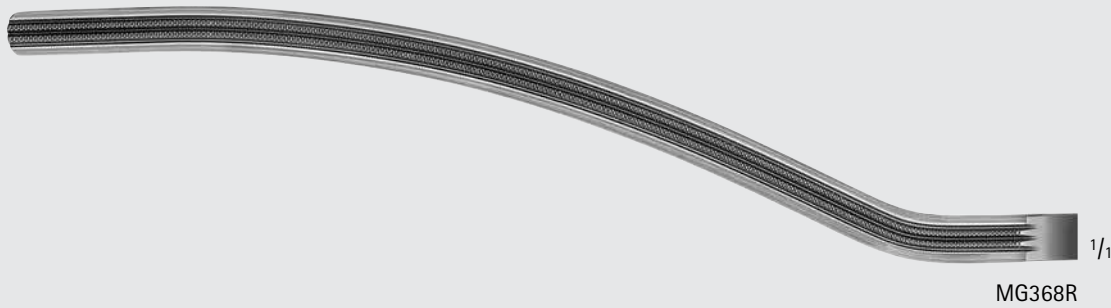
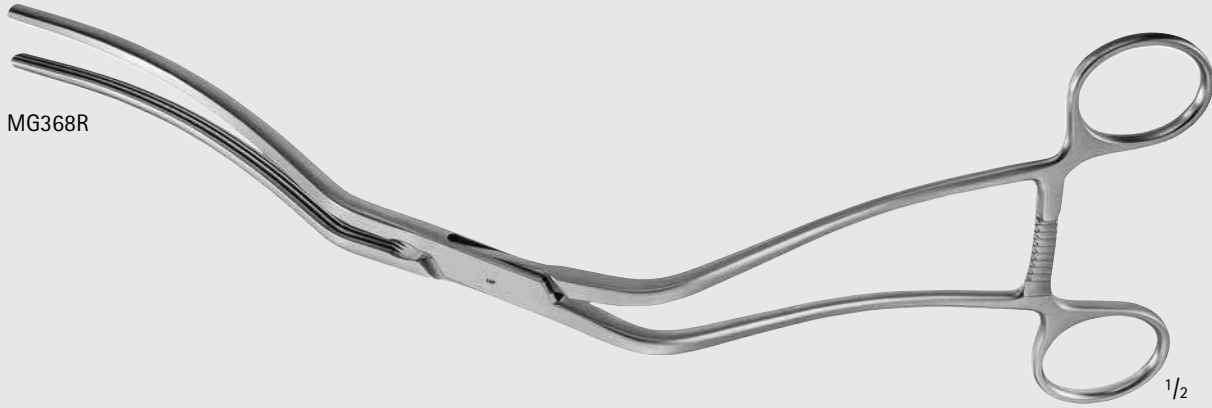



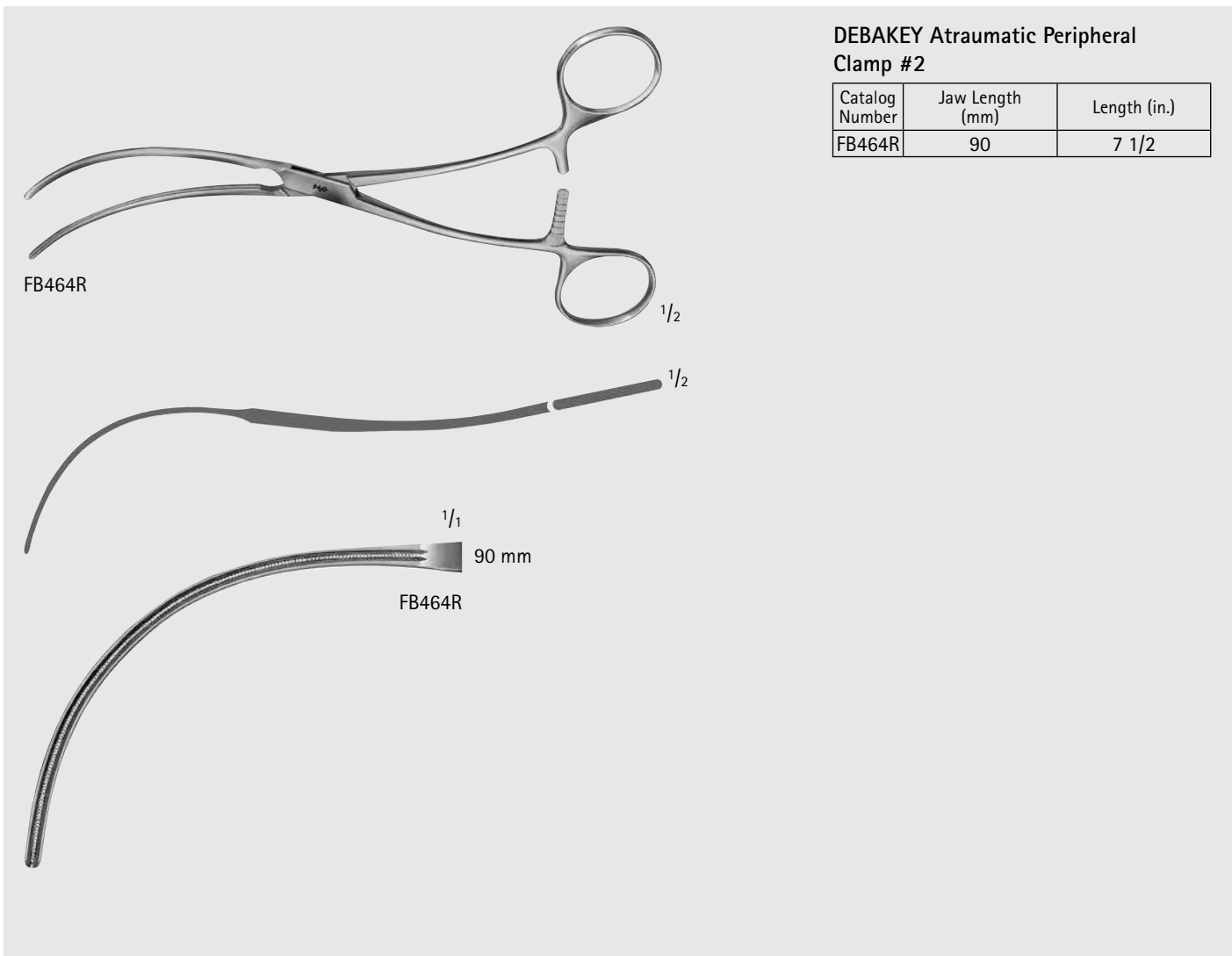
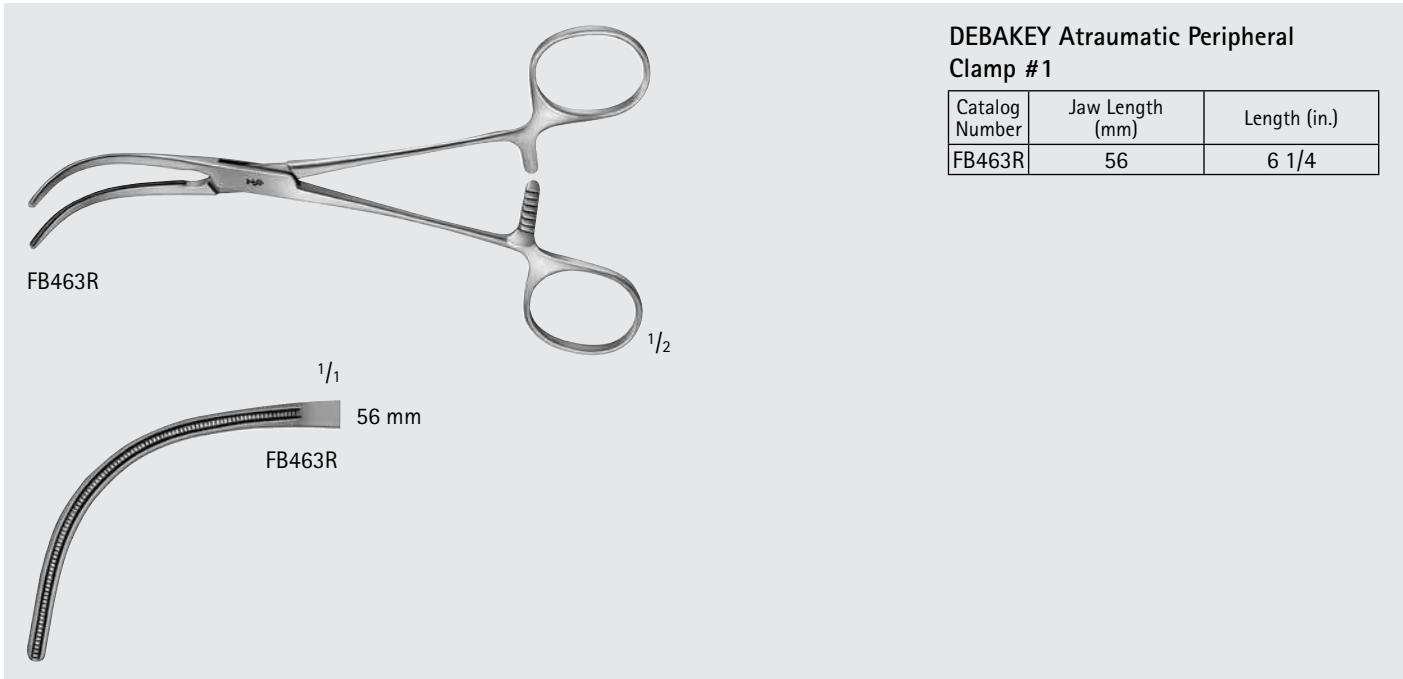

Cardiovascular  
Vascular Clamps

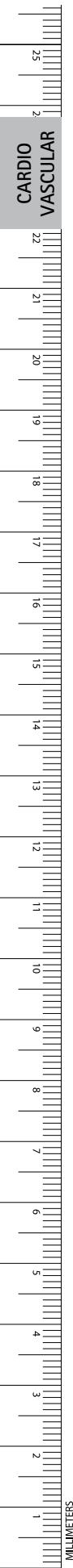

CARDIO  
VASCULAR

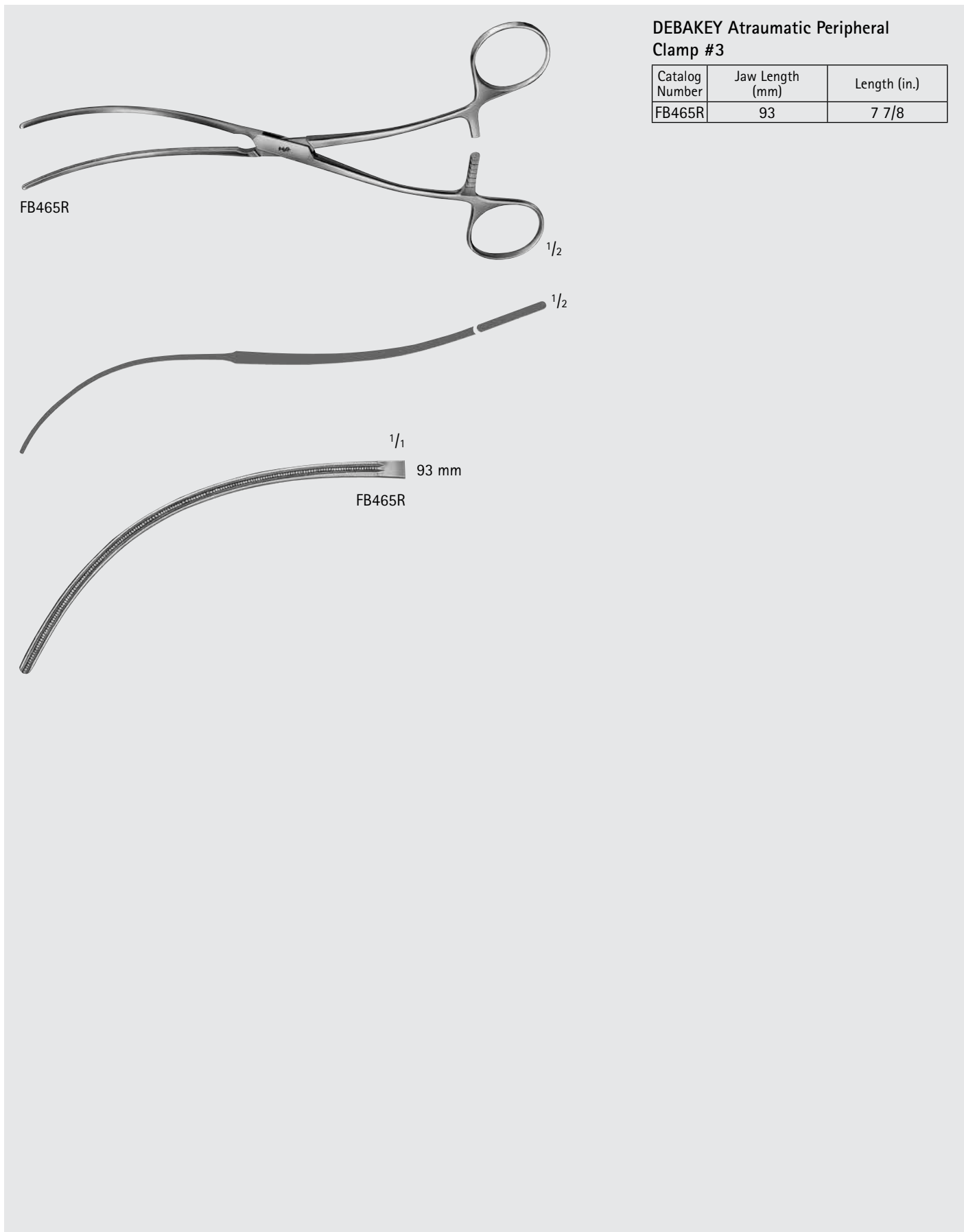

DEBAKEY Atraumatic Peripheral  
Clamp #3

Catalog Number	Jaw Length (mm)	Length (in.)
FB465R	93	7 7/8

FB465R

1/2

1/2

1/1

93 mm

FB465R

DEBAKEY Atraumatic Peripheral  
Clamp #4

Catalog Number	Jaw Angle	Jaw Length (mm)	Length (in.)
FB466R	60°	77	7

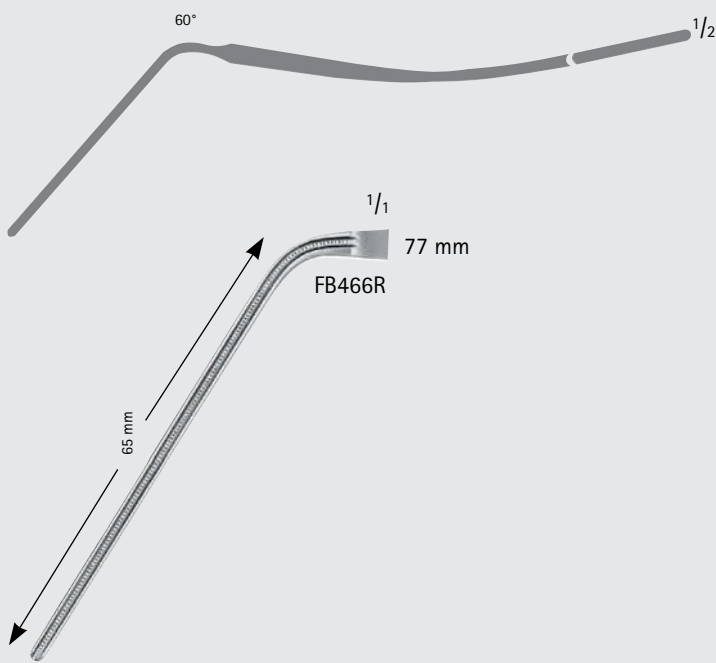
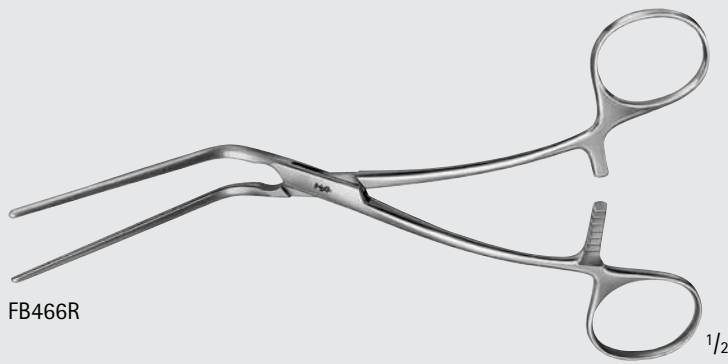

Cardiovascular  
Vascular Clamps

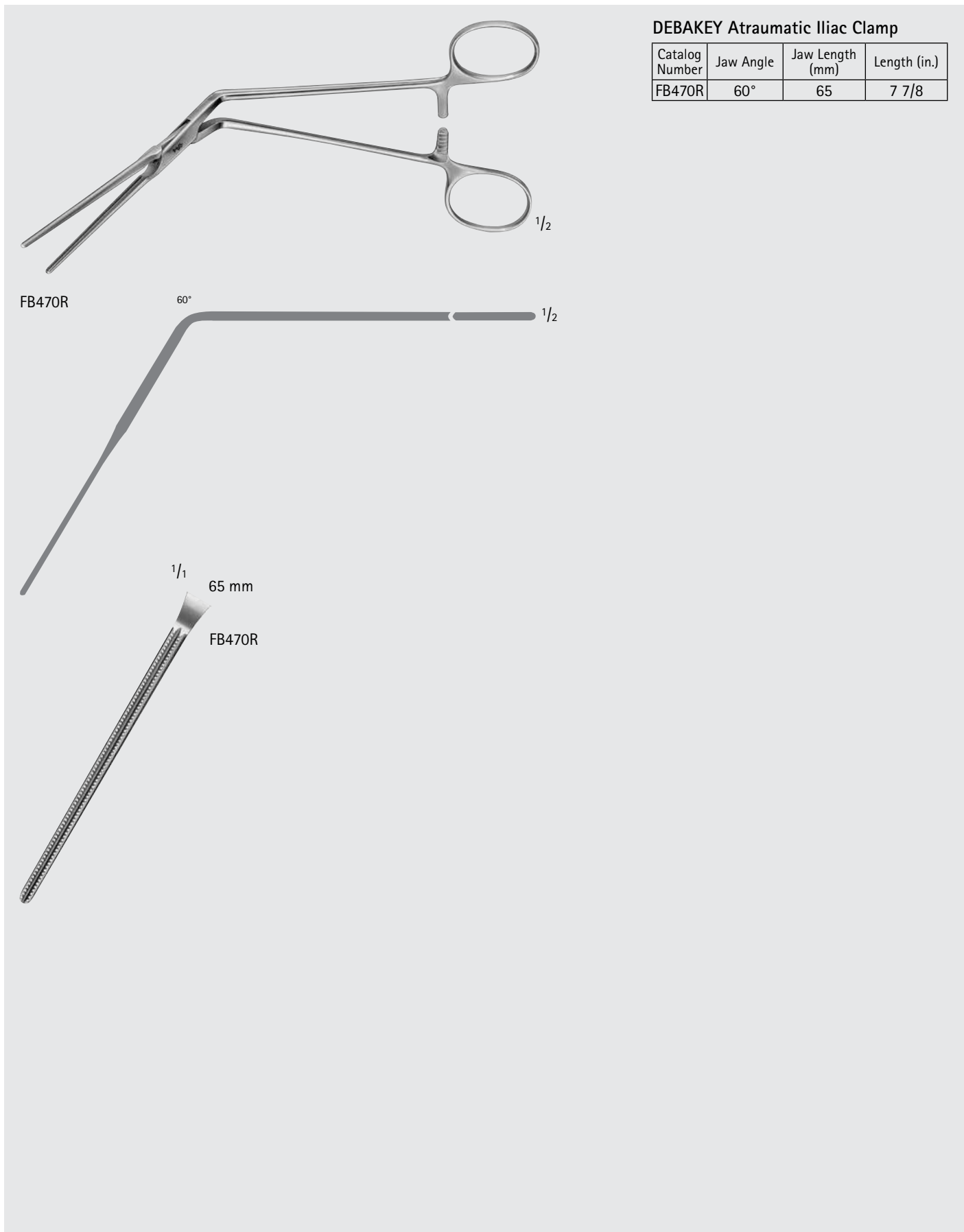
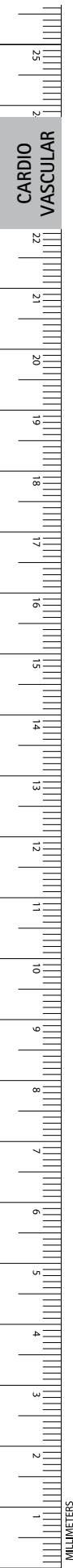

DEBAKEY Atraumatic Iliac Clamp

Catalog Number	Jaw Angle	Jaw Length (mm)	Length (in.)
FB470R	60°	65	7 7/8

COOLEY Aortic Aneurysm Clamp

Catalog Number	Jaw	Jaw Length (mm)	Length (in.)
MG448R	CVD	75	10

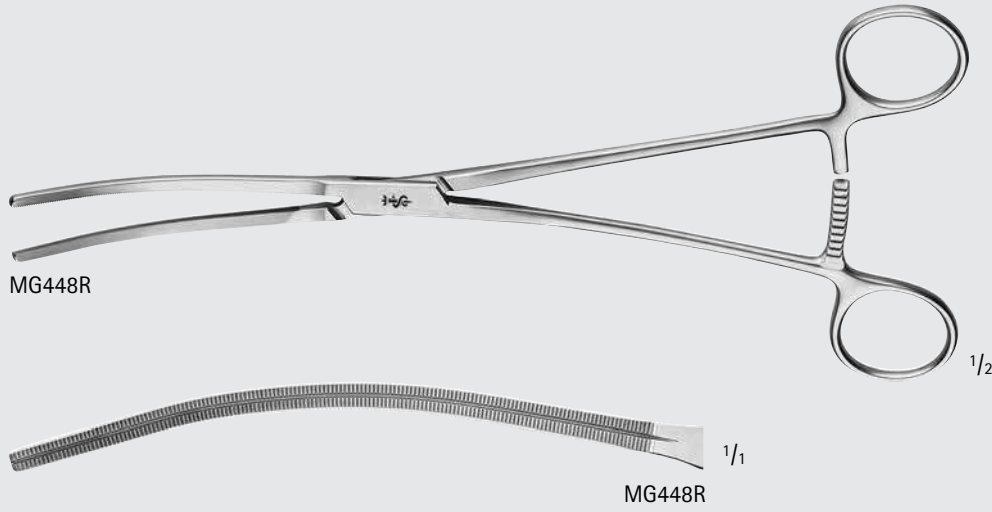

INCHES

Cardiovascular  
Vascular Clamps



DEBAKEY Atraumatic Aortic Aneurysm  
Clamp, Light Curved

Catalog Number	Jaw	Jaw Length (mm)	Length (in.)
FB471R	2 x 3 SERR	95	9 3/4
FB472R	2 x 3 SERR	110	11 3/4
FB473R	2 x 3 SERR	130	12 3/8
FB480R	2 x 3 SERR	140	12 3/4

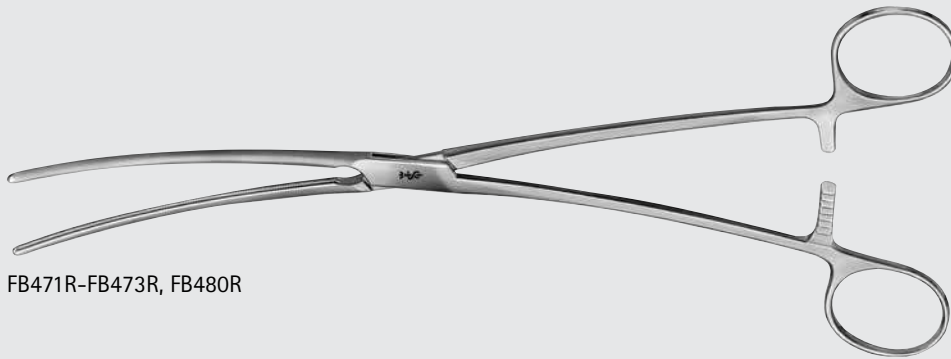

FB471R-FB473R, FB480R



FB471R 1/1

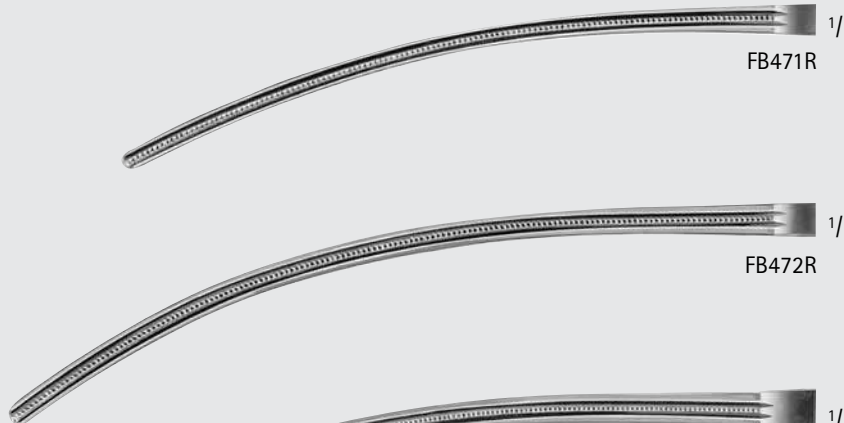

FB472R 1/1

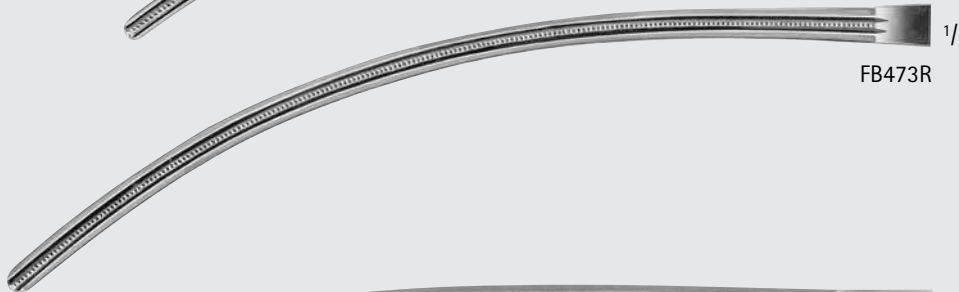

FB473R 1/1



FB480R 1/1

DEBAKEY Atraumatic Aortic Aneurysm  
Clamp

Catalog Number	Jaw	Jaw Length (mm)	Length (in.)
FB478R	SLIGHT-CVD	70	10
FB477R	CVD	75	10 1/2
FB476R	HEAVY-CVD	85	11

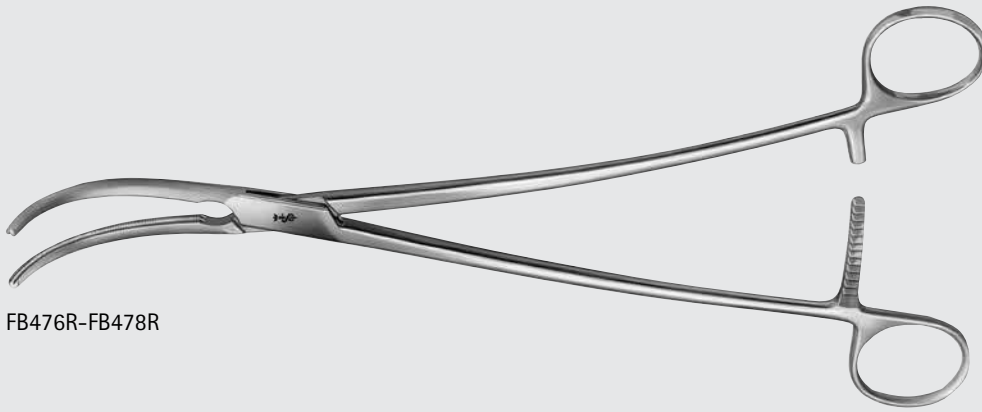

FB476R-FB478R

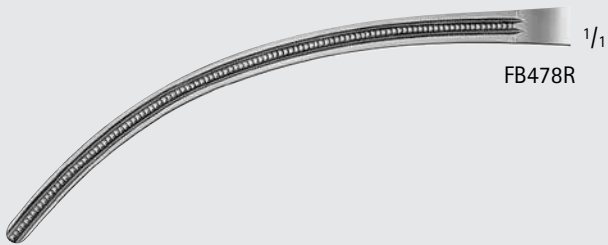

FB478R

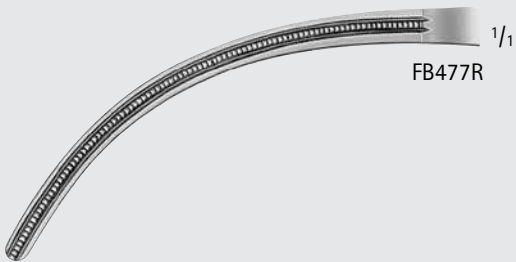

FB477R

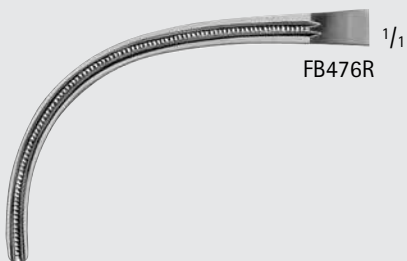

FB476R



Cardiovascular  
Vascular Clamps

DEBAKEY Atraumatic Aortic Aneurysm  
Clamp, S-Curved

Catalog Number	Jaw Length (mm)	Length (in.)
FB475R	115	11 3/4

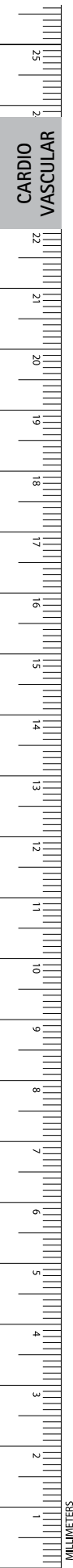
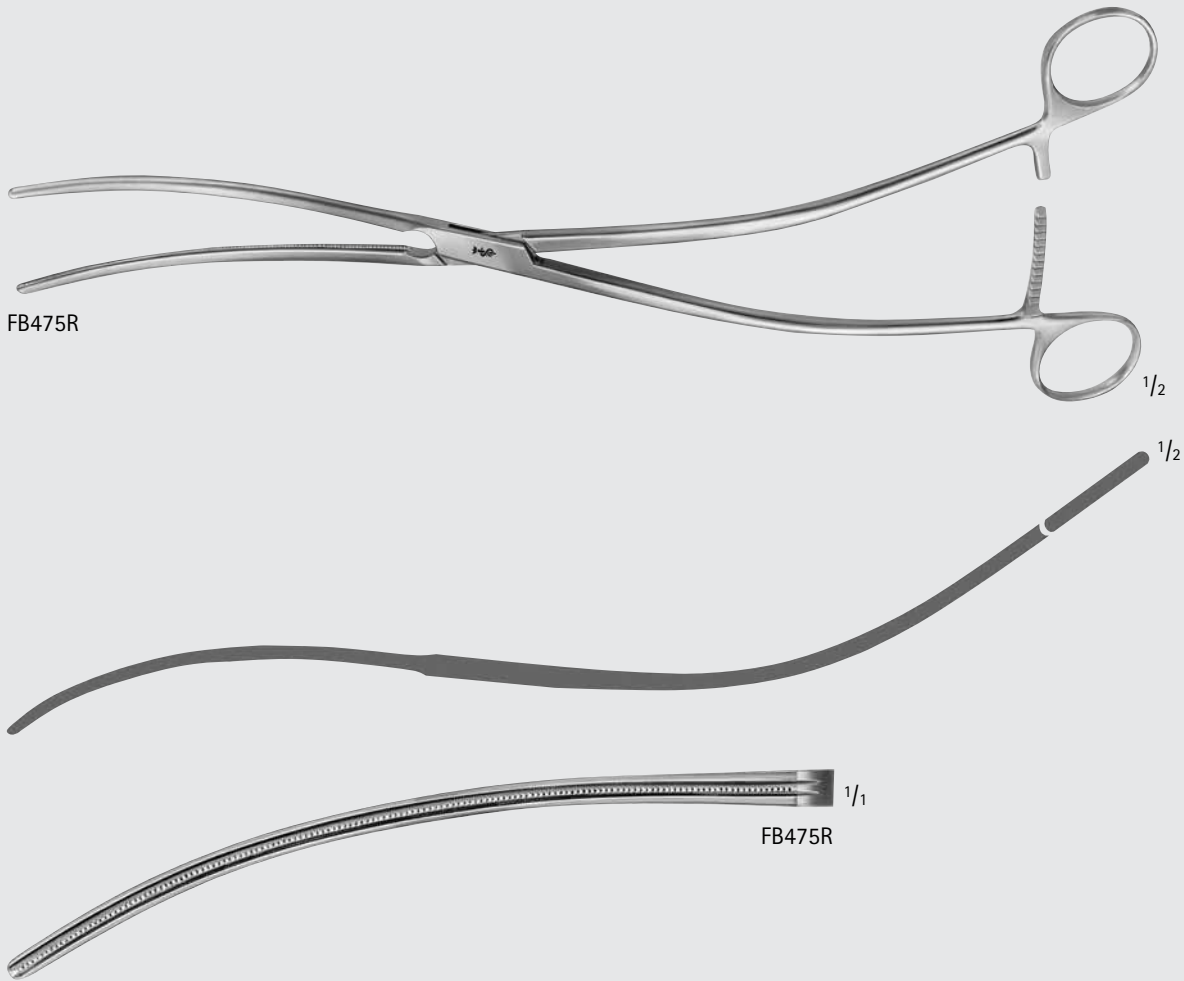



DEBAKEY-SEMB Atraumatic Aortic  
Aneurysm Clamp, Curved

Catalog Number	Jaw Length (mm)	Length (in.)
FB482R	100	10 1/2

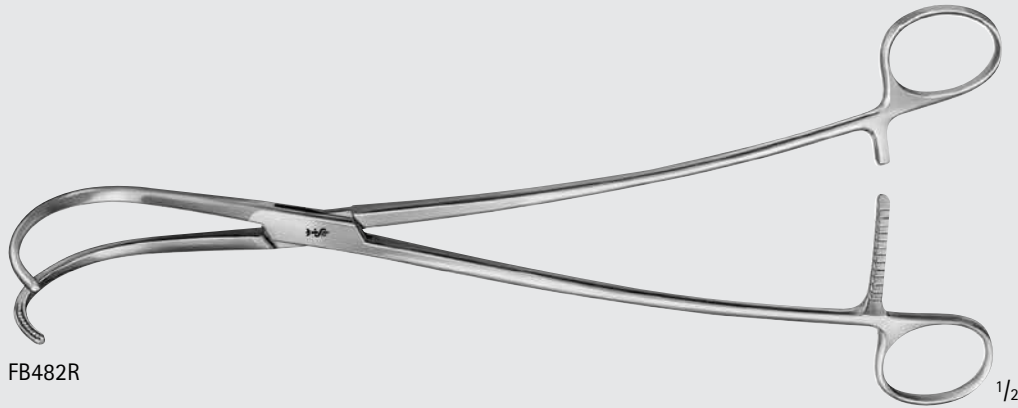

FB482R

1/2



1/2



FB482R

1/1

20 mm

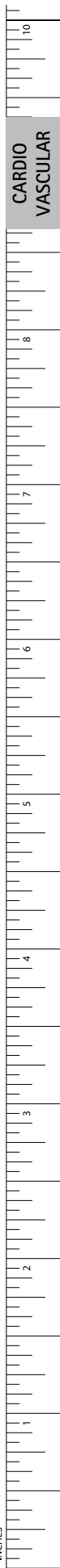

INCHES

Cardiovascular  
Vascular Clamps

DEBAKEY Atraumatic Aortic Aneurysm  
Clamp, Full Curved

Catalog Number	Jaw Length (mm)	Length (in.)
FB481R	111	10 5/8

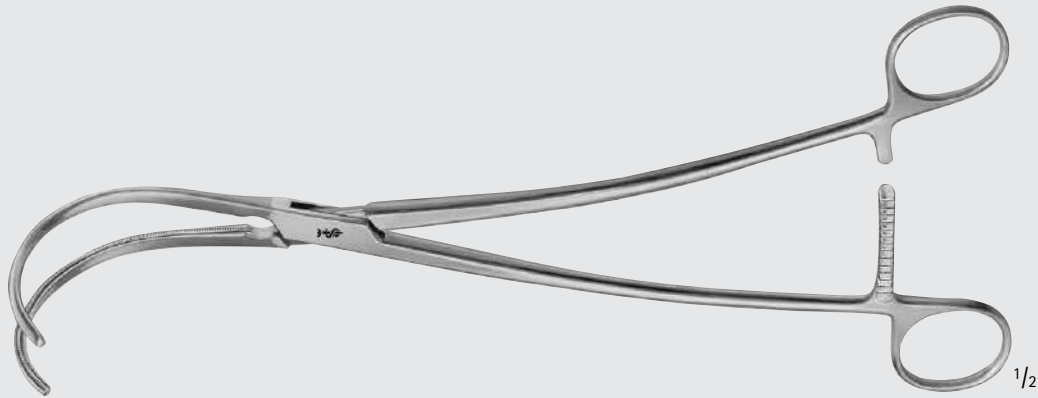

FB481R

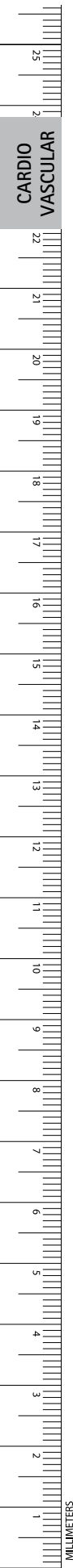
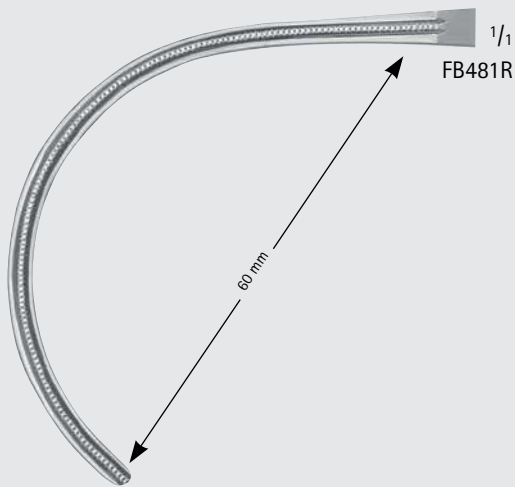

WEBER Atraumatic Aortic Clamp, Left

Catalog Number	Jaw Length (mm)	Length (in.)
FB488R	113	10 1/4

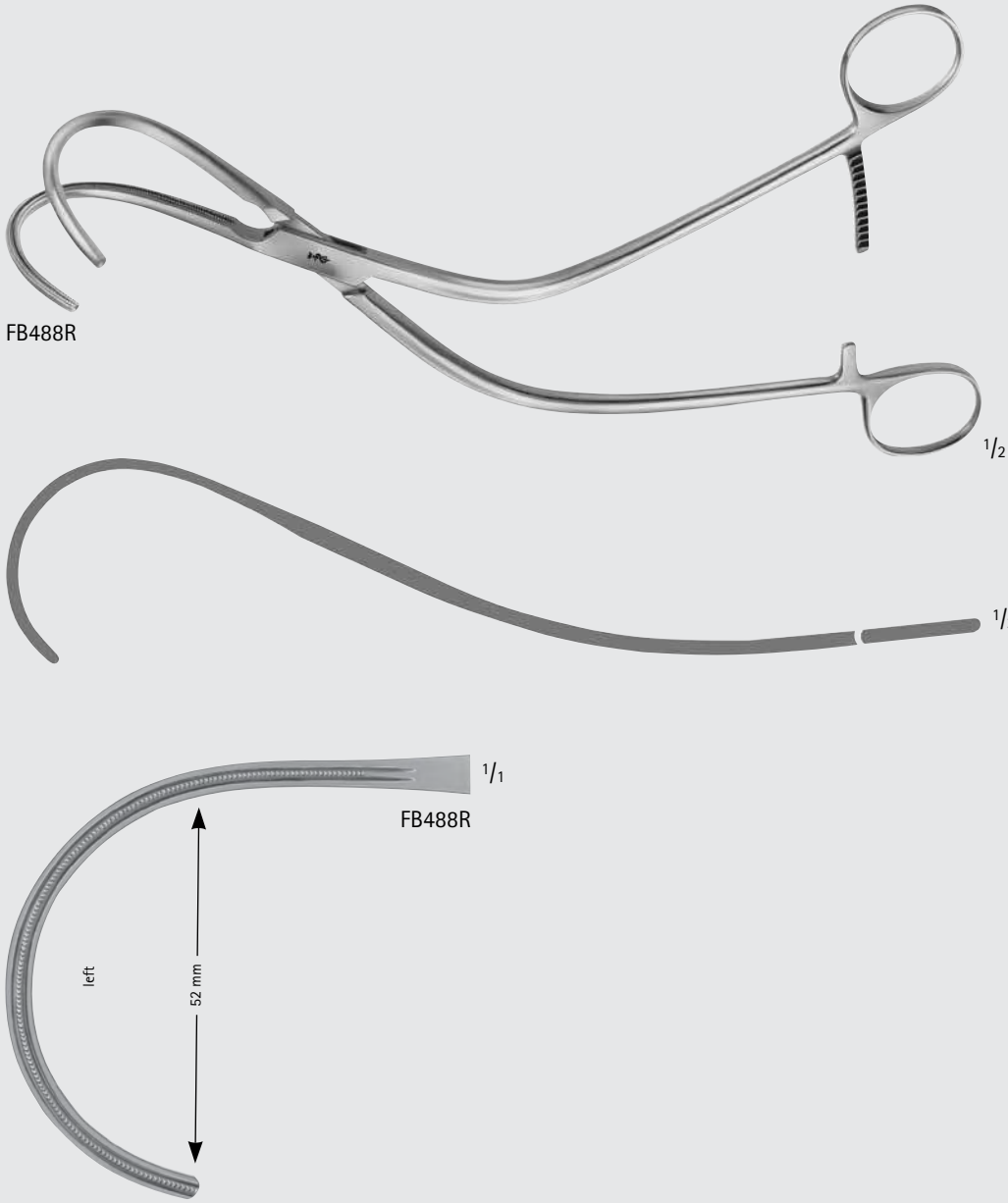

# Cardiovascular

## Vascular Clamps

WEBER Atraumatic Aortic Clamp, Right

Catalog Number	Jaw Length (mm)	Length (in.)
FB489R	113	10 1/4

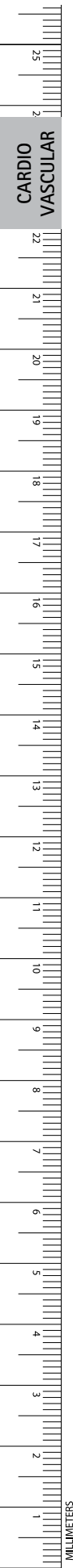
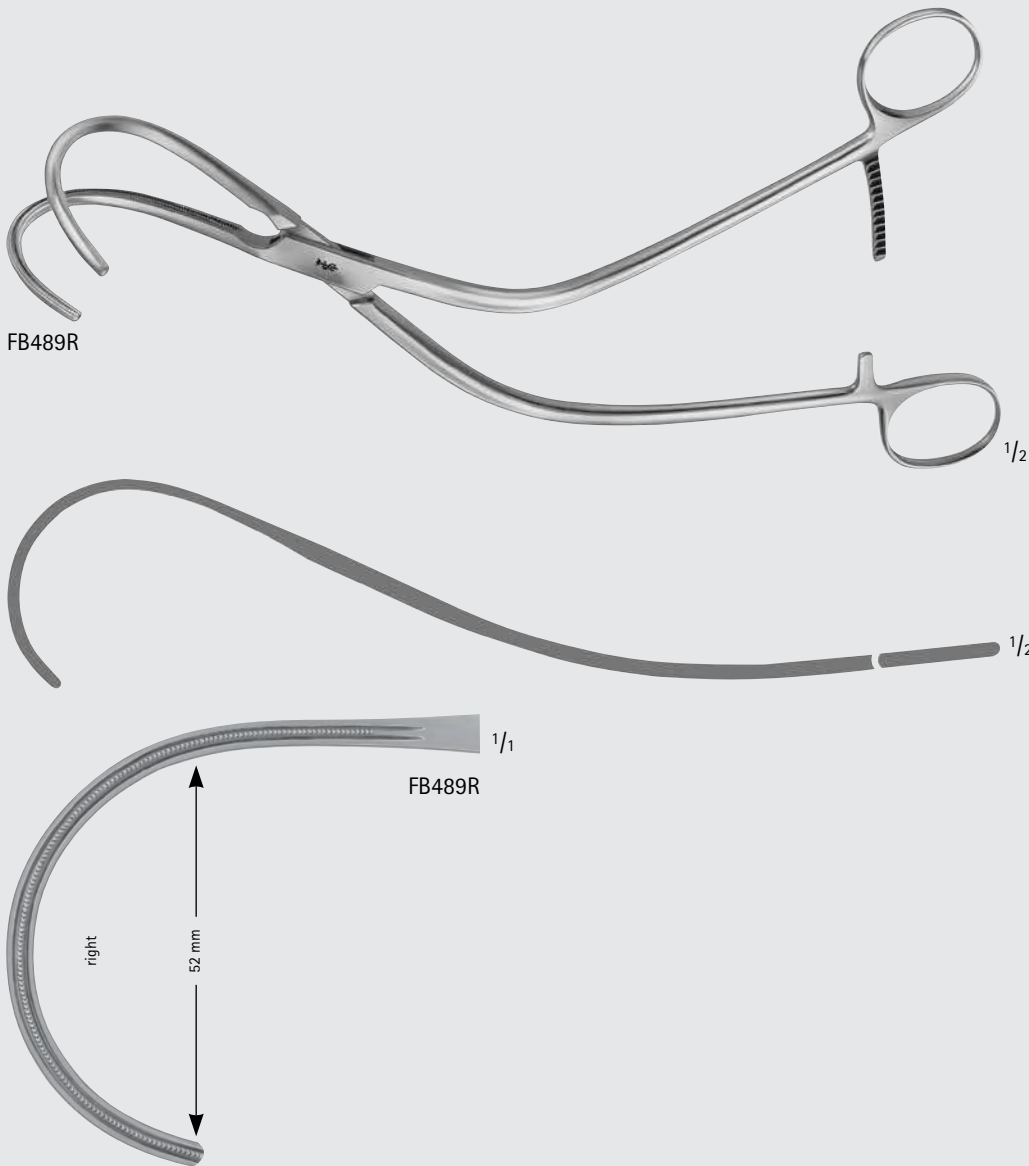

LAMBERT-KAY Atraumatic Aortic  
Clamp

Catalog Number	Weight	Jaw Length (mm)	Length (in.)
FB490R	LIGHT	93	8 1/2
FB492R	HEAVY	100	8 1/4

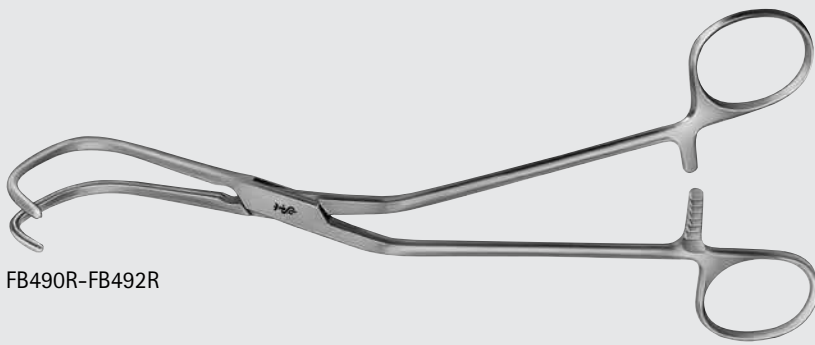

FB490R-FB492R

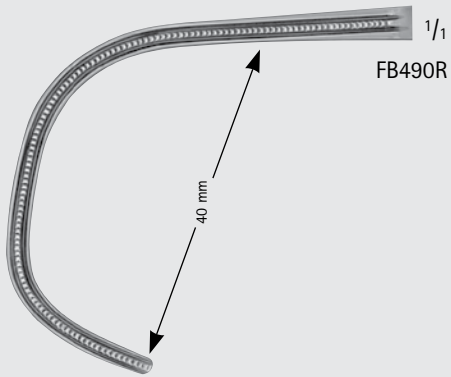

FB490R

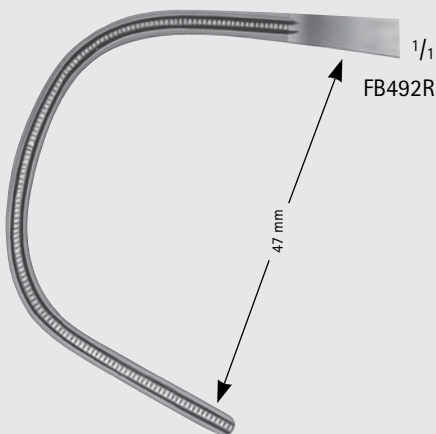

FB492R



INCHES

# Cardiovascular

## Vascular Clamps

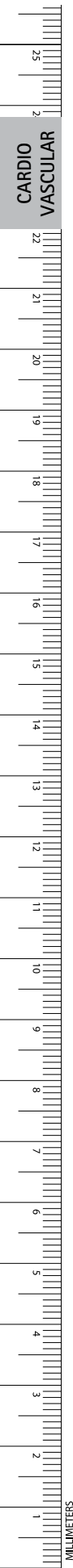

### DEBAKEY-LAMBERT Atraumatic Aortic Clamp

Catalog Number	Jaw Angle	Jaw Length (mm)	Length (in.)
FB491R	MULTI	40	10

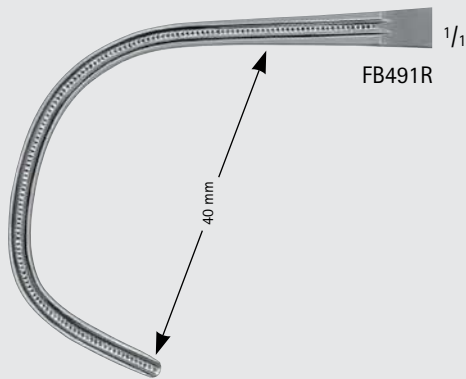

MORRIS Atraumatic Aortic Cross Clamp

Catalog Number	Jaw Angle	Jaw Length (mm)	Length (in.)
FB493R	70°	67	6 7/8

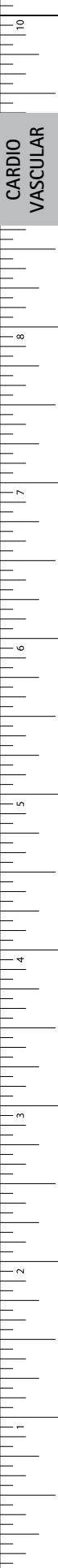
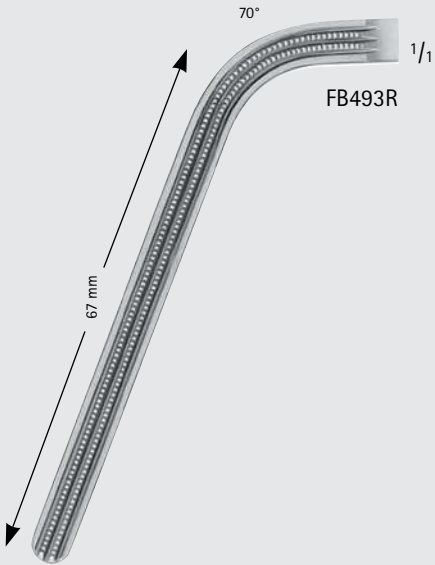
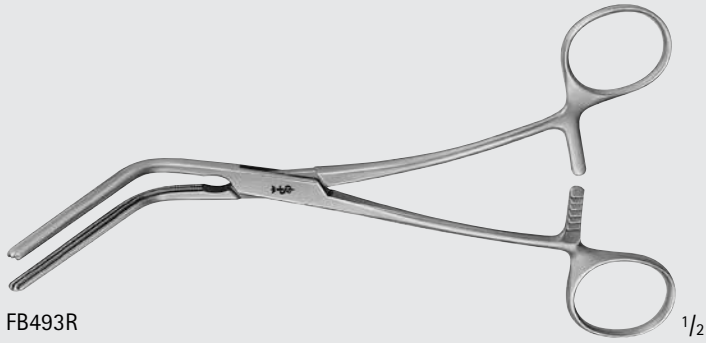

Cardiovascular  
Vascular Clamps

DEBAKEY-MORRIS Atraumatic  
Cross-Clamp

Catalog Number	Jaw Angle	Jaw Length (mm)	Length (in.)
FB494R	70°	70	9 1/2

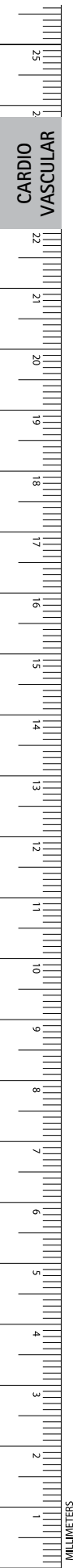
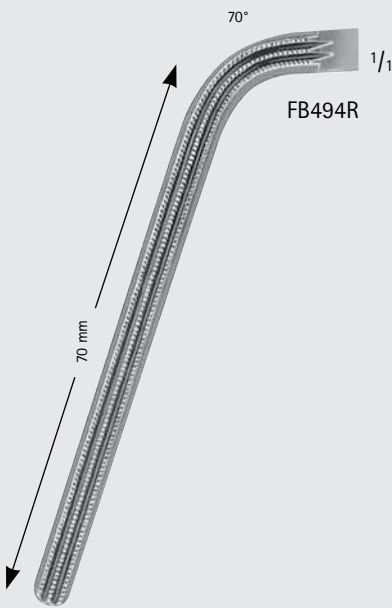
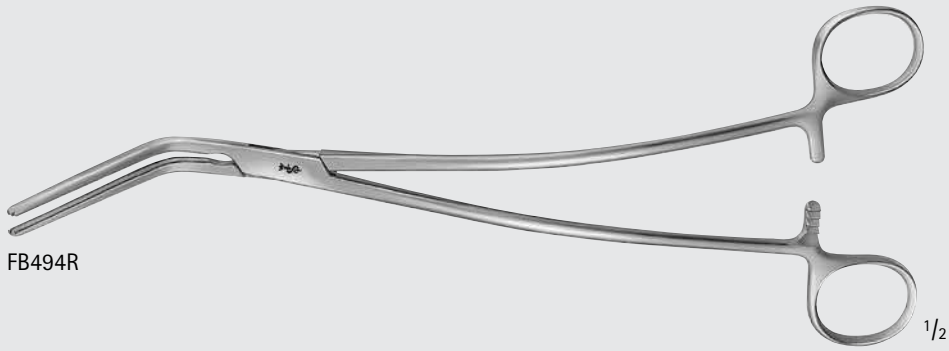



OCHSNER Atraumatic Aortic Clamp

Catalog Number	Jaw Angle	Jaw Length (mm)	Length (in.)
FB495R	70°	50	10 1/4

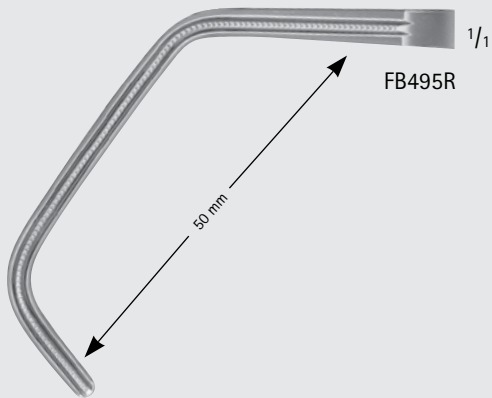
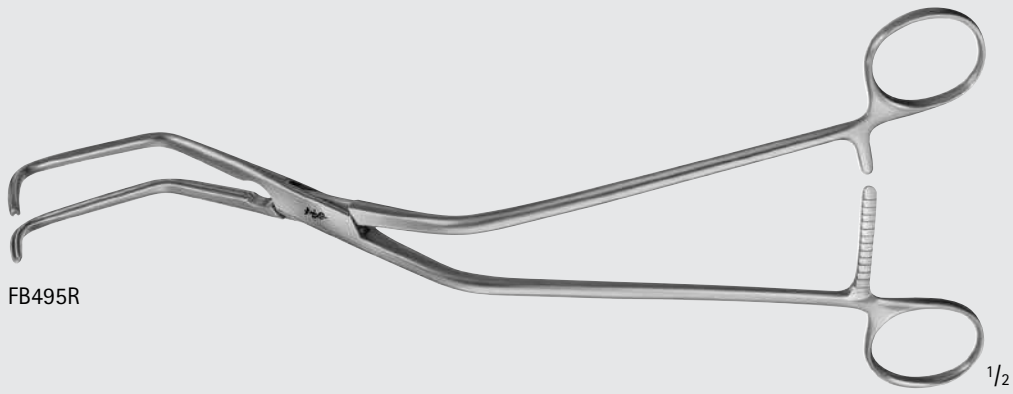

# Cardiovascular

## Vascular Clamps

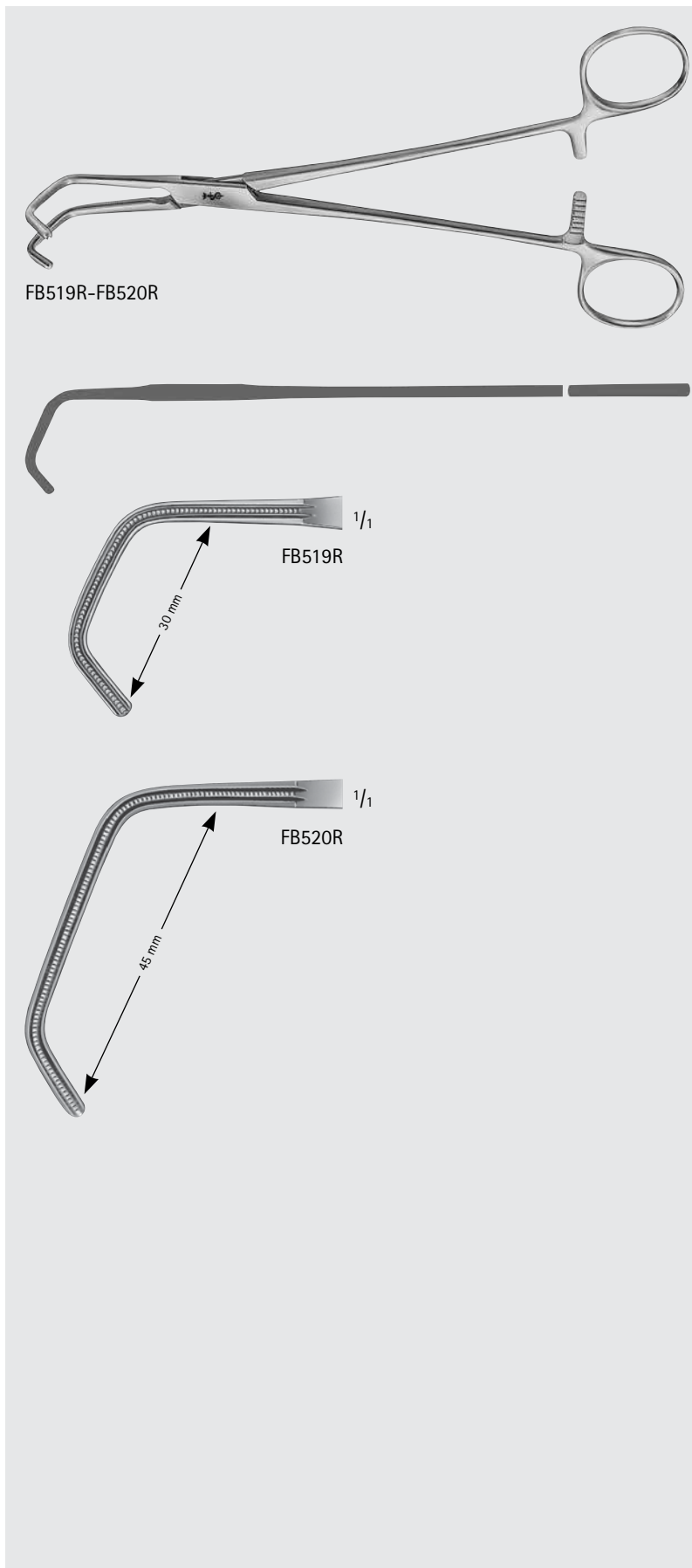
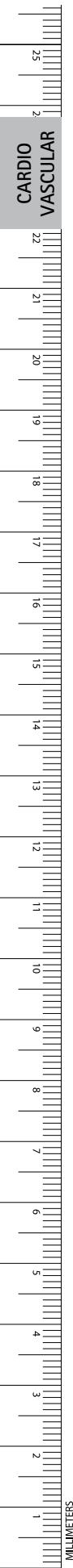

### DEBAKEY-BECK Atraumatic Vena Cava Clamp

Catalog Number	Jaw Length (mm)	Length (in.)
FB519R	30	8
FB520R	45	8 1/4

DEBAKEY Atraumatic Tangential Clamp

Catalog Number	Jaw Size (#)	Jaw Length (mm)	Length (in.)
FB500R	1	38	8 3/4
FB501R	2	48	10 1/2
FB502R	3	54	10 5/8
FB503R	4	58	10 5/8
FB504R	5	75	11

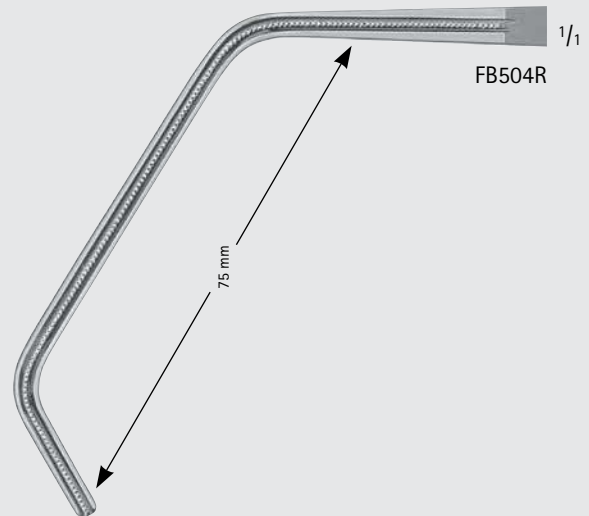
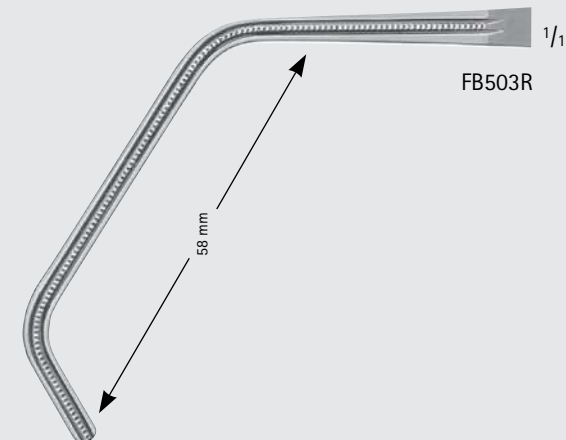
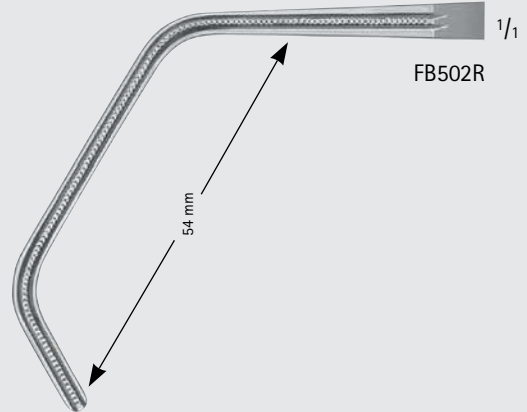
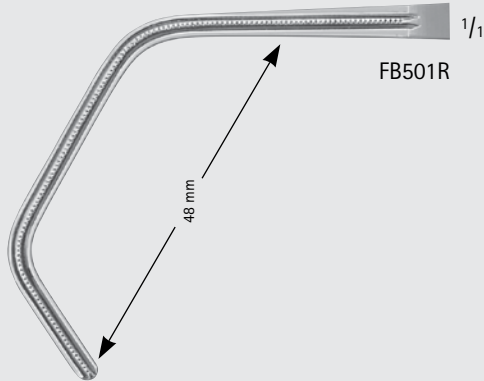
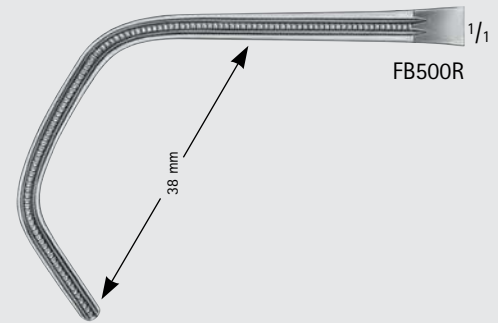
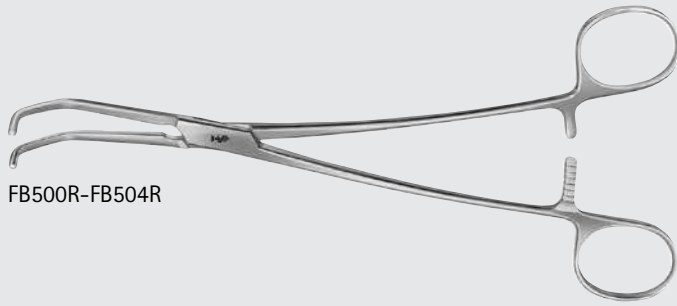

# Cardiovascular

## Vascular Clamps

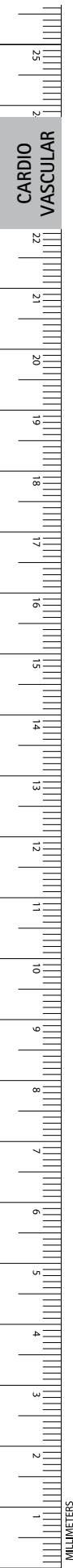

### DEBAKEY-SATINSKY Atraumatic Tangential Clamp

Catalog Number	Jaw Length (mm)	Length (in.)
FB506R	32	9 1/4
FB507R	40	9 1/2
FB508R	47	9 5/8

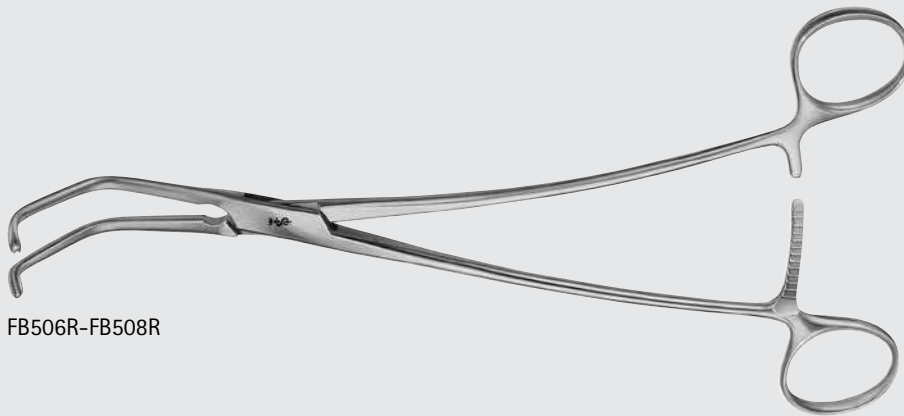

FB506R-FB508R

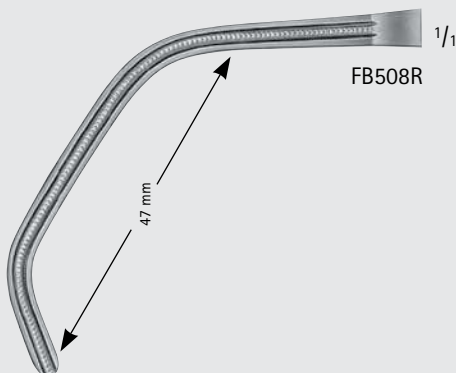
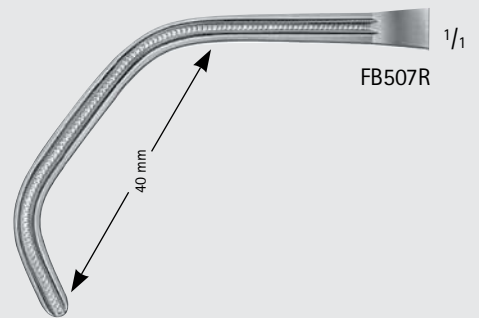
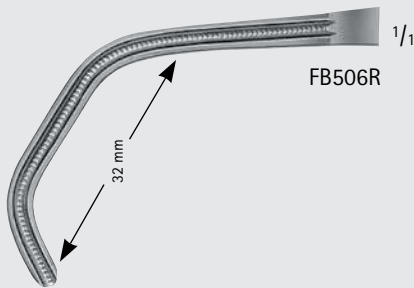

DEBAKEY Atraumatic Sidewinder  
Aortic Clamp

Catalog Number	Jaw Angle	Jaw Length (mm)	Length (in.)
FB576R	70°	60	10 1/2

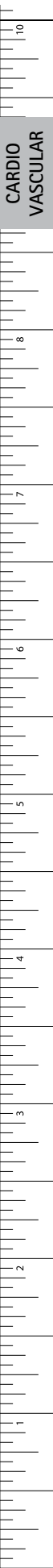
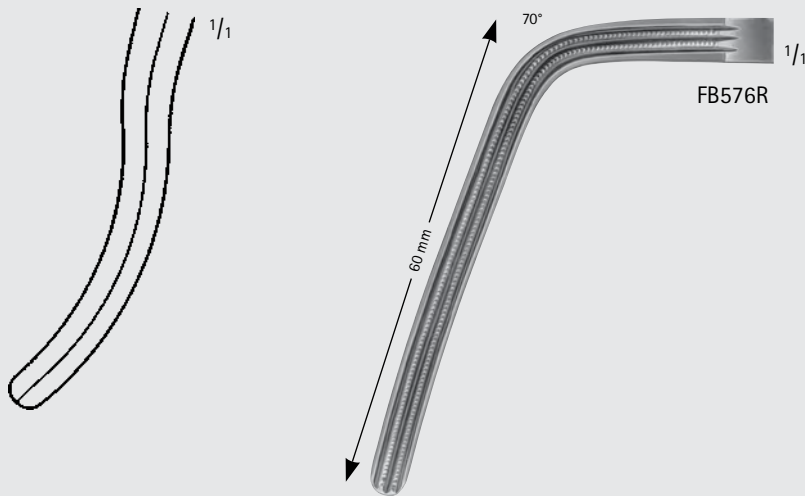
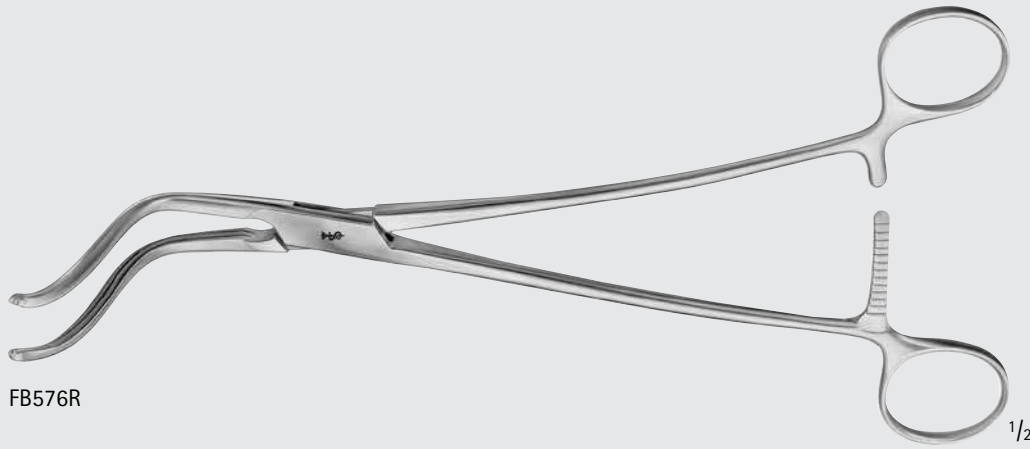

Cardiovascular  
Vascular Clamps

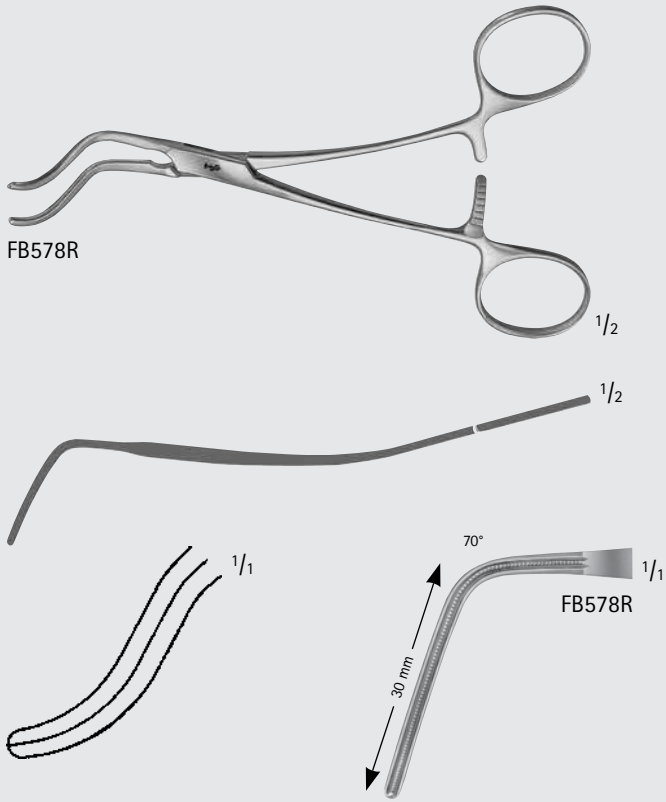
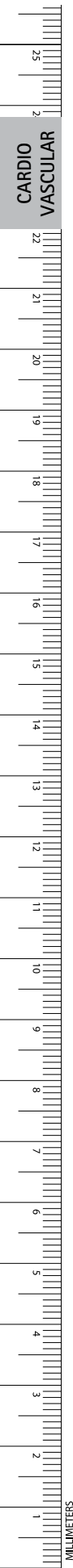

DEBAKEY-SUBRAMANIAN Atraumatic Aortic Clamp

Catalog Number	Jaw Angle	Jaw Length (mm)	Length (in.)
FB578R	70°	30	6 1/8

DEBAKEY Vascular Clamp

Catalog Number	Jaw Angle	Jaw Length (mm)	Length (in.)
US123	60°	40	4 1/4
US124	90°	40	3 3/4

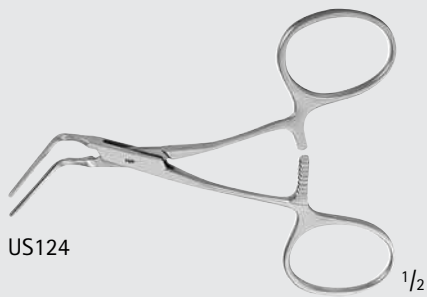
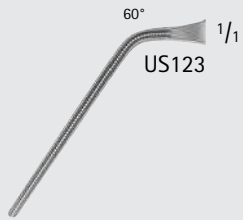
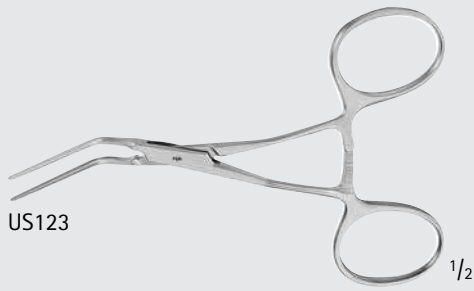

DEBAKEY Partial Occlusion Clamp

Catalog Number	Jaw Angle	Jaw Length (mm)	Length (in.)
US125	MULTI	24	4 1/2

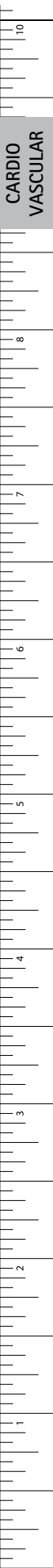
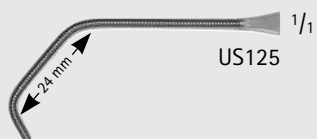
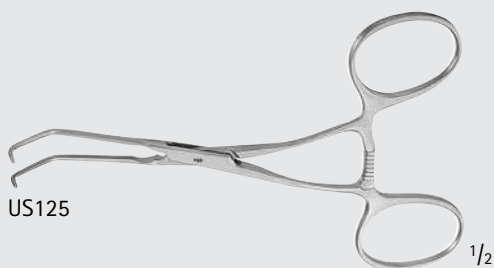

# Cardiovascular

## Vascular Clamps

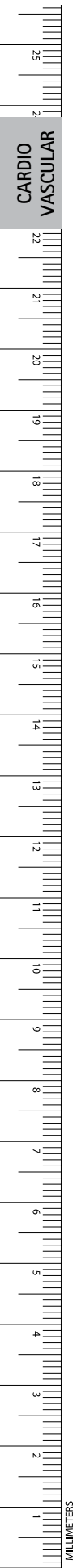

**COOLEY Atraumatic Ring Handle Bulldog Clamp**

Catalog Number	Shaft Angle	Jaw Angle	Jaw Length (mm)	Length (in.)
FB700R	STR	STR	50	5
FB702R	STR	CVD	50	4 1/2
FB701R	15° ANG	STR	50	5
FB703R	SLIGHT-CVD	CVD	50	5
FB704R	SLIGHT-CVD	40°	37	4 3/4
FB706R	SLIGHT-CVD	MULTI	52	5
FB705R	CVD	MULTI	50	4 3/4
FB708R	CVD	MULTI	12	4 1/4
FB707R	ANG	90°	41	4

Diagram labels and dimensions:

- FB700R: 1/1
- FB702R: 1/1
- FB701R: 1/1
- FB703R: 1/1
- FB704R: 40°, 37 mm
- FB706R: 1/1
- FB705R: 1/1
- FB708R: 1/1, 12 mm
- FB707R: 90°, 41 mm



**COOLEY-BECK Atraumatic Pediatric Clamp, Curved**

Catalog Number	Jaw Length (mm)	Length (in.)
FB731R	25	6
FB732R	30	6 1/8

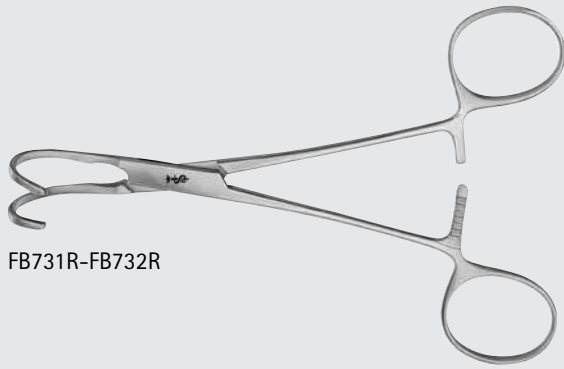

FB731R-FB732R

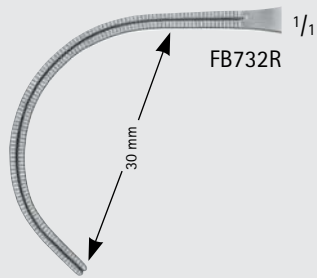
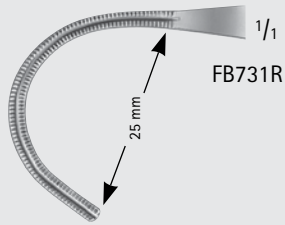

**COOLEY Atraumatic Peripheral Vascular Clamp, Angled**

Catalog Number	Jaw Length (mm)	Length (in.)
MB233	65	7

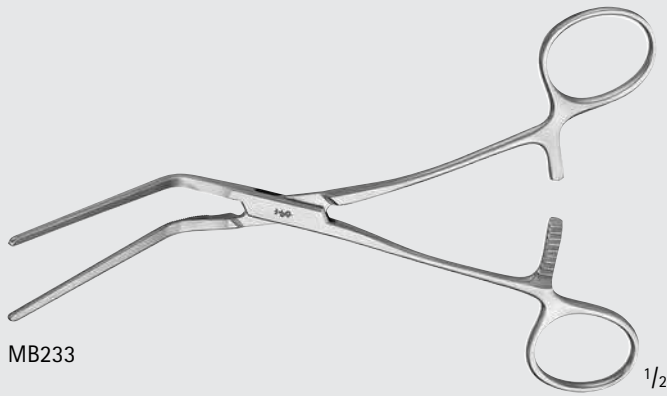

MB233

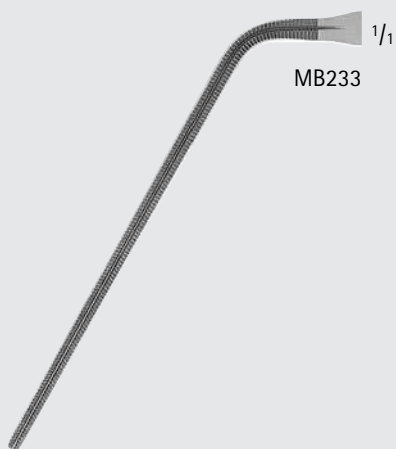

# Cardiovascular

## Vascular Clamps

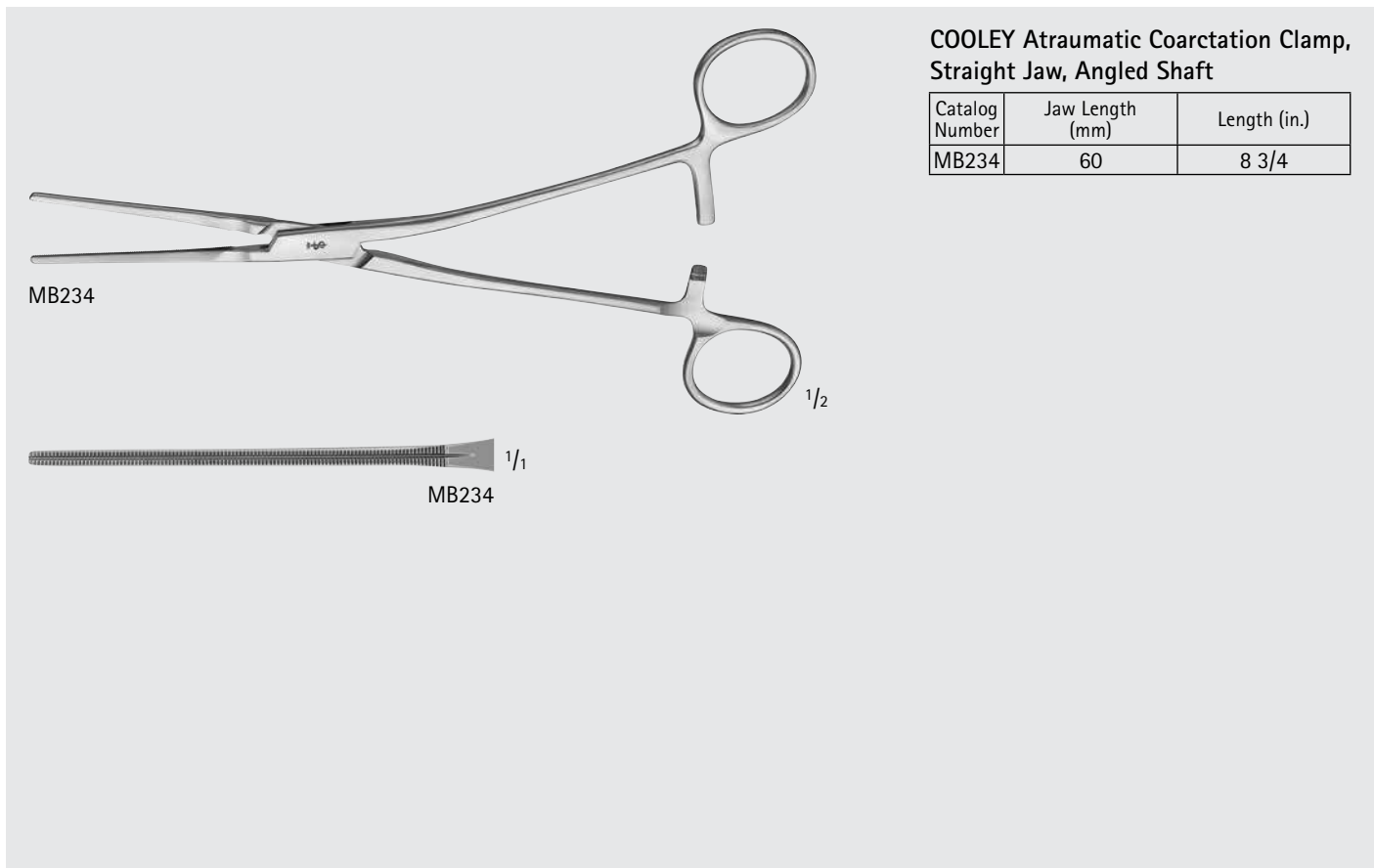
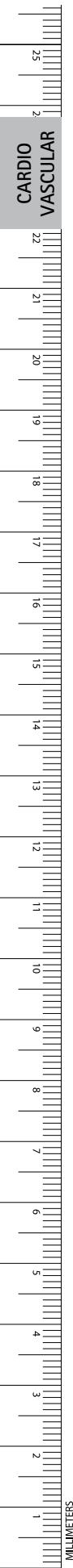

**COOLEY Atraumatic Coarctation Clamp, Straight Jaw, Angled Shaft**

Catalog Number	Jaw Length (mm)	Length (in.)
MB234	60	8 3/4

MB234

1/2

1/1

MB234

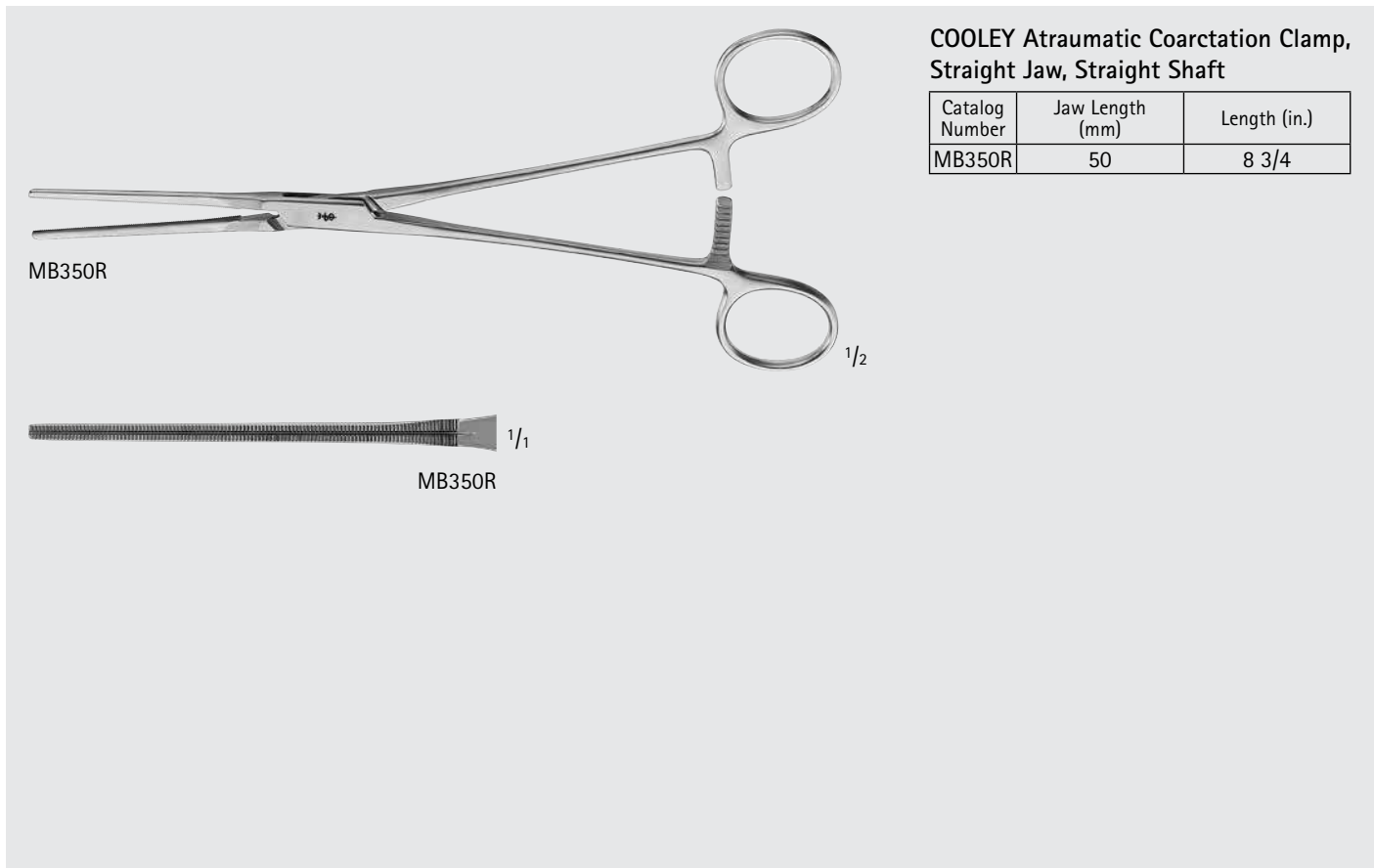

**COOLEY Atraumatic Coarctation Clamp, Straight Jaw, Straight Shaft**

Catalog Number	Jaw Length (mm)	Length (in.)
MB350R	50	8 3/4

MB350R

1/2

1/1

MB350R



**DERRA-COOLEY Atraumatic Clamp**

Catalog Number	Jaw Length (mm)	Length (in.)
FB725R	16	6 3/4
FB726R	21	6 7/8
FB727R	27	6 7/8

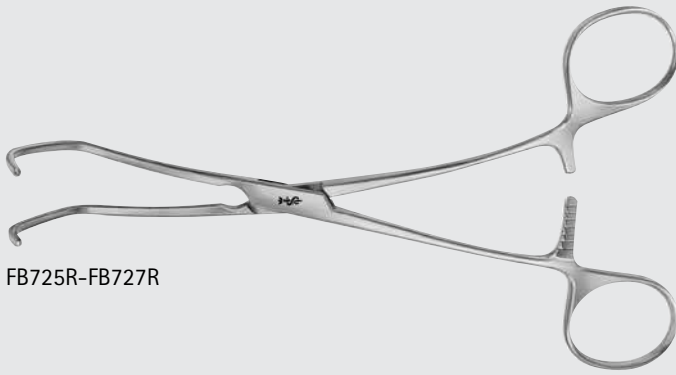

FB725R-FB727R

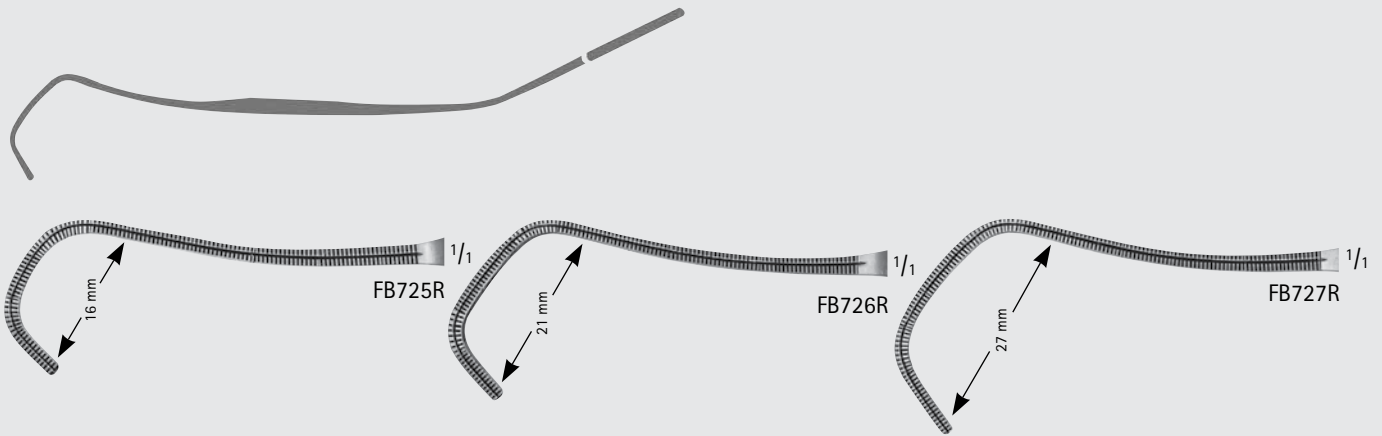

**COOLEY Atraumatic Clamp, Spoon Shaped**

Catalog Number	Jaw Length (mm)	Length (in.)
FB743R	42	5 3/4

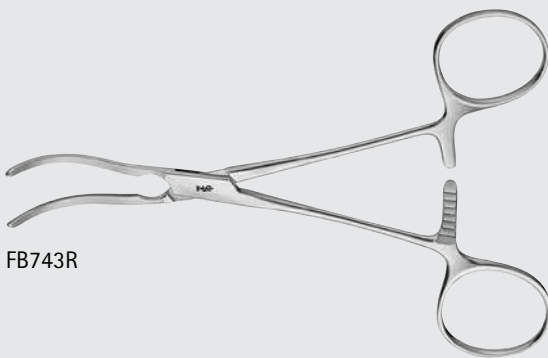

FB743R



**COOLEY-SATINSKY Atraumatic Pediatric Clamp**

Catalog Number	Jaw Length (mm)	Length (in.)
MB613R	21	5 1/2

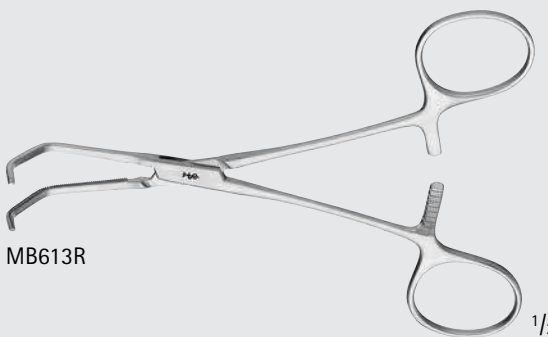

MB613R

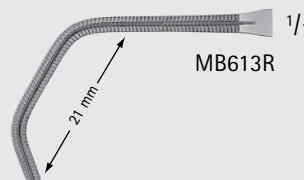

MB613R

# Cardiovascular

## Vascular Clamps

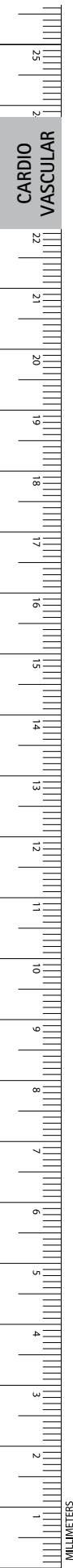
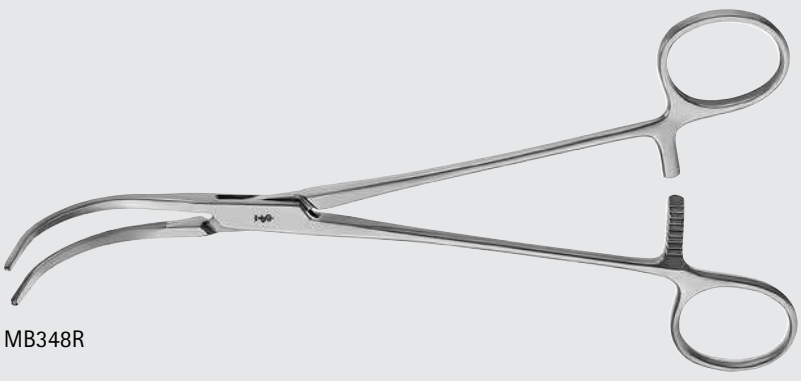

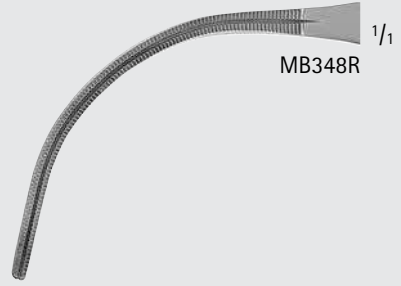

**COOLEY Atraumatic Cardiovascular Clamp, Curved**

Catalog Number	Jaw Length (mm)	Length (in.)
MB348R	55	8 1/4

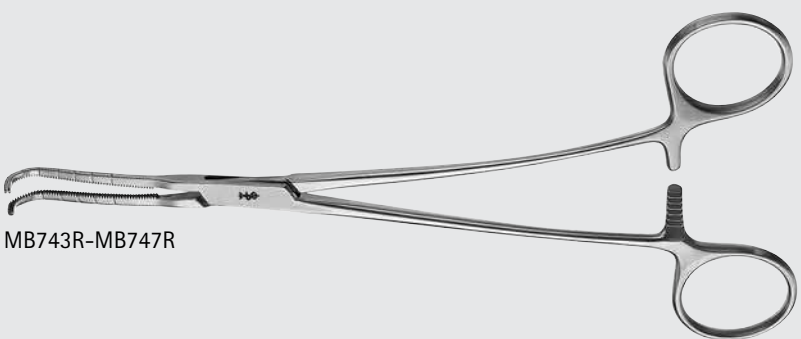

MB348R



**HENDREN Atraumatic Cardiovascular Clamp**

Catalog Number	Jaw Length (mm)	Length (in.)
MB743R	13	8 1/4
MB744R	30	8 1/2
MB745R	35	8 1/2
MB746R	40	8 3/4
MB747R	45	8 3/4

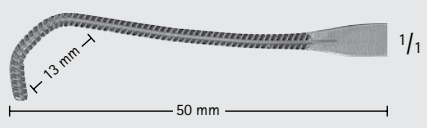
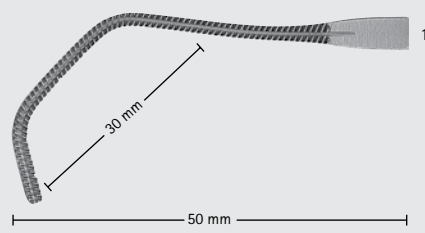
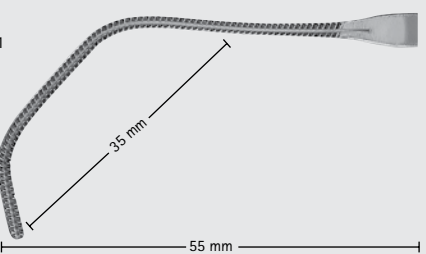
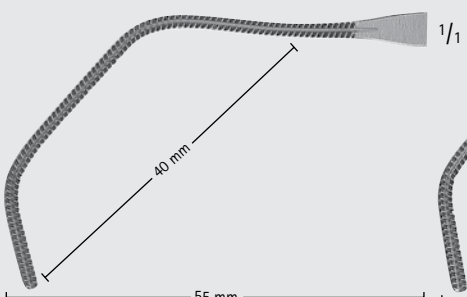
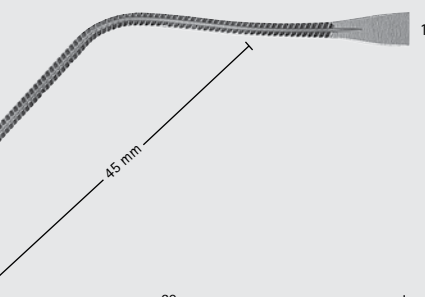
MB743R-MB747R

MB743R

MB744R

MB745R

MB746R

MB747R

**COOLEY Atraumatic Pediatric Anastomosis Clamp, Curved**

Catalog Number	Jaw Length (mm)	Length (in.)
FB734R	36	6 3/4
FB735R	44	6 3/4

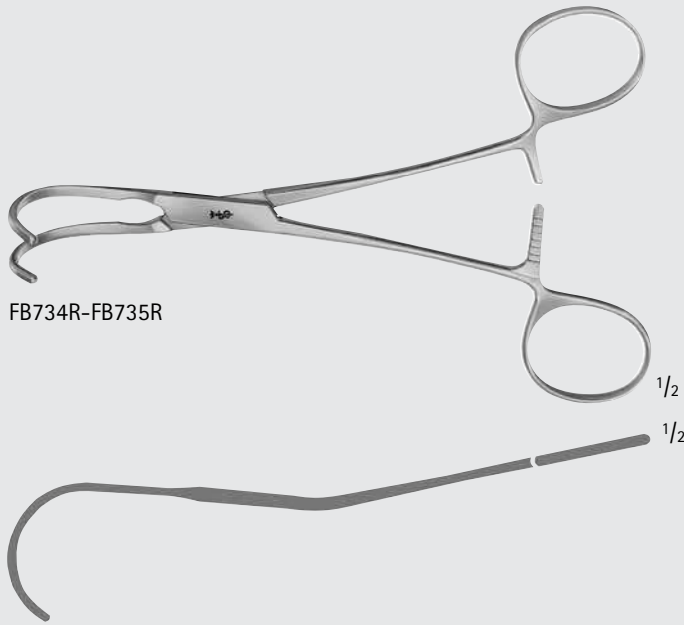

FB734R-FB735R

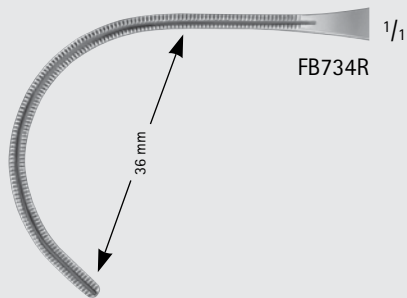

FB734R

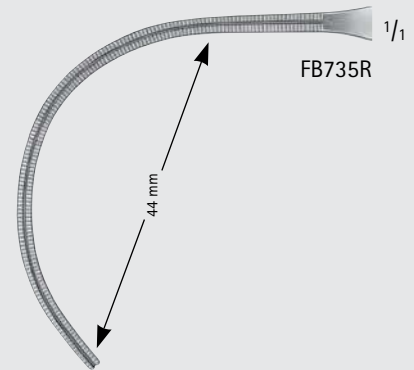

FB735R

**POTTS Anastomosis Clamp**

Catalog Number	Jaw Angle	Jaw Length (mm)	Length (in.)
MB547R	90°	40	7 1/4

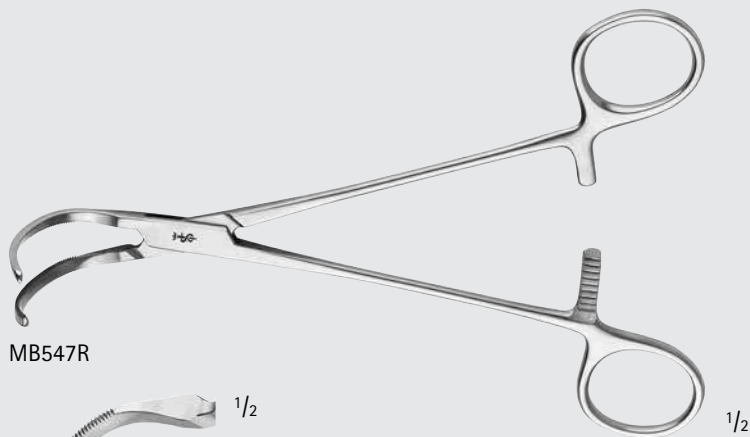

MB547R

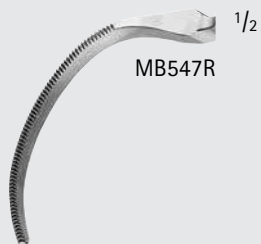

MB547R



# Cardiovascular

## Vascular Clamps



CARDIO  
VASCULAR

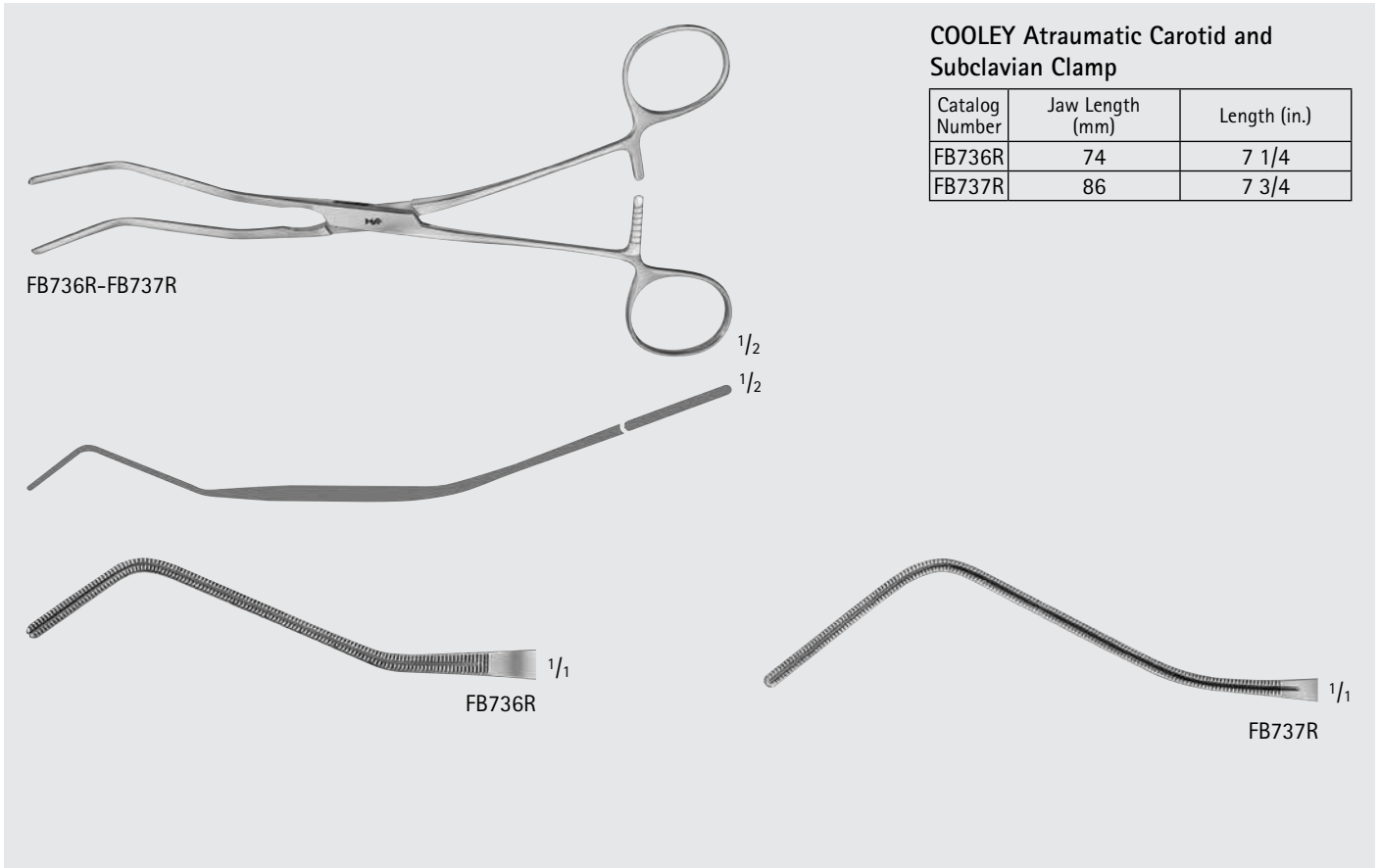

### COOLEY Atraumatic Carotid and Subclavian Clamp

Catalog Number	Jaw Length (mm)	Length (in.)
FB736R	74	7 1/4
FB737R	86	7 3/4

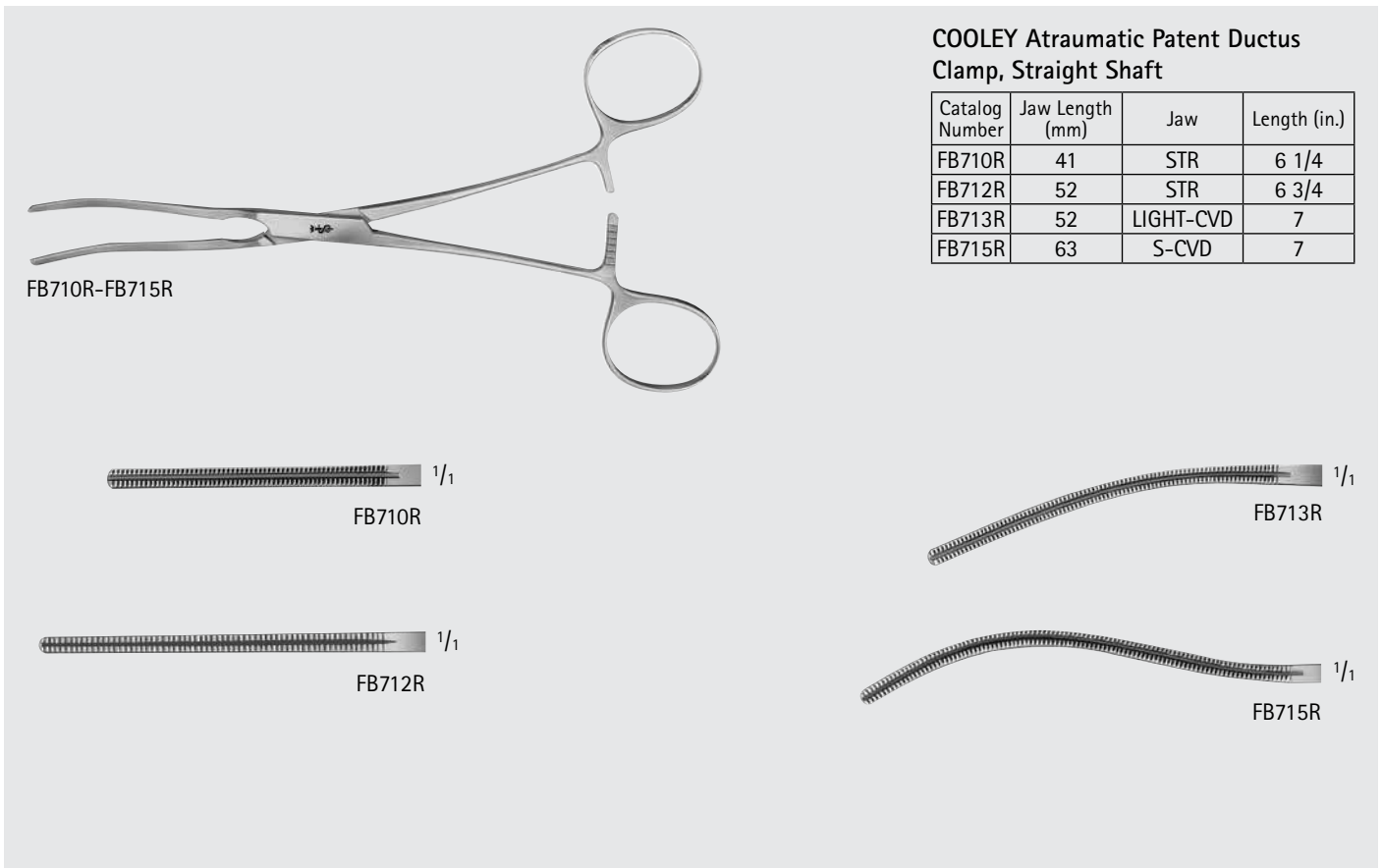

### COOLEY Atraumatic Patent Ductus Clamp, Straight Shaft

Catalog Number	Jaw Length (mm)	Jaw	Length (in.)
FB710R	41	STR	6 1/4
FB712R	52	STR	6 3/4
FB713R	52	LIGHT-CVD	7
FB715R	63	S-CVD	7

COOLEY Atraumatic Patent Ductus  
Clamp, Angled Shaft

Catalog Number	Jaw Angle	Jaw Length (mm)	Length (in.)
FB711R	STR	41	6 1/4
FB714R	STR	52	6 3/4
FB754R	60°	57	6 1/2
FB755R	60°	67	6 3/4
FB756R	60°	82	7 1/4

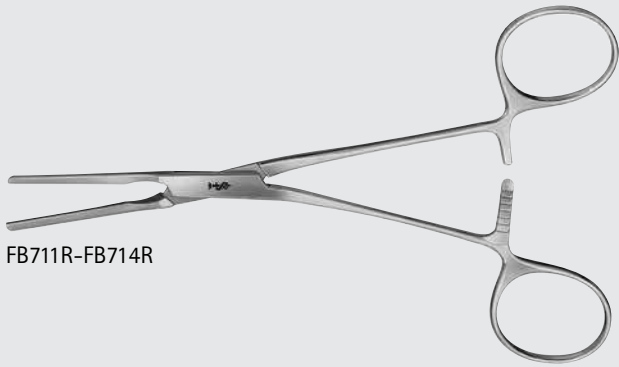

FB711R-FB714R



FB711R



FB714R



FB754R-FB756R

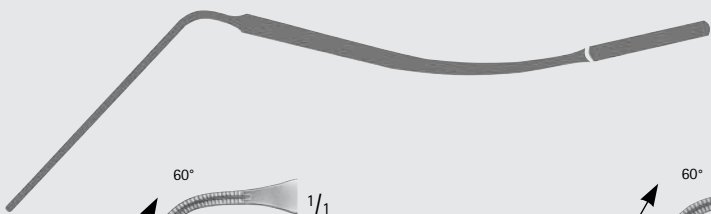

FB754R

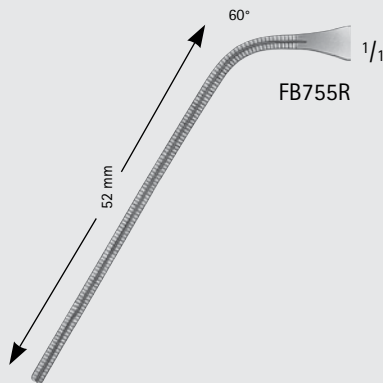

FB755R

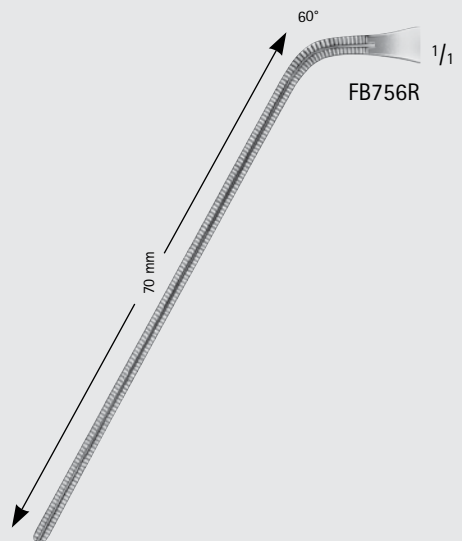

FB756R

# Cardiovascular

## Vascular Clamps

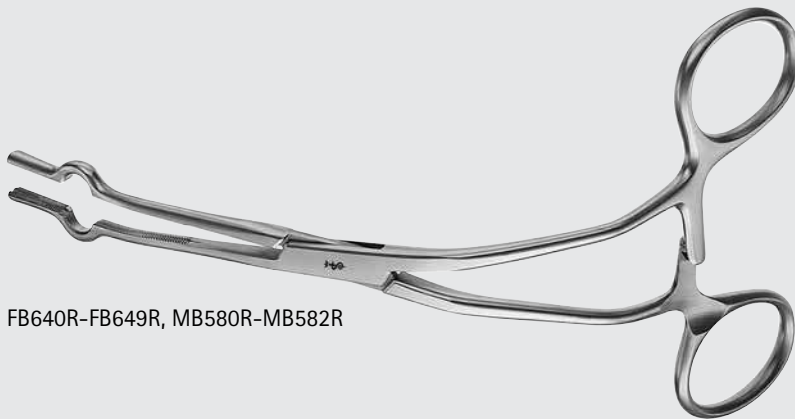
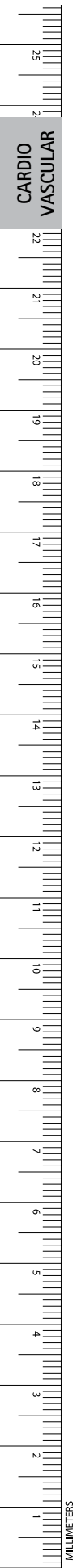

FB640R-FB649R, MB580R-MB582R

### COOLEY Cava Occlusion Clamp

Catalog Number	Jaw Size (FR)	Length (in.)
FB640R	20	6 1/4
FB641R	24	6 1/4
FB642R	26	7 1/2
MB580R	28	7 1/2
FB644R	30	7 1/2
MB581R	32	7 1/2
MB582R	34	7 1/2
FB647R	36	7 1/2
FB649R	40	7 1/2



FB640R



FB642R



FB644R



MB582R



FB649R



FB641R



MB580R



MB581R



FB647R



COOLEY Atraumatic Pediatric  
Anastomosis Clamp, Angled Shaft

Catalog Number	Jaw Length (mm)	Length (in.)
FB729R	17	6 3/4
FB721R	25	6 1/2
FB722R	28	6 1/2
FB723R	33	6 7/8
FB724R	36	7

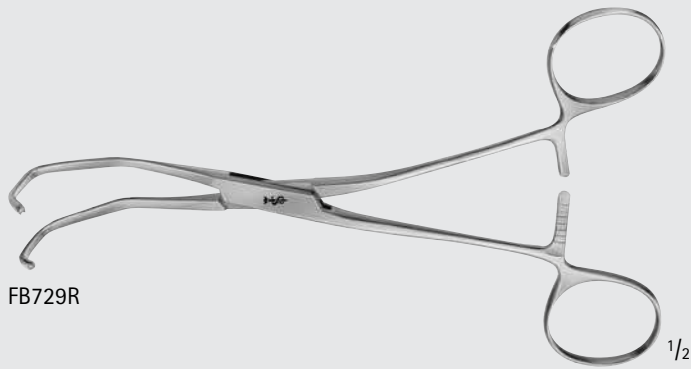

FB729R

1/2



1/2



FB729R

1/1

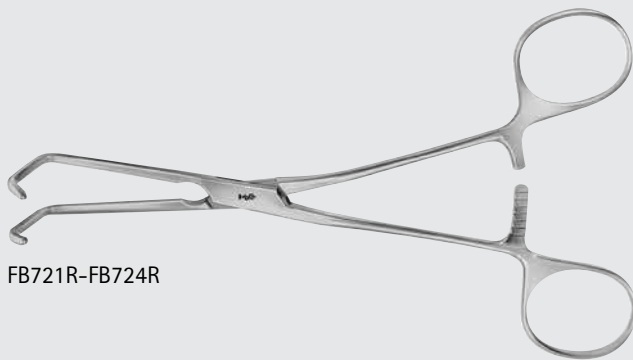

FB721R-FB724R

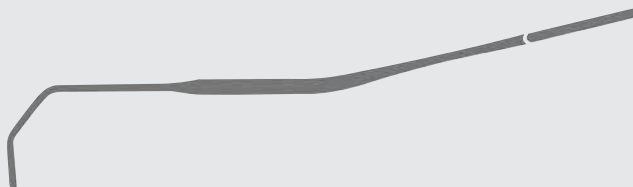

FB721R

1/1

25 mm

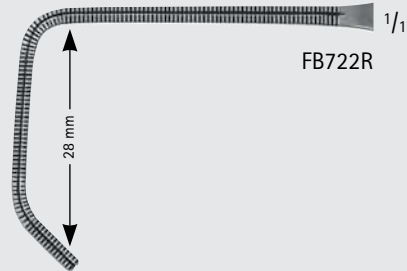

FB722R

1/1

28 mm

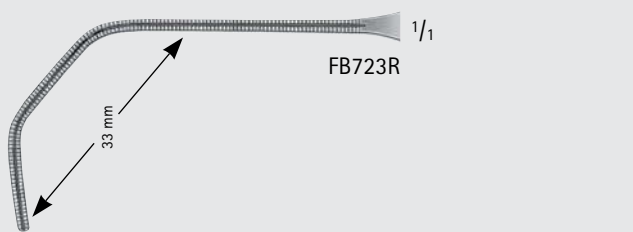

FB723R

1/1

33 mm

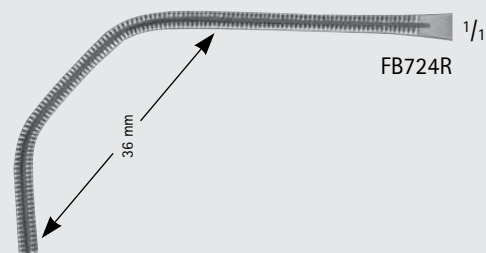

FB724R

1/1

36 mm

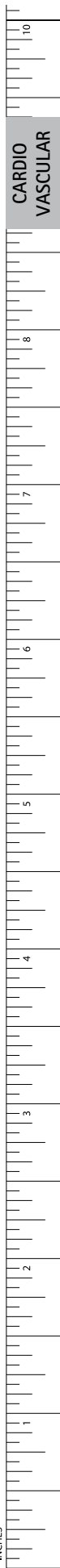

INCHES

# Cardiovascular

## Vascular Clamps



CARDIO  
VASCULAR

**COOLEY Atraumatic Pediatric Multi-Purpose Clamp, Angled Shaft**

Catalog Number	Jaw Angle	Jaw Length (mm)	Length (in.)
FB717R	30°	35	6 1/2
FB718R	60°	35	6 1/4
FB719R	90°	37	6

FB717R-FB719R

**COOLEY Atraumatic Pediatric Anastomosis Clamp, Angled Shaft**

Catalog Number	Jaw Length (mm)	Length (in.)
FB730R	20	6 7/8

FB730R

COOLEY Atraumatic Renal Artery  
Clamp, Angled Shaft

Catalog Number	Jaw Length (mm)	Length (in.)
FB738R	108	10 1/4

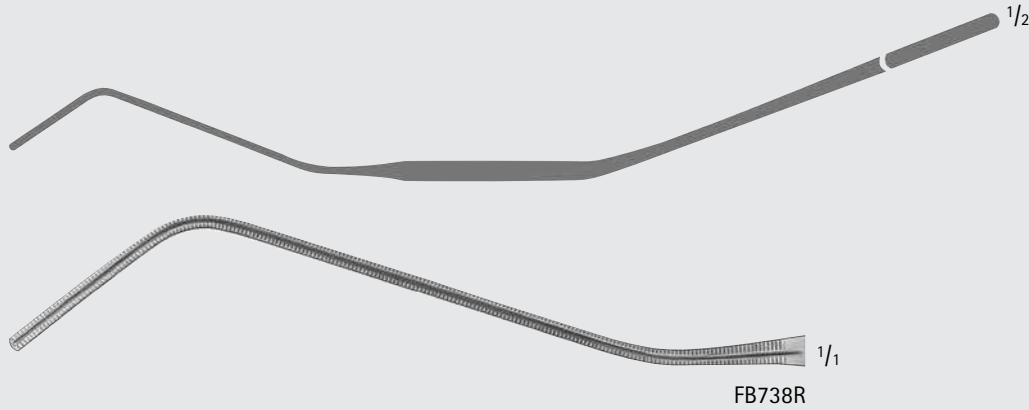
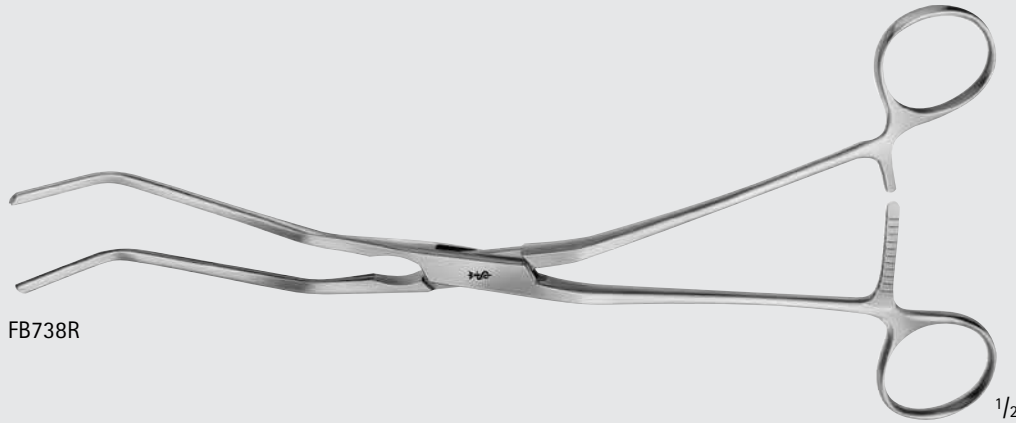

Cardiovascular  
Vascular Clamps

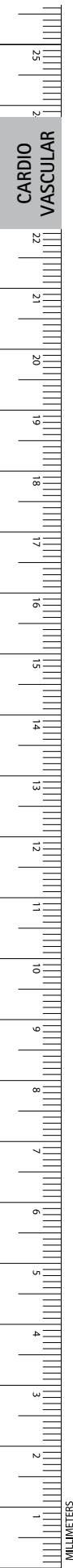

COOLEY Atraumatic Aorta Clamp,  
Angled Shaft

Catalog Number	Jaw Length (mm)	Length (in.)
MB349R	73	10

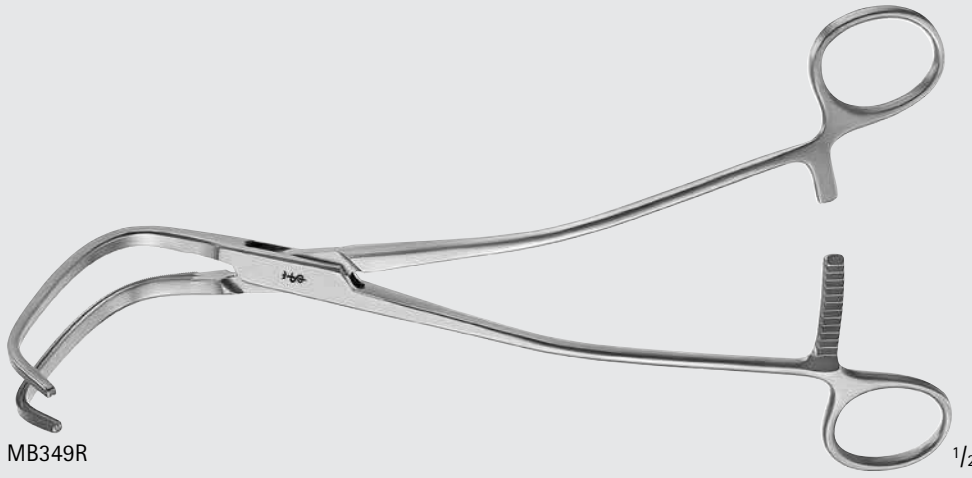

MB349R

1/2

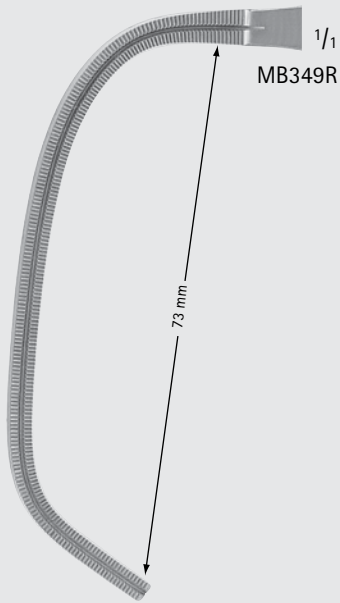

MB349R

73 mm

1/1

COOLEY Tangential Clamp, Calibrated

Catalog Number	Jaw (mm)	Length (in.)
MG456R	20 x 7	7 3/4
MG457R	25 x 8	7 7/8
MG458R	38 x 10	7 7/8

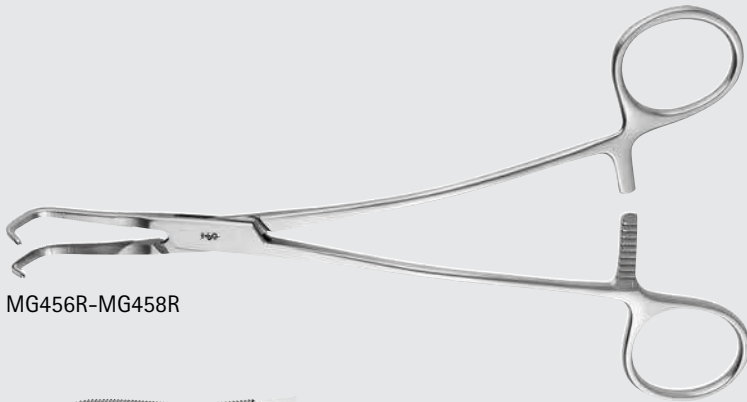

MG456R-MG458R



MG456R



MG457R



MG458R

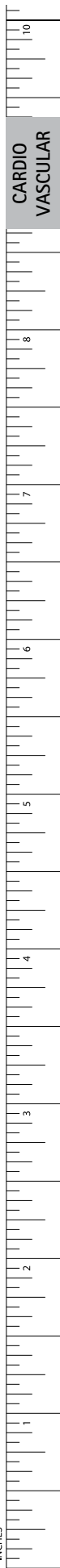

Cardiovascular  
Vascular Clamps

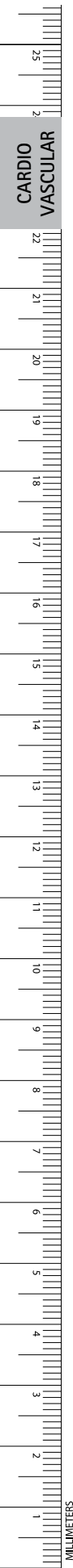

COOLEY Atraumatic Forceps, S-Shaped

Catalog Number	Jaw Length (mm)	Length (in.)
FB764R	115	12 1/2

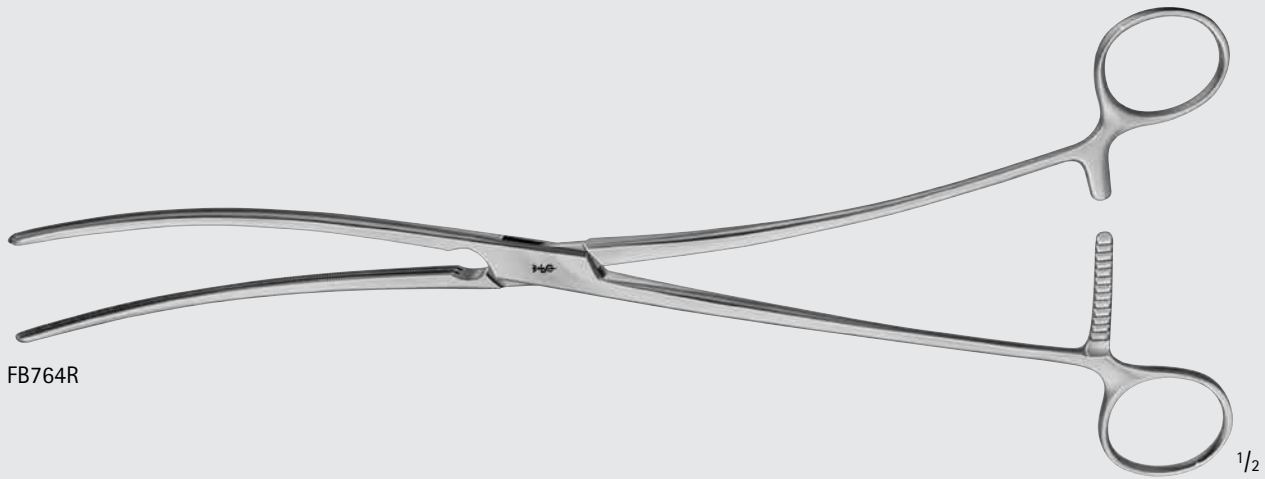

FB764R

1/2



1/2

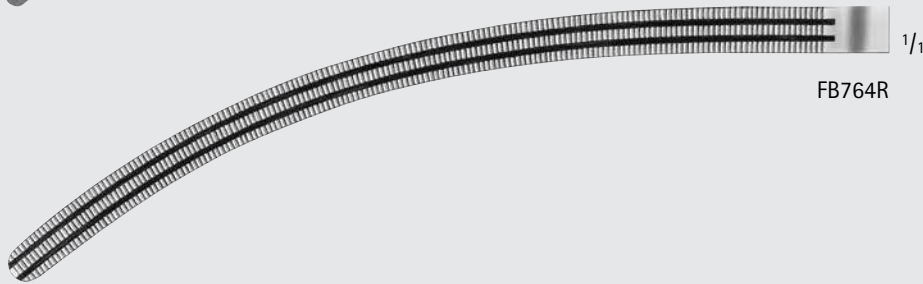

1/1

FB764R

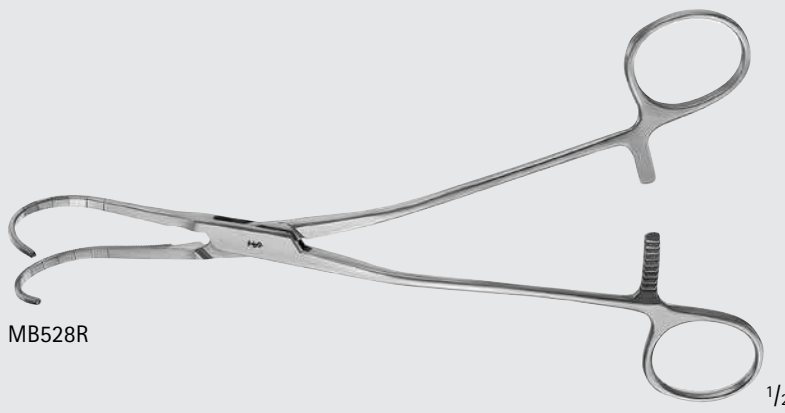

MB528R

1/2

COOLEY Atraumatic Multi-Purpose Clamp, Curved, Angled Shaft, Calibrated

Catalog Number	Jaw Length (mm)	Length (in.)
MB528R	32	8

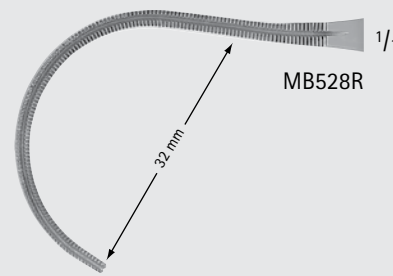

1/1

MB528R

32 mm

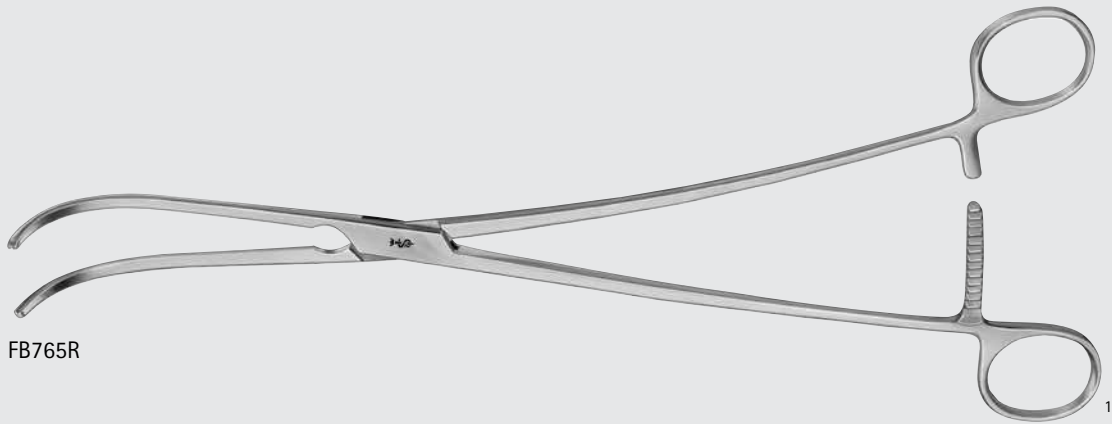

FB765R

1/2

COOLEY Atraumatic Forceps, Curved, Angled Shaft

Catalog Number	Jaw Length (mm)	Length (in.)
FB765R	82	11 1/4

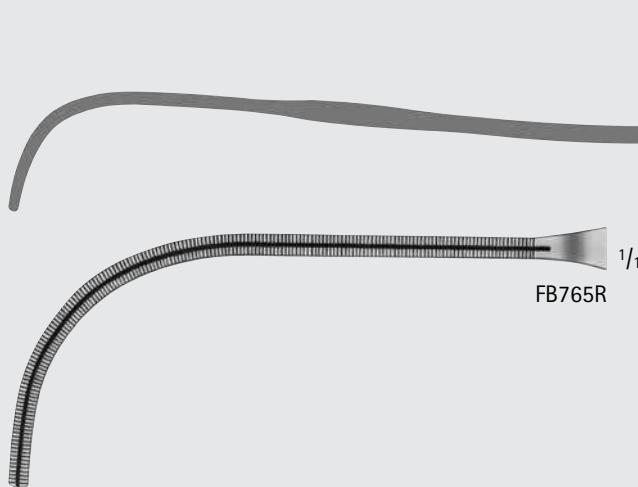

1/1

FB765R

1/2



# Cardiovascular

## Vascular Clamps

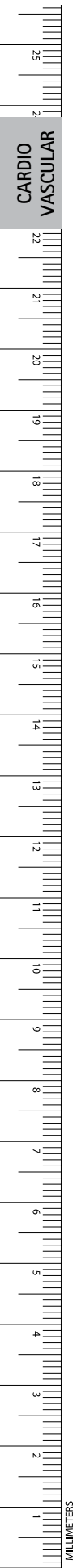

### PARRY-COOLEY Atraumatic Forceps

Catalog Number	Jaw Length (mm)	Length (in.)
FB775R	70	11 5/8

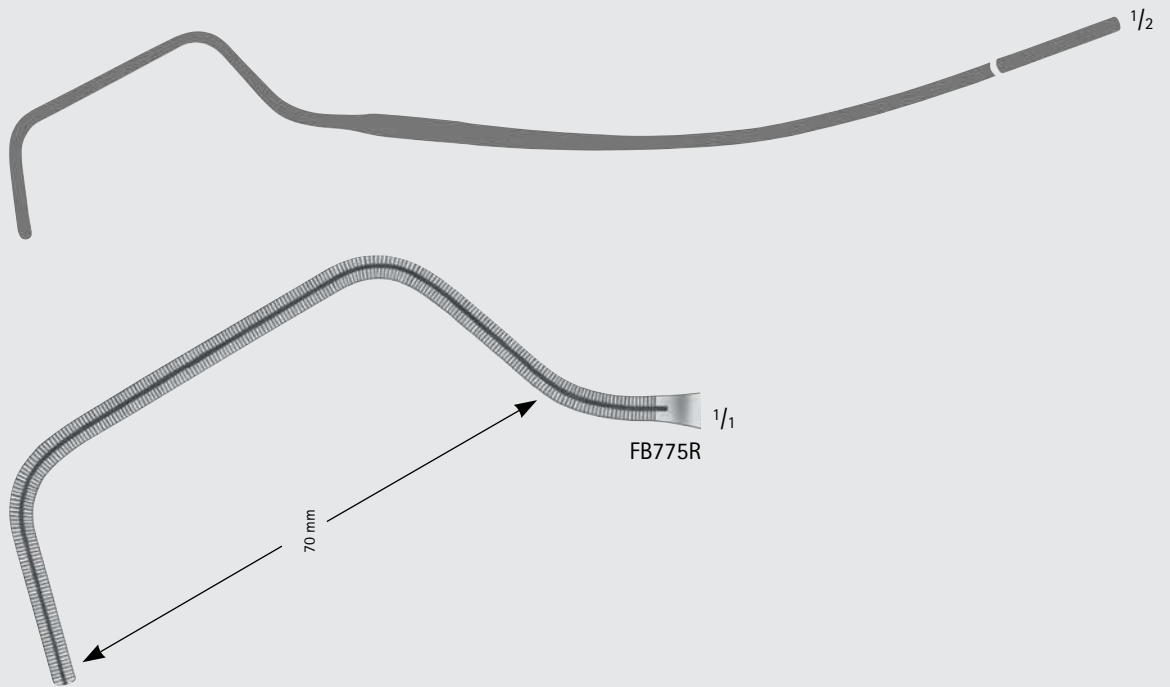
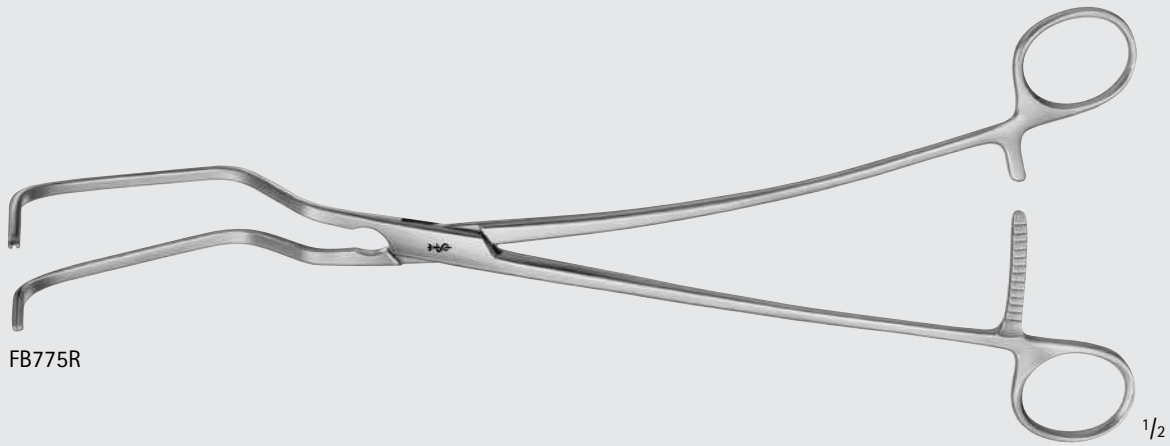



COOLEY Auricular Appendage Clamp

Catalog Number	Jaw	Length (in.)
MG451R	40 x 10	10

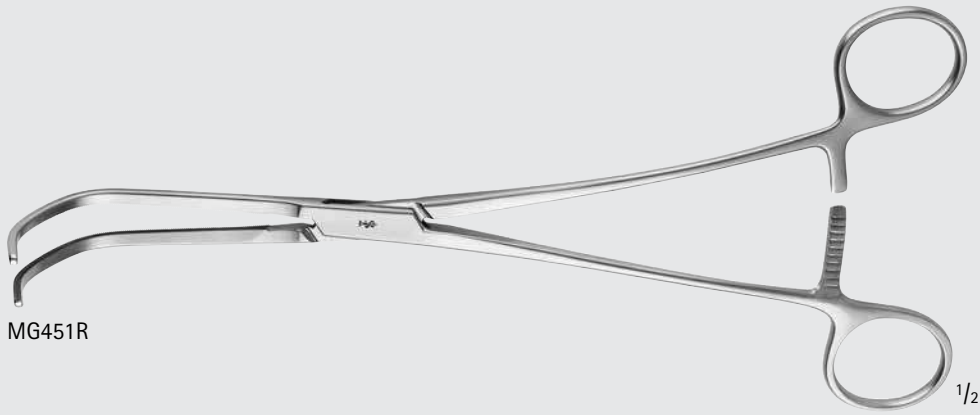

MG451R

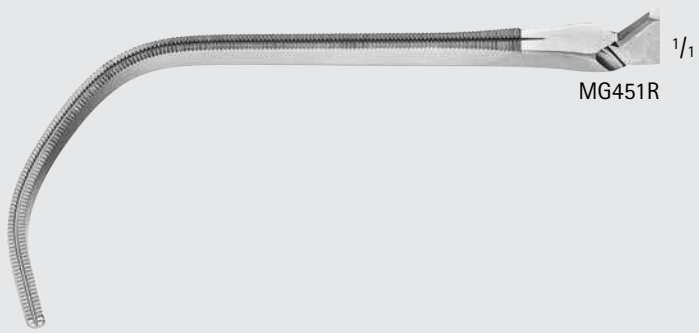

MG451R



INCHES

# Cardiovascular

## Vascular Clamps



CARDIO  
VASCULAR

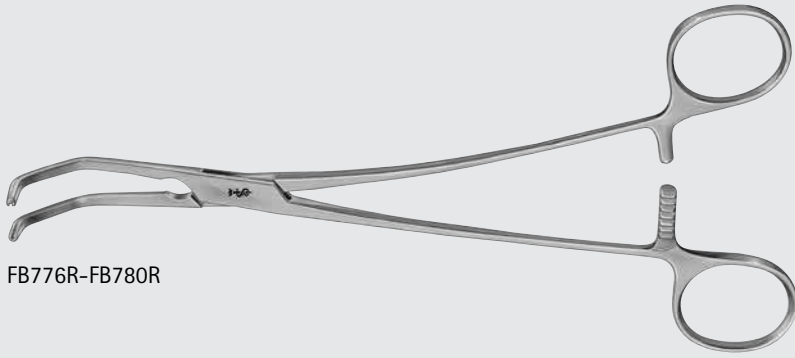

FB776R-FB780R

### COOLEY Partial Occlusion Clamp

Catalog Number	Jaw Length (mm)	Length (in.)
FB776R	31	8
FB777R	44	10 1/4
FB778R	50	10 1/2
FB779R	63	10 1/2
FB780R	78	10 3/4

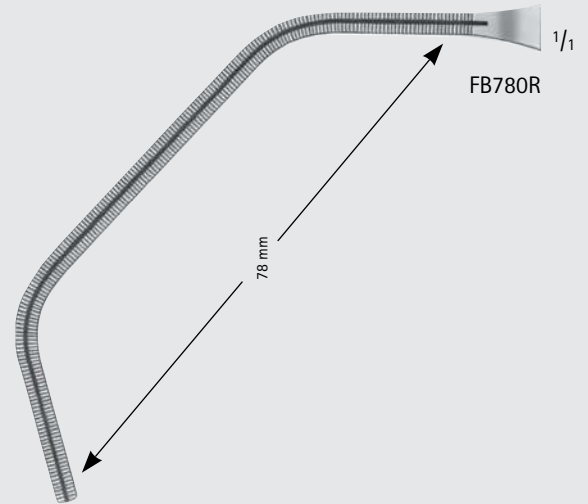
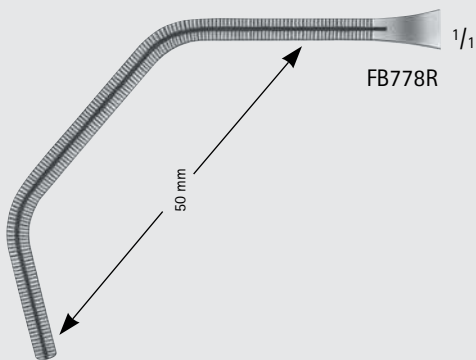
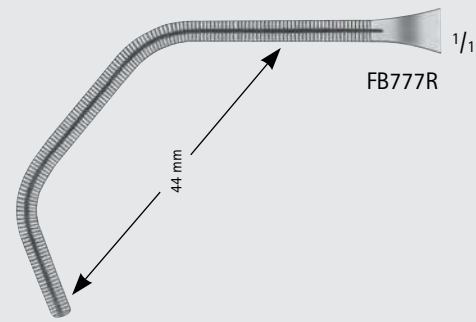
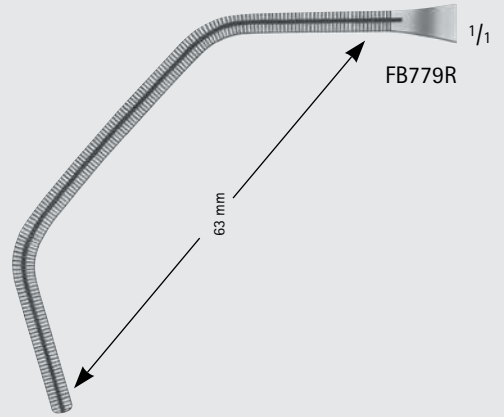
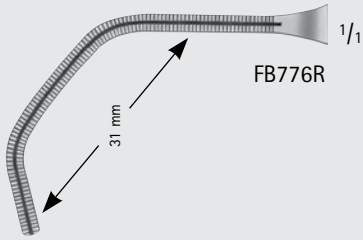

Atraumatic Multi-Purpose Clamp

Catalog Number	Jaw Length (mm)	Jaw	Length (in.)
FC310R	50	STR	6 3/4
FC311R	50	ANG 15°	6 3/4
FC312R	50	ANG 30°	6 3/4
FC313R	50	ANG 45°	6 1/4

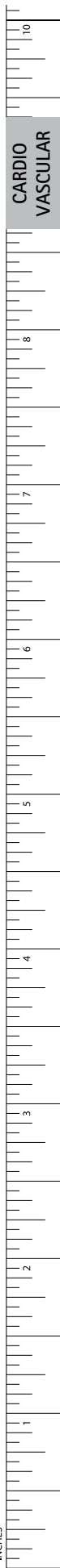
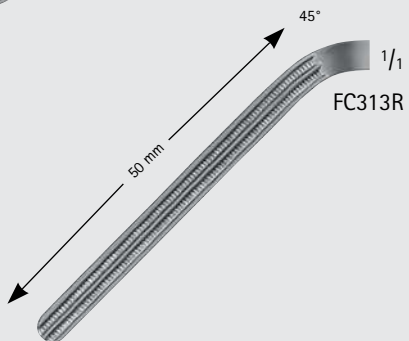
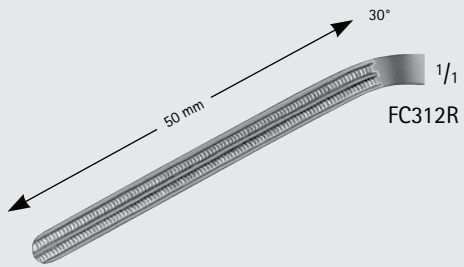
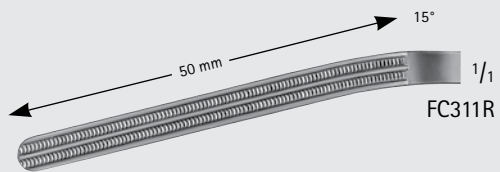
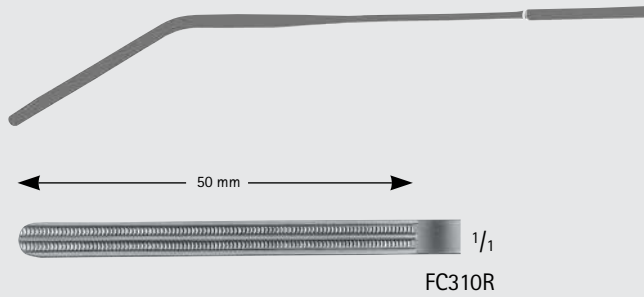
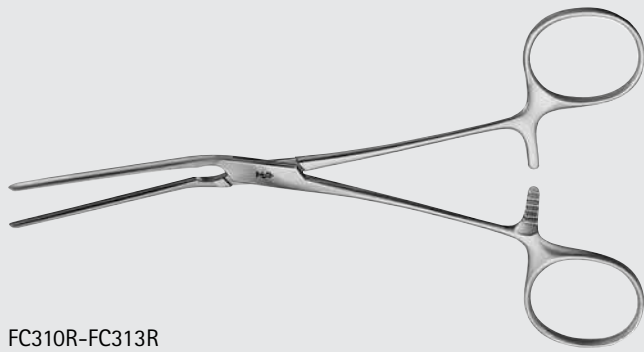

Cardiovascular  
Vascular Clamps



**KLINTMALM Liver Transplant Clamp**

Catalog Number	Jaw Length (mm)	Length (in.)
MG073R	95	9 3/4

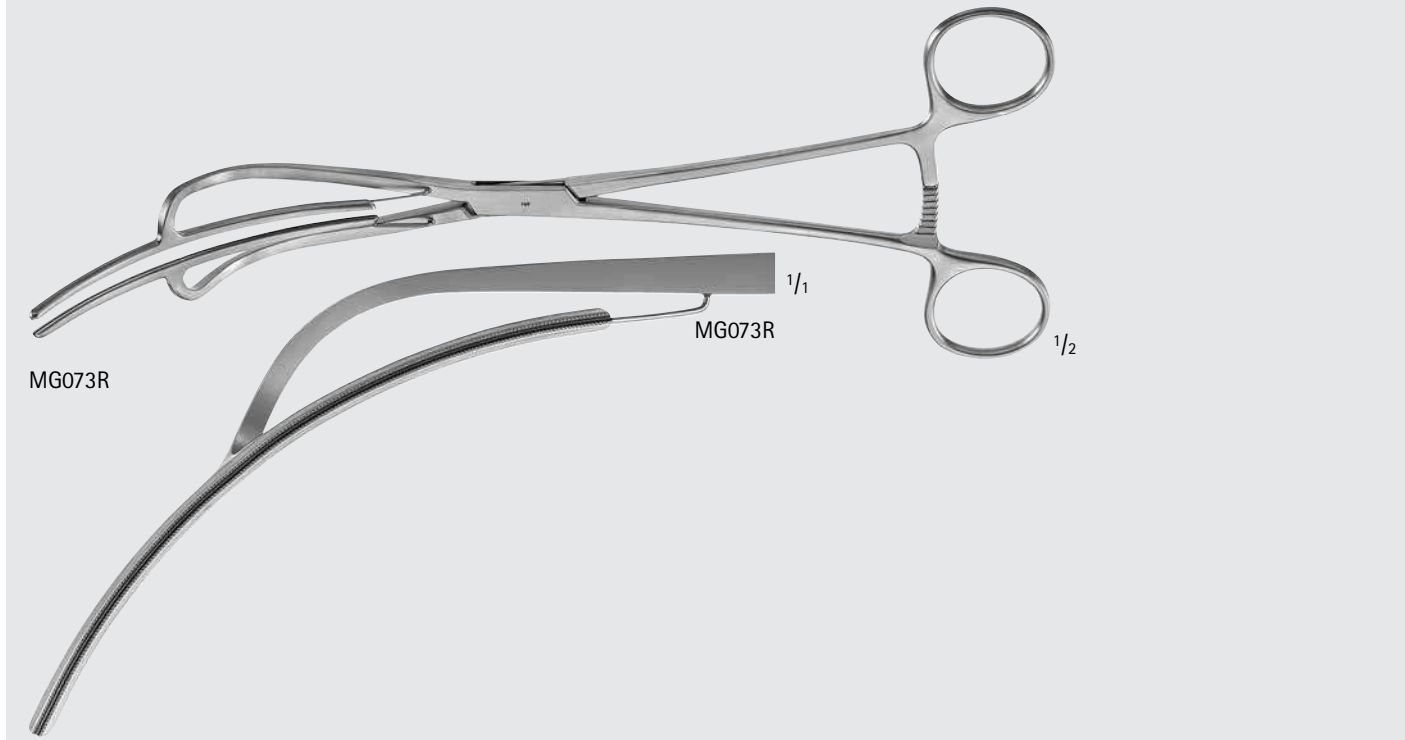

**KITZMILLER Clamp**

Catalog Number	Jaw	Jaw Length (mm)	Length (in.)
MG012R	ANG LEFT	10	5 1/4
MG013R	ANG RIGHT	10	5 1/4

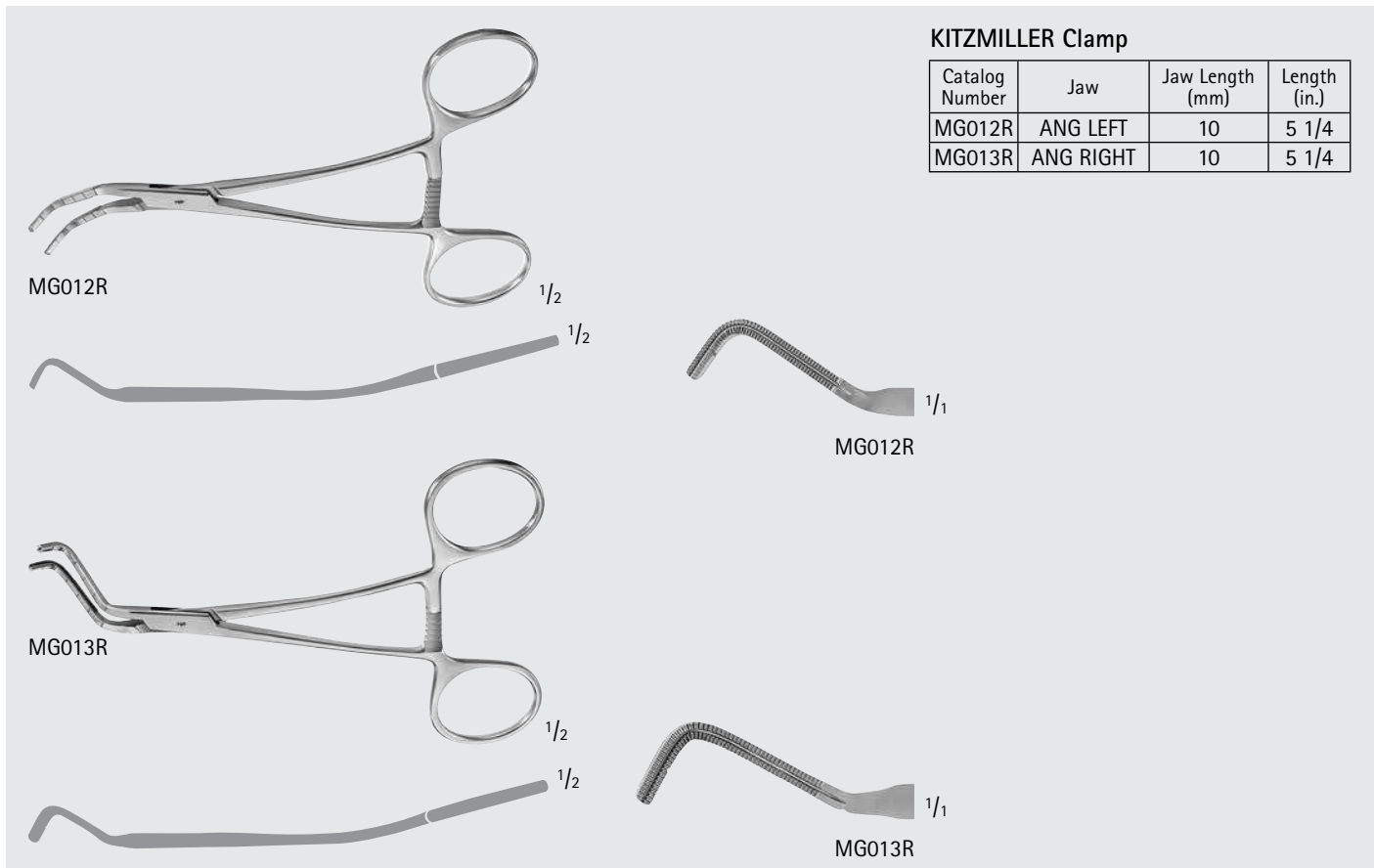

POTTS Liver Clamp W/ Teeth

Catalog Number	Size	Length (in.)
MB481R	SMALL	10
MB482R	MEDIUM	10 1/4
MB483R	LARGE	10 5/8

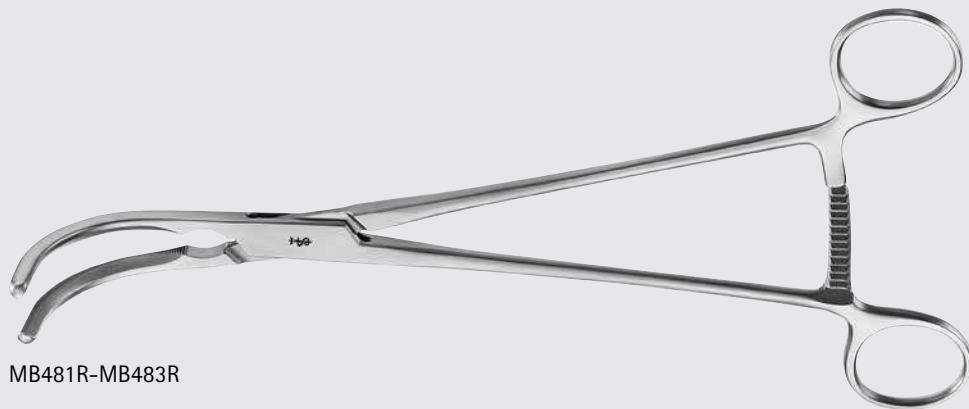

MB481R-MB483R

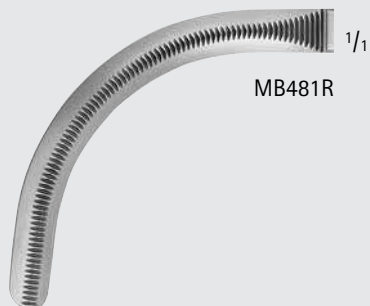

MB481R

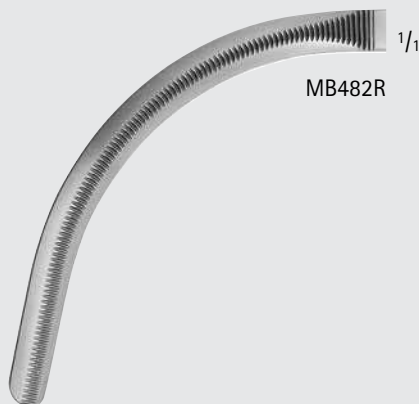

MB482R

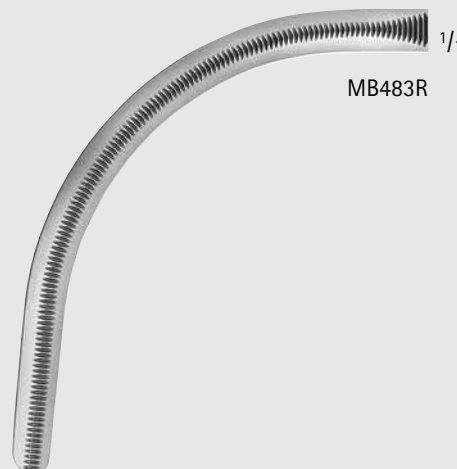

MB483R

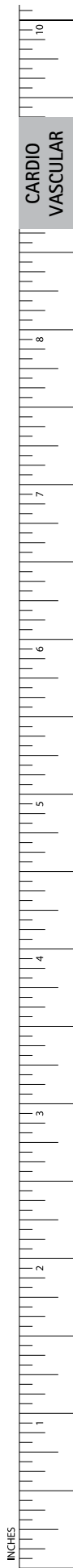

INCHES

Cardiovascular  
Vascular Clamps

PARSONNET Aorta Clamp

Catalog Number	Jaw Length (mm)	Length (in.)
MB671R	28	9 3/8
MB672R	32	9 5/8
MB673R	38	9 5/8
MB674R	45	10

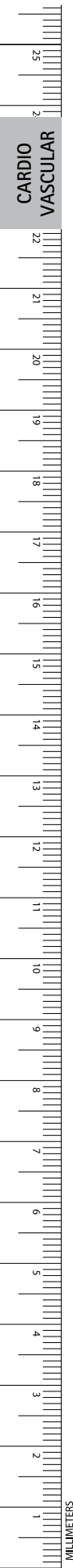
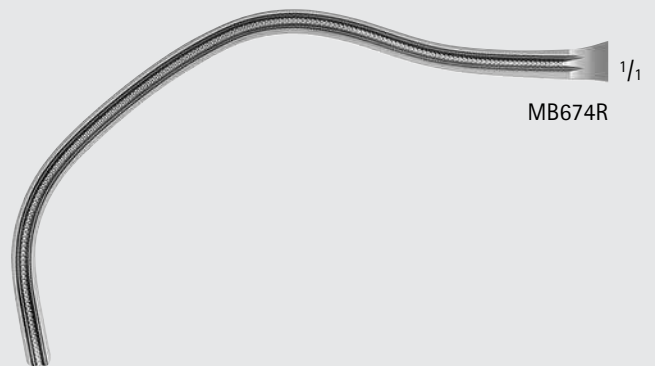
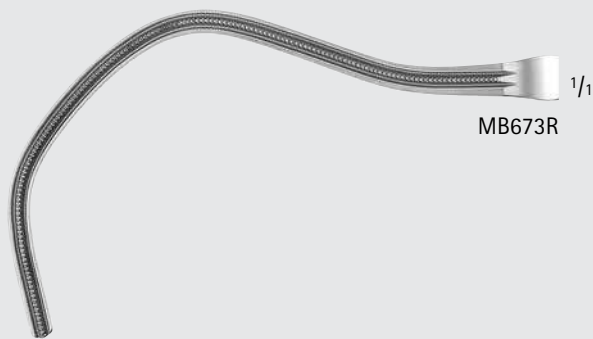
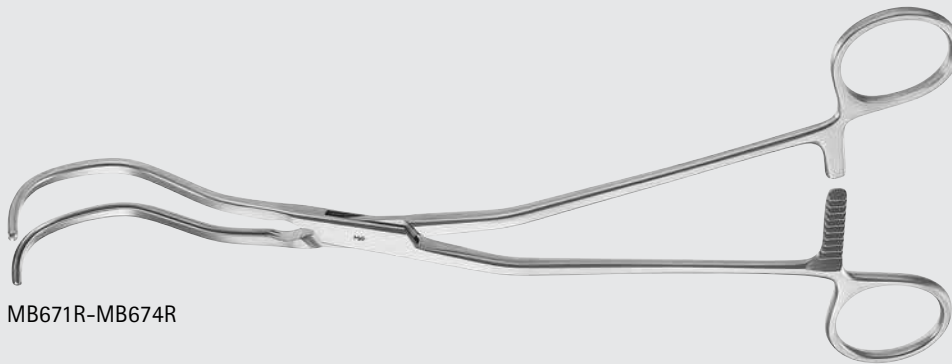

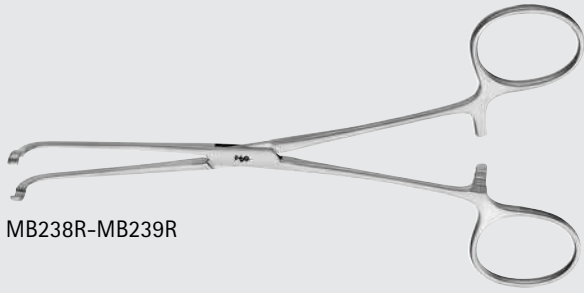

MB238R-MB239R

JAVID Carotid Artery Bypass  
Shunt Clamp

Catalog Number	Jaw	Length (in.)
MB238R	4 MM RING	6 5/8
MB239R	6 MM RING	7



MB238R

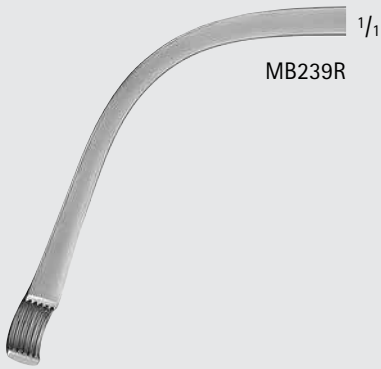

MB239R



# Cardiovascular

## Bulldog and Micro Vessel Clamps

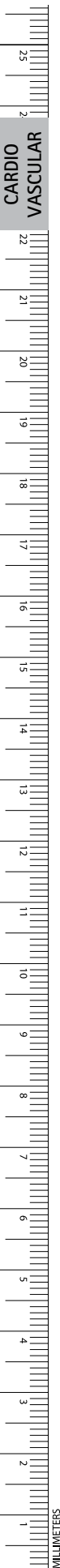

CARDIO  
VASCULAR

### JOHNS-HOPKINS Apply/Remove Forceps

Catalog Number	Length (in.)
BH018R	9 1/2

Forceps for applying and removing bulldog clamps BH011R - BH031R and FB420R - FB427R

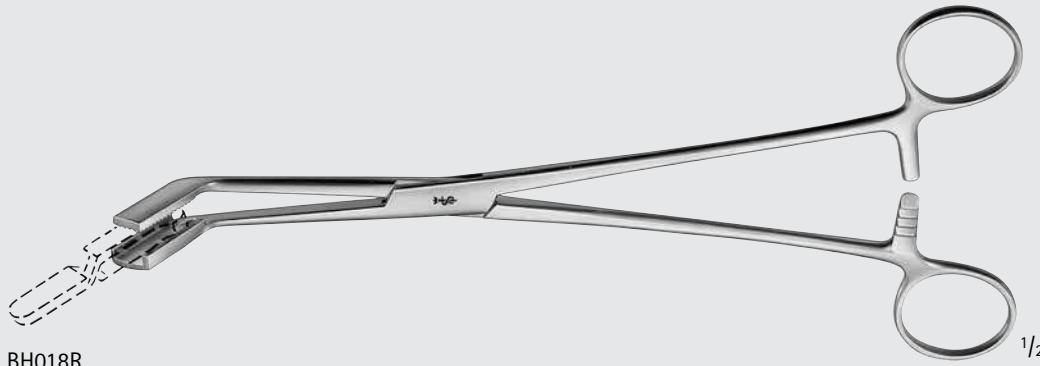

BH018R

### JOHNS-HOPKINS Bulldog Clamp

Catalog Number	Jaw	Jaw Length (mm)	Length (in.)
BH011R	CVD	12	1 1/2
BH012R	CVD	17	1 7/8
BH013R	CVD	25	2 1/8
BH014R	CVD	30	2 1/2
BH015R	CVD	33	2 3/4
BH016R	CVD	42	3 1/8
BH017R	CVD	52	3 1/2



BH011R-BH017R

### DIEFFENBACH Bulldog Clamp

Catalog Number	Jaw	Jaw Length (mm)	Length (in.)
BH020R	STR	12	1 1/2
BH022R	STR	16	1 7/8
BH026R	STR	16	2 1/8
BH021R	CVD	12	1 1/2
BH023R	CVD	16	1 7/8
BH027R	CVD	16	2 1/8



BH020R



BH026R



BH021R



BH027R





MG082R



MG083R



MG084R

**Bulldog Clamp, Lightweight**

Catalog Number	Jaw	Jaw Length (mm)	Length (in.)
MG082R	STR	18	1 1/2
MG083R	ANG	18	1 3/8
MG084R	ANG	21	1 1/2



BH030R



BH031R

**DEBAKEY-HESS Bulldog Clamp**

Catalog Number	Jaw	Jaw Length (mm)	Length (in.)
BH030R	ANG	20	1 3/8
BH031R	ANG	30	1 1/2



MB523R

**GREGORY-DEBAKEY Bulldog Clamp**

Catalog Number	Jaw	Jaw Length (mm)	Length (in.)
MB523R	ANG	70	4 3/4



FB382R

**GREGORY Mini-Bulldog Clamp**

Catalog Number	Jaw Length (mm)	Jaw	Length (in.)
FB382R	50	ANG	4 1/8
FB383R	65	ANG	4 3/4



FB383R

# Cardiovascular

## Bulldog and Micro Vessel Clamps

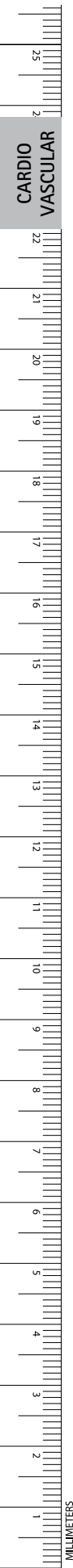

CARDIO  
VASCULAR

### GREGORY Mini-Bulldog Clamp

Catalog Number	Jaw	Jaw Length (mm)	Length (in.)
FB384R	CVD-LEFT	70	4 3/4
FB385R	CVD-RIGHT	70	4 3/4

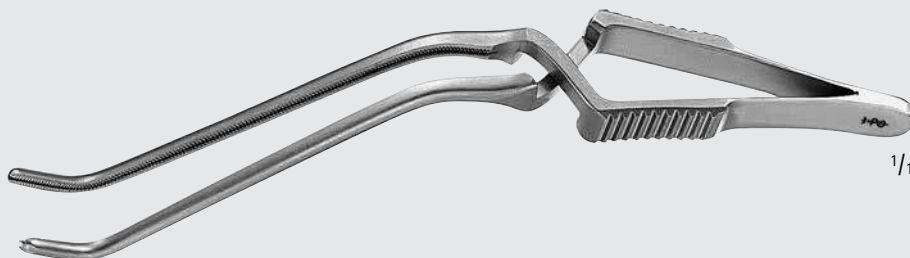

1/1

FB384R-FB385R

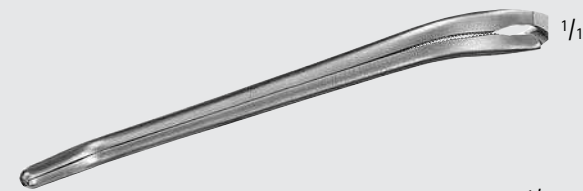

1/1

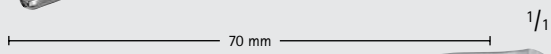

1/1

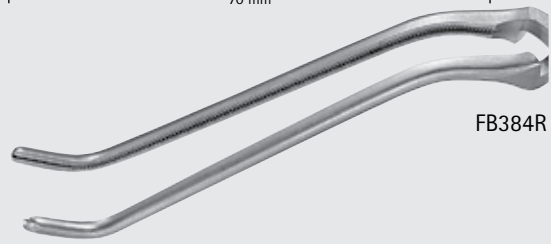

FB384R

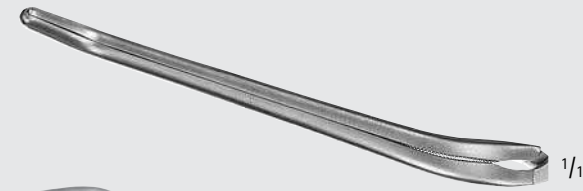

1/1

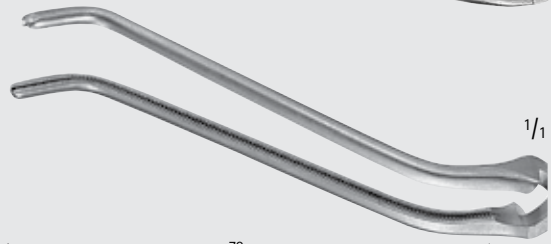

1/1

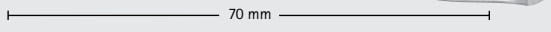

FB385R



FB420R, FB422R, FB424R, FB426R



FB421R, FB423R, FB425R, FB427R

**DEBAKEY Atraumatic Mini-Bulldog Clamp**

Catalog Number	Jaw	Jaw Length (mm)	Length (in.)
FB420R	STR	20	3 1/8
FB422R	STR	30	3 1/2
FB424R	STR	45	4 1/8
FB426R	STR	65	5
FB421R	CVD	20	3 1/8
FB423R	CVD	30	3 1/4
FB425R	CVD	45	3 3/4
FB427R	CVD	65	4 1/2



FB328R

1/1



FB330R

1/1



FB329R

1/1



FB331R

1/1

**Atraumatic Mini-Bulldog Clamp**

Catalog Number	Jaw	Jaw Length (mm)	Length (in.)
FB328R	STR	14	1 3/8
FB330R	STR	19	1 3/4
FB329R	CVD	14	1 3/8
FB331R	CVD	19	1 3/4



MB741R

1/1



MB285R

1/1



BH032R

1/1

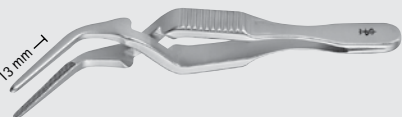

BH034R

1/1

**DIETRICH Micro Bulldog Clamp**

Catalog Number	Jaw	Jaw Length (mm)	Length (in.)
MB741R	STR	16	2
MB285R	STR	20	2 1/4
BH032R	ANG	10	1 7/8
BH034R	ANG	13	1 7/8

# Cardiovascular

## Bulldog and Micro Vessel Clamps

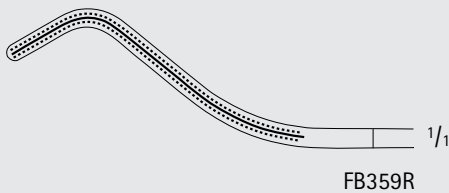
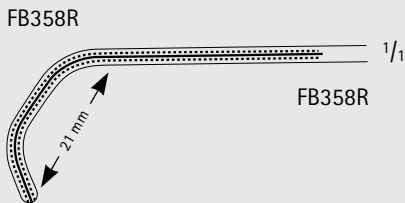
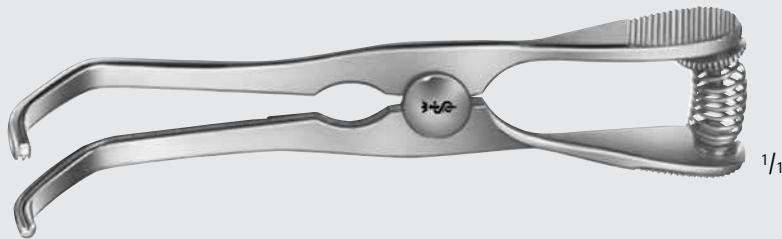
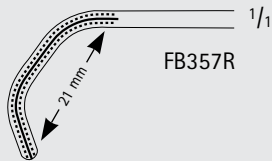
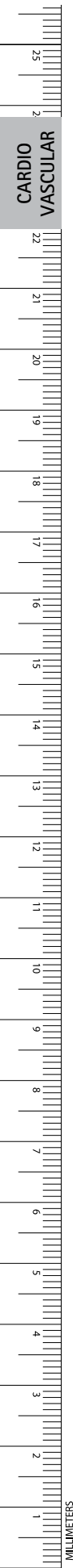

### DEBAKEY Atraumatic Mini-Bulldog Clamp

Catalog Number	Jaw Angle	Jaw Length (mm)	Length (in.)
FB352R	STR	20	2
FB353R	CVD	20	1 7/8
FB357R	MULTI	21	3
FB358R	MULTI	42	4
FB359R	S-SHAPED	38	3 3/4



FB431R



FB432R, FB434R, FB436R



FB433R, FB435R, FB437R

**GLOVER Atraumatic Mini-Bulldog Clamp**

Catalog Number	Jaw Angle	Jaw Length (mm)	Length (in.)
FB431R	75°	20	2
FB432R	STR	25	2 3/4
FB434R	STR	40	3 3/4
FB436R	STR	60	4 1/2
FB433R	CVD	25	2 1/2
FB435R	CVD	40	3 1/2
FB437R	CVD	60	4 1/4



MB737R-MB740R



MB586R-MB589R

**COOLEY Atraumatic Bulldog Clamp**

Catalog Number	Jaw	Jaw Length (mm)	Length (in.)
MB737R	STR	20	2
MB738R	STR	30	2 1/2
MB739R	STR	45	3 1/4
MB740R	STR	60	5
MB586R	CVD	44	1 3/4
MB587R	CVD	64	2 1/2
MB588R	CVD	75	3 1/8
MB589R	CVD	60	4 3/4



# Cardiovascular

## Bulldog and Micro Vessel Clamps

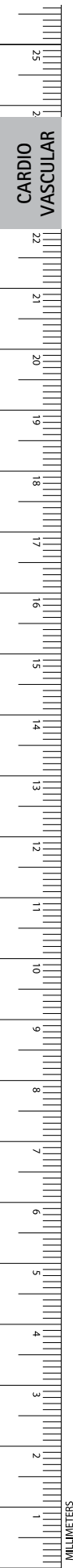

FB370R

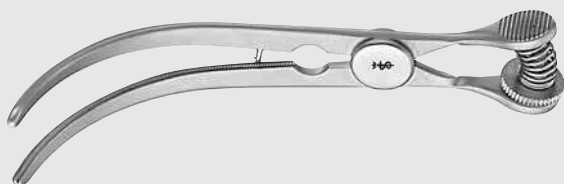

FB374R-FB376R

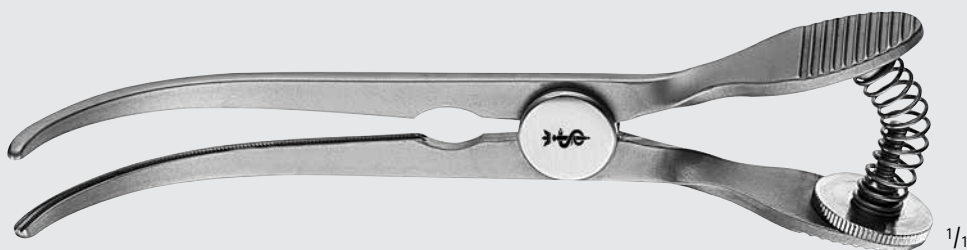

FB377R

### GLOVER Atraumatic Bulldog Clamp

Catalog Number	Jaw	Jaw Length (mm)	Length (in.)
FB370R	STR	25	2
FB374R	CVD	20	1 1/2
FB375R	CVD	30	2 3/8
FB376R	CVD	45	3
FB377R	CVD	55	4 3/4

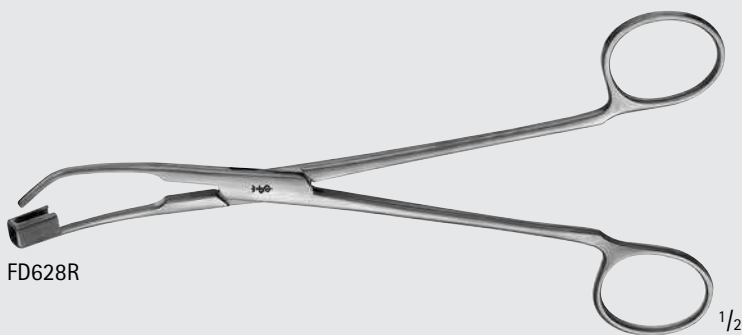

FD628R

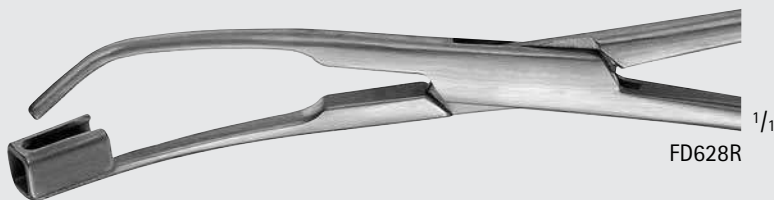

FD628R

### SCHWARTZ Apply/Remove Forceps

Catalog Number	Length (in.)
FD628R	7 1/2



FD622R

FD623R

FD624R

### SCHWARTZ Micro-Vessel Clamp, Cross-Serrated

Catalog Number	Jaw	Jaw Length (mm)	Closing Force	Length (in.)
FD622R	STR	8	400G	1
FD623R	25°	8	400G	1
FD624R	45°	8	400G	1



FE010K, FE020K

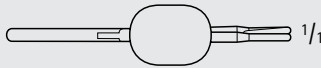

FE010K, FE020K



FE011K, FE021K



FE011K, FE021K



FE012K, FE022K

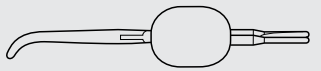

FE012K, FE022K



FE013K, FE023K

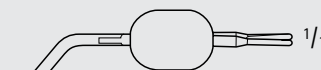

FE013K, FE023K



FE014K, FE024K

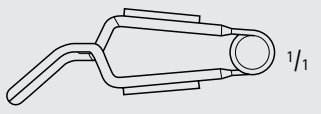

FE014K, FE024K

MUELLER Atraumatic Micro-Vessel  
Clamp

Catalog Number	Jaw	Closing Force
FE010K	STR	50G
FE020K	STR	80G
FE011K	FULL-CVD	50G
FE021K	FULL-CVD	80G
FE012K	CVD-TIP	50G
FE022K	CVD-TIP	80G
FE013K	ANG	50G
FE023K	ANG	80G
FE014K	LAT-ANG	50G
FE024K	LAT-ANG	80G



FE005K



FE005K

MUELLER Ligature Forceps

Catalog Number	Jaw
FE005K	STR

# Cardiovascular

## Bulldog and Micro Vessel Clamps

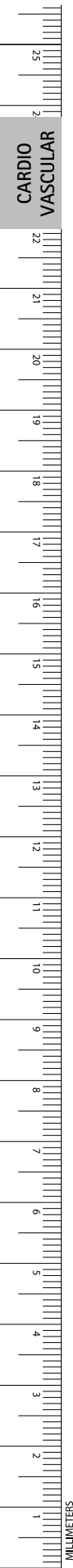

FE031S, FE041S



FE032S, FE042S



FE030S, FE040S



FE034S, FE044S

### MUELLER Alpha Vessel Clamp

Catalog Number	Jaw	Closing Force
FE031S	SLIGHT-CVD	250G
FE041S	SLIGHT-CVD	350G
FE032S	CVD	250G
FE042S	CVD	350G
FE030S	ANG	250G
FE040S	ANG	350G
FE034S	KNEE-BENT	250G
FE044S	KNEE-BENT	350G



**NABATOFF Vein Stripper Set**

Catalog Number	Description
FB031R	METAL CASE
FB040R	HANDLE
FB033	PLASTIC PROBE TIP
FB034R	METAL PROBE TIP, 3 MM
FB035R	METAL OLIVE, 6 MM
FB036R	METAL OLIVE, 9 MM
FB037R	METAL OLIVE, 12 MM
FB038R	METAL OLIVE, 15 MM

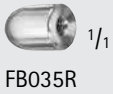

**NABATOFF Mini Vein Stripper Set**

Catalog Number	Description
FB031R	METAL CASE
FB053R	METAL OLIVE, 3 MM
FB054R	METAL OLIVE, 4 MM
FB055R	METAL OLIVE, 5 MM

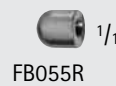
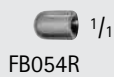

# Cardiovascular

## Vessel Instruments

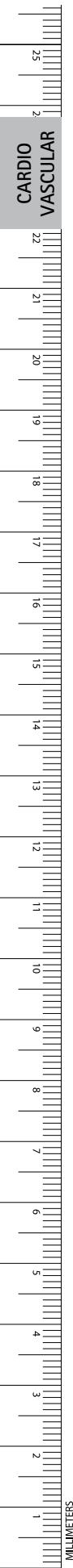

**VARADY Varix Dissector, Double Ended**

Catalog Number	Tip Size (mm)	Length (in.)
FB120R	0.30 / 0.30	7

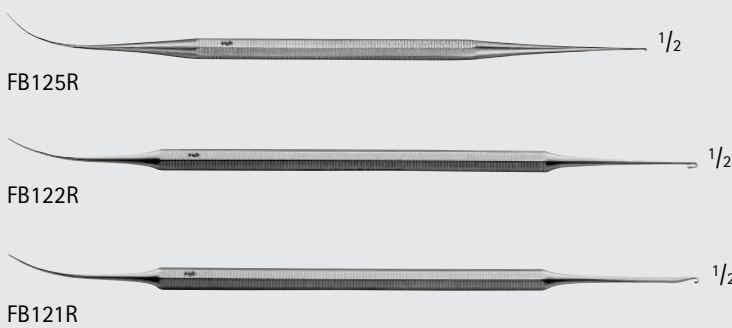

**VARADY Varix Extractor, Double Ended W/ Hook**

Catalog Number	Tip Size (mm)	Length (in.)
FB125R	0.25 / 0.40	6 3/4
FB122R	0.75 / 0.60	7
FB121R	0.75 / 1.2	7



**VARADY Mini-Varix Extractor, Double Ended W/ Hook**

Catalog Number	Tip Size (mm)	Length (in.)
FB126R	0.35 / 0.50	6 3/4



**VARADY Micro Spatula, Double Ended**

Catalog Number	Tip Size (mm)	Length (in.)
FB124R	0.35 / 0.25	6 7/8



FB108R-FB117R

○ 1/1

FB108R

○ 1/1

FB109R

○ 1/1

FB110R

○ 1/1

FB112R

○ 1/1

FB113R

○ 1/1

FB114R

○ 1/1

FB115R

○ 1/1

FB116R

○ 1/1

FB117R



FB119R

Endarterectomy Stripper

Catalog Number	Tip Size (mm)	Length (in.)
FB108R	2	21 3/4
FB109R	3	21 3/4
FB110R	4	21 3/4
FB112R	6	21 3/4
FB113R	7	21 3/4
FB114R	8.5	21 3/4
FB115R	10	21 3/4
FB116R	12	21 3/4
FB117R	14	21 3/4
FB119R	-	4 1/4

FB119R is the handle for FB108R-FB117R



INCHES

# Cardiovascular

## Specialty CV/Thoracic Instruments

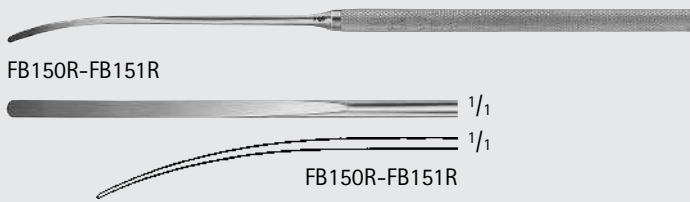
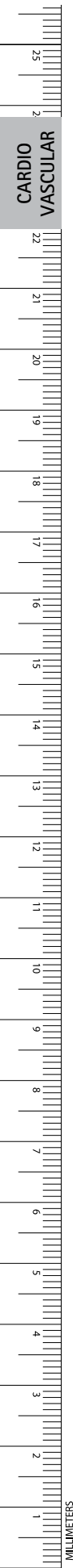

FB150R-FB151R

FB150R-FB151R

### Vascular Spatula, Blunt, 3 mm

Catalog Number	Length (in.)
FB150R	7 1/4
FB151R	8 1/2



MB063R

MB063R

### JACOBSON Endarterectomy Spatula

Catalog Number	Length (in.)
MB063R	7



FB160R-FB172R, MG008R-MG010R

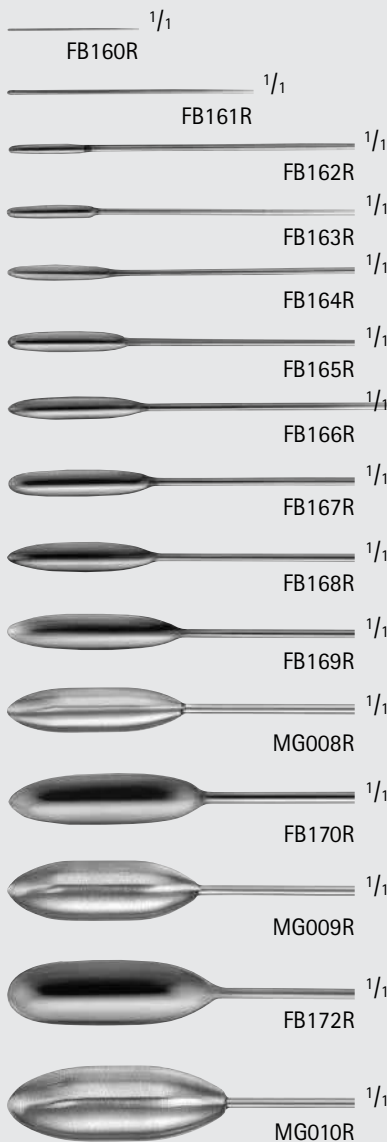

### DEBAKEY Vascular Dilator, Malleable

Catalog Number	Tip Size (mm)	Length (in.)
MG011R	SET OF 12	-
MG055R	SET OF 5	-
FB160R	0.5	7 1/2
FB161R	1.0	7 1/2
FB162R	1.5	7 1/2
FB163R	2.0	7 1/2
FB164R	2.5	7 1/2
FB165R	3.0	7 1/2
FB166R	3.5	7 1/2
FB167R	4.0	7 1/2
FB168R	4.5	7 1/2
FB169R	5.0	7 1/2
MG008R	6.0	7 1/2
FB170R	7.0	7 1/2
MG009R	8.0	7 1/2
FB172R	9.0	7 1/2
MG010R	10.0	7 1/2

#### MG011R Includes:

1 Dilator of each FB161R-165R, FB167R, FB169R, MG008R, FB170R, MG009R, FB172R, MG010R

#### MG055R Includes:

1 Dilator of each FB161R-165R

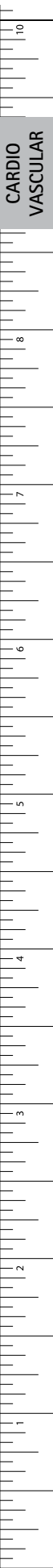

**GARRETT Vascular Dilator**

Catalog Number	Tip Size (mm)	Length (in.)
MB245	COMPLETE SET	5 1/2
MB246	1.0	5 1/2
MB247	1.5	5 1/2
MB248	2.0	5 1/2
MB249	2.5	5 1/2
MB250	3.0	5 1/2
MB251	3.5	5 1/2
MB252	4.0	5 1/2
MB253	4.5	5 1/2
MB254	5.0	5 1/2
MB255	TUBE	5 1/2

MB245 Includes:  
1 Dilator of each MB246-MB254

MB255:  
Tube for GARRETT Vascular Dilators  
MB245-MB254

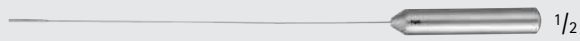

MB246-MB254

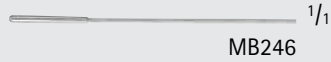

MB246



MB247



MB248



MB249



MB250

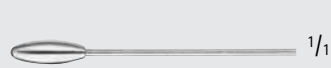

MB251

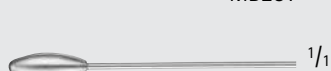

MB252

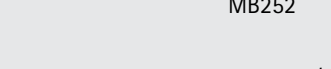

MB253

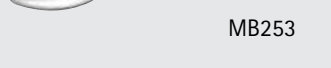

MB254



MB254



MB255

1/2

# Cardiovascular

## Specialty CV/Thoracic Instruments

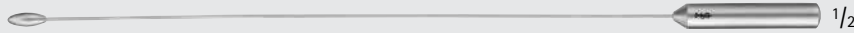
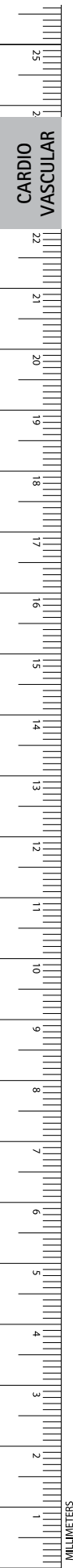

MB257-MB265



MB257

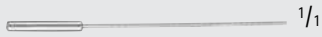

MB258

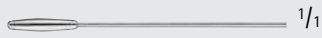

MB259

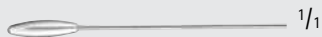

MB260

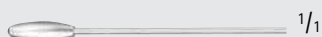

MB261

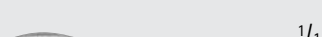

MB262

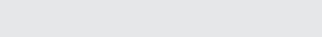

MB263

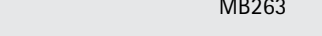

MB264

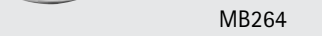

MB265



MB266

### GARRETT Vascular Dilator

Catalog Number	Tip Size (mm)	Length (in.)
MB256	COMPLETE SET	8 1/2
MB257	1.0	8 1/2
MB258	1.5	8 1/2
MB259	2.0	8 1/2
MB260	2.5	8 1/2
MB261	3.0	8 1/2
MB262	3.5	8 1/2
MB263	4.0	8 1/2
MB264	4.5	8 1/2
MB265	5.0	8 1/2
MB266	TUBE	8 1/2

MB256 Includes:

1 Dilator of each MB257-MB265

MB266:

Tube for GARRETT Vascular Dilator



MG051R-MG054R



MG053R



MG052R



MG051R



MG054R

### Aortic Arch Dilator

Catalog Number	Tip Size (mm)	Length (in.)
MG053R	5	8
MG051R	6	8
MG052R	8	8
MG054R	9.5	8



FB153R-FB156R



FB153R



FB154R



FB155R



FB156R

**SCHMID Vessel Irrigation Cannula,  
Silver Plated**

Catalog Number	Tip Size (mm)	Length (in.)
FB153R	3	6
FB154R	4	6
FB155R	5	6
FB156R	6	6



MD610-MD611

**Heparin Needle**

Catalog Number	Gauge	Length (in.)
MD610	13	3 1/2
MD611	18	3 3/4

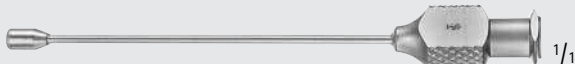

MB601R

**ZANGER Heparin Cannula, Malleable**

Catalog Number	Tip Size (mm)	Length (in.)
MB601R	3.5	2 3/4



MB602R

**IMA Heparin Cannula, Malleable**

Catalog Number	Tip Size (mm)	Length (in.)
MB602R	1.5	2 1/8



MB634R

**Luer Lock Adapter**

Catalog Number	Length (in.)
MB634R	1 1/2

# Cardiovascular

## Specialty CV/Thoracic Instruments

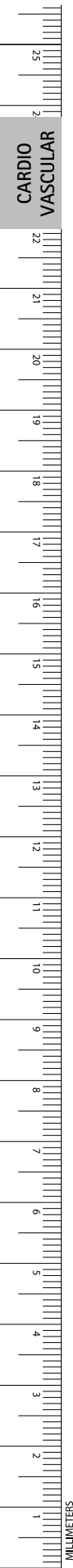

FK340R

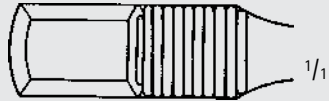

FK340R



FK341R

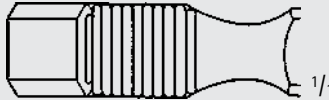
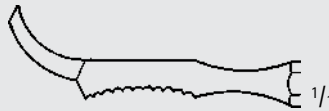

FK341R

### FARABEUF Elevator

Catalog Number	Tip Size (mm)	Blade Shape	Length (in.)
FK340R	12.5	STR	5 3/4
FK341R	12.5	CVD	5 1/4



FK344R

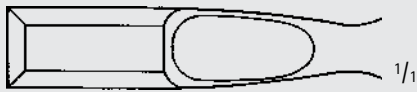
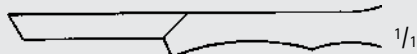

FK344R



FK345R

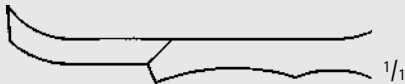

FK345R

### FARABEUF-COLLIN Elevator

Catalog Number	Tip Size (mm)	Blade Shape	Length (in.)
FK344R	11	STR	6 1/4
FK345R	11	CVD	6 1/4





MB812R

**MATSON Rib Stripper/Elevator**

Catalog Number	Length (in.)
MB812R	8 3/4



FK355R-FK359R

**LAMBOTTE Rib Elevator**

Catalog Number	Tip Size (mm)	Length (in.)
FK355R	5	8 1/2
FK356R	10	8 1/2
FK357R	15	8 1/2
FK358R	20	8 1/2
FK359R	25	8 1/2

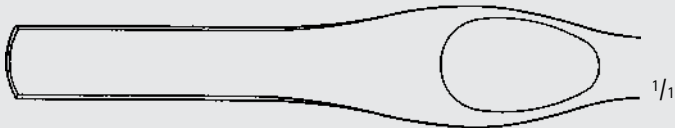
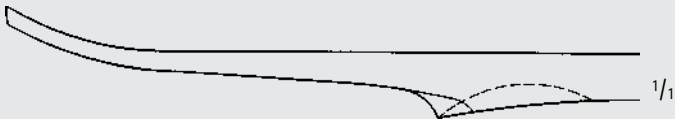

FK355R-FK359R



# Cardiovascular

## Specialty CV/Thoracic Instruments

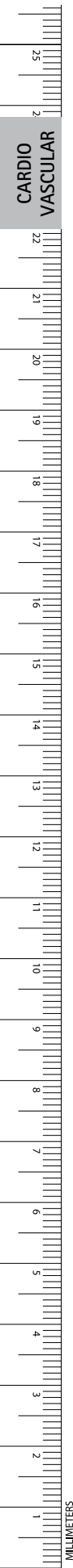

CARDIO  
VASCULAR



FK381R-FK387R

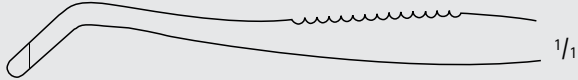

1/1



1/1

FK381R

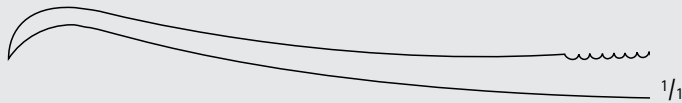

1/1



1/1

FK382R

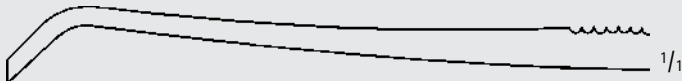

1/1



1/1

FK383R

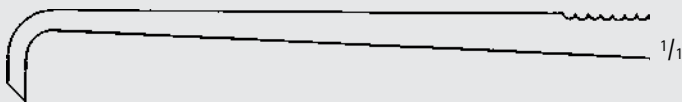

1/1

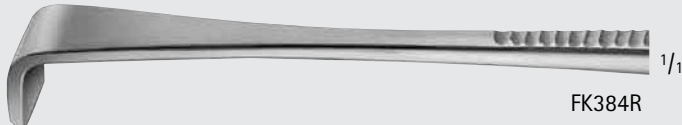

1/1

FK384R

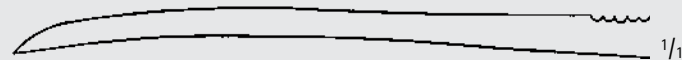

1/1



1/1

FK387R

### SEMB Elevator

Catalog Number	Tip Size (mm)	Length (in.)
FK381R	12	7 1/2
FK382R	12	9
FK383R	13	9
FK384R	13	9
FK387R	15	9

DOYEN Elevator

Catalog Number	Blade End	Blade Shape	Length (in.)
FK400R	PEDIATRIC	LEFT-CVD	6 7/8
FK402R	ADULT	LEFT-CVD	6 7/8
FK401R	PEDIATRIC	RIGHT-CVD	6 7/8
FK403R	ADULT	RIGHT-CVD	6 7/8
FK408R	-	LEFT-CVD	9 1/2
FK409R	-	RIGHT-CVD	9 1/2



FK400R-FK402R

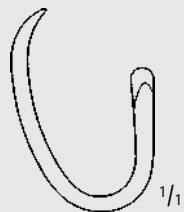

FK400R

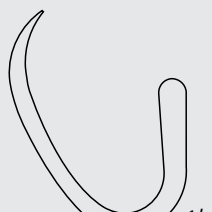

FK402R



FK401R-FK403R

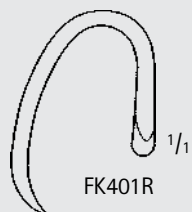

FK401R

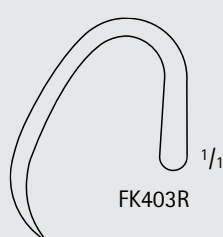

FK403R

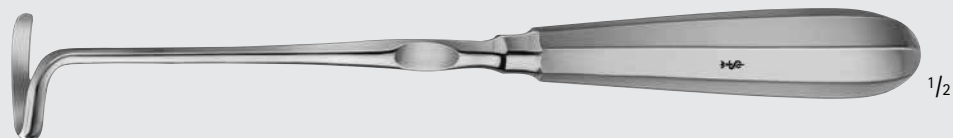

FK408R

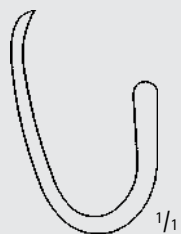

FK408R



FK409R

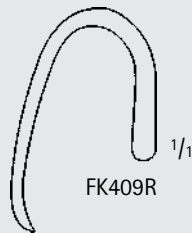

FK409R

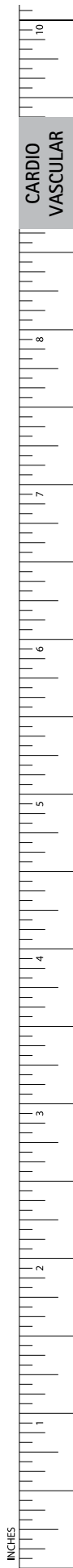

# Cardiovascular

## Specialty CV/Thoracic Instruments

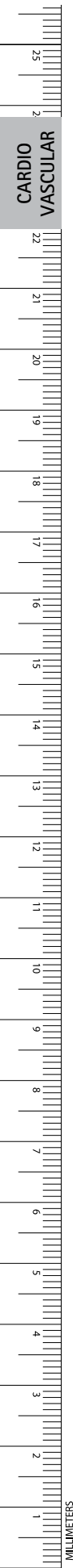

FK420R

### ALEXANDER Elevator

Catalog Number	Tip Size (mm)	Length (in.)
FK420R	12	8 1/4

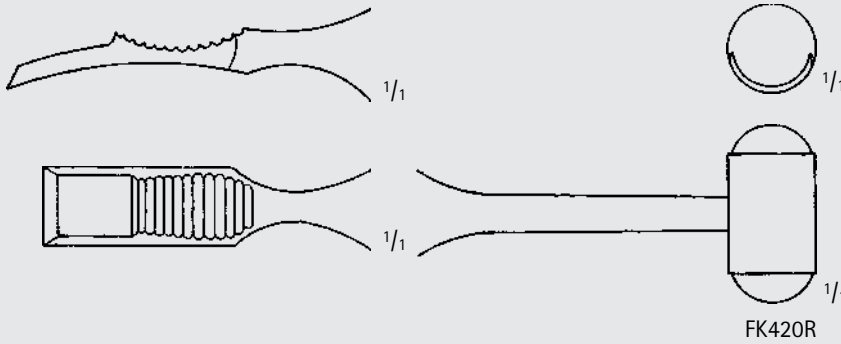

FB870R

### Rib Shears

Catalog Number	Blade	Length (in.)
FB870R	S/B	9



FB873R

### GLUCK Rib Shears

Catalog Number	Length (in.)
FB873R	7 1/2

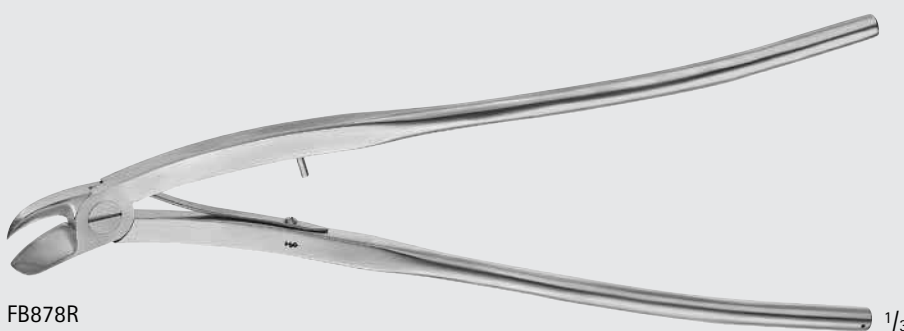

FB878R

### BETHUNE Rib Shears

Catalog Number	Length (in.)
FB878R	13 3/8



**SAUERBRUCH Rib Shears**

Catalog Number	Size	Length (in.)
FB881R	PEDIATRIC	9 1/2
FB882R	ADULT	10 5/8

FB881R-FB882R

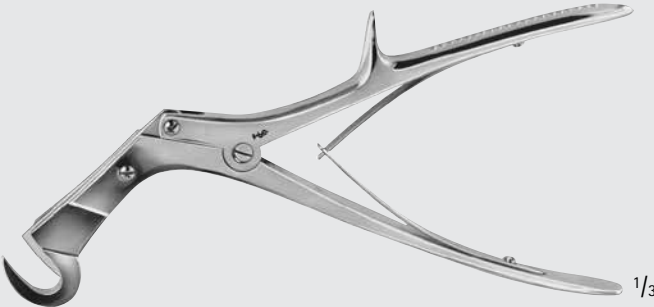

**GIERTZ-STILLE Rib Shears**

Catalog Number	Length (in.)
FB890R	9 3/4

FB890R



**SWEET Sternum Punch**

Catalog Number	Length (in.)
MG094R	10

MG094R

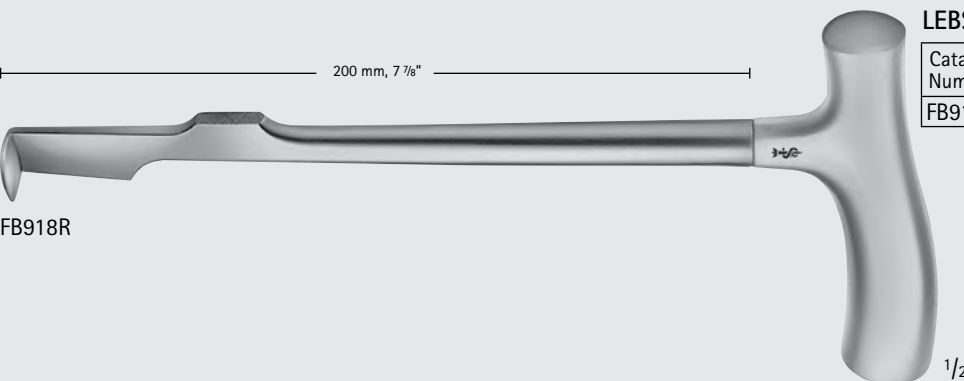

**LEBSCHKE Sternum Chisel**

Catalog Number	Length (in.)
FB918R	9 3/4

200 mm, 7 7/8"

FB918R

# Cardiovascular

## Specialty CV/Thoracic Instruments

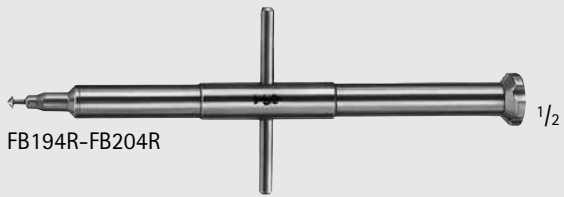
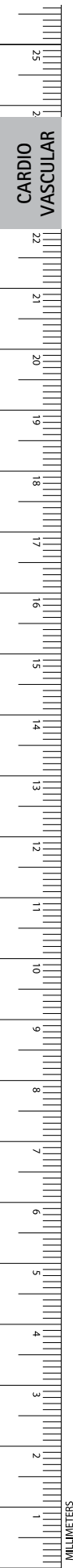

FB194R-FB204R



FB201R



FB202R

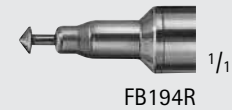

FB194R



FB203R



FB195R



FB204R



FB196R

### Aorta Punch

Catalog Number	Tip Size (mm)	Length (in.)
FB201R	3.0	5 1/2
FB202R	3.5	5 1/2
FB194R	4.0	5 1/2
FB203R	4.5	5 1/2
FB195R	5.0	5 1/2
FB204R	5.5	5 1/2
FB196R	6.0	5 1/2

### Valvulotome

Catalog Number	Tip	Length (in.)
MB360R	ANTEGRADE	6 3/8
MB358R	RETROGRADE	9 1/2
MB359R	RETROGRADE	12 1/4

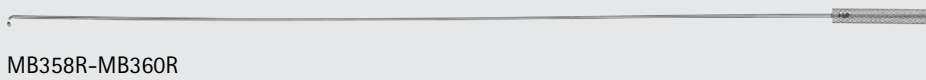

MB358R-MB360R



MB360R



MB358R



MB359R

JENKNER Tunnelling Instruments

Catalog Number	Diameter (mm)	Description	Length (in.)
FC004R	12	TUNNELLING TUBE W/ CONICAL TIP	16
FC005R	12	TUNNELLING TUBE W/ CONICAL TIP	20
FC014R	14	TUNNELLING TUBE W/ CONICAL TIP	16
FC015R	14	TUNNELLING TUBE W/ CONICAL TIP	20
FC034R	5	TUNNELLING FORCEPS F/ FC004R/ FC014R	16
FC035R	5	TUNNELLING FORCEPS F/ FC005R/ FC015R	20
FC030	-	HANDLE F/ TUNNELLING TUBES	-

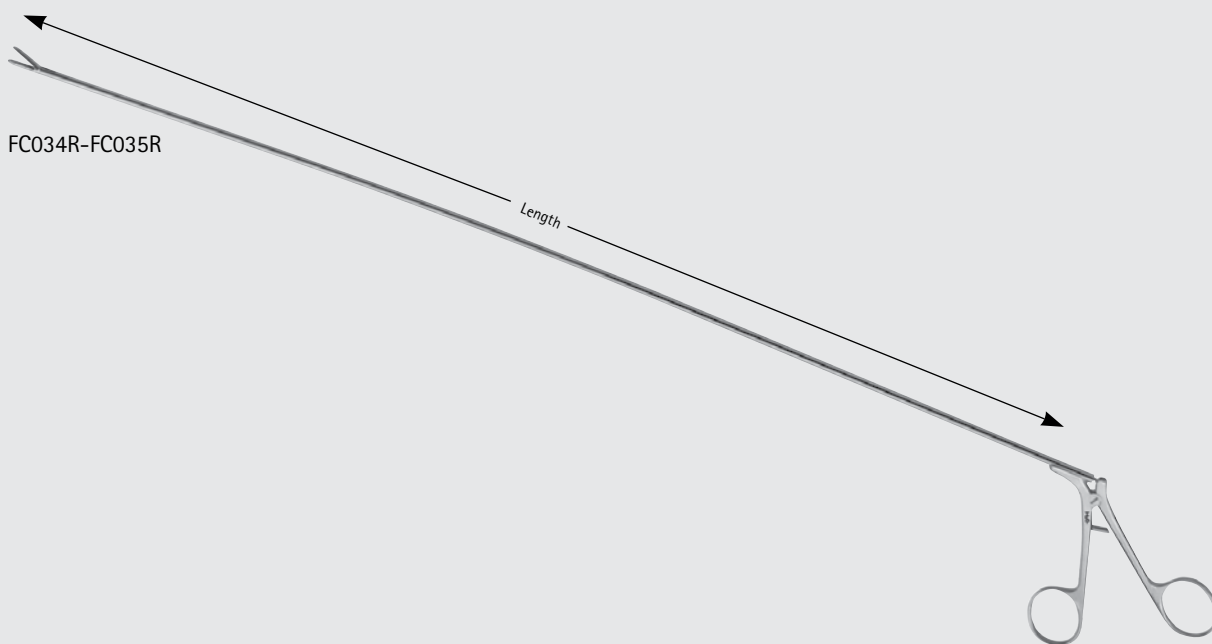
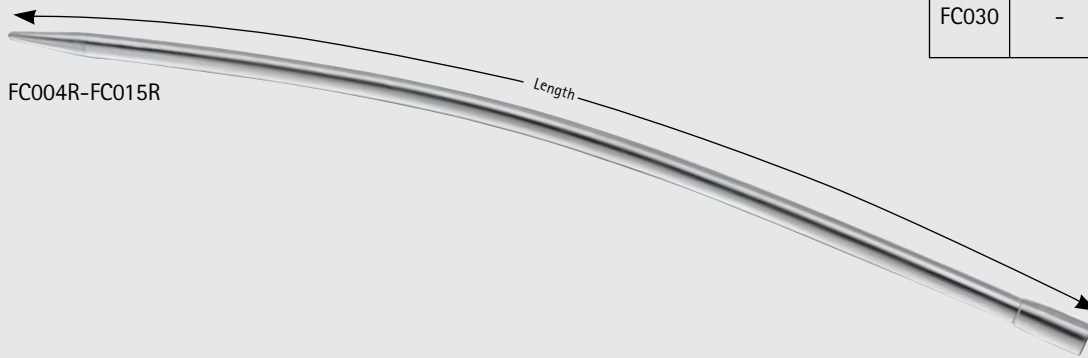

1/3



# Cardiovascular

## Specialty CV/Thoracic Instruments

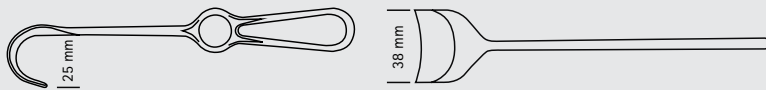
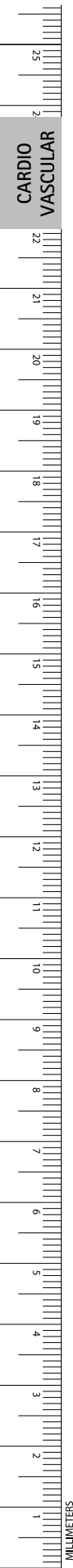

Dimensions for blade size of retractors  
 1st number = depth      Example: 25 x 38 mm  
 2nd number = width

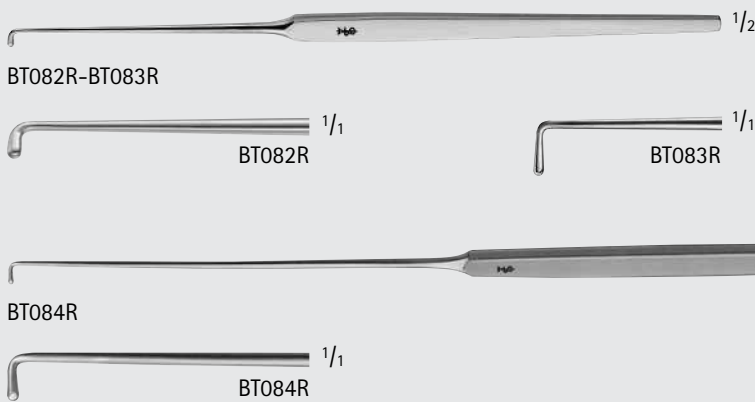

### CUSHING Vessel Hook

Catalog Number	Tip Size (mm)	Tip	Length (in.)
BT082R	1 x 4	BLUNT	7 1/2
BT083R	1 x 7	BLUNT	7 1/2
BT084R	1 x 6	BLUNT	11

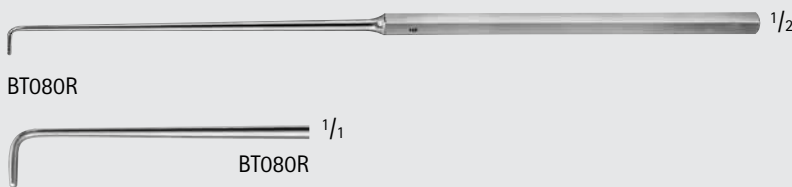

### CRILE Vessel Hook

Catalog Number	Tip Size (mm)	Tip	Length (in.)
BT080R	1.5 x 9	BLUNT	7 7/8



### DANDY Nerve Hook

Catalog Number	Tip Size (mm)	Tip	Length (in.)
MD562	1 x 8	BLUNT	8 3/4

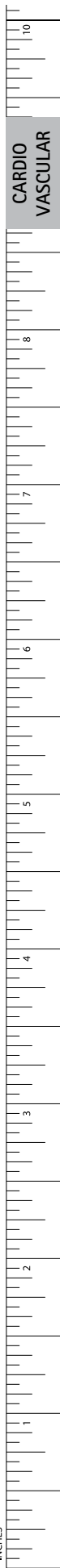
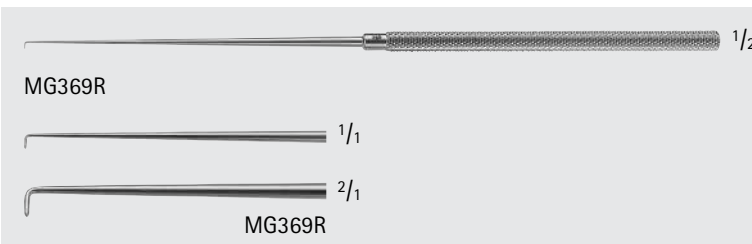

MG369R  $\frac{1}{2}$

MG369R  $\frac{1}{1}$

MG369R  $\frac{2}{1}$

MG369R

Blunt Hook			
Catalog Number	Tip Size (mm)	Tip	Length (in.)
MG369R	2	RND	7

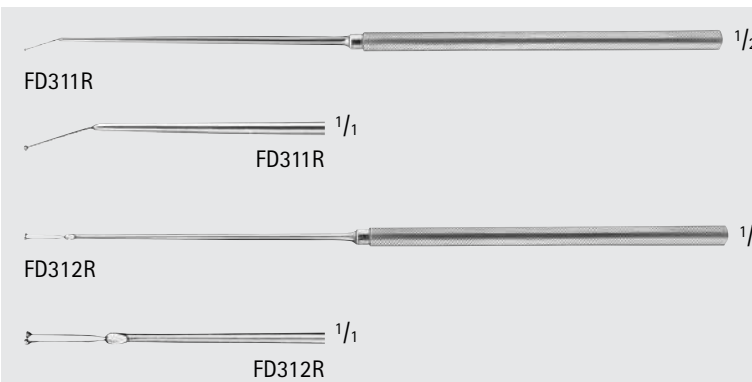

FD311R  $\frac{1}{2}$

FD311R  $\frac{1}{1}$

FD311R

FD312R  $\frac{1}{2}$

FD312R  $\frac{1}{1}$

FD312R

JACOBSON Probe		
Catalog Number	Tip	Length (in.)
FD311R	ANG, SINGLE PROBE	7 1/4
FD312R	STR, DOUBLE PROBE	7 1/4

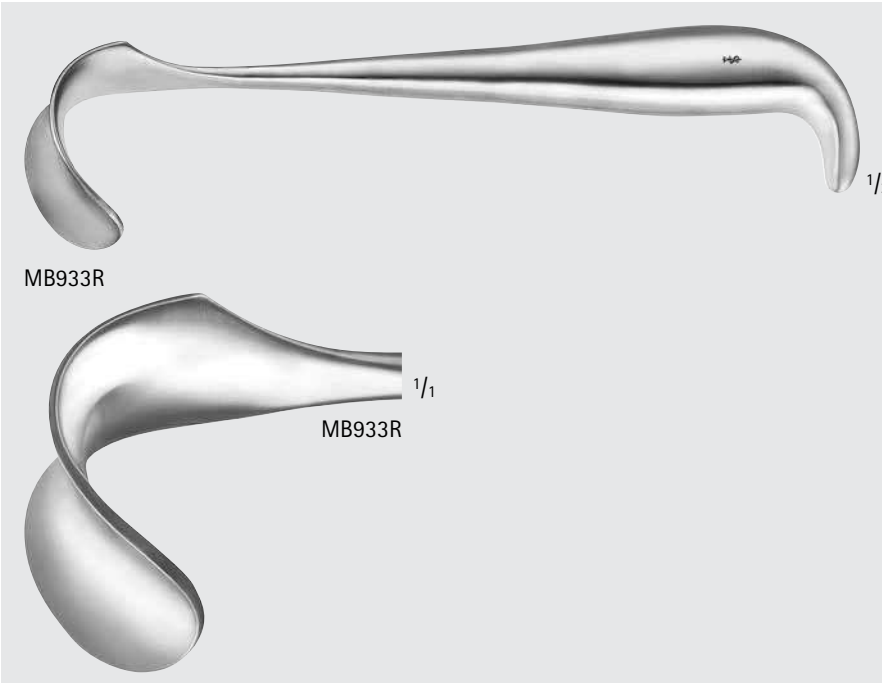

MB933R  $\frac{1}{2}$

MB933R  $\frac{1}{1}$

MB933R

BREWSTER Retractor			
Catalog Number	Blade Size (mm)	Blade	Length (in.)
MB933R	25 x 45	CVD CONVEX	9

# Cardiovascular

## Retractors

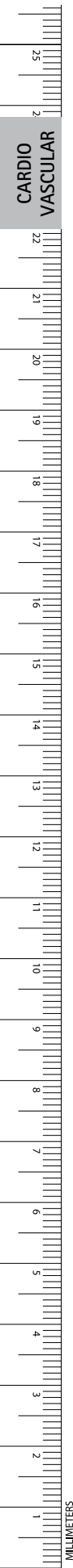

BV014R



### PARSONNET Epicardial Retractors

Catalog Number	Blade End	Tip	Length (in.)
BV014R	3 x 3 PRONGS	SHARP	2



BV021R-BV024R

### IMA Epicardial Retractor

Catalog Number	Blade End	Tip	Length (in.)
BV021R	3 x 3 PRONGS	SHARP	1
BV022R	3 x 3 PRONGS	SHARP	1 1/4
BV023R	3 x 3 PRONGS	SHARP	1 1/2
BV024R	3 x 3 PRONGS	SHARP	2



MB047R-MB048R, MB700R-MB703R

### ROSS Aortic Valve Retractor

Catalog Number	Blade Size (mm)	Length (in.)
MB047R	15 x 15	10
MB048R	13 x 22	10
MB700R	17 x 24	10
MB701R	13 x 27	10
MB702R	30 x 28	10
MB703R	40 x 25	10



MB047R



MB048R



MB700R

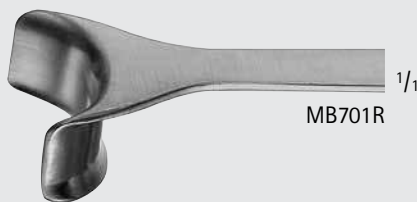

MB701R



MB702R



MB703R



FB923R-FB927R

1/2

COOLEY Atrium Retractor, Left

Catalog Number	Blade Size (mm)	Length (in.)
FB923R	25 x 20	9 5/8
FB924R	25 x 25	9 5/8
FB925R	25 x 30	9 5/8
FB926R	25 x 35	9 5/8
FB927R	25 x 45	9 5/8



25 x 20 mm

FB923R 1/1



25 x 25 mm

FB924R 1/1

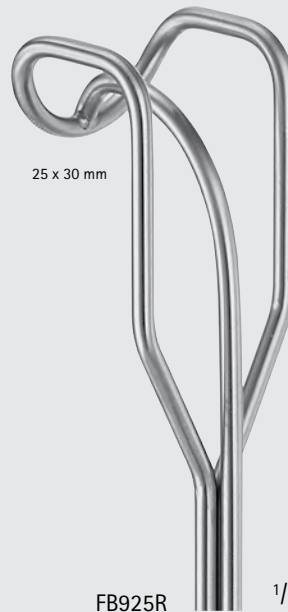

25 x 30 mm

FB925R 1/1

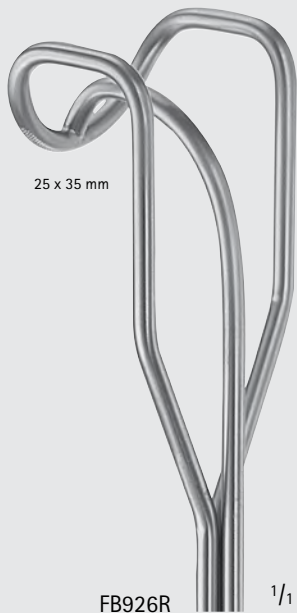

25 x 35 mm

FB926R 1/1

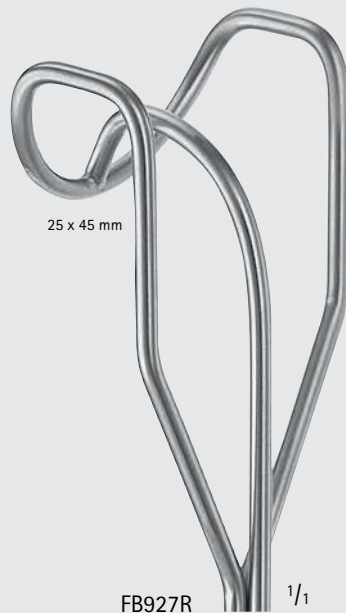

25 x 45 mm

FB927R 1/1

# Cardiovascular

## Retractors

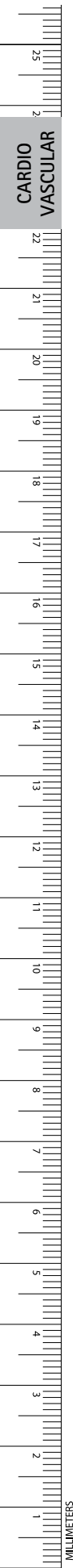

**COOLEY Atrium Retractor, Right**

Catalog Number	Blade Size (mm)	Length (in.)
FB963R	25 x 20	9 1/4
FB964R	40 x 25	9 1/4
FB965R	40 x 30	9 1/4
FB966R	40 x 35	9 1/4
FB967R	40 x 45	9 1/4
FB968R	50 x 35	9 1/4

FB963R-FB968R



25 x 20 mm

FB963R 1/1

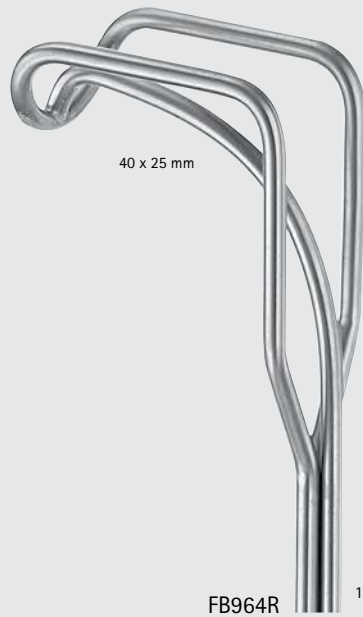

40 x 25 mm

FB964R 1/1

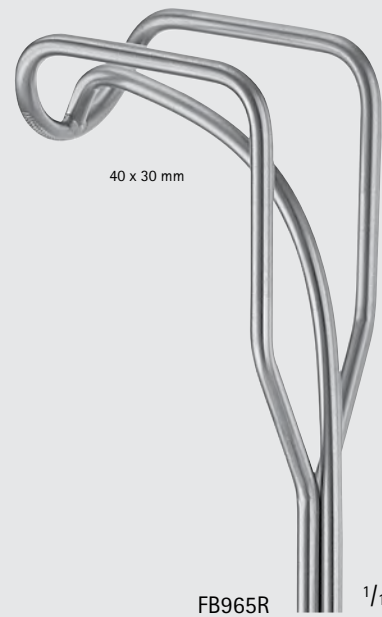

40 x 30 mm

FB965R 1/1



40 x 35 mm

FB966R 1/1

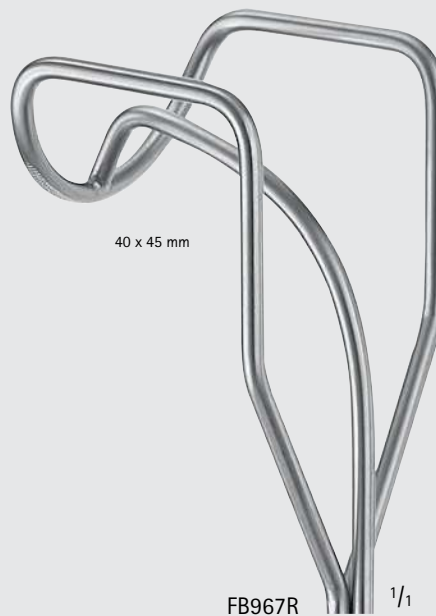

40 x 45 mm

FB967R 1/1

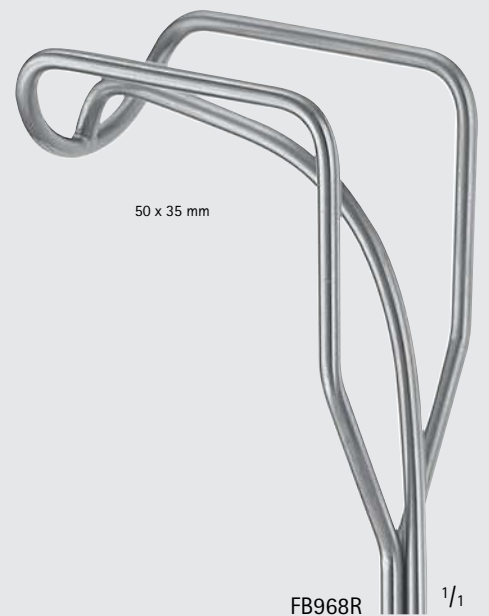

50 x 35 mm

FB968R 1/1

COOLEY Atrial Retractor, Right

Catalog Number	Blade Size (mm)	Length (in.)
MB383R	22 x 19	9 1/4
MB385R	29 x 19	9 1/4
MB386R	38 x 38	9 1/4
MB387R	48 x 44	9 1/4

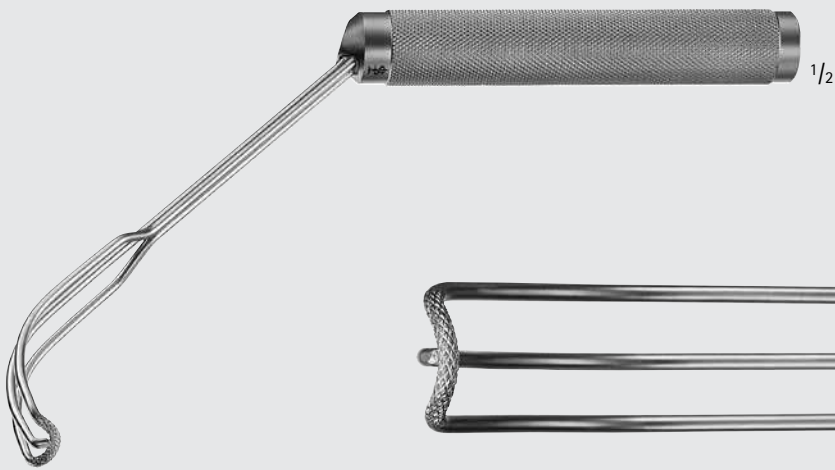

MB383R-MB387R

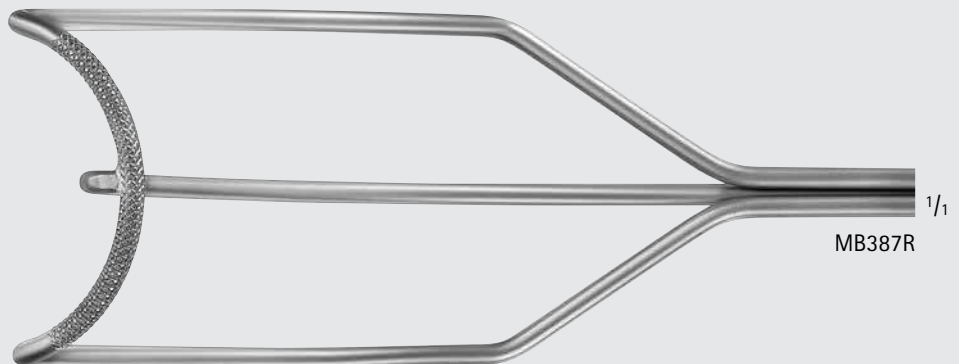
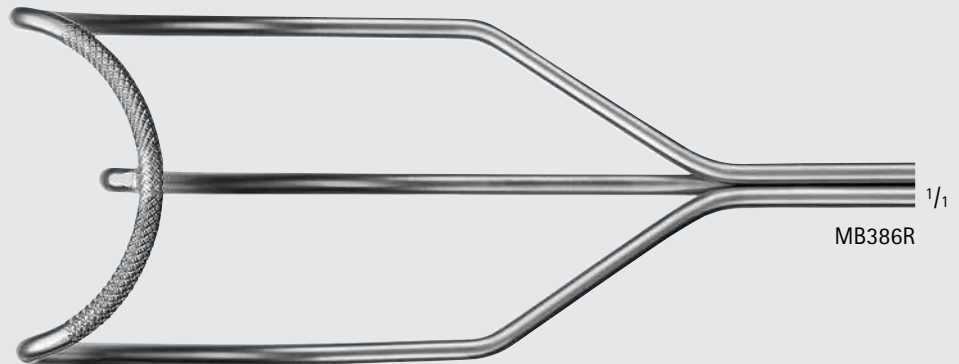
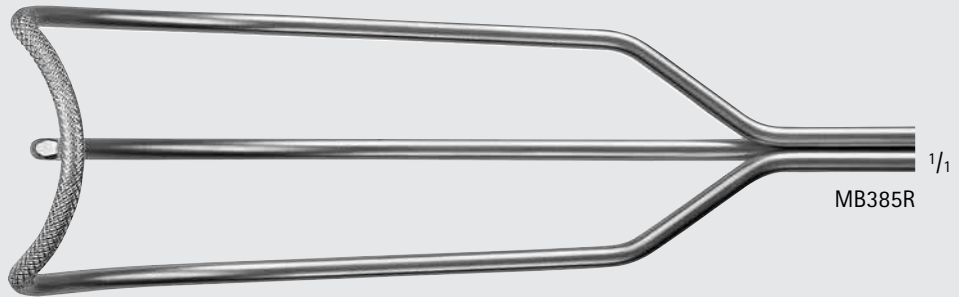
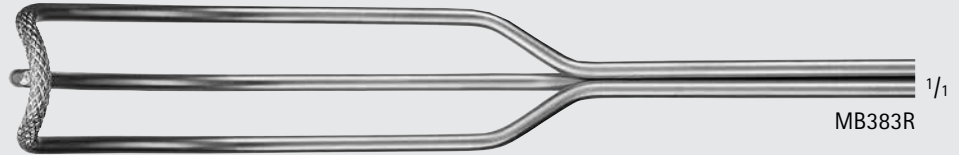

# Cardiovascular

## Retractors

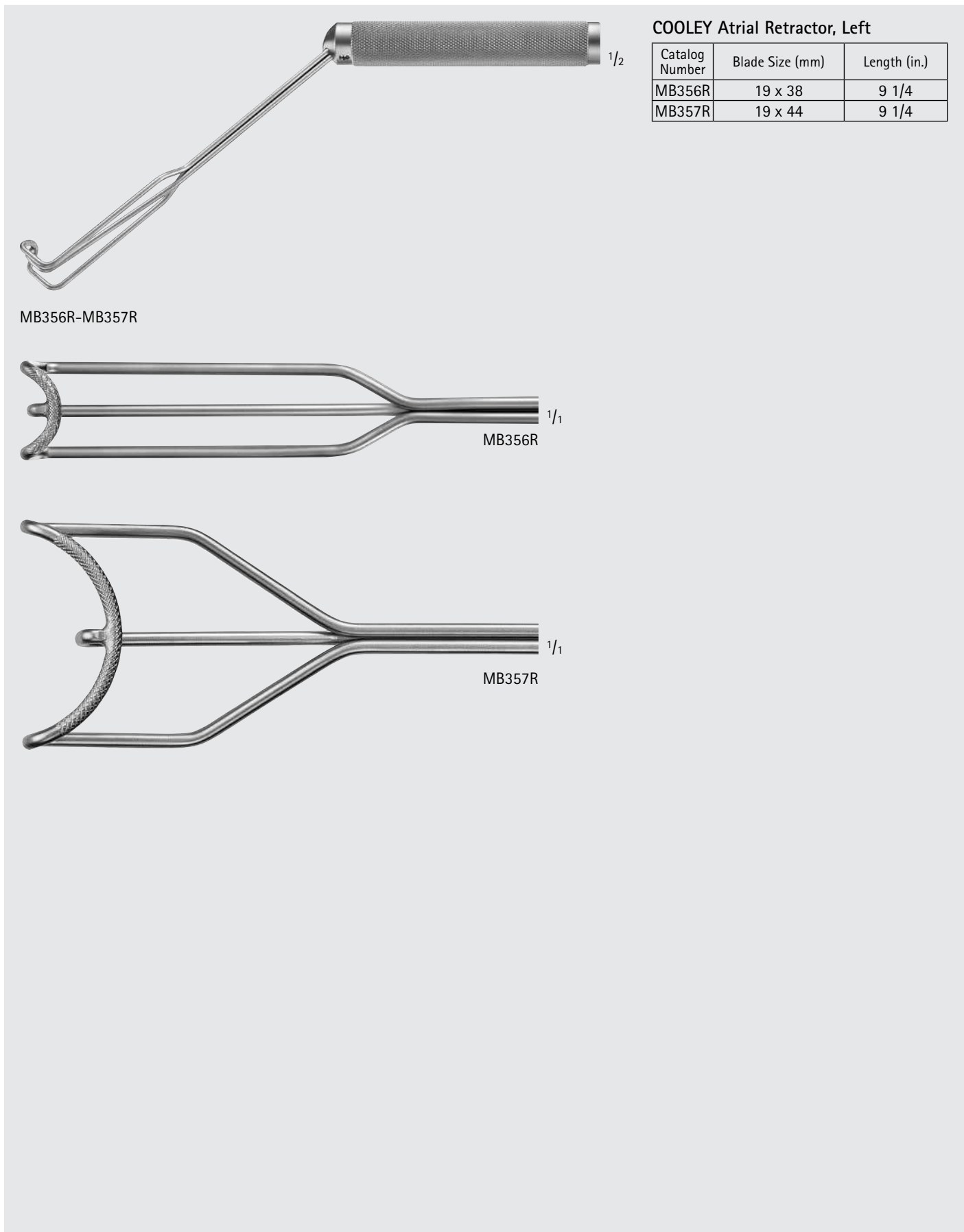
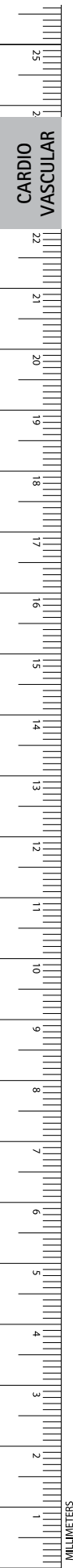

**COOLEY Atrial Retractor, Left**

Catalog Number	Blade Size (mm)	Length (in.)
MB356R	19 x 38	9 1/4
MB357R	19 x 44	9 1/4

MB356R-MB357R

1/1  
MB356R

1/1  
MB357R

**KRASKY Retractor**

Catalog Number	Blade End	Tip	Blade Size (mm)	Length (in.)
MG067R	6 PRONGS	SHARP	51 x 25	11

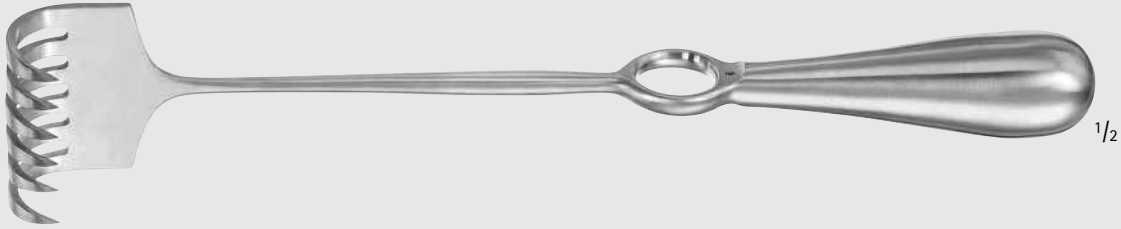

1/2

MG067R



1/1

MG067R

CARDIO  
VASCULAR

INCHES

# Cardiovascular

## Retractors

### CORYLLOS Retractor

Catalog Number	Blade Size (mm)	Length (in.)
BT521R	80 x 20	10
BT522R	115 x 38	10
BT523R	115 x 65	10

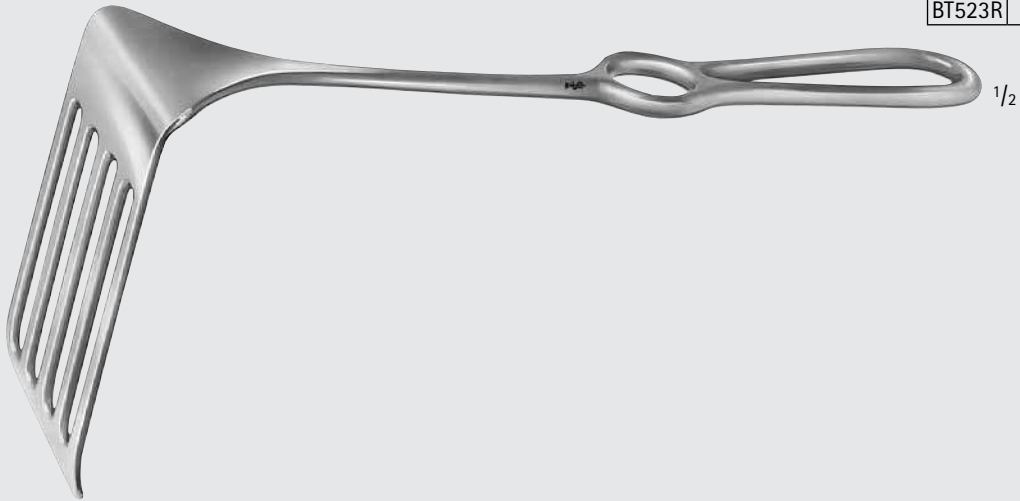

BT521R-BT523R

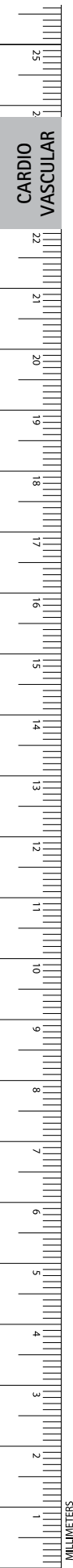
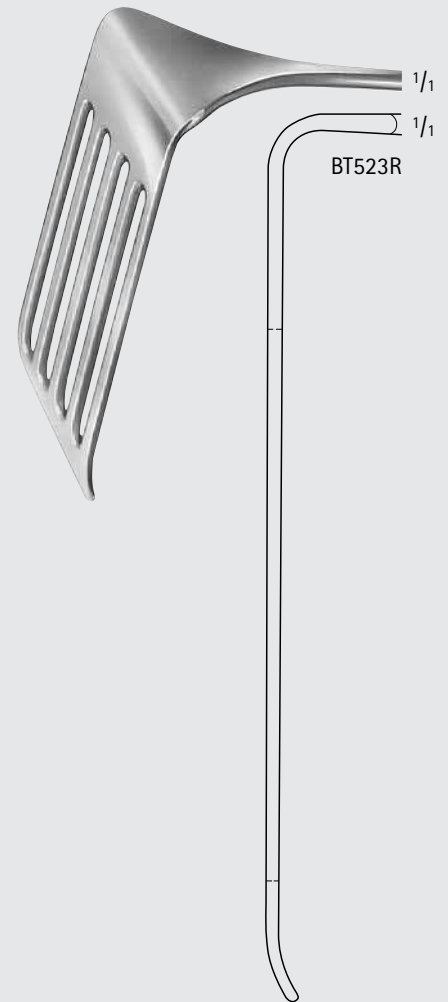
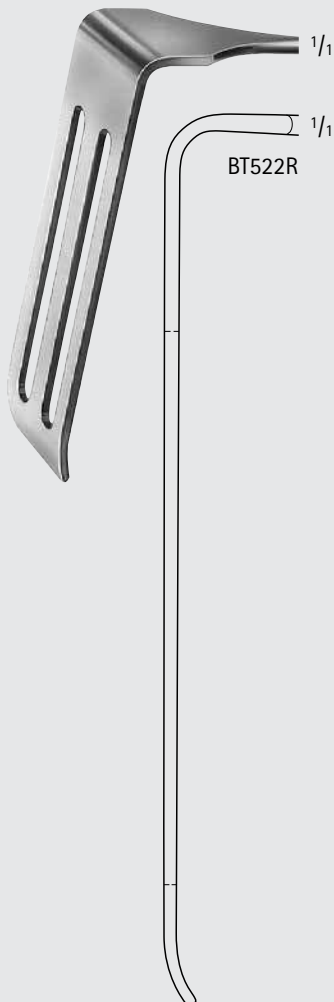



DAVIDSON Scapula Retractor

Catalog Number	Blade Size (mm)	Length (in.)
MB758R	80 x 50	7 3/4
BT531R	90 x 80	7 3/4

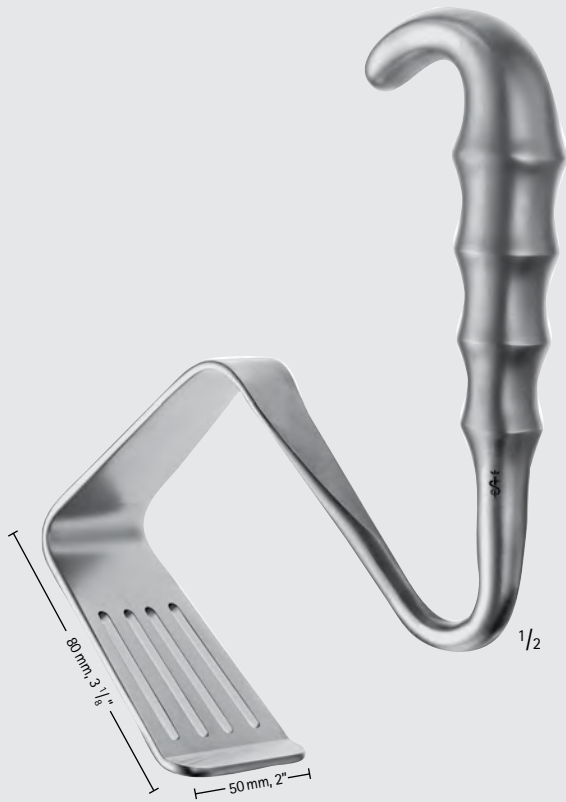

MB758R

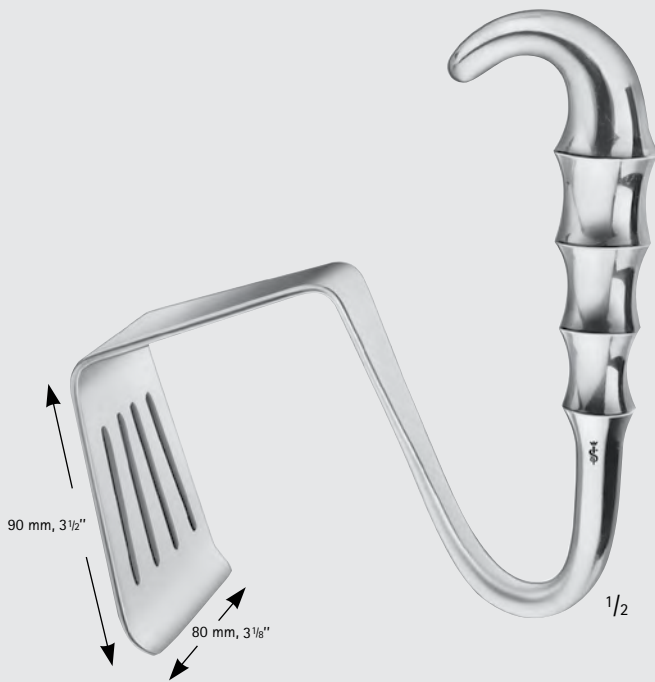

BT531R



INCHES

# Cardiovascular Retractors

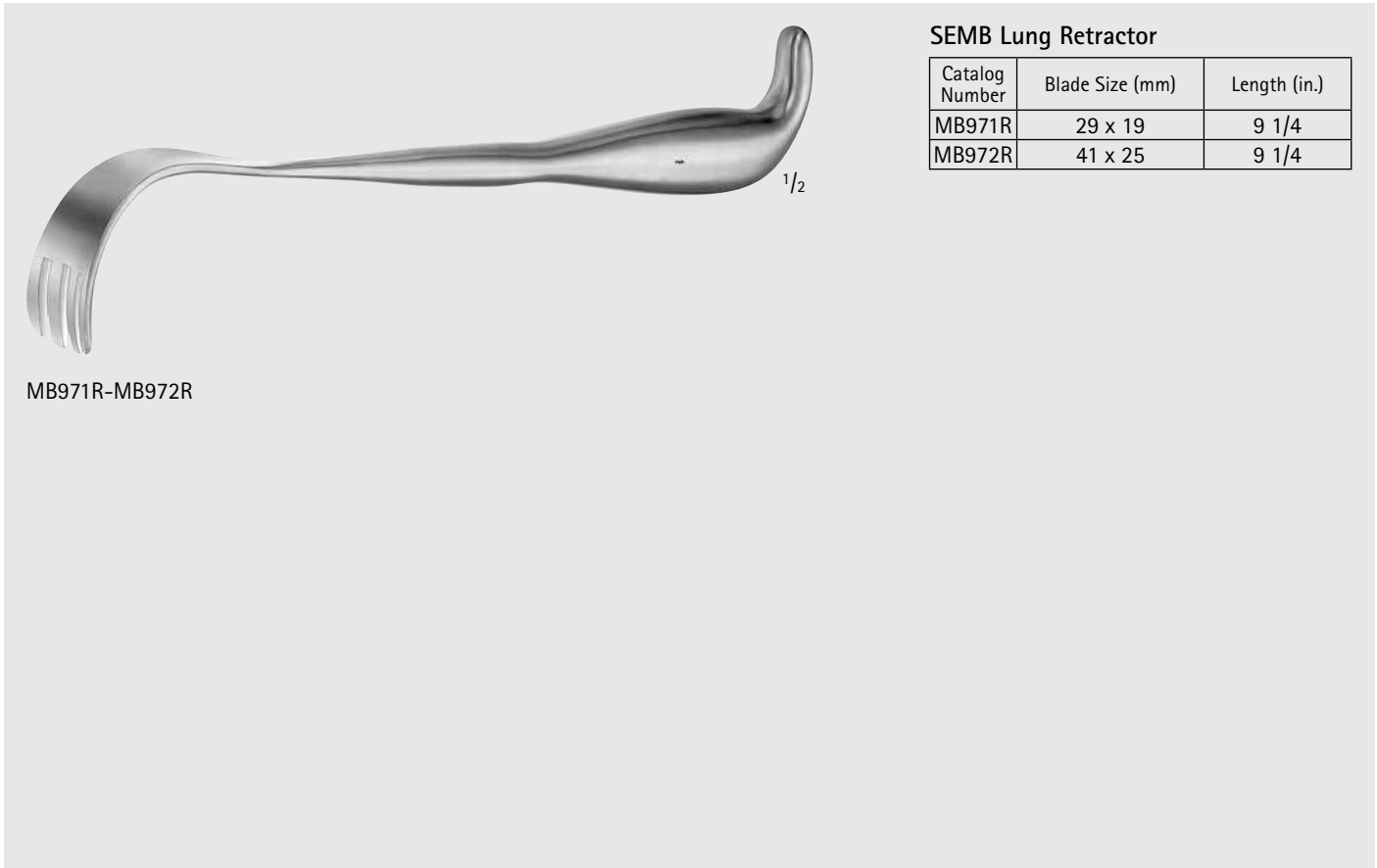
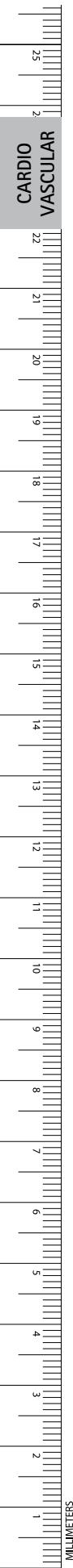

### SEMB Lung Retractor

Catalog Number	Blade Size (mm)	Length (in.)
MB971R	29 x 19	9 1/4
MB972R	41 x 25	9 1/4

MB971R-MB972R

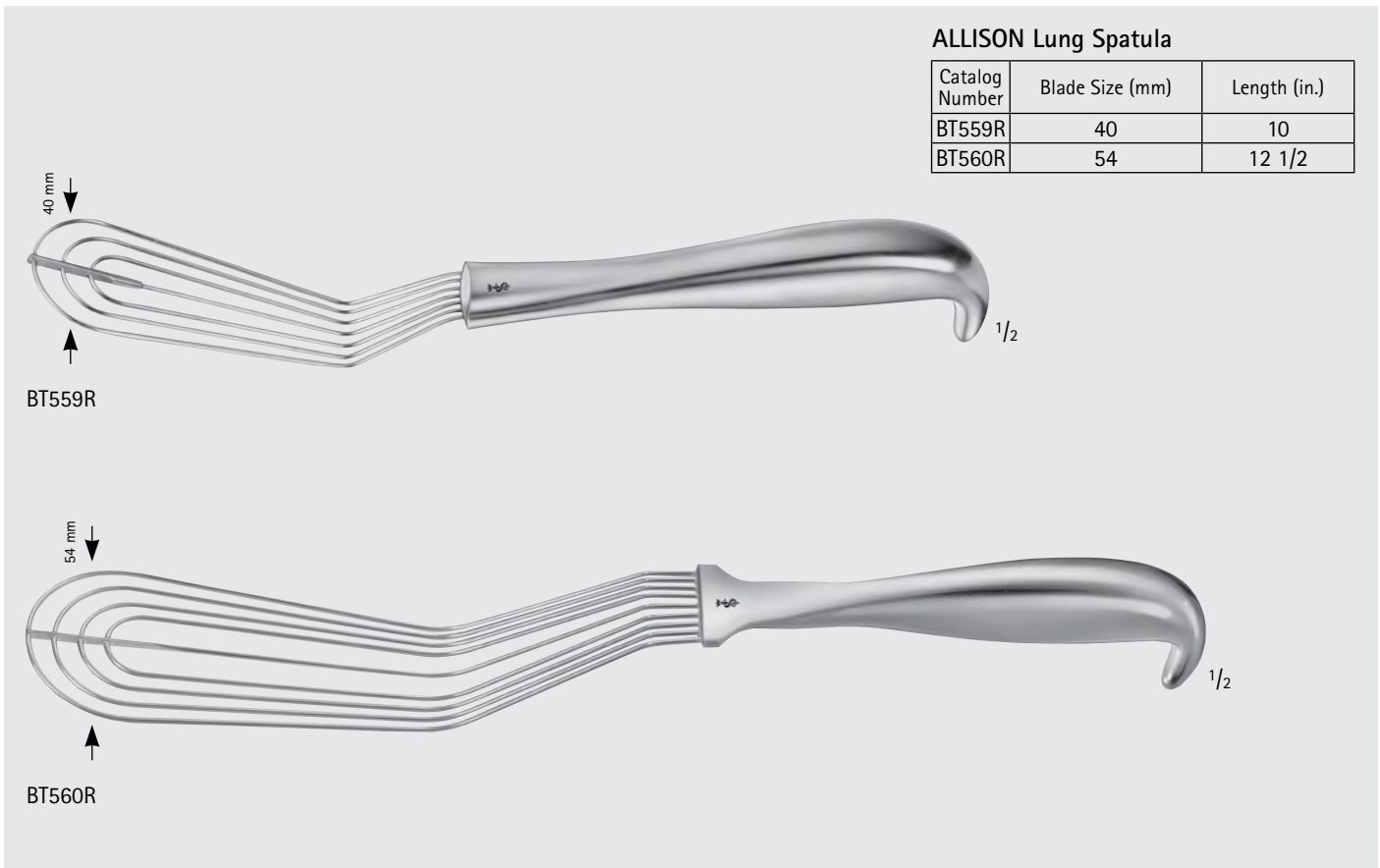

### ALLISON Lung Spatula

Catalog Number	Blade Size (mm)	Length (in.)
BT559R	40	10
BT560R	54	12 1/2

BT559R

BT560R

ALLISON "Sweetheart" Lung Spatula

Catalog Number	Blade Size (mm)	Length (in.)
BT561R	137	11 3/4

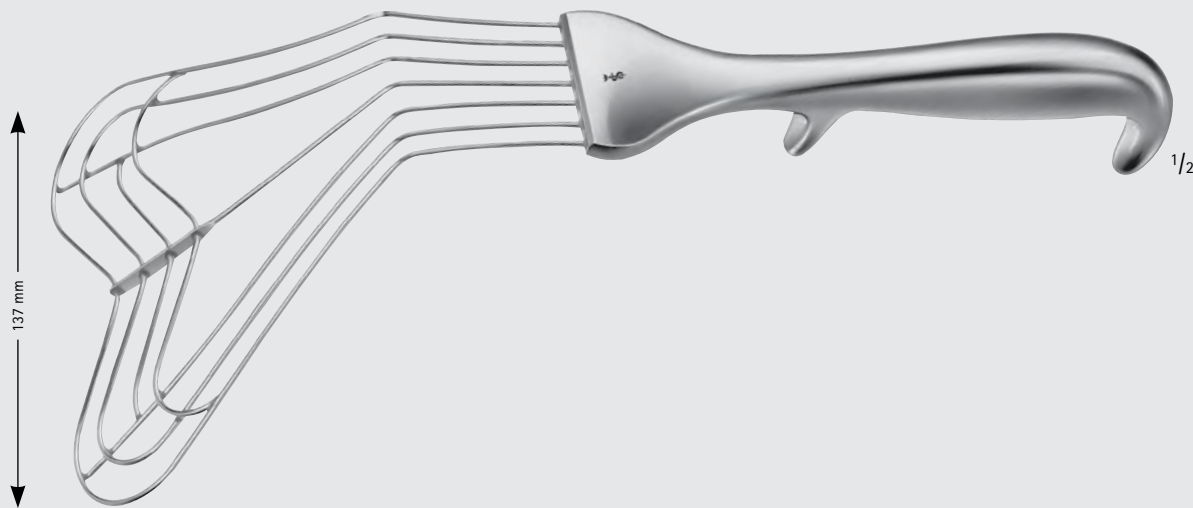

BT561R

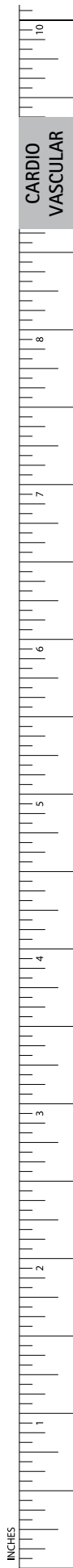

# Cardiovascular

## Rib Spreaders

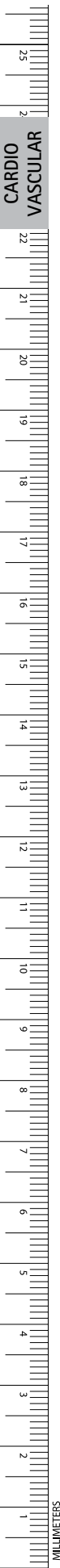

Dimensions for blade size of rib spreaders:  
 1st number = Depth  
 2nd number = Width  
 Example: 38 x 45 mm

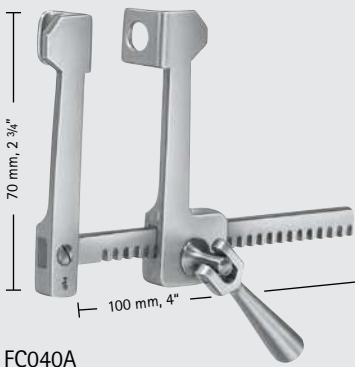

FC040A

**FINOCHIETTO Rib Spreader, Aluminum**

Catalog Number	Blade Size (mm)
FC040A	12 x 15

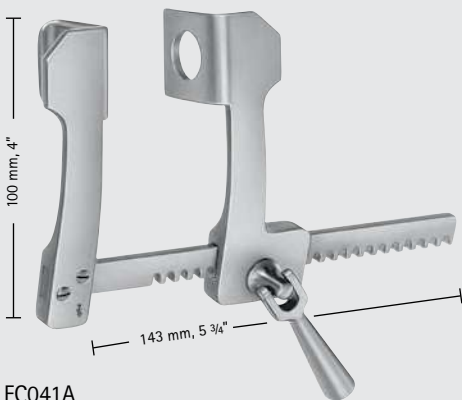

FC041A

**FINOCHIETTO-HAIGHT Rib Spreader, Aluminum**

Catalog Number	Blade Size (mm)
FC041A	28 x 30

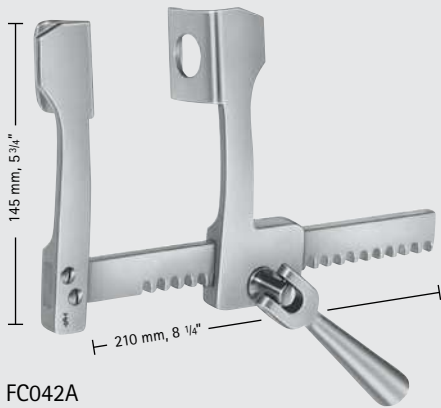

FC042A

**FINOCHIETTO Rib Spreader, Aluminum**

Catalog Number	Blade Size (mm)
FC042A	31 x 45

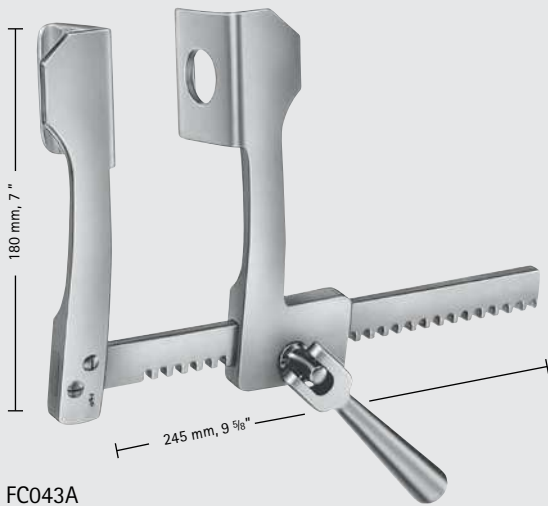

FC043A

**FINOCHIETTO Rib Spreader, Aluminum**

Catalog Number	Blade Size (mm)
FC043A	42 x 61

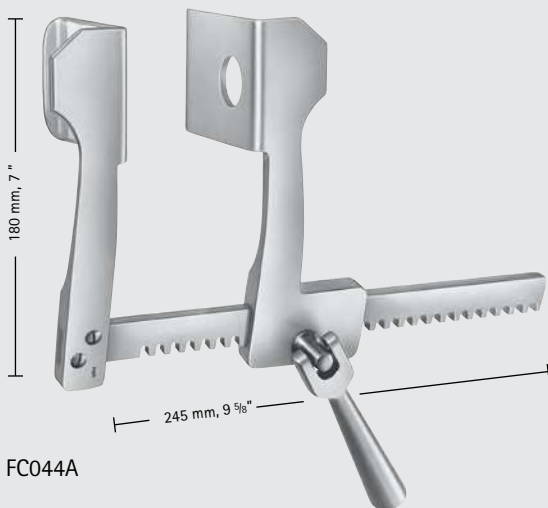

FC044A

**FINOCHIETTO Rib Spreader, Aluminum**

Catalog Number	Blade Size (mm)
FC044A	74 x 64

# Cardiovascular

## Rib Spreaders

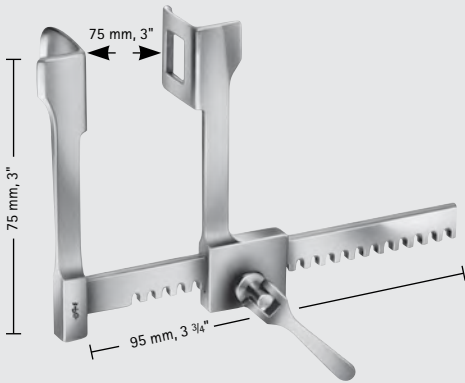

FB830R

### FINOCHIETTO Rib Spreader, Infant

Catalog Number	Blade Size (mm)
FB830R	18 x 21

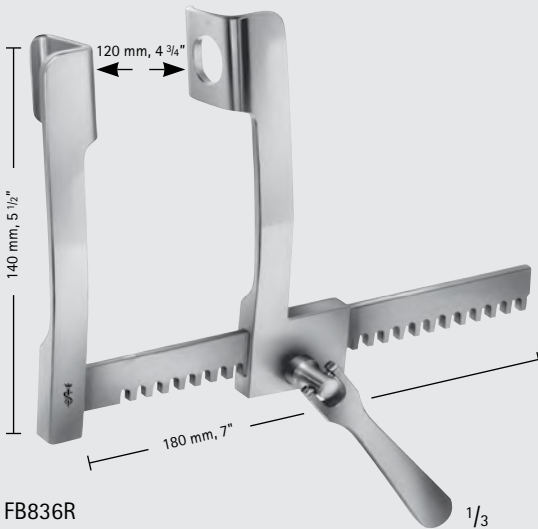

FB836R

### FINOCHIETTO Rib Spreader, Pediatric

Catalog Number	Blade Size (mm)
FB836R	28 x 32

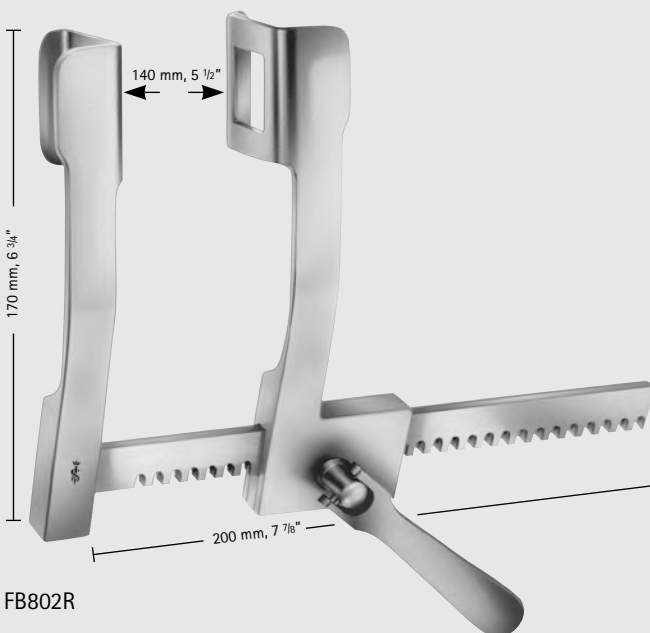

FB802R

### FINOCHIETTO Rib Spreader, Small Adult

Catalog Number	Blade Size (mm)
FB802R	36 x 45

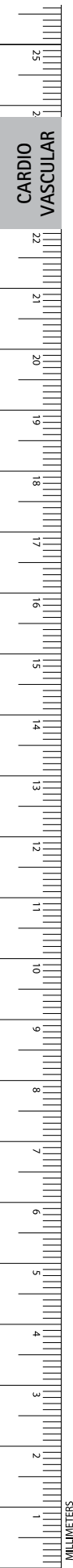

FINOCHIETTO Rib Spreader, Adult

Catalog Number	Blade Size (mm)
FB803R	44 x 65
FB804R	65 x 65

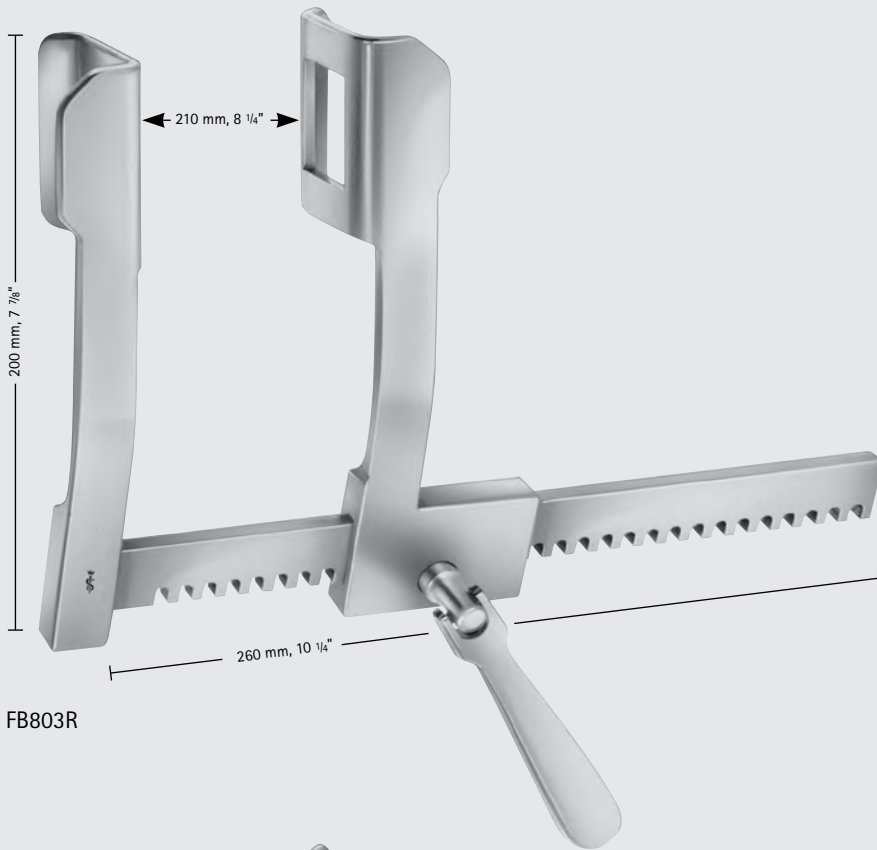

FB803R

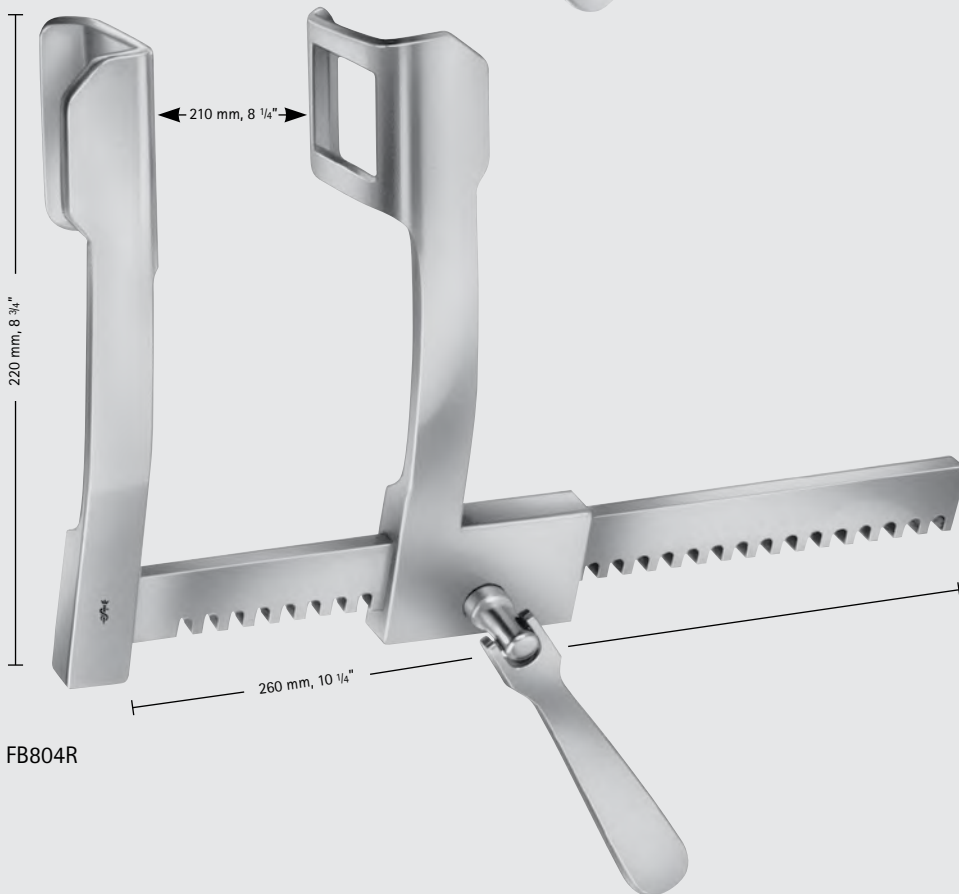

FB804R



# Cardiovascular

## Rib Spreaders

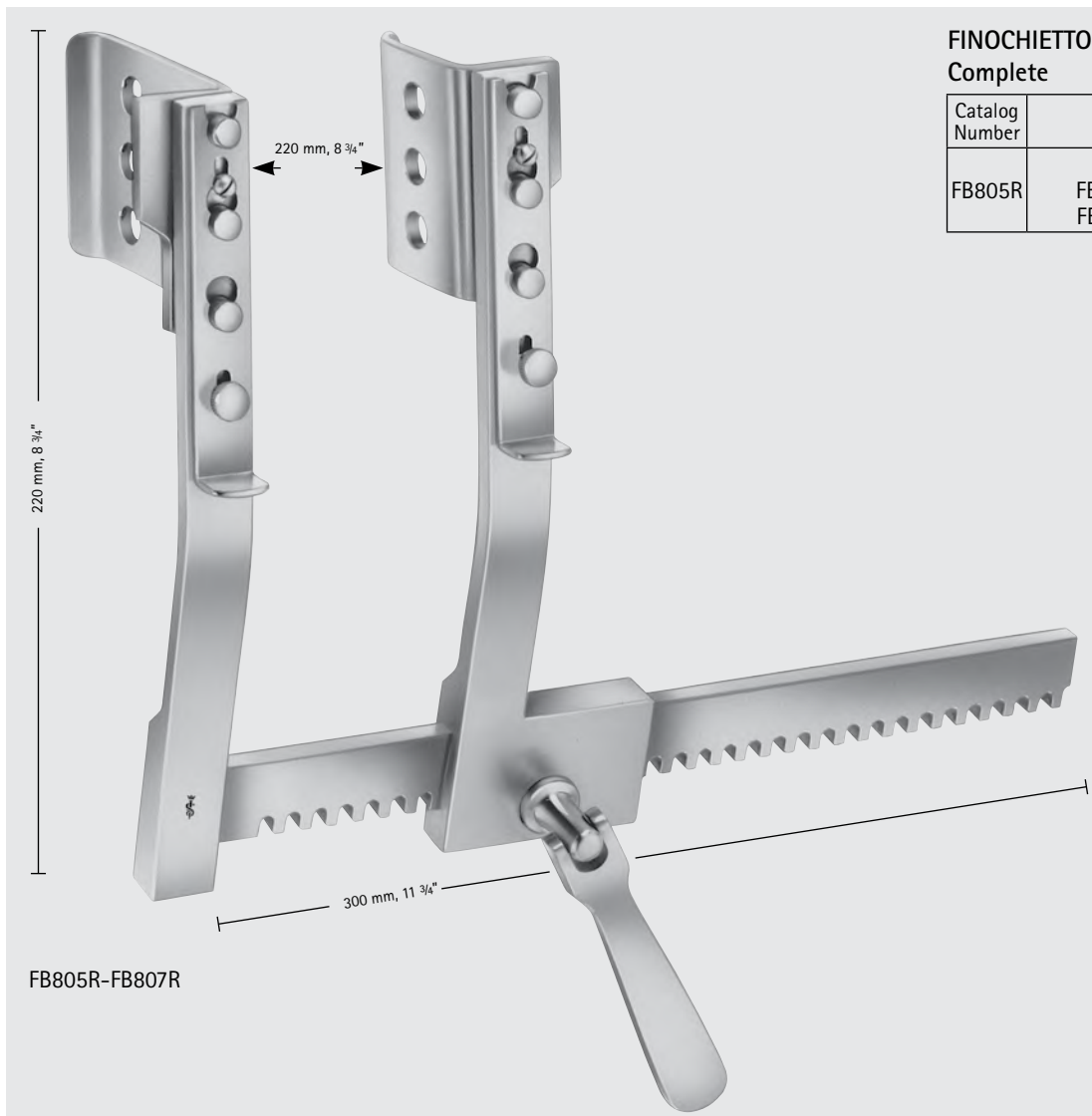
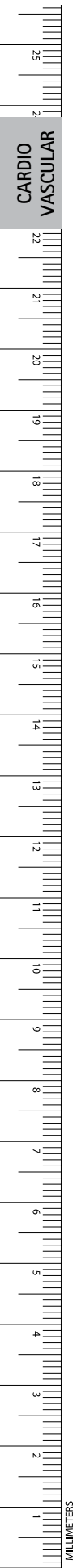

**FINOCHIETTO-BURFORD Rib Spreader, Complete**

Catalog Number	Description
FB805R	COMPLETE, W/ BLADES FB806R (45 MM x 64 MM) FB807R (75 MM x 64 MM)

FB805R-FB807R

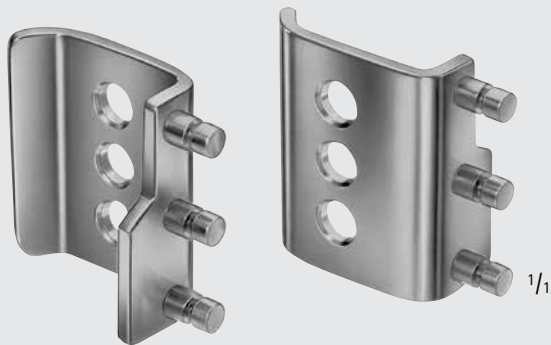

FB806R



FB807R



**HAIGHT Rib Spreader**

Catalog Number	Blade Size (mm)
FB835R	30 x 30

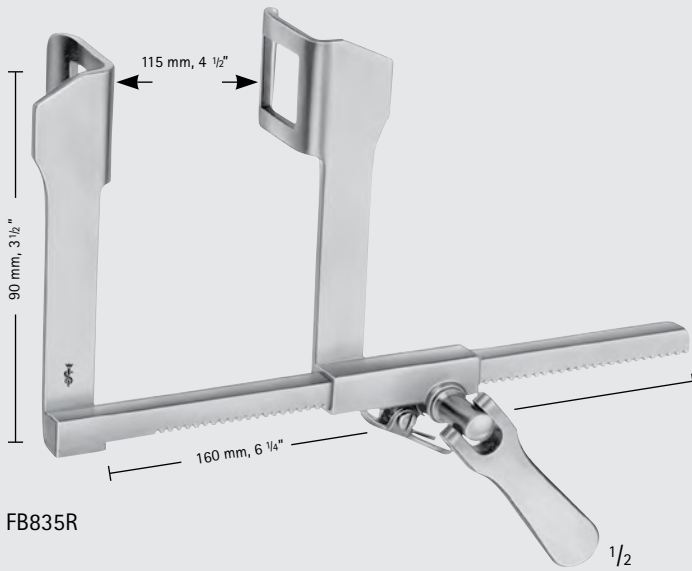

**Rib Spreader, Premie**

Catalog Number	Blade Size (mm)	Description
MG062R	7 x 7	SPREAD 1 1/2", ARM LENGTH 1 1/2"

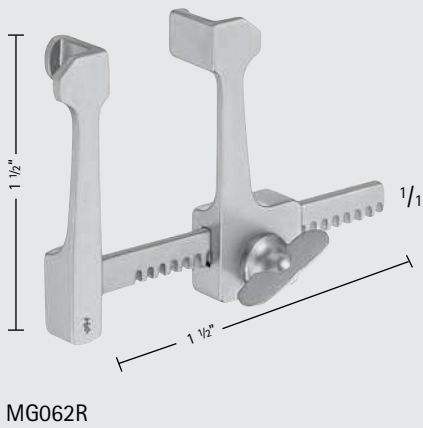

# Cardiovascular

## Rib Spreaders

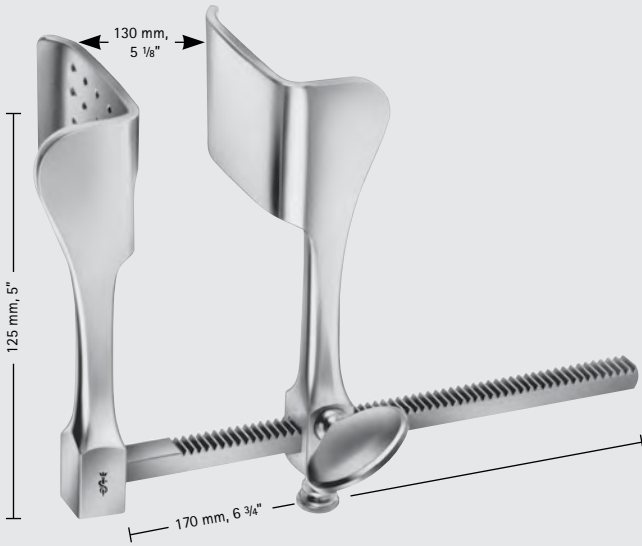
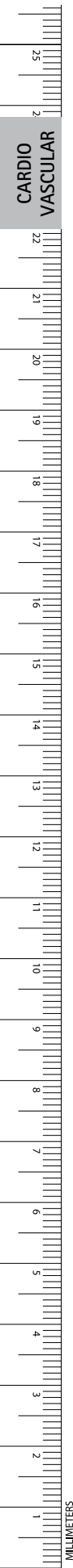

FB800R

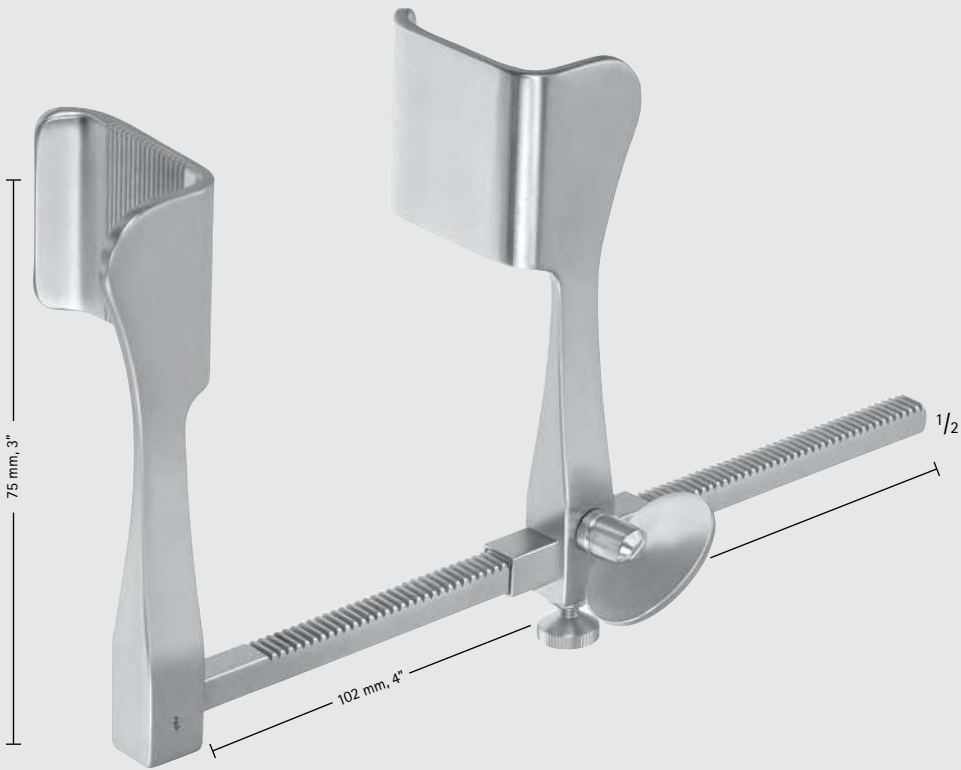

MG061R

### TUFFIER Rib Spreader

Catalog Number	Blade Size (mm)	Blade End
FB800R	43 x 53	RIBBED
MG061R	45 x 47	SERR

**BAILEY Rib Contractor**

Catalog Number	Description	Length (in.)
FB844R	PEDIATRIC	6
FB841R	SMALL ADULT	7 7/8
FB842R	ADULT	7 7/8



FB844R

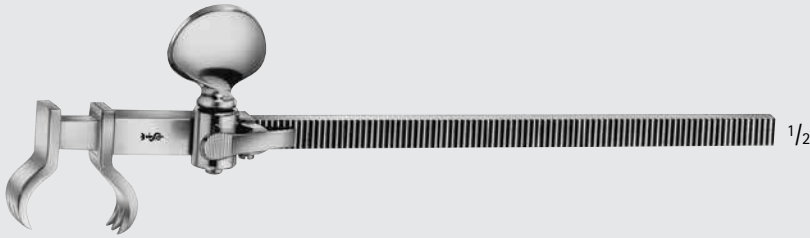
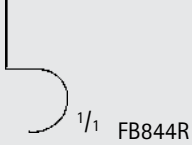

FB841R-FB842R



FB841R



FB841R



FB842R

**FAVALORO-MORSE Sternal Retractor**

Catalog Number	Blade Size (mm)
MG015R	40 x 29



MG015R



# Cardiovascular

## Rib Spreaders

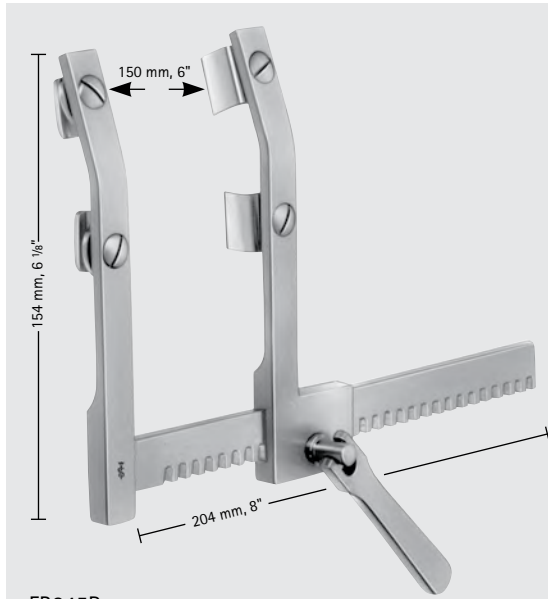
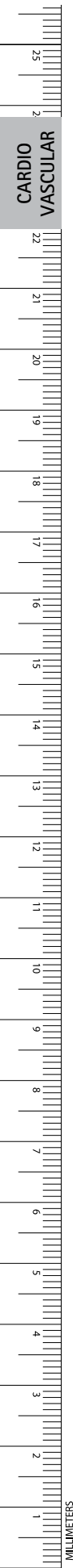

FB845R

### MORSE Sternotomy Retractor, Pediatric

Catalog Number	Blade Size (mm)
FB845R	12 x 20

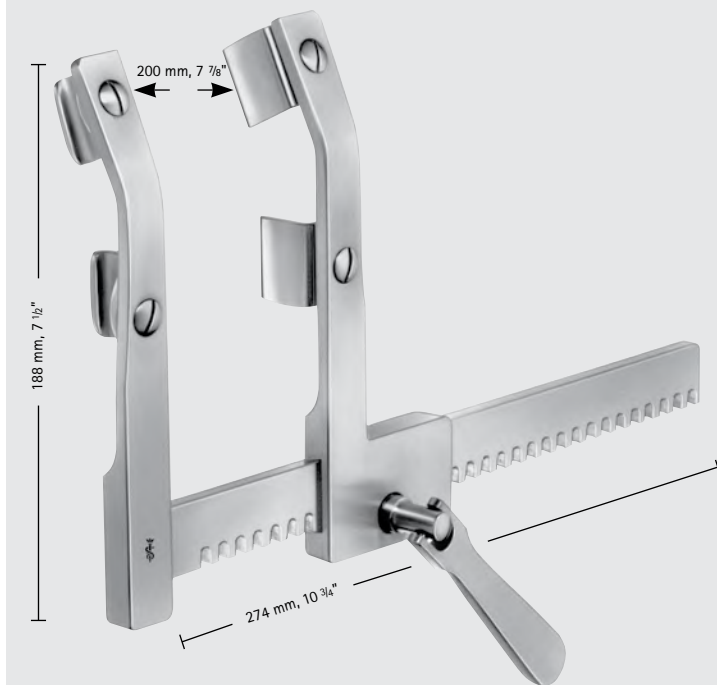

FB846R

### MORSE Sternotomy Retractor, Adult

Catalog Number	Blade Size (mm)
FB846R	19 x 29

REINHOFF Rib Spreader

Catalog Number	Blade Size (mm)
MG063R	45 x 50

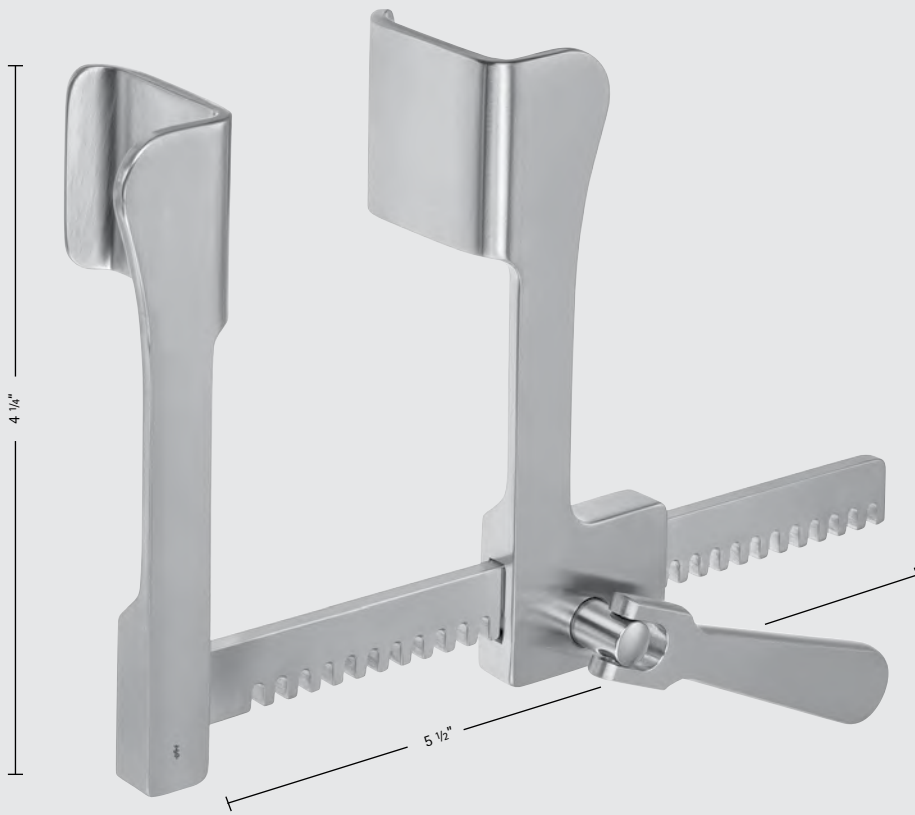

MG063R

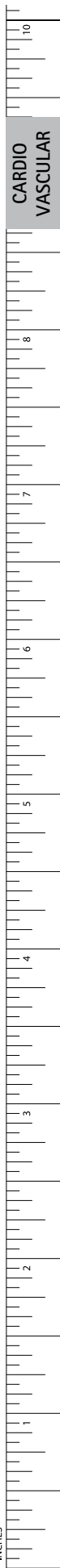

# Cardiovascular

## Rib Spreaders

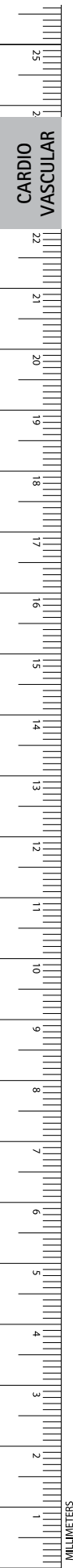

COOLEY Sternotomy Spreader, Pediatric

Catalog Number	Blade Size (mm)
FB851R	21 x 45

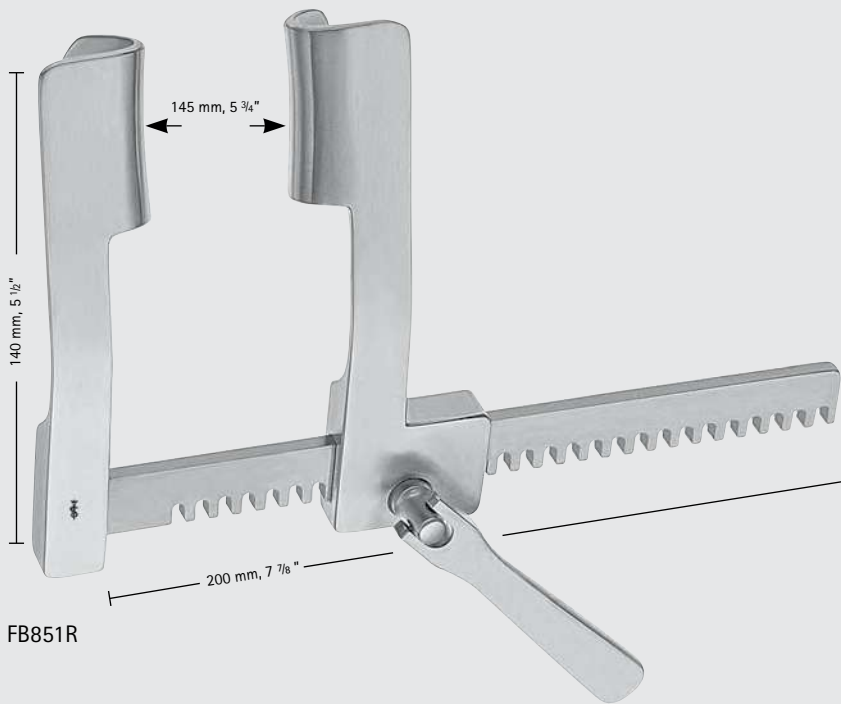

FB851R



FB851R

COOLEY Sternotomy Spreader, Adult

Catalog Number	Blade Size (mm)
FB850R	32 x 50

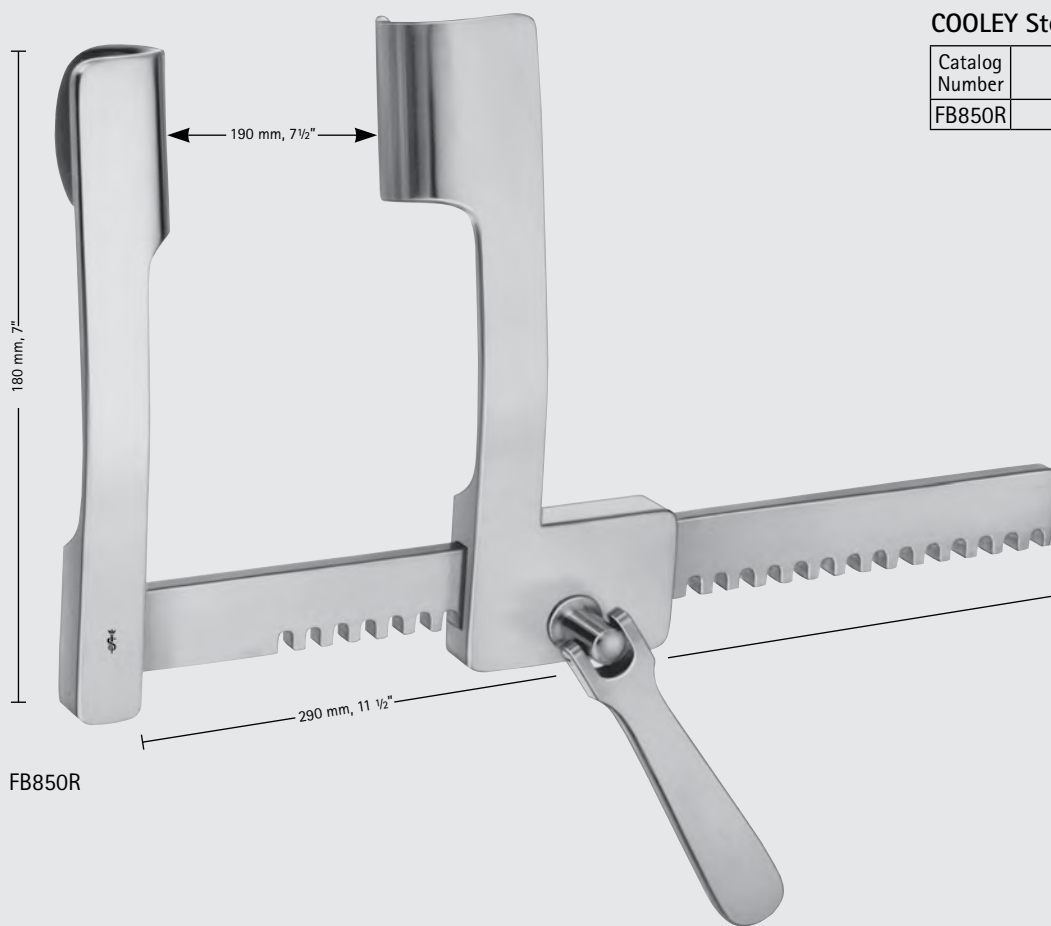

FB850R

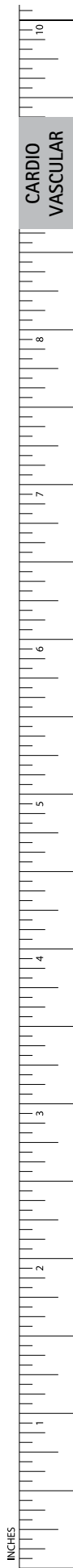

# Cardiovascular

## Rib Spreaders

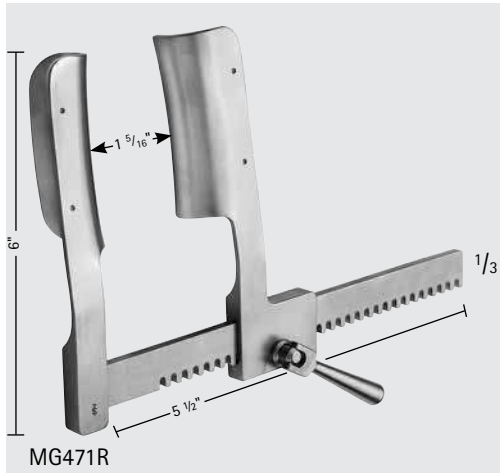
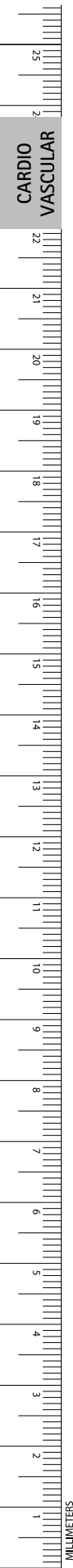

**COOLEY Sternotomy Spreader, Extra Large**

Catalog Number	Blade Size (mm)
MG471R	35 x 100



**COOLEY Sternal Retractor, Aluminum, Pediatric**

Catalog Number	Blade Size (mm)
MG016R	17 x 19 W/ PINS

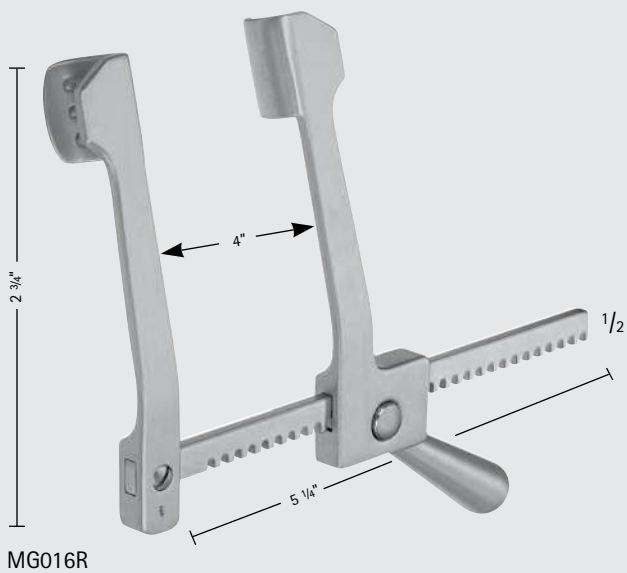



Sternal Retractor

Catalog Number	Blade Size (mm)	Description
MG017R	12 x 10	DOUBLE BLADES 12 x 10 MM
MG018R	14 x 14	DOUBLE BLADE 14 x 14 MM
MG019R	20 x 19	DOUBLE BLADE 20 x 19 MM

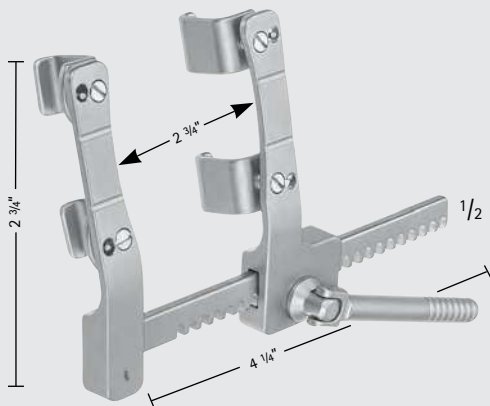

MG017R

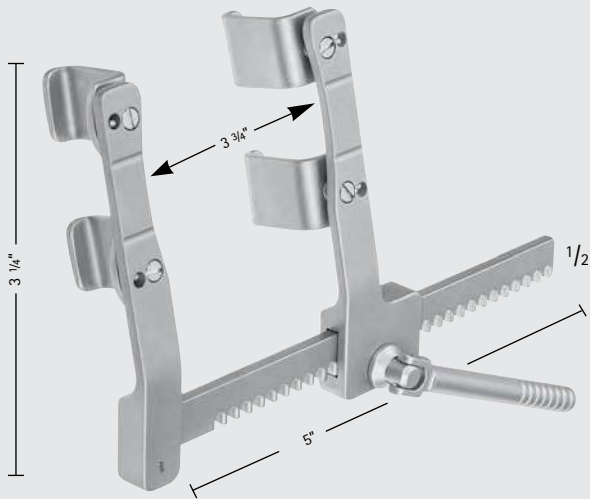

MG018R

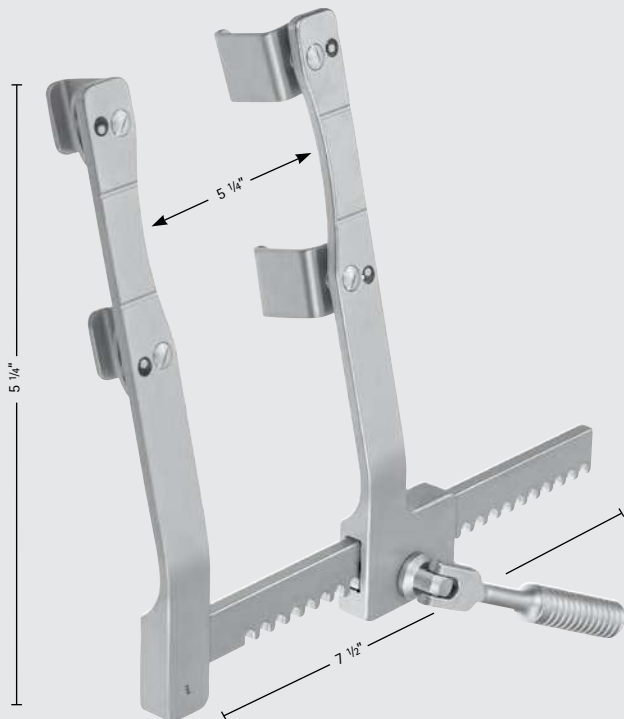

MG019R



Cardiovascular  
Rib Spreaders

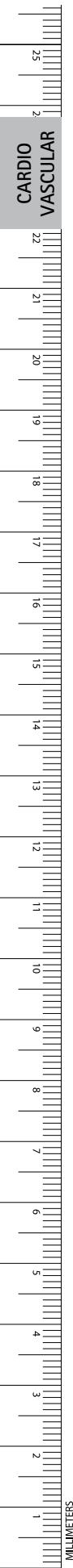

CHAUX Sternal Retractor

Catalog Number	Blade Size (mm)	Description
MG020R	27 x 30	ROTATION FOR IMA EXPOSURE

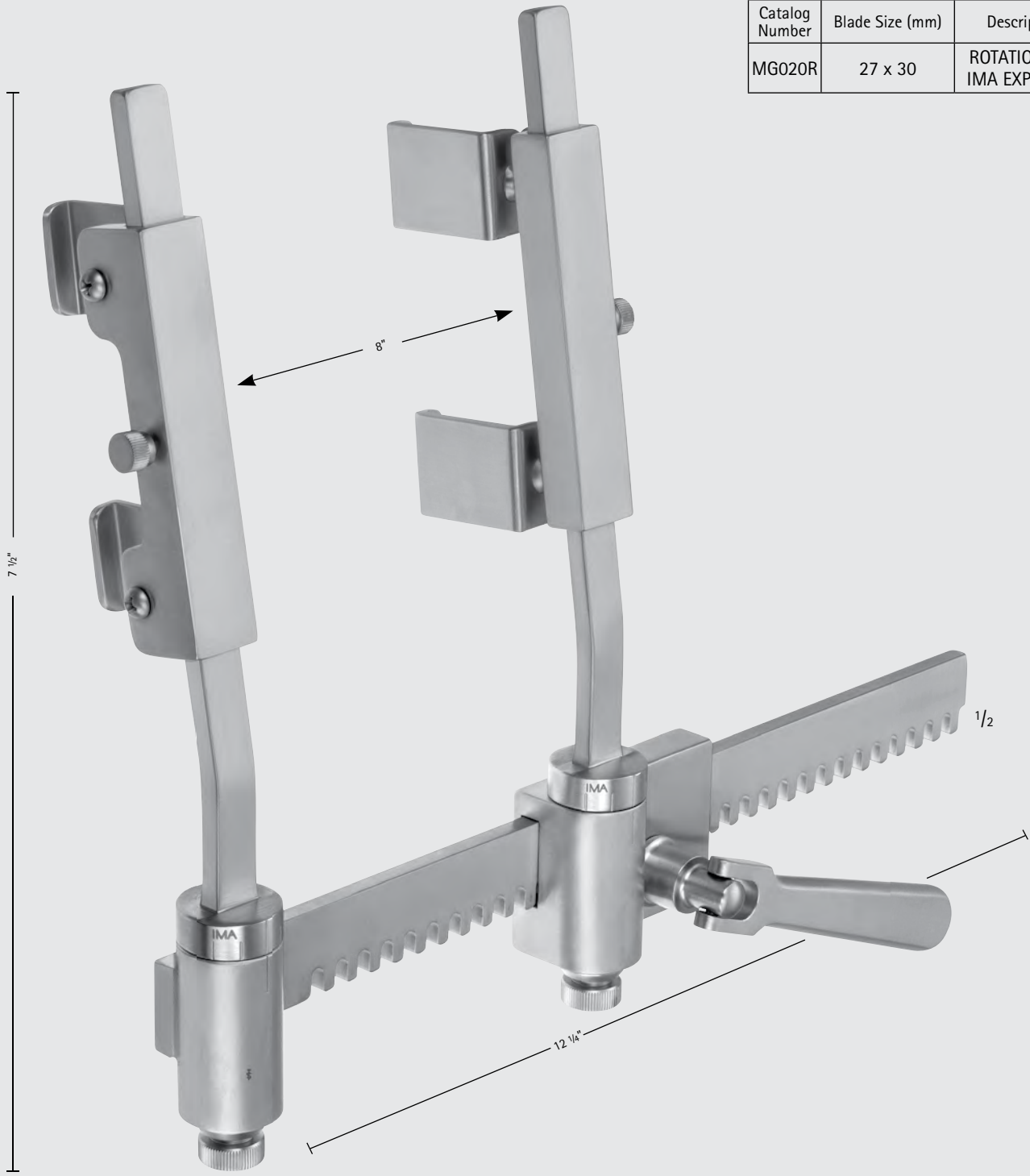

MG020R

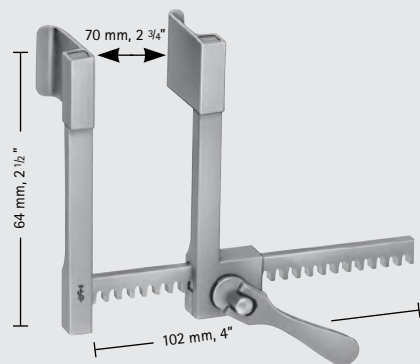

FB852R



FB854R



FB855R



FB856R



FB857R



FB858R

**STRUCK Rib Spreader, Infant**

Catalog Number	Description
FB852R	COMPLETE
FB853R	SPREADER ONLY, 64 x 92 MM
FB854R	OPT. BLADES, 10 x 10 MM, 2/SET
FB855R	OPT. BLADES, 10 x 15 MM, 2/SET
FB856R	OPT. BLADES, 10 x 20 MM, 2/SET
FB857R	BLADES, 15 x 20 MM, 2/SET
FB858R	BLADES, 20 x 20 MM, 2/SET

FB852R Includes:  
FB853R Spreader only  
FB857R Blades (pair)  
FB858R Blades (pair)

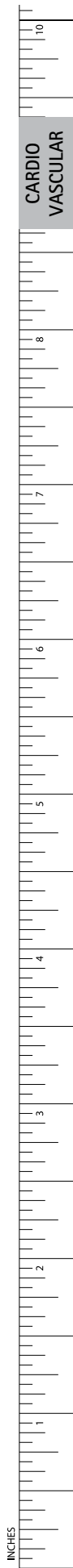

INCHES



## *Manufacturing Unit -*

***115-A Waryana Industrial Complex, Leather Complex Road,  
Jalandhar Punjab, 144021***



## *Sales Office -*

***Plot No. 581- Kakrola Housing Complex, Near Metro Pillar 802,  
Dwarka Mor, Delhi, 110078***



## *Our Certifications -*

***UDYAM , ISO 13485, WHO-GMP, ISO 9001:2015, CE , ROHS,  
FDA , MD-42, MD-5***

### CONTACT US:



+91- 98141-81255, +91- 98142-62255



[www.alisprofessional.com](http://www.alisprofessional.com)



[info@royalinternational.org](mailto:info@royalinternational.org)