

SAFETY PRECAUTIONS

1. Make sure incoming pressure does not exceed the rated pressure.
2. Use proper eye protection when assembling and using the hose reel.
3. Assemble the hose reel on a clean workbench free of debris and moisture.
4. Use soap and water when checking for air leaks.
5. Keep children away from work area.

WARNING!

Exposure of skin directly to pressurized air or fluids could result in severe bodily injury!

Ref 300946 Rev. C
07-16

General Pump
1174 Northland Drive • Mendota Heights, MN 55120
Phone: 651.686.2199 • Fax: 800.535.1745
www.generalpump.com • email: sales@gpcompanies.com



DHRA50300

- FRICTION BRAKE
- DIRECT HAND-CRANK REWIND WITH LOCKING MECHANISM
- SOLID STEEL CONSTRUCTION
- DURABLE POWDERCOAT FINISH
- FULL FLOW SWIVEL STAINLESS SWIVEL

OPERATOR'S MANUAL

Ref 300946 Rev. C
07-16



General Pump
is a member of
The Interpump Group



INDUSTRIAL

HOSE

REELS

FROM GENERAL PUMP

DHRA50150

DHRA50300

DHRA50450

ASSEMBLY AND OPERATING INSTRUCTIONS

1. Connect the handle to the axle
2. Use 1/2" or 13 mm bolts when securing the hose reel to ceiling or wall.
3. Use thread sealant (not provided) on inlet threads and on outlet hose (not provided).
4. Attach hose reel hose to hose reel outlet in hub.
5. Attach pump hose to hose reel swivel.
6. The hose reel is ready for operation.

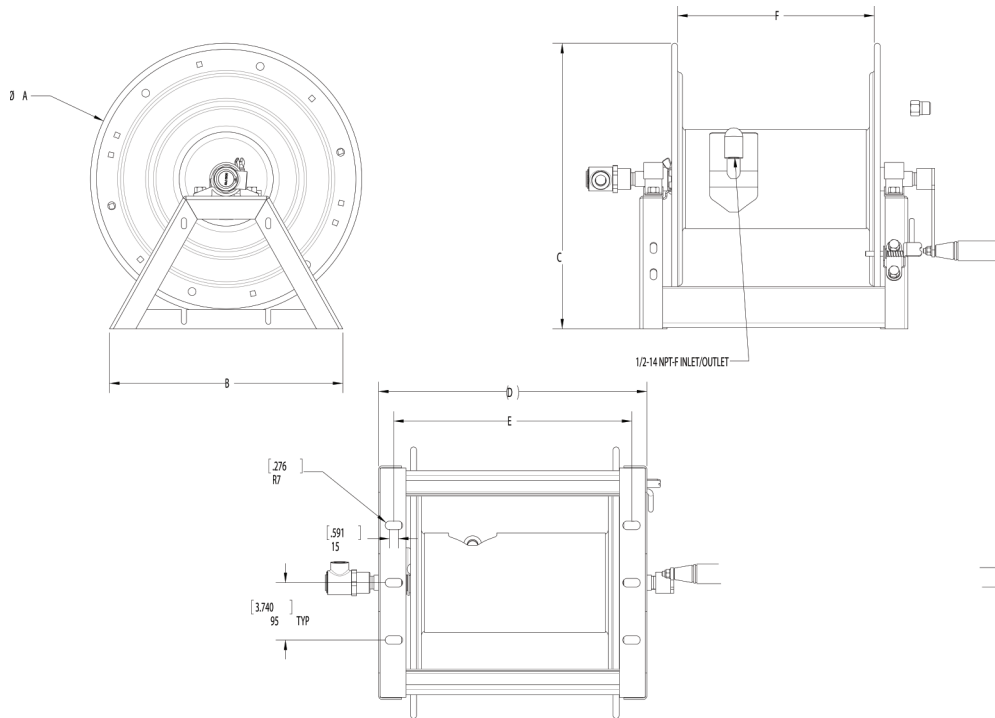

	Dimensions inches/mm					
	A	B	C	D	E	F
DHRA50150	17.7/450	15.2/387	18.6/473.6	12.4/315	10.4/264	7.7/196
DHRA50300	17.7/450	15.2/387	18.6/473.6	17.5/445	15.5/394	12.8/326
DHRA50450	17.7/450	15.2/387	18.6473.6	23.0/585	21.2/539	18.3466

Ref 300946 Rev. C
07-16

SPECIFICATIONS

Model	3/8" Hose Capacity	Swivel Pressure Rating	Inlet	Outlet
DHRA50150	150 Ft.	5,000 PSI	1/2" NPT-F	1/2" NPT-F
DHRA50300	300 Ft.	5,000 PSI	1/2" NPT-F	1/2" NPT-F
DHRA504500	450 Ft.	5,000 PSI	1/2" NPT-F	1/2" NPT-F

MAXIMUM TEMPERATURE RATING: 300°F

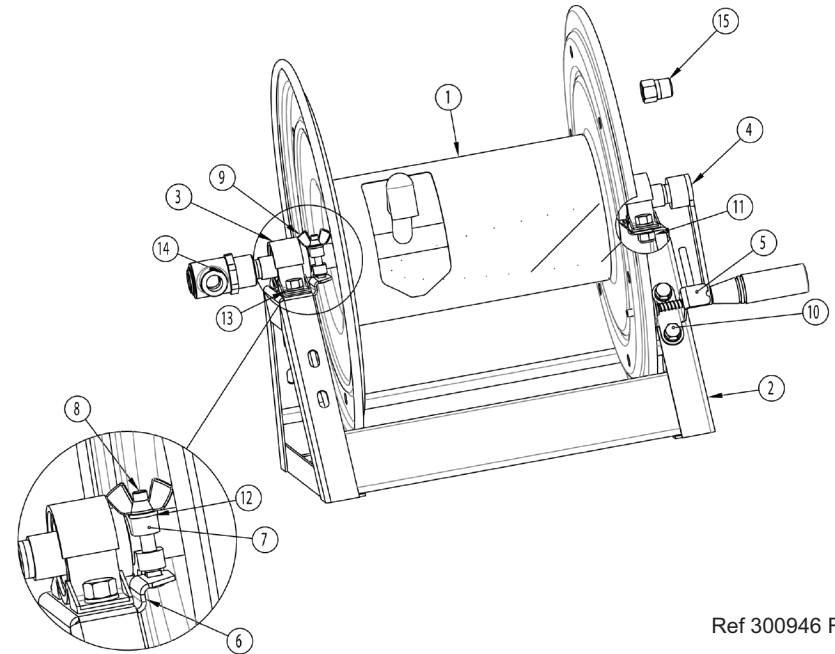

Ref 300946 Rev. C
07-16

PARTS LIST

Item	Part #	Description	QTY
1	2103282	ASSY, HUB & FLANGE, DHRA50450	1
	2103242	ASSY, HUB & FLANGE, DHRA50300	
	2103247	ASSY, HUB & FLANGE, DHRA50150	
2	2103283	FRAME, HOSE REEL, DHRA50450	1
	2103243	FRAME, HOSE REEL, DHRA50300	
	2103248	FRAME, HOSE REEL, DHRA50150	
3	2640025	PILLOW BLOCK	2
4	2103244	ASSY, CRANK	1
5	2103245	ASSY, LOCK PIN	1
6	2540087	BRACKET, BRAKE	1
7	2660268	BRAKE	1
8	2200103	BOLT, M8	1
9	2203018	NUT, WING, M8	1
10	2200104	BOLT, M10	6
11	2203017	NUT, M10, NYLOK, SST	6
12	2200013	WASHER, M8, SS	1
13	2203413	WASHER, FLAT, M10	12
14	2103246	SWIVEL	1
15	2530112	FITTING, 1/2NPT-MX3/8NPT-F	2
	2100278	REPAIR KIT	