

Fixed Flat Thermal Rooflight

Double Glazed 1.2 U-Value

TECHNICAL

Manufactured to:

BS EN – 12150

BS EN -1270

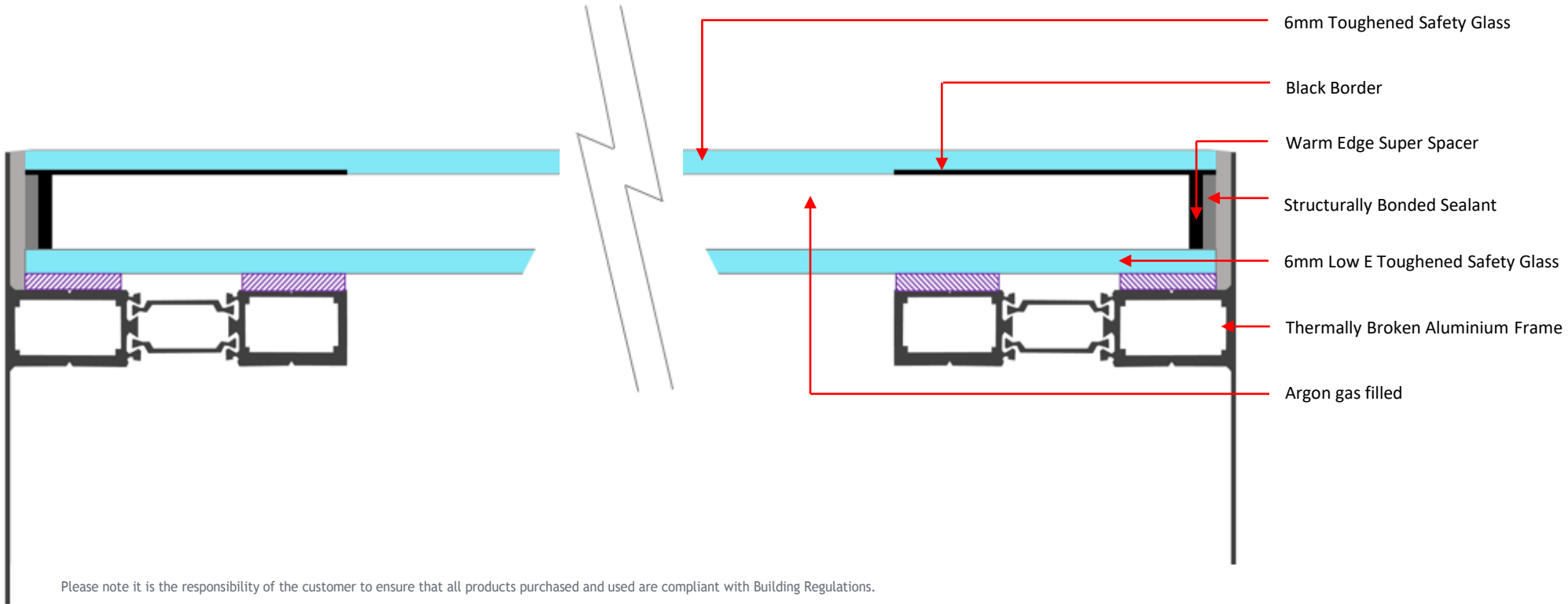

Option 1 (Fixing from Externally) Fixed Rooflight Installation Guide

Fixed Flat Thermal Rooflight Typical Installation Guide

Double Glazed

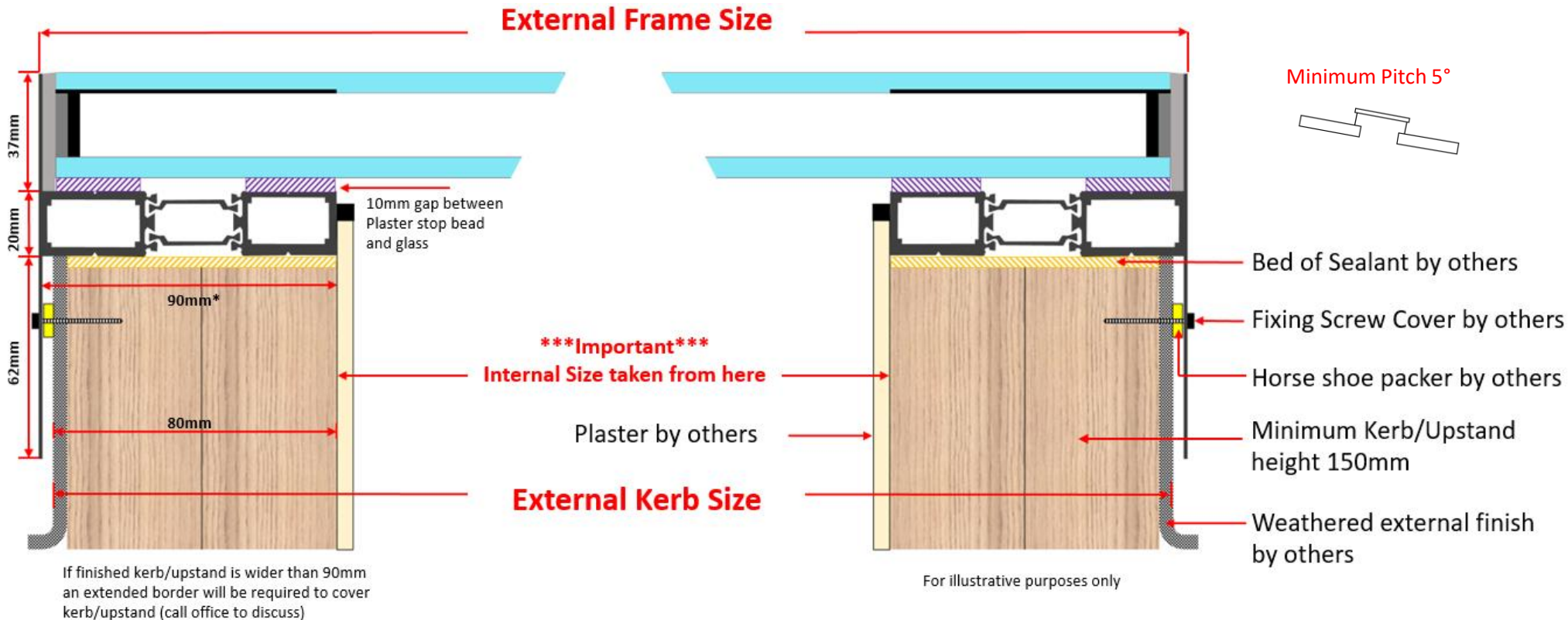

Option 1 (Fixing from Externally) Fixed Rooflight Installation Guide

- 1) Apply a thick bead of silicone all the way around the top of the timber upstand/kerb

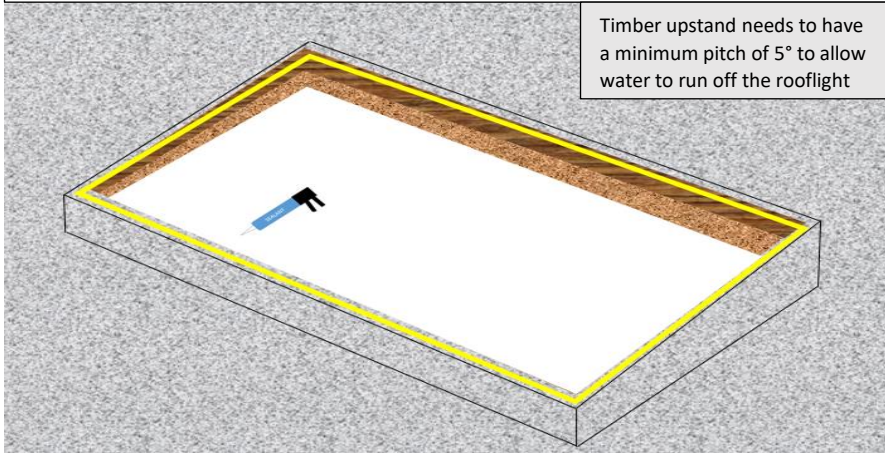

- 2) Position and lower the Rooflight frame over the top and side of the upstand/kerb

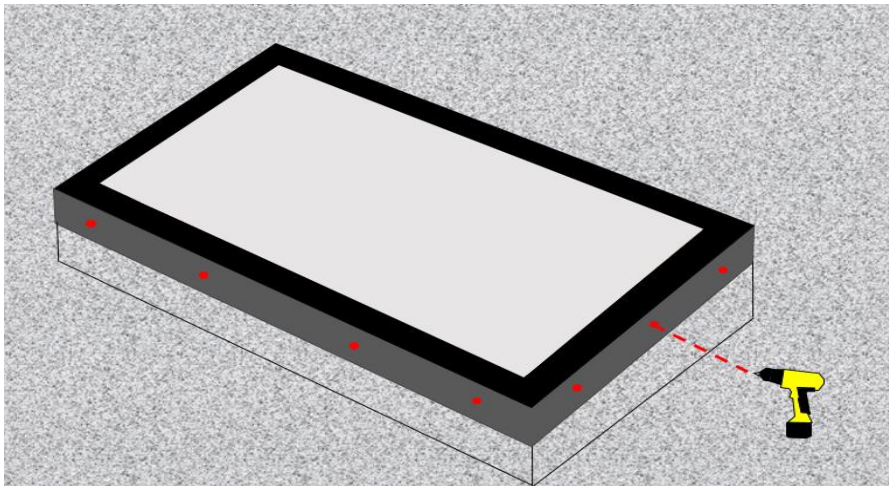
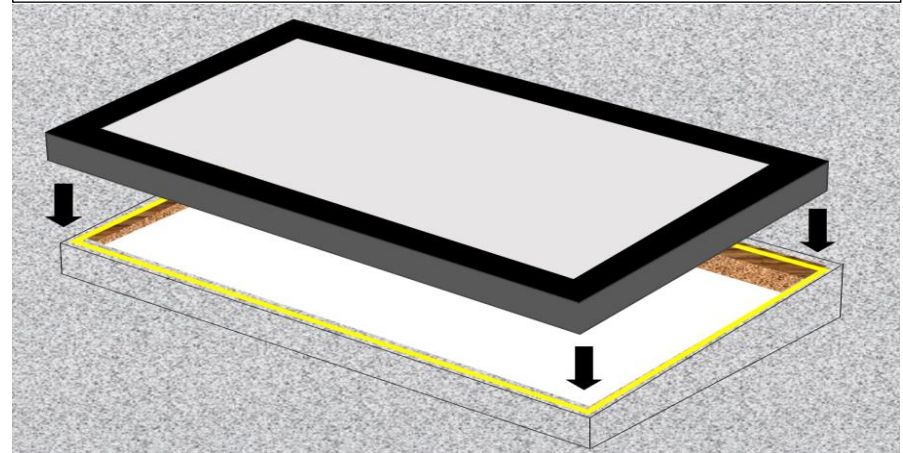

- 3) Pre drill fixing holes through aluminium and timber upstand/kerb at 100mm from each corner and then at regular intervals.

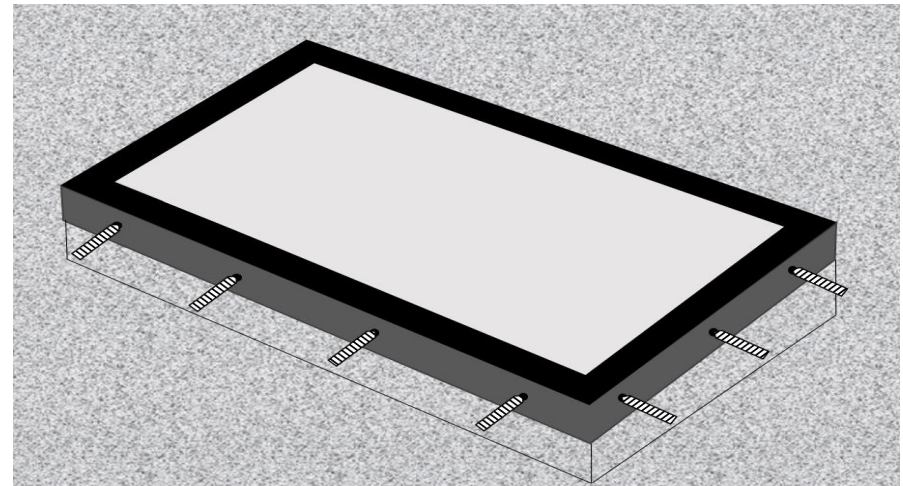

- 4) Secure fixing screws with horse shoe packers and finishing caps continuously all the way around securing the aluminium frame in place.

Option 2 (Fixing from Internally) Fixed Rooflight Installation

Fixed Flat Thermal Rooflight Typical Installation Guide

Double Glazed

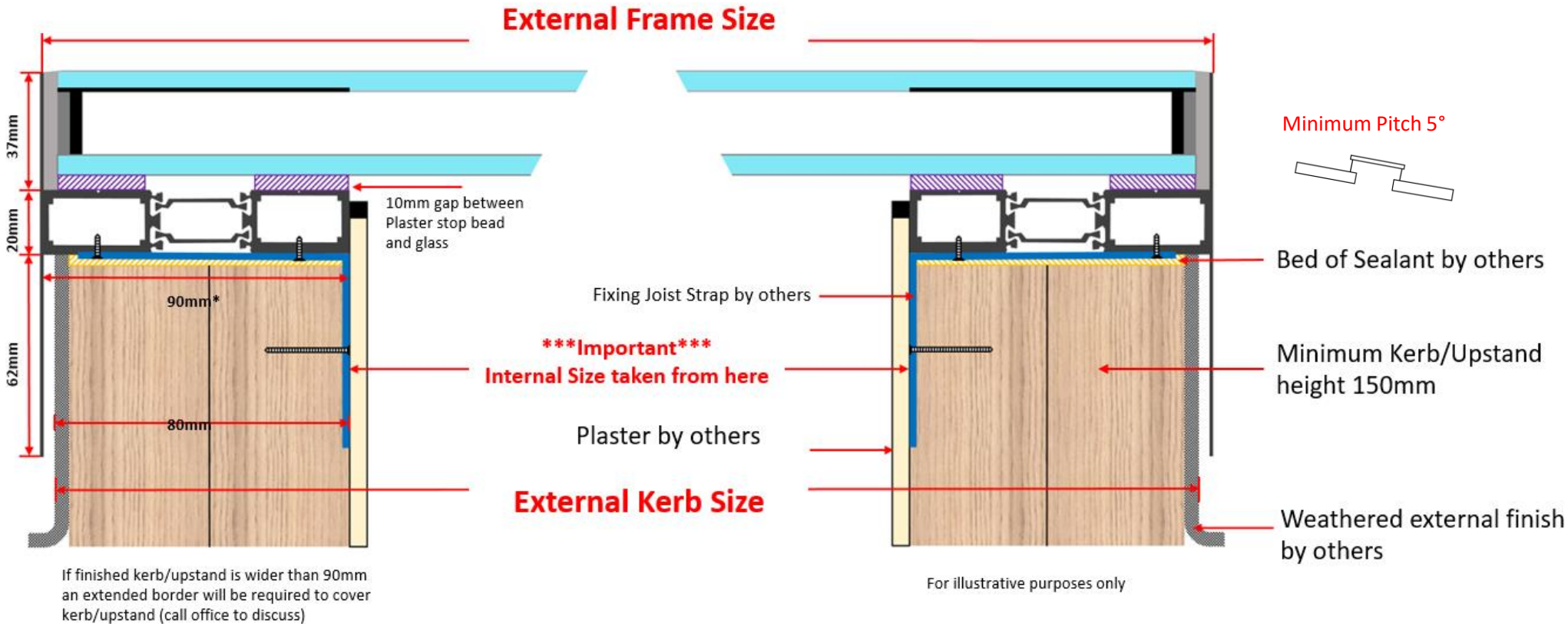

Option 2 (Fixing from Internally) Fixed Rooflight Installation Guide

- 1) Apply a thick bead of silicone all the way around the top of the timber upstand

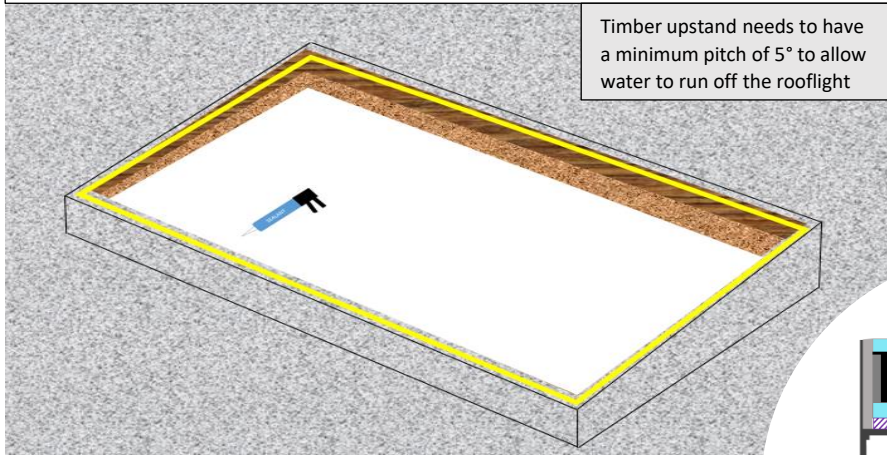

- 2) Position the Rooflight over the upstand ensuring that the fixing straps have been fixed to underside of frame (refer to diagram centre).

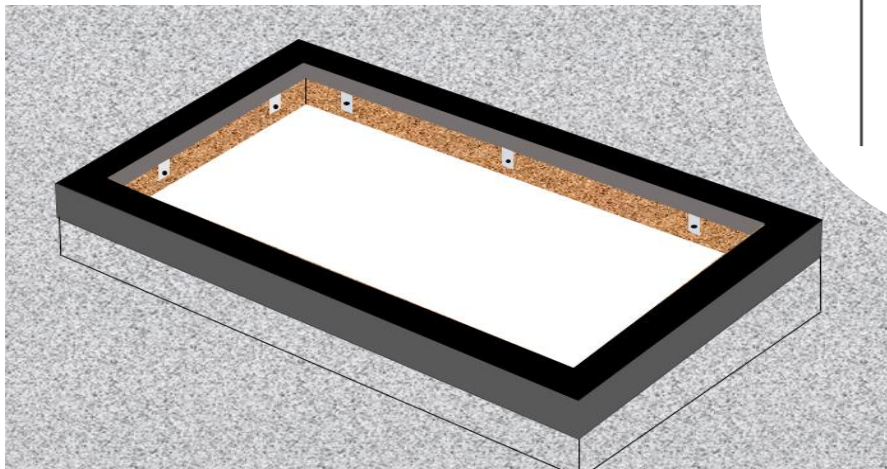
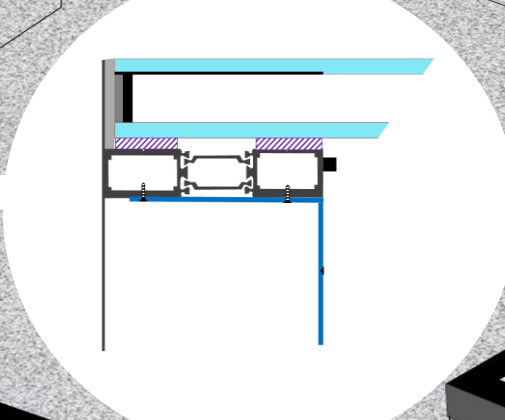
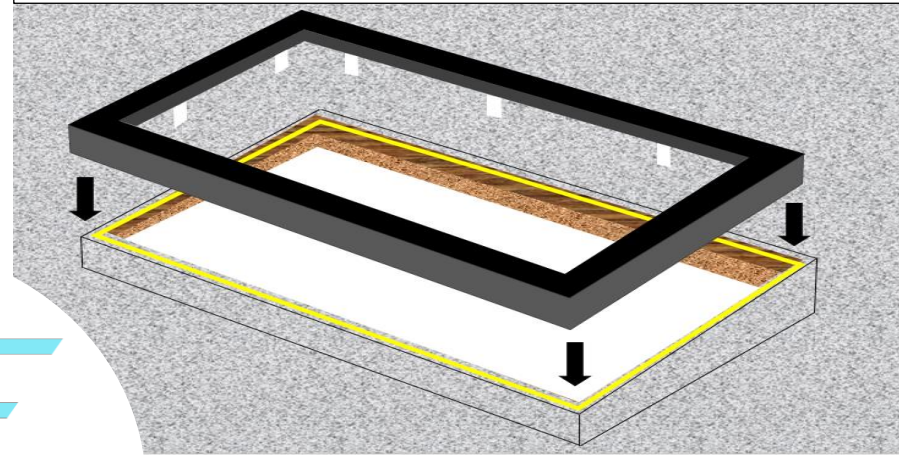

- 3) From the inside secure the fixing straps to inside the timber upstand.

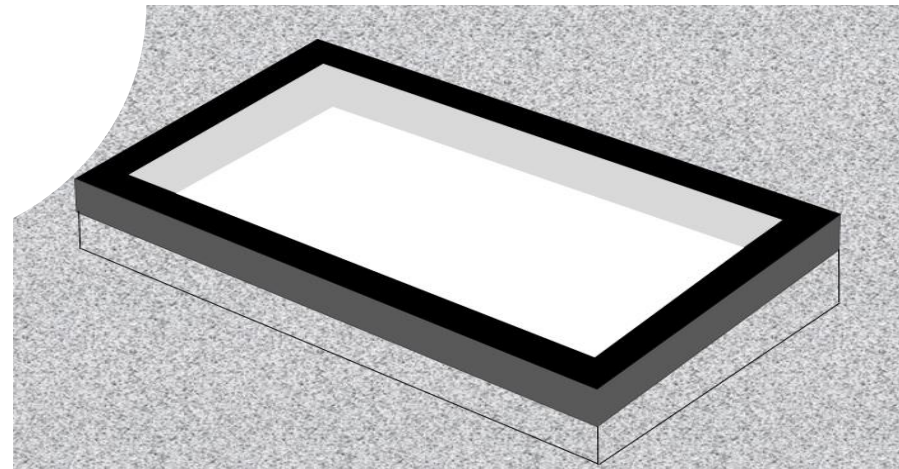

- 4) Internally finish by plaster boarding over the timber and straps leaving at least a 10mm gap from the top of the plasterboard to glass.