



BENTLEY

[HOME](#)

BE EXTRAORDINARY, LIVE EXTRAORDINARY

Style and craftsmanship come together effortlessly in the Bentley Home collection. A range of furnishings that perfectly complement your lifestyle, in high-quality materials shaped by skilled Italian artisans. Bentley Home has been inspired by the design codes and meticulous attention to detail typical of Bentley, the renowned automotive Maison, using leather, veneer, metal and glass to achieve a distinctive aesthetic. The collection is designed for everyday living in complete comfort but also with stylish elegance, as a perfect expression of contemporary luxury.



EXQUISITE STYLE, TIMELESS DESIGN

The Bentley Home collection is a tribute to the tradition of the great automotive brand. Its refinement has been honed to shape a new aesthetic style based on savoir-faire, creativity and sophistication.

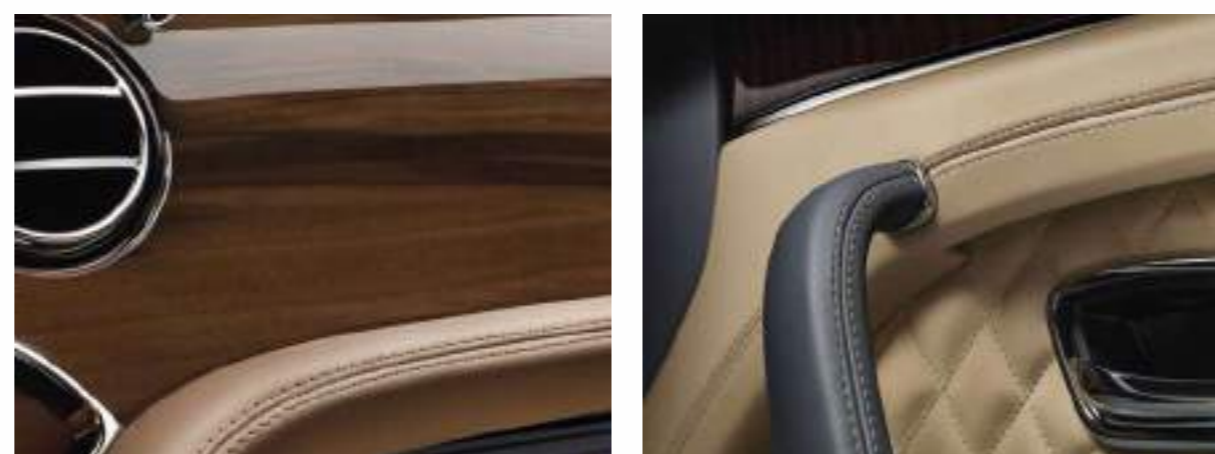
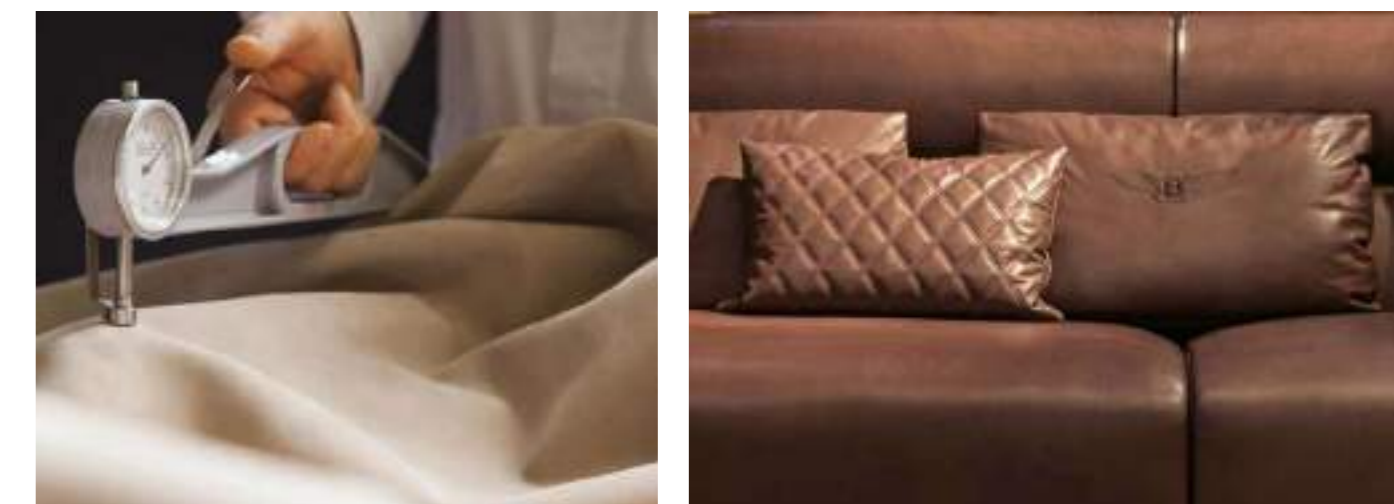

The Bentley identity is reflected in the Bentley Home collection, composed of prestigious and exclusive furniture and accessories. Every Bentley Home piece is unique and timeless. The collection features outstanding design, relying on the finest Italian tradition of craftsmanship. Elegant, sophisticated and contemporary: the Bentley Home collection creates an exclusive ambiance with an unmistakable style, where luxury and functional quality blend perfectly. An aristocratic air tempered by a contemporary approach to produce a forceful impact: style and savoir-faire generate exceptional flair, crafted down to the smallest details, embodied by the silhouettes and shapes of sofas, armchairs, beds and accessories.

The art of crafting excellence



The same cutting edge of craftsmanship

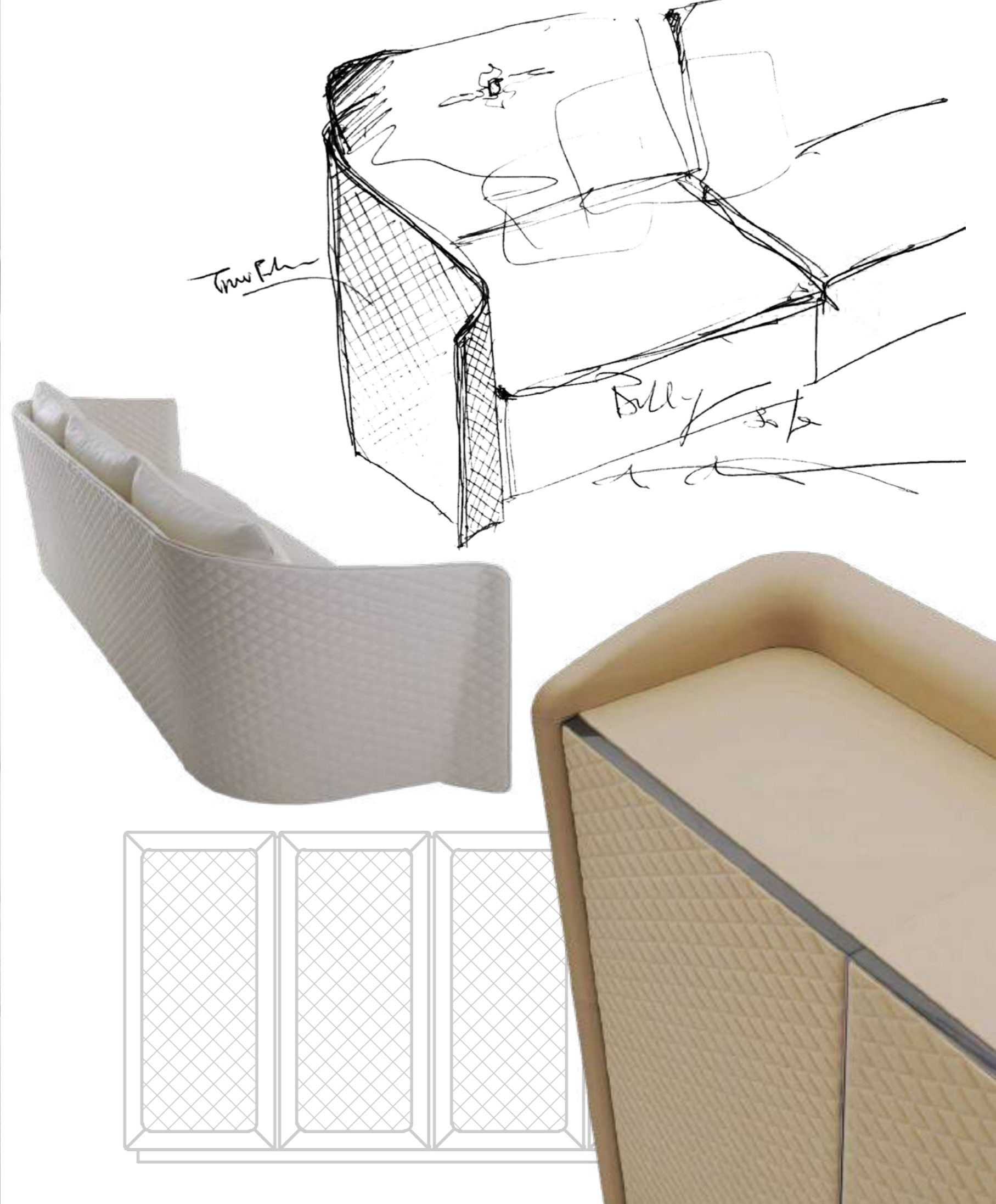

THE WORLD OF BENTLEY INTERIORS ³ / CONTEMPORARY
STYLE AND CRAFTSMANSHIP ⁴ / THE LINE OF BEAUTY WITHOUT
COMPROMISES ²⁸ / EXCELLENCE IN DESIGN AND MATERIALS ⁴⁶ /
THE ART OF LUXURIOUS DESIGN ⁶⁸ / A COLLECTION FOCUSED
ON DETAILS ⁸⁰ / TECHNICAL SPECIFICATIONS ⁹³ /



Butterfly table, Belgravia chairs

THE WORLD OF BENTLEY INTERIORS

Bentley Home collection reflects the evolution of its formal language. A faithful reinterpretation of the codes of excellence, expressed in furniture and accessories displayed in a setting that describes a new dimension of contemporary luxury.

Unique creations form a Collection that stands out for the modern, subtle overtones of the finest craftsmanship, Made in Italy. The harmonious play of contrasts and styles follows a fil rouge of elegance, suggesting luxurious, enveloping atmospheres. Balancing the use of the highest-quality materials and fine craftsmanship with innovation; paying tribute to the brand's illustrious heritage, whilst openly embracing the future. To create a captivating everyday lifestyle.

CONTEMPORARY STYLE AND CRAFTSMANSHIP

The materials used for the Bentley Home collection are the result of the balance between tradition and innovation. New velvets, with their unique quality and elegance, are handwoven on backstrap looms using traditional techniques. This approach is enhanced by new technologies to create three-dimensional textures.



Minster sofa, Kepi coffee table



Richmond sofa and armchair, Cliffden coffee tables



Kendal chair



Lendal cupboard detail



Alston table, Kendal chairs, Lendal cupboards



Norton armchair and sectional sofa, Cliffden and Lewes coffee tables, Alton cabinet



Stamford armchair, Lewes side table



Stamford sofa, Kepi side tables



Butterfly sofa, Roseberry armchair, Kew side tables, Morpeth floor lamp



Beaumont sofa and armchairs, Madeley coffee table, Harold sideboard, Honister standing lamp



Kensington sofa, Kew coffee table and Morpeth floor lamp



Kensington armchair



Roseberry armchair



Richmond bed detail



Richmond bed

The relaxing and innovative attitude typical of the Bentley world is also reflected in the choice of materials. The maple and eucalyptus woods that add allure to the structures and surfaces are interpreted in variations with the refined fiddleback motif, at times in contrast with the leather covers.



Butterfly armchair, Todd ottoman, Stonelight floor lamp



Avebury bed, Eastgate bedside table



Eastgate chest of drawers

An extraordinary vision in every detail



THE LINE OF BEAUTY WITHOUT COMPROMISES

A total lifestyle for everyday experience, a world of functional quality without compromise in terms of luxury and craftsmanship. Fabrics take their cue from the world of haute couture, in a tribute to the inimitable automotive tradition. Soft cotton and silk velvets and high-performance chenilles reinterpret chromatic patterns, applying a palette that ranges through delicate and pastel nuances.



Maldon table with Malvern chairs, Acton suspension



Chorley sofas, Sherwood armchairs, Harrow sectional sideboard, Madeley coffee table



Butterfly 3 seater sofa and armchairs, Matlock coffee and side tables, Dundee ottomans



Wickham armchairs and 3 seater sofa, Kepi coffee and side tables, Ambassador bookshelves



Wickham armchair, Ambassador bookshelves



Wickham armchair detail



Wickham 3 seater sofa, Ambassador bookshelf



Tiverton sectional sofa and chaise longues, Matlock coffee and side tables, Dundee ottoman



President writing-desk with Yate office chair, Mere armchairs, Stonelight table lamp

The colours offer a range of warm tones: shades of brown, dark chocolate, brick, the new praline tones, along with quartz grey, burgundy, hazelnut and royal blue. The quest for style is fully expressed in the furniture's upholstery. Elements typical of men's tailoring, such as pinstripes, Prince of Wales, and the iconic Bentley patterns, including quilted effects, are applied to the leather: light, supple, of the highest quality, in shades of beige, mink and cognac, matched with incredibly fine houndstooth-patterned wool in walnut and dark mocha hues.



Sherwood bergere with ottoman

The cars, the brand and the lifestyle

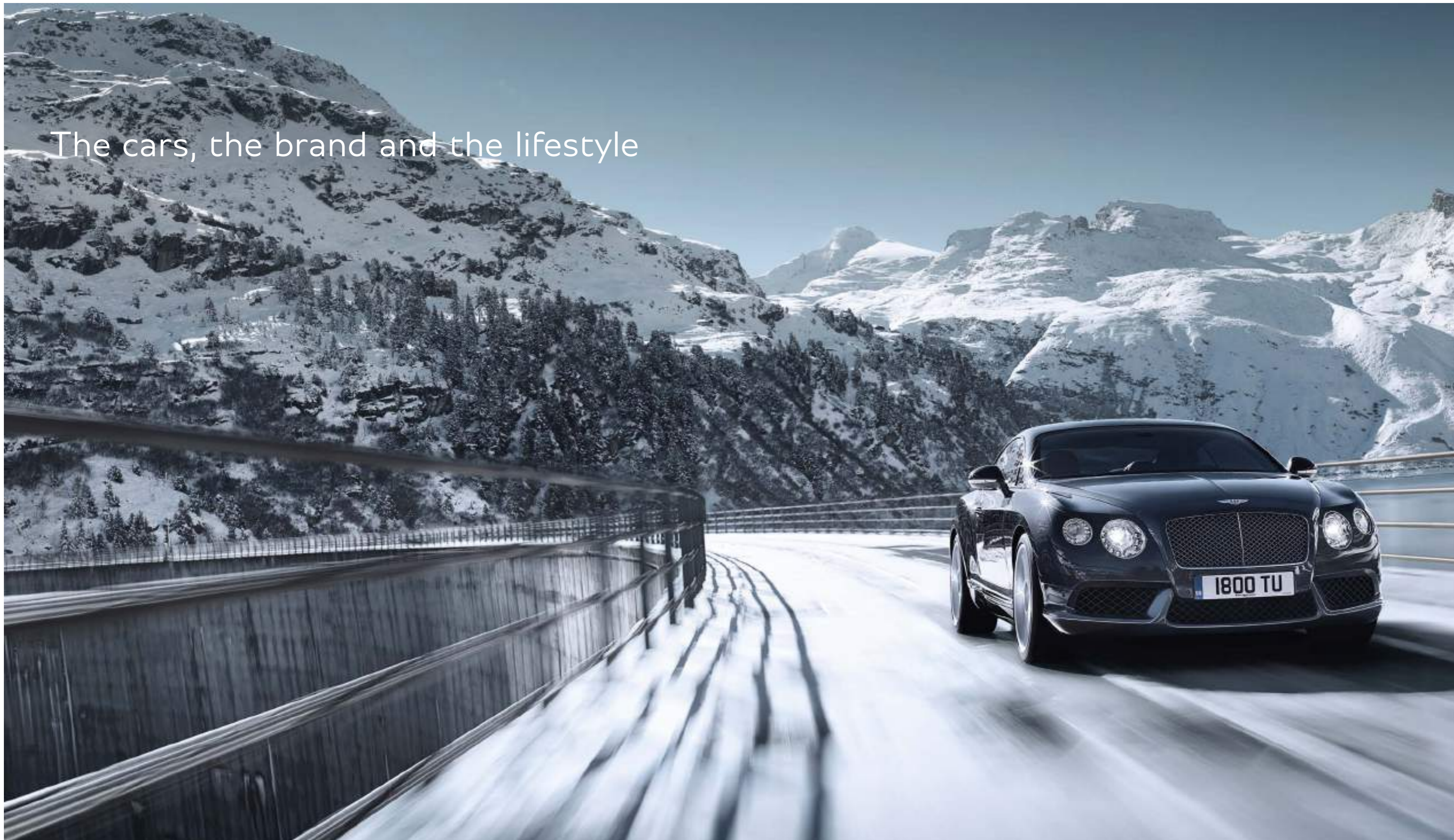

EXCELLENCE IN DESIGN AND MATERIALS

Chestnut briar-root adds elegance to structures and surfaces. The rich grain of Ebony Macassar, the exclusive glow of onyx and pale Calacatta marble adorn the table tops, in contrast with the gun-metal grey finish of the bases.

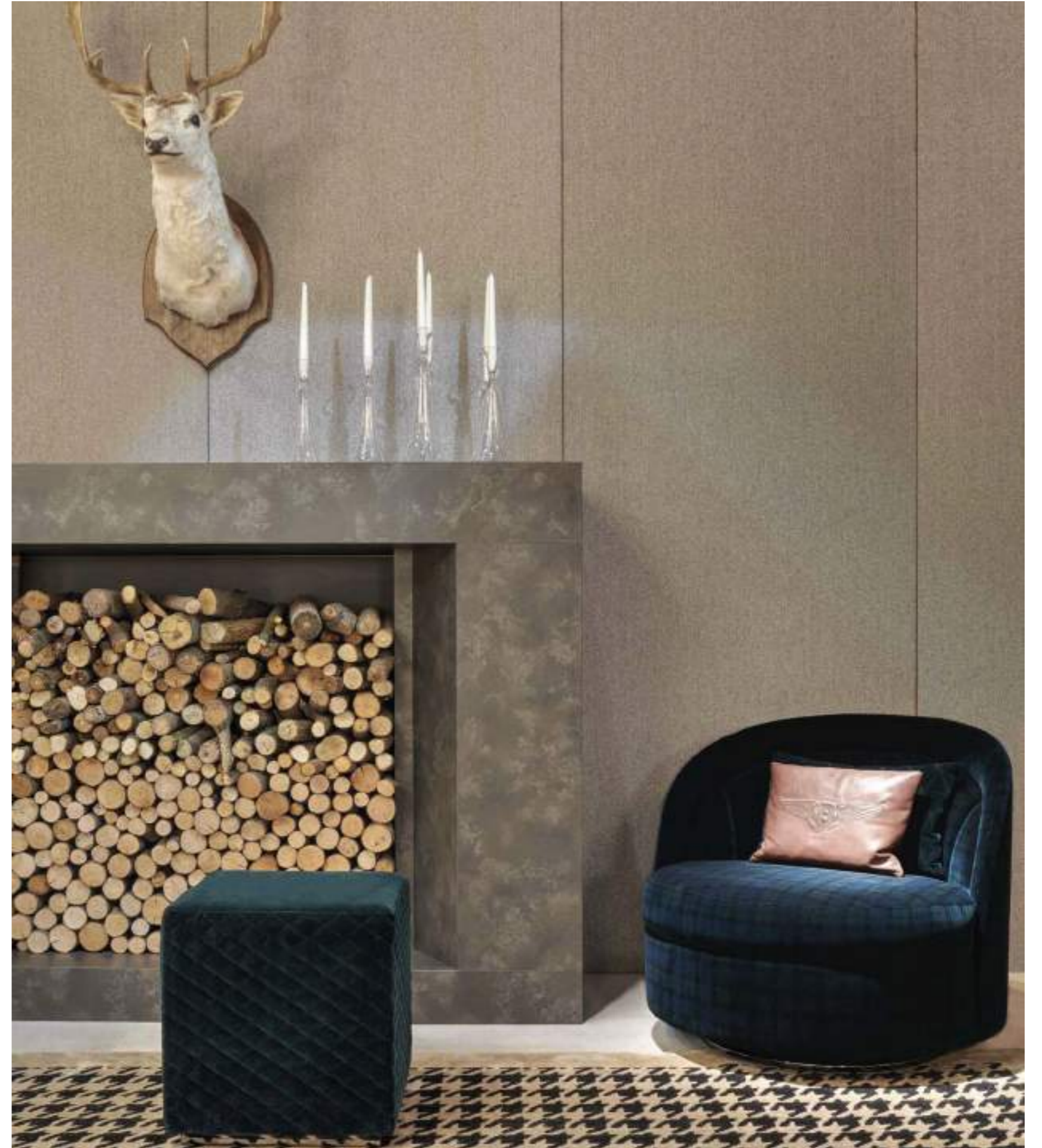

Ashley armchair, Todd ottoman



Tiverton sectional sofas and chaise longues, Matlock coffee and side tables, Dundee ottoman



Tiverton sectional sofa, Matlock coffee and side tables



Bampton armchairs and 4 seater sofa, Sherwood coffee and side tables, Dundee ottomans



Maldon oval table with Thorne chairs, Eastgate cabinets, Talbot suspension



Amble bed, Ambleside bedside tables and "Settimino" chest of drawers, Dundee ottomans, Warwick suspensions



Ambleside chest of drawers



Eastgate "Settimino" chest of drawers



Rugby sofa
60



Harold dressing table with mirror, Roseberry armchair, Evan console

The materials have been selected to create a balance between tradition and innovation. New velvets, with their unique quality and elegance, are handwoven on backstrap looms using age-old techniques. This approach is enhanced by new technologies to create three-dimensional textured weaves.



Mere armchair

Leather crafted with love



THE ART OF LUXURIOUS DESIGN

Bentley Home is a collection of furniture that narrates an incomparable lifestyle, with the same charm and allure as a Bentley motorcar. Sofas, armchairs, consoles, beds and accessories like humidors, frames, vases and sumptuous fabrics convey ideas with a forceful aesthetic sensibility, a synthesis between design and an innate culture of beauty. An enveloping style conceived to be experienced in everyday life, providing the highest functional quality without sacrificing luxury and impeccable workmanship.



Henley table with Malvern chairs, Warwick suspension



Harold sideboard, Stonelight table lamp



Mere armchair, Harold "Settimino" chest of drawers



Wickham bed and Harold bedside table detail



Wickham bed with Harold bedside tables, Todd ottomans



Lanes "Settimino" chest of drawers, Rugby sofa detail



Lanes bedside table detail



Lanes chest of drawers detail



Lancaster bed, Sherbourne sideboard, Stafford bedside tables, Stonelight table lamps

A long tradition of unrivaled design



A COLLECTION FOCUSED ON DETAILS

Thanks to the expertise of Luxury Living Group, Bentley Home is a collection suitable for a complete interior decoration project, from the living area to the bedroom and dining areas. The collection is the perfect choice for the world's most exclusive locations, from residences in Miami to Alpine chalets. The collection embodies a complete lifestyle that reflects an idea of luxury at the highest levels, expressed in even the smallest details.



Alton cabinet, Todd ottoman



Winston sofa, Cliffden coffee tables, Stonelight floor lamp, Todd ottoman



Canterbury bed detail



Stafford bedside table detail



Canterbury bed, Chesil bedside table lamp



Stowe sectional sofa, Sherwood coffee table, Eastgate sideboard



Stowe sectional sofa



Stowe sectional sofa, Sherwood coffee table

technical specifications

SOFAS	95 /
ARMCHAIRS	113 /
OTTOMANS	121 /
CHAIRS	123 /
TABLES	127 /
CABINETS & BOOKSHELF	133 /
CHEST OF DRAWERS	139 /
CUPBOARDS & SIDEBOARDS	145 /
COFFEE AND SIDE TABLES	153 /
CONSOLES & MIRRORS	163 /
OFFICE	167 /
CENTENARY LIMITED EDITION	171 /
BEDS & BEDSIDE TABLES	173 /
LIGHTING	187 /
RUGS	195 /
TEXTILE ACCESSORIES	198 /
ACCESSORIES	207 /
DECORATIONS	209 /
FINISHING	213 /
NOTE	215 /



BAMPTON



BEAUMONT

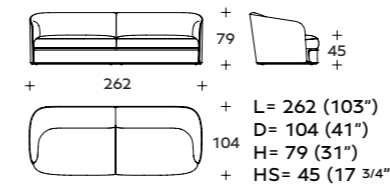

3 SEATER SOFA: 3BE (D3)

VENEERED: 3BE (D3E)
GLAZE EARTH - GLAZE SLATE -
GLAZE GREIGE: 3BE (D3L)

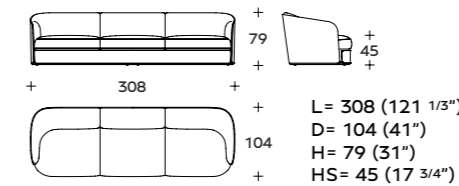

4 SEATER SOFA: 3BE (D4)

VENEERED: 3BE (D4E)
GLAZE EARTH - GLAZE SLATE -
GLAZE GREIGE: 3BE (D4L)

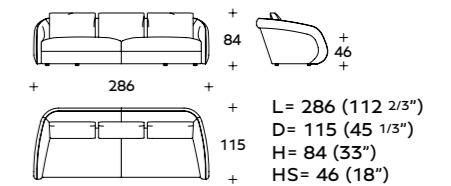

4 SEATER SOFA: MOL (D4)

EBONY MACASSAR - LARCH -
LIQUIDAMBAR: MOL (D4E)
CHESTNUT - BURR WALNUT: MOL (D4R)

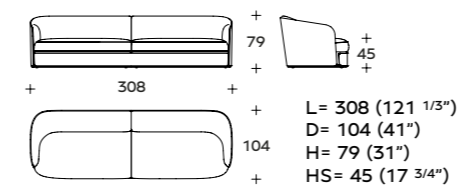

4 SEATER SOFA IN 2 ELEMENTS: 3BE (AD4)

VENEERED: 3BE (AD4E)
GLAZE EARTH - GLAZE SLATE -
GLAZE GREIGE: 3BE (AD4L)



BUTTERFLY



CHORLEY



COLBURN

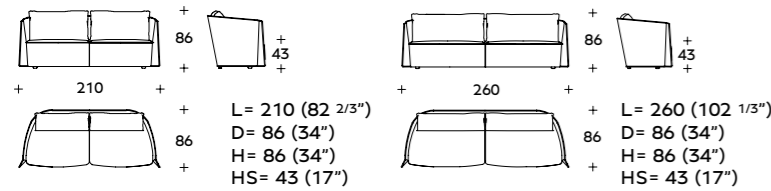

3 SEATER SOFA: BTF (D3)

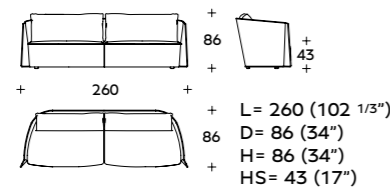

3 SEATER MAXI SOFA: BTF (BD3)

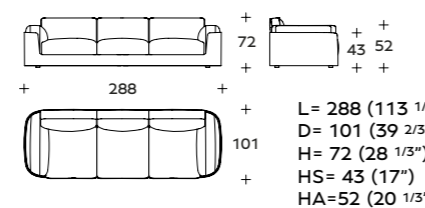

3 SEATER SOFA: 5CH (D3)
VENEERED: 5CH (D3R)

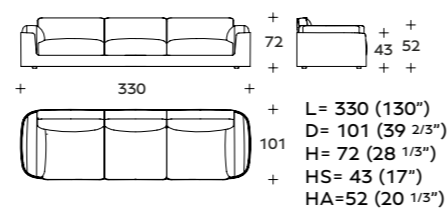

4 SEATER SOFA: 5CH (D4A)
VENEERED: 5CH (D4AR)

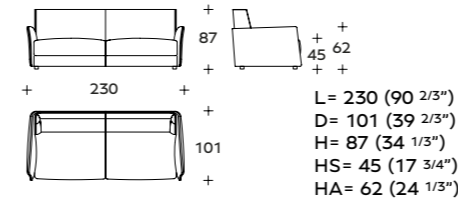

3 SEATER SOFA: 2BE (D3)
EBONY MACASSAR - EUCALYPTUS -
LARCH - SYCAMORE - CHESTNUT -
BURR WALNUT: 2BE (D3E)

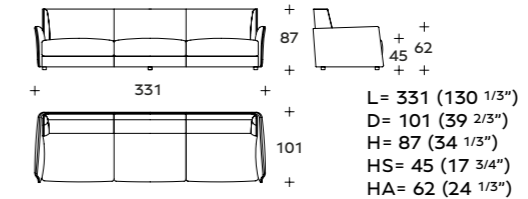

4 SEATER SOFA: 2BE (D4)
EBONY MACASSAR - EUCALYPTUS -
LARCH - SYCAMORE - CHESTNUT -
BURR WALNUT: 2BE (D4E)

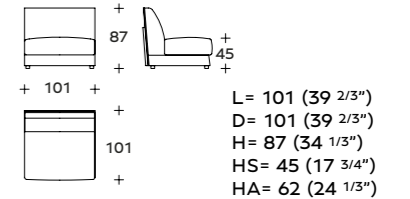

CENTRAL ELEMENT: 2BE (EC)
EBONY MACASSAR - EUCALYPTUS -
LARCH - SYCAMORE - CHESTNUT -
BURR WALNUT: 2BE (ECE)

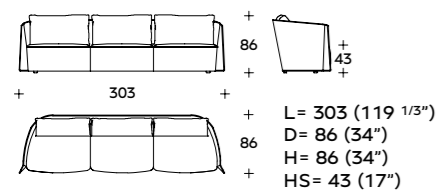

4 SEATER SOFA: BTF (D4)

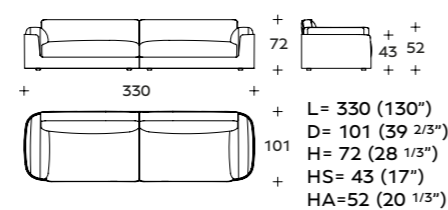

4 SEATER SOFA IN 2 ELEMENTS: 5CH (D4)
VENEERED: 5CH (D4R)

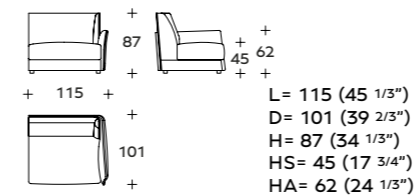

SEATER ELEMENT WITH RIGHT
ARMREST: 2BE (ED)
EBONY MACASSAR - EUCALYPTUS -
LARCH - SYCAMORE - CHESTNUT -
BURR WALNUT: 2BE (EDE)

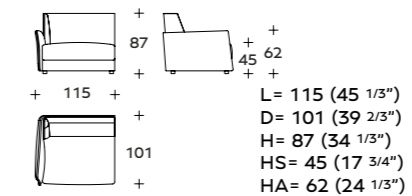

SEATER ELEMENT WITH LEFT
ARMREST: 2BE (ES)
EBONY MACASSAR - EUCALYPTUS -
LARCH - SYCAMORE - CHESTNUT -
BURR WALNUT: 2BE (ESE)



KENSINGTON

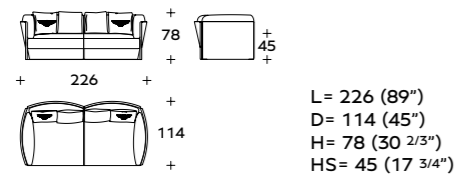

3 SEATER SOFA: BTL (D3)

CHESTNUT - BURR WALNUT: BTL (D3R)



KINGSWOOD

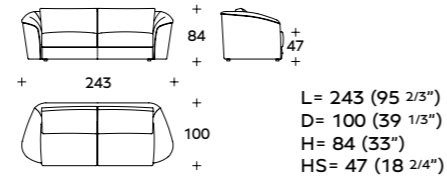

3 SEATER SOFA: AZU (D3)

CHESTNUT - BURR WALNUT: AZU (D3R)



LANCASTER

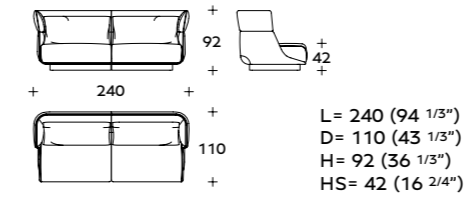

3 SEATER SOFA: CDB (D3)



MINSTER

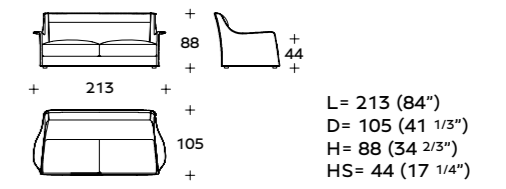

3 SEATER SOFA: MIS (D3)

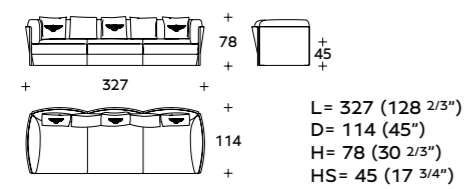

4 SEATER SOFA: BTL (D4)

CHESTNUT - BURR WALNUT: BTL (D4R)

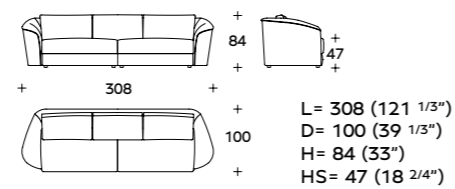

4 SEATER SOFA IN 2 ELEMENTS: AZU (AD4)

CHESTNUT - BURR WALNUT: AZU (AD4R)

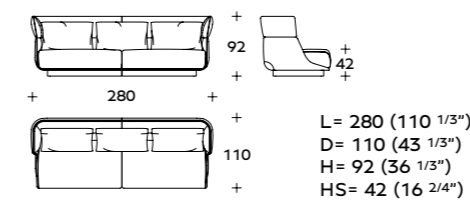

4 SEATER SOFA: CDB (D4)

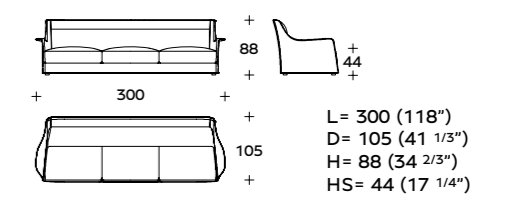

4 SEATER SOFA: MIS (D4)



LEISTON



PORTOBELLO



NORTON

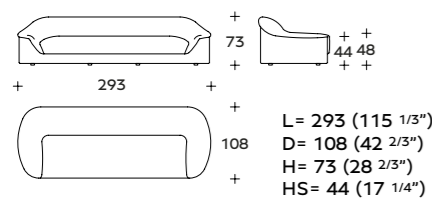

3 SEATER SOFA: HON (D3)
VENEERED: HON (D3E)

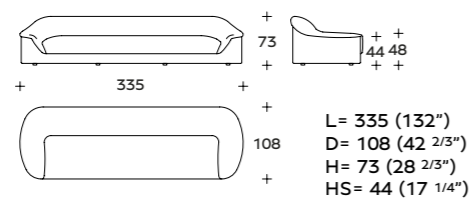

4 SEATER SOFA: HON (D4)
VENEERED: HON (D4E)

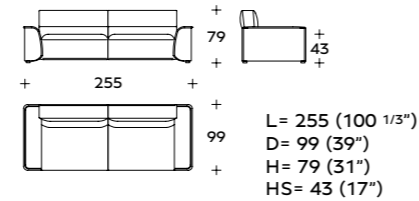

3 SEATER SOFA: UXB (D3)
EBONY MACASSAR: UXB (D3E)
CHESTNUT - BURR WALNUT: UXB (D3R)

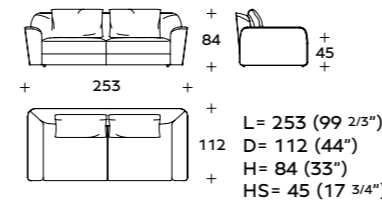

3 SEATER SOFA: WAT (D3)

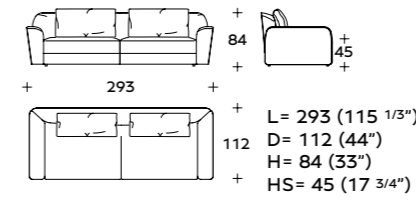

4 SEATER SOFA: WAT (D4)

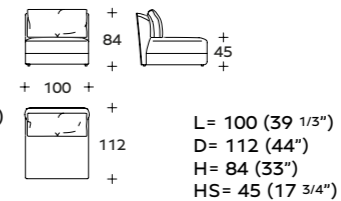

1 SEATER CENTRAL ELEMENT:
WAT (AE1CN)

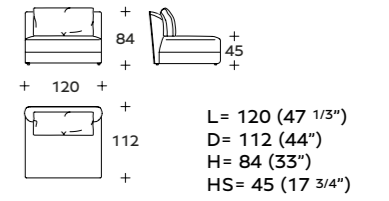

BIG: 1 SEATER CENTRAL ELEMENT:
WAT (E1CN)

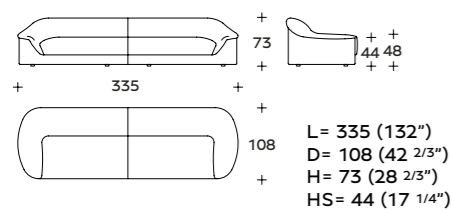

4 SEATER SOFA IN 2 ELEMENTS: HON (D4A)
VENEERED: HON (D4AE)

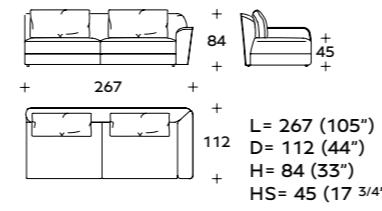

4 SEATER ELEMENT WITH
RIGHT OR LEFT ARMREST:
WAT (E4D) - WAT (E4S)

Drawing: right element

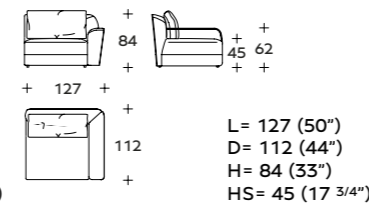

1 SEATER ELEMENT WITH
RIGHT OR LEFT ARMREST:
WAT (AE1D) - WAT (AE1S)

Drawing: right element

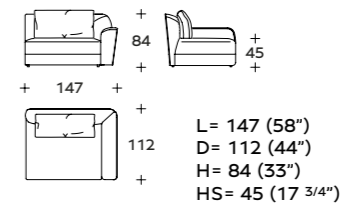

BIG: 1 SEATER ELEMENT WITH
RIGHT OR LEFT ARMREST:
WAT (E1D) - WAT (E1S)

Drawing: right element

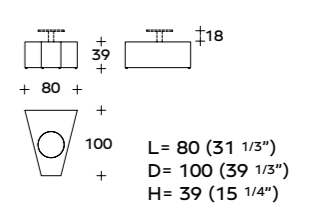

COFFEE TABLE
OPTIONAL ELECTRICAL
LIFT GLASS HOLDER
EBONY MACASSAR: CTB (16E)
CHESTNUT - BURR WALNUT: CTB (16R)



RICHMOND



RUGBY



STAMFORD

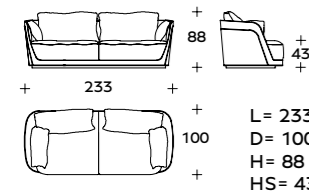

3 SEATER SOFA: CNC (D3)

LACQUERED: CNC (D3L)
 GLAZE EARTH - GLAZE SLATE: CNC (D3L)
 CHESTNUT - BURR WALNUT: CNC (D3R)
 EBONY MACASSAR - SYCAMORE - LARCH: CNC (D3E)

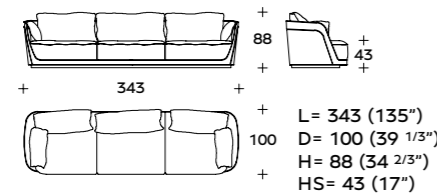

4 SEATER SOFA: CNC (D4)

LACQUERED: CNC (D4L)
 GLAZE EARTH - GLAZE SLATE: CNC (D4L)
 CHESTNUT - BURR WALNUT: CNC (D4R)
 EBONY MACASSAR - SYCAMORE - LARCH: CNC (D4E)

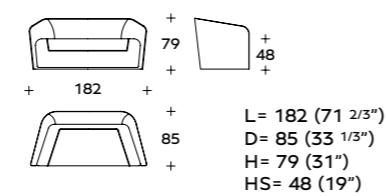

2 SEATER SOFA: RUG (D2)

LACQUERED: RUG (D2L)
 CHESTNUT - BURR WALNUT: RUG (D2R)

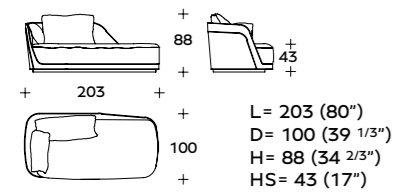

RIGHT OR LEFT CHAISE LONGUE:
 CNC (CLD) - CNC (CLS)

LACQUERED: CNC (CLDL) - CNC (CLSL)
 LACQUERED GLAZE EARTH - GLAZE SLATE - GLAZE
 GREIGE: CNC (CLDL) - CNC (CLSL)
 CHESTNUT - BURR WALNUT: CNC (CLDR) - CNC (CLSR)
 EBONY MACASSAR - SYCAMORE - LARCH: CNC (CLDE) - CNC (CLSE)

Drawing: right element

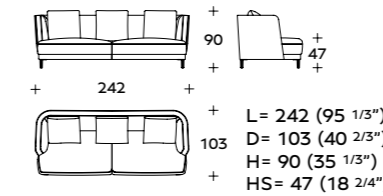

3 SEATER SOFA: SPI (D3)

EBONY MACASSAR - EUCALYPTUS - SYCAMORE - LARCH: SPI (D3E)
 CHESTNUT - BURR WALNUT: SPI (D3R)

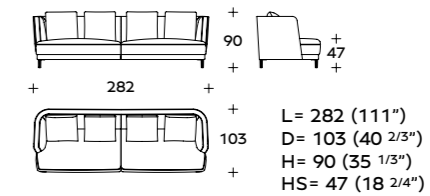

4 SEATER SOFA: SPI (D4)

EBONY MACASSAR - EUCALYPTUS - SYCAMORE - LARCH: SPI (D4E)
 CHESTNUT - BURR WALNUT: SPI (D4R)

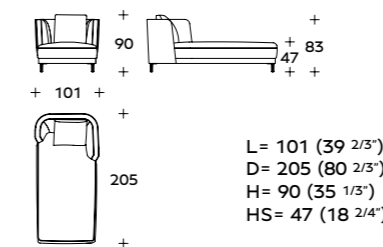

RIGHT OR LEFT DORMEUSE:
 SPI (CLD) - SPI (CLS)

EBONY MACASSAR - EUCALYPTUS - SYCAMORE - LARCH: SPI (CLDE) - SPI (CLSE)
 CHESTNUT - BURR WALNUT: SPI (CLDR) - SPI (CLSR)

Drawing: right element



STOWE



STOWE

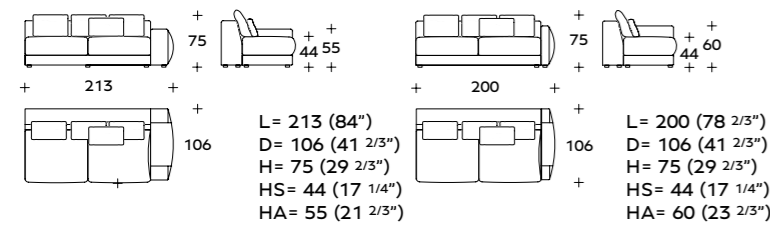

2 SEATER END ELEMENT WITH RIGHT OR LEFT ARMREST: KUR (E2BD) - KUR (E2BS)

Drawing: right element

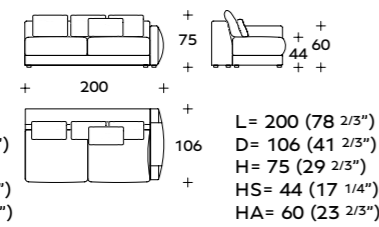

HIGH ARMREST
2 SEATER END ELEMENT WITH RIGHT OR LEFT ARMREST: KUR (E2AD) - KUR (E2AS)

Drawing: right element

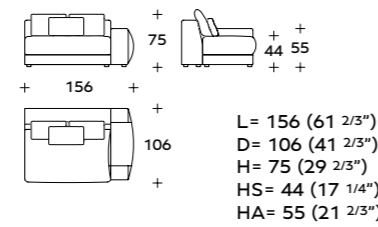

BIG END ELEMENT WITH RIGHT OR LEFT ARMREST: KUR (E1GBD) - KUR (E1GBS)

Drawing: right element

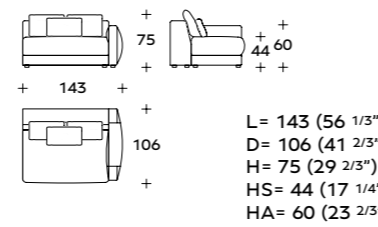

HIGH ARMREST
BIG END ELEMENT WITH RIGHT OR LEFT ARMREST: KUR (E1GAD) - KUR (E1GAS)

Drawing: right element

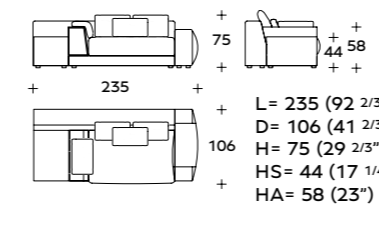

BIG END ELEMENT WITH RIGHT OR LEFT ARMREST + LEFT CASE WITH DRAWER: KUR (EMBD/02) - KUR (EMBS/02)

Drawing: right element

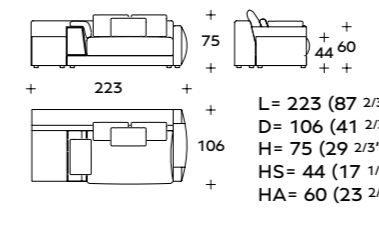

HIGH ARMREST
BIG END ELEMENT WITH RIGHT OR LEFT ARMREST + LEFT CASE WITH DRAWER: KUR (EMAD/02) - KUR (EMAS/02)

Drawing: right element

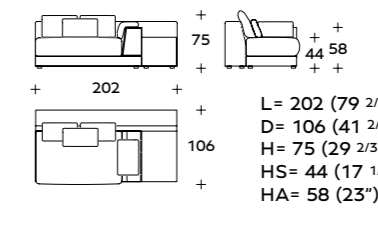

RIGHT OR LEFT BIG CENTRAL ELEMENT WITH ARMREST-BOOKSHELF + CASE WITH DRAWER: KUR (ECNMD/02) - KUR (ECNMS/02)

Drawing: right element

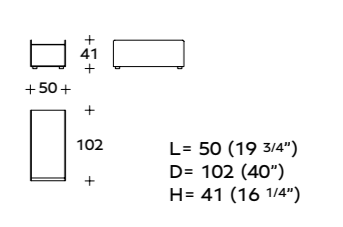

CASE WITH DRAWER: KUR (01)

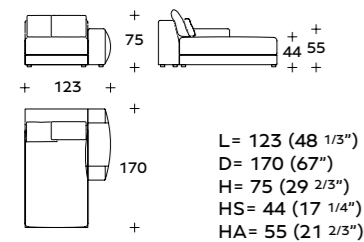

RIGHT OR LEFT CHAISE LONGUE: KUR (CLBD) - KUR (CLBS)

Drawing: right element

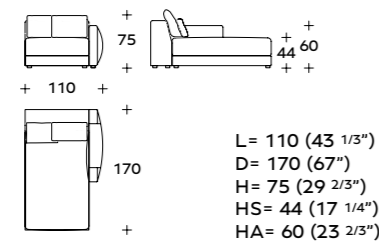

HIGH ARMREST
RIGHT OR LEFT CHAISE LONGUE: KUR (CLAD) - KUR (CLAS)

Drawing: right element

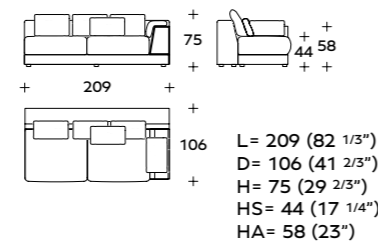

2 SEATER END ELEMENT WITH RIGHT OR LEFT ARMREST-BOOKSHELF: KUR (E2CD/BR) - KUR (E2CS/BR)

Drawing: right element

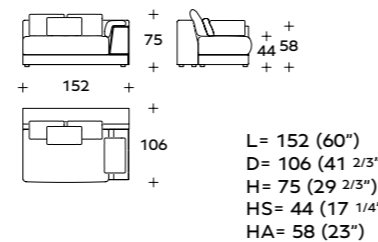

BIG END ELEMENT WITH RIGHT OR LEFT ARMREST-BOOKSHELF: KUR (E1CD/BR) - KUR (E1CS/BR)

Drawing: right element

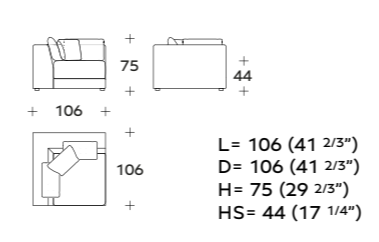

CORNER ELEMENT: KUR (ANG)

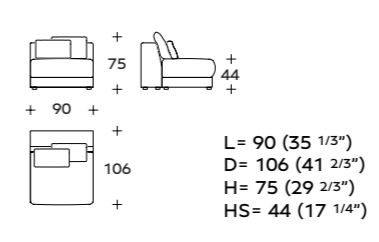

CENTRAL ELEMENT: KUR (E1CN)

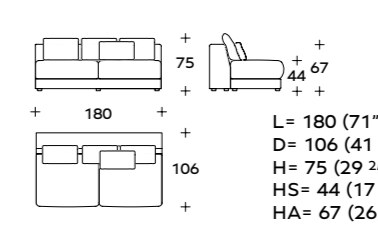

2 SEATER CENTRAL ELEMENT: KUR (E2CN)



TIVERTON

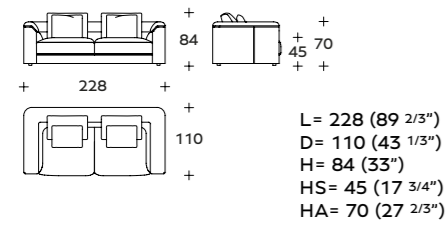

3 SEATER SOFA: TTN (D3)

VENEERED: TTN (D3E)

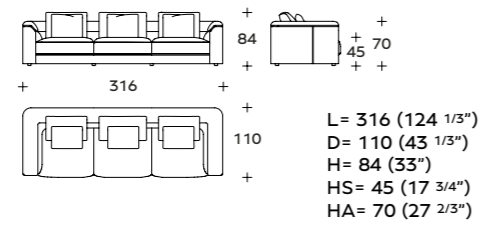

4 SEATER SOFA: TTN (D4)

VENEERED: TTN (D4E)

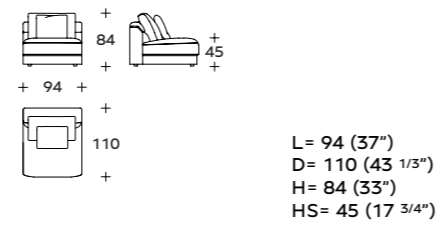

CENTRAL ELEMENT: TTN (ECP)

VENEERED: TTN (ECPE)

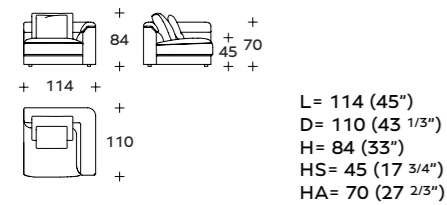

1 SEATER ELEMENT WITH RIGHT OR LEFT ARMREST: TTN (EDP) - TTN (ESP)

VENEERED: TTN (EDPE) - TTN (ESPE)

Drawing: right element

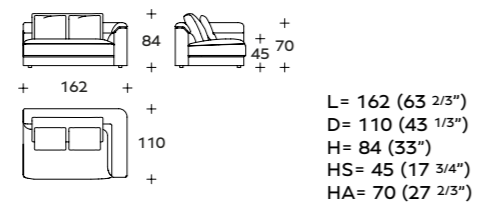

MAXI

1 SEATER ELEMENT WITH RIGHT OR LEFT ARMREST: TTN (EDX) - TTN (ESX)

VENEERED: TTN (EDXE) - TTN (ESXE)

Drawing: right element

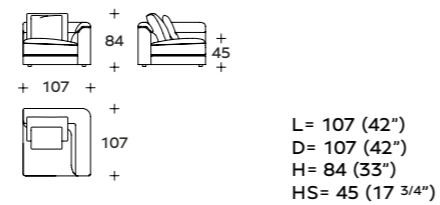

CORNER ELEMENT: TTN (ANGP)

VENEERED: TTN (ANGPE)



TIVERTON

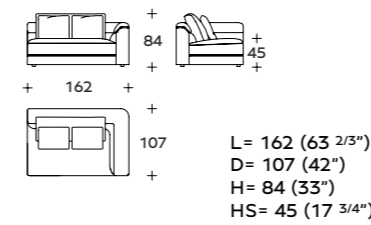

MAXI

RIGHT OR LEFT CORNER ELEMENT: TTN (ANGDX) - TTN (ANGSX)

VENEERED: TTN (ANGDXE) - TTN (ANGSXE)

Drawing: right element

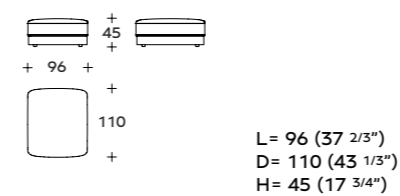

OTTOMAN: TTN (POU)

VENEERED: TTN (POUE)

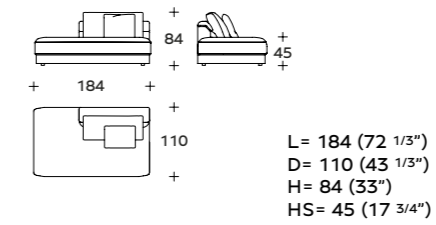

RIGHT OR LEFT PENINSULA: TTN (PEND) - TTN (PENS)

VENEERED: TTN (PENDE) - TTN (PENSE)

Drawing: right element

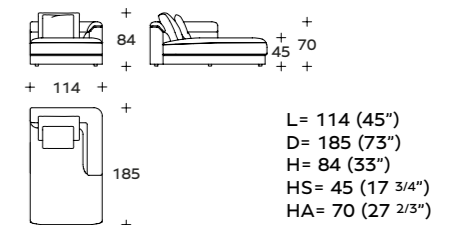

RIGHT OR LEFT CHAISE LONGUE: TTN (CLD) - TTN (CLS)

VENEERED: TTN (CLDE) - TTN (CLSE)

Drawing: right element



WESTBURY



WESTBURY

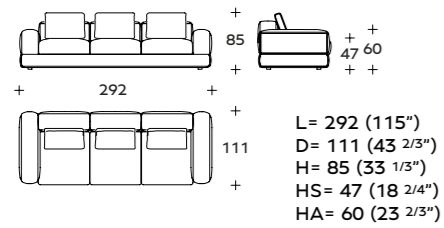

3 SEATER SOFA: BE1 (D3)

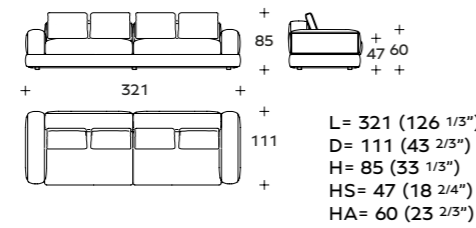

4 SEATER SOFA: BE1 (D4)

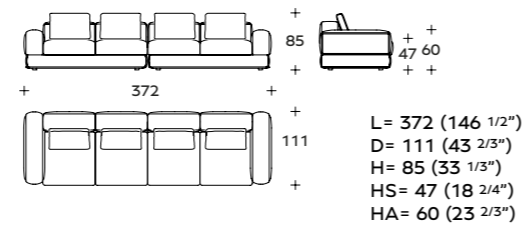

MAXI
4 SEATER SOFA IN 2 ELEMENTS: BE1 (D4X)

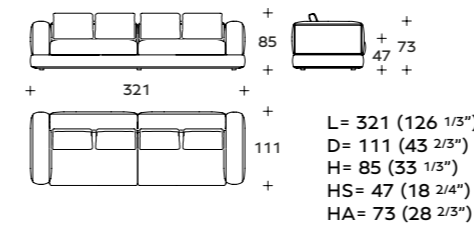

HIGH ARMREST
4 SEATER SOFA: BE1 (AD4)

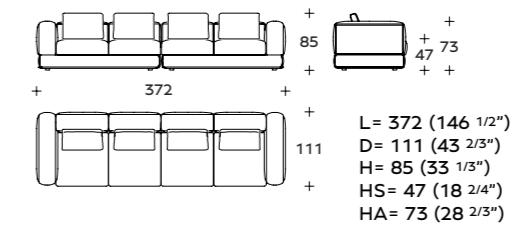

HIGH ARMREST - MAXI
4 SEATER SOFA IN 2 ELEMENTS: BE1 (AD4X)

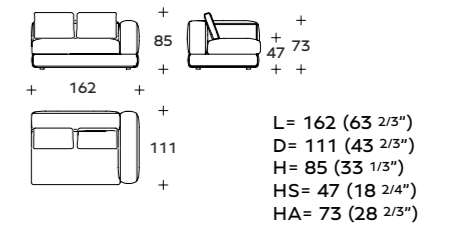

HIGH ARMREST - BIG
ELEMENT WITH RIGHT OR LEFT
ARMREST: BE1 (AEDG) - BE1 (AESG)

Drawing: right element

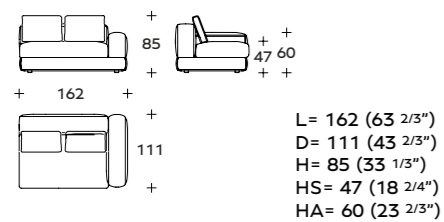

BIG
ELEMENT WITH RIGHT OR LEFT
ARMREST: BE1 (EDG) - BE1 (ESG)

Drawing: right element

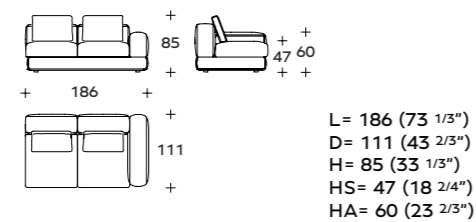

MAXI
ELEMENT WITH RIGHT OR LEFT
ARMREST: BE1 (EDX) - BE1 (ESX)

Drawing: right element

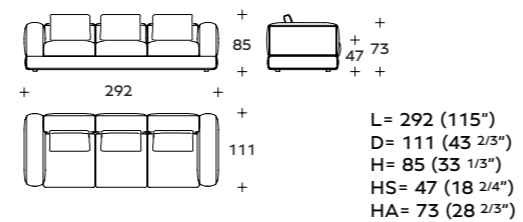

HIGH ARMREST
3 SEATER SOFA: BE1 (AD3)

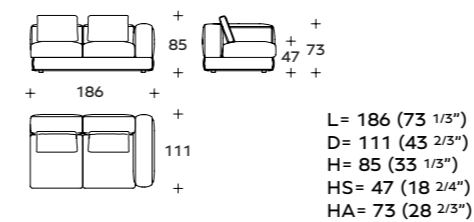

HIGH ARMREST - MAXI
ELEMENT WITH RIGHT OR LEFT
ARMREST: BE1 (AEDX) - BE1 (AESX)

Drawing: right element

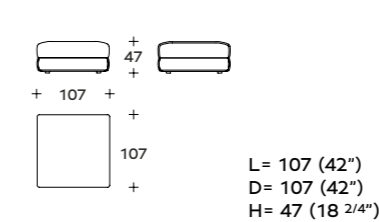

SQUARE OTTOMAN: BE1 (POUG)

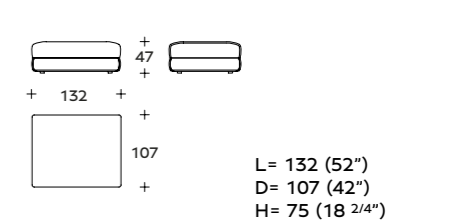

RECTANGULAR OTTOMAN: BE1 (POUR)



WINSTON

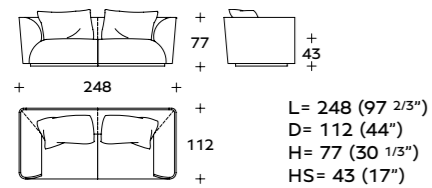

3 SEATER SOFA: MRB (D3)
 EBONY MACASSAR: MRB (D3E)
 CHESTNUT - BURR WALNUT: MRB (D3R)

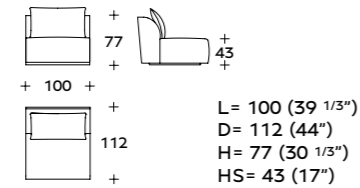

CENTRAL ELEMENT: MRB (E1CN)
 EBONY MACASSAR: MRB (E1CNE)
 CHESTNUT - BURR WALNUT: MRB (E1CNR)

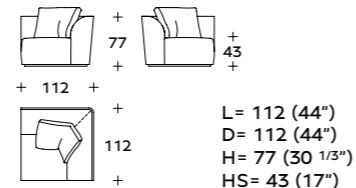

CORNER ELEMENT: MRB (ANG)
 EBONY MACASSAR: MRB (ANGE)
 CHESTNUT - BURR WALNUT: MRB (ANGR)



WICKAM

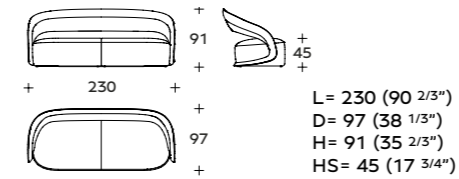

3 SEATER SOFA: RAM (D3)
 LACQUERED: RAM (D3L)
 BURR WALNUT: RAM (D3E)



WOOLWICH

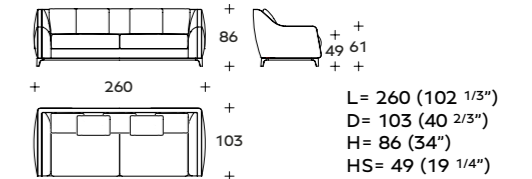

3 SEATER SOFA: WOO (D3)

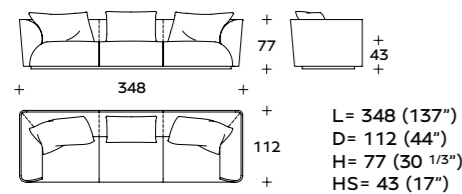

4 SEATER SOFA: MRB (D4)
 EBONY MACASSAR: MRB (D4E)
 CHESTNUT - BURR WALNUT: MRB (D4R)

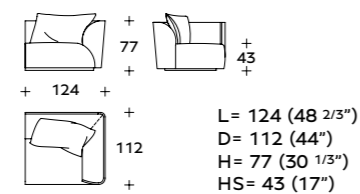

1 SEATER ELEMENT WITH RIGHT
 ARMREST: MRB (E1D)
 EBONY MACASSAR: MRB (E1DE)
 CHESTNUT - BURR WALNUT: MRB (E1DR)

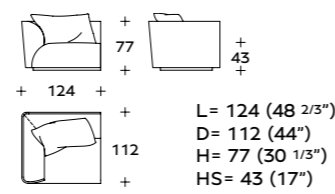

1 SEATER ELEMENT WITH LEFT
 ARMREST: MRB (E1S)
 EBONY MACASSAR: MRB (E1SE)
 CHESTNUT - BURR WALNUT: MRB (E1SR)

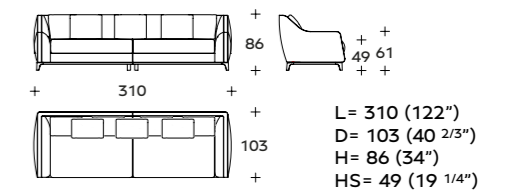

4 SEATER SOFA: WOO (D4)



BEAUMONT

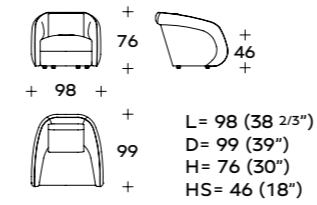

ARMCHAIR: MOL (POL)
EBONY MACASSAR - LARCH -
LIQUIDAMBAR: MOL (POLE)
CHESTNUT - BURR WALNUT: MOL (POLR)



ASHLEY

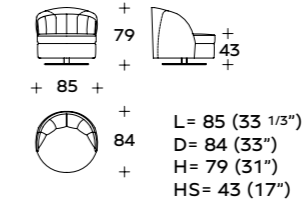

ARMCHAIR: POB (10)



BAMPTON

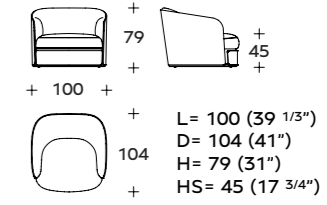

ARMCHAIR: 3BE (POL)
VENEERED: 3BE (POLE)
GLAZE EARTH - GLAZE SLATE -
GLAZE GREIGE: 3BE (POLL)



BELGRAVIA

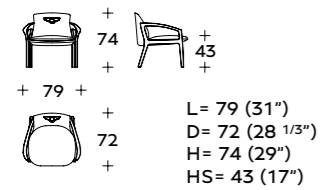

ARMCHAIR

EBONY MACASSAR - SYCAMORE: POB (16E)
CHESTNUT - BURR WALNUT: POB (16R)



BULL

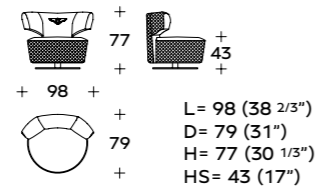

ARMCHAIR: POB (7)



BUTTERFLY

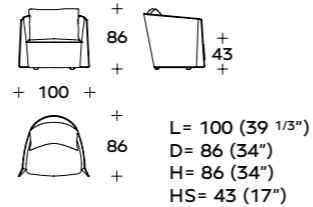

ARMCHAIR: BTF (POL)



CANTERBURY

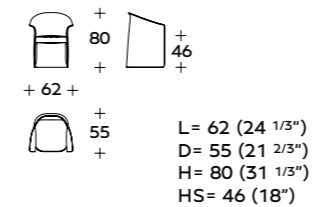

ARMCHAIR: POB (1)

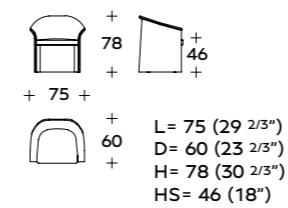

BIG ARMCHAIR: POB (1B)



COLBURN

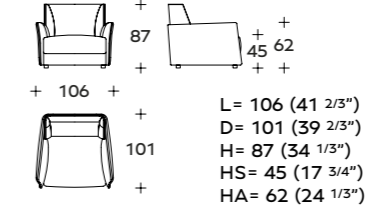

ARMCHAIR: 2BE (POL)

EBONY MACASSAR - EUCALYPTUS -
LARCH - SYCAMORE - CHESTNUT -
BURR WALNUT: 2BE (POLE)



DUKE

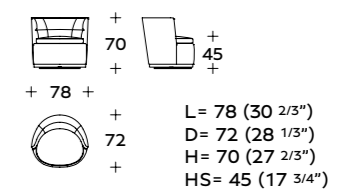

ARMCHAIR: POB (15)

SHEEPSKIN ARMCHAIR: POB (15F)



KENSINGTON

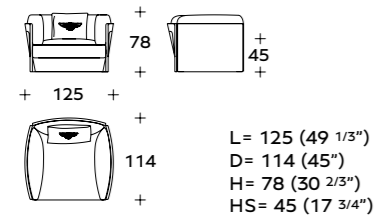

ARMCHAIR: BTL (POL)
CHESTNUT - BURR WALNUT: BTL (POLR)



LEISTON

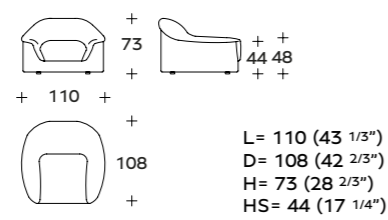

ARMCHAIR: HON (POL)
VENEERED: HON (POLE)



MERE

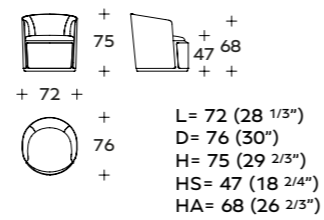

ARMCHAIR: POB (19)
VENEERED: POB (19E)



MINSTER

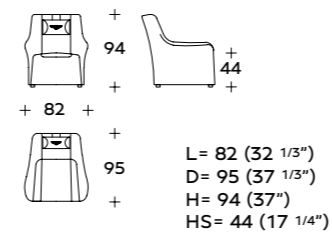

ARMCHAIR: POB (2)



MORLEY

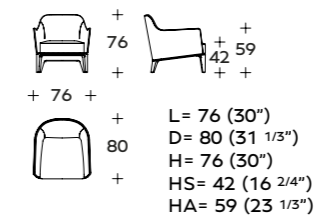

ARMCHAIR
EUCALYPTUS - SYCAMORE - LARCH - LIQUIDAMBAR LEGS: POB (18)
EUCALYPTUS - SYCAMORE - LARCH - LIQUIDAMBAR - CHESTNUT - BURR WALNUT TOP + LEGS: POB (18R)



NORTON

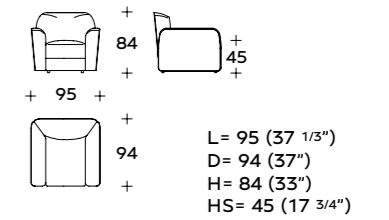

ARMCHAIR: WAT (POL)



PORTOBELLO

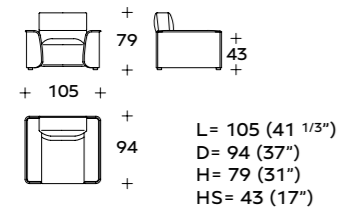

ARMCHAIR: UXB (POL)
 EBONY MACASSAR: UXB (POLE)
 CHESTNUT - BURR WALNUT: UXB (POLR)



RICHMOND

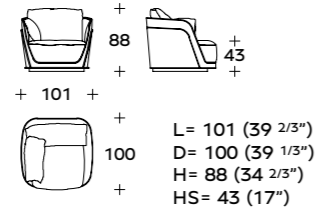

ARMCHAIR: CNC (POL)
 LACQUERED: CNC (POLL)
 GLAZE EARTH - GLAZE SLATE: CNC (POLL)
 CHESTNUT - BURR WALNUT: CNC (POLR)
 EBONY MACASSAR - SYCAMORE - LARCH: CNC (POLE)



ROSEBERRY

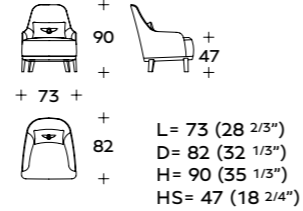

ARMCHAIR: POB (11)
 EBONY MACASSAR: POB (11E)



RUGBY

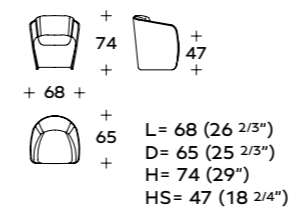

ARMCHAIR: POB (3)
 LACQUERED: POB (3L)
 CHESTNUT - BURR WALNUT: POB (3R)



SHERWOOD

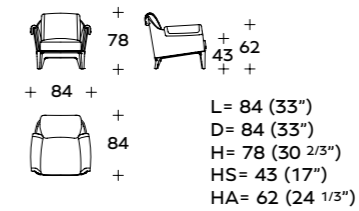

ARMCHAIR
 CHESTNUT - BURR WALNUT LEGS: POB (17E)

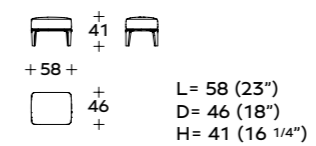

OTTOMAN
 CHESTNUT - BURR WALNUT LEGS: BPU (02E)



STAMFORD

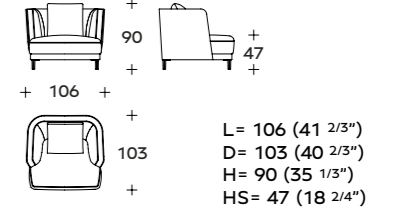

ARMCHAIR: SPI (POL)
 EBONY MACASSAR - EUCALYPTUS - SYCAMORE - LARCH: SPI (POLE)
 CHESTNUT - BURR WALNUT: SPI (POLR)



WICKHAM

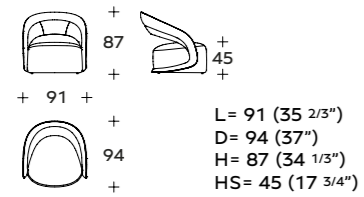

ARMCHAIR: RAM (POL)
 LACQUERED: RAT (POLL)
 BURR WALNUT: RAM (POLE)



WINSTON

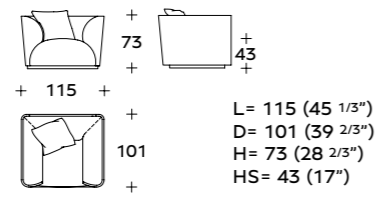

ARMCHAIR: MRB (POL)
 EBONY MACASSAR: MRB (POLE)
 CHESTNUT - BURR WALNUT: MRB (POLR)



TODD

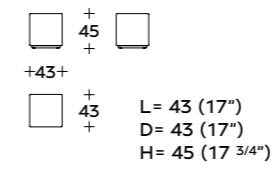

OTTOMAN: BPU (01)



DUNDEE

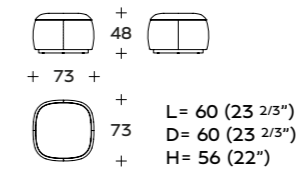

OTTOMAN: BPU (04P)

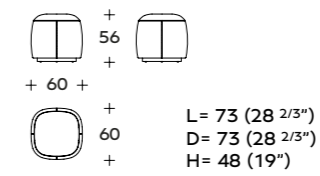

BIG OTTOMAN: BPU (04)



SHERWOOD

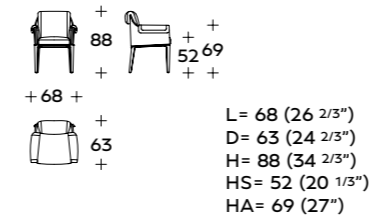

CHAIR WITH ARMRESTS
CHESTNUT - BURR WALNUT: SDB (11BE)



BARON

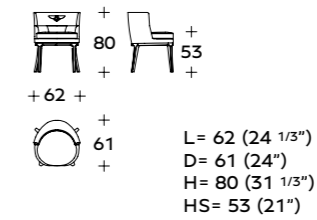

CHAIR: SDB (05)
SHEEPSKIN CHAIR: SDB (05F)



BELGRAVIA

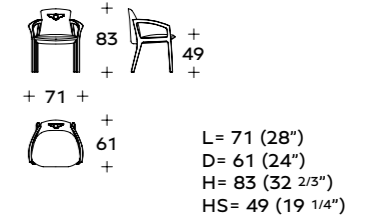

CHAIR
EBONY MACASSAR - SYCAMORE: SDB (07E)
CHESTNUT - BURR WALNUT: SDB (07R)

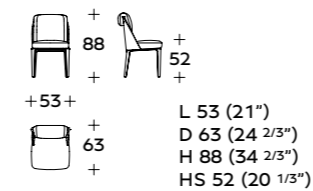

CHAIR
CHESTNUT - BURR WALNUT: SDB (11E)



HARLETTE

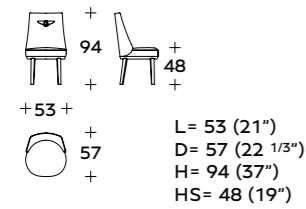

CHAIR: SDB (03E)



KENDAL

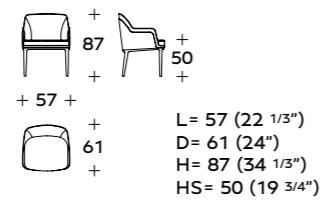

CHAIR: SDB (02)



MALVERN

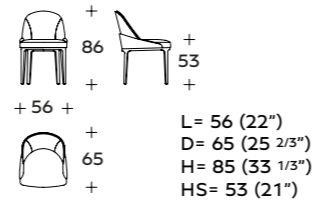

CHAIR: SDB (13)

EBONY MACASSAR - EUCALYPTUS - SYCAMORE - LARCH - LIQUIDAMBAR - CHESTNUT - BURR WALNUT: SDB (13E)



MORLEY

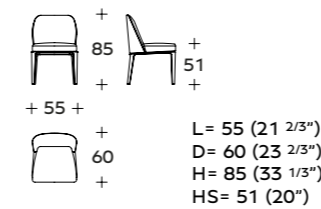

CHAIR: SDB (A12)

EUCALYPTUS - SYCAMORE - LARCH - LIQUIDAMBAR - CHESTNUT - BURR WALNUT: SDB (12)



STAMFORD

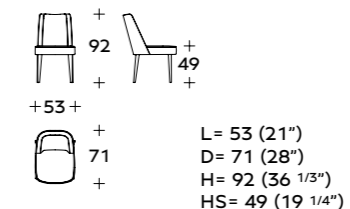

HIGH CHAIR: SDB (09)



THORNE

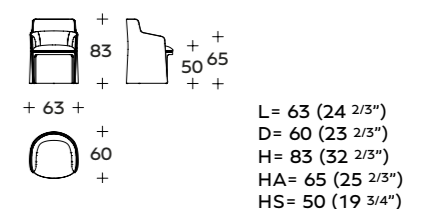

CHAIR: SDB (14)

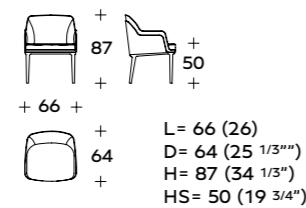

BIG CHAIR: SDB (04)

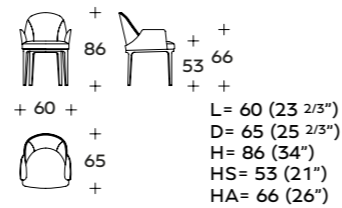

CHAIR WITH ARMRESTS: SDB (13B)

EBONY MACASSAR - EUCALYPTUS - SYCAMORE - LARCH - LIQUIDAMBAR - CHESTNUT - BURR WALNUT: SDB (13BE)

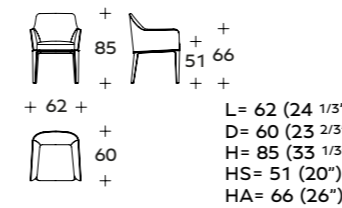

CHAIR WITH ARMRESTS: SDB (A12B)

EUCALYPTUS - SYCAMORE - LARCH - LIQUIDAMBAR - CHESTNUT - BURR WALNUT: SDB (12B)

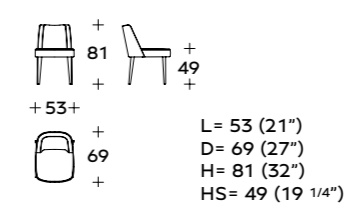

CHAIR: SDB (10)



ALSTON



BALMORAL

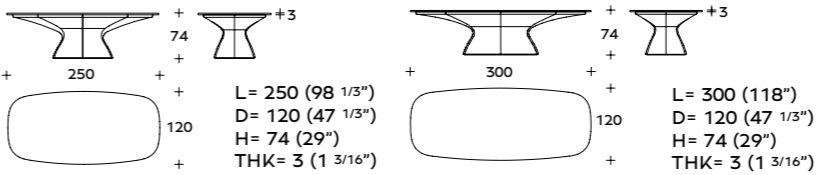

TABLE
TOP
EBONY MACASSAR - EUCALYPTUS -
SYCAMORE - CHESTNUT -
BURR WALNUT: BTV (17)

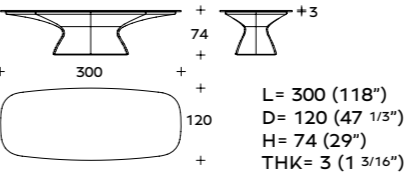

TABLE
TOP
EBONY MACASSAR - EUCALYPTUS -
SYCAMORE - CHESTNUT -
BURR WALNUT: BTV (13)

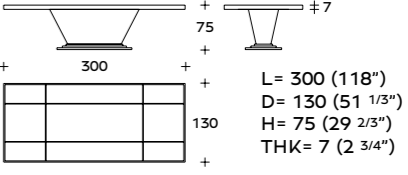

TABLE
CHESTNUT - BURR WALNUT CENTRAL
PANEL: BTV (01)

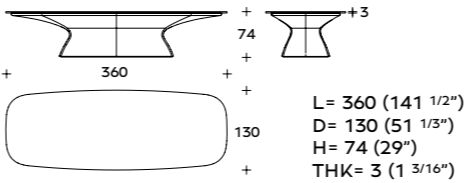

TABLE
TOP
EBONY MACASSAR - EUCALYPTUS -
SYCAMORE - CHESTNUT -
BURR WALNUT: BTV (14)



BUTTERFLY



HENLEY



MADELEY



MALDON

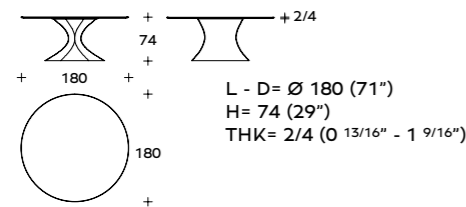

ROUND TABLE

TOP
EBONY MACASSAR - CHESTNUT -
BURR WALNUT: BTV (06)

MARBLE: BTV (06M)

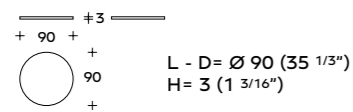

OPTIONAL
REVOLVING TRAY: VSB (GIR01)

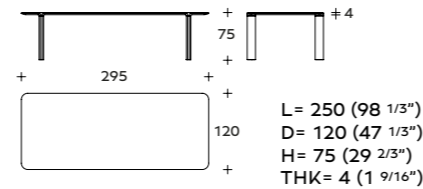

RECTANGULAR DINING TABLE

MARBLE TOP
LEATHER LEGS: BTV (27MP)
EBONY MACASSAR - EUCALYPTUS -
SYCAMORE - LARCH - LIQUIDAMBAR -
CHESTNUT - BURR WALNUT LEGS: BTV (27ME)

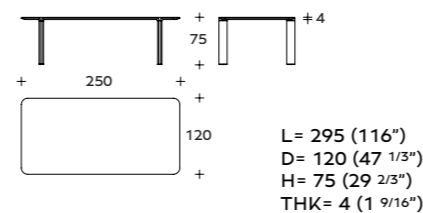

RECTANGULAR DINING TABLE

MARBLE TOP
LEATHER LEGS: BTV (26MP)
EBONY MACASSAR - EUCALYPTUS -
SYCAMORE - LARCH - LIQUIDAMBAR -
CHESTNUT - BURR WALNUT LEGS: BTV (26ME)

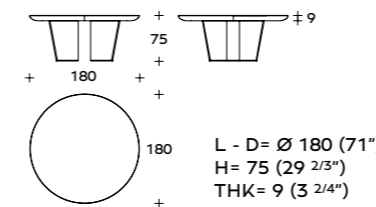

ROUND TABLE

TOP
EBONY MACASSAR - EUCALYPTUS -
SYCAMORE - CHESTNUT -
BURR WALNUT: BTV (02)

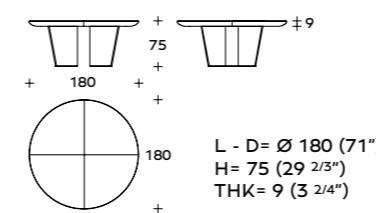

ROUND TABLE

TOP
LEATHER: BTV (02P)

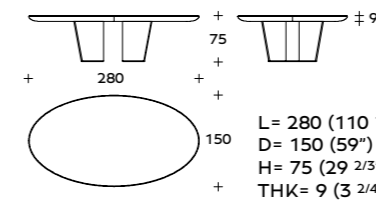

OVAL TABLE

TOP
EBONY MACASSAR - EUCALYPTUS -
SYCAMORE - CHESTNUT -
BURR WALNUT: BTV (03)

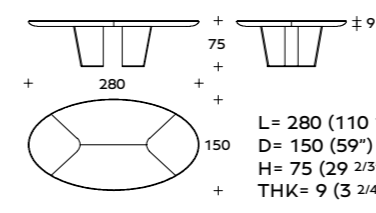

OVAL TABLE

TOP
LEATHER: BTV (03P)

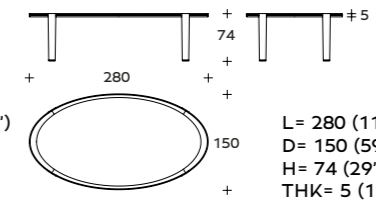

OVAL TABLE

EBONY MACASSAR - EUCALYPTUS -
SYCAMORE - LARCH - CHESTNUT -
BURR WALNUT TOP + LEGS: BTV (20E)

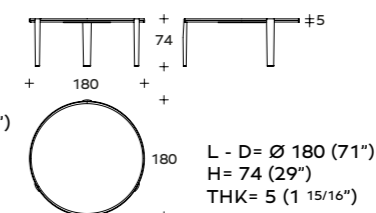

ROUND TABLE

EBONY MACASSAR - EUCALYPTUS -
SYCAMORE - LARCH - CHESTNUT -
BURR WALNUT TOP + LEGS:
BTV (23E)



ROUND TABLE WITH LAZY SUSAN
 $\varnothing 90 (\varnothing 35 1/3")$

EBONY MACASSAR - EUCALYPTUS -
SYCAMORE - LARCH - CHESTNUT -
BURR WALNUT TOP + LEGS:
BTV (23EO)



SHERWOOD

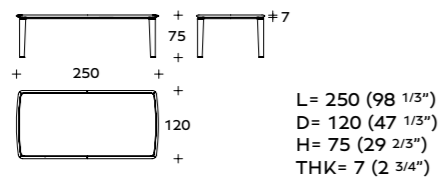

- TABLE
- GLASS TOP + EBONY MACASSAR - EUCALYPTUS - SYCAMORE - CHESTNUT - BURR WALNUT LEGS: BTV (15VE)
 - EBONY MACASSAR - EUCALYPTUS - SYCAMORE - CHESTNUT - BURR WALNUT TOP + LEGS: BTV (15EE)
 - LEATHER LEGS + EBONY MACASSAR - EUCALYPTUS - SYCAMORE - CHESTNUT - BURR WALNUT TOP: BTV (15EP)
 - LEATHER LEGS + GLAZE SLATE - GLAZE EARTH LACQUERED TOP: BTV (15LP)

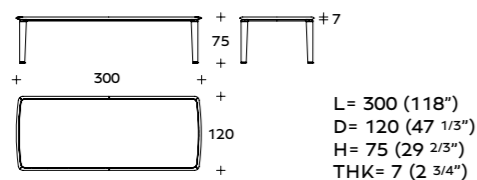

- TABLE
- GLASS TOP + EBONY MACASSAR - EUCALYPTUS - SYCAMORE - CHESTNUT - BURR WALNUT LEGS: BTV (16VE)
 - EBONY MACASSAR - EUCALYPTUS - SYCAMORE - CHESTNUT - BURR WALNUT TOP + LEGS: BTV (16EE)
 - LEATHER LEGS + EBONY MACASSAR - EUCALYPTUS - SYCAMORE - CHESTNUT - BURR WALNUT TOP: BTV (16EP)
 - LEATHER LEGS + GLAZE SLATE - GLAZE EARTH LACQUERED TOP: BTV (16LP)



WHITBY

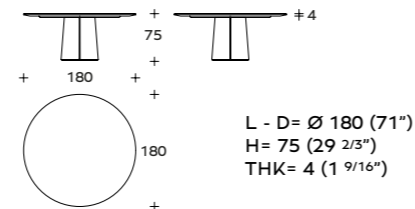

- TABLE
- LEATHER BASE + EBONY MACASSAR - EUCALYPTUS - SYCAMORE - LARCH - LIQUIDAMBAR - CHESTNUT - BURR WALNUT TOP: BTV (25EP)
 - EBONY MACASSAR - EUCALYPTUS - SYCAMORE - LARCH - LIQUIDAMBAR - CHESTNUT - BURR WALNUT TOP + BASE: BTV (25E)

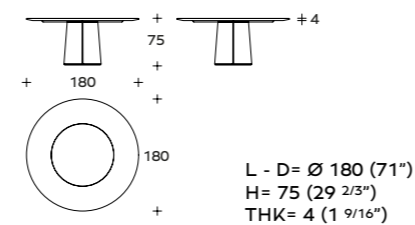

- TABLE WITH LAZY SUSAN
- LEATHER BASE + EBONY MACASSAR - EUCALYPTUS - SYCAMORE - LARCH - LIQUIDAMBAR - CHESTNUT - BURR WALNUT TOP: BTV (25EPO)
 - EBONY MACASSAR - EUCALYPTUS - SYCAMORE - LARCH - LIQUIDAMBAR - CHESTNUT - BURR WALNUT TOP + BASE: BTV (25EO)





HARROW

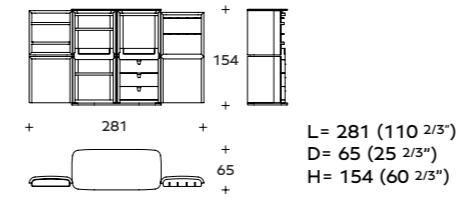

BAR CABINET

EBONY MACASSAR - EUCALYPTUS -
 SYCAMORE - LARCH - LIQUIDAMBAR -
 CHESTNUT - BURR WALNUT: MDB (18E)



HARROW

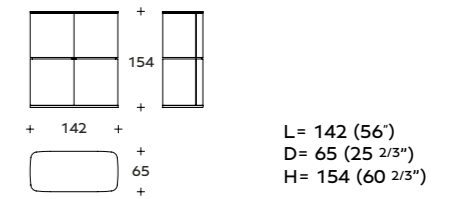

TALL CABINET

EBONY MACASSAR - EUCALYPTUS -
 SYCAMORE - LARCH - LIQUIDAMBAR -
 CHESTNUT - BURR WALNUT: MDB (19E)



ALTON

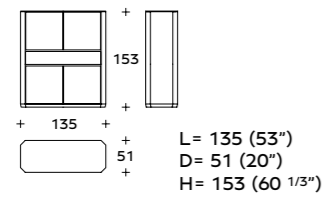

CABINET

EBONY MACASSAR - EUCALYPTUS - SYCAMORE - CHESTNUT - BURR WALNUT: BMB (06)



AMBASSADOR

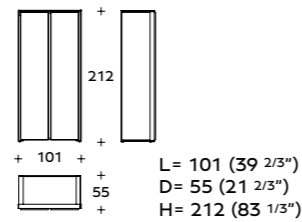

CABINET 1

WOODEN CABINET

LEATHER FRAME AND DOORS: BMB (03PP)

EBONY MACASSAR - EUCALYPTUS - SYCAMORE - LIQUIDAMBAR FRAME AND DOORS: BMB (03EE)

CHESTNUT - BURR WALNUT FRAME AND DOORS: BMB (03RR)

LEATHER FRAME + EBONY MACASSAR - EUCALYPTUS - SYCAMORE - LIQUIDAMBAR DOORS: BMB (03PE)

LEATHER FRAME + CHESTNUT - BURR WALNUT DOORS: BMB (03PR)

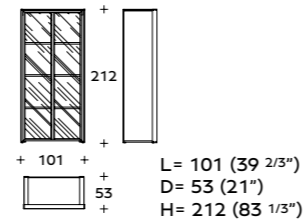

CABINET 2

WOODEN CABINET WITH GLASS DOORS

FRAME LEATHER: BMB (03PV)

EBONY MACASSAR - EUCALYPTUS - LIQUIDAMBAR - SYCAMORE: BMB (03EV)

CHESTNUT - BURR WALNUT: BMB (03RV)



EASTGATE

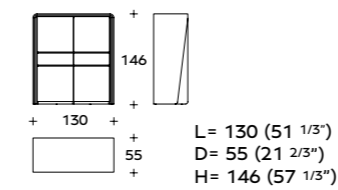

CABINET

CHESTNUT - BURR WALNUT FRAME + LEATHER DOORS: MDB (17RP)

EUCALYPTUS - SYCAMORE - LARCH - LIQUIDAMBAR - FRAME + LEATHER DOORS: MDB (17EP)

GLAZE EARTH - GLAZE SLATE - GLAZE GREIGE LACQUERED FRAME + LEATHER DOORS: MDB (17LP)



KINGSBRIDGE

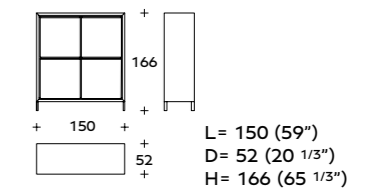

CABINET

DOORS

LEATHER: MDB (04P)
CHESTNUT - BURR WALNUT - EUCALYPTUS - SYCAMORE: MDB (04R)



LENDAL

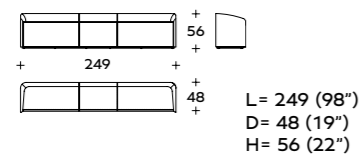

TV CABINET

LEATHER: MDB (15P)



WILSON

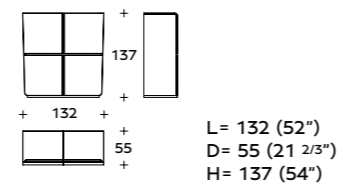

CABINET

EBONY MACASSAR - SYCAMORE -
CHESTNUT - BURR WALNUT: BMB (08E)

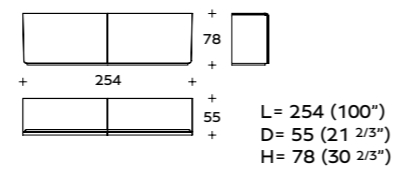

LOW CABINET

EBONY MACASSAR - SYCAMORE -
CHESTNUT - BURR WALNUT: BMB (07E)



AMBASSADOR

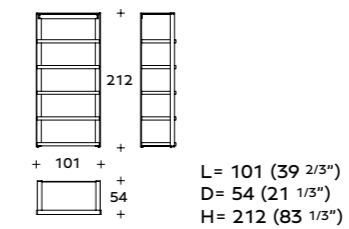

BOOKSHELF

EBONY MACASSAR - EUCALYPTUS -
SYCAMORE - LIQUIDAMBAR: BMB (02E)
CHESTNUT - BURR WALNUT: BMB (02R)



chest of drawers



HAROLD

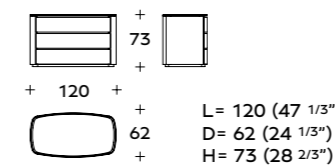

CHEST OF DRAWERS

TOP
GLASS - EBONY MACASSAR -
CHESTNUT - BURR WALNUT: BMB (05)
LEATHER: BMB (05P)

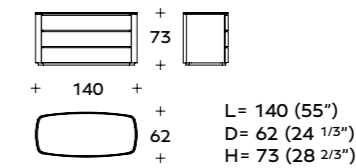

CHEST OF DRAWERS

TOP
GLASS - EBONY MACASSAR -
CHESTNUT - BURR WALNUT: BMB (11)
LEATHER: BMB (11P)

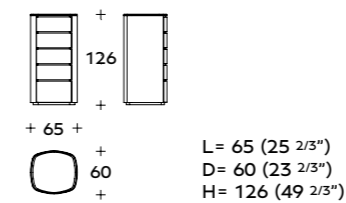

CHEST OF DRAWERS "SETTIMINO"

TOP
GLASS - EBONY MACASSAR -
CHESTNUT - BURR WALNUT: BMB (04)
LEATHER: BMB (04P)



chest of drawers



AMBLESIDE

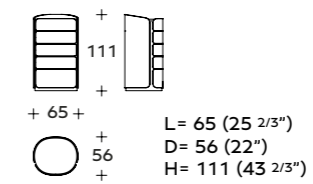
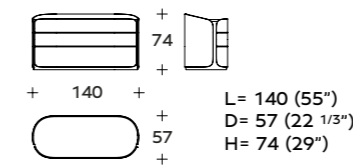

CHEST OF DRAWERS

EBONY MACASSAR - EUCALYPTUS - SYCAMORE - LARCH - CHESTNUT - BURR WALNUT: BMB (18E)

LEATHER TOP + EBONY MACASSAR - EUCALYPTUS - SYCAMORE - LARCH - LIQUIDAMBAR - CHESTNUT - BURR WALNUT FRAME: BMB (18P)

CHEST OF DRAWERS "SETTIMINO"

EBONY MACASSAR - EUCALYPTUS - SYCAMORE - LARCH - CHESTNUT - BURR WALNUT: BMB (17E)

LEATHER TOP + EBONY MACASSAR - EUCALYPTUS - SYCAMORE - LARCH - LIQUIDAMBAR - CHESTNUT - BURR WALNUT FRAME: BMB (17P)



EASTGATE



LANES



RUBENS

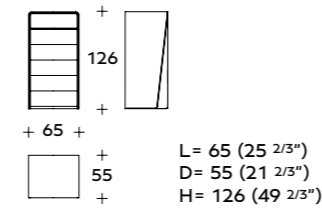
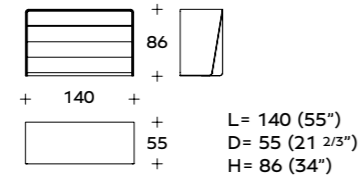
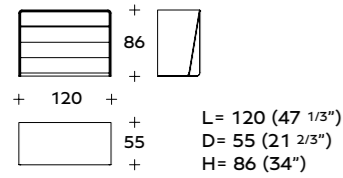

RIGHT OR LEFT CHEST OF DRAWERS

LEATHER DRAWERS + EUCALYPTUS - SYCAMORE - LARCH - LIQUIDAMBAR - CHESTNUT - BURR WALNUT FRAME: BMB (14ED) - BMB (14ES)

LEATHER DRAWERS + GLAZE EARTH - GLAZE SLATE - GLAZE GREIGE LACQUERED TOP: BMB (14LD) - BMB (14LS)

Drawing: left element

RIGHT OR LEFT CHEST OF DRAWERS

LEATHER DRAWERS + EUCALYPTUS - SYCAMORE - LARCH - LIQUIDAMBAR - CHESTNUT - BURR WALNUT FRAME: BMB (15ED) - BMB (15ES)

LEATHER DRAWERS + GLAZE EARTH - GLAZE SLATE - GLAZE GREIGE LACQUERED TOP: BMB (15LD) - BMB (15LS)

Drawing: left element

RIGHT OR LEFT CHEST OF DRAWERS "SETTIMINO"

LEATHER DRAWERS + EUCALYPTUS - SYCAMORE - LARCH - LIQUIDAMBAR - CHESTNUT - BURR WALNUT FRAME: BMB (16ED) - BMB (16ES)

LEATHER DRAWERS + GLAZE EARTH - GLAZE SLATE LACQUERED TOP: BMB (16LD) - BMB (16LS)

Drawing: left element

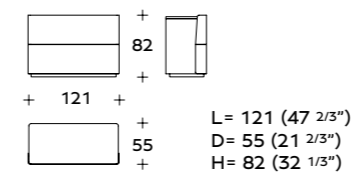

CHEST OF DRAWERS

TOP
EBONY MACASSAR - SYCAMORE - CHESTNUT - BURR WALNUT: BMB (12)

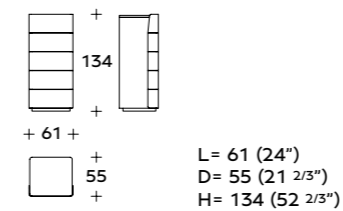

CHEST OF DRAWERS "SETTIMINO"

TOP
EBONY MACASSAR - SYCAMORE - CHESTNUT - BURR WALNUT: BMB (13)

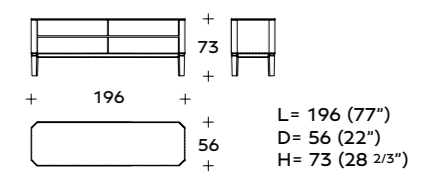

CHEST OF DRAWERS

EBONY MACASSAR - CHESTNUT - BURR WALNUT DRAWERS: COB (04)



EASTGATE

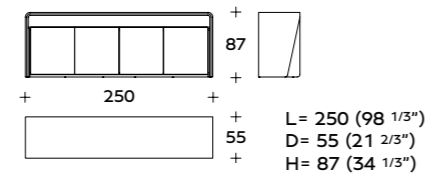

SIDEBOARD

CHESTNUT - BURR WALNUT FRAME +
LEATHER DOORS: MDB (16RP)

EUCALYPTUS - SYCAMORE - LARCH - LIQUIDAMBAR
FRAME + LEATHER DOORS: MDB (16EP)

GLAZE EARTH - GLAZE SLATE - GLAZE GREIGE
LACQUERED FRAME + LEATHER DOORS: MDB (16LP)



HAROLD

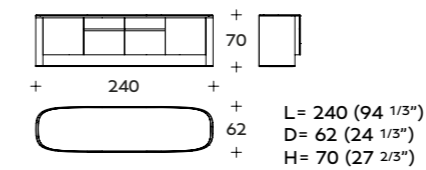

SIDEBOARD 2 DOORS 4 DRAWERS

GLASS TOP + EBONY MACASSAR -
LARCH - CHESTNUT - BURR WALNUT:
MDB (11)

LEATHER TOP + EBONY MACASSAR -
LARCH - CHESTNUT - BURR WALNUT:
MDB (11P)

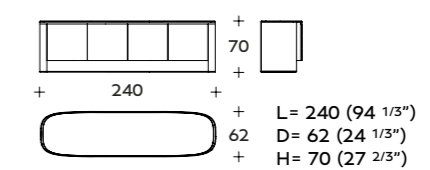

SIDEBOARD 4 DOORS

GLASS TOP + EBONY MACASSAR -
LARCH - CHESTNUT - BURR WALNUT:
MDB (12)

LEATHER TOP + EBONY MACASSAR -
LARCH - CHESTNUT - BURR WALNUT:
MDB (12P)



HARROW



HARROW

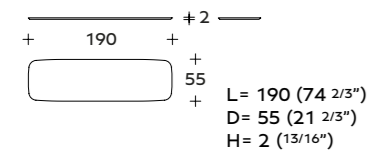

SECTIONAL SIDEBOARD TOP

MARBLE: BMB (19TOPE1)
LEATHER: BMB (19TOPP1)

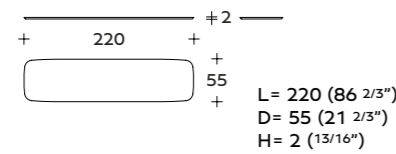

SECTIONAL SIDEBOARD TOP

MARBLE: BMB (19TOPE2)
LEATHER: BMB (19TOPP2)

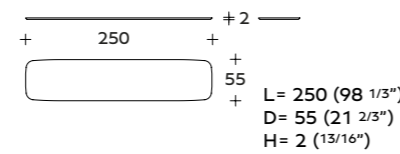

SECTIONAL SIDEBOARD TOP

MARBLE: BMB (19TOPE3)
LEATHER: BMB (19TOPP3)

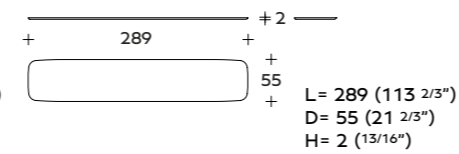

SECTIONAL SIDEBOARD TOP

MARBLE: BMB (19TOPE4)
LEATHER: BMB (19TOPP4)

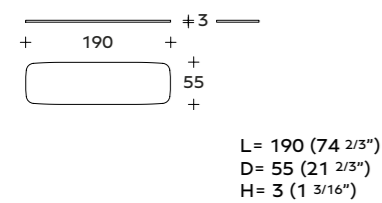

SECTIONAL SIDEBOARD BASE

EBONY MACASSAR - EUCALYPTUS - SYCAMORE - LARCH - LIQUIDAMBAR - CHESTNUT - BURR WALNUT: BMB (19BASE1)
LEATHER: BMB (19BASP1)

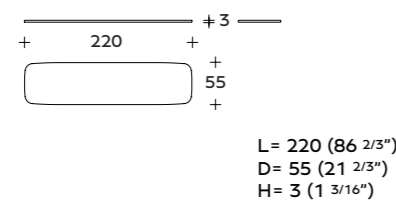

SECTIONAL SIDEBOARD BASE

EBONY MACASSAR - EUCALYPTUS - SYCAMORE - LARCH - LIQUIDAMBAR - CHESTNUT - BURR WALNUT: BMB (19BASE2)
LEATHER: BMB (19BASP2)

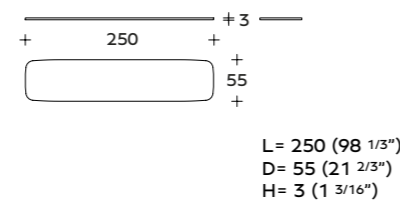

SECTIONAL SIDEBOARD BASE

EBONY MACASSAR - EUCALYPTUS - SYCAMORE - LARCH - LIQUIDAMBAR - CHESTNUT - BURR WALNUT: BMB (19BASE3)
LEATHER: BMB (19BASP3)

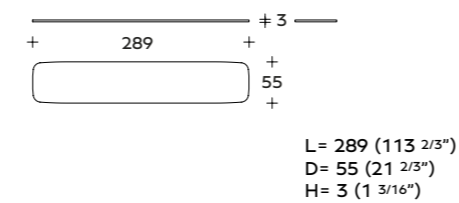

SECTIONAL SIDEBOARD BASE

EBONY MACASSAR - EUCALYPTUS - SYCAMORE - LARCH - LIQUIDAMBAR - CHESTNUT - BURR WALNUT: BMB (19BASE4)
LEATHER: BMB (19BASP4)

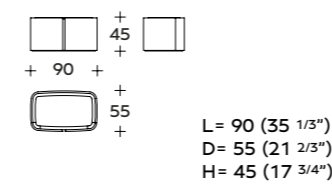

SECTIONAL SIDEBOARD: LOW ELEMENT WITH SHUTTER

EBONY MACASSAR - EUCALYPTUS - SYCAMORE - LARCH - LIQUIDAMBAR - CHESTNUT - BURR WALNUT: BMB (19M90ABE)
LEATHER: BMB (19M90ABP)

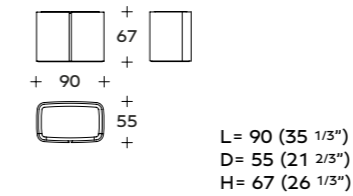

SECTIONAL SIDEBOARD: HIGH ELEMENT WITH SHUTTER

EBONY MACASSAR - EUCALYPTUS - SYCAMORE - LARCH - LIQUIDAMBAR - CHESTNUT - BURR WALNUT: BMB (19M90AAE)
LEATHER: BMB (19M90AAP)

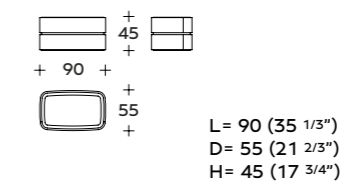

SECTIONAL SIDEBOARD: LOW ELEMENT WITH DRAWERS

EBONY MACASSAR - EUCALYPTUS - SYCAMORE - LARCH - LIQUIDAMBAR - CHESTNUT - BURR WALNUT: BMB (19M90CBE)
LEATHER: BMB (19M90CBP)

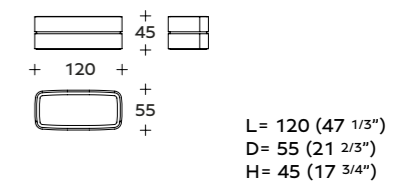

SECTIONAL SIDEBOARD: LOW ELEMENT WITH DRAWERS

EBONY MACASSAR - EUCALYPTUS - SYCAMORE - LARCH - LIQUIDAMBAR - CHESTNUT - BURR WALNUT: BMB (19M120CBE)
LEATHER: BMB (19M120CBP)

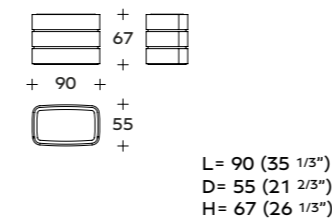

SECTIONAL SIDEBOARD: HIGH ELEMENT WITH DRAWERS

EBONY MACASSAR - EUCALYPTUS - SYCAMORE - LARCH - LIQUIDAMBAR - CHESTNUT - BURR WALNUT: BMB (19M90CAE)
LEATHER: BMB (19M90CAP)

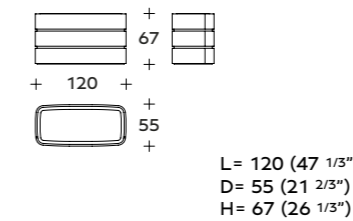

SECTIONAL SIDEBOARD: HIGH ELEMENT WITH DRAWERS

EBONY MACASSAR - EUCALYPTUS - SYCAMORE - LARCH - LIQUIDAMBAR - CHESTNUT - BURR WALNUT: BMB (19M120CAE)
LEATHER: BMB (19M120CAP)

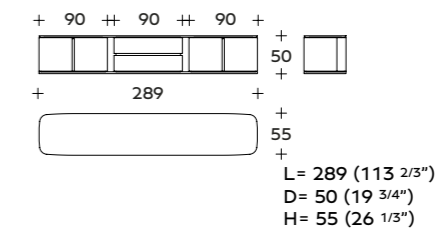

SECTIONAL SIDEBOARD EXAMPLE: LOW ELEMENT WITH DRAWERS

BMB (19BASE4) + BMB (19M90ABE) + BMB (19M90CBE) + BMB (19M120CBE) + BMB (19TOPE4)

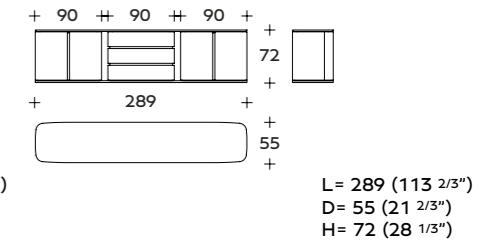

SECTIONAL SIDEBOARD EXAMPLE: HIGH ELEMENT WITH DRAWERS

BMB (19BASE4) + BMB (19M90AAE) + BMB (19M90CAE) + BMB (19M120CAE) + BMB (19TOPE4)



KENSINGTON



LENDAL



SHERBOURNE

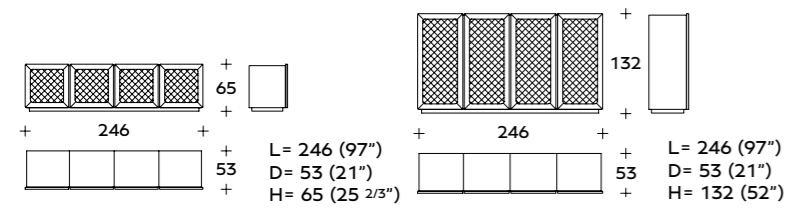

SIDEBOARD 4 DOORS
LEATHER: MDB (06P)

HIGH SIDEBOARD 4 DOORS
LEATHER: MDB (08P)

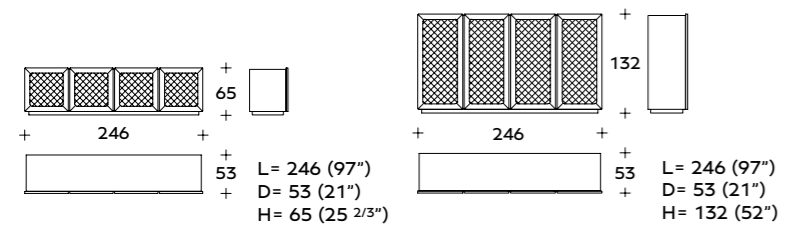

SIDEBOARD 4 DOORS

EBONY MACASSAR - EUCALYPTUS -
SYCAMORE - LARCH: MDB (06E)
CHESTNUT - BURR WALNUT:
MDB (06R)

HIGH SIDEBOARD 4 DOORS

EBONY MACASSAR - EUCALYPTUS -
SYCAMORE - LARCH: MDB (08E)
CHESTNUT - BURR WALNUT:
MDB (08R)

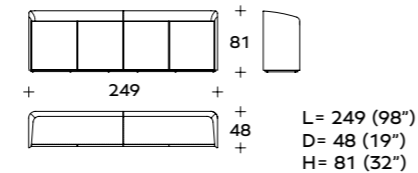

SIDEBOARD

LEATHER: MDB (14P)

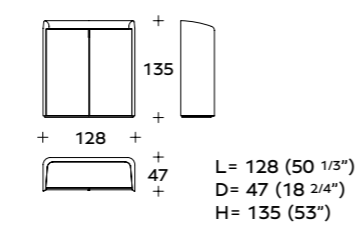

CUPBOARD

LEATHER: MDB (13P)

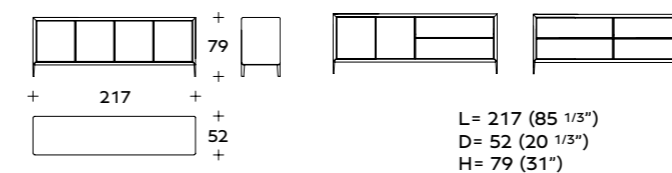

SIDEBOARD 2 DOORS + 2 DRAWERS LEATHER: MDB (02P)

SIDEBOARD 4 DRAWERS LEATHER: MDB (03P)

SIDEBOARD 4 DOORS: MDB (05P)

SIDEBOARD 2 DOORS + 2 DRAWERS
CHESTNUT - BURR WALNUT: MDB (02R)

SIDEBOARD 4 DRAWERS
CHESTNUT - BURR WALNUT: MDB (03R)

SIDEBOARD 4 DOORS
CHESTNUT - BURR WALNUT: MDB (05R)



CLIFFDEN

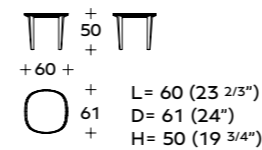

SIDE TABLE
LEATHER FRAME
TOP
EBONY MACASSAR - EUCALYPTUS - SYCAMORE - LARCH - LIQUIDAMBAR - CHESTNUT - BURR WALNUT: CTB (12P)

AMERICAN WALNUT FRAME
TOP
GLASS: CTB (12E)
LEATHER: CTB (12EP)

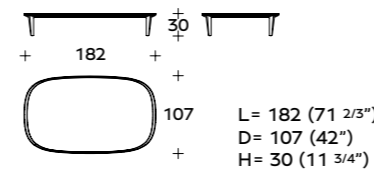

COFFEE TABLE
LEATHER FRAME
TOP
EBONY MACASSAR - EUCALYPTUS SYCAMORE - LARCH - LIQUIDAMBAR - CHESTNUT - BURR WALNUT: CTB (11P)

AMERICAN WALNUT FRAME
TOP
GLASS: CTB (11E)
LEATHER: CTB (11EP)

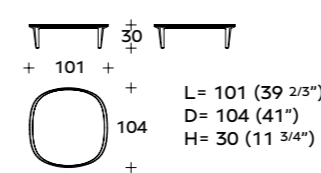

COFFEE TABLE
LEATHER FRAME
TOP
EBONY MACASSAR - EUCALYPTUS - SYCAMORE - LARCH - LIQUIDAMBAR - CHESTNUT - BURR WALNUT: CTB (10P)

AMERICAN WALNUT FRAME
TOP
GLASS: CTB (10E)
LEATHER: CTB (10EP)



KEPI

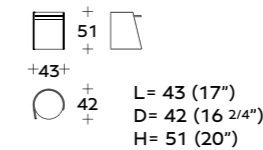

SIDE TABLE
TOP
LEATHER: CTB (09PP/2)
EBONY MACASSAR - EUCALYPTUS - SYCAMORE - LARCH: CTB (09EP/2)
CHESTNUT - BURR WALNUT: CTB (09RP/2)

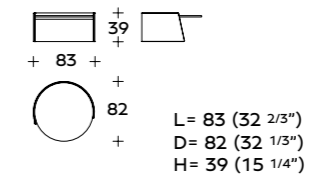

COFFEE TABLE
TOP
LEATHER: CTB (09PP/3)
EBONY MACASSAR - EUCALYPTUS - SYCAMORE - LARCH: CTB (09EP/3)
CHESTNUT - BURR WALNUT: CTB (09RP/3)

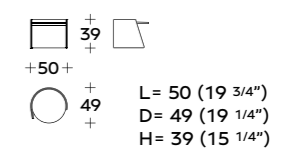

COFFEE TABLE
TOP
LEATHER: CTB (09PP/1)
EBONY MACASSAR - EUCALYPTUS - SYCAMORE - LARCH: CTB (09EP/1)
CHESTNUT - BURR WALNUT: CTB (09RP/1)



KEW

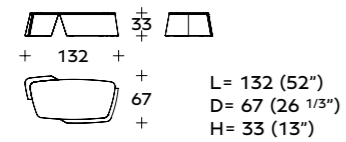

COFFEE TABLE: CTB (20P)

TOP
 EBONY MACASSAR - CHESTNUT -
 BURR WALNUT: CTB (20E)

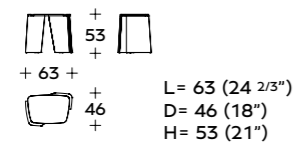

SIDE TABLE: CTB (21P)

TOP
 EBONY MACASSAR - CHESTNUT -
 BURR WALNUT: CTB (21E)



LEWES

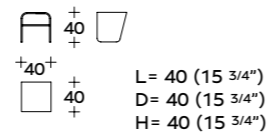

COFFEE TABLE

FRAME
 EBONY MACASSAR: CTB (18E)
 CHESTNUT - BURR WALNUT: CTB (18R)

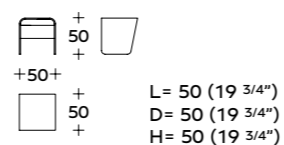

SIDE TABLE

FRAME
 EBONY MACASSAR: CTB (19E)
 CHESTNUT - BURR WALNUT: CTB (19R)



MADELEY

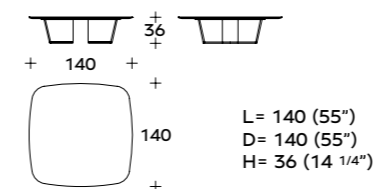

COFFEE TABLE

TOP
 MARBLE: CTB (07M)

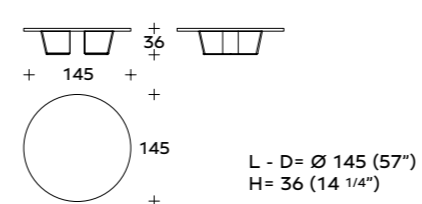

COFFEE TABLE

TOP
 MARBLE: CTB (08M)
 EBONY MACASSAR - EUCALYPTUS -
 SYCAMORE: CTB (08E)
 CHESTNUT - BURR WALNUT: CTB (08R)



MATLOCK

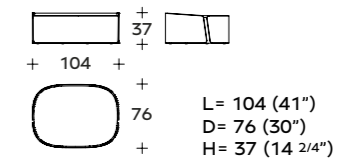

COFFEE TABLE

TOP
 EBONY MACASSAR - EUCALYPTUS -
 SYCAMORE - LARCH - LIQUIDAMBAR -
 CHESTNUT - BURR WALNUT: CTB (24E)
 LEATHER: CTB (24P)

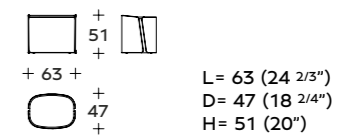

SIDE TABLE

TOP
 EBONY MACASSAR - EUCALYPTUS -
 SYCAMORE - LARCH - LIQUIDAMBAR -
 CHESTNUT - BURR WALNUT: CTB (25E)
 LEATHER: CTB (25P)



NESTON



NESTON

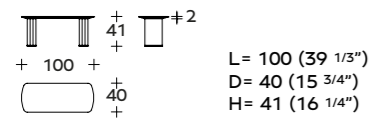

COFFEE TABLE

LEATHER LEGS + TOP: CTB (31PP)
EBONY MACASSAR - EUCALYPTUS - SYCAMORE - LARCH - LIQUIDAMBAR - CHESTNUT - BURR WALNUT LEGS + LEATHER TOP: CTB (31PE)

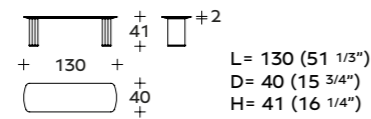

COFFEE TABLE

LEATHER LEGS + TOP: CTB (29PP)
EBONY MACASSAR - EUCALYPTUS - SYCAMORE - LARCH - LIQUIDAMBAR - CHESTNUT - BURR WALNUT LEGS + LEATHER TOP: CTB (29PE)

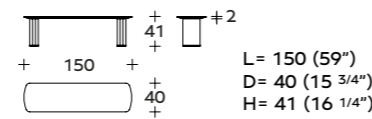

COFFEE TABLE

LEATHER LEGS + TOP: CTB (27PP)
EBONY MACASSAR - EUCALYPTUS - SYCAMORE - LARCH - LIQUIDAMBAR - CHESTNUT - BURR WALNUT LEGS + LEATHER TOP: CTB (27PE)

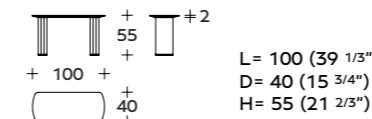

SIDE TABLE

LEATHER LEGS + TOP: CTB (30PP)
EBONY MACASSAR - EUCALYPTUS - SYCAMORE - LARCH - LIQUIDAMBAR - CHESTNUT - BURR WALNUT LEGS + LEATHER TOP: CTB (30PE)

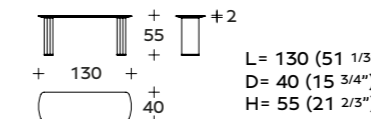

SIDE TABLE

LEATHER LEGS + TOP: CTB (28PP)
EBONY MACASSAR - EUCALYPTUS - SYCAMORE - LARCH - LIQUIDAMBAR - CHESTNUT - BURR WALNUT LEGS + LEATHER TOP: CTB (28PE)

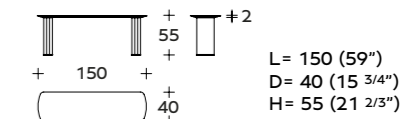

SIDE TABLE

LEATHER LEGS + TOP: CTB (26PP)
EBONY MACASSAR - EUCALYPTUS - SYCAMORE - LARCH - LIQUIDAMBAR - CHESTNUT - BURR WALNUT LEGS + LEATHER TOP: CTB (26PE)

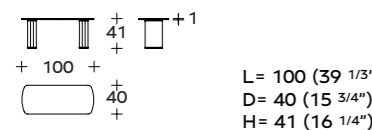

COFFEE TABLE

GLASS TOP + LEATHER LEGS: CTB (31VP)

GLASS TOP + EBONY MACASSAR - EUCALYPTUS - SYCAMORE - LARCH - LIQUIDAMBAR - CHESTNUT - BURR WALNUT LEGS: CTB (31VE)

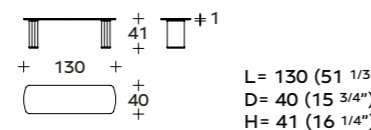

COFFEE TABLE

GLASS TOP + LEATHER LEGS: CTB (29VP)

GLASS TOP + EBONY MACASSAR - EUCALYPTUS - SYCAMORE - LARCH - LIQUIDAMBAR - CHESTNUT - BURR WALNUT LEGS: CTB (29VE)

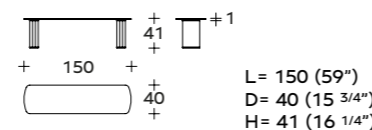

COFFEE TABLE

GLASS TOP + LEATHER LEGS: CTB (27VP)

GLASS TOP + EBONY MACASSAR - EUCALYPTUS - SYCAMORE - LARCH - LIQUIDAMBAR - CHESTNUT - BURR WALNUT LEGS: CTB (27VE)

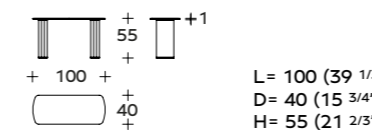

SIDE TABLE

GLASS TOP + LEATHER LEGS: CTB (30VP)

GLASS TOP + EBONY MACASSAR - EUCALYPTUS - SYCAMORE - LARCH - LIQUIDAMBAR - CHESTNUT - BURR WALNUT LEGS: CTB (30VE)

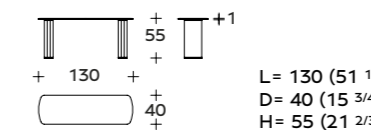

SIDE TABLE

GLASS TOP + LEATHER LEGS: CTB (28VP)

GLASS TOP + EBONY MACASSAR - EUCALYPTUS - SYCAMORE - LARCH - LIQUIDAMBAR - CHESTNUT - BURR WALNUT LEGS: CTB (28VE)

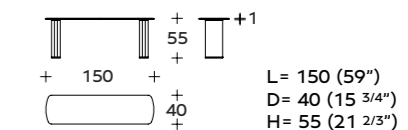

SIDE TABLE

GLASS TOP + LEATHER LEGS: CTB (26VP)

GLASS TOP + EBONY MACASSAR - EUCALYPTUS - SYCAMORE - LARCH - LIQUIDAMBAR - CHESTNUT - BURR WALNUT LEGS: CTB (26VE)



NESTON



SAXON

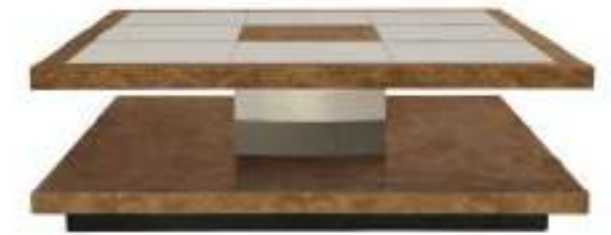

YORK

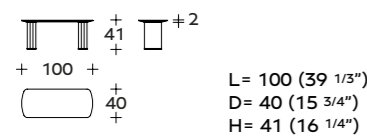

MARBLE COFFEE TABLE

MARBLE TOP + EBONY MACASSAR - EUCALYPTUS - SYCAMORE - LARCH - LIQUIDAMBAR - CHESTNUT - BURR WALNUT LEGS: CTB (31ME)

MARBLE TOP + LEATHER LEGS: CTB (31MP)

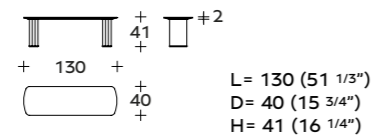

MARBLE COFFEE TABLE

MARBLE TOP + EBONY MACASSAR - EUCALYPTUS - SYCAMORE - LARCH - LIQUIDAMBAR - CHESTNUT - BURR WALNUT LEGS: CTB (29ME)

MARBLE TOP + LEATHER LEGS: CTB (29MP)

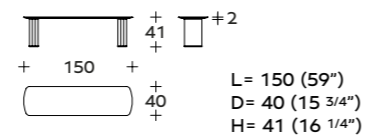

MARBLE COFFEE TABLE

MARBLE TOP + EBONY MACASSAR - EUCALYPTUS - SYCAMORE - LARCH - LIQUIDAMBAR - CHESTNUT - BURR WALNUT LEGS: CTB (27ME)

MARBLE TOP + LEATHER LEGS: CTB (27MP)

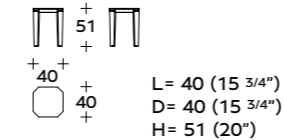

COFFEE TABLE

EBONY MACASSAR - CHESTNUT - BURR WALNUT: CTB (14)

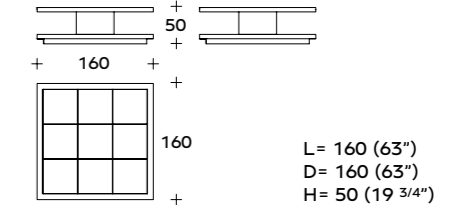

COFFEE TABLE

CHESTNUT - BURR WALNUT: CTB (03)

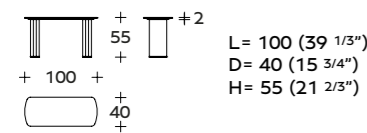

MARBLE SIDE TABLE

MARBLE TOP + EBONY MACASSAR - EUCALYPTUS - SYCAMORE - LARCH - LIQUIDAMBAR - CHESTNUT - BURR WALNUT LEGS: CTB (30ME)

MARBLE TOP + LEATHER LEGS: CTB (30MP)

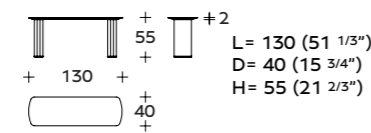

MARBLE SIDE TABLE

MARBLE TOP + EBONY MACASSAR - EUCALYPTUS - SYCAMORE - LARCH - LIQUIDAMBAR - CHESTNUT - BURR WALNUT LEGS: CTB (28ME)

MARBLE TOP + LEATHER LEGS: CTB (28MP)

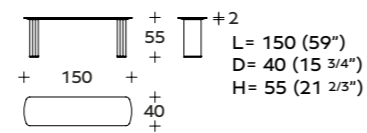

MARBLE SIDE TABLE

MARBLE TOP + EBONY MACASSAR - EUCALYPTUS - SYCAMORE - LARCH - LIQUIDAMBAR - CHESTNUT - BURR WALNUT LEGS: CTB (26ME)

MARBLE TOP + LEATHER LEGS: CTB (26MP)

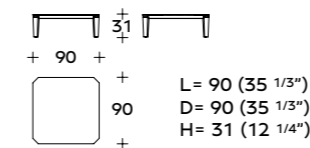

COFFEE TABLE

EBONY MACASSAR - CHESTNUT - BURR WALNUT: CTB (13)



SHERWOOD



SHERWOOD CLASS



TADLEY

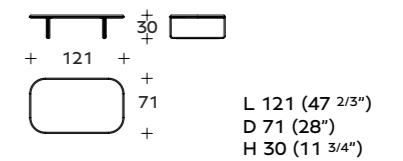
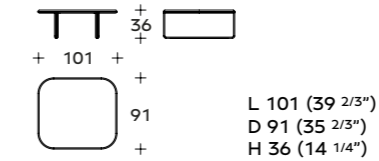
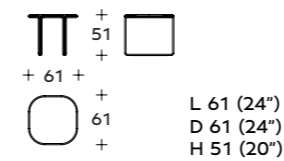
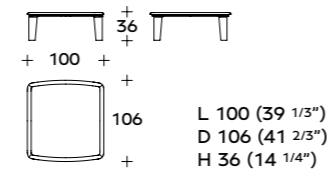
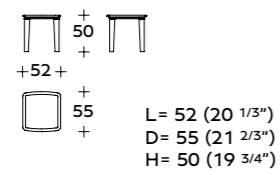
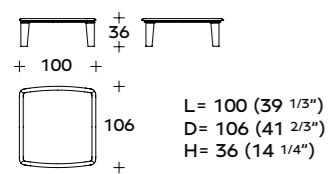

COFFEE TABLE

LEATHER TOP + LEGS: CTB (23PP)

LEATHER TOP + EBONY MACASSAR - EUCALYPTUS - SYCAMORE - LARCH - CHESTNUT - BURR WALNUT LEGS: CTB (23PE)

LEATHER LEGS + EBONY MACASSAR - EUCALYPTUS - SYCAMORE - LARCH - CHESTNUT - BURR WALNUT TOP: CTP (23EP)

EBONY MACASSAR - EUCALYPTUS - SYCAMORE - LARCH - CHESTNUT - BURR WALNUT TOP + LEGS: CTP (23EE)

MARBLE TOP + LEATHER LEGS: CTB (23MP)

SIDE TABLE

LEATHER TOP + LEGS: CTB (22PP)

LEATHER TOP + EBONY MACASSAR - EUCALYPTUS - SYCAMORE - LARCH - CHESTNUT - BURR WALNUT LEGS: CTB (22PE)

LEATHER LEGS + EBONY MACASSAR - EUCALYPTUS - SYCAMORE - LARCH - CHESTNUT - BURR WALNUT TOP: CTP (22EP)

EBONY MACASSAR - EUCALYPTUS - SYCAMORE - LARCH - CHESTNUT - BURR WALNUT TOP + LEGS: CTP (22EE)

MARBLE TOP + LEATHER LEGS: CTB (22MP)

COFFEE TABLE: CTB (23LL)

LEATHER LEGS + GLAZE EARTH - GLAZE SLATE LACQUERED TOP: CTB (23LP)

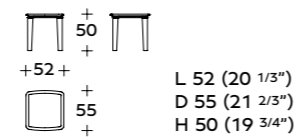

SIDE TABLE: CTB (22LL)

LEATHER LEGS + GLAZE EARTH - GLAZE SLATE LACQUERED TOP: CTB (22LP)

SIDE TABLE

EBONY MACASSAR - EUCALYPTUS - SYCAMORE - LARCH - LIQUIDAMBAR - CHESTNUT - BURR WALNUT TOP + LACQUERED LEGS: CTB (34EL)

EBONY MACASSAR - EUCALYPTUS - SYCAMORE - LARCH - LIQUIDAMBAR - CHESTNUT - BURR WALNUT TOP + LEATHER LEGS: CTB (34EP)

MARBLE TOP + LACQUERED LEGS: CTB (34ML)

MARBLE TOP + LEATHER LEGS: CTB (34MP)

LEATHER TOP + LACQUERED LEGS: CTB (34PL)

LEATHER TOP AND LEGS: CTB (34PP)

COFFEE TABLE

EBONY MACASSAR - EUCALYPTUS - SYCAMORE - LARCH - LIQUIDAMBAR - CHESTNUT - BURR WALNUT TOP + LACQUERED LEGS: CTB (32EL)

EBONY MACASSAR - EUCALYPTUS - SYCAMORE - LARCH - LIQUIDAMBAR - CHESTNUT - BURR WALNUT TOP + LEATHER LEGS: CTB (32EP)

MARBLE TOP + LACQUERED LEGS: CTB (32ML)

MARBLE TOP + LEATHER LEGS: CTB (32MP)

LEATHER TOP + LACQUERED LEGS: CTB (32PL)

LEATHER TOP AND LEGS: CTB (32PP)

COFFEE TABLE

EBONY MACASSAR - EUCALYPTUS - SYCAMORE - LARCH - LIQUIDAMBAR - CHESTNUT - BURR WALNUT TOP + LACQUERED LEGS: CTB (33EL)

EBONY MACASSAR - EUCALYPTUS - SYCAMORE - LARCH - LIQUIDAMBAR - CHESTNUT - BURR WALNUT TOP + LEATHER LEGS: CTB (33EP)

MARBLE TOP + LACQUERED LEGS: CTB (33ML)

MARBLE TOP + LEATHER LEGS: CTB (33MP)

LEATHER TOP + LACQUERED LEGS: CTB (33PL)

LEATHER TOP AND LEGS: CTB (33PP)



SAXON

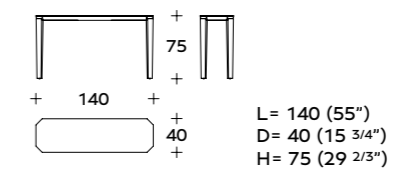

CONSOLE

EBONY MACASSAR - CHESTNUT -
BURR WALNUT: COB (02)



EVAN

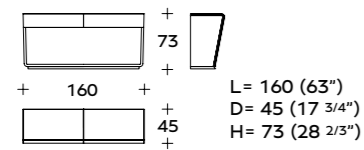

CONSOLE WITH DRAWERS

EBONY MACASSAR - SYCAMORE - CHESTNUT - BURR WALNUT: COB (03E)



KELLEY

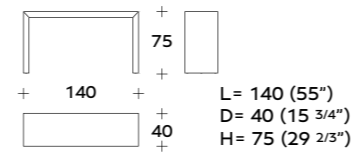

CONSOLE

EBONY MACASSAR: COB (01E)
CHESTNUT - BURR WALNUT: COB (01R)

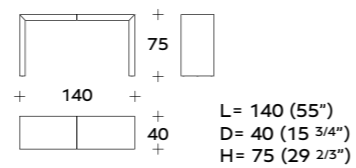

CONSOLE

LEATHER: COB (01P)



HAROLD

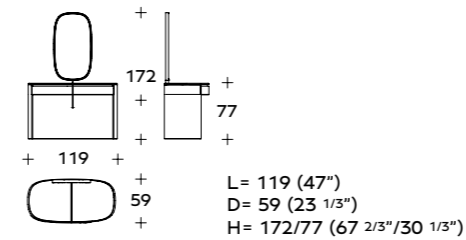

DRESSING TABLE WITH MIRROR

TOP
GLASS: COB (05)
LEATHER: COB (05P)



LEAMINGTON

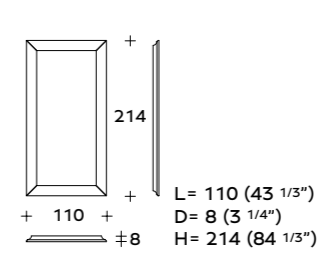

MIRROR

EBONY MACASSAR - CHESTNUT - BURR WALNUT: SPB (01)

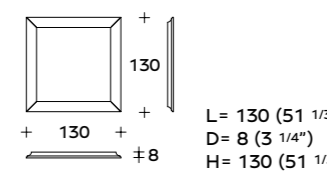

MIRROR

EBONY MACASSAR - CHESTNUT - BURR WALNUT: SPB (03)

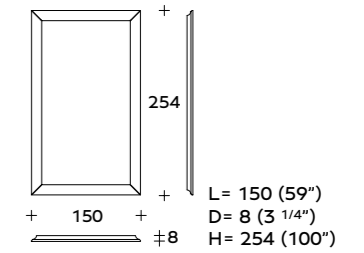

MIRROR

EBONY MACASSAR - CHESTNUT - BURR WALNUT: SPB (02)

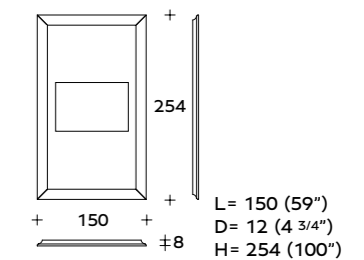

MIRROR FOR LED TV 40"

EBONY MACASSAR - CHESTNUT - BURR WALNUT: SPB (02TV)



PRESIDENT

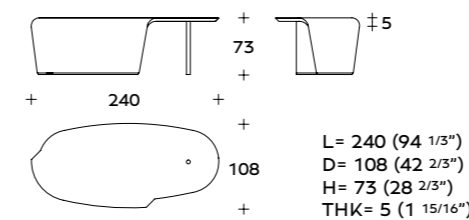

LEATHER WRITING-DESK: BTV (19)

EBONY MACASSAR - LARCH - CHESTNUT -
BURR WALNUT WRITING DESK: BTV (22E)

LEATHER FRAME
TOP
GLASS: BTV (19V)
EUCALYPTUS - SYCAMORE - CHESTNUT -
BURR WALNUT: BTV (19PE)

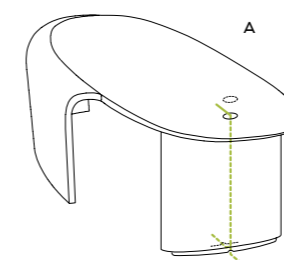

A - EXAMPLE OF CABLE STORAGE FOR WRITING-DESK

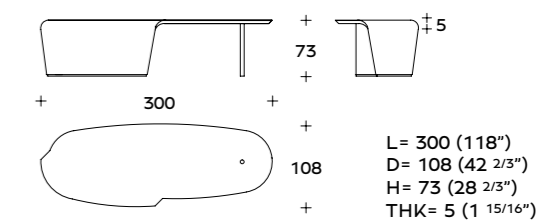

LEATHER WRITING-DESK: BTV (18)

EBONY MACASSAR - LARCH - CHESTNUT -
BURR WALNUT WRITING DESK: BTV (21E)

TOP
GLASS: BTV (18V)
EUCALYPTUS - SYCAMORE - CHESTNUT -
BURR WALNUT: BTV (18PE)

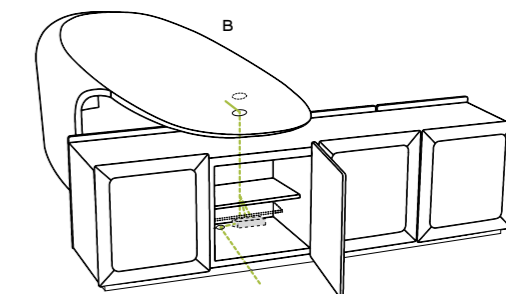

B - EXAMPLE OF CABLE STORAGE FOR WRITING-DESK WITH OPTIONAL BOARD

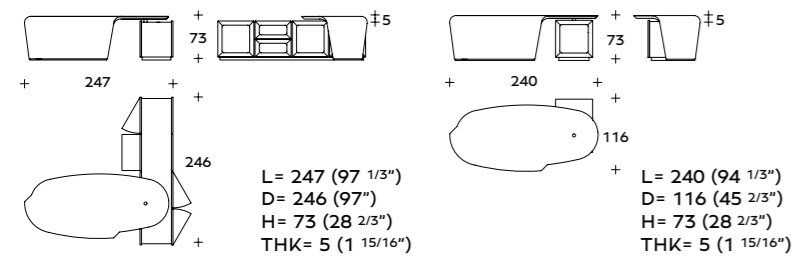

Writing-desk with optional 1

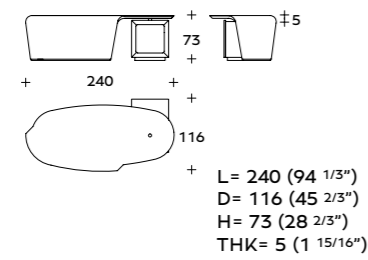

Writing-desk with optional 2

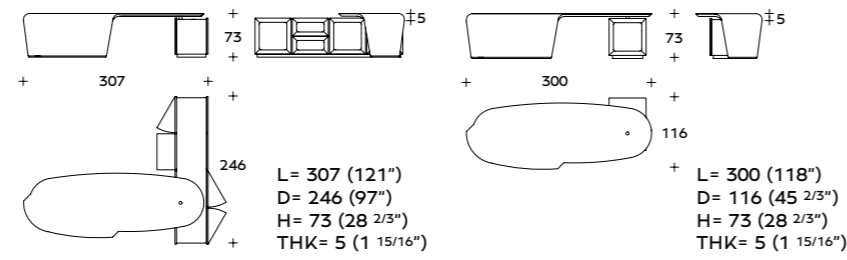

Writing-desk with optional 1

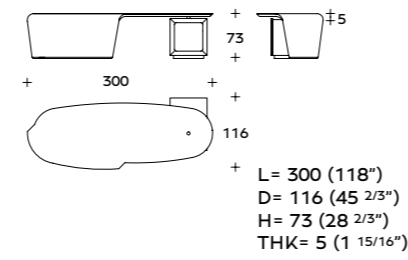

Writing-desk with optional 2

LEATHER WRITING-DESK:

- OPTIONAL 1
(KENSINGTON SIDEBOARD)
- LEATHER 3 DOORS + 2 DRAWERS: BTV (19MP)
- EBONY MACASSAR - EUCALYPTUS - SYCAMORE - CHESTNUT - BURR WALNUT FRAME AND LEATHER 3 DOORS + 2 DRAWERS: BTV (19ME)

- OPTIONAL 2
(KENSINGTON CHEST OF DRAWERS)
- LEATHER 2 DRAWERS: BTV (19CP)
- EBONY MACASSAR - EUCALYPTUS - SYCAMORE - CHESTNUT - BURR WALNUT FRAME AND LEATHER 2 DRAWERS: BTV (19CE)

LEATHER WRITING-DESK:

- OPTIONAL 1
(KENSINGTON SIDEBOARD)
- LEATHER 3 DOORS + 2 DRAWERS: BTV (18MP)
- EBONY MACASSAR - EUCALYPTUS - SYCAMORE - CHESTNUT - BURR WALNUT FRAME AND LEATHER 3 DOORS + 2 DRAWERS: BTV (18ME)

- OPTIONAL 2
(KENSINGTON CHEST OF DRAWERS)
- LEATHER 2 DRAWERS: BTV (18CP)
- EBONY MACASSAR - EUCALYPTUS - SYCAMORE - CHESTNUT - BURR WALNUT FRAME AND LEATHER 2 DRAWERS: BTV (18CE)

EBONY MACASSAR - LARCH - CHESTNUT - BURR WALNUT WRITING-DESK:

- OPTIONAL 1
(KENSINGTON SIDEBOARD)
- LEATHER 3 DOORS + 2 DRAWERS: BTV (22EMP)
- EBONY MACASSAR - LARCH - CHESTNUT - BURR WALNUT FRAME AND LEATHER 3 DOORS + 2 DRAWERS: BTV (22EME)

- OPTIONAL 2
(KENSINGTON SIDEBOARD)
- LEATHER 2 DRAWERS: BTV (22ECP)
- EBONY MACASSAR - LARCH - CHESTNUT - BURR WALNUT FRAME AND LEATHER 2 DRAWERS: BTV (22ECE)

EBONY MACASSAR - LARCH - CHESTNUT - BURR WALNUT WRITING-DESK:

- OPTIONAL 1
(KENSINGTON SIDEBOARD)
- LEATHER 3 DOORS + 2 DRAWERS: BTV (21EMP)
- EBONY MACASSAR - LARCH - CHESTNUT - BURR WALNUT FRAME AND LEATHER 3 DOORS + 2 DRAWERS: BTV (21EME)

- OPTIONAL 2
(KENSINGTON SIDEBOARD)
- LEATHER 2 DRAWERS: BTV (21ECP)
- EBONY MACASSAR - LARCH - CHESTNUT - BURR WALNUT FRAME AND LEATHER 2 DRAWERS: BTV (21ECE)

WRITING-DESK WITH GLASS TOP:

- OPTIONAL 1
(KENSINGTON SIDEBOARD)
- LEATHER 3 DOORS + 2 DRAWERS: BTV (19VMP)
- EBONY MACASSAR - EUCALYPTUS - SYCAMORE - CHESTNUT - BURR WALNUT FRAME AND LEATHER 3 DOORS + 2 DRAWERS: BTV (19VME)

- OPTIONAL 2
(KENSINGTON CHEST OF DRAWERS)
- LEATHER 2 DRAWERS: BTV (19VCP)
- EBONY MACASSAR - EUCALYPTUS - SYCAMORE - CHESTNUT - BURR WALNUT FRAME AND LEATHER 2 DRAWERS: BTV (19VCE)

WRITING-DESK WITH GLASS TOP:

- OPTIONAL 1
(KENSINGTON SIDEBOARD)
- LEATHER 3 DOORS + 2 DRAWERS: BTV (18VMP)
- EBONY MACASSAR - EUCALYPTUS - SYCAMORE - CHESTNUT - BURR WALNUT FRAME AND LEATHER 3 DOORS + 2 DRAWERS: BTV (18VME)

- OPTIONAL 2
(KENSINGTON CHEST OF DRAWERS)
- LEATHER 2 DRAWERS: BTV (18VCP)
- EBONY MACASSAR - EUCALYPTUS - SYCAMORE - CHESTNUT - BURR WALNUT FRAME AND LEATHER 2 DRAWERS: BTV (18VCE)

WRITING-DESK WITH EUCALYPTUS - SYCAMORE - LARCH - CHESTNUT - BURR WALNUT TOP:

- OPTIONAL 1
(KENSINGTON SIDEBOARD)
- LEATHER 3 DOORS + 2 DRAWERS: BTV (19PEMP)
- EUCALYPTUS - SYCAMORE - LARCH - CHESTNUT - BURR WALNUT FRAME AND LEATHER 3 DOORS + 2 DRAWERS: BTV (19PEME)

- OPTIONAL 2
(KENSINGTON CHEST OF DRAWERS)
- LEATHER 2 DRAWERS: BTV (19PECP)
- EUCALYPTUS - SYCAMORE - LARCH - CHESTNUT - BURR WALNUT FRAME AND LEATHER 2 DRAWERS: BTV (19PECE)

WRITING-DESK WITH EUCALYPTUS - SYCAMORE - LARCH - CHESTNUT - BURR WALNUT TOP:

- OPTIONAL 1
(KENSINGTON SIDEBOARD)
- LEATHER 3 DOORS + 2 DRAWERS: BTV (18PEMP)
- EUCALYPTUS - SYCAMORE - LARCH - CHESTNUT - BURR WALNUT FRAME AND LEATHER 3 DOORS + 2 DRAWERS: BTV (18PEME)

- OPTIONAL 2
(KENSINGTON CHEST OF DRAWERS)
- LEATHER 2 DRAWERS: BTV (18PECP)
- EUCALYPTUS - SYCAMORE - LARCH - CHESTNUT - BURR WALNUT FRAME AND LEATHER 2 DRAWERS: BTV (18PECE)



YATE



ELLE

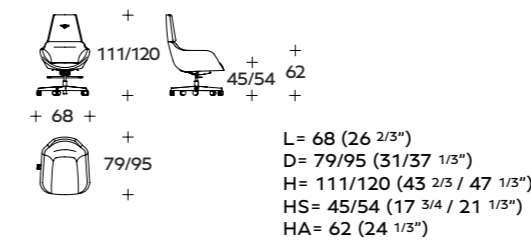

OFFICE ARMCHAIR: POB (20)

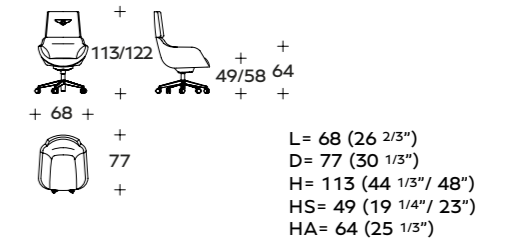

OFFICE ARMCHAIR: POB (9)



centenary limited edition



CREWE

CREWE

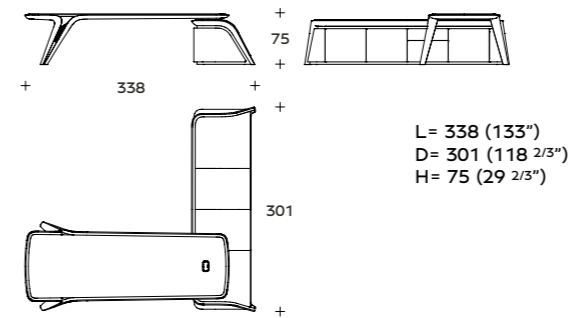

DESKBOARD: BTV (28PMP)

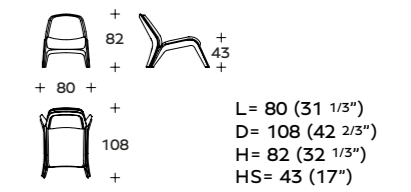

ARMCHAIR: POB (21)

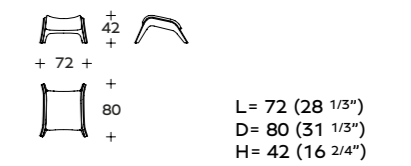

FOOTSTOOL: BPU (05)



RICHMOND

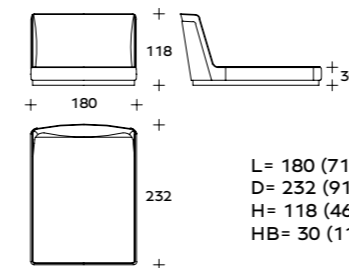

BED
LEATHER: CNC (LE1)
LACQUERED: CNC (LLE1)
CHESTNUT - BURR WALNUT: CNC (RLE1)

FOR MATTRESS 165x200 (65x78 2/3")

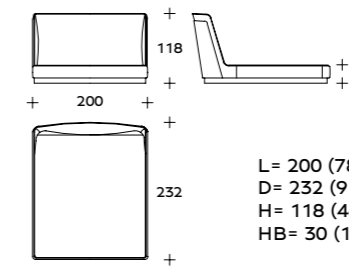

BED
LEATHER: CNC (LE2)
LACQUERED: CNC (LLE2)
CHESTNUT - BURR WALNUT: CNC (RLE2)

FOR MATTRESS 185x200 (73x78 2/3")

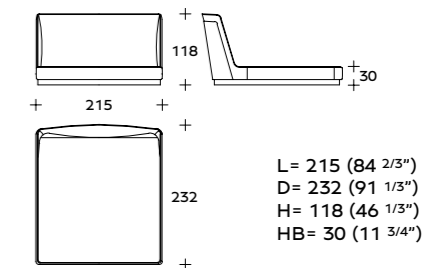

BED
LEATHER: CNC (LE7)
LACQUERED: CNC (LLE7)
CHESTNUT - BURR WALNUT: CNC (RLE7)

FOR MATTRESS 200x200 (78 2/3x78 2/3")

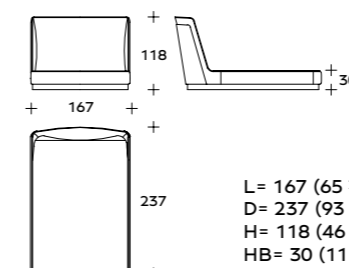

BED
LEATHER: CNC (QUSA)
LACQUERED: CNC (LQUSA)
CHESTNUT - BURR WALNUT: CNC (RQUSA)

FOR MATTRESS QUEEN USA
152x205 (60x80 2/3")

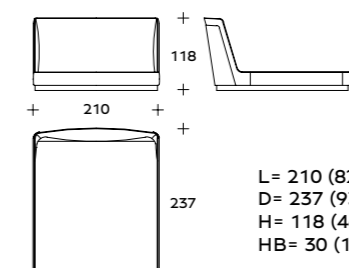

BED
LEATHER: CNC (KUSA)
LACQUERED: CNC (LKUSA)
CHESTNUT - BURR WALNUT: CNC (RKUSA)

FOR MATTRESS KING USA
195x205 (76 2/3x80 2/3")

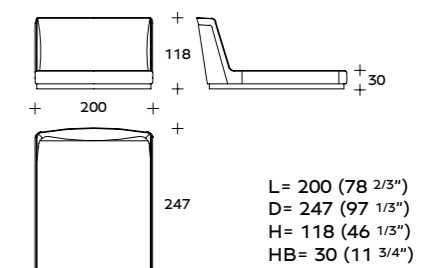

BED
LEATHER: CNC (CUSA)
LACQUERED: CNC (LCUSA)
CHESTNUT - BURR WALNUT: CNC (RCUSA)

FOR MATTRESS CALIFORNIA USA
183x215 (72x84 2/3")

OPT: BED BASE COVER WITH LOGO AVAILABLE FOR ALL SIZES: 1FB (LE1) - 1FB (LE2) - 1FB (LE7) - 1FB (QUSA) - 1FB (KUSA) - 1FB (CUSA)



AMBLE

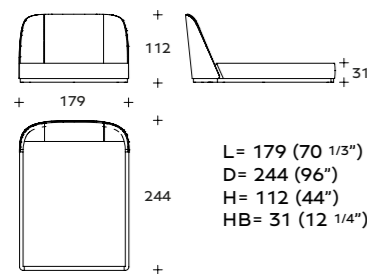

BED: 1BE (LE1)
EBONY MACASSAR - EUCALYPTUS -
SYCAMORE - LARCH - CHESTNUT -
BURR WALNUT HEADBOARD: 1BE (LE1E)

FOR MATTRESS 165x200 (65x78 2/3")

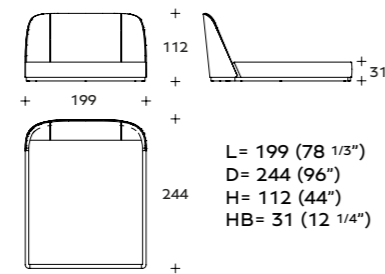

BED: 1BE (LE2)
EBONY MACASSAR - EUCALYPTUS -
SYCAMORE - LARCH - CHESTNUT -
BURR WALNUT HEADBOARD: 1BE (LE2E)

FOR MATTRESS 185x200 (73x78 2/3")

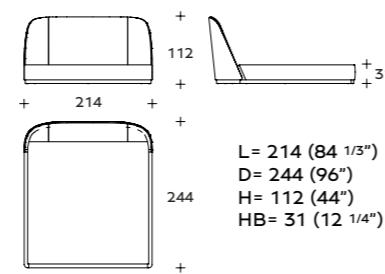

BED: 1BE (LE7)
EBONY MACASSAR - EUCALYPTUS -
SYCAMORE - LARCH - CHESTNUT -
BURR WALNUT HEADBOARD: 1BE (LE7E)

FOR MATTRESS 200x200 (78 2/3x78 2/3")

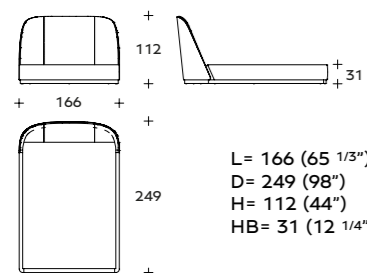

BED: 1BE (QUSA)
EBONY MACASSAR - EUCALYPTUS -
SYCAMORE - LARCH - CHESTNUT -
BURR WALNUT HEADBOARD: 1BE (QUSAE)

FOR MATTRESS QUEEN USA
152x205 (60x80 2/3")

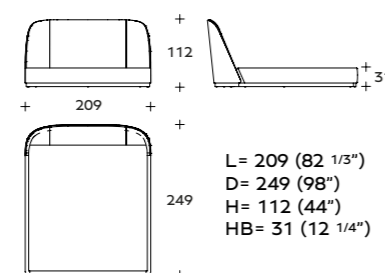

BED: 1BE (KUSA)
EBONY MACASSAR - EUCALYPTUS -
SYCAMORE - LARCH - CHESTNUT -
BURR WALNUT HEADBOARD: 1BE (KUSAE)

FOR MATTRESS KING USA
195x205 (76 2/3x80 2/3")

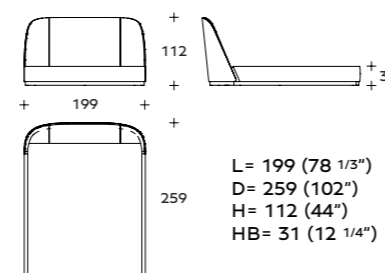

BED: 1BE (CUSA)
EBONY MACASSAR - EUCALYPTUS -
SYCAMORE - LARCH - CHESTNUT -
BURR WALNUT HEADBOARD: 1BE (CUSAE)

FOR MATTRESS CALIFORNIA USA
183x215 (72x84 2/3")

OPT: BED BASE COVER WITH LOGO AVAILABLE FOR ALL SIZES: 1FB (LE1) - 1FB (LE2) - 1FB (LE7) - 1FB (QUSA) - 1FB (KUSA) - 1FB (CUSA)



AVEBURY

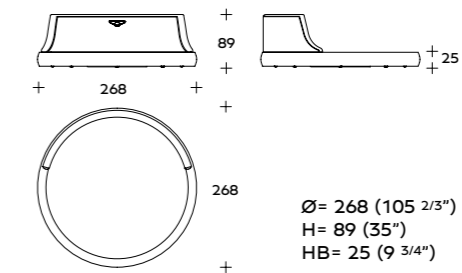

ROUND BED: AVU (LER)

FOR MATTRESS
Ø 240x21H (94 1/3x8 1/4"): MAT (GR)



BERKELEY

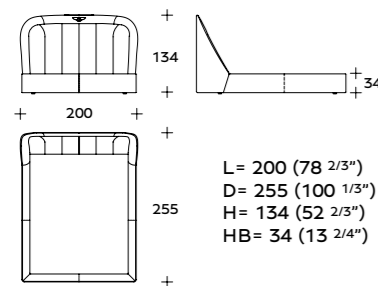

BED: BEL (LE1)
FOR MATTRESS 165x200 (65x78 2/3")

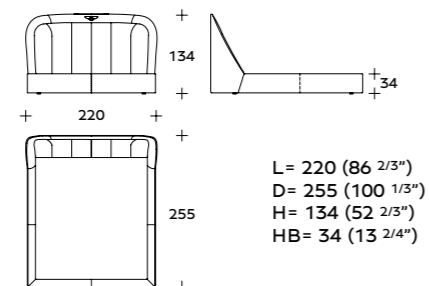

BED: BEL (LE2)
FOR MATTRESS 185x200 (73x78 2/3")

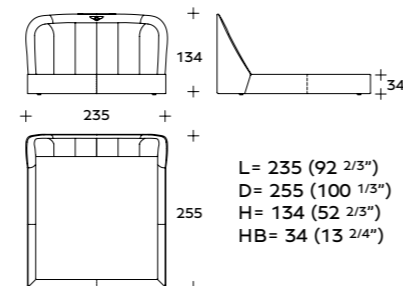

BED: BEL (LE7)
FOR MATTRESS 200x200 (78 2/3x78 2/3")

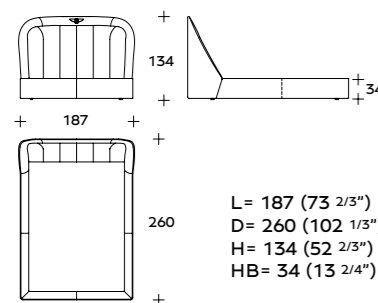

BED: BEL (QUSA)
FOR MATTRESS QUEEN USA
152x205 (60x80 2/3")

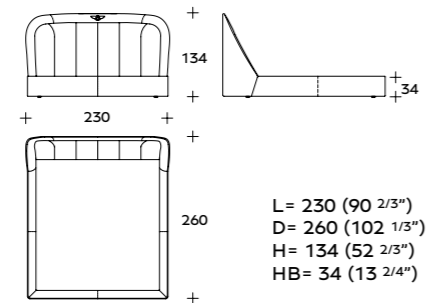

BED: BEL (KUSA)
FOR MATTRESS KING USA
195x205 (76 2/3x80 2/3")

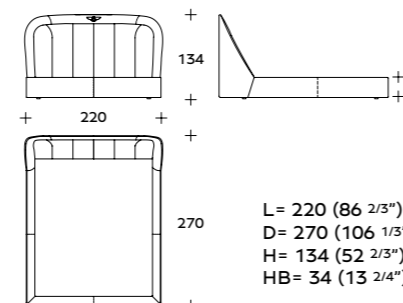

BED: BEL (CUSA)
FOR MATTRESS CALIFORNIA USA
183x215 (72x84 2/3")

OPT: BED BASE COVER WITH LOGO AVAILABLE FOR ALL SIZES: 1FB (LE1) - 1FB (LE2) - 1FB (LE7) - 1FB (QUSA) - 1FB (KUSA) - 1FB (CUSA)



BERWICK

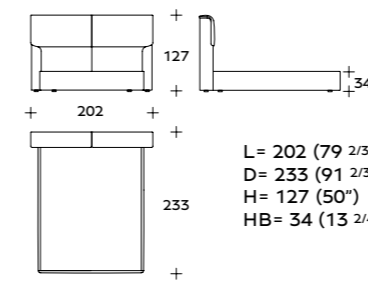

BED: KIA (LE1)
CHESTNUT - BURR WALNUT: KIA (RLE1)
EBONY MACASSAR: KIA (ELE1)
FOR MATTRESS 165x200 (65x78 2/3")

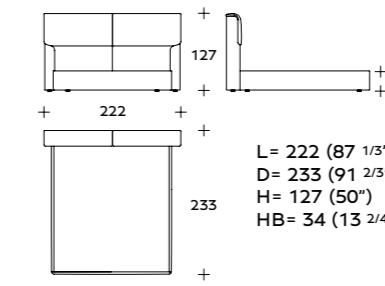

BED: KIA (LE2)
CHESTNUT - BURR WALNUT: KIA (RLE2)
EBONY MACASSAR: KIA (ELE2)
FOR MATTRESS 185x200 (73x78 2/3")

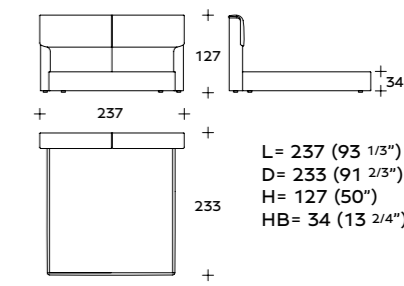

BED: KIA (LE7)
CHESTNUT - BURR WALNUT: KIA (RLE7)
EBONY MACASSAR: KIA (ELE7)
FOR MATTRESS 200x200 (78 2/3x78 2/3")

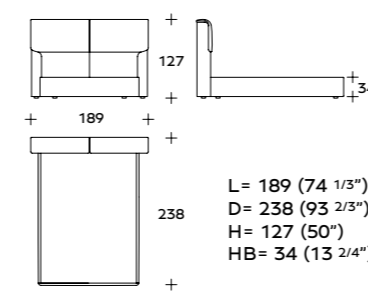

BED: KIA (QUSA)
CHESTNUT - BURR WALNUT: KIA (RQUSA)
EBONY MACASSAR: KIA (EQUSA)
FOR MATTRESS QUEEN USA
152x205 (60x80 2/3")

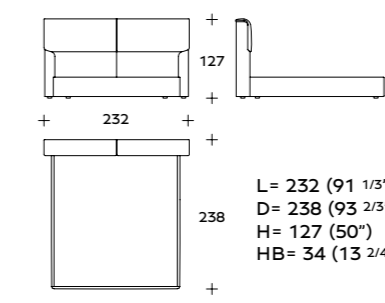

BED: KIA (KUSA)
CHESTNUT - BURR WALNUT: KIA (RKUSA)
EBONY MACASSAR: KIA (EKUSA)
FOR MATTRESS KING USA
195x205 (76 2/3x80 2/3")

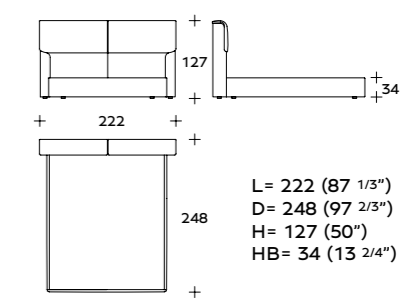

BED: KIA (CUSA)
CHESTNUT - BURR WALNUT: KIA (RCUSA)
EBONY MACASSAR: KIA (ECUSA)
FOR MATTRESS CALIFORNIA USA
183x215 (72x84 2/3")

OPT: BED BASE COVER WITH LOGO AVAILABLE FOR ALL SIZES: 1FB (LE1) - 1FB (LE2) - 1FB (LE7) - 1FB (QUSA) - 1FB (KUSA) - 1FB (CUSA)



CANTERBURY

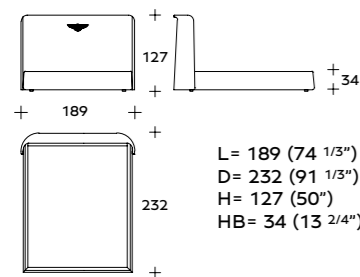

BED: LBM (LE1)
FOR MATTRESS 165x200 (65x78 2/3")

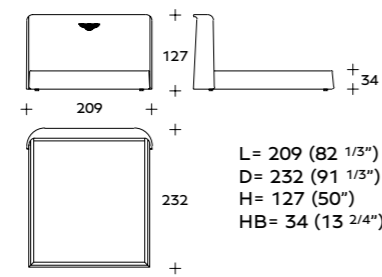

BED: LBM (LE2)
FOR MATTRESS 185x200 (73x78 2/3")

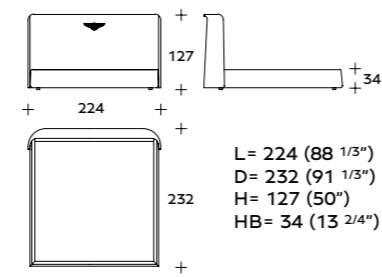

BED: LBM (LE7)
FOR MATTRESS 200x200 (78 2/3x78 2/3")

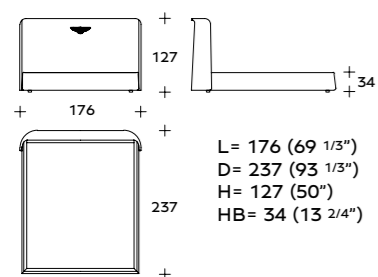

BED: LBM (QUSA)
FOR MATTRESS QUEEN USA
152x205 (60x80 2/3")

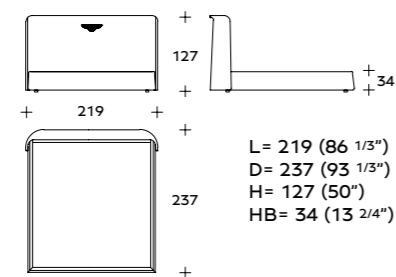

BED: LBM (KUSA)
FOR MATTRESS KING USA
195x205 (76 2/3x80 2/3")

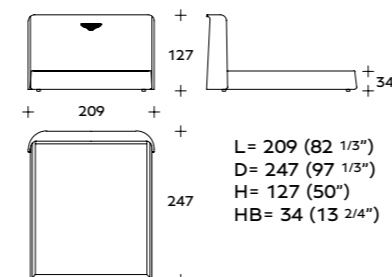

BED: LBM (CUSA)
FOR MATTRESS CALIFORNIA USA
183x215 (72x84 2/3")



LANCASTER

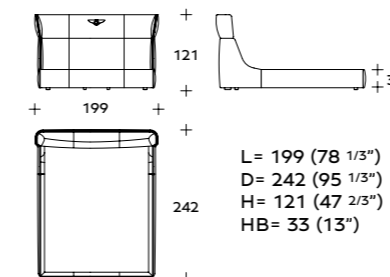

BED: LB1 (LE1)
FOR MATTRESS 165x200 (65x78 2/3")

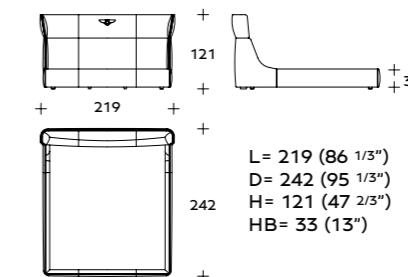

BED: LB1 (LE2)
FOR MATTRESS 185x200 (73x78 2/3")

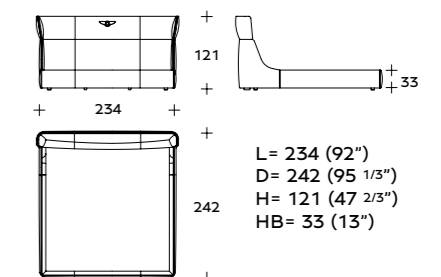

BED: LB1 (LE7)
FOR MATTRESS 200x200 (78 2/3x78 2/3")

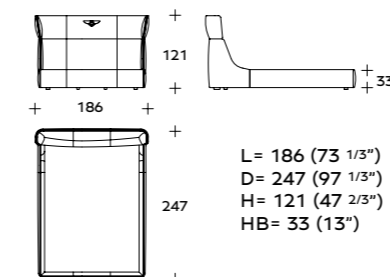

BED: LB1 (QUSA)
FOR MATTRESS QUEEN USA
152x205 (60x80 2/3")

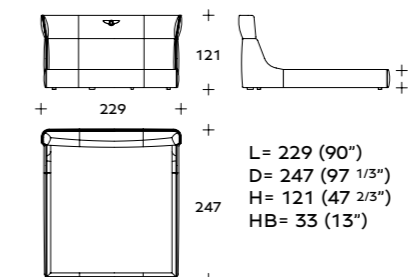

BED: LB1 (KUSA)
FOR MATTRESS KING USA
195x205 (76 2/3x80 2/3")

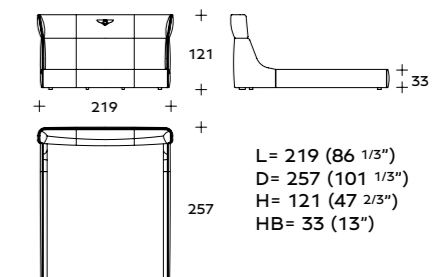

BED: LB1 (CUSA)
FOR MATTRESS CALIFORNIA USA
183x215 (72x84 2/3")

OPT: BED BASE COVER WITH LOGO AVAILABLE FOR ALL SIZES: 1FB (LE1) - 1FB (LE2) - 1FB (LE7) - 1FB (QUSA) - 1FB (KUSA) - 1FB (CUSA)

OPT: BED BASE COVER WITH LOGO AVAILABLE FOR ALL SIZES: 1FB (LE1) - 1FB (LE2) - 1FB (LE7) - 1FB (QUSA) - 1FB (KUSA) - 1FB (CUSA)



STAMFORD

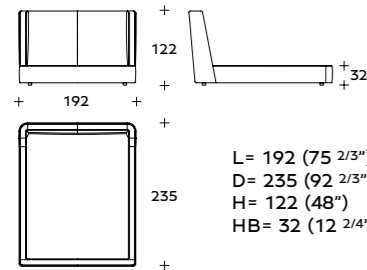

L= 192 (75 2/3")
D= 235 (92 2/3")
H= 122 (48")
HB= 32 (12 2/4")

BED: EAS (LE1)
EBONY MACASSAR - EUCALYPTUS -
SYCAMORE - LARCH: EAS (ELE1)
CHESTNUT - BURR WALNUT: EAS (RLE1)

FOR MATTRESS 165x200 (65x78 2/3")

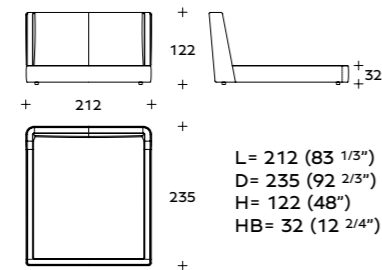

L= 212 (83 1/3")
D= 235 (92 2/3")
H= 122 (48")
HB= 32 (12 2/4")

BED: EAS (LE2)
EBONY MACASSAR - EUCALYPTUS -
SYCAMORE - LARCH: EAS (ELE2)
CHESTNUT - BURR WALNUT: EAS (RLE2)

FOR MATTRESS 185x200 (73x78 2/3")

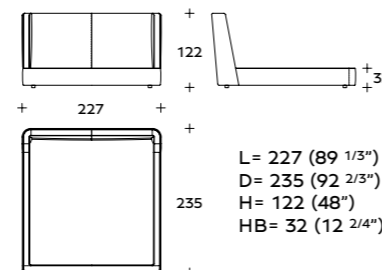

L= 227 (89 1/3")
D= 235 (92 2/3")
H= 122 (48")
HB= 32 (12 2/4")

BED: EAS (LE7)
EBONY MACASSAR - EUCALYPTUS -
SYCAMORE - LARCH: EAS (ELE7)
CHESTNUT - BURR WALNUT: EAS (RLE7)

FOR MATTRESS 200x200 (78 2/3x78 2/3")

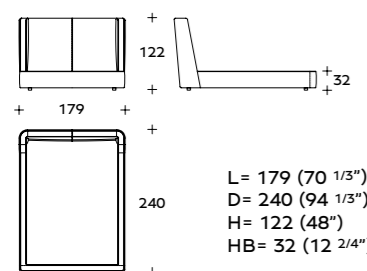

L= 179 (70 1/3")
D= 240 (94 1/3")
H= 122 (48")
HB= 32 (12 2/4")

BED: EAS (QUSA)
EBONY MACASSAR - EUCALYPTUS -
SYCAMORE - LARCH: EAS (EQUSA)
CHESTNUT - BURR WALNUT: EAS (RQUSA)

FOR MATTRESS QUEEN USA
152x205 (60x80 2/3")

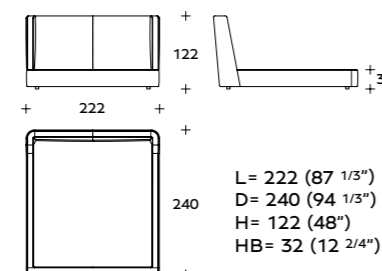

L= 222 (87 1/3")
D= 240 (94 1/3")
H= 122 (48")
HB= 32 (12 2/4")

BED: EAS (KUSA)
EBONY MACASSAR - EUCALYPTUS -
SYCAMORE - LARCH: EAS (EKUSA)
CHESTNUT - BURR WALNUT: EAS (RKUSA)

FOR MATTRESS KING USA
195x205 (76 2/3x80 2/3")

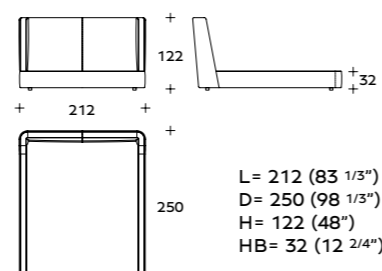

L= 212 (83 1/3")
D= 250 (98 1/3")
H= 122 (48")
HB= 32 (12 2/4")

BED: EAS (CUSA)
EBONY MACASSAR - EUCALYPTUS -
SYCAMORE - LARCH: EAS (ECUSA)
CHESTNUT - BURR WALNUT: EAS (RCUSA)

FOR MATTRESS CALIFORNIA USA
183x215 (72x84 2/3")

OPT: BED BASE COVER WITH LOGO AVAILABLE FOR ALL SIZES: 1FB (LE1) - 1FB (LE2) - 1FB (LE7) - 1FB (QUSA) - 1FB (KUSA) - 1FB (CUSA)
RUNNER (EAT) 115x35 (45 1/3x13 3/4")



TIVERTON

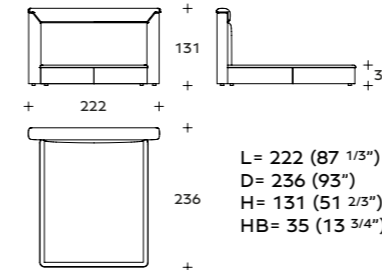

L= 222 (87 1/3")
D= 236 (93")
H= 131 (51 2/3")
HB= 35 (13 3/4")

BED: TTN (LE1)
VENEERED: TTN (ELE1)

FOR MATTRESS 165x200 (65x78 2/3")

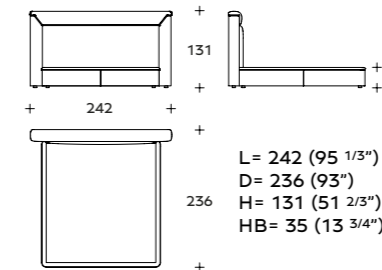

L= 242 (95 1/3")
D= 236 (93")
H= 131 (51 2/3")
HB= 35 (13 3/4")

BED: TTN (LE2)
VENEERED: TTN (ELE2)

FOR MATTRESS 185x200 (73x78 2/3")

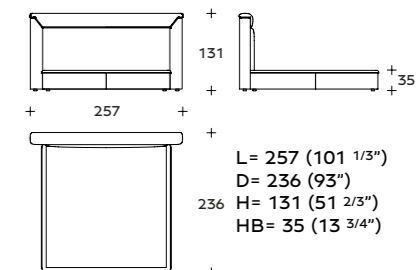

L= 257 (101 1/3")
D= 236 (93")
H= 131 (51 2/3")
HB= 35 (13 3/4")

BED: TTN (LE7)
VENEERED: TTN (ELE7)

FOR MATTRESS 200x200 (78 2/3x78 2/3")

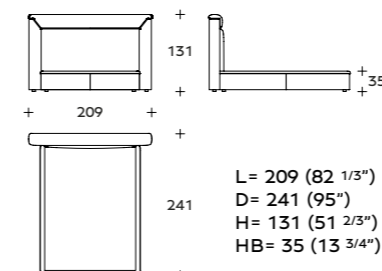

L= 209 (82 1/3")
D= 241 (95")
H= 131 (51 2/3")
HB= 35 (13 3/4")

BED: TTN (QUSA)
VENEERED: TTN (EQUSA)

FOR MATTRESS QUEEN USA
152x205 (60x80 2/3")

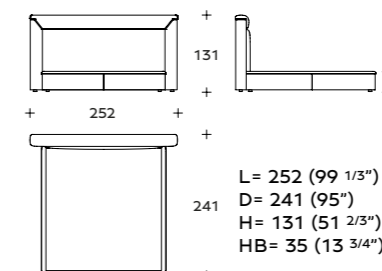

L= 252 (99 1/3")
D= 241 (95")
H= 131 (51 2/3")
HB= 35 (13 3/4")

BED: TTN (KUSA)
VENEERED: TTN (EKUSA)

FOR MATTRESS KING USA
195x205 (76 2/3x80 2/3")

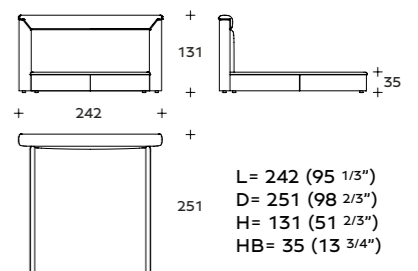

L= 242 (95 1/3")
D= 251 (98 2/3")
H= 131 (51 2/3")
HB= 35 (13 3/4")

BED: TTN (CUSA)
VENEERED: TTN (ECUSA)

FOR MATTRESS CALIFORNIA USA
183x215 (72x84 2/3")

OPT: BED BASE COVER WITH LOGO AVAILABLE FOR ALL SIZES: 1FB (LE1) - 1FB (LE2) - 1FB (LE7) - 1FB (QUSA) - 1FB (KUSA) - 1FB (CUSA)



WICKHAM

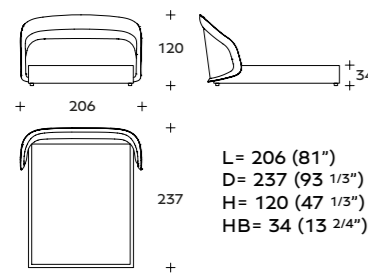

BED: RMG (LE1)
FOR MATTRESS 165x200 (65x78 2/3")

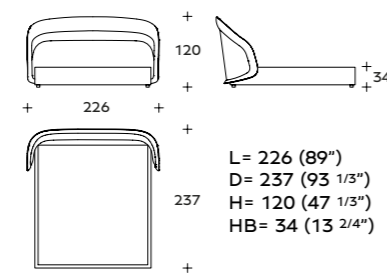

BED: RMG (LE2)
FOR MATTRESS 185x200 (73x78 2/3")

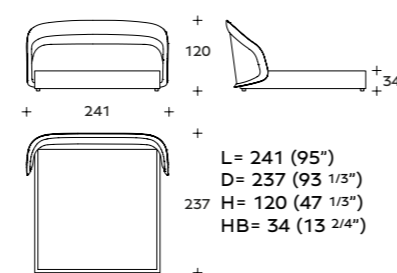

BED: RMG (LE7)
FOR MATTRESS 200x200 (78 2/3x78 2/3")

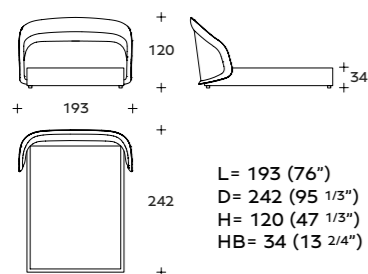

BED: RMG (QUSA)
FOR MATTRESS QUEEN USA
152x205 (60x80 2/3")

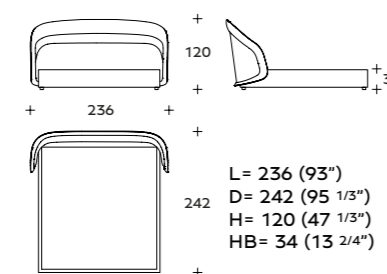

BED: RMG (KUSA)
FOR MATTRESS KING USA
195x205 (76 2/3x80 2/3")

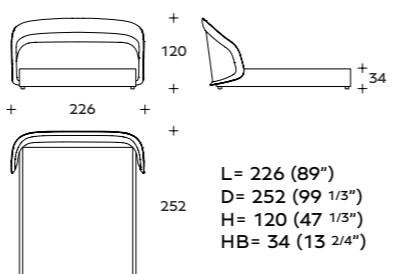

BED: RMG (CUSA)
FOR MATTRESS CALIFORNIA USA
183x215 (72x84 2/3")

OPT: BED BASE COVER WITH LOGO AVAILABLE FOR ALL SIZES: 1FB (LE1) - 1FB (LE2) - 1FB (LE7) - 1FB (QUSA) - 1FB (KUSA) - 1FB (CUSA)



AMBLESIDE

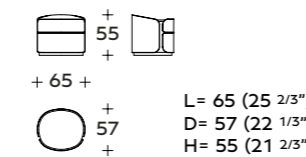

BEDSIDE TABLE

EBONY MACASSAR - LARCH - LIQUIDAMBAR - SYCAMORE - EUCALYPTUS - CHESTNUT - BURR WALNUT FRAME: BCM (8E)

LEATHER TOP + EBONY MACASSAR - EUCALYPTUS - SYCAMORE - LARCH - LIQUIDAMBAR - CHESTNUT - BURR WALNUT FRAME: BCM (8P)



EASTGATE

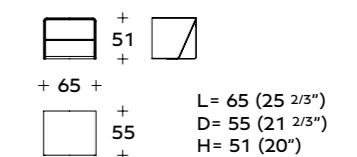

RIGHT OR LEFT BEDSIDE TABLE

GLAZE EARTH - GLAZE SLATE - GLAZE GREIGE LACQUERED TOP + LEATHER DRAWER: BCM (7LD) - BCM (7LS)

EUCALYPTUS - SYCAMORE - LARCH - LIQUIDAMBAR - CHESTNUT - BURR WALNUT TOP + LEATHER DRAWER: BCM (7ED) - BCM (7ES)

Drawing: left element



HAROLD

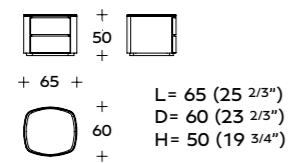

BEDSIDE TABLE

TOP
 GLASS - EBONY MACASSAR -
 CHESTNUT - BURR WALNUT: BCM (3)
 LEATHER: BCM (3P)



LANES

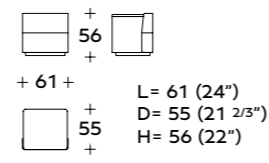

BEDSIDE TABLE

EBONY MACASSAR - SYCAMORE -
 CHESTNUT - BURR WALNUT: BCM (6)



SAXON

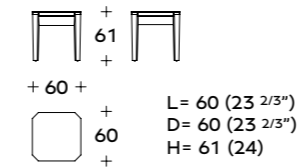

BEDSIDE TABLE

EBONY MACASSAR -
 CHESTNUT - BURR WALNUT: BCM (4)



STAFFORD

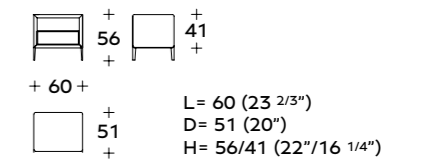

BEDSIDE TABLE

DRAWER
 LEATHER: BCM (1P)
 CHESTNUT - BURR WALNUT: BCM (1R)



ACTON



ARRAN

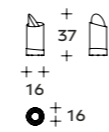

L - D= Ø 16 (6 1/4")
H= 37 (14 2/4")

BEDSIDE TABLE LAMP: LMB (29)

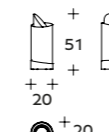

L - D= Ø 20 (7 3/4")
H= 51 (20")

TABLE LAMP: LMB (30)

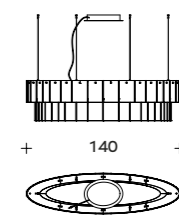

SUSPENSION: LMB (24)

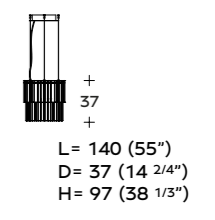

L= 140 (55")
D= 37 (14 2/4")
H= 97 (38 1/3")

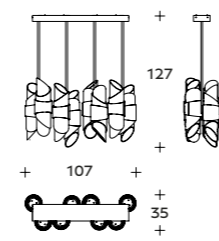

L= 107 (42")
D= 35 (13 3/4")
H= 127 (50")

SUSPENSION: LMB (34)

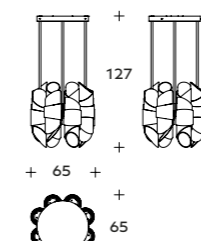

L= 65 (25 2/3")
D= 65 (25 2/3")
H= 127 (50")

SUSPENSION: LMB (35)



CHESIL



HONISTER



LE NÔTRE

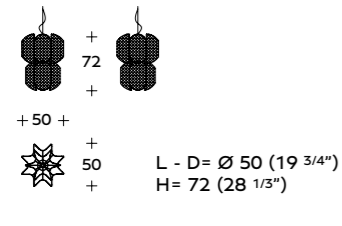

PENDANT: LMB (19)

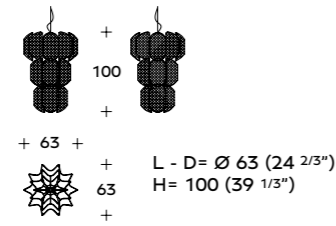

BIG PENDANT: LMB (18)

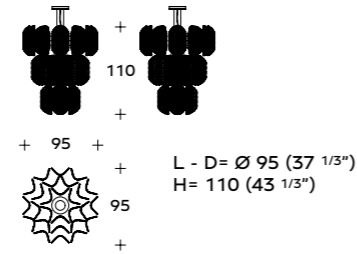

XL SUSPENSION: LMB (20)

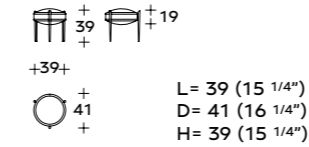
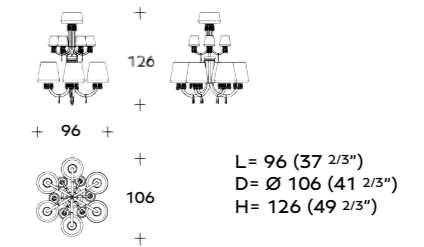
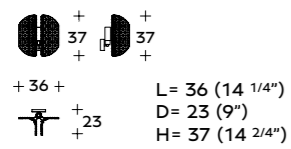

TABLE LAMP: LMB (14)



CHANDELIER: LMB (MUR4)



WALL LAMP: LMB (21)

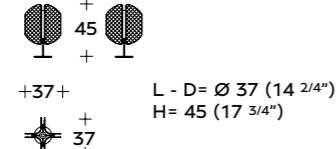
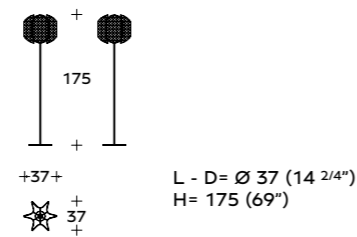
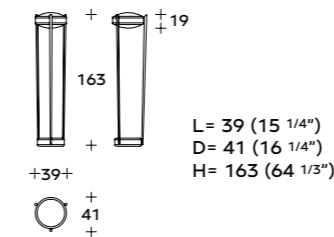

TABLE LAMP: LMB (15)



STANDING LAMP: LMB (17)



FLOOR LAMP: LMB (13)

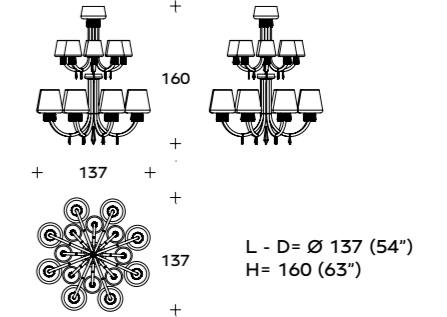

CHANDELIER: LMB (MUR7)



MORPETH

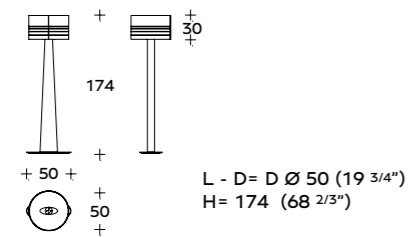

FLOOR LAMP: LMB (22)

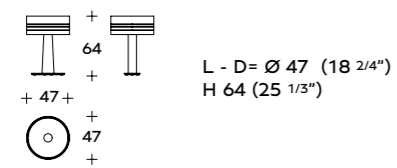
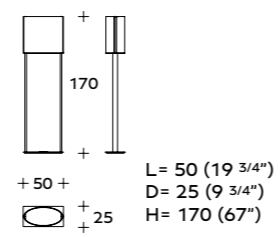

TABLE LAMP: LMB (23)



STONELIGHT



FLOOR LAMP: LMB (3)

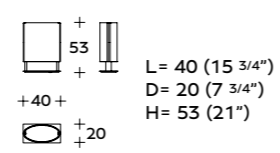
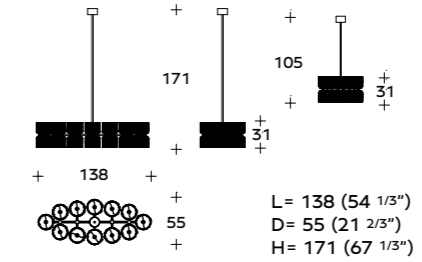

TABLE LAMP: LMB (2)



TALBOT



CHANDELIER: LMB (MUR8)

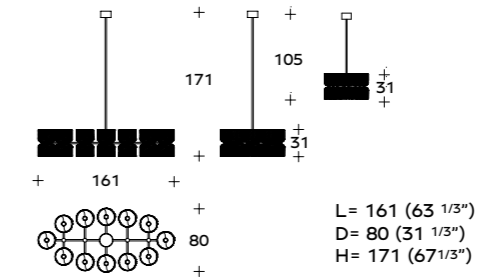

CHANDELIER: LMB (MUR9)



WARWICK

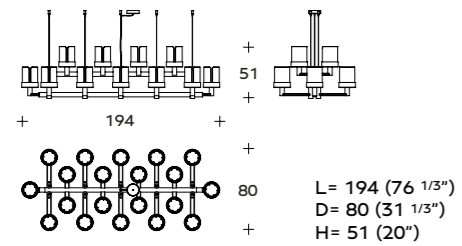

SUSPENSION: LMB (25)

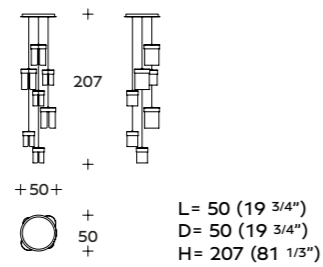

SUSPENSION: LMB (26)

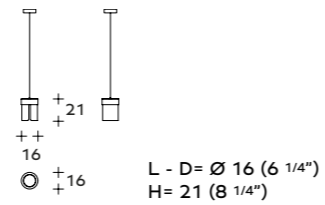

SUSPENSION: LMB (27)

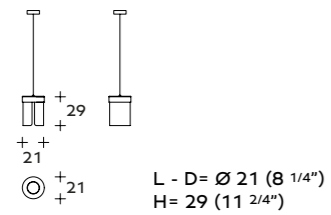

BIG SUSPENSION: LMB (28)

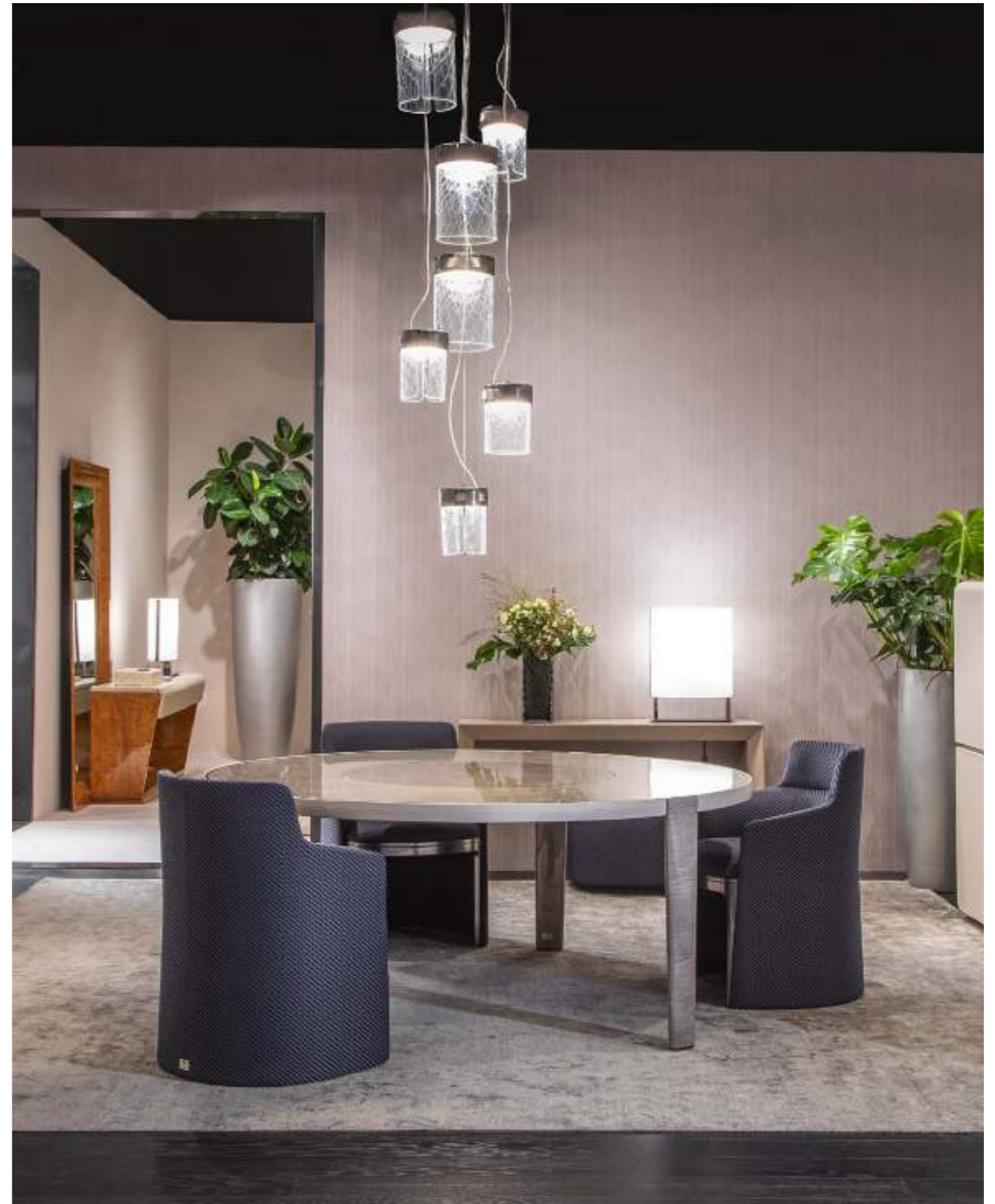

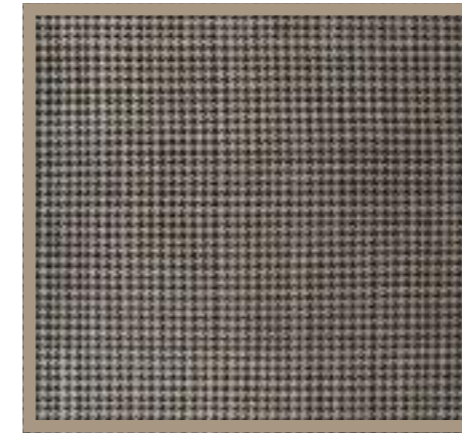

BRAXTON



DAVIS

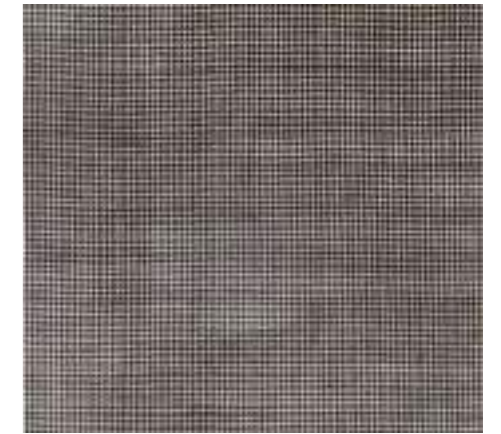

HEXHAM

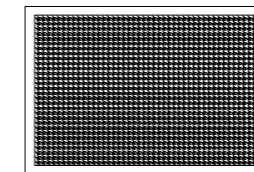

WOOL & SILK RUG:
 BTP (8) - 300x200 (118x78 2/5")
 BTP (9) - 300x300 (118x118")
 BTP (10) - 400x400 (157 1/2x157 1/2")

BIG PIED DE POULE
 - BROWN-GREY WITH BLACK MOTIF
 HAND KNOTTED

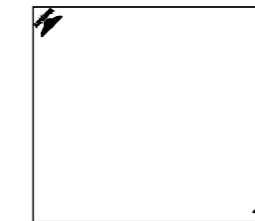

"FINE" BAMBOO VISCOSE FIBRE RUG:
 BTP (26) - 400x400 (157 1/2x157 1/2")
 BTP (33) - 400x300 (157 1/2x118")

BENTLEY LOGO
 - OPTIC WHITE
 - WHITE
 - MUD
 - BROWN

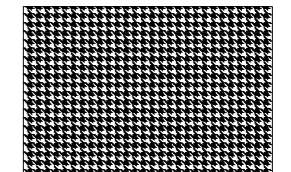

BAMBOO "SILK" FIBRE RUG:
 BTP (28) - 300x300 (118x118")
 BTP (29) - 400x400 (157 1/2x157 1/2")

SMALL PIED DE POULE
 - WHITE WITH QUARTZ GREY MOTIF
 - WHITE WITH CARAMEL MOTIF
 - QUARTZ GREY WITH NAVY BLUE MOTIF
 HAND KNOTTED



MATRIX



NEW ZEALAND WOOL:
 BTP (34) - 300x200 (118x78 2/3")
 BTP (35) - 400x300 (157 1/2x118")
 BTP (36) - 400x400 (157 1/2x157 1/2")
 - QUARTZ GREY WITH NOISETTE
 MATRIX MOTIF
 - EARTH WITH BLACK
 MATRIX MOTIF
 TUFTED



NORMAND



LINEN RUG:
 BTP (14) - 300x200 (118x78 2/3")
 BTP (15) - 300x300 (118x118")
 BTP (40) - 400x300 (157 1/2x118")
 BTP (16) - 400x400 (157 1/2x157 1/2")
 - SMOKE GREY
 - LAVA
 - LIGHT GREY
 HAND KNOTTED



PENRITH



BAMBOO "SILK" FIBRE RUG:
 BTP (31) - 300x300 (118x118")
 BTP (32) - 400x300 (157 1/2x118")
 BTP (30) - 400x400 (157 1/2x157 1/2")
 DEGRADÉ MOTIF
 - LAVA
 - GOLD
 - CAMEL
 HAND KNOTTED



PERCIVAL



PASHMINA & SILK RUG:
 BTP (11) - 300x200 (118x78 2/3")
 BTP (12) - 300x300 (118x118")
 BTP (13) - 400x400 (157 1/2x157 1/2")
 - IVORY WITH COGNAC MOTIF
 PIED DE POULE MOTIF ON THE
 EDGE



ROYAL

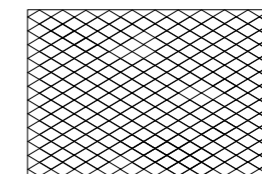

BAMBOO "SILK" FIBRE RUG:
 BTP (39) - 300x300 (118x118")
 BTP (37) - 400x300 (157 1/2x118")
 BTP (38) - 400x400 (157 1/2x157 1/2")
 LAVA
 SMOKE GREY
 HAND KNOTTED



SEYMOUR

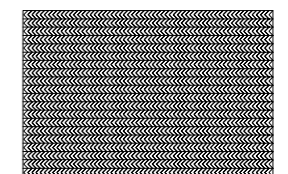

WOOL & SILK RUG:
 BTP (20) - 300x200 (118x78 2/3")
 BTP (21) - 300x300 (118x118")
 BTP (22) - 400x400 (157 1/2x157 1/2")
 CHEVRON
 - BEIGE WITH CHOCOLATE MOTIF
 HAND KNOTTED



CUSHION
 FABRIC OR LEATHER
 BCS (01/30) - 40x30 (15 3/4 x11 3/4")
 BCS (01/50) - 50x50 (19 3/4 x19 3/4")
 CASHMERE
 BCS (01A/30) - 40x30 (15 3/4 x11 3/4")
 BCS (01A/50) - 50x50 (19 3/4 x19 3/4")
 CASHMERE MIDLANDS
 CASHMERE MOORE
 BCS (01B/30) - 40x30 (15 3/4 x11 3/4")
 BCS (01B/50) - 50x50 (19 3/4 x19 3/4")
 EMBROIDERY: LOGO



CUSHION
 FABRIC OR LEATHER
 BCS (02/30) - 50x30 (19 3/4 x11 3/4")
 BCS (02/40) - 60x40 (23 2/3 x15 3/4")
 BCS (02/50) - 50x50 (19 3/4 x19 3/4")
 CASHMERE
 BCS (02A/30) - 50x30 (19 3/4 x11 3/4")
 BCS (02A/40) - 60x40 (23 2/3 x15 3/4")
 BCS (02A/50) - 50x50 (19 3/4 x19 3/4")
 CASHMERE MIDLANDS
 CASHMERE MOORE
 BCS (02B/30) - 50x30 (19 3/4 x11 3/4")
 BCS (02B/40) - 60x40 (23 2/3 x15 3/4")
 BCS (02B/50) - 50x50 (19 3/4 x19 3/4")
 EMBROIDERY: RHOMBUS



CUSHION
 FABRIC OR LEATHER
 BCS (03/30) - 50x30 (19 3/4 x11 3/4")
 BCS (03/50) - 50x50 (19 3/4 x19 3/4")
 CASHMERE
 BCS (03A/30) - 50x30 (19 3/4 x11 3/4")
 BCS (03A/50) - 50x50 (19 3/4 x19 3/4")
 CASHMERE MIDLANDS
 CASHMERE MOORE
 BCS (03B/30) - 50x30 (19 3/4 x11 3/4")
 BCS (03B/50) - 50x50 (19 3/4 x19 3/4")
 EMBROIDERY: CERCLE



CUSHION
 FABRIC OR LEATHER
 BCS (04/50) - 50x50 (19 3/4 x19 3/4")
 CASHMERE
 BCS (04A/50) - 50x50 (19 3/4 x19 3/4")
 CASHMERE MIDLANDS
 CASHMERE MOORE
 BCS (04B/50) - 50x50 (19 3/4 x19 3/4")
 EMBROIDERY: LOGO



CUSHION
 FABRIC OR LEATHER
 BCS (05/50) - 50x50 (19 3/4 x19 3/4")
 BCS (05/60) - 60x60 (23 2/3 x23 2/3")
 CASHMERE
 BCS (05A/50) - 50x50 (19 3/4 x19 3/4")
 BCS (05A/60) - 60x60 (23 2/3 x23 2/3")
 CASHMERE MIDLANDS
 CASHMERE MOORE
 BCS (05B/50) - 50x50 (19 3/4 x19 3/4")
 BCS (05B/60) - 60x60 (23 2/3 x23 2/3")
 EMBROIDERY: CAR



CUSHION
 FABRIC OR LEATHER
 BCS (06/30) - 50x30 (19 3/4 x11 3/4")
 BCS (06/50) - 50x50 (19 3/4 x19 3/4")
 CASHMERE
 BCS (06A/30) - 50x30 (19 3/4 x11 3/4")
 BCS (06A/50) - 50x50 (19 3/4 x19 3/4")
 CASHMERE MIDLANDS
 CASHMERE MOORE
 BCS (06B/30) - 50x30 (19 3/4 x11 3/4")
 BCS (06B/50) - 50x50 (19 3/4 x19 3/4")
 EMBROIDERY: LOGO + MAXI RHOMBUS



CUSHION

FABRIC OR LEATHER
 BCS (07/30) - 40x30 (15 3/4 x11 3/4")
 BCS (07/40) - 60x40 (23 2/3 x15 3/4")
 BCS (07/50) - 50x50 (19 3/4 x19 3/4")
 BCS (07/60) - 60x60 (23 2/3 x23 2/3")

CASHMERE
 BCS (07A/30) - 40x30 (15 3/4 x11 3/4")
 BCS (07A/40) - 60x40 (23 2/3 x15 3/4")
 BCS (07A/50) - 50x50 (19 3/4 x19 3/4")
 BCS (07A/60) - 60x60 (23 2/3 x23 2/3")

CASHMERE MIDLANDS
 CASHMERE MOORE
 BCS (07B/30) - 40x30 (15 3/4 x11 3/4")
 BCS (07B/40) - 60x40 (23 2/3 x15 3/4")
 BCS (07B/50) - 50x50 (19 3/4 x19 3/4")
 BCS (07B/60) - 60x60 (23 2/3 x23 2/3")



CUSHION

WOOL & CASHMERE
 BCS (08/40) - 40x40 (15 3/4 x15 3/4")
 BCS (08/50) - 50x50 (19 3/4 x19 3/4")

CHOCOLATE

DOUBLE FACE
 - PLAIN
 - PRINCE OF WALES CHECK

EMBROIDERY: LOGO

LEATHER PIPING



CUSHION

FABRIC OR LEATHER
 BCS (10/50) - 50x50 (19 3/4 x19 3/4")

CASHMERE
 BCS (10A/50) - 50x50 (19 3/4 x19 3/4")

CASHMERE MIDLANDS
 CASHMERE MOORE
 BCS (10B/50) - 50x50 (19 3/4 x19 3/4")

EMBROIDERY: VERTICAL STRIPES



CUSHION

FABRIC OR LEATHER
 BCS (11/50) - 50x50 (19 3/4 x19 3/4")

CASHMERE
 BCS (11A/50) - 50x50 (19 3/4 x19 3/4")

CASHMERE MIDLANDS
 CASHMERE MOORE
 BCS (11B/50) - 50x50 (19 3/4 x19 3/4")

EMBROIDERY: LOGO



CUSHION

VELVET
 BCS (14/30) - 40x30 (15 3/4 x11 3/4")

LOGO + PIED DE POULE:
 SMALL STUDS

STUDS COLOURS
 - SILVER
 - TAUPE
 - GUN-METAL GREY
 - BRONZE



CUSHION

FABRIC OR LEATHER
 BCS (19/50) - 50x50 (19 3/4x19 3/4")

ROYALE QUILTED DIAMOND



CUSHION
FABRIC OR LEATHER
BCS (20/30) - 40x30 (15 3/4x11 3/4")
BCS (20/50) - 50x50 (19 3/4x19 3/4")
WITH INSERT ON CONTRAST



CUSHION
LEATHER
BCS (21/30) - 40x30 (15 3/4x11 3/4")
BCS (21/50) - 50x50 (19 3/4x19 3/4")
WITH STITCHING ON CONTRAST



CUSHION
LEATHER
BCS (22/30) - 40x30 (15 3/4x11 3/4")
BCS (22/50) - 50x50 (19 3/4x19 3/4")
SQUARE QUILTED DIAMOND



CUSHION
VELVET OR LEATHER
BCS (23/30) - 40x30 (15 3/4x11 3/4")
BCS (23/50) - 50x50 (19 3/4x19 3/4")
APPLICATION:
"CAR GRILL" ALCANTARA



CUSHION
VELVET OR LEATHER
BCS (24/50) - 50x50 (19 3/4x19 3/4")
APPLICATION:
LOGO ALCANTARA



THROW
CASHMERE
PLB (1) - 170x140 (67x55")

FABRIC
PLB (2) - 170x140 (67x55")

CASHMERE MIDLANDS
CASHMERE MOORE
PLB (3) - 170x140 (67x55")

BABY CASHMERE
PLB (5) - 170x140 (67x55")

EMBROIDERY: LOGO

SPECIAL WOOL SEWINGS
WITHOUT LINING



THROW
WOOL & CASHMERE
PLB (4) - 170x140 (67x55")
- CHOCOLATE

LOGO EMBROIDERY ON 2 CORNERS

DOUBLE FACE
- PLAIN
- PRINCE OF WALES CHECK



THROW
CASHMERE MIDLANDS
CASHMERE MOORE
PLB (7B) - 180x150 (71x59")

LOGO EMBROIDERY ON 2 CORNERS

LEATHER EDGE

WITHOUT LINING



THROW
CASHMERE
PLB (13) - 186x156 (73 1/3x61 1/3")

- LIGHT TAUPE
- IVORY
- CHOCOLATE

COORDINATED OR ON CONTRAST
FABRIC EDGES:

PIED DE POULE
- TAUPE
- SMOKE GREY
- DARK CHOCOLATE



THROW
CASHMERE
PLB (15) - 190x135 (74 2/3x53")

- IVORY WITH SUEDE LEATHER
INSERT
DEGRADÉ EFFECT
COGNAC

- GREY WITH SUEDE LEATHER
INSERT
DEGRADÉ EFFECT
ANTHRACITE

WITH LOGO EMBROIDERY AND
FRINGES



THROW
CASHMERE
PLB (16) - 180x140 (71x55")

- BEIGE WITH QUARTZ GREY EDGE AND
BURGUNDY INSERT ON CONTRAST

- BEIGE WITH QUARTZ GREY EDGE AND
BLUE INSERT ON CONTRAST

- TAUPE WITH QUARTZ GREY EDGE AND
BURGUNDY INSERT ON CONTRAST

WITH LOGO EMBROIDERY



THROW HOLDER
LEATHER
PPB (02) - 43,5x27 (17,1 15/16 x110 3/4")

- QUARTZ GREY
- BURGUNDY
- COGNAC



THROW WITH THROW HOLDER
WOOL & CASHMERE: PPB (01) 170x140 (67x55")
LEATHER THROW HOLDER: 30x21 (11 3/4 x8 1/4")

THROW HOLDER: BEIGE
THROW: NATURAL IVORY

THROW HOLDER: BURGUNDY
THROW: CHOCOLATE BURGUNDY



THROW
CASHMERE
PLB (17) - 180x140 (71x55")

- QUARTZ GREY-WHITE
- BLACK-WHITE

WITH MATRIX MOTIF AND FRINGES



GRAND TOUR

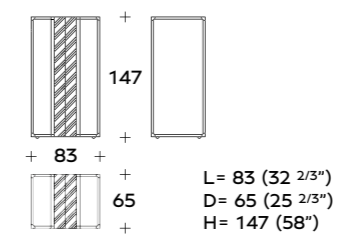

TRUNK - CABINET

CHESTNUT - BURR WALNUT: BLB (01)

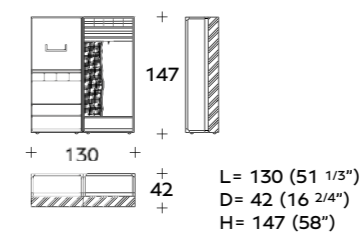

OPEN TRUNK



SANDY

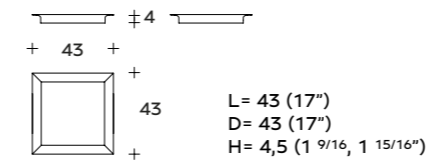

SQUARE TRAY:
VSB (03PL) - VSB (03PP)

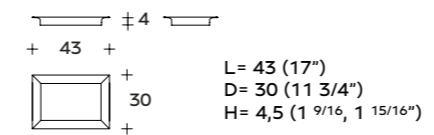

RECTANGULAR TRAY:
VSB (04PL) - VSB (04PP)



TOPSY

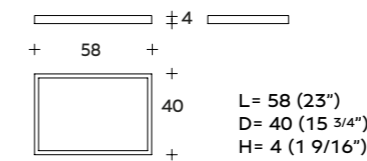

3 TRAYS SET:
VSB (05/K)

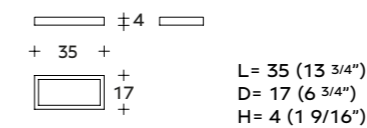
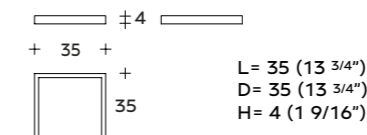

GEMSTONE

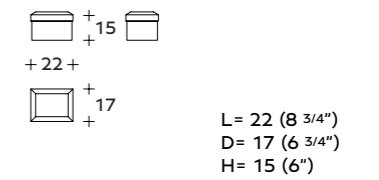

BOX: SCB (10)

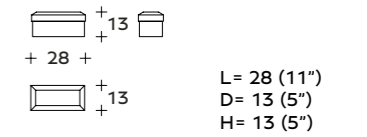

BOX: SCB (11)

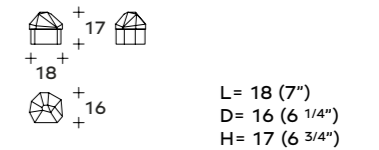

BOX: SCB (12)



VERWOOD



LUNAR



WITNEY



RESERVE CIGAR BOX

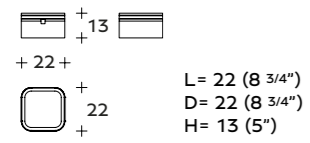

BOX: SCB (09A)

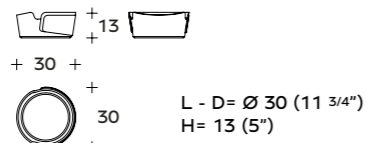

VASE: VAB (15)

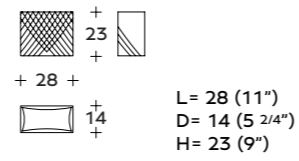

VASE: VAB (12)

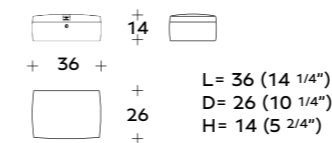

CIGAR BOX: SCB (01)

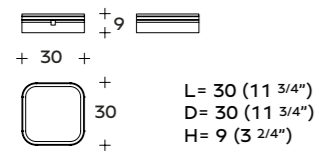

LOW BOX: SCB (09B)

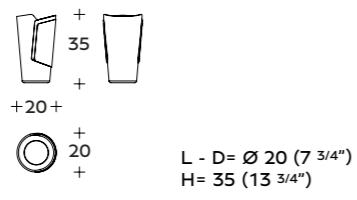

VASE: VAB (13)

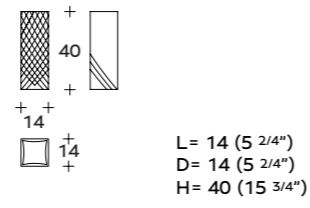

VASE: VAB (11A)

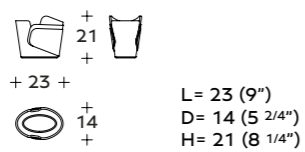



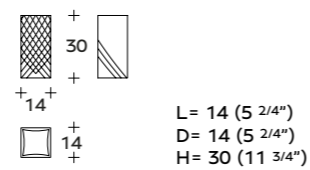









VASE: VAB (14)



VASE: VAB (11B)



Bentley Home is famous for its fine craftsmanship and use of natural materials. The collection is totally custom made through a vast selection of finishes, precious briar roots and essences presented in different veneers and colour variations, soft leathers and fine marbles in balance between tradition and innovation. A great expertise paying homage to the brand's illustrious heritage, whilst openly embracing the future. Creating a captivating lifestyle, for everyday living.

WOODEN FINISHINGS		SPECIAL LACQUERINGS	
CHESTNUT		GLAZE SLATE	
BURR WALNUT		GLAZE EARTH	
AMERICAN WALNUT		GLAZE GREIGE	
EBONY MACASSAR		MARBLES	
DARK FIDDLEBACK EUCALYPTUS		CALACATTA MARBLE	
WARM GREY FIDDLEBACK SYCAMORE		VALENTINE GREY	
TOFFEE BROWN SMOKED LARCH			
SMOKED LIQUIDAMBAR			

H: Altezza totale
 HA: Altezza bracciolo
 HS: Altezza seduta
 HB: Altezza base
 L: Lunghezza totale
 D: Profondità totale
 THK: Spessore

Overall height
 Armrest height
 Seat height
 Base height
 Overall length
 Overall depth
 Thickness

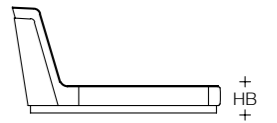
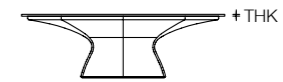
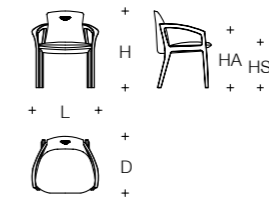

Images and colours of the products printed in this catalogue are purely for information. The products shown in the pictures do not have only one standard cover. Depending on the model, products can be covered both in fabric and/or leather as from the official BENTLEY HOME collection, set of samples and price-list in force during the printing of the catalogue.
 Drawings show the standard version of the product. All the dimensions included in technical descriptions are in cm (inch.), approximate and subject to possible changes (tolerance of +/- 2%).

Due to natural variations of the colorant dyes during the bathing and drying process of the leathers, some slight differences in shade may occur on the final product.
 Any eventual difference in colour that can be noticed between different panels that are joined together to create the same product, must be considered acceptable.
 As a result of technical/production updates, the company reserves the right to change the product information shown on this catalogue anytime and without advance notice.

In order to protect the legitimacy and novelty of our Products, please be informed that all our furniture and accessories contain an internal microchip.



BENTLEY

HOME

Produced by Club House Italia Spa
distributed by Luxury Living Group
Palazzo Orsi Mangelli, Corso Diaz 43/45, 47122 Forlì, Italy
info@luxurylivinggroup.com
luxurylivinggroup.com

"Bentley" the "B in wings device" are registered trademarks of Bentley Motors Limited
www.bentleymotors.com