

BELIEV_&TRAIN

SPORTS MEDAL HANGERS

www.believeandtrain.com



p.2

MHEXTB2



p.6

MHEXBUBK21 / MHEXBUBK11



p.10

MHBHEUBK01

1



2x



2x



2x



2x

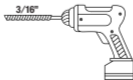



NEVER GIVE UP

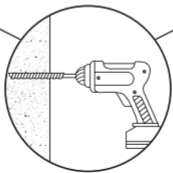

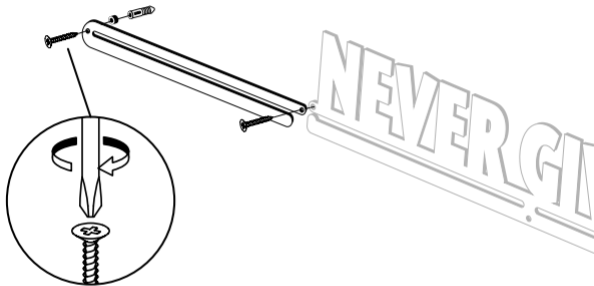

NEVER GIVE UP

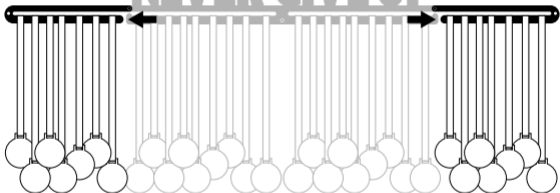



1x



2x



2x



2x

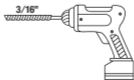



NEVER GIVE UP

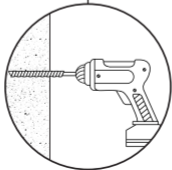

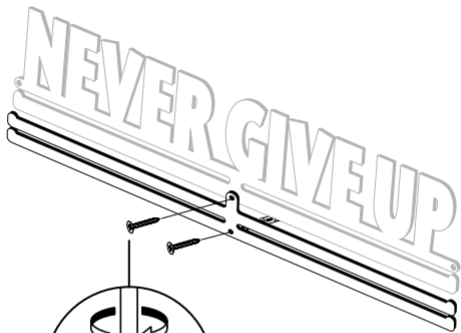

NEVER GIVE UP

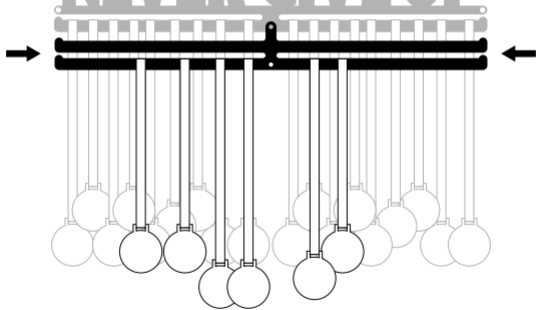



1x



1x



2x



2x



2x



2x



2x

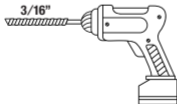

3/16"

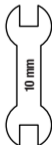
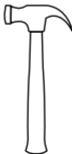

10 mm



NEVER GIVE UP

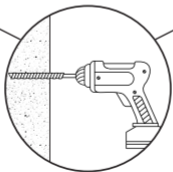

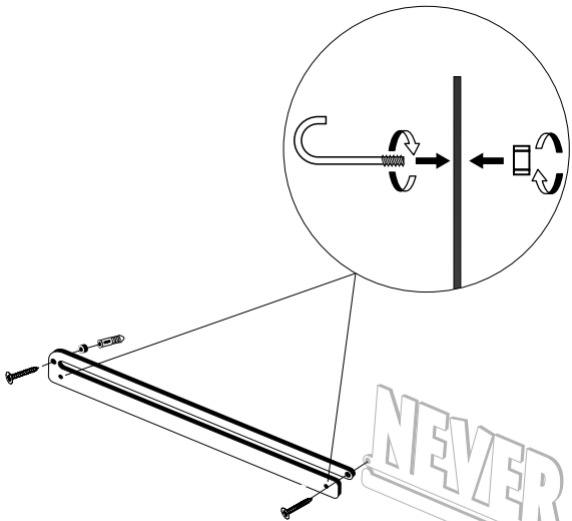

NEVER

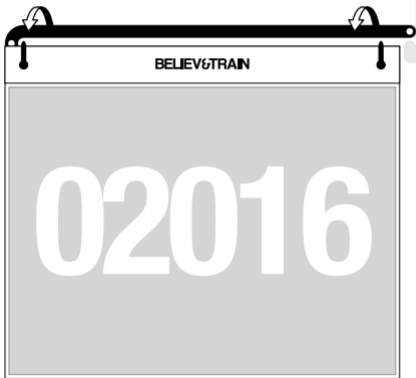

NEVER GIVE UP

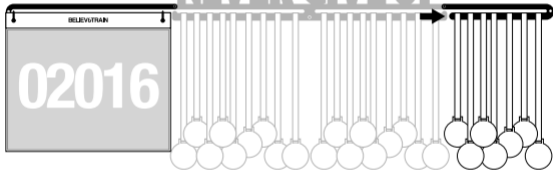

BELIEV&TRAIN



SPORTS MEDAL HANGERS

www.believeandtrain.com

CONTACT:

USA (512) 777 2623

MX (81) 5515 8250

sales@believeandtrain.com

FOLLOW US!

 [/believeandtrain](https://www.facebook.com/believeandtrain)

 [@believeandtrain](https://twitter.com/believeandtrain)

 [/believeandtrain](https://www.instagram.com/believeandtrain)

"Believe&Train" brand, logo, and designs were created since 2013. They are trademarks of Alveni, LLC.
All rights reserved. Made in Mexico.