



575 Naples Road
Mendota, CA 93640

info@wetstonedesign.co
559-269-7363

PROJECT NAME:
Firepit Oblica Round 45 in

ARCHITECT / DESIGNER:
Luis C

DRAWING PACKAGE:
Parts for Firepit Oblica Round 45 in

SHEET CONTENTS:
Final Drawing

MATERIAL:
Concrete

FINISHING:
-

COLOR:
-

AUTHOR	DATE
LC	02/13/2021

NOTES:
-

SHEET NO.
A01

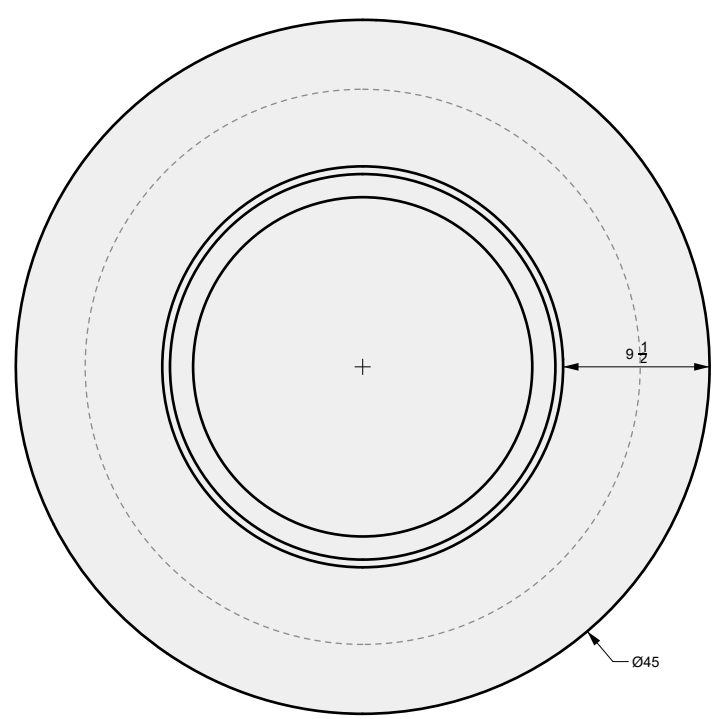

01 TOP VIEW

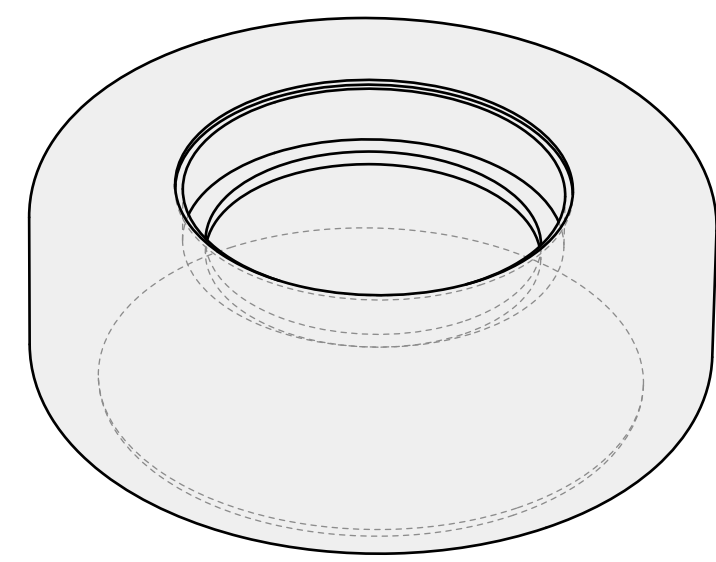

04 PERSPECTIVE

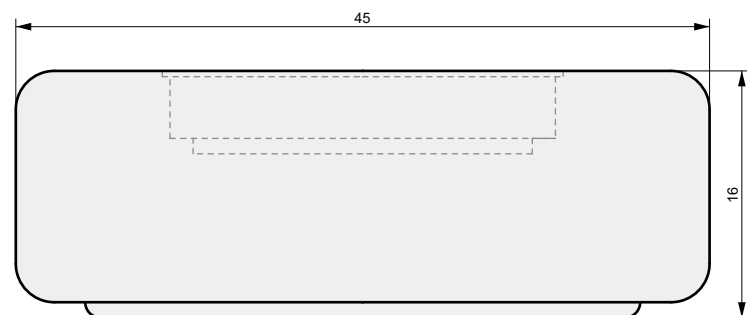

02 FRONT VIEW

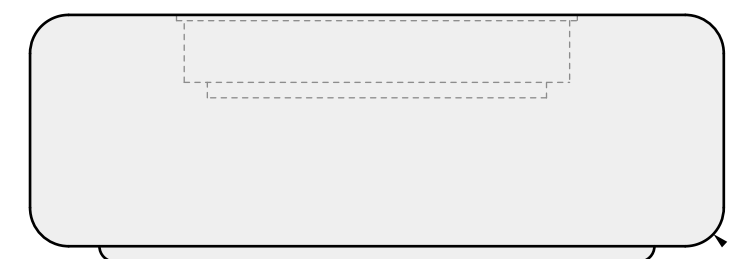

03 SIDE VIEW



575 Naples Road
Mendota, CA 93640

info@wetstonedesign.co
559-269-7363

PROJECT NAME:
Firepit Oblica Round 45 in

ARCHITECT / DESIGNER:
Luis C

DRAWING PACKAGE:
Parts for Firepit Oblica Round
45 in

SHEET CONTENTS:
Final Drawing

MATERIAL:
Concrete

FINISHING:
-

COLOR:
-

AUTHOR	DATE
LC	02/13/2021

NOTES:
-

SHEET NO.
A02

BURNER MODEL

OCTAGONAL CFBO180
Dimensions: 15.75" x 14.25"
180,000 BTU

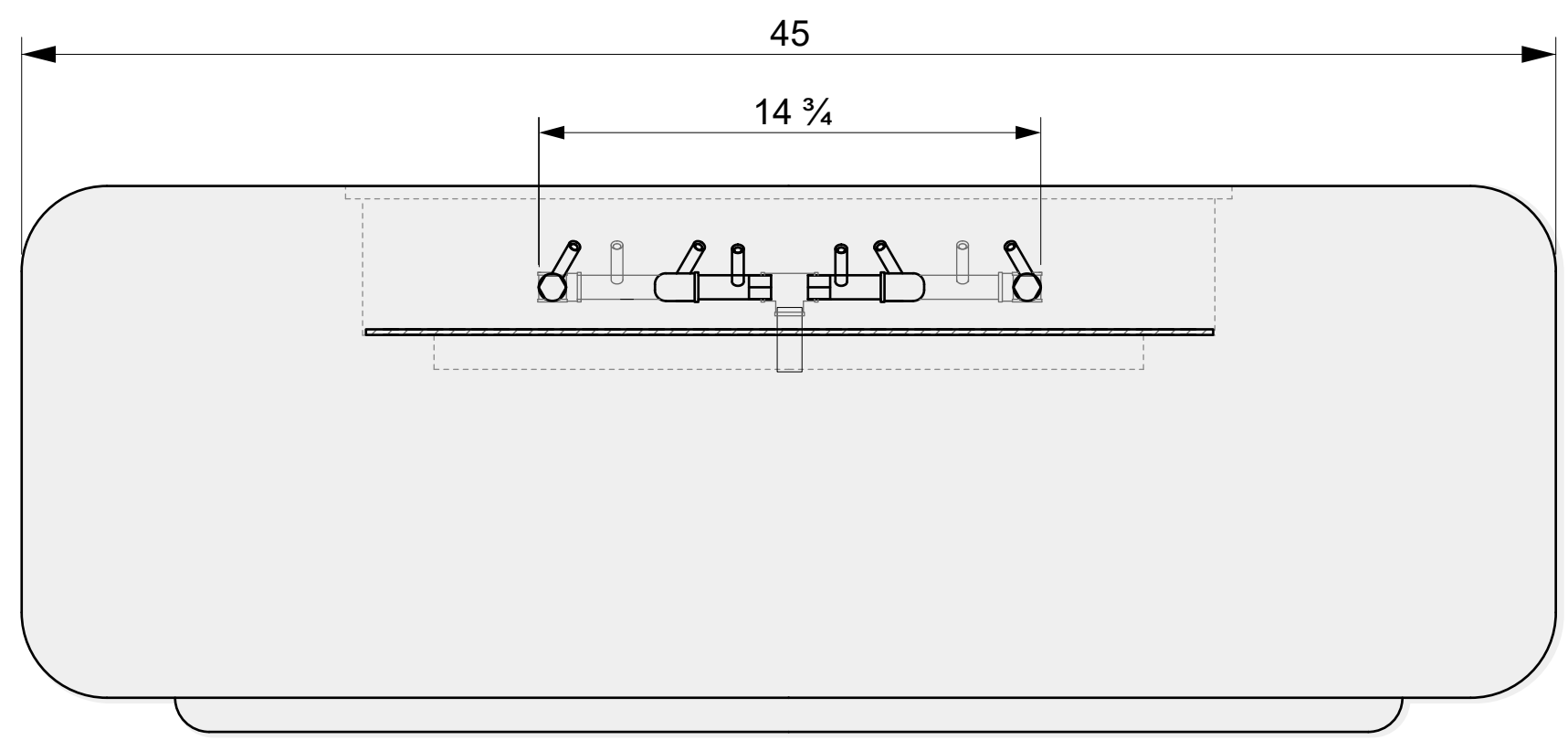
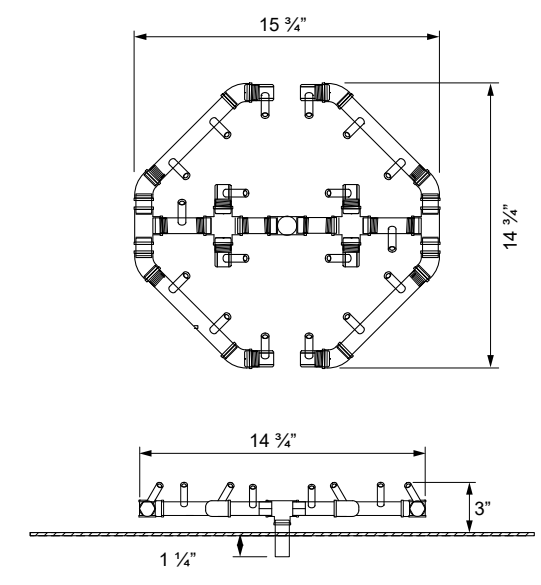

01 SIDE VIEW

A

B

C

D



575 Naples Road
Mendota, CA 93640

info@wetstonedesign.co
559-269-7363

PROJECT NAME:
Firepit Oblica Round 45 in

ARCHITECT / DESIGNER:
Luis C

DRAWING PACKAGE:
Parts for Firepit Oblica Round 45 in

SHEET CONTENTS:
Aluminum Top

MATERIAL:
1/4 in Aluminum Sheet

FINISHING:
-

COLOR:
-

AUTHOR	DATE
LC	02/13/2021

NOTES:
-

SHEET NO.
A03

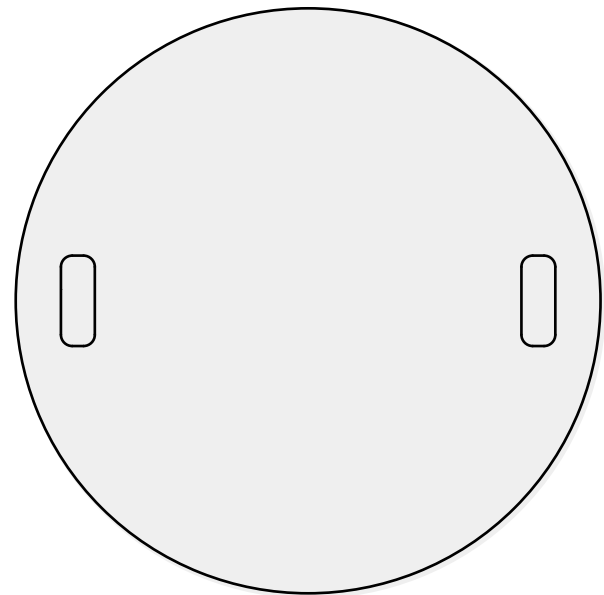

01 TOP VIEW

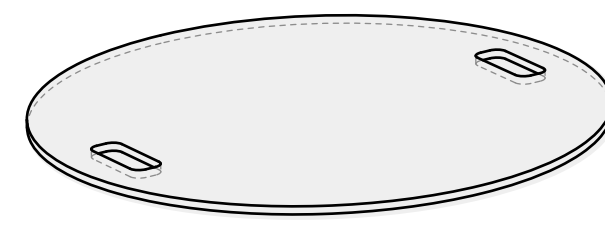

03 PERSPECTIVE



02 FRONT VIEW



575 Naples Road
Mendota, CA 93640

info@wetstonedesign.co
559-269-7363

PROJECT NAME:
Firepit Oblica Round 45 in

ARCHITECT / DESIGNER:
Luis C

DRAWING PACKAGE:
Parts for Firepit Oblica Round
45 in

SHEET CONTENTS:
Stainless Steel Plate

MATERIAL:
1/8 in Stainless Steel Sheet

FINISHING:
-

COLOR:
-

AUTHOR	DATE
LC	02/13/2021

NOTES:
-

SHEET NO.
A04

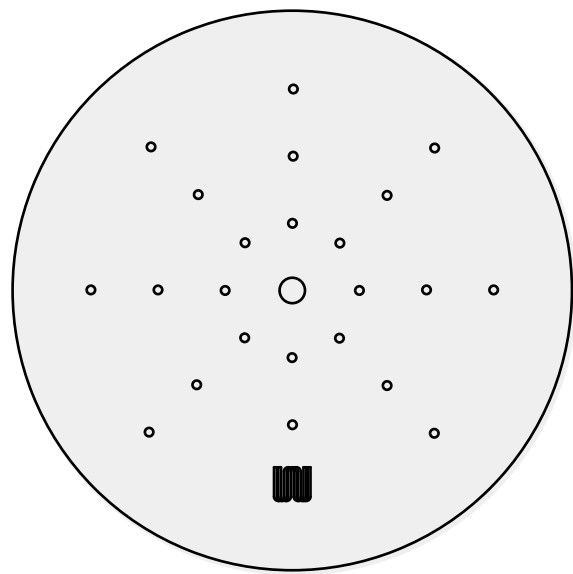

01 TOP VIEW

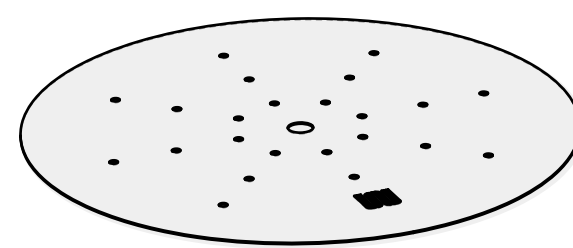

03 PERSPECTIVE



02 FRONT VIEW