



575 Naples St.
Mendota, CA 93640

info@wetstonedesign.co
559-269-7363

PROJECT NAME:
Cumulo Firepit 85 in

ARCHITECT / DESIGNER:
Luis C

DRAWING PACKAGE:
Cumulo Firepit 85 in

SHEET CONTENTS:
Final Drawing

MATERIAL:
Concrete

FINISHING:
-

COLOR:
-

AUTHOR	DATE
LC	06/18/2020

NOTES:
-

SHEET NO.
A01

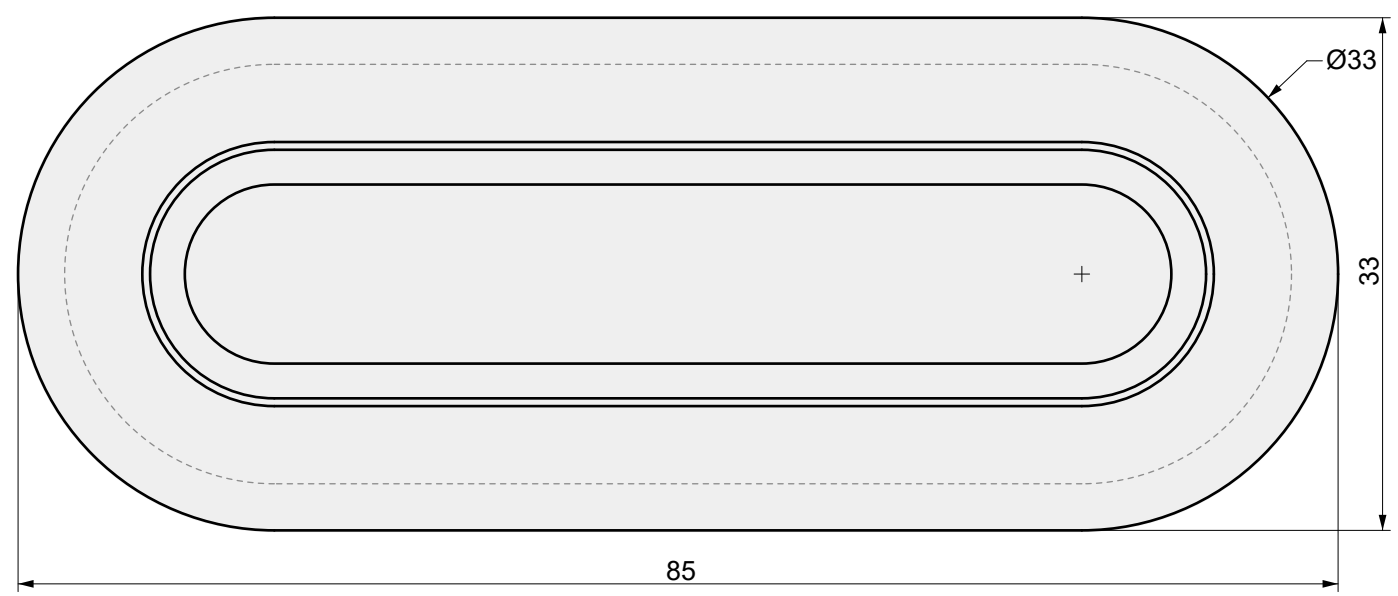

01 TOP VIEW

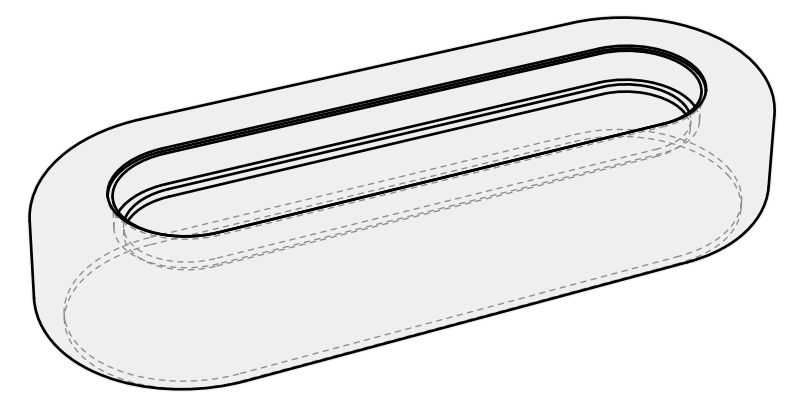

04 PERSPECTIVE

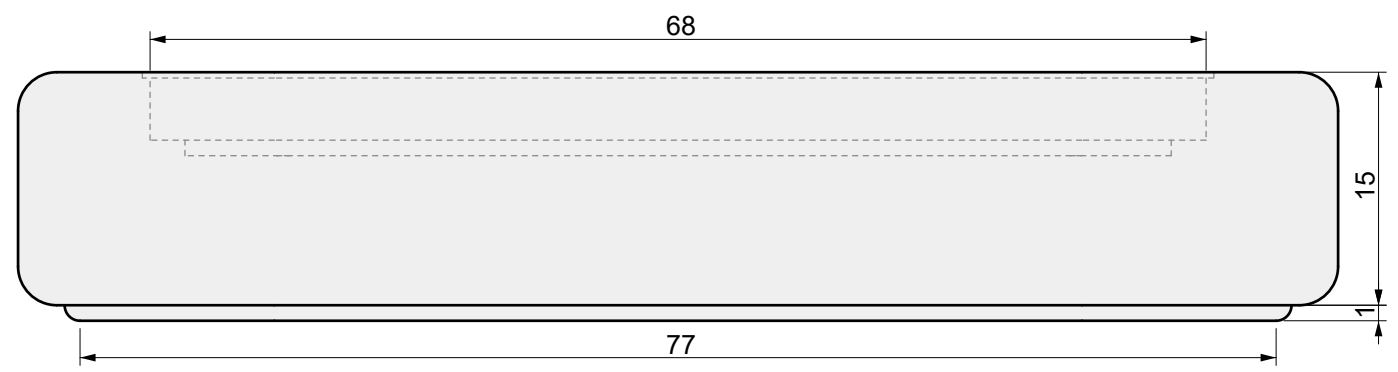

02 FRONT VIEW

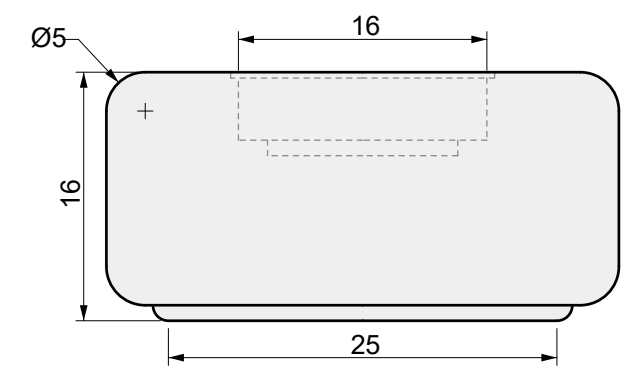

03 SIDE VIEW



575 Naples St.
Mendota, CA 93640

info@wetstonedesign.co
559-269-7363

PROJECT NAME:
Cumulo Firepit 85 in

ARCHITECT / DESIGNER:
Luis C

DRAWING PACKAGE:
Cumulo Firepit 85 in

SHEET CONTENTS:
Burner Setting

MATERIAL:
-

FINISHING:
-

COLOR:
-

AUTHOR	DATE
LC	06/18/2020

NOTES:
-

SHEET NO.
A02

BURNER MODEL

LINEAR CFBL270
Dimensions: 54" x 1.5"
270,000 BTU

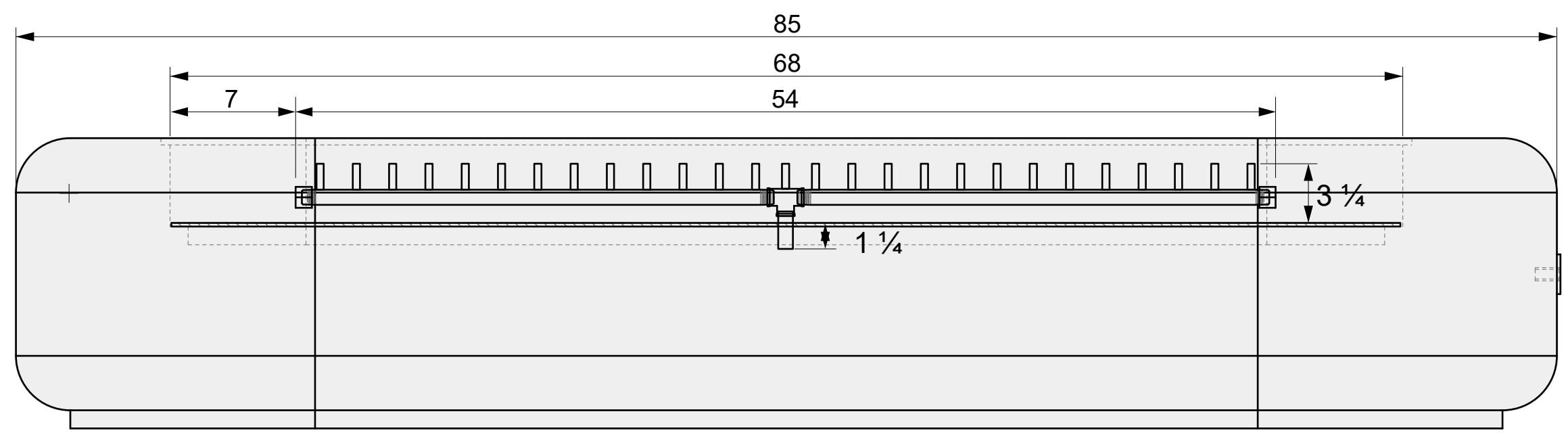
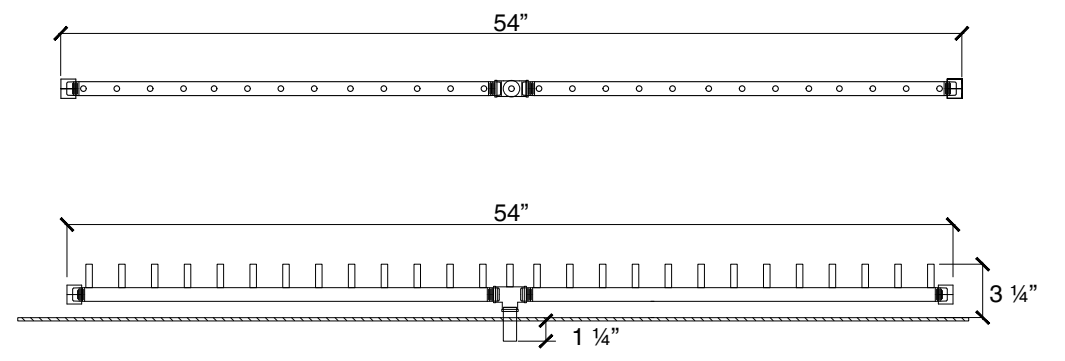

01 SIDE VIEW

A

B

C

D



575 Naples St.
Mendota, CA 93640

info@wetstonedesign.co
559-269-7363

PROJECT NAME:
Cumulo Firepit 85 in

ARCHITECT / DESIGNER:
Luis C

DRAWING PACKAGE:
Cumulo Firepit 85 in

SHEET CONTENTS:
Aluminum Top

MATERIAL:
1/4 Aluminum Sheet

FINISHING:
-

COLOR:
-

AUTHOR	DATE
LC	06/18/2020

NOTES:
-

SHEET NO.
A03

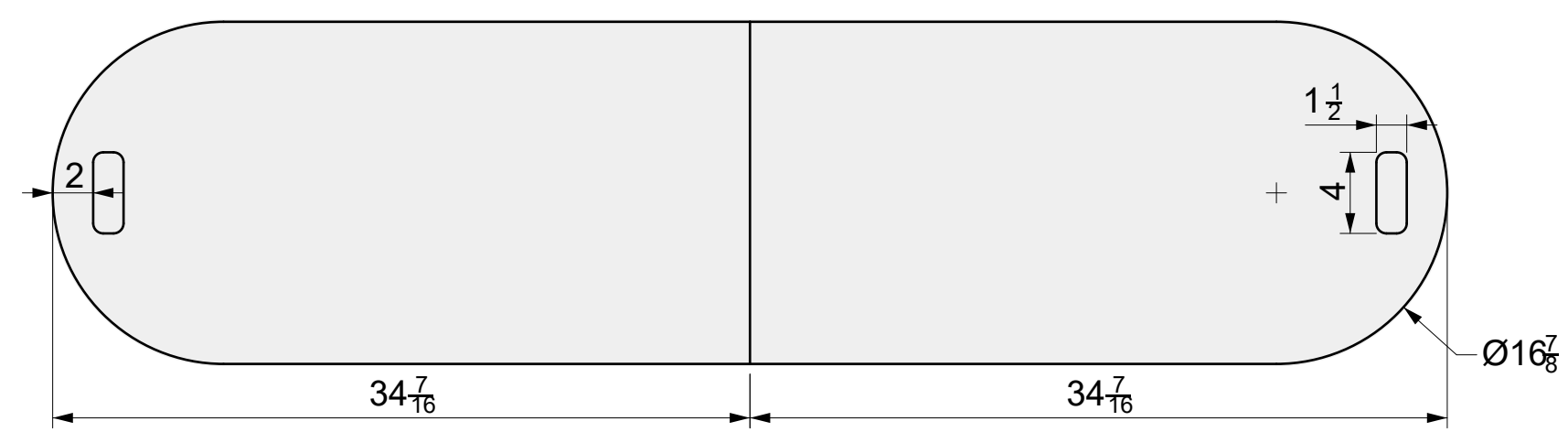

01 TOP VIEW

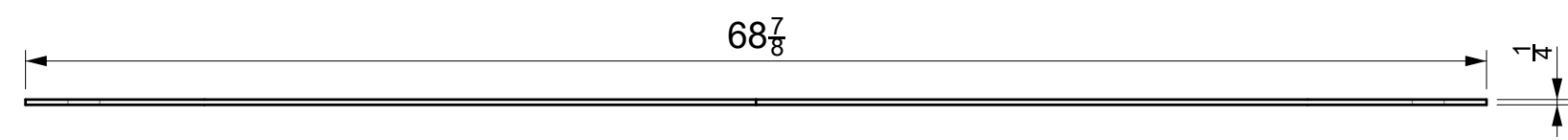

02 FRONT VIEW

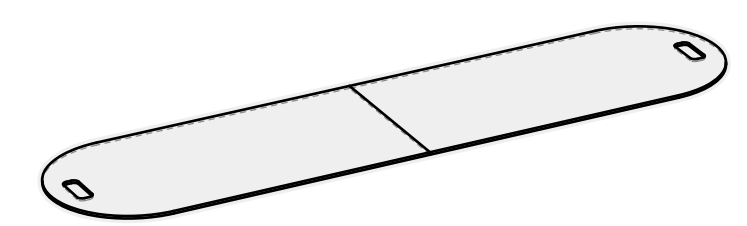

04 PERSPECTIVE

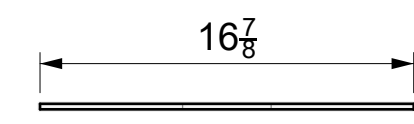

03 SIDE VIEW



575 Naples St.
Mendota, CA 93640

info@wetstonedesign.co
559-269-7363

PROJECT NAME:
Cumulo Firepit 85 in

ARCHITECT / DESIGNER:
Luis C

DRAWING PACKAGE:
Cumulo Firepit 85 in

SHEET CONTENTS:
Stainless Steel Plate

MATERIAL:
1/16 in Stainless Steel Sheet

FINISHING:
-

COLOR:
-

AUTHOR	DATE
LC	06/18/2020

NOTES:
-

SHEET NO.
A04

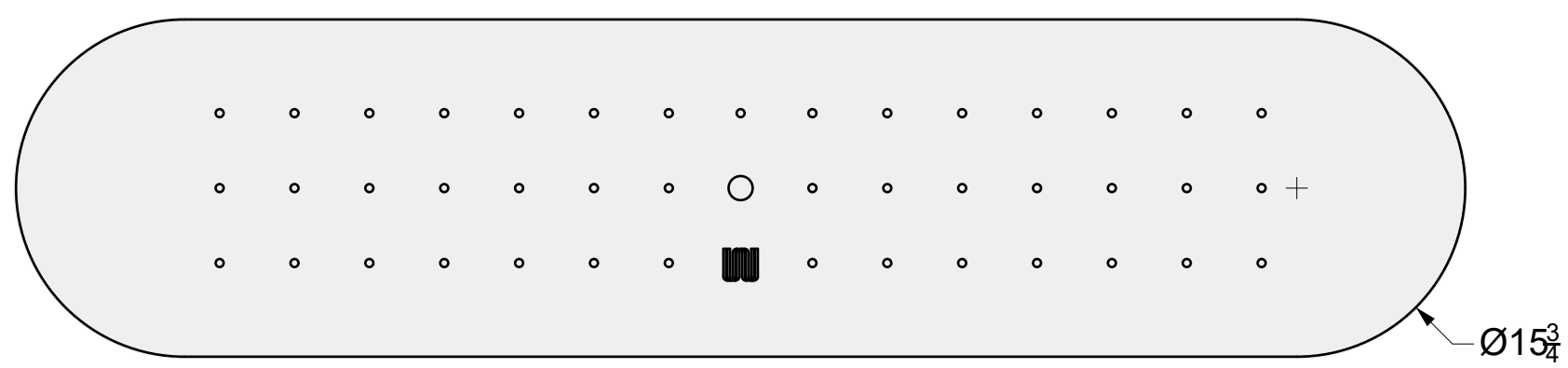

01 TOP VIEW

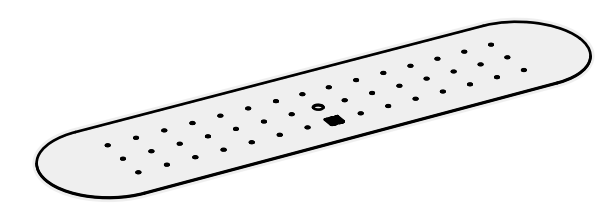

04 PERSPECTIVE

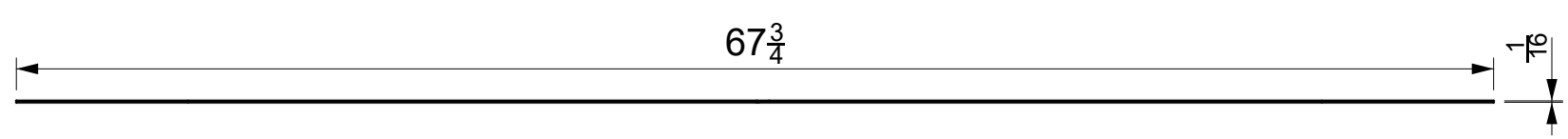

02 FRONT VIEW

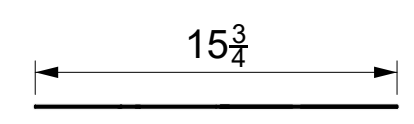

03 SIDE VIEW

A

B

C

D