



RICTOR reserves the right to make changes to the vehicle,
release firmware updates, and update this manual at any time.
Visit www.rictor.com to download the latest user materials.
You must install the App to follow the new rider tutorial, activate
your vehicle, and obtain the latest updates and safety instructions.

www.rictor.com

Alpha

user manual

USER MANUAL

There are important instructions on safety and usage in the User Manual. You must read it entirely and carefully before your first ride.
Packing List: Main Scooter, Battery Charger, User Manual, Tools (Screw)

Contents

1: Function	01
2: Assemble	02
3: Dashboard Operation	04
4: Charging	05
5: Beginners	06
6: Avoid Potential Safety Hazards	08
7: No Dangerous Actions	10
8: Safety Instructions	12
9: Daily Maintenance	14
10: Model Parameter Table	15
11: Contact Us	16

1 FUNCTION

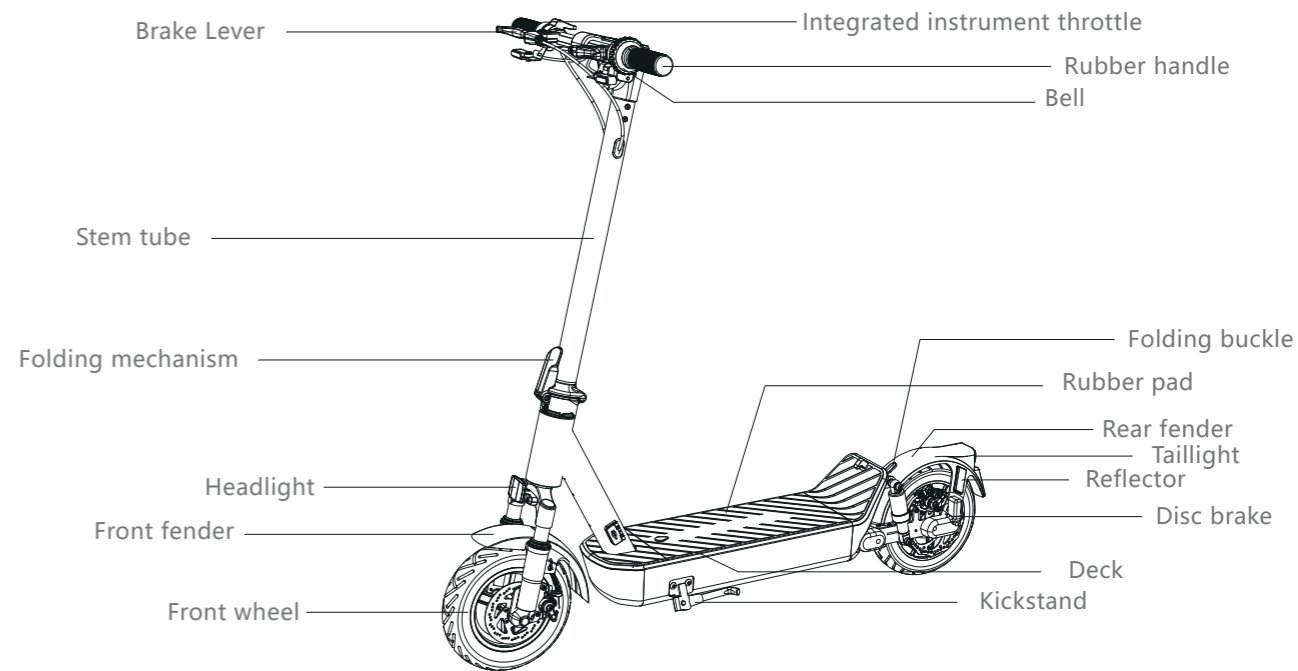

2 ASSEMBLE



1. Fix the stem tube and open the kickstand.



2. Install the handlebar into the stem tube.



3. Use the hexagon wrench in the box to tighten the screws on both sides and the back side.



4. After the installation, detect by switching on and off.

3 DASHBOARD OPERATION

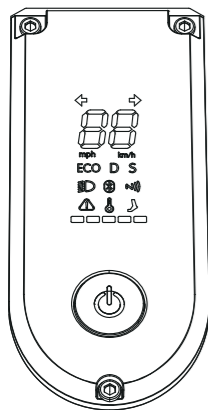

- 1: Power Switch: Short press to power on, then the scooter information will be displayed on the dashboard. Drive after unlocking the scooter by using NFC card, otherwise you cannot drive the scooter. Long press to power off.
- 2: Mode Selection: 3 driving modes are available, which respectively are ECO mode (energy-saving), D mode (Standard), and S mode (Sports). Single click to switch the mode.
- 3: Speedometer: Indicates the current speed. Also displays error codes when faults are detected.
- 4: LED Lighting: Double-click to turn on.
- 5: Bluetooth: A solid Bluetooth icon indicates that the vehicle is connected to a mobile device. You can view the vehicle status after connecting to the APP via Bluetooth.
- 6: Optional NFC: When the NFC card is close to the display panel, the NFC logo on the panel will light up, and the buzzer will beep to indicate successful unlock.
- 7: Over-temperature Display: If the internal temperature of the controller and motor is too high during the operation of the vehicle, the panel will promptly display an over-temperature alarm.
- 8: Failure Alarm: When the controller fails, the alarm symbol will light up to warn.

4 CHARGING

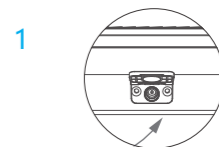

Open the charging cover

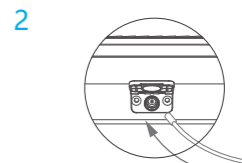

Plug in the charging plug



Close the charging cover after charging

5 BEGINNERS

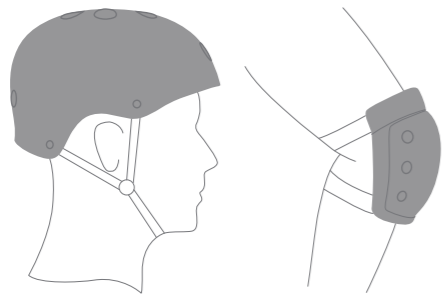

When you are in learning, please wear helmets and protective devices all the way.



1 Power on the scooter and check the indicator lamp power level. Charge the scooter if the battery level is low. After booting, use NFC card on the dashboard.



2 Stand on the footrest with one foot and push off with your foot to start gliding.

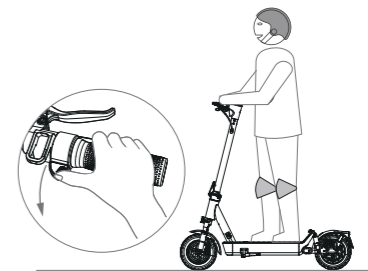

3 Put your other foot on the footrest to keep both feet stable. Press the throttle on right hand to speed up when you are balanced. Note, For your safety, the motor will not engage until the scooter reaches 5km/h

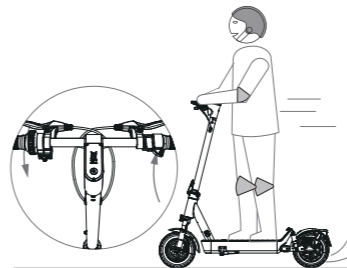

4 Slow down by releasing the throttle; stir the brake handle thumb shifter quickly and stamp the fender with foot at the same time to trigger mechanical braking in order to make a sharp brake.

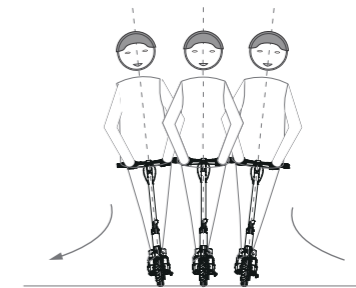

5 To turn, shift your body weight and turn the handle slightly.

6 AVOID POTENTIAL SAFETY HAZARDS



⚠ Do Not Recommend Using when Raining or Freezing



⚠ DO NOT ride over speed bumps, thresholds, or other bumps at HIGH SPEED.

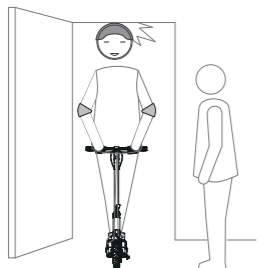

⚠ Watch your head when passing through doorways.



⚠ Watch your speed when traveling downhill. Use both brakes together when traveling at high speed.

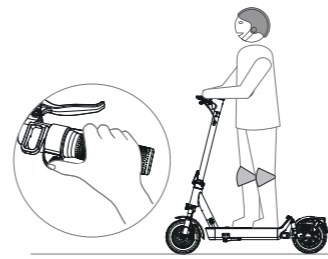

⚠ DO NOT press the throttle when walking with the scooter.

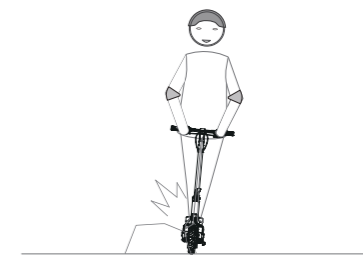

⚠ Avoid contacting obstacles with the tire/wheel.

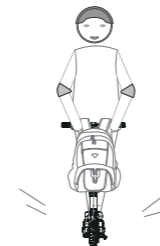

⚠ DO NOT carry heavy objects on the handlebar.

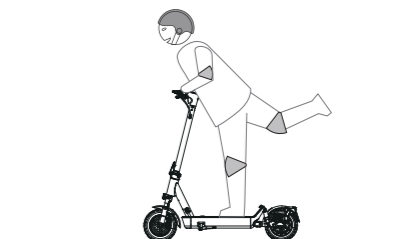

⚠ DO NOT ride the scooter with only one foot.

7 NO DANGEROUS ACTIONS

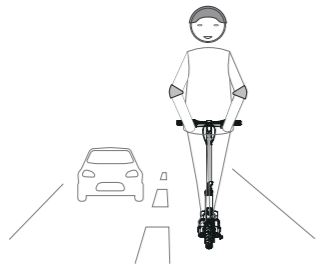

❌ DO NOT ride on public roads, motorways, or highways.

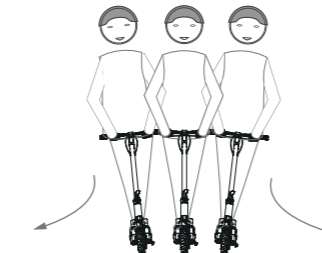

❌ DO NOT rotate the handle violently while driving at high speed.



❌ DO NOT trample the rear end of the fender.

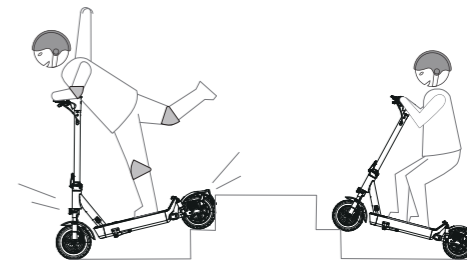

❌ DO NOT ride up and down stairs or jump over obstacles.



❌ DO NOT ride the scooter in the rain or on the road with water in excess of 2cm depth.

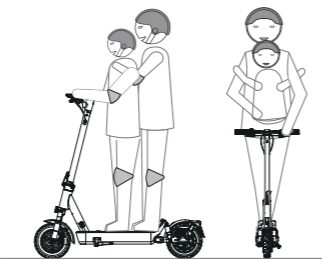

❌ The KickScooter is for one rider only. Do not ride double or carry any passengers. Do not carry a child.



❌ DO NOT take your hands off the handlebar while riding. Do not ride with one hand only.

8 SAFETY INSTRUCTIONS

Please understand that you can reduce the risk by following all the instructions and warnings in this manual, but you cannot eliminate all the risks. Remember that whenever you ride the vehicles you risk injury from loss of control, collisions, and falls.

The electric scooter is an intelligent and convenient transportation tool to meet the needs of short-distance. When entering into public spaces always comply with the local laws and regulations. For related laws and regulations, please consult the relevant local departments or contact our agents and after-sales departments.

Note:

- ★Always wear helmets, gloves, elbow pads, knee pads and other safety protective equipment when riding;
- ★Check whether the power is sufficient and any abnormal noise or looseness before riding;
- ★Ride on slippery roads is forbidden, especially on icy and snowy roads;
- ★Recommend not to ride on up and down slopes exceeding 15°;
- ★Ride on rainy days is forbidden;
- ★Not recommended for children under 15 years of age to learn and ride;
- ★Avoid sudden acceleration and deceleration, do not lean forward and lean backward too much, and prohibit speeding; when the power is insufficient, please keep riding at a low speed and charge as soon as possible;
- ★Focus on protecting personal safety when risk of falling and always adhere to the principle of "people are first";
- ★Do not put your hands in your pockets when riding to prevent unexpected situations;
- ★Do not leave the scooter in the trunk of the car for a long time in high temperature weather;
- ★Always comply with the local laws and regulations and keep a safe distance between you and other people or vehicles when riding.

- ★Do not frighten people in public space, especially children; warn people and reduce speed when passing behind them ;
- ★Keep an appropriate safety distance with other riders, avoid danger and obstacles, and do not ride side by side unless there is enough space to pass through;
- ★Do not ride in the dark place, if necessary, reduce the speed and stay alert;
- ★Reverse riding is dangerous, try to avoid backward riding;

Active safety protection measures

Please read this manual carefully and understand and approve the contents.

- ★Do not let others use your scooter unless they have read this manual carefully;
- ★Please take good safety protection measures during driving. Whenever you ride, please wear an approved helmet with a hatband that can conform to the head shape and can protect the back of the head, and wear protective equipment such as gloves, eye protection equipment, elbow pads and knee pads;
- ★Do not ride if you are not well or cannot follow the instructions or warnings in this manual; do not ride under the influence of alcohol or drugs;
- ★Please get off the scooter and charge it in time to ensure safety when the scooter power is low, the alarm is continued and the speed is limited;
- ★Do not lift the scooter from the tire to avoid getting fingers stuck between the tire and the shell;
- ★Please check the scooter each time before riding. If any looseness or damage is found, do not ride before troubleshooting.

Please speed up slowly. Sudden acceleration can easily cause the scooter to lose its balance and cause the rider to fall and get injured! This is a dangerous habit and is responsible for most accidental falls and off-balance injuries. Sudden dangers may occur during the ride, so ride carefully at all times. The company shall not be responsible for any personal injuries caused by failure to follow the instructions in the manual.

9 Daily Maintenance

If the surface of the scooter is stained, use a soft cloth dipped in a little water to wipe it; If it is difficult to clean, use the toothpaste and brush repeatedly the stain with the toothbrush, then clean it with the wet cloth.

Do not use alcohol, gasoline, kerosene, or other corrosive, volatile chemical solvents to clean, otherwise it will seriously damage the appearance and internal structure of the scooter. It is forbidden to spray and wash with a water torch. Ensure that the scooter is turned off during cleaning, and the charging cable has been unplugged and the rubber plug of the charging port is strictly tightened, otherwise it may cause electric shock or serious failure due to internal water ingress.

Place the scooter in a dry and cool place indoors, and avoid storing it outdoors for a long time. Exposure to the sun/over-heat/over-cold outdoors can accelerate the scooter appearance and tires of aging and reduce the life of the battery pack.

Maintenance of scooter battery pack

Do not put the battery pack in a high-temperature environment above 50°C or a low-temperature environment below -20°C (for example, do not put the scooter or its battery pack in a car exposed to summer exposure). It is forbidden to put the battery pack into a fire, otherwise it may cause the battery to fail, overheat, or even catch fire.

Avoid completely exhausting the battery before recharging, and try to use it as much as possible, which can greatly extend the life of the battery. In addition, the battery can play a higher cruising range when used at normal temperature; the battery life and performance will be reduced if it is used in an environment below 0°C. Typically, in the -20 °C environment, the cruising range may only be half or less than at room temperature. After the temperature rises, the battery range will be restored.

When the scooter is not used for a long time, it is recommended to charge the scooter battery every 0.5 to 1 month. (Note: Non-professionals are forbidden to disassemble the battery pack at will, otherwise it may cause serious safety accidents due to electric shock or short circuit!)

10 MODEL PARAMETER TABLE

Parameter	Item	Alpha
Dimension	Folding Size	1190*583*600
	Height	1170
Weight	Max load	120kg
	Net Weight	24.5kg
For people	For Age	16~60
	For height	120~200
Machine parameters	Max speed	≤40
	Theoretical cruising	65km
	climbing slope	25%
	Operating temperature	-10°C~40°C
Battery pack parameters	Waterproof level	IPX5
	Rated voltage	36V
	Max charging voltage	42V
Motor parameters	Battery capacity	15.6Ah
	Rated power	500w
Charger Parameters	Rated power	84W
	Rated Input voltage (V)	100~240 AC
	Rated Output voltage (V)	42 VDC
	Rated current (A)	3A
	Charging time (h)	5~6h

Note: The data and parameters may vary with different models. No additional notice will be made in terms of any variation.

11 CONTACT US

During your use, if you have any questions about riding, maintenance and security, or feedback to the manufacturer about the failure of your product, you can contact us in the following ways, we are very happy to provide you with help services.

There is an official QR code on the back cover of this manual. You only need to scan with your mobile phone to log in to the official website. For more information about the latest products. Please pay attention.

Authorization: Nanjing Kuailun Intelligent Technology Co., Ltd.
Address: B4-2F, Maple science park, Xigang Street, Qixia district,
Nanjing, China
After-sales Tel: 400-186-1968

Authorization: Nanjing Kuailun Intelligent Technology Co., Ltd.
Address: B4-2F, Maple science park, Xigang Street, Qixia district,
Nanjing, China
After-sales Tel: 400-186-1968