

User Manual for KingSmith WalkingPad Treadmill

Please read the User Manual carefully before using the Treadmill, and keep it properly.



Manufacturer: Beijing Kingsmith Technology Co., Ltd.
Address: Floor 4, Building 25, Area 18, ABP Park, Fengtai, Beijing, China.
MADE IN CHINA

Model No.: *TRX21F*

WalkingPad KING SMITH | 

Caution: The user is cautioned that changes or modifications not expressly approved by the party responsible for compliance could void the user's authority to operate the equipment.

This device complies with Part 15 of the FCC Rules. Operation is subject to the following two conditions: (1) this device may not cause harmful interference, and (2) this device must accept any interference received, including interference that may cause undesired operation.

NOTE: This equipment has been tested and found to comply with the limits for a Class B digital device, pursuant to Part 15 of the FCC Rules. These limits are designed to provide reasonable protection against harmful interference in a residential installation. This equipment generates, uses and can radiate radio frequency energy and, if not installed and used in accordance with the instructions, may cause harmful interference to radio communications. However, there is no guarantee that interference will not occur in a particular installation.

If this equipment does cause harmful interference to radio or television reception, which can be determined by turning the equipment off and on, the user is encouraged to try to correct the interference by one or more of the following measures:

- Reorient or relocate the receiving antenna.
- Increase the separation between the equipment and receiver.
- Connect the equipment into an outlet on a circuit different from that to which the receiver is connected.
- Consult the dealer or an experienced radio/TV technician for help.

FCC Radiation Exposure Statement

This equipment complies with FCC radiation exposure limits set forth for an uncontrolled environment.

This transmitter must not be co-located or operating in conjunction with any other antenna or transmitter.

The appliance is intended for household.



DANGER – To reduce the risk of electric shock:

Always unplug this appliance from the electrical outlet immediately after using and before cleaning.



WARNING – To reduce the risk of burns, fire, electric shock, or injury to persons:

- 1) An appliance should never be left unattended when plugged in. Unplug from outlet when not in use, and before putting on or taking off parts.
- 2) Close supervision is necessary when this appliance is used by, on, or near children, invalids, or disabled persons.
- 3) Use this appliance only for its intended use as described in this manual. Do not use attachments not recommended by the manufacturer.
- 4) Never operate this appliance if it has a damaged cord or plug, if it is not working properly, if it has been dropped or damaged, or dropped into water. Return the appliance to a service center for examination and repair.
- 5) Do not carry this appliance by supply cord or use cord as a handle.
- 6) Keep the cord away from heated surfaces.
- 7) Never drop or insert any object into any opening.
- 8) Do not use outdoors.
- 9) Do not operate where aerosol (spray) products are being used or where oxygen is being administered.
- 10) To disconnect, turn all controls to the off position, then remove plug from outlet.

Connect this appliance to a properly grounded outlet only. See Grounding Instructions.

This appliance is not intended for use by persons with reduced physical, sensory or mental capabilities, or lack of experience and knowledge, unless they have been given supervision or instruction concerning use of the appliance by a person responsible for their safety. Keep children under the age of 13 away from this machine.

To reduce the risk of electric shock, this appliance has a polarized plug (one blade is wider than the other). This plug will fit in a polarized outlet only one way. If the plug does not fit fully in the outlet, reverse the plug. If it still does not fit, contact a qualified electrician to install the proper outlet. Do not change the plug in any way.

1.0 EN ENGLISH.....PG/02

2.0 FR FRANÇAIS.....PG/20

3.0 DE DEUTSH.....PG/38

4.0 ES ESPAÑOL.....PG/56

5.0 POR PORTUGAL.....PG/74

6.0 IT ITALIANO.....PG/92

Contents

1.1 Product and Accessories	04
1.2 Functional Diagram	05
1.3 Guide for Initial Use	09
1.4 Operational Instructions	11
1.5 Trademark and Legal Statement	14
1.6 Safety Precautions	15
1.7 Care and Maintenance	18
1.8 Replacement and Disposal	19

Welcome!

Thanks for choosing KingSmith WalkingPad Treadmill (hereinafter referred to as "the Treadmill"), which boasts a simple, exquisite, and innovative design. Users of the Treadmill can enjoy an at-home workout and boost the quality of life. The Treadmill is for home use only, not for business, leasing, or public organization purposes.

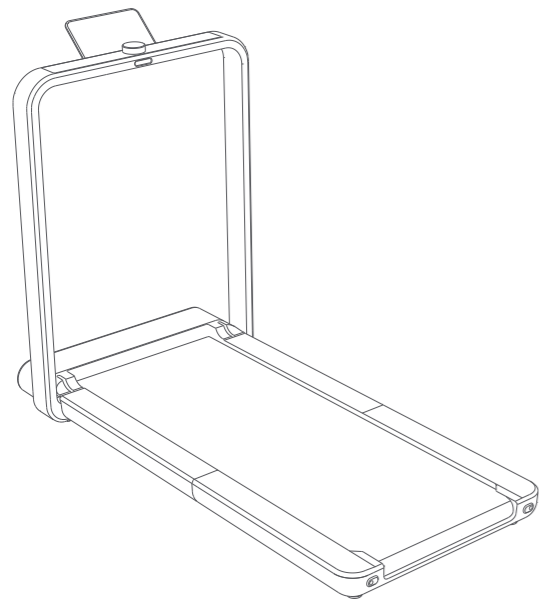

Performance index	Detailed parameters
Applicable age	14-60 years old
Speed range	1-12 km/h
Running area	460×1210 mm
Maximum load	110 kg
Frequency	50/60 Hz
Voltage	220-240 V~
Power	918 W
Net weight	38 kg
Unfolding dimension	1419×711×1053 mm
Folding dimension	1007×711×225 mm

1.1 Product and Accessories

Please carefully check whether the items contained in the packing box are complete and intact, and contact the retailer once finding any items missing or damaged.

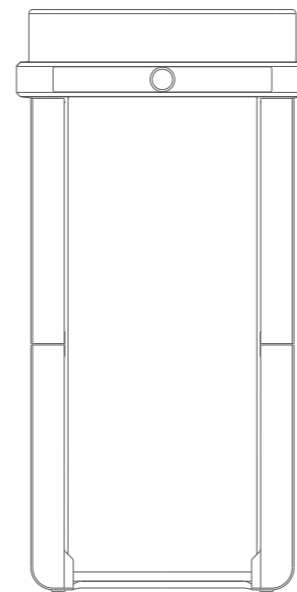

Treadmill

Accessories



Power cord



Mobile phone holder



Safety key



Wrench



Silicone oil

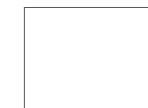

Manual

1.2 Functional Diagram

1. Unfolding state

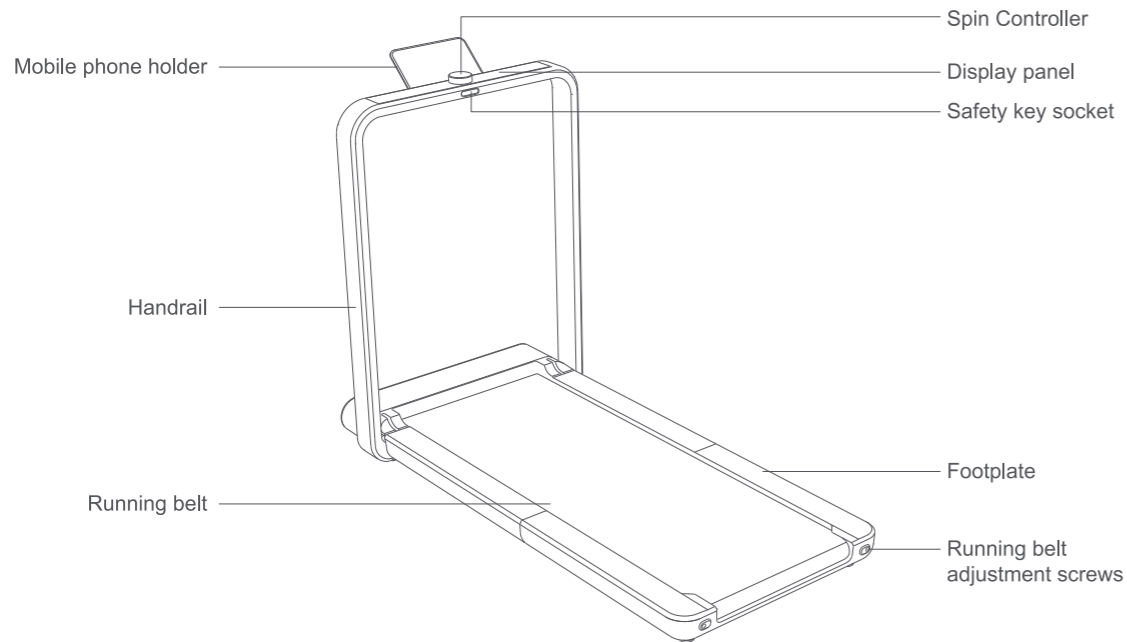

2. Folding state

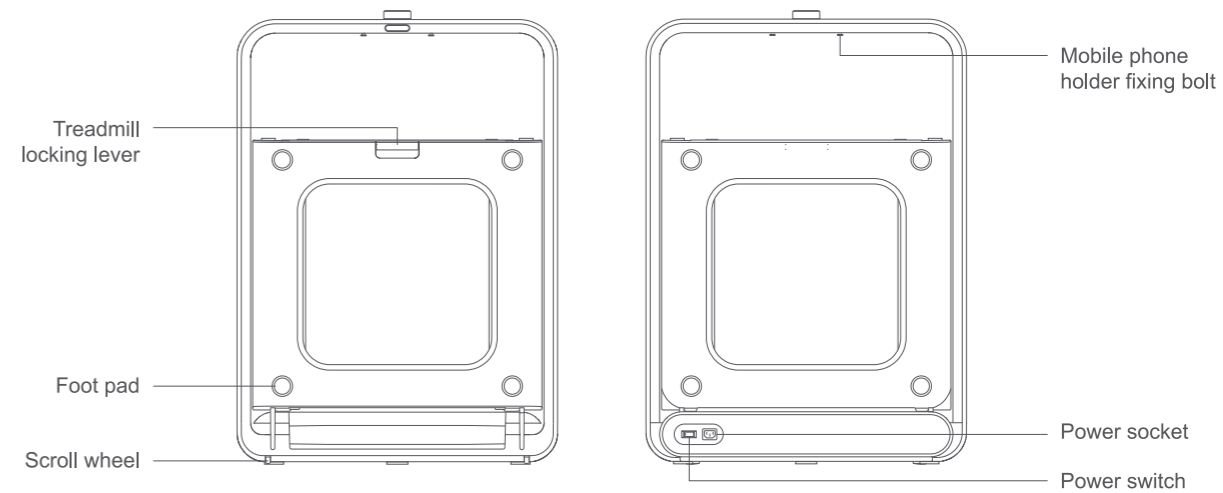

3. Functions of the display panel

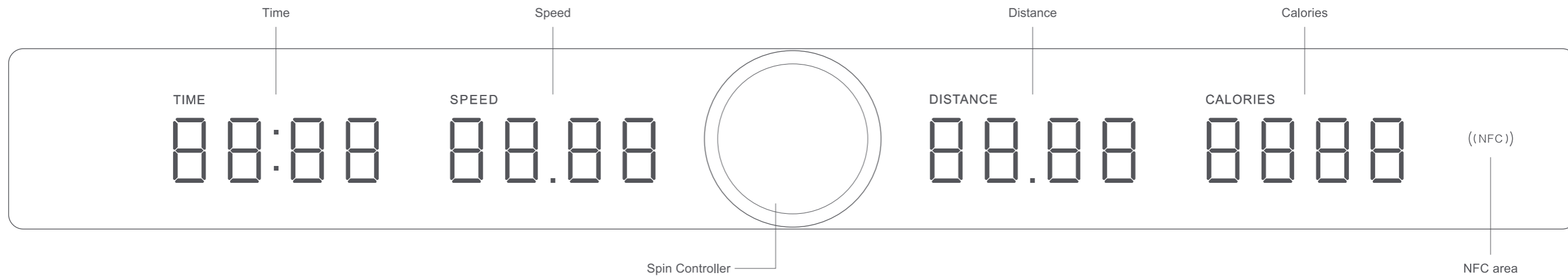

1.3 Guide for Initial Use

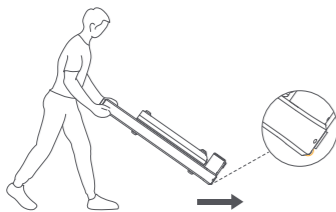

1. Before pushing or pulling the Treadmill, please make sure the Treadmill is locked and placed on flat ground.

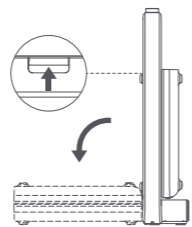

2. Pull up the treadmill locking lever to unlock the Treadmill and slowly keep it flat.

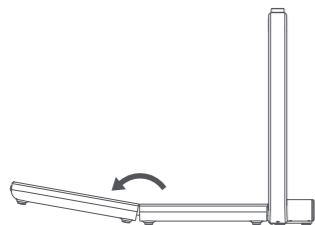

3. Unfold the Treadmill, adjust the running belt to the center position, slowly unfold and press the treadmill, or rotate the bottom foot pad to make it completely flat.

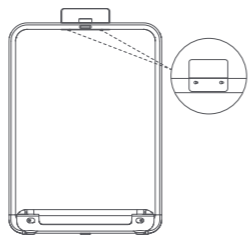

4. Take out the mobile phone holder from the accessory box, connect two large holes to the fixing bolts beneath the handrail, then push towards the direction of the narrow ends of the holes, thus fixing the mobile phone holder to the handrail.

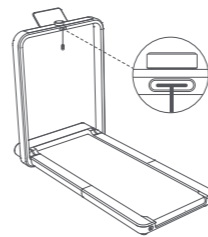

5. Take the safety key out of the accessory box, and insert it into the safety key socket in the middle of the handrail.

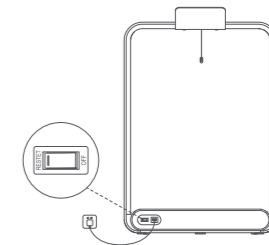

6. Turn on the Treadmill switch after connecting the power cord.



7. Scan the QR code above or search for "KS Fit" in App Store or Google Play to complete the installation and sign-up.

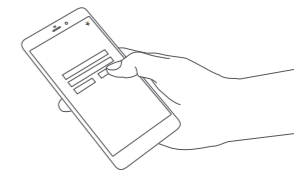

8. Before using the Treadmill, open the APP, add and bind the Treadmill following the prompts.

1.4 Operational Instructions

1. Start running



1. After the Treadmill is powered on, the display panel will be lit up, and all parameters will be displayed as "0" by default.

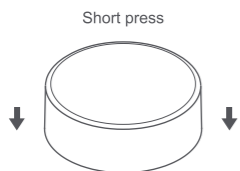

3. After the Spin Controller is short pressed for 3 seconds in the default mode, the Treadmill will be started slowly.

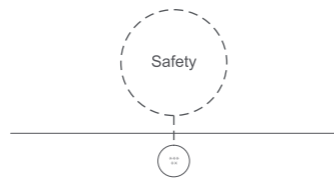

2. If the safety key is not inserted, a prompt of "Safety" will be displayed, and the "SAFE" mode will be activated. If failing to start the Treadmill, please insert the safety key.

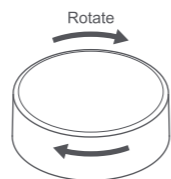

4. Rotate the Spin Controller clockwise to accelerate. Rotate the Spin Controller counterclockwise to decelerate.

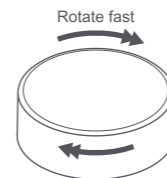

5. Fast regulation of speed: Rotate the Spin Controller quickly to switch the speed levels, which will be switched among 1km/h, 3km/h, 6km/h, 9km/h, and 12km/h.

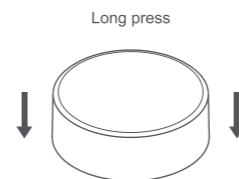

7. In the pause mode, after the Spin Controller is long pressed for 2 seconds or there is no operation for 180 seconds, the Treadmill will stop, and all parameters will return to "0" by default.

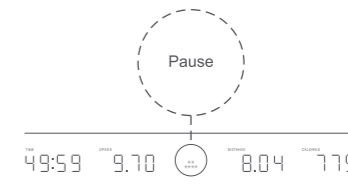

6. After the Spin Controller is short pressed during movement, or after the no-load operation lasts for 5 minutes, the Treadmill will slowly stop and enter the pause state. Then, short press the Spin Controller again to restart the Treadmill, which will return to the original speed level before the pause.



8. After finishing the exercise, please turn off the power switch and put away the power cord.

2. Other statuses displayed on the Spin Controller screen

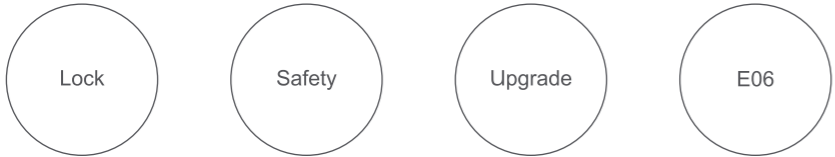

Instructions for special status are also displayed via the Spin Controller screen. As the Treadmill system will be upgraded and optimized regularly, some operations might be adjusted, and please refer to the actual Treadmill possessed when operate.

3. Standby and Wakeup

In the standby mode (all parameters are displayed as "0"), if the Spin Controller is long pressed for 3 seconds or the Treadmill is kept idle for 5 minutes, the Treadmill will be switched to standby status, and the panel lights will be off. In the standby mode, short press the Spin Controller to wake up the Treadmill.

4. Fault codes 

- E01: Software overcurrent
- E02: Hardware overcurrent
- E03: IPM module overheating
- E04: Undervoltage protection
- E05: Overvoltage protection
- E06: Motor open-phase protection
- E07: Motor lock-rotor protection
- E08: Sensor fault
- E09: Motor failure to start
- E12: Motor overcurrent protection
- E13: Overload protection
- E14: Hall signal loss
- E15: Communication error

Various patents relating to the KingSmith WalkingPad Treadmill series are developed and copyrighted by Beijing KingSmith Technology Co., Ltd. ("KingSmith" for short). Without the written permission of KingSmith, any organization or individual shall not copy or distribute all or any part of this User Manual and shall not use the patents contained thereof. This User Manual, as far as possible, has included various latest function introductions and operational instructions at the time of being printed. Nevertheless, there might be discrepancies between the purchased Treadmill and those described herein due to a continuous optimization in functions and designs. Therefore, the actual Treadmill shall prevail in case of any deviations in color and appearance.

1.6 Safety Precautions

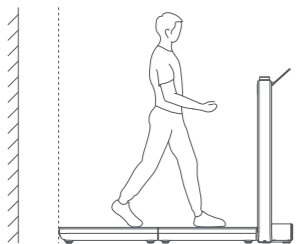

⚠ Please hold the handrail with both hands to support the body before jumping off the treadmill in an emergency. Therefore, there should be a distance of at least 2,000mm or above behind the Treadmill.

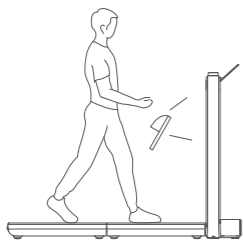

⚠ Please put on sports shoes and clothes when using the Treadmill, and conduct proper exercise according to one's health condition. If feeling uncomfortable in the exercise process, please stop immediately and consult a doctor to avoid the possible risk of injury.

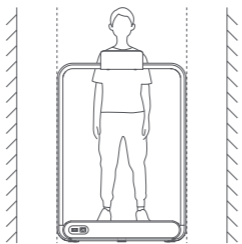

⚠ The distance between the Treadmill and other objects on the two sides should be at least 500mm.

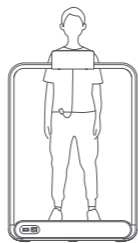

⚠ Before using the Treadmill, please nip the other end of the safety key to clothes. In case of any emergency, pull off the safety key to stop the Treadmill immediately.

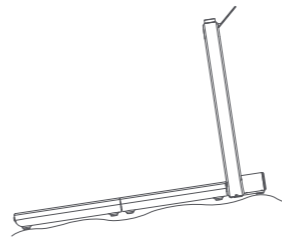

⊗ Strictly prohibit using the Treadmill on any uneven ground.

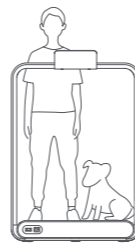

⊗ Do not use the Treadmill in the company of any pets.



⚠ Unplug the power cord when the Treadmill is not used.

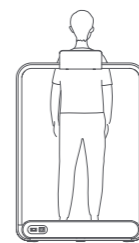

⊗ Do not use the Treadmill backward or sideways.



⊗ Do not step on the head of the Treadmill.



⚠ The elderly, children and pregnant women should use this product prudently.

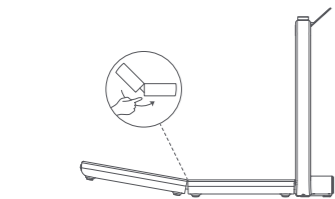

⚠ Keep hands safe.

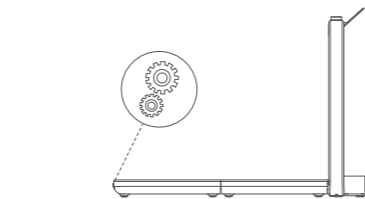

⚠ Keep belongings well in case of getting stuck.

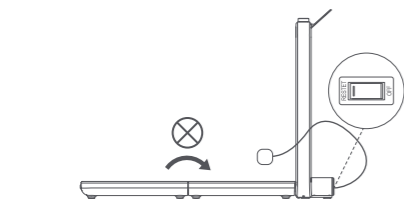

⊗ Do not fold the Treadmill when the power is not turned off.

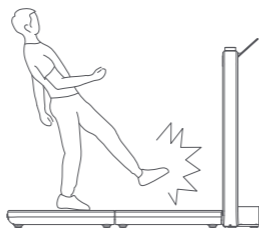

⊗ Do not get on or off the Treadmill when the running belt is still working.

1.7 Care and Maintenance

1. Treadmill cleaning



- Turn off the Treadmill and unplug the power cord.
- Apply an appropriate amount of soft detergent to a piece of cloth entirely made of cotton. Do not spray the detergent directly on the running belt or use any acid or corrosive detergent to avoid damage.
- Do not wipe beneath the running belt.
- As a regular practice, clean the dust and stains that might appear on the ground behind the Treadmill tail

2. Running belt slippage and correction

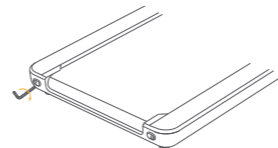

- Running belt inclination towards left: rotate the left adjustment screw for a 1/4 circle clockwise.
- Running belt inclination towards right: rotate the right adjustment screw for a 1/4 circle clockwise.
- Running belt slippage: rotate the left and right adjusting screws for a 1/2 circle clockwise, respectively.
- After regulating each time, let the Treadmill run at a speed of 3-4km/h for 1-2 minutes to observe the correction. If necessary, please adjust again.

3. Running belt lubrication

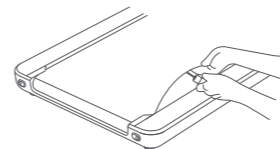

- Turn off the Treadmill and unplug the power cord.
- Uplift the edge of the running belt, and apply silicone oil to its inner surface. It is easier to operate when the treadmill is not fully unfolded.
- Start the Treadmill and let it run at 3km/h for 10-20 seconds before use.
- Apply 5-10ml of silicone oil for lubrication each time to avoid any negative impacts caused by the excessive use of silicone oil.
- Lubricate the running belt every three months.

1.8 Replacement and Disposal



The battery contained in this appliance must be removed for disposal.

When replacing the battery, use only original battery, available from our online parts shop.

The battery compartment is located on the back of the appliance. Open the compartment by removing the screw in the cover using a suitable screwdriver, and then press the lower end of the locking catch on the connectors. In that way, both sides of the connection can be separated by pulling them apart.

When inserting a new battery, push together the two connectors and ensure that the catch locks over the stop.

Never dispose of old battery in domestic garbage, but only through the proper public collection points. This also applies to the battery of defective appliances.



Devices marked with this symbol must be disposed of separately from your household waste, as they contain valuable materials that can be recycled. Proper disposal protects the environment and human health. Your local authority or retailer can provide information on the matter.

Contenu

2.1 Produit et Accessoires	22
2.2 Schéma Fonctionnel	23
2.3 Guide pour la Première Utilisation	27
2.4 Mode d'Emploi	29
2.5 Marque Déposée et Mention Légale	32
2.6 Précautions de Sécurité	33
2.7 Entretien et Maintenance	36
2.8 Recyclage et Mise au rebut	37

Bienvenue!

Merci d'avoir choisi le Tapis de course KingSmith WalkingPad, et ci-après dénommé « Le Tapis de course ». Un design exquis, simple et innovant permet aux utilisateurs de profiter d'un entraînement de qualité et agréable à la maison. Le Tapis de course est conçu pour un usage familial uniquement et ne doit pas être utilisé à des fins commerciales, de location ou d'organisation publique.

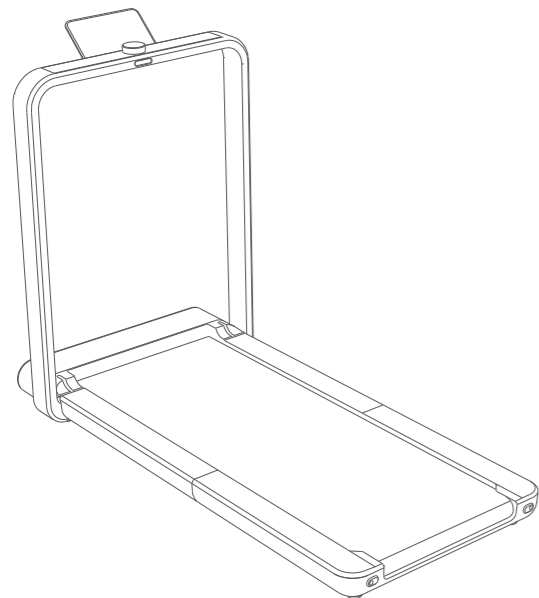

Indice de performance	Paramètres détaillés
Âge applicable	14-60 ans
Plage de vitesse	1-12 km/h
Aire de course	460×1210 mm
Charge maximale	110 kg
Fréquence	50/60 Hz
Tension	220-240 V~
Puissance	918 W
Poids net	38 kg
Dimensions dépliées	1419×711×1053 mm
Dimensions pliées	1007×711×225 mm

2.1 Produit et Accessoires

Il est important de vérifier soigneusement si les articles contenus dans la boîte d'emballage sont complets et intacts, et contacter le revendeur en cas de manquant ou de casse.

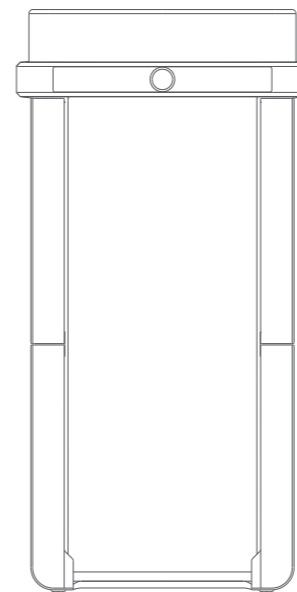

Tapis de course

Accessoires



Cordon d'alimentation



Support de téléphone portable



Clé de sécurité



Clé



Huile de silicone

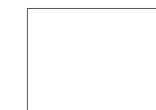

Manuel d' Utilisation

2.2 Schéma Fonctionnel

1. État déplié

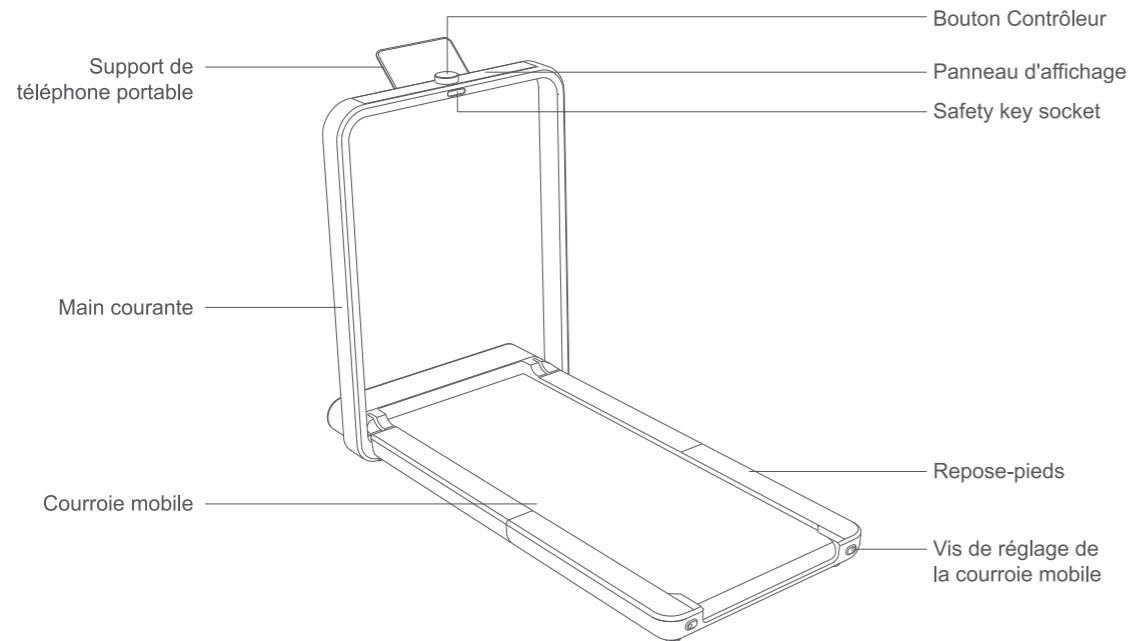

2. État plié

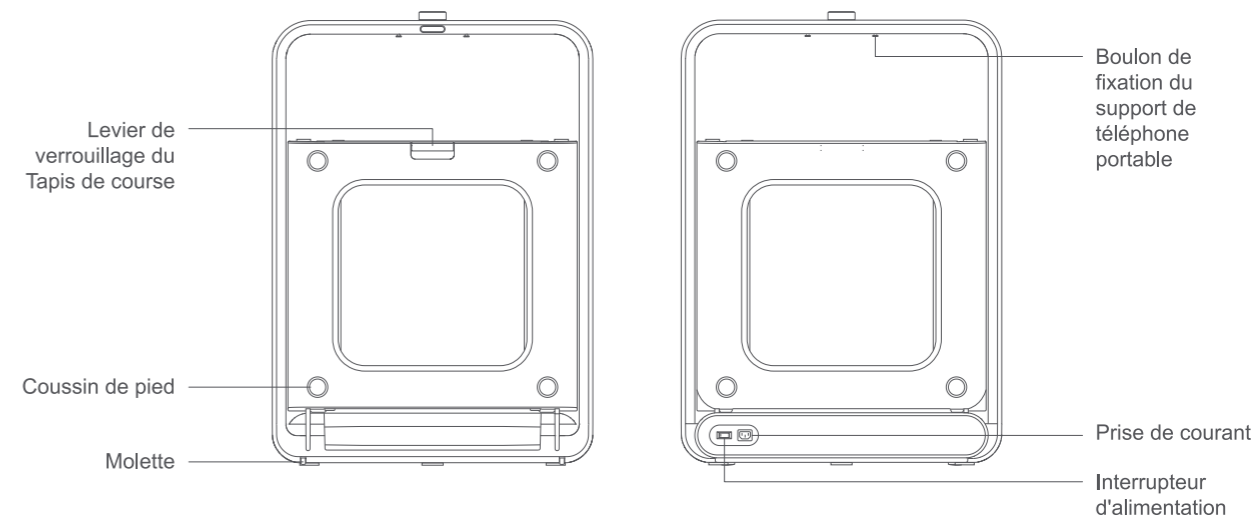

3. Fonctions du panneau d'affichage

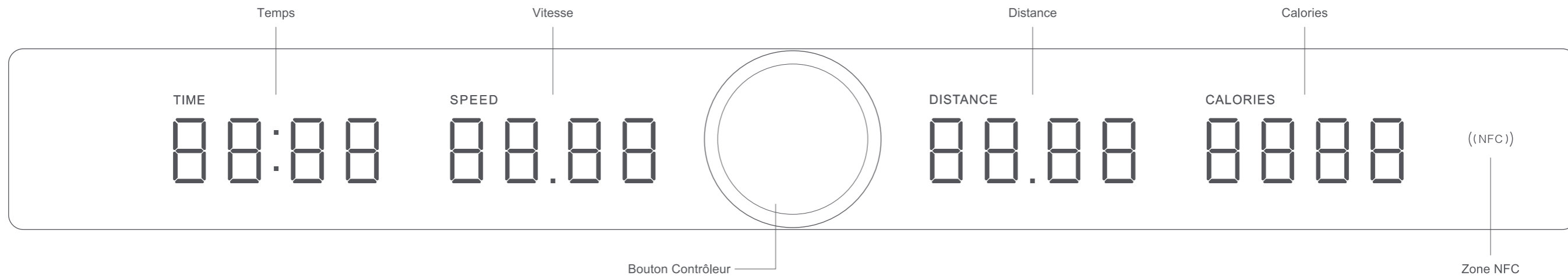

2.3 Guide pour la Première Utilisation

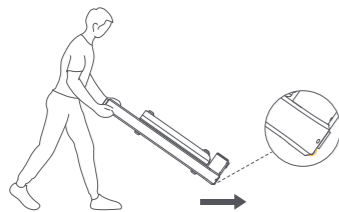

1. Avant de pousser ou de tirer le Tapis de course, il faut s'assurer que le Tapis de course est verrouillé et placé sur un sol plat.

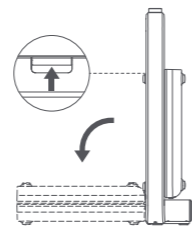

2. Tirer le levier de verrouillage du Tapis de course vers le haut pour le déverrouiller et maintenir-le lentement à plat.

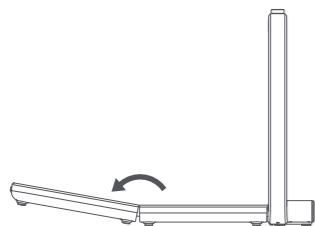

3. Déplier le Tapis de course, ajuster la courroie mobile en position centrale, déplier-la lentement et appuyer sur la courroie mobile pour le rendre complètement plat, ou faire pivoter le coussin de pied inférieur pour la mise à niveau.

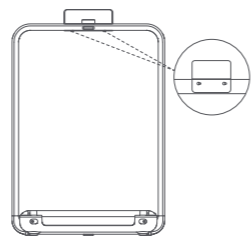

4. Sortir le support de téléphone portable de la boîte d'accessoires, connecter deux gros trous aux boulons de fixation sous la main courante, puis pousser vers la direction des extrémités étroites des trous, fixant ainsi le support de téléphone portable à la main courante.

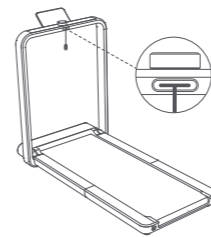

5. Sortir la clé de sécurité de la boîte d'accessoires et enclencher-la dans la prise de la clé de sécurité au milieu de la main courante.

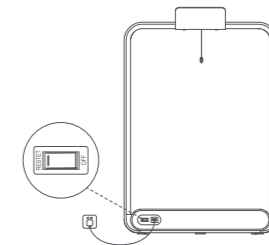

6. Allumer l'interrupteur du Tapis de course après avoir branché le cordon d'alimentation.



7. Scanner le code QR ci-dessus ou rechercher « KS Fit » dans l'App Store ou Google Play pour l'installation et l'inscription.

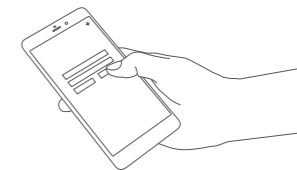

8. Ouvrir l'APP, suivre les instructions pour ajouter et lier le Tapis de course pour commencer l'utilisation.

2.4 Mode d'Emploi

1. Commencer à courir



1. Après la mise sous tension du Tapis de course, le panneau d'affichage s'allumera et tous les paramètres seront affichés comme « 0 » par défaut.

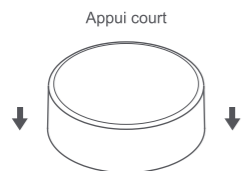

3. Après avoir appuyé brièvement sur le Bouton Contrôleur dans le mode par défaut, le Tapis de course démarrera lentement après un compte à rebours de 3 secondes.

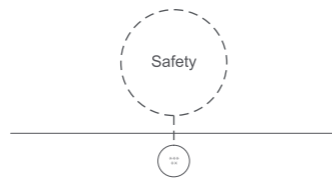

2. Si la clé de sécurité n'est pas enclenchée, une invite de « Safety » s'affichera et le mode « sécurité » sera activé. En cas de défaut de démarrage normal du Tapis de course, enclencher la clé de sécurité .

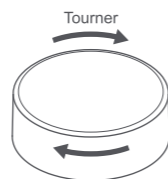

4. Tourner le Bouton Contrôleur dans le sens des aiguilles d'une montre pour accélérer. Tourner le Bouton Contrôleur dans le sens inverse des aiguilles d'une montre pour ralentir.

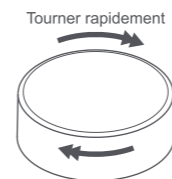

5. Régulation rapide de la vitesse : faire tourner rapidement le Bouton Contrôleur pour changer les niveaux de vitesse, qui seront commutés entre 1km/h, 3km/h, 6km/h, 9km/h et 12km/h.

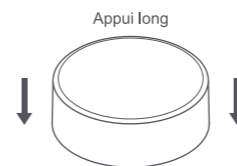

7. En mode pause, après avoir appuyé longuement sur le Bouton Contrôleur pendant 2 secondes ou s'il n'y a pas eu d'opération pendant 180 secondes, le Tapis de course s'arrêtera et tous les paramètres reviendront à « 0 » par défaut.

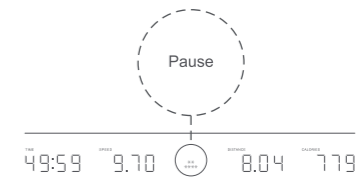

6. Après avoir appuyé brièvement sur le Bouton Contrôleur pendant le mouvement, ou après que l'opération à vide ait duré 5 minutes, le Tapis de course s'arrêtera lentement et entrera en état de pause. Ensuite, appuyer à nouveau brièvement sur le Bouton Contrôleur pour redémarrer le Tapis de course, qui reviendra au niveau de vitesse d'origine avant la pause.



8. Après avoir terminé l'exercice, éteindre l'interrupteur d'alimentation et ranger le cordon d'alimentation.

2. Autres états affichés sur l'écran du Bouton Contrôleur



Les instructions relatives aux états spéciaux sont également affichées via l'écran du Bouton Contrôleur. Le système du Tapis de course sera mis à niveau et optimisé régulièrement, certaines opérations peuvent être ajustées, et il est essentiel de référer au Tapis de course réel possédé lors de son utilisation.

3. Veille et Réveil

En mode veille (tous les paramètres sont affichés comme « 0 »), si le Bouton Contrôleur est appuyé longuement pendant 3 secondes ou si le Tapis de course est inactif pendant 5 minutes, le Tapis de course passera en mode veille et les voyants du panneau seront éteints. En mode veille, on peut appuyer brièvement sur le Bouton Contrôleur pour réveiller le Tapis de course.

2.5 Marque Déposée et Mention Légale

4. Codes d'erreur ¶

- E01: Surintensité logicielle
- E02: Surintensité matérielle
- E03: Surchauffe du module IPM
- E04: Protection contre les sous-tensions
- E05: Protection contre les surtensions
- E06: Protection de phase ouverte du moteur
- E07: Protection contre rotor bloqué du moteur
- E08: Défaut du capteur
- E09: Échec du démarrage du moteur
- E12: Protection contre les surintensités du moteur
- E13: Protection contre les surcharges
- E14: Perte du signal Hall
- E15: Défaut de communication

Les brevets relatifs à la série de Tapis de course KingSmith WalkingPad sont développés par Beijing KingSmith Technology Co., Ltd. (« KingSmith » en abrégé), qui en détient les droits d'auteur. Sans l'autorisation écrite de KingSmith, aucune organisation ou personne ne doit reproduire ou distribuer tout ou partie de ce Manuel d'Utilisation, et ne peut utiliser les brevets contenus dans celui-ci. Ce manuel, dans la mesure du possible, a inclus diverses introductions de fonctions et instructions opérationnelles les plus récentes au moment de l'impression. Cependant, en raison d'une optimisation continue des fonctions et des conceptions, il pourrait y avoir des écarts entre le Tapis de course acheté et ceux décrits ici. En cas d'incohérence entre le manuel et le produit réel en matière de couleur et d'apparence, le Tapis de course réel prévaut.

2.6 Précautions de Sécurité

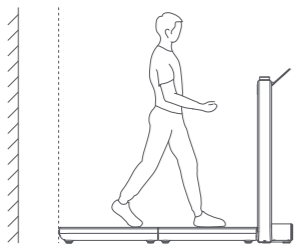

⚠ On peut tenir la main courante avec les deux mains pour soutenir le corps avant de sauter du Tapis de course en cas d'urgence. Par conséquent, il doit y avoir une distance de 2 000 mm ou plus derrière le Tapis de course.

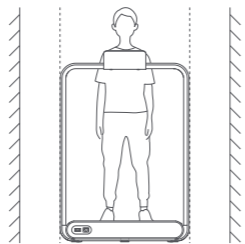

⚠ La distance entre le Tapis de course et les autres objets des deux côtés doit être d'au moins 500 mm.

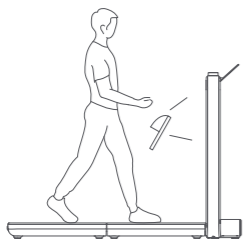

⚠ Il est important de mettre des chaussures et vêtements de sport lors de l'utilisation du Tapis de course et effectuer des exercices appropriés en fonction de l'état de santé de chacun. En cas d'inconfort physique pendant l'exercice, arrêter immédiatement et consulter un médecin pour éviter tout risque de blessure.

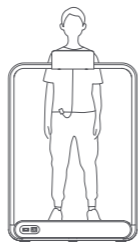

⚠ Avant d'utiliser le Tapis de course, il est recommandé de pincer l'autre extrémité de la clé de sécurité aux vêtements. En cas d'urgence, retirer la clé de sécurité pour arrêter immédiatement le Tapis de course.

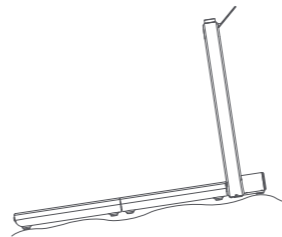

⊗ Il est strictement interdit d'utiliser le Tapis de course sur un terrain inégal.

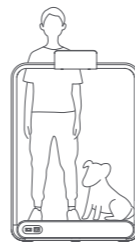

⊗ Ne pas utiliser le Tapis de course en compagnie d'animaux domestiques.



⚠ Débrancher le cordon d'alimentation lorsque le Tapis de course n'est pas utilisé.

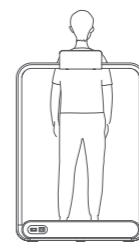

⊗ Ne pas utiliser le Tapis de course à l'envers ou sur le côté.



⊗ Ne pas marcher sur la tête du Tapis de course.



⚠ Les personnes âgées, les enfants et les femmes enceintes doivent utiliser le Tapis de course avec prudence.

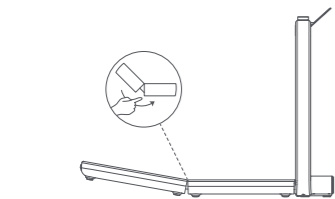

⚠ Garder les mains en sécurité.

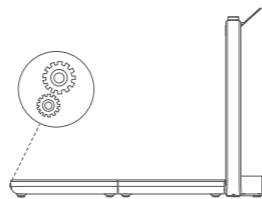

⚠ Garder bien les effets personnels pour éviter le coincement.

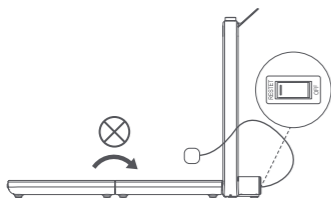

⊗ Ne pas plier le Tapis de course avant qu'il ne soit éteint.

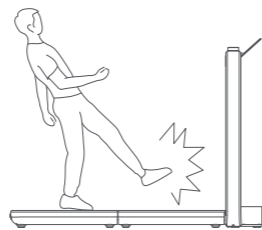

⊗ Ne pas monter ou descendre du Tapis de course lorsque la courroie mobile fonctionne encore.

2.7 Entretien et Maintenance

1. Nettoyage du Tapis de course



- Eteindre le Tapis de course et débrancher le cordon d'alimentation.
- Appliquer une quantité appropriée de détergent doux au chiffon 100% coton. Ne pas vaporiser le détergent directement sur la courroie mobile et ne pas utiliser de détergent acide ou corrosif pour éviter tout dommage.
- Ne pas essuyer sous la courroie mobile.
- En tant que pratique régulière, nettoyer la poussière et les taches qui pourraient apparaître sur le sol derrière la queue du Tapis de course.

2. Dérapage et correction de la courroie mobile

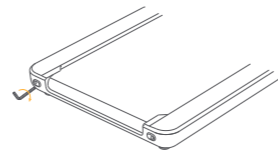

- Inclinaison de la courroie mobile vers la gauche : tourner la vis de réglage gauche dans le sens des aiguilles d'une montre d'un 1/4 de cercle.
- Inclinaison de la courroie mobile vers la droite : tourner la vis de réglage droite dans le sens des aiguilles d'une montre d'un 1/4 de cercle.
- Dérapage de la courroie mobile : tourner les vis de réglage gauche et droite respectivement dans le sens des aiguilles d'une montre d'un 1/2 cercle.
- Après chaque réglage, laisser le Tapis de course fonctionner à une vitesse de 3 à 4 km/h pendant 1 à 2 minutes pour observer la correction. Ajuster à nouveau si nécessaire.

3. Lubrification de la courroie mobile

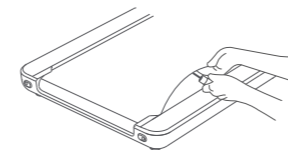

- Éteindre le Tapis de course et débrancher le cordon d'alimentation.
- Soulever la bordure de la courroie mobile et appliquer de l'huile de silicone sur sa surface intérieure. Il est plus facile à manoeuvrer lorsque le Tapis de course n'est pas complètement déplié.
- Démarrer le Tapis de course et le laisser fonctionner à une vitesse de 3 km/h pendant 10 à 20 secondes avant de l'utiliser.
- Il faut environ 5-10 ml d'huile de silicone pour chaque cycle de lubrification, l'utilisation excessive de silicone peut causer des dérapages et affecter le bon fonctionnement.
- Lubrifier la courroie mobile une fois tous les trois mois.

2.8 Recyclage et Mise au rebut



La batterie contenue dans ce Tapis de course doit être retirée pour être mise au rebut.

Lors du remplacement de la batterie, utiliser uniquement une batterie OEM disponible dans notre boutique de pièces en ligne.

Le compartiment à piles est situé à l'arrière du Tapis de course. Ouvrir le compartiment en retirant la vis sur le couvercle avec un tournevis approprié, puis appuyer sur l'extrémité inférieure du loquet de verrouillage sur les connecteurs.

Lors de l'insertion d'une nouvelle batterie, pousser ensemble les deux connecteurs et s'assurer que le loquet se verrouille sur la butée.

Ne pas jeter les piles usagées dans le système d'ordures ménagères et s'assurer qu'elles sont correctement recyclées dans les points de collecte publics. Ceci s'applique également à la batterie des Tapis de course défectueux.



Les appareils marqués de ce symbole doivent être mis au rebut séparément des ordures ménagères, car ils contiennent des matériaux de valeur qui peuvent être recyclés. Une mise au rebut appropriée profite à l'environnement et à la santé humaine. Il est conseillé de référer aux informations pertinentes fournies par l'autorité locale ou le revendeur.

Inhalt

3.1 Produkt und Zubehör	40
3.2 Funktionsschema	41
3.3 Gebrauchsanleitung für den ersten Gebrauch	45
3.4 Betriebsanweisungen	47
3.5 Marken- und Rechtserklärung	50
3.6 Sicherheitsvorkehrungen	51
3.7 Pflege und Wartung	54
3.8 Recycling und Entsorgung	55

Willkommen!

Vielen Dank, dass Sie sich für das KingSmith WalkingPad Laufband (im Folgenden als „das Laufband“ bezeichnet) entschieden haben, das ein einfaches, exquisites und innovatives Design bietet. Benutzer des Laufbands können ein Workout zu Hause genießen und die Lebensqualität steigern. Das Laufband ist nur für den privaten Gebrauch bestimmt, nicht für geschäftliche, Leasing- oder öffentliche Organisationszwecke.

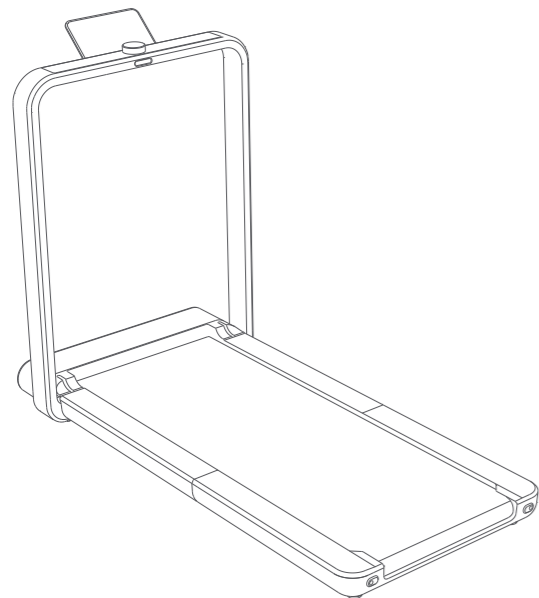

Leistungsindex	Detaillierte Parameter
Geeignete Altersgruppe	14-60 Jahre
Drehzahlbereich	1-12 km/h
Laufbereich	460×1210 mm
Maximale Belastung	110 kg
Frequenz	50/60 Hz
Spannung	220-240 V~
Leistung	918 W
Nettogewicht	38 kg
Aufklappmaß	1419×711×1053 mm
Faltmaß	1007×711×225 mm

3.1 Produkt und Zubehör

Bitte überprüfen Sie sorgfältig, ob die in der Verpackung enthaltenen Artikel vollständig und intakt sind, und kontaktieren Sie den Händler, wenn Sie feststellen, dass Artikel fehlen oder beschädigt sind.

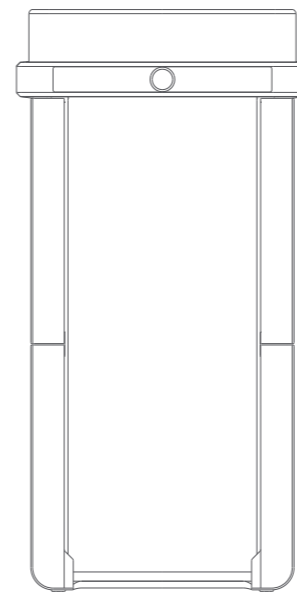

Laufband

Zubehör



Netzkabel



Handyhalter



Sicherheitsschlüssel



Schraubenschlüssel



Silikonöl



Benutzerhandbuch

3.2 Funktionsschema

1. Aufklappzustand

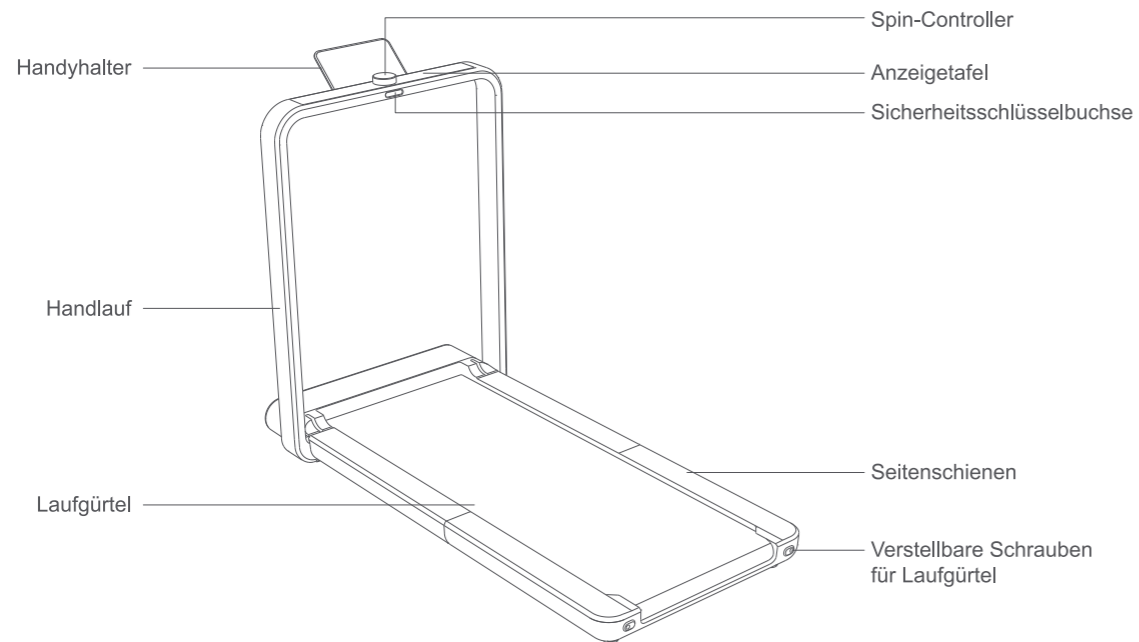

2. Faltzustand

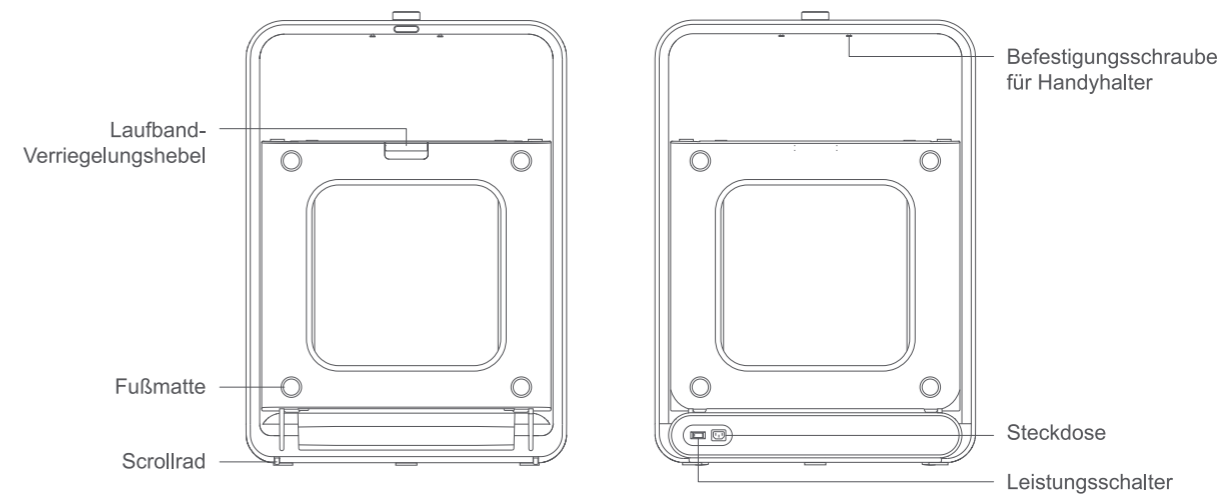

3. Funktionen der Anzeigetafel

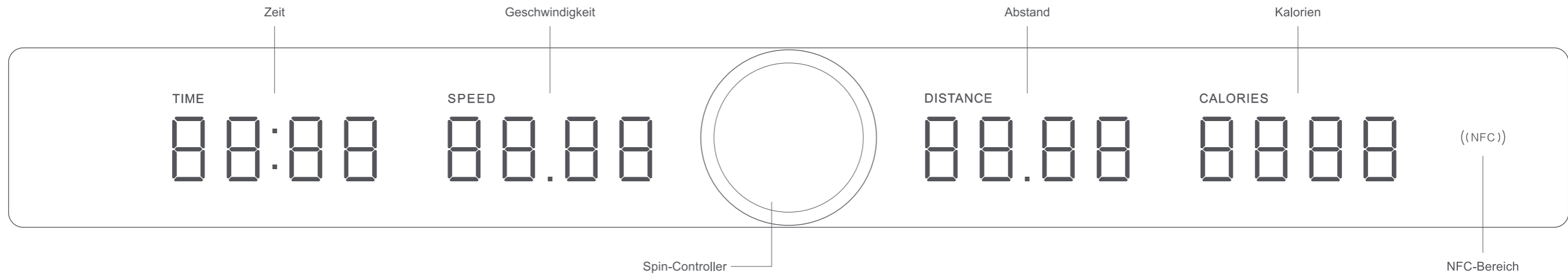

3.3 Gebrauchsanleitung für den ersten Gebrauch

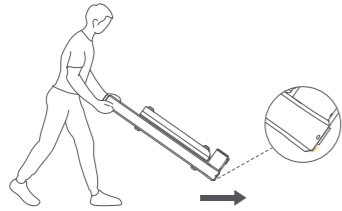

1. Bevor Sie das Laufband schieben oder ziehen, vergewissern Sie sich bitte, dass das Laufband verriegelt und auf ebenem Boden platziert ist.

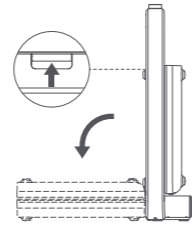

2. Ziehen Sie den Laufband-Verriegelungshebel nach oben, um das Laufband zu entriegeln und langsam flach zu halten.

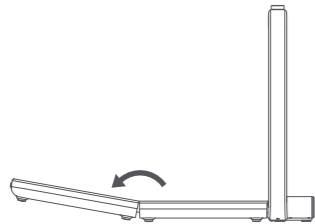

3. Klappen Sie das Laufband aus, stellen Sie das Laufband in die mittlere Position ein, falten Sie es langsam aus und drücken Sie das Laufband oder drehen Sie das untere Fußpolster, um es vollständig flach zu machen.

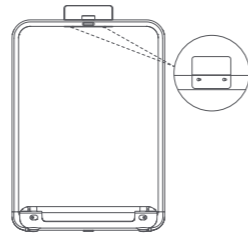

4. Nehmen Sie den Handyhalter aus der Zubehörbox, verbinden Sie zwei große Löcher mit den Befestigungsschrauben unter dem Handlauf und drücken Sie dann in Richtung der schmalen Enden der Löcher, wodurch der Handyhalter an dem Handlauf befestigt wird.

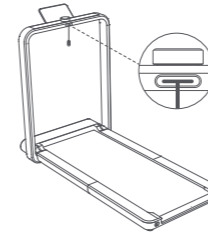

5. Nehmen Sie den Sicherheitsschlüssel aus der Zubehörbox und stecken Sie ihn in die Sicherheitsschlüsselbuchse in der Mitte des Handlaufs.

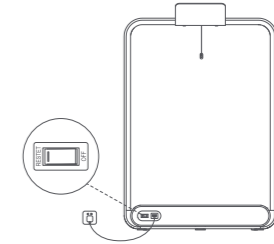

6. Schalten Sie den Laufbandschalter nach dem Anschließen des Netzkabels ein.



7. Scannen Sie den QR-Code oben oder suchen Sie im App Store oder bei Google Play nach "KS Fit", um die Installation und Anmeldung abzuschließen.

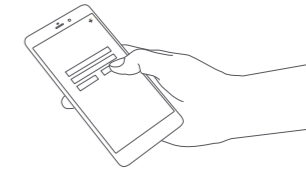

8. Bevor Sie das Laufband verwenden, öffnen Sie die APP, fügen Sie das Laufband hinzu und binden Sie es nach den Anweisungen.

3.4 Betriebsanweisungen

1. Starten Sie den Betrieb



1. Nach dem Einschalten des Laufbands leuchtet das Anzeigetafel auf und alle Parameter werden standardmäßig als „0“ angezeigt.



3. Nachdem der Spin-Controller im Standardmodus 3 Sekunden kurz gedrückt wurde, wird das Laufband langsam gestartet.

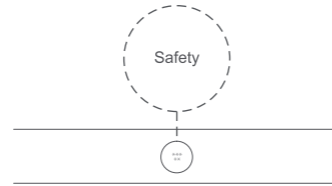

2. Wenn der Sicherheitsschlüssel nicht eingesteckt ist, wird eine Eingabeaufforderung "Safety" angezeigt und der Modus "Sicher" aktiviert. Wenn Sie das Laufband nicht starten können, stecken Sie bitte den Sicherheitsschlüssel ein.

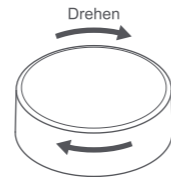

4. Drehen Sie den Spin-Controller im Uhrzeigersinn, um zu beschleunigen. Drehen Sie den Spin-Controller gegen den Uhrzeigersinn, um zu verzögern.

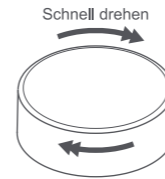

5. Schnelle Geschwindigkeitsregelung: Drehen Sie den Spin Controller schnell, um die Geschwindigkeitsstufen umzuschalten, die zwischen 1 km/h, 3 km/h, 6 km/h, 9 km/h und 12 km/h umgeschaltet werden.

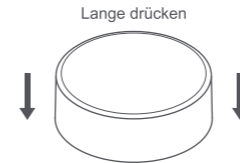

7. Im Pause-Modus, nachdem der Spin-Controller 2 Sekunden lang gedrückt wurde oder 180 Sekunden lang keine Bedienung erfolgt, stoppt das Laufband und alle Parameter kehren standardmäßig auf „0“ zurück.

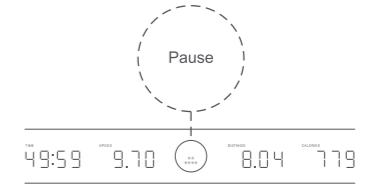

6. Nachdem der Spin-Controller während der Bewegung kurz gedrückt wird oder nachdem der Leerlaufbetrieb 5 Minuten andauert, stoppt das Laufband langsam und geht in den Pausenzustand über. Drücken Sie dann erneut kurz auf den Spin-Controller, um das Laufband neu zu starten, das auf das ursprüngliche Geschwindigkeitsniveau vor der Pause zurückkehrt.



8. Schalten Sie nach der Übung das Laufband aus und stellen Sie das Netzkabel zurück.

2. Andere Status, die auf dem Bildschirm des Spin-Controllers angezeigt werden

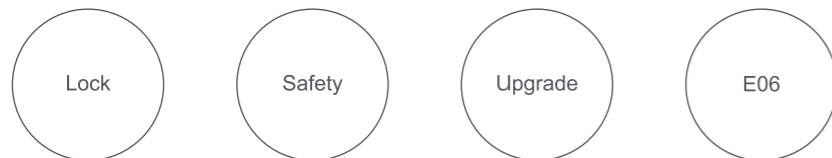

Anweisungen für den Sonderstatus werden auch über den Bildschirm des Spin-Controllers angezeigt. Da das Laufbandsystem regelmäßig aktualisiert und optimiert wird, können einige Vorgänge angepasst werden. Bitte beziehen Sie sich beim Betrieb auf das tatsächliche Laufband.

3. Standby und Wakeup

Wenn Sie im Standby- und Standard-Weckmodus (alle Parameter werden als „0“ „0“ angezeigt) den Spin-Controller 3 Sekunden lang gedrückt halten oder das Laufband 5 Minuten lang im Leerlauf halten, wird das Laufband in den Standby-Status geschaltet und die Kontrollleuchten sind ausgeschaltet. Drücken Sie im Standby-Modus kurz auf den Spin-Controller, um das Laufband aufzuwecken.

4. Fehlercodes

- E01: Software-Überstrom
- E02: Hardware-Überstrom
- E03: Überhitzung des IPM-Moduls
- E04: Unterspannungsschutz
- E05: Überspannungsschutz
- E06: Schutz des Motors bei offener Phase
- E07: Motorschloss-Rotorschutz
- E08: Sensorfehler
- E09: Motor läuft nicht an
- E12: Überspannungsschutz für Motoren
- E13: Überlastschutz
- E14: Verlust des Hallsignals
- E15: Kommunikationsfehler

Verschiedene Patente im Zusammenhang mit der KingSmith WalkingPad Laufband-Serie werden von Beijing KingSmith Technology Co., Ltd. (kurz "KingSmith") entwickelt und urheberrechtlich geschützt. Ohne die schriftliche Genehmigung von KingSmith darf keine Organisation oder Person dieses Benutzerhandbuch ganz oder teilweise kopieren oder verbreiten und die darin enthaltenen Patente nicht verwenden. Dieses Benutzerhandbuch enthält, soweit möglich, verschiedene neueste Funktionseinführungen und Bedienungsanleitungen zum Zeitpunkt des Drucks. Dennoch kann es aufgrund einer kontinuierlichen Optimierung der Funktionen und Designs zu Abweichungen zwischen dem gekauften Laufband und den hier beschriebenen Laufbändern kommen. Daher hat das eigentliche Laufband bei Abweichungen in Farbe und Aussehen Vorrang.

3.6 Sicherheitsvorkehrungen

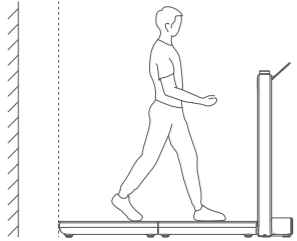

⚠ Bitte halten Sie den Handlauf mit beiden Händen, um den Körper zu stützen, bevor Sie im Notfall vom Laufband springen. Daher sollte sich hinter dem Laufband ein Abstand von mindestens 2.000 mm oder mehr befinden.

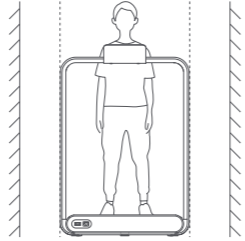

⚠ Der Abstand zwischen dem Laufband und anderen Objekten auf beiden Seiten sollte mindestens 500 mm betragen.

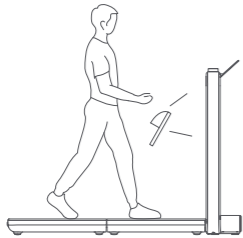

⚠ Bitte ziehen Sie Sportschuhe und -kleidung an, wenn Sie das Laufband benutzen, und führen Sie die richtige Übung entsprechend dem Gesundheitszustand durch. Wenn Sie sich während des Trainings unwohl fühlen, brechen Sie bitte sofort ab und konsultieren Sie einen Arzt, um das mögliche Verletzungsrisiko zu vermeiden.

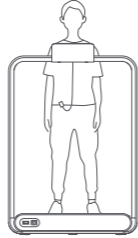

⚠ Bevor Sie das Laufband verwenden, klemmen Sie bitte das andere Ende des Sicherheitsschlüssels an der Kleidung ein. Ziehen Sie im Notfall den Sicherheitsschlüssel ab, um das Laufband sofort zu stoppen.

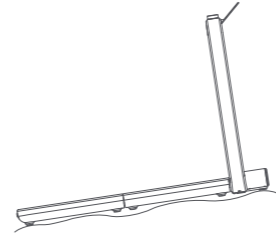

⊗ Verwenden Sie das Laufband nicht auf unebenem Untergrund.



⊗ Verwenden Sie das Laufband nicht in Begleitung von Haustieren.



⚠ Ziehen Sie den Netzstecker, wenn das Laufband nicht verwendet wird.

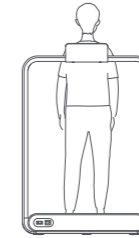

⊗ Verwenden Sie das Laufband nicht rückwärts oder seitlich.



⊗ Verwenden Sie das Laufband nicht auf unebenem Untergrund.



⚠ Ältere Menschen, Kinder und schwangere Frauen sollten das Laufband umsichtig verwenden.

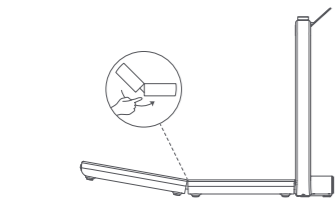

Halten Sie die Hände in Sicherheit.

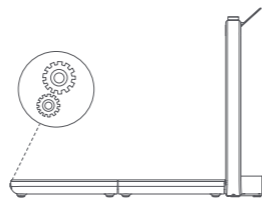

Bewahren Sie Ihre Sachen gut auf, falls sie hängen bleiben.

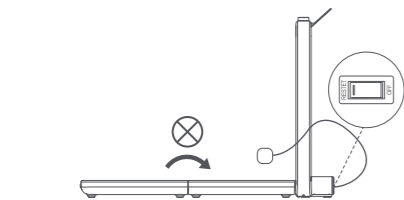

Falten Sie dieses Produkt nicht, bevor das Laufband nicht ausgeschaltet ist.

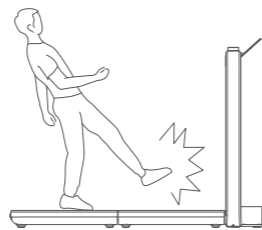

Steigen Sie nicht auf oder von dem Laufband, wenn das Laufband noch funktioniert.

3.7 Pflege und Wartung

1. Reinigung des Laufbands



- Schalten Sie das Laufband aus und ziehen Sie den Netzstecker.
- Tragen Sie eine angemessene Menge eines weichen Reinigungsmittels auf ein Tuch auf, das vollständig aus Baumwolle besteht. Sprühen Sie das Reinigungsmittel nicht direkt auf das Laufband oder verwenden Sie kein saures oder ätzendes Reinigungsmittel, um Schäden zu vermeiden.
- Wischen Sie nicht unter dem Laufband ab.
- Reinigen Sie regelmäßig den Staub und Flecken, die auf dem Boden hinter dem Laufband erschienen könnten.

2. Schlupf und Korrektur des Laufgürtels

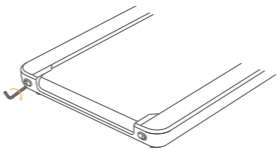

- Laufbandneigung nach links: Drehen Sie die linke Einstellschraube für einen 1/4-Kreis im Uhrzeigersinn.
- Laufbandneigung nach rechts: Drehen Sie die rechte Einstellschraube für einen 1/4-Kreis im Uhrzeigersinn.
- Schlupf des Laufgürtels: Drehen Sie die linken und rechten Einstellschrauben jeweils für einen 1/2 Kreis im Uhrzeigersinn.
- Lassen Sie das Laufband nach jeder Regulierung 1-2 Minuten lang mit einer Geschwindigkeit von 3-4 km/h laufen, um die Korrektur zu beobachten. Falls erforderlich, bitte erneut anpassen.

3. Schmierung des Laufbandes

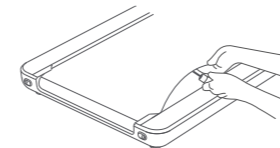

- Schalten Sie das Laufband aus und ziehen Sie den Netzstecker.
- Heben Sie den Rand des Laufgürtels an und tragen Sie Silikonöl auf seine Innenfläche auf. Es ist einfacher zu bedienen, wenn das Laufband nicht vollständig ausgeklappt ist.
- Starten Sie das Laufband und lassen Sie es vor dem Gebrauch 10-20 Sekunden lang mit 3 km/h laufen.
- Tragen Sie jedes Mal 5-10 ml Silikonöl zur Schmierung auf, um negative Auswirkungen zu vermeiden, die durch die übermäßige Verwendung von Silikonöl verursacht werden.
- Laufgürtel einmal alle drei Monate schmieren.

3.8 Recycling und Entsorgung



Der in diesem Laufband enthaltene Akku muss zur Entsorgung entfernt werden.

Verwenden Sie beim Austausch der Batterie nur einen OEM, der in unserem Online-Teile-Shop erhältlich ist.

Das Batteriefach befindet sich auf der Rückseite des Laufbands. Öffnen Sie das Fach, indem Sie die Schraube am Deckel mit einem geeigneten Schraubendreher entfernen und drücken Sie dann das untere Ende der Sperrklinke auf die Anschlüsse. Auf diese Weise können beide Seiten der Verbindung durch Auseinanderziehen getrennt werden. (Dieser Satz ist nicht richtig und muss möglicherweise später überarbeitet werden).

Schieben Sie beim Einlegen einer neuen Batterie die beiden Anschlüsse zusammen und achten Sie darauf, dass der Riegel über dem Anschlag einrastet.

Bitte entsorgen Sie Altbatterien nicht im Hausmüllsystem und stellen Sie sicher, dass sie über öffentliche Sammelstellen ordnungsgemäß recycelt werden. Dies gilt auch für die Batterie defekter Laufbänder.



Geräte, die mit diesem Symbol gekennzeichnet sind, müssen getrennt vom Hausmüll entsorgt werden, da sie wertvolle Materialien enthalten, die recycelt werden können. Eine ordnungsgemäße Entsorgung kommt der Umwelt und der menschlichen Gesundheit zugute. Bitte beachten Sie die einschlägigen Informationen der lokalen Behörde oder des Einzelhändlers.

Índice

4.1 Producto y Accesorios	58
4.2 Diagrama Funcional	59
4.3 Guía para el Primer Uso	63
4.4 Instrucciones de Operación	65
4.5 Marca y Declaración Legal	68
4.6 Precauciones de Seguridad	69
4.7 Cuidado y Mantenimiento	72
4.8 Reciclaje y Eliminación	73

Bienvenido!

Gracias por elegir la Caminadora KingSmith WalkingPad (en lo sucesivo, "la Caminadora"), que tiene un diseño simple, fino e innovador. Los usuarios de la Caminadora pueden disfrutar de una vida de calidad a través de ejercicio saludable en casa. Sin embargo, la Caminadora es sólo para uso doméstico, y no para fines comerciales, de arrendamiento u organizaciones públicas.

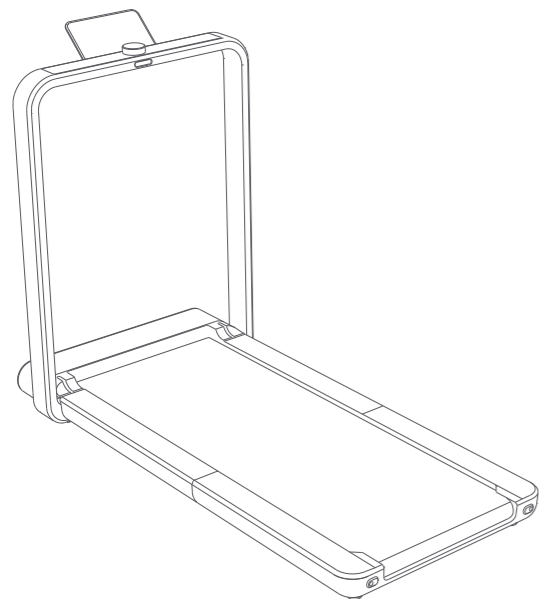

Índice de rendimiento	Parámetros detallados
Edad aplicable	14-60 años
Rango de velocidad	1-12 km/h
Área de carrera	460×1210 mm
Carga máxima	110 kg
Frecuencia	50/60 Hz
Voltaje	220-240 V~
Potencia	918 W
Peso neto	38 kg
Dimensión de despliegue	1419×711×1053 mm
Dimensión de plegado	1007×711×225 mm

4.1 Producto y Accesorios

Verifique cuidadosamente si los artículos que contiene la caja de embalaje están completos e intactos, y póngase en contacto con el minorista en caso de encontrar algún artículo faltante o dañado.

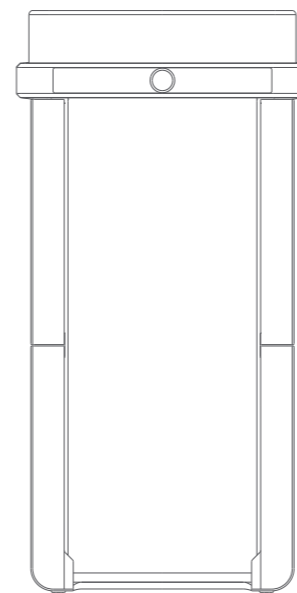

Caminadora

Accesorios



Cable de alimentación



Soporte para teléfono móvil



Llave de seguridad



Llave mecánica



Aceite de silicona



Manual de Usuario

4.2 Diagrama Funcional

1. Estado desplegado

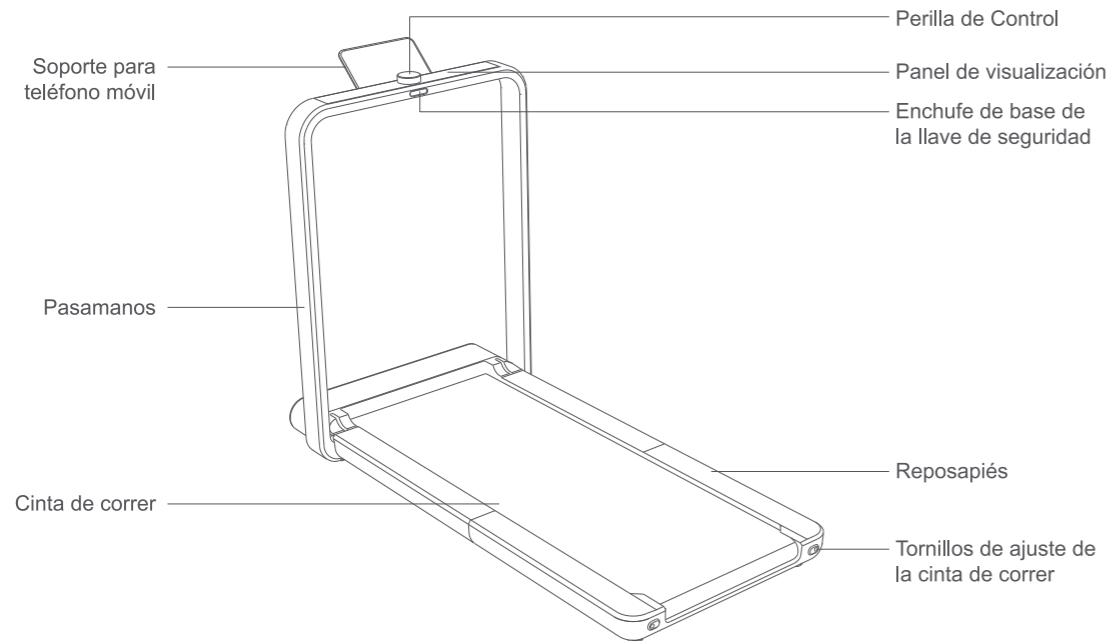

2. Estado de plegado

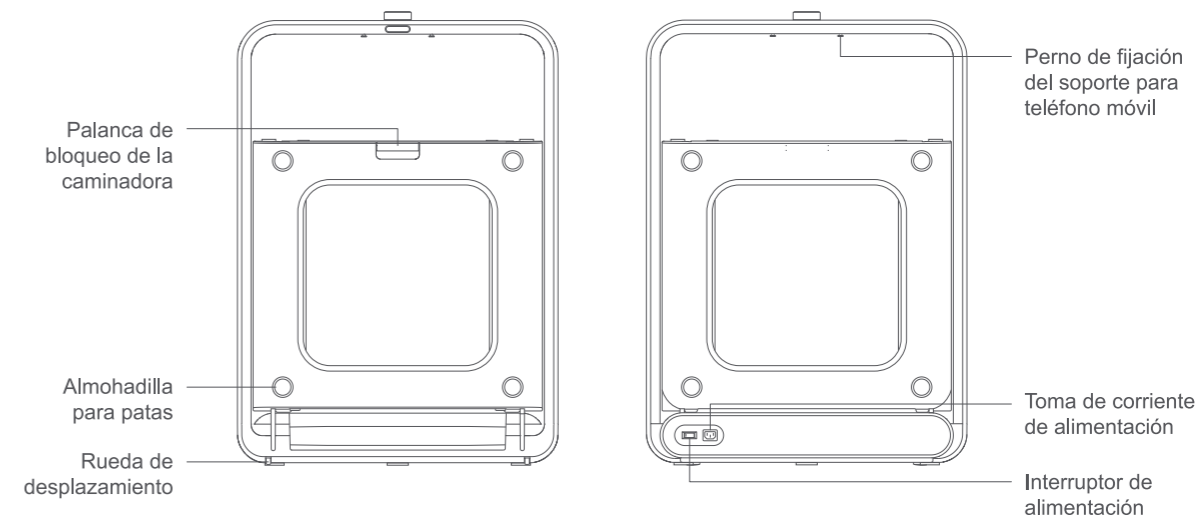

3. Funciones del panel de visualización

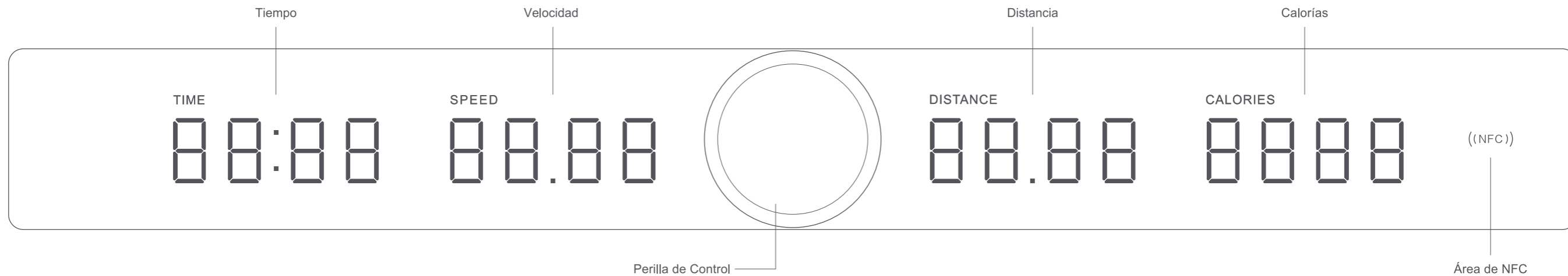

4.3 Guía para el Primer Uso

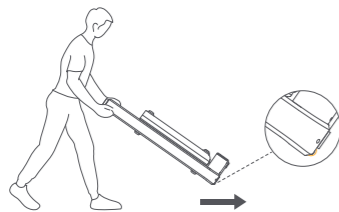

1. Antes de empujar o tirar de la Caminadora, asegúrese de que la Caminadora esté bloqueada y puesta en un suelo plano.

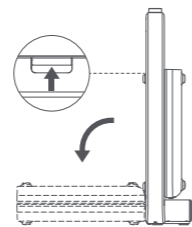

2. Tire hacia arriba de la palanca de bloqueo de la Caminadora para desbloquearla y déjela plana lentamente.

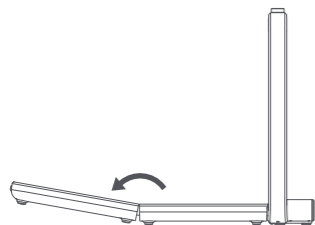

3. Despliegue la Caminadora, ajuste la cinta de correr a la posición central, despliegue lentamente y presione la caminadora, o gire la almohadilla para patas en la parte inferior para que quede completamente plana.

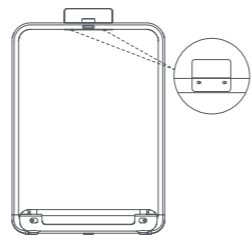

4. Saque el soporte para teléfono móvil de la caja de accesorios, conecte los dos orificios grandes a los pernos de fijación debajo del pasamanos, luego empuje hacia la dirección de los extremos estrechos de los orificios, fijando así el soporte para teléfono móvil en el pasamanos.

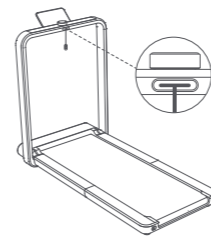

5. Saque la llave de seguridad de la caja de accesorios e insértela en el enchufe de base de la llave de seguridad en el medio del pasamanos.

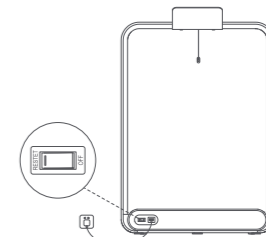

6. Conecte el cable de alimentación y después, encienda el interruptor de la Caminadora.



7. Escanee el código QR de arriba o busque "KS Fit" en la tienda de aplicaciones o Google Play para completar la instalación y registrarse.

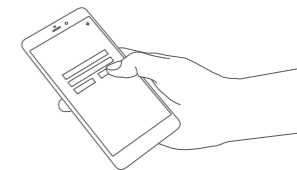

8. Abra la Tienda de APLICACIÓN, siga las instrucciones para agregar y vincular la caminadora para su uso.

4.4 Instrucciones de Operación

1. Empezar a correr



1. Luego de encender la Caminadora, el panel de visualización se iluminará y todos los parámetros se mostrarán como "0" de forma predeterminada.



3. Presione brevemente la perilla de control durante 3 segundos en el modo predeterminado y la caminadora se iniciará lentamente.

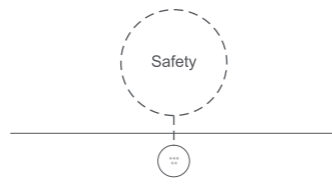

2. Si la llave de seguridad no está insertada, se mostrará el mensaje "Safety" y se activará el modo "Seguro". Si no se puede iniciar la Caminadora normalmente, inserte la llave de seguridad

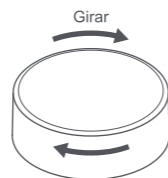

4. Gire la perilla de control en el sentido de las agujas del reloj para acelerar.
Gire la perilla de control en el sentido antihorario para desacelerar.

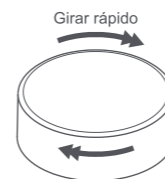

5. Ajuste de velocidad rápido: Gire la perilla de control rápidamente para cambiar los niveles de velocidad, que se cambiarán entre los niveles 1km/h, 3km/h, 6km/h, 9km/h y 12km/h.



7. En el modo de pausa, después de mantener presionado la perilla de control durante 2 segundos o mantener el estado sin operación durante 180 segundos, la caminadora se detendrá y todos los parámetros volverán a "0" por defecto.

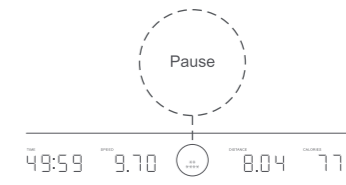

6. Después de presionar brevemente la perilla de control durante el movimiento, o después de dejarla funcionar sin carga durante 5 minutos, la caminadora se detendrá lentamente y entrará en el estado de pausa. Luego, presione brevemente la perilla de control nuevamente para reiniciar la máquina, que volverá al nivel de velocidad original antes de la pausa.



8. Después de terminar el ejercicio, apague el interruptor de encendido y guarde el cable de alimentación.

2. Otros estados mostrados en la Pantalla de la Perilla de Control



Las instrucciones para el estado especial también se muestran en la Pantalla de la Perilla de Control. Como el sistema de equipos de la Caminadora se actualizará y optimizará periódicamente. Generalmente, algunas operaciones pueden ajustarse y consulte la Caminadora real que posee cuando la utiliza.

3. Espera y Despertador

En el modo predeterminado (todos los parámetros se muestran como "0"), si se mantiene presionado la perilla de control durante 3 segundos o mantiene la cinta de correr inactiva durante 5 minutos, la cinta de correr cambiará al estado de espera y las luces del panel se apagarán. En el modo de espera, presione brevemente la perilla de control para activar la caminadora.

4.5 Marca y Declaración Legal

4. Códigos de avería

- E01: Sobrecorriente de software
- E02: Sobrecorriente de hardware
- E03: Sobrecalentamiento del módulo IPM
- E04: Protección contra subtensión
- E05: Protección contra sobretensión
- E06: Protección de fase abierta del motor
- E07: Protección contra bloqueo de rotor del motor
- E08: Avería del sensor
- E09: Fallo de arranque del motor
- E12: Protección contra sobrecorriente del motor
- E13: Protección contra sobrecarga
- E14: Pérdida de señal Hall
- E15: Error de comunicación

Beijing KingSmith Technology Co., Ltd. ("KingSmith" como abreviatura) ha desarrollado varias patentes relacionadas con la serie de caminadoras KingSmith WalkingPad. Ninguna organización o individuo no copiará ni distribuirá todo o parte de este Manual y sus patentes sin el permiso por escrito de KingSmith. Este manual de Usuario, en la medida de lo posible, ha incluido varias introducciones de funciones e instrucciones operativas más recientes en el momento de su impresión. Sin embargo, puede haber discrepancias entre la Caminadora comprada y las descritas en este documento debido a una optimización continua en las funciones y diseños. Por lo tanto, la Caminadora real prevalecerá en caso de cualquier desviación en el color y la apariencia.

4.6 Precauciones de Seguridad

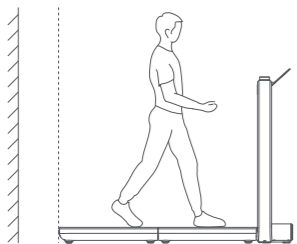

⚠️ Sujete el pasamanos con ambas manos para sostener el cuerpo antes de saltar de la caminadora en caso de emergencia. Por lo tanto, hay que haber una distancia de al menos 2000 mm o más detrás de la Caminadora.

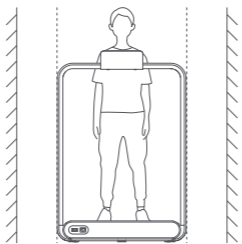

⚠️ La distancia entre la cinta de correr y otros objetos en ambos lados debe ser de al menos 500 mm.

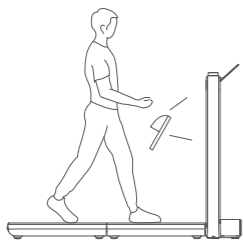

⚠️ Lleve ropa y calzado deportivos antes de hacer ejercicio adecuado según sus propias condiciones. Si se siente incómodo durante el proceso de ejercicio, deténgase de inmediato y consulte a su médico para evitar un posible riesgo de lesiones.

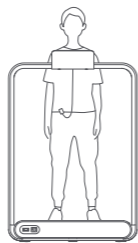

⚠️ Antes de usar la Caminadora, sujete el otro extremo de la llave de seguridad a su ropa. En caso de emergencia, quite la llave de seguridad.

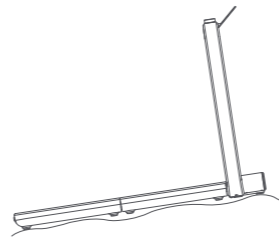

⊗ Está estrictamente prohibido el uso de la Caminadora en terrenos irregulares.

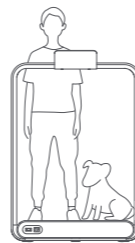

⊗ Está estrictamente prohibido usar la Caminadora en compañía de ninguna mascota.



⚠️ Desconecte el cable de alimentación cuando no utilice la caminadora.

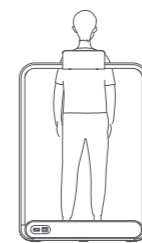

⊗ Está estrictamente prohibido usar la caminadora al revés o de lado.



⊗ Está estrictamente prohibido pisar la cabeza de la caminadora.



⚠️ Los ancianos, los niños y las mujeres embarazadas deben usar la Caminadora con prudencia.

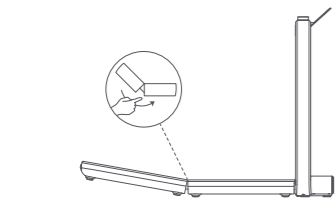

⚠ Mantenga las manos seguras.

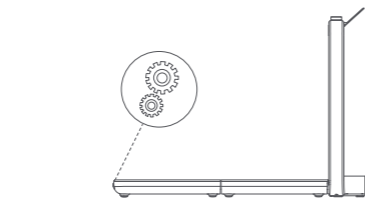

⚠ Guarde bien los artículos que se lleva consigo en caso de atascarse.

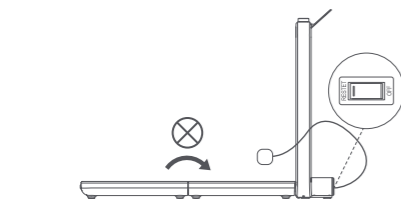

⊗ No doble la Caminadora antes de que la alimentación no esté desconectada.

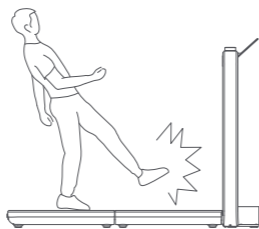

⊗ No se suba ni se baje de la máquina mientras la cinta de correr aún esté funcionando.

4.7 Cuidado y Mantenimiento

1. Limpieza de la cinta de correr

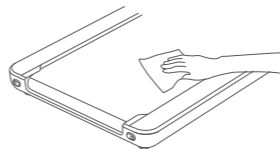

- Apague la caminadora y desenchufe el cable de alimentación.
- Aplique una cantidad adecuada de detergente suave a un paño enteramente hecho de algodón para limpiarla. No rocíe el detergente directamente sobre la cinta de correr ni use ningún detergente ácido o corrosivo.
- No limpie debajo de la cinta de correr.
- Limpie el polvo y las manchas que puedan aparecer en el suelo detrás de la cola de la Caminadora después de su uso durante un período de tiempo.

2. Deslizamiento y corrección de la cinta de correr

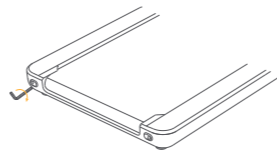

- Inclinación de la cinta de correr hacia la izquierda: gire el tornillo de ajuste izquierdo 1/4 de círculo en el sentido de las agujas del reloj.
- Inclinación de la cinta de correr hacia la derecha: gire el tornillo de ajuste derecho 1/4 de círculo en el sentido de las agujas del reloj.
- Deslizamiento de la cinta de correr: gire los tornillos de ajuste izquierdo y derecho en 1/2 de círculo en el sentido de las agujas del reloj, respectivamente.
- Después del ajuste cada vez, deje que la Caminadora funcione a una velocidad de 3-4 km/h durante 1-2 minutos para observar los resultados de la corrección. Si es necesario, ajústelo de nuevo.

3. Lubricación de la cinta de correr

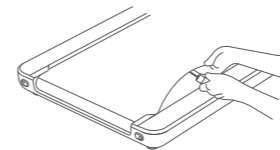

- Apague la caminadora y desenchufe el cable de alimentación.
- Levante el borde de la cinta de correr y aplique aceite de silicona en su superficie interna. Es más fácil de operar cuando la caminadora no está completamente desplegada.
- Encienda la caminadora y déjela funcionar a una velocidad de 3 km/h durante 10-20 segundos antes del uso.
- Aplique de 5 a 10 ml de aceite de silicona para lubricar cada vez, con el fin de evitar los impactos negativos causados por el uso excesivo de aceite de silicona.
- Lubrique la cinta de correr una vez cada tres meses.

4.8 Reciclaje y Eliminación



En el momento de eliminación de la caminadora, la batería contenida en la máquina debe retirarse.

Al reemplazar la batería, use sólo una OEM, una disponible en nuestra tienda de repuestos en línea.

El compartimiento de la batería está ubicado en la parte posterior de la caminadora. Para abrir el compartimiento, primero quite el tornillo de la tapa con un destornillador adecuado y luego presione el extremo inferior del pestillo de bloqueo de los conectores. De esta manera, ambos lados del enlace se pueden separar tirando de ellos.

Cuando inserte una batería nueva, une los dos conectores y asegúrese de que el pestillo quede bloqueado sobre el tope.

No deseche las baterías usadas en el sistema de desechos domésticos y asegúrese de que se reciclen adecuadamente a través de puntos de recolección públicos. Esto también se aplica a la batería de cintas de correr defectuosas.



Los dispositivos marcados con este símbolo deben eliminarse por separado de los residuos domésticos, ya que contienen materiales valiosos que pueden reciclarse. La eliminación adecuada beneficia al medio ambiente y a la salud humana. Consulte la información pertinente proporcionada por la autoridad local o minorista.

Conteúdo

5.1 Produto e Acessórios	76
5.2 Diagrama funcional	77
5.3 Guia para uso inicial	81
5.4 Instruções Operacionais	83
5.5 Marca e Declaração Legal	86
5.6 Precauções de Segurança	87
5.7 Cuidados e Manutenção	90
5.8 Reciclagem e Eliminação	91

Seja bem-vindo

Obrigado por escolher Esteira ergométrica de KingSmith WalkingPad (doravante referido como "a esteira ergométrica ") que ostenta um design simples, requintado e inovador. Os utilizadores da esteira ergométrica podem desfrutar de uma vida com qualidade de exercício saudável em casa. Contudo, este produto é apenas para uso doméstico, e não para quaisquer fins comerciais, locação, ou para organizações públicas.

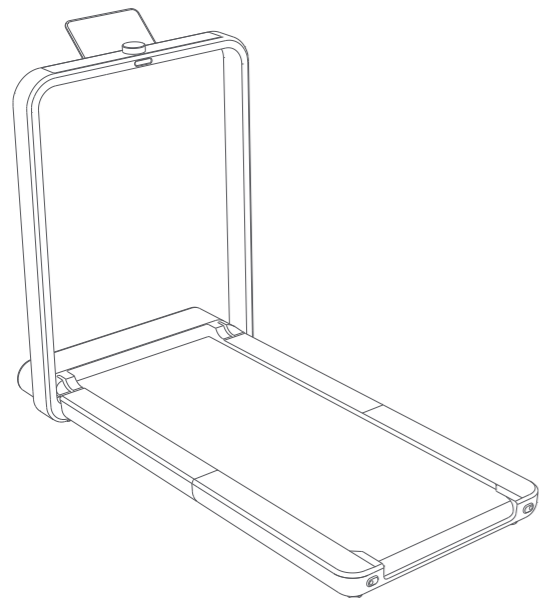

Índice de desempenho	Parâmetros detalhados
Idade aplicável	14-60 anos de idade
Gama de velocidades	1-12 km/h
Área de correr	460×1210 mm
Carga máxima	110 kg
Frequência	50/60 Hz
Voltagem	220-240 V~
Potência	918 W
Peso líquido	38 kg
Dimensão desdobrável	1419×711×1053 mm
Dimensão dobrável	1007×711×225 mm

5.1 Produto e Acessórios

Por favor verifique cuidadosamente se os artigos dentro da caixa de embalagem estão completos e intatos, e contacte o retalhista assim que encontrar quaisquer artigos em falta ou danificados.

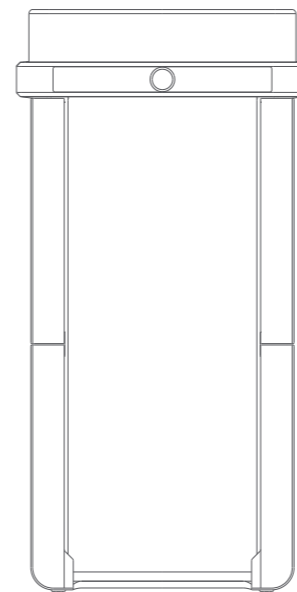

Tapete rolante

Acessórios



Cabo de alimentação



Suporte de telemóvel



Chave de segurança



Chave inglesa



Óleo de silicone



Manual do utilizador

5.2 Diagrama funcional

1. Estado desdobrável

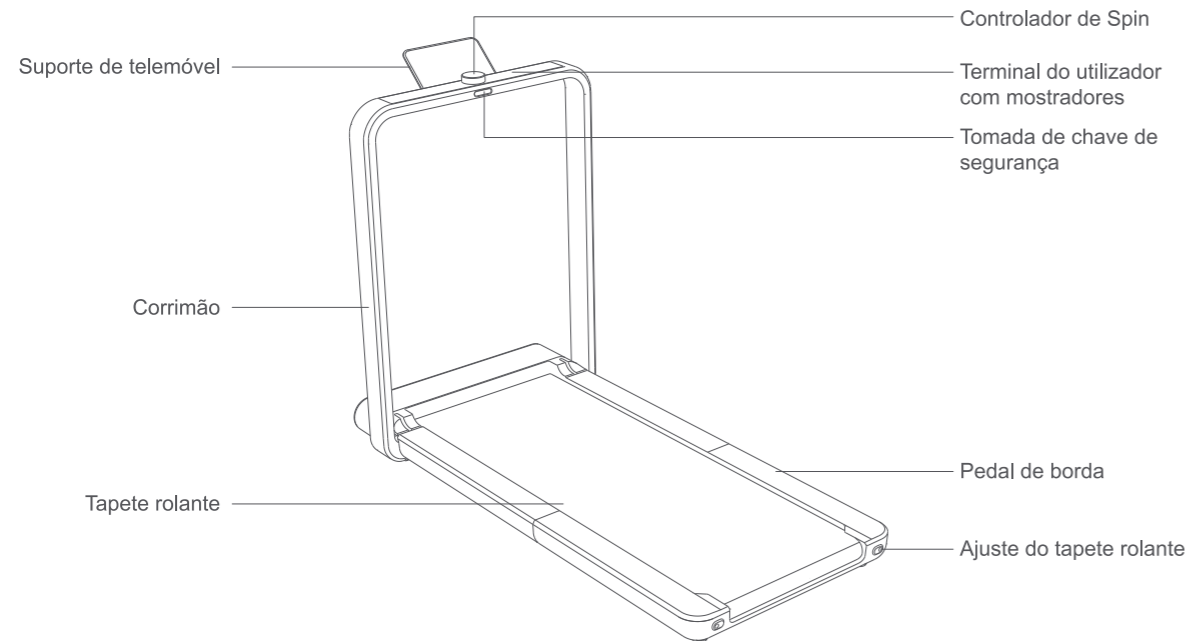

2. Estado dobrável

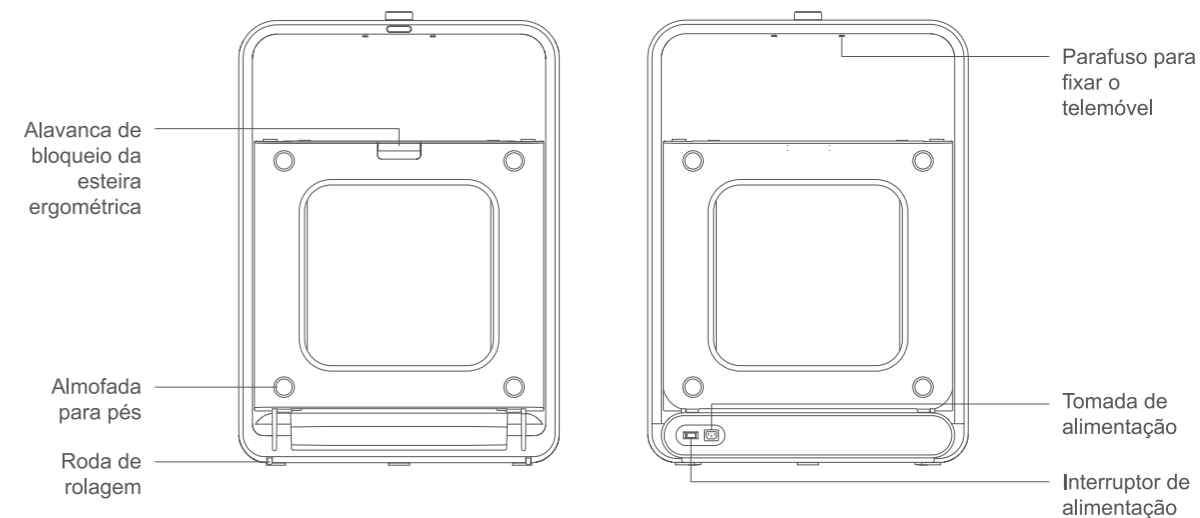

3. Funcionalidades de terminal do utilizador com mostradores

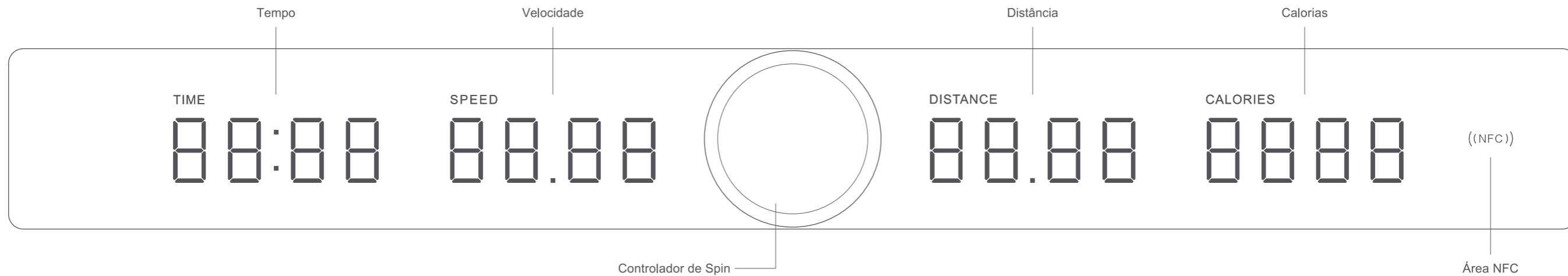

5.3 Guia para uso inicial

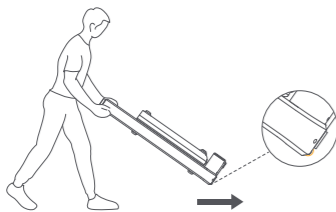

1. Antes de empurrar ou puxar este produto, certifique-se de que a esteira ergométrica está trancada, e coloque-a sobre um solo plano.

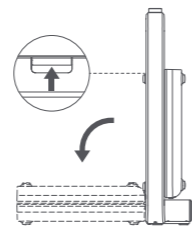

2. Puxar a alavanca de bloqueio da esteira ergométrica para desbloquear a esteira ergométrica e mantê-la lentamente plana.

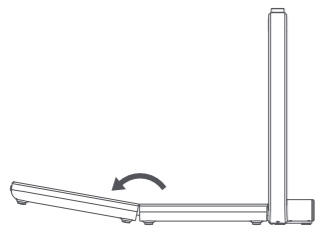

3. Desdobrar a esteira ergométrica, ajustar o tapete rolante para a posição central, desdobrá-lo lentamente e pressioná-lo, ou rode a almofada para pés para a tornar completamente plana.

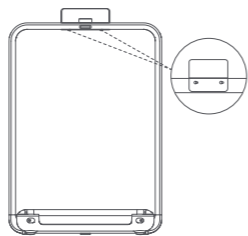

4. Tirar o suporte do telemóvel da caixa de acessórios e encaixar os dois grandes orifícios nos parafusos de fixação no lado inferior do corrimão, depois empurrar para sentido dos orifícios mais pequenos e fixar no corrimão.

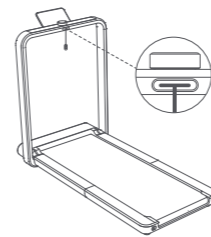

5. Tirar a chave de segurança da caixa de acessórios, e inseri-la na tomada da chave de segurança no meio do corrimão.

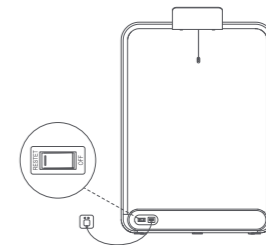

6. Ligar o interruptor da esteira ergométrica depois de ligar o cabo de alimentação.



7. Digitalizar o código QR acima ou procure "KS Fit" na App Store ou Google Play para completar a instalação e inscrição.

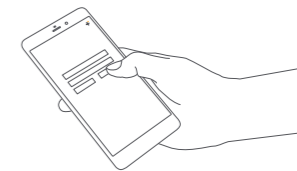

8. Antes de utilizar a esteira ergométrica, abrir o APP, adicionar e ligar a esteira ergométrica seguindo as instruções.

5.4 Instruções Operacionais

1. Começar a correr

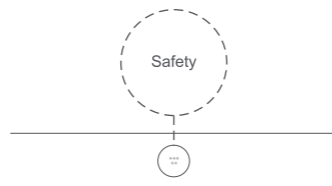

1. Depois de a esteira ergométrica ser ligada, o terminal do utilizador com mostradores será iluminado, e todos os parâmetros serão exibidos como "0" por defeito.

2. Se a chave de segurança não for inserida, o ecrã mostrará "Safety", e o modo "Segurança" será ativado. Se não conseguir iniciar a esteira ergométrica normalmente, por favor insira a chave de segurança.

Pressionar por tempo curto

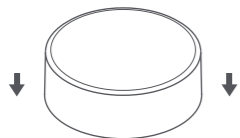

3. Após o Controlador de Spin ser pressionado durante 3 segundos no modo por defeito, a esteira ergométrica será iniciada lentamente.

Rodar

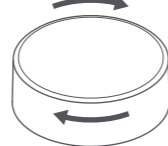

4. Rodar o Controlador de Spin no sentido dos ponteiros do relógio para acelerar.
Rodar o Controlador de Spin no sentido contrário ao dos ponteiros do relógio para desacelerar.

Rodar rapidamente

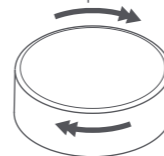

5. Regulação rápida da velocidade: Rode o Controlador de Spin rapidamente para alternar os níveis de velocidade, que serão alternados entre os níveis 1 km/h, 3 km/h, 6 km/h, 9 km/h, e 12 km/h.

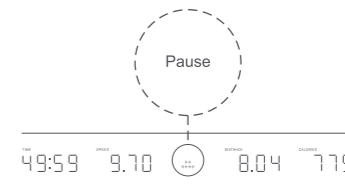

6. Após o Controlador de Spin ser pressionado durante o exercício, ou após a operação sem carga durar 5 minutos, a esteira ergométrica irá parar lentamente e entrar no estado de pausa. Depois, pressionar brevemente o Controlador de Spin novamente para reiniciar a esteira ergométrica, que voltará ao nível de velocidade original antes da pausa.

Pressionar por um longo tempo

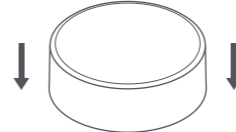

7. No modo de pausa, após o Controlador de Spin ser pressionado durante 2 segundos ou o estado de não operação durar 180s, a esteira ergométrica irá parar, e todos os parâmetros irão voltar a "0" por defeito.



8. Após terminar o exercício, por favor desligue o interruptor e guarde o cabo de alimentação.

2. Outros estados apresentados no ecrã Controlador de Spin

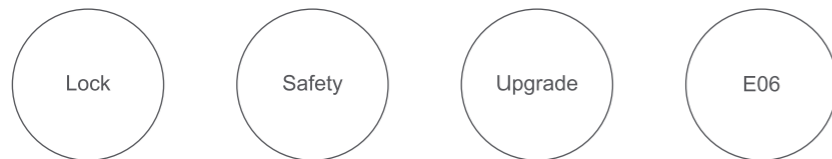

As instruções para o estatuto especial são também apresentadas através do ecrã do Controlador de Spin. O sistema do equipamento será atualizado e renovado regularmente. Algumas operações podem ser ajustadas, e por favor consulte a esteira ergométrica que possui quando opera.

3. Modo de esperar e acordar

No modo de esperar (todos os parâmetros são apresentados como "0"), se o Controlador de Spin for pressionado durante 3s ou se a esteira ergométrica for mantida inativa durante 5min, a esteira ergométrica será mudada para o estado de esperar, e as luzes do painel serão apagadas. No modo de esperar, pressione por breves instantes o Controlador de Spin para acordar a esteira ergométrica.

5.5 Marca e Declaração Legal

4. Códigos de avaria 🗑

- E01: Excesso de corrente de software
- E02: Excesso de corrente de hardware
- E03: Sobreaquecimento do módulo IPM
- E04: Proteção contra subtensão
- E05: Proteção contra sobretensão
- E06: Proteção de motor em fase aberta
- E07: Proteção de lock-rotor do motor
- E08: Falha do sensor
- E09: Falha no arranque do motor
- E12: Proteção contra sobrecargas de motor
- E13: Proteção contra sobrecarga
- E14: Perda de sinal de Hall
- E15: Erro de comunicação

Várias patentes relacionadas com a série da Esteira ergométrica de KingSmith WalkingPad são desenvolvidas e protegidas por direitos do autor pela Beijing KingSmith Technology Co., Ltd. (" KingSmith" para abreviar). Sem a autorização escrita do KingSmith, qualquer organização ou indivíduo não copiará ou distribuirá a totalidade ou qualquer parte deste Manual do Utilizador e as respetivas patentes. Este Manual do Utilizador, tanto quanto possível, contém o maior número das últimas introduções de funções e instruções de utilização como a hora da impressão. Pode haver discrepâncias entre a esteira ergométrica comprada e as aqui descritas devido a uma otimização contínua nas funções e desenhos. Portanto, este Manual do Utilizador pode divergir do produto real em termos de cor, aspecto, etc. Por isso, por favor, consulte o produto real.

5.6 Precauções de Segurança

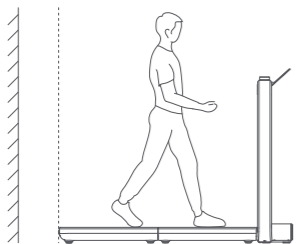

⚠ Deve haver a distância de mais de 2.000mm ou superior atrás da esteira ergométrica. Em caso de qualquer emergência, pode segurar o corrimão com ambas as mãos para apoiar o seu corpo antes de saltar da esteira ergométrica.

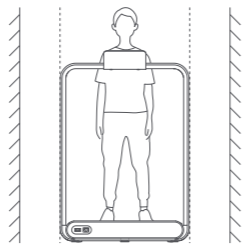

⚠ A distância entre a esteira ergométrica e outros objetos nos dois lados deve ser de pelo menos 500mm.

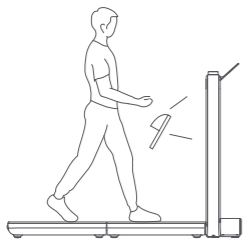

⚠ Por favor, calce os sapatos e roupas desportivas antes do exercício apropriado, de acordo com as próprias condições. Se sentir desconfortável no processo do exercício, por favor pare imediatamente e consulte o médico para evitar possíveis riscos de lesões.

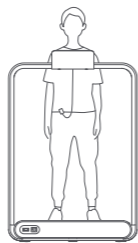

⚠ Antes de utilizar a esteira ergométrica, por favor prenda o outro lado da chave de segurança à roupa. Em caso de qualquer emergência, retire a chave de segurança para parar imediatamente a esteira ergométrica.

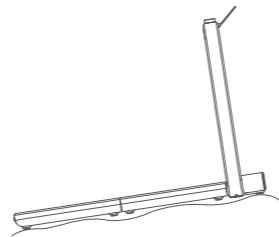

⊗ Proibir rigorosamente a utilização da esteira ergométrica em qualquer terreno irregular.

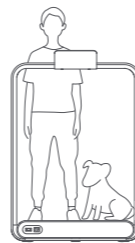

⊗ Não utilizar a esteira ergométrica na companhia dos animais de estimação.



⚠ Desligar o cabo de alimentação quando a esteira ergométrica não é utilizada.

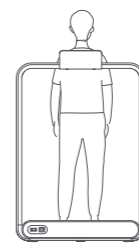

⊗ Não utilizar a esteira ergométrica para trás ou para os lados.



⊗ Não pisar a cabeça da esteira ergométrica.



⚠ Os idosos, as crianças e as mulheres grávidas devem utilizar a esteira ergométrica com prudência.

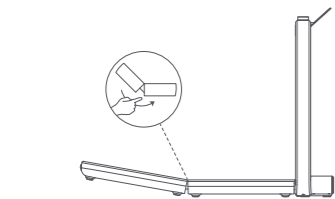

⚠ Atenção às mãos.

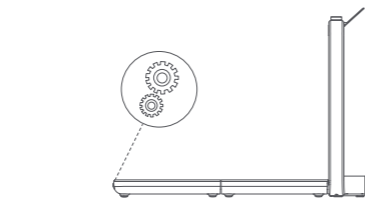

⚠ Mantenha bem os pertences em caso de ficar preso.

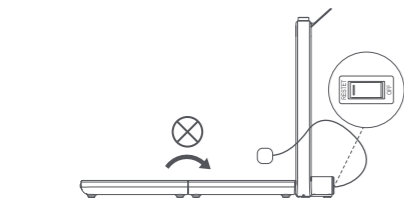

⊗ Não dobrar a esteira ergométrica sem que a energia seja desligada.

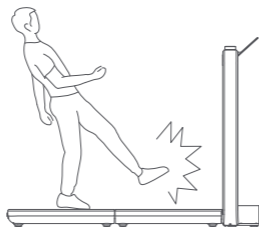

⊗ Não entrar ou sair da esteira ergométrica quando o tapete rolante ainda está a funcionar.

5.7 Cuidados e Manutenção

1. Limpeza da esteira ergométrica

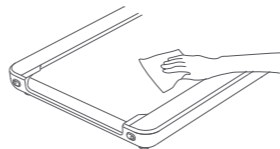

- Desligue a esteira ergométrica e o cabo de alimentação.
- Aplicar uma quantidade apropriada de detergente suave num pedaço de pano totalmente feito de algodão. Não pulverizar o detergente diretamente sobre o tapete rolante ou utilizar qualquer detergente ácido ou corrosivo.
- Não esfregar debaixo do tapete rolante.
- Como prática regular, limpar o pó e as manchas que possam aparecer no chão por detrás da cauda da esteira ergométrica.

2. Deslizamento e correção do tapete rolante

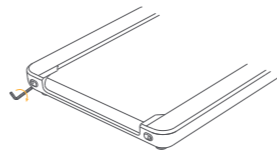

- Inclinação do tapete rolante para a esquerda: rodar o parafuso de ajustamento esquerdo para um círculo de 1/4 no sentido dos ponteiros do relógio.
- Inclinação do tapete rolante para a direita: rodar o parafuso de ajustamento direito para um círculo de 1/4 no sentido dos ponteiros do relógio.
- Deslizamento do tapete rolante: rodar os parafusos de ajustamento esquerdos e direitos para um 1/2 círculo no sentido dos ponteiros do relógio, respetivamente.
- Depois de ajustar cada vez, deixar a esteira ergométrica funcionar a uma velocidade de 3-4km/h durante 1-2 minutos para observar a correção. Se necessário, por favor ajuste novamente.

3. Lubrificação do tapete rolante

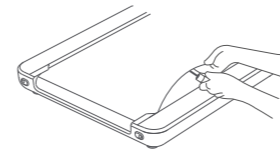

- Desligue a esteira ergométrica e desligue o cabo de alimentação.
- Levantar o bordo do tapete rolante, e aplicar óleo de silicone na sua superfície interna. É mais fácil de operar quando a esteira ergométrica não está totalmente desdobrada.
- Iniciar a esteira ergométrica, deixá-la correr a uma velocidade de 3km/h durante 10-20 segundos antes de ser utilizada.
- Aplicar 5-10ml de óleo de silicone para lubrificação de cada vez, para evitar qualquer impacto negativo causado pelo uso excessivo de óleo de silicone.
- Lubrificar o tapete rolante a cada 3 meses.

5.8 Reciclagem e Eliminação



A bateria contida nesta esteira ergométrica deve ser removida para eliminação.

Ao substituir a bateria, utilizar apenas uma OEM, que está disponível na nossa loja de peças online.

O compartimento da bateria está localizado na parte de trás da esteira ergométrica. Abrir o compartimento retirando o parafuso da tampa com uma chave de fendas apropriada, e depois pressionar ao lado inferior do fecho de bloqueio nos conectores. Desta forma, ambos os lados da ligação podem ser separados, puxando-os para fora.

Ao inserir uma nova bateria, junte os dois conectores e assegure-se de que o fecho fecha por cima do batente.

Não deitar as baterias usadas no sistema de resíduos domésticos, e confirmou-se de que são devidamente recicladas através de pontos de recolha públicos. Isto também se aplica à bateria da esteira ergométricas defeituosas.



Os dispositivos marcados com este símbolo devem ser eliminados separadamente dos seus resíduos domésticos, uma vez que contêm materiais valiosos que podem ser reciclados. A eliminação adequada beneficia o ambiente e a saúde humana. Consulte a informação relevante fornecida pela sua autoridade local ou retalhista.

Contenuti

6.1 Prodotti e accessori	94
6.2 Schema funzionale	95
6.3 Guida al primo utilizzo	99
6.4 Impara a usare un tapis roulant	101
6.5 Marchi e note legali	104
6.6 Istruzioni di sicurezza	105
6.7 Cura e manutenzione	108
6.8 Riciclaggio e smaltimento	109

Benvenuti!

Grazie per aver scelto il tapis roulant KingSmith WalkingPad (di seguito denominato "il tapis roulant"), che vanta un design semplice, squisito e innovativo. Gli utenti del tapis roulant possono godere di un allenamento a casa e migliorare la qualità della vita. Il tapis roulant è solo per uso domestico, non per scopi commerciali, di leasing o di organizzazione pubblica.

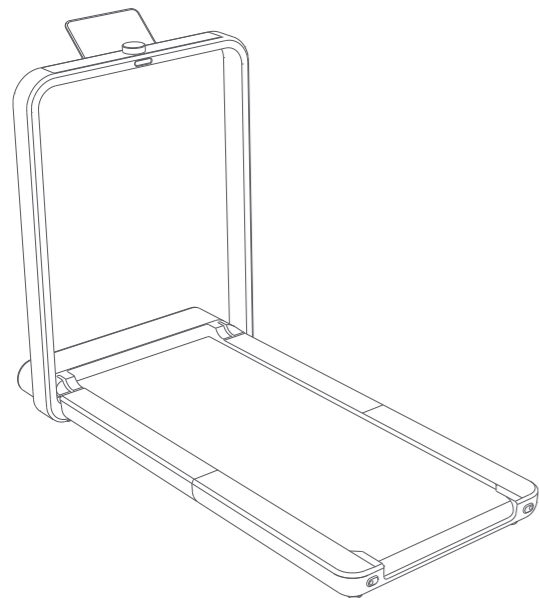

Prestazione	Specificazione
Età adatta	14-60 anni
Gamma di velocità	1-12 km/h
Area di corsa	460×1210 mm
Carico massimo	110 kg
Frequenza	50/60 Hz
Tensione	220-240 V~
Potenza	918 W
Peso del prodotto	38 kg
Dimensione espansa	1419×711×1053 mm
Dimensione pieghevole	1007×711×225 mm

6.1 Prodotti e accessori

Si prega di controllare attentamente se gli articoli contenuti nella scatola di imballaggio sono completi e intatti, e di contattare il rivenditore una volta trovato qualsiasi articolo mancante o danneggiato.

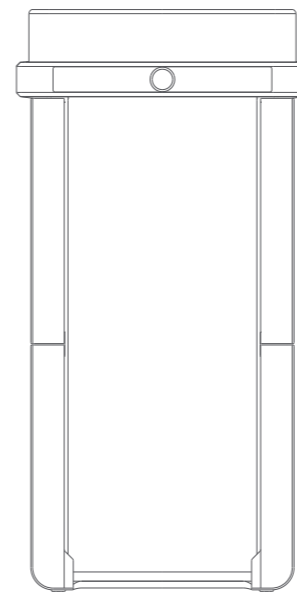

Tapis roulant

Accessori



Cavo di alimentazione



Porta cellulare



Chiave di sicurezza



Chiave inglese



Olio di silicone

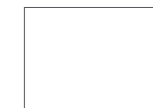

Manuale d'uso

6.2 Schema funzionale

1. Stato espanso

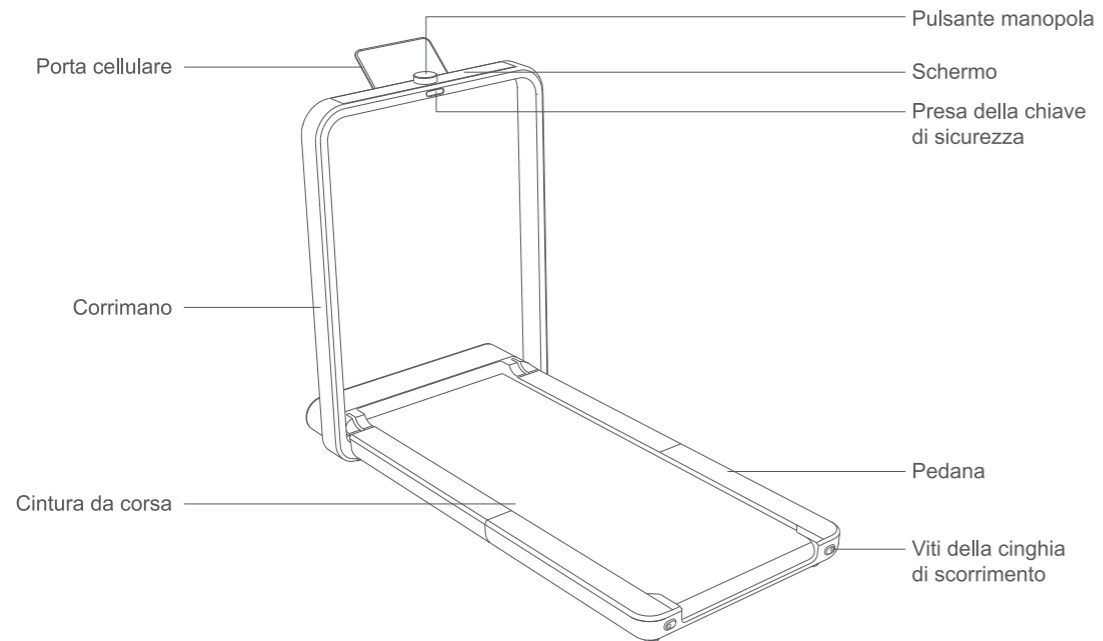

2. Stato di archiviazione

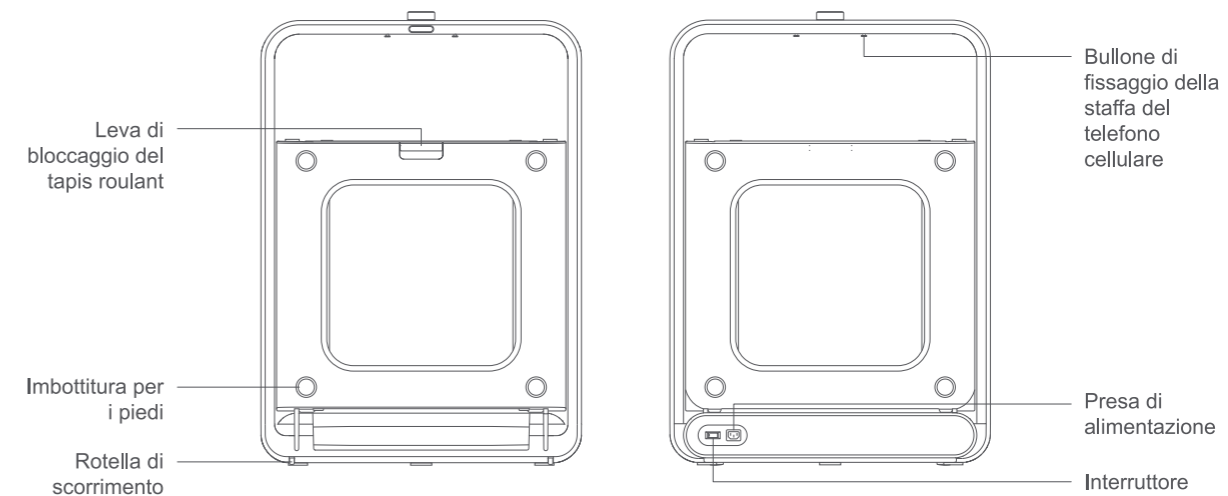

3. Funzioni del pannello di visualizzazione

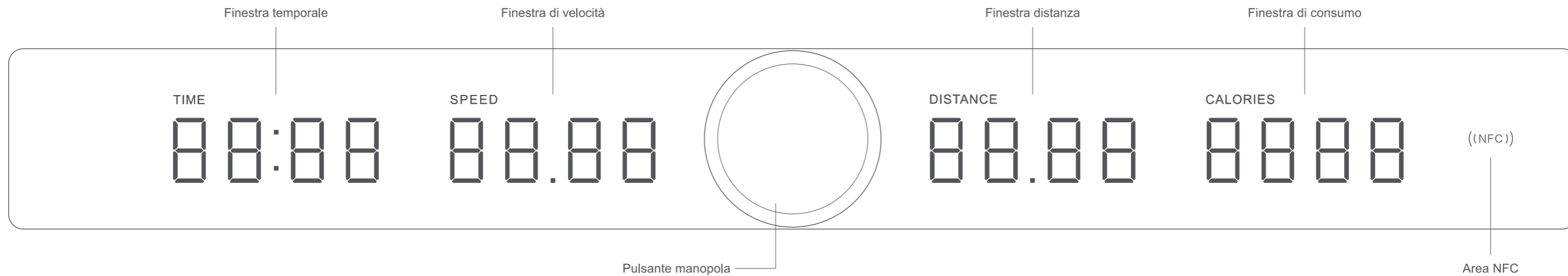

6.3 Guida al primo utilizzo

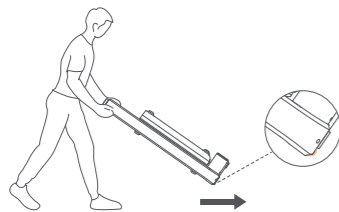

1. Prima di spingere o tirare il tapis roulant, assicurati che il tapis roulant sia bloccato e posizionato su un terreno piano.

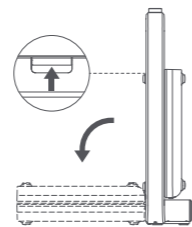

2. Tira verso l'alto la leva di bloccaggio del tapis roulant per sbloccarlo e tienilo lentamente in piano.

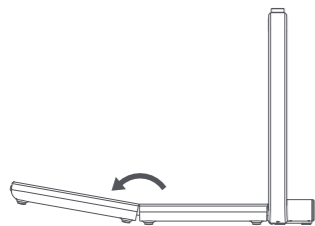

3. Dispiegare il tapis roulant, regolare la cinghia da corsa in posizione centrale, dispiegare lentamente e premere il tapis roulant, o ruotare il cuscinetto del piede inferiore per renderlo completamente piatto.

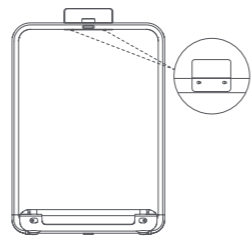

4. Estrarre il portacellulare dalla scatola degli accessori, collegare due grandi fori ai bulloni di fissaggio sotto il tallero, poi spingere verso la direzione delle estremità strette dei fori, fissando così il portacellulare al tallero.

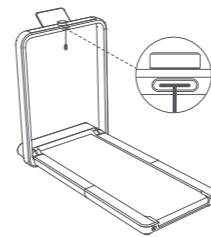

5. Estrarre la chiave di sicurezza dalla scatola degli accessori e inserirla nella presa della chiave di sicurezza al centro del corrimano.

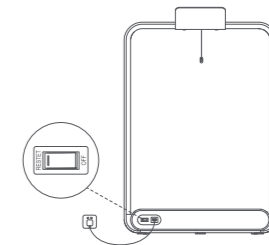

6. Accendere l'interruttore del tapis roulant dopo aver collegato il cavo di alimentazione.



7. Scannerizza il codice QR qui sopra o cerca "KS Fit" nell'App Store o Google Play per completare l'installazione e l'iscrizione.

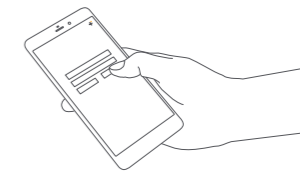

8. Prima di usare il Treadmill, apri l'APP, aggiungi e lega il Treadmill seguendo le istruzioni.

6.4 Impara a usare un tapis roulant

1. Inizia a correre



1. Dopo l'accensione del Treadmill, il pannello del display si illuminerà e tutti i parametri saranno visualizzati come "0" per impostazione predefinita.

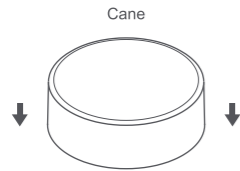

3. Dopo aver premuto brevemente pulsante della manopola per 3 secondi nella modalità predefinita, il tapis roulant verrà avviato lentamente.

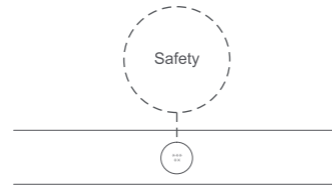

2. Se la chiave di sicurezza non è inserita, verrà visualizzato il messaggio "Safety" e verrà attivata la modalità "Sicuro". Se non si riesce ad avviare il tapis roulant, inserire la chiave di sicurezza.

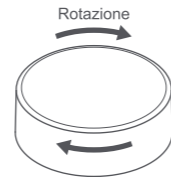

4. Ruotare il pulsante della manopola in senso orario per accelerare. Ruotare il pulsante della manopola in senso antiorario per decelerare.

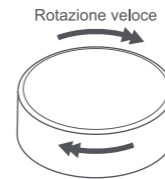

5. Regolazione rapida della velocità: Ruota rapidamente il pulsante della manopola per cambiare i livelli di velocità, che saranno commutati tra 1km/h, 3km/h, 6km/h, 9km/h e 12km/h.

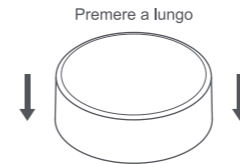

7. Nella modalità di pausa, dopo che il pulsante della manopola viene premuto a lungo per 2 secondi o non c'è nessuna operazione per 180 secondi, il Treadmill si fermerà e tutti i parametri torneranno a "0" per default.

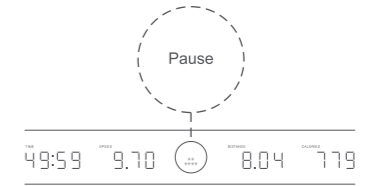

6. Durante l'esercizio, premere brevemente il pulsante della manopola o correre senza carico per 5 minuti, il tapis roulant si fermerà lentamente ed entrerà nello stato di pausa. In questo stato, premere di nuovo brevemente il pulsante della manopola e il tapis roulant riprenderà la velocità precedente alla pausa.



8. Dopo aver finito l'esercizio, si prega di spegnere l'interruttore e mettere via il cavo di alimentazione.

2. Altri stati visualizzati sullo schermo del pulsante della manopola



Le istruzioni per lo stato speciale sono anche visualizzate tramite lo schermo del pulsante della manopola. Poiché il sistema Treadmill sarà aggiornato e ottimizzato regolarmente, alcune operazioni potrebbero essere regolate, e si prega di fare riferimento al Treadmill effettivo posseduto quando operare.

3. Standby e risveglio

In modalità standby (tutti i parametri sono visualizzati come "0"), se il pulsante della manopola viene premuto a lungo per 3 secondi o il Treadmill viene tenuto inattivo per 5 minuti, il Treadmill passerà allo stato di standby e le luci del pannello saranno spente. In modalità standby, premere brevemente il pulsante della manopola per risvegliare il Treadmill.

6.5 Marchi e note legali

4. Codice di errore

- E01: Sovracorrente software
- E02: Sovracorrente hardware
- E03: Il modulo IPM è surriscaldato
- E04: Protezione da sottotensione
- E05: Protezione da sovratensione
- E06: Protezione mancanza fase motore
- E07: Protezione stallo motore
- E08: Guasto sensore
- E09: Impossibile avviare il motore
- E12: Protezione da sovracorrente motore
- E13: Protezione da sovraccarico
- E14: Manca il segnale di Hall
- E15: Problema di comunicazione

Vari brevetti relativi alla serie di tapis roulant KingSmith WalkingPad sono sviluppati e protetti da copyright da Beijing KingSmith Technology Co., Ltd. ("KingSmith in breve). Senza il permesso scritto di KingSmith, qualsiasi organizzazione o individuo non deve copiare o distribuire tutto o parte di questo manuale d'uso e non deve utilizzare i brevetti in esso contenuti. Questo manuale d'uso, per quanto possibile, ha incluso varie introduzioni di funzioni e istruzioni operative aggiornate al momento della stampa. Tuttavia, potrebbero esserci discrepanze tra il tapis roulant acquistato e quelli descritti nel presente documento a causa di una continua ottimizzazione delle funzioni e del design. Pertanto, il tapis roulant reale prevarrà in caso di eventuali differenze di colore e aspetto.

6.6 Istruzioni di sicurezza

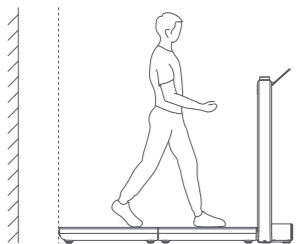

⚠ Si prega di tenere il corrimano con entrambe le mani per sostenere il corpo prima di saltare dal tapis roulant in caso di emergenza. Pertanto, ci dovrebbe essere una distanza di almeno 2.000 mm o superiore dietro il tapis roulant.

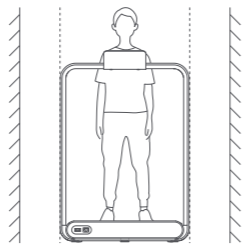

⚠ La distanza tra il tapis roulant e altri oggetti sui due lati deve essere di almeno 500 mm.

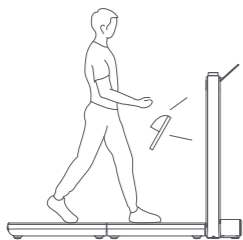

⚠ Si prega di indossare scarpe e vestiti sportivi quando si utilizza il tapis roulant, e di condurre un esercizio adeguato in base alle proprie condizioni di salute. Se si sente a disagio nel processo di esercizio, si prega di fermarsi immediatamente e consultare un medico per evitare il possibile rischio di lesioni.

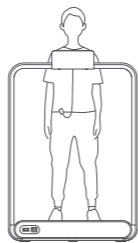

⚠ Prima di utilizzare il tapis roulant, si prega di tagliare l'altra estremità della chiave di sicurezza ai vestiti. In caso di emergenza, staccare la chiave di sicurezza per fermare immediatamente il tapis roulant.

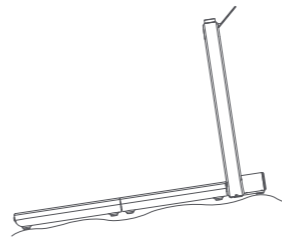

⊗ Proibire rigorosamente l'uso del tapis roulant su qualsiasi terreno irregolare.

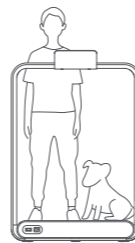

⊗ Non utilizzare il tapis roulant in compagnia di animali domestici.



⚠ Scollegare il cavo di alimentazione quando il tapis roulant non viene utilizzato.

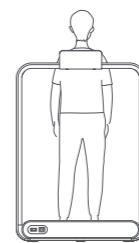

⊗ Non utilizzare il tapis roulant all'indietro o lateralmente.



⊗ Non calpestare la testa del tapis roulant.



⚠ Gli anziani, i bambini e le donne incinte dovrebbero usare il tapis roulant con prudenza.

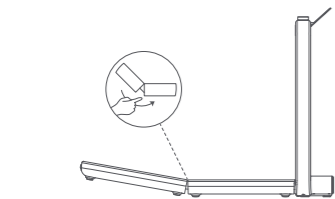

⚠ Tenere le mani al sicuro.

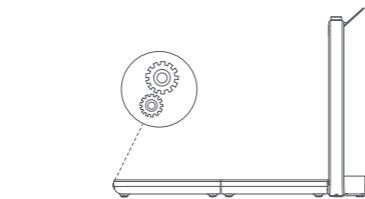

⚠ Conservate bene le vostre cose in caso di rimanere bloccati.

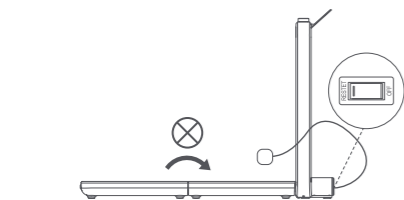

⊗ Non piegare il tapis roulant quando l'alimentazione non è spenta.

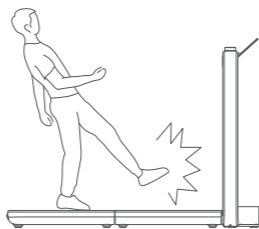

⊗ Non salire o scendere dal tapis roulant quando la cinghia da corsa è ancora in funzione.

6.7 Cura e manutenzione

1. Pulire il tapis roulant

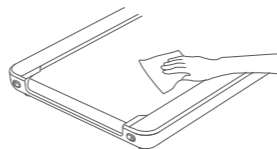

- Spegner il tapis roulant e scollega il cavo di alimentazione.
- Applicare una quantità appropriata di detergente morbido su un pezzo di stoffa interamente in cotone. Non spruzzare il detergente direttamente sulla cinghia di scorrimento e non usare detergenti acidi o corrosivi per evitare danni.
- Non pulire sotto la cintura di scorrimento.
- Come pratica regolare, pulire la polvere e le macchie che potrebbero apparire sul terreno dietro la coda del tapis roulant.

2. Slittamento e correzione della cintura da corsa

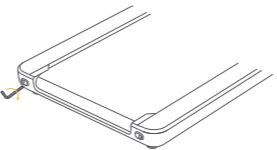

- Inclinazione del nastro di scorrimento verso sinistra: ruotare la vite di regolazione sinistra per 1/4 di cerchio in senso orario.
- Inclinazione del nastro di scorrimento verso destra: ruotare la vite di regolazione destra per 1/4 di cerchio in senso orario.
- Scivolamento della cinghia di scorrimento: ruotare le viti di regolazione sinistra e destra rispettivamente di 1/2 cerchio in senso orario.
- Dopo aver regolato ogni volta, lasciate correre il tapis roulant a una velocità di 3-4km/h per 1-2 minuti per osservare la correzione. Se necessario, regolare di nuovo.

3. Lubrificazione della cinghia di corsa

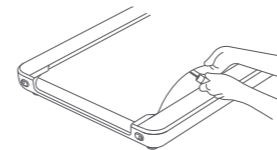

- Spegner il tapis roulant e scollega il cavo di alimentazione.
- Sollevare il bordo della cinghia di corsa e applicare olio di silicone sulla sua superficie interna. È più facile da usare quando il tapis roulant non è completamente aperto.
- Avviare il tapis roulant e lasciarlo funzionare a 3km/h per 10-20 secondi prima dell'uso.
- Applicare 5-10ml di olio di silicone per la lubrificazione ogni volta per evitare qualsiasi impatto negativo causato dall'uso eccessivo di olio di silicone.
- Lubrificare la cinghia di scorrimento una volta ogni tre mesi.

6.8 Riciclaggio e smaltimento



La batteria contenuta in questo tapis roulant deve essere rimossa per lo smaltimento.

Quando si sostituisce la batteria, utilizzare solo una batteria OEM disponibile nel nostro negozio di ricambi online.

Il vano batteria si trova sul retro del tapis roulant. Apre il compartimento togliendo la vite del coperchio con un cacciavite adeguato, e poi preme l'estremità inferiore del fermo di bloccaggio dei connettori. In questo modo, entrambi i lati del collegamento possono essere separati tirandoli

Si prega di non smaltire le batterie usate nel sistema dei rifiuti domestici e di assicurarsi che vengano riciclate correttamente attraverso i punti di raccolta pubblici. Questo vale anche per le batterie dei tapis roulant difettosi.



I dispositivi contrassegnati da questo simbolo devono essere smaltiti separatamente dai rifiuti domestici, poiché contengono materiali preziosi che possono essere riciclati. Uno smaltimento corretto va a beneficio dell'ambiente e della salute umana. Si prega di fare riferimento alle informazioni pertinenti fornite dalle autorità locali o dal rivenditore.