



**L20**

**CAUTION READ THIS MANUAL BEFORE USING YOUR EQUIPMENT**

# Table of contents

1.Important warning .....	1
2.Product components .....	3
3.Technical parameters .....	4
4.Product installation .....	5
4.1 Install the handlebar .....	6
4.2 Install the front wheel .....	7
4.3 Install the front mudguard .....	8
4.4 Install the front basket .....	9
4.5 Install the headlight .....	10
4.6 Install the pedals .....	11
5.Display instructions .....	12
6.Battery .....	19
7.Charging .....	21
8.Warranty policy .....	22

# 1.Important warning

This manual include important safety performance informatlon and service informatlon.Please make sure you have read the following warning content before the first time you use our product.

If you borrow your electric bicycle to other people, please let the user read this manual, it could help to decrease the risk of accident.

Please wear a suitable and safe helmet before riding, please wear the clothes with fluores-cent and reflective stripes when you ride at night. Don't exceed speed limit, it is a main reason of traffic accident, we should abide by the traffic rule, we shouldn't exceed the speed limit.

Don't touch the charging hole on the bike, or use metal touch it, otherwise, the accident will be caused by the transient short circuit of the current.

Zero starting, braking frequent, driving against the wind, carrying people or anything; insufficient air pressure on the tires. All of these will use much electric energy, and then reduce the endurance mileage.If you want the best endurance mileage, please do something as follows :

- 1) Please use assist mode;
- 2) On the premise of safety, don't brake frequently or use zero starting.
- 3) Don't overload;
- 4) Before riding, please check the pressure of the tire and supply enough pressure.

Our Ebike should avoid prolonged exposure to the sun or rain, avoid storage in places with high temperature or corrosive gas, so as to avoid electroplating parts and paint surface by

chemical corrosion and electrical parts damage, resulting in operational failure and accidents.

Your current insurance business may not cover the situation you may encounter when riding an electric bike, please contact your insurance company or insurance broker for relevant consultation.

If you use our ebike in your country, pls refer to the local laws and regulation. For example in China, riding an electric bicycle must reach the age of 16.

Bicycles are vehicles with certain risk factors, please be sure to abide by the traffic rules. At the same time, when emergency braking, brake the rear wheel first, then brake the frontwheel, when cycling speed is too fast. There is a danger of tipping over if you brake the frontwheel suddenly, please ride carefully.

## 2.Product components

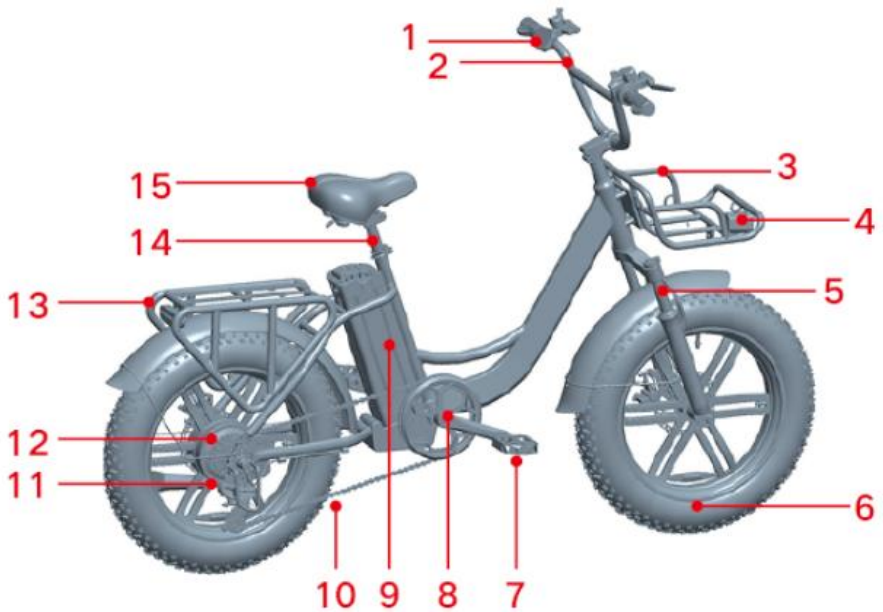

1.Display	2.Handlebar	3.Front basket	4.Front light	5.Fork
6.Tire	7.Pedal	8.Crank set	9.Battery	10.Chain
11.Freewheel	12.Motor	13.Rear light	14.Seatpost	15.Saddle

### 3. Technical parameters

Performance index	Project	US	EU
Basic Parameters	Vehicle Size	1737*700*1140	1737*700*1140
	wheel Size	20Inches	20Inches
	Body Material	Aluminium alloy	Aluminium alloy
	Maximum Load	264 lbs(120KG)	264 lbs(120KG)
	Vehicle weight	74.8 lbs(34KG)	74.8 lbs(34KG)
Main Parameters of the Whole Vehicle	Maximum Speed	25mph(39km/h)	25km/h(15mph)
	Maximum Gradient	10°	10°
	Rear Deraillleur	7-Speed	7-Speed
	Mileage Range	42km 26miles	66km 41miles
	Working Temperature	23°F-95°F(-5~35)	23°F-95°F(-5~35)
Battery Parameters	Rated Voltage	48V	48V
	Battery Capacity	13AH	13AH
Motor Parameters	Motor Power	750W	250W
	Motor Type	Brushless Gear Motor	Brushless Gear Motor
	Maximum Torque	50Nm	50Nm
Charger Parameters	Input voltage	100-240v	100-240v
	output voltage	54V	54V
	Output Current	2A	2A

# 4.Product installation

## Tool box checklist

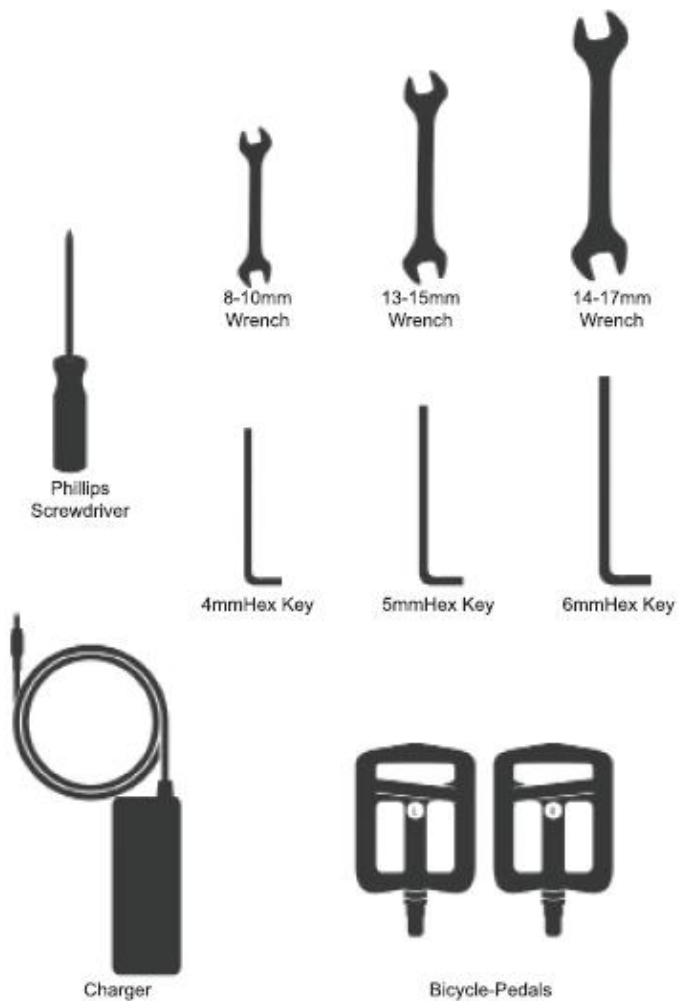

## 4.1 Install the handlebar

(1) Remove the handlebars to remove the packing material and place the center at the riser clamlet.



(2) Install 4mm hexagon wrench clockwise. Do not tighten the 4 bolts in FIG. A. Adjust the handle to the proper Angle in Fig. B, and then tighten the 4 bolts with proper force.

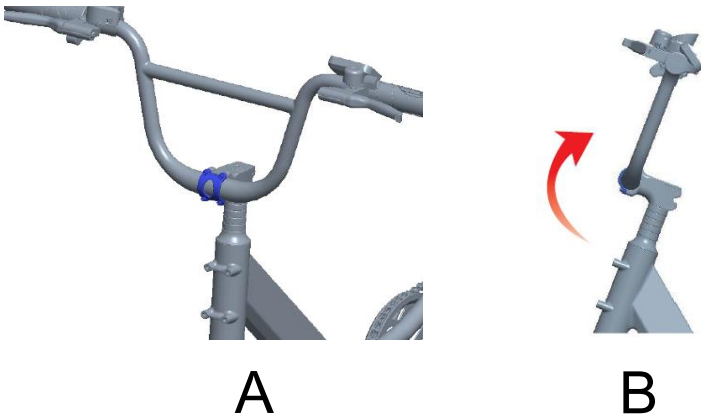



## 4.2 Install the front wheel

(1) Remove the front wheel to remove the packing material, and install the screw gasket shaft sleeve according to the drawing.

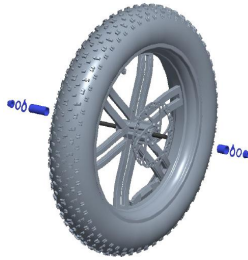

(2) Place the front wheel in the front fork card slot and lock it with a 15mm wrench.



## 4.3 Install the front mudguard

(1) The lifting lug of the mud pan is connected with the hole of the front fork axle pipe, and then threaded in the screw to tighten it.

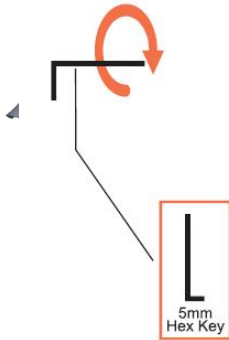

(2) The mudguard support shall be aligned with the front fork mudguard take-up hole position, and then threaded into the screw for tightening.



## 4.4 Install the front basket

(1) Remove the basket to remove the packaging material, and install the screw gasket according to the drawing.



(2) Install 4 bolts clockwise using a 4mm hexagon wrench, and place the harness in the front shelf hook.

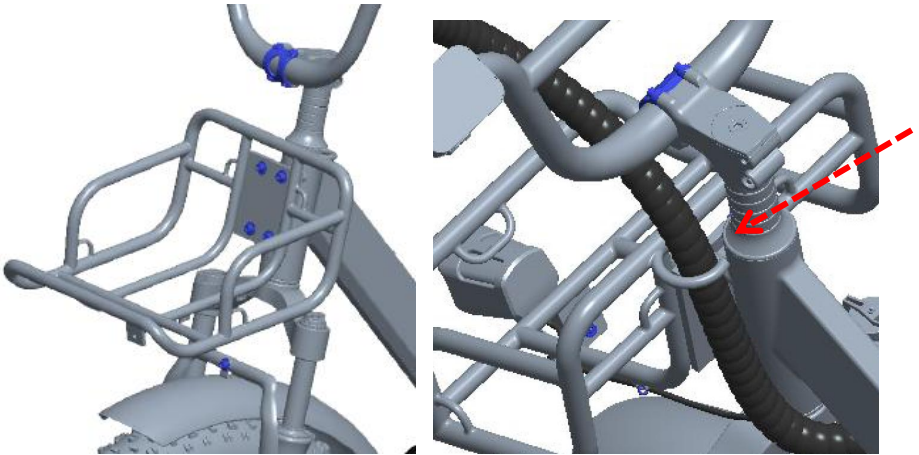

## 4.5 Install the headlight

(1) Install the headlight screw washer nut according to the drawing.

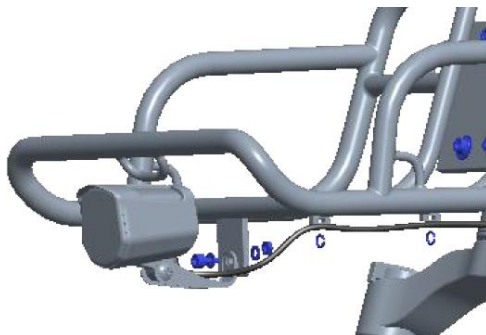

(2) The headlight line is fixed as shown in the figure.

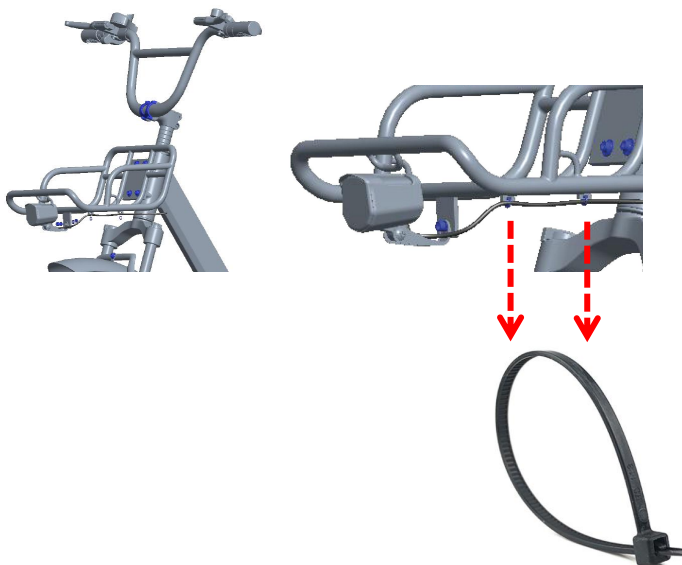

## 4.6 Install the pedals

(1) Prepare left and right pedal, The pedal "R" is installed on one side of the chainring, and "L" is opposite to the chainring.

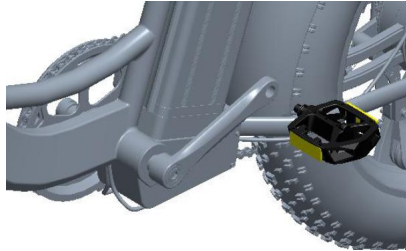
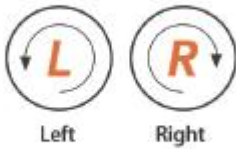

(2) Tighten the right pedal "R" clockwise, Tighten the left pedal "L" counterclockwise.



# 5.Display instructions

## 1.Product name and model name

Intelligent LCD display for e-bike; model: YL81C.

## 2.Specifications

- 36V/48V power supply
- Rated working current 15mA
- Maximum working current 30mA
- Leakage current at power-off <1uA
- Working current at the supply controller end 50mA
- Working temperature -20~60°C
- Storage temperature -30~70°C

## 3.Appearance and dimension



## 4.Function overview and functional area layout

### 4.1 Function overview

Display YL81C provides a variety of functions to meet the riding needs of users, including:

- Battery level indicator
- Assist level adjustment and indication
- Headlight indicator
- Speed indicator (including real-time speed, maximum speed (MAXS) and

average speed (AVG))

- Distance indicator (including ODO and trip distance (Trip))
- Error code indicator
- Bluetooth connection indicator (reserved)
- Parameter setting function

## 4.2 Functional area layout





## 4.3 Button definitions

There are three buttons on the operating unit of display YL81C, i.e., the

on/off button , plus button  and minus button .

## 5. General operation

### 5.1 Power on/off

By pressing and holding the button , the display will start to work and the working power supply of the controller will be turned on. In the power-on state, by pressing and holding the button , your e-bike will be powered off. In the power-off state, the display will no longer use the battery power, and its leakage current will be less than 1uA.

- If your e-bike is not used for more than 10 minutes, the display will be automatically powered off.

### 5.2 Display interface

After the display is turned on, the display will show the real-time speed

(km/h) and the trip distance (km) by default. By pressing the button , the information displayed will be switched between the trip distance (km), ODO (km), maximum speed (km/h) and average speed (km/h).

When the distance reaches 9999.9 km, it will be automatically reset to zero.



### **5.3 Push assistance**

By pressing and holding the button , the electric push assistance mode will be enabled. Your e-bike will run at the constant speed of 6km/h.

The display will show level P. By releasing the button , your e-bike will immediately stop power output and return to the state before push assistance.

■ The push assistance function can only be used when you are pushing your e-bike. Please do not use it during riding.

### **5.4 Headlight on/off**

By pressing and holding the button , the controller will turn on the headlights and the display backlight will turn dark. By pressing and holding the button  again, the controller will turn off the headlights and the display backlight will resumes the luminance.

### **5.5 Assist level selection**

By pressing the button , the e-bike assist level will be switched to change the motor output power. The assist levels available for the display include: levels 1-5.

### **5.6 Battery level indicator**

The battery level indicator consists of five segments. When the battery is fully charged, the five segments will be all on. In case of low voltage, the outline of the battery indicator will flash, which means the battery has to be



charged immediately.

## 5.7 Error code indicator

When a fault occurs in the electronic control system of your e-bike, the display will automatically indicate the error code in the distance area in the format of E0\*\*. Detailed definitions of error codes are shown in **Schedule 1**.



- When an error code appears on the display interface, please conduct troubleshooting in time. Otherwise, your e-bike will not work normally.

## 6. General setting

- All parameters can only be set when your e-bike stops.



The steps for general setting are as follows:

In the power-on state, when the display shows the speed of 0,

### 6.1 Trip distance reset



Press and hold the buttons  and  at the same time for more than 2 seconds to reset the trip distance.

### 6.2 Factory reset

dEF refers to factory reset. dEF-n represents not to restore factory settings, and dEF-y represents to restore factory settings. Press and hold the buttons  and  at the same time for more than 2 seconds to enter the factory reset interface, and press the button  to select a parameter.



### 6.3 Speed limit setting

P3 represents the speed limit setting option. The adjustable range is 10~40km/h. Press the button  to enter the parameter modification

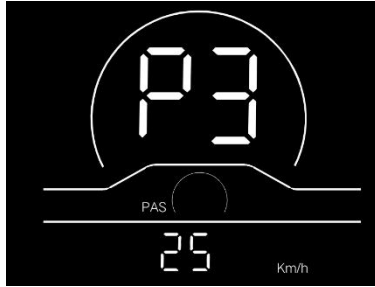
interface. Press the button  for parameter selection. Press the button  to save the parameter and return to the selection interface of general setting options.



### 6.4 Metric/imperial system setting

P4 refers to the metric/imperial system setting option. 00 represents the metric system, and 01 represents the imperial system. Press the button  to enter the parameter modification interface. Press the button  for parameter selection. Press the button  to save the parameter and return to the selection interface of general setting options.

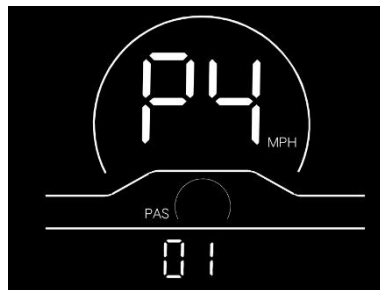
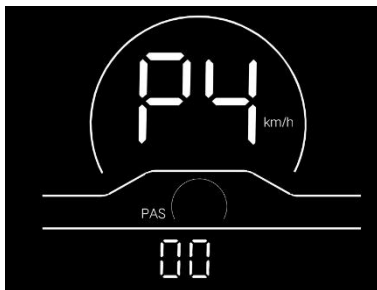

## Schedule 1 Error Code Definitions

Error codes for protocols YL-01 and YL-02:			
Error codes for protocols YL-01 and YL-02:	Definition	Error codes for protocols YL-01 and YL-02:	Definition
E001	Controller Abnormality	E004	Throttle Abnormality
E002	Communication	E005	Brake Abnormality
E003	Motor Hall Signal	E006	Motor Phase
Error codes for protocols YL-05, KDS and YL-J:			
Error codes for protocols YL-01 and YL-02:	Definition	Error codes for protocols YL-01 and YL-02:	Definition
E021	Current Abnormality	E024	Motor Hall Signal
E022	Throttle Abnormality	E025	Brake Abnormality
E023	Motor Phase	E030	Communication

## 6. Battery

● How far a fully charged battery can go? That depends on the loading weight, road condition and battery capacity. But in the same condition, average speeds can continuous longer travel range.

● When storing the battery for a longer time, (during winter time) it is important to place the fully charged battery in a dry place.

● Attention: The battery should be re-charged once every 2-3 month when it is not used.

### **WARNING:**

● Keep the battery out of reach for children.

● Never try to open the battery.

● Only use the ENGWE supplied battery. Do not use a battery from any other different product models.

● If the battery is damaged because it has been dropped somewhere or biking accident, there may be a risk of electrolytes leakage. Beware of chemical burns! And immediately stop using the damaged battery.

● Do not touch the battery without a cloth or gloves and make sure no acid touches your eyes.

● Do not store the battery in temperatures above 95°F or below 23°F.

- Do not allow the battery to run down completely before charging. Charge the battery before storing the product. If the battery is completely empty, it may cause the battery to no longer charge.

- Charge a new battery for at least 4-6 hours before you use it in your product for the first time. Never charge the battery too long per time. Overheating or undercharging the battery may shorten battery life and decrease product run time.

### **IMPORTANT: BATTERY DISPOSAL**

- Battery must be recycled or disposed of in an environmentally sound manner.

- Do not dispose of the battery in a fire. The battery may explode or leak.

- Do not dispose of a battery in your regular household trash.

## 7.Charging

●You can charge the bike directly, or you can remove the battery for charging.

●The RED light indicates it is in charging and GREEN light indicates the battery is fully charged. (Please put off plug from wall)Usually the charging time is 4-6 hours depends on the battery capacity remain.

### **WARNING:**

●Charging time over 10 hours is prohibited, please kept it away from high temperature environment and stores it in a cool place.

●Please make sure that the battery charger and charging plug are always kept dry and never get wet.

●The charger should only be cleaned with a dry cloth. Never use a wet cloth, oil or any other liquid.

●Do not connect positive and negative terminals.

●Stop the charging procedure immediately if you notice anything unusual.

●It is strictly forbidden to cut the battery charging and discharging lines.

●It is strictly forbidden to disassemble the battery box or modify the internal structure and protection board of the lithium battery.

●It is strictly forbidden to disassemble the battery box or modify the internal structure and protection board of the lithium battery.

●After using the battery, please charge it within 12 hours.

If the product has problems with the following forms during the protection period, we will provide customer service as part of the product quality guarantee.

## **8.Warranty policy**

Dear customer !

Thank you for purchasing ENGWE series products !

Warranty service:

Please enter into the official website <https://engwe-bikes.com/> to view the warranty policy of Engwe.

After purchasing Engwe products, please kindly contact Engwe after-sales service for help when there is a quality issue, which means that you can contact customer service of the seller where you buy your e-bike from.

Please provide your order number, purchase interface, videos of the issue.