

Installation & Operation Manual

Nat. Gas Model

VFLDB24L-EN
VFLDB36L-EN
VFLDB48L-EN
VFLDB60L-EN

VFLDB24B-EN
VFLDB36B-EN
VFLDB48B-EN
VFLDB60B-EN



Propane Model

VFLDB24L-EP
VFLDB36L-EP
VFLDB48L-EP
VFLDB60L-EP

VFLDB24B-EP
VFLDB36B-EP
VFLDB48B-EP
VFLDB60B-EP

WARNING: If the information in this manual is not followed exactly, a fire or explosion may result causing property damage, personal injury, or loss of life.

- Do not store or use gasoline or other flammable vapors and liquids in the vicinity of this or any other appliance.
- **WHAT TO DO IF YOU SMELL GAS**
 - Do not try to light any appliance.
 - Do not touch any electrical switch; do not use any phone in your building.
 - Immediately call your gas supplier from a neighbor's phone. Follow the gas supplier's instructions.
 - If you cannot reach your gas supplier, call the fire department.
- Installation and service must be performed by a qualified installer, service agency, or the gas supplier.

WARNING: Improper installation, adjustment, alteration, service, or maintenance can cause injury or property damage. Refer to this manual for correct installation and operational procedures. For assistance or additional information consult a qualified installer, service agency, or the gas supplier.

WARNING: This appliance has been specifically tested and design certified for installation only in a solid-fuel burning fireplace, including factory-built UL127 fireplaces and masonry fireplaces, or in a listed ventless firebox.

WARNING: This is an unvented gas-fired heater. It uses air (oxygen) from the room in which it is installed. Provisions for adequate combustion and ventilation air must be provided. Refer to Air for Combustion and Ventilation section on pages 6 through 8 of this manual.

INSTALLER: Leave this manual with the appliance.
CONSUMER: Retain this manual for future reference.

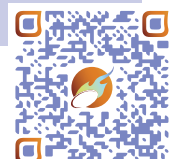

table of contents

1	<i>Safety Information</i>	<i>1</i>
2	<i>Product Identification</i>	<i>4</i>
3	<i>Specifications</i>	<i>5</i>
4	<i>Air for Combustion and Ventilation</i>	<i>6</i>
5	<i>Installation</i>	<i>9</i>
	Installation and Clearances	10
	Minimum Noncombustible Material Clearances	10
	Vented Installation.	12
	Installing Gas Supply.	13
	Installing Opalescence Burner.	14
	Checking Gas Connections	17
6	<i>Operation</i>	<i>18</i>
	Multifunction Burner Remote Operation	18
	LED Lighting Operation Instructions	22
	Operating Instructions Label	24
	Rating Plate Example	25
7	<i>Replacement Parts</i>	<i>26</i>
8	<i>Wiring Diagram</i>	<i>28</i>
9	<i>Maintenance</i>	<i>29</i>
10	<i>Troubleshooting</i>	<i>30</i>
11	<i>Warranty Information</i>	<i>32</i>

welcome

Thank you for purchasing this Mason-Lite Opalescence Vent-Free Burner. We are proud to offer this quality product to add beauty and heating efficiency into your home.

The Opalescence should be installed and used as an unvented supplemental heating appliance. This owner's manual provides complete instructions for safely installing, operating, and maintaining your Opalescence. Read and save these instructions. Pay close attention to all safety and operating instructions. Refer to this manual often to ensure proper safety and operation.

For easy reference, record the product information.

<p>Model Number: _____</p> <p>Date Purchased: _____</p> <p>Where Purchased: _____</p>
--

<p>Installer: Place Serial Number label here.</p>
--

**If you have a question or problem,
call 1-800-345-7078
or visit mason-lite.com**

1 safety information

⚠️ WARNINGS

⚠️ WARNING: Read this owner's manual carefully and completely. Improper installation, use, adjustment, servicing, and maintenance of this heater can cause property damage, serious injury or death from burns, fire, explosion, electrical shock, and carbon monoxide poisoning. Installation and service must be performed by a qualified installer, service agency or the gas supplier.

⚠️ DANGER: Carbon monoxide poisoning may lead to death!

Carbon Monoxide Poisoning: Early signs of carbon monoxide poisoning resemble the flu, with headaches, dizziness, or nausea. If you have these signs, the heater may not be working properly. Get fresh air at once! Have heater serviced. Some people are more affected by carbon monoxide than others. These include pregnant women, people with heart or lung disease or anemia, those under the influence of alcohol, and those at high altitudes.

Natural Gas and Liquid Propane/LP Gas: Natural gas and Liquid Propane/LP gas is odorless. An odor-making agent is added to the gas. The odor helps you detect a gas leak. However, the odor added to the gas can fade. Gas may be present even though no odor exists.

Make certain you read and understand all Warnings. Keep this manual for reference. It is your guide to safe and proper operation of this heater.

⚠️ WARNING: This appliance is equipped for either Natural Gas or Liquid Propane (LP) gas. Only use the type of gas indicated on the rating plate. Field conversion for use with other gases is not permitted.

⚠️ WARNING: Any change to this heater or its controls can be dangerous.

⚠️ WARNING: FIRE, EXPLOSION, AND ASPHYXIATION HAZARD

Improper adjustment, alteration, service, maintenance, or installation of this heater or its controls can cause death or serious injury.

Read and follow instructions and precautions in User's Information Manual provided with this heater.

⚠️ WARNING: This product can expose you to chemicals including carbon monoxide, lead and lead compounds, which are known to the State of California to cause cancer, birth defects or other reproductive harm. For more information, go to www.P65Warnings.ca.gov.

This appliance is intended for supplemental heating.

1. If you smell gas
 - Shut off gas supply
 - Do not try to light any appliance
 - Do not touch any electrical switch; do not use any phone in your building
 - Immediately call your gas supplier from a neighbor's phone. Follow the gas supplier's instructions
 - If you cannot reach your gas supplier, call the fire department
2. Due to high temperatures, this appliance should be located out of traffic and away from furniture/draperies.
3. Children and adults should be alerted to the hazard of high surface temperatures and should stay away to avoid burns or clothing ignition.
4. Young children should be carefully supervised when in the same room with this appliance.
5. Do not place clothing or any flammable material on or near your vent-free gas appliance. Matches, paper, garbage or any other material must not be thrown on top of the burner or into the flame.
6. Any safety screen, guard, or barrier removed for servicing this appliance must be replaced prior to operating the heater.
7. Installation and repair should be done by a qualified service person. The appliance should be inspected before use and at least annually by a professional service person.

More frequent cleaning may be required due to excessive lint from carpeting, bedding material etc. It is imperative that control compartments, burners, and circulating air passageways of the appliance be kept clean.

8. Do not block air intakes and maintain adequate clearances to enable the free flow of air.
9. This heater shall not be installed in a room or space unless the required volume of indoor combustion air is provided by the method described in the National Fuel Gas Code, ANSI Z223.1/NFPA 54, the International Fuel Gas Code, or applicable local codes.
10. This heater needs fresh, outside air ventilation to run properly. This heater has an oxygen depletion sensor (ODS) pilot light safety system. The ODS shuts down the heater if not enough fresh air is available. See *Air for Combustion and Ventilation*, pages 6 through 8. If heater keeps shutting off, see Troubleshooting, pages 30 and 31.
11. Provide adequate clearances for servicing and operation.
12. Do not install this appliance directly on combustible flooring. Be certain that the top surface of the combustible flooring material (i.e. carpet, tile, etc.) is not too close to this gas appliance. If this appliance is at floor level or less than 6" above the top surface of the flooring material, there must be at least 12" of non-combustible material between the base of the fireplace and any surface of the combustible flooring.
13. At least 10"-12" of noncombustible or heat-resistant material is required above the fireplace. A fireplace hood will be required to act as a heat deflector in protecting combustible fireplace surroundings (facing and/or mantel) if certain minimum clearances cannot be met (see the "Clearances to Combustibles" section).
14. All models of this heater have an input rating of more than 10,000 BTU/hr and shall not be installed in a bedroom or bathroom (ANSI Z21.11.2).
15. **WARNING:** Failure to keep the primary air opening(s) of the burner(s) clean may result in sooting and property damage.
16. When installing as a decorative vented appliance, the unit must conform to all local codes or, in the absence of local codes, to the National Fuel Gas Code ANSI Z223.1/NFPA 54.
17. The appliance and its appliance main gas valve must be disconnected from the gas supply piping system during any pressure testing of that system at test pressure in excess of ½ psi (3.5 kPa). The appliance must be isolated from the gas supply piping system by closing its equipment shutoff valve during any pressure testing of the gas supply piping system at test pressure equal to or less than ½ psi (3.5 kPa).
18. Keep the area around your gas appliance clear of combustible materials, gasoline, and any other flammable vapors/liquids. Be especially cautious if the gas appliance is installed in a basement or converted garage.
19. Do not use this appliance if any part has been underwater. Immediately call a qualified professional service technician to inspect the appliance and to replace a part of the control system and any gas control which has been underwater.
20. Perform a periodic visual check of the pilot and burner flame.
21. **WARNING:** This appliance is for installation only in a solid-fuel burning masonry or UI 127 factory-built fireplace or in a listed ventless firebox enclosure. It has been design certified for these installations.

Exception: DO NOT Install this appliance in a factory-built fireplace that includes instructions stating it has not been tested or should not be used with unvented gas logs.
22. **WARNING:** Before installing in a solid-fuel burning fireplace, the chimney flue and firebox must be cleaned of soot, creosote, ashes, and loose paint by a qualified chimney cleaner.
23. **WARNING:** Do not allow fans to blow directly into the fireplace. Avoid any drafts that alter burner flame patterns.

24. **WARNING:** Do not use a blower insert, heat exchanger insert or other accessory not approved for use with this heater.
25. For unvented installation in bedrooms or bathrooms, the burner base assembly must be secured to the fireplace or the firebox floor in accordance with these installation instructions, as applicable.
26. A fireplace screen must be in place when this appliance is operating, unless other provisions for combustion air are provided, the screen has an opening(s) for introduction of combustion air.
27. It is important to use this appliance in the minimum size fireplace as indicated in the “Minimum Firebox Size” section showing the height, width, and depth.
28. Solid fuels must not be burned in the fireplace where this unvented gas appliance is installed.
29. Glass doors must be fully open when this vent-free gas appliance is operating. Do not operate this appliance if glass doors are closed. This can lead to sooting, burner outages, and possible glass explosion, causing damage or injury.
30. Any outside air ducts and/or ash dumps located on the floor or walls of the fireplace must be permanently sealed shut before the installation. Use heat-resistant sealant. Do not seal chimney flue damper.
31. State and local codes may only allow operation of this appliance in a vented configuration. Check your state or local codes.
32. If any soot appears on the appliance or other areas of the fireplace in which this appliance is installed, shut the system off and call a qualified professional service technician, vent-free gas burner system technician, or your local gas company.
33. This appliance may be installed in an aftermarket, permanently located, manufactured (mobile) home where not prohibited by local codes. Installation of appliances designed for manufactured homes or mobile homes must conform with Manufactured Home Construction and Safety Standards, Title 24 CFR, Part 3280 in the U.S.; or with CAN/CSA Z240 MH, Mobile Housing in Canada; or with ANSI/NCSBCS A225.1/NFPA 501A, Manufactured Home Installations Standard when none of the previously referenced standards are applicable.

⚠ WARNING

FIRE RISK HAZARD / DELAYED IGNITION
High supply pressure will damage the valve / controls.

Disconnect the appliance main gas valve/control from the supply piping when pressure testing that system at pressures in excess of 1/2 psi (3.5 kPa).

Isolate the appliance with its shut off valve during any pressure testing of the supply piping at pressures equal to or less than 1/2 psi (3.5 kPa).



⚠ DANGER

HOT GLASS WILL CAUSE BURNS.
DO NOT TOUCH GLASS UNTIL COOLED.
NEVER ALLOW CHILDREN TO TOUCH GLASS.



2 product identification

- A. Handles
- B. Case
- C. Burner
- D. Gas Valve
- E. Gas Valve Cover
- F. Base
- G. IFC Board
- H. ProFlame Receiver
- I. Pilot
- J. Power Cord
- K. LED Lights
- L. Multifunction Burner Remote
- M. LED Remote

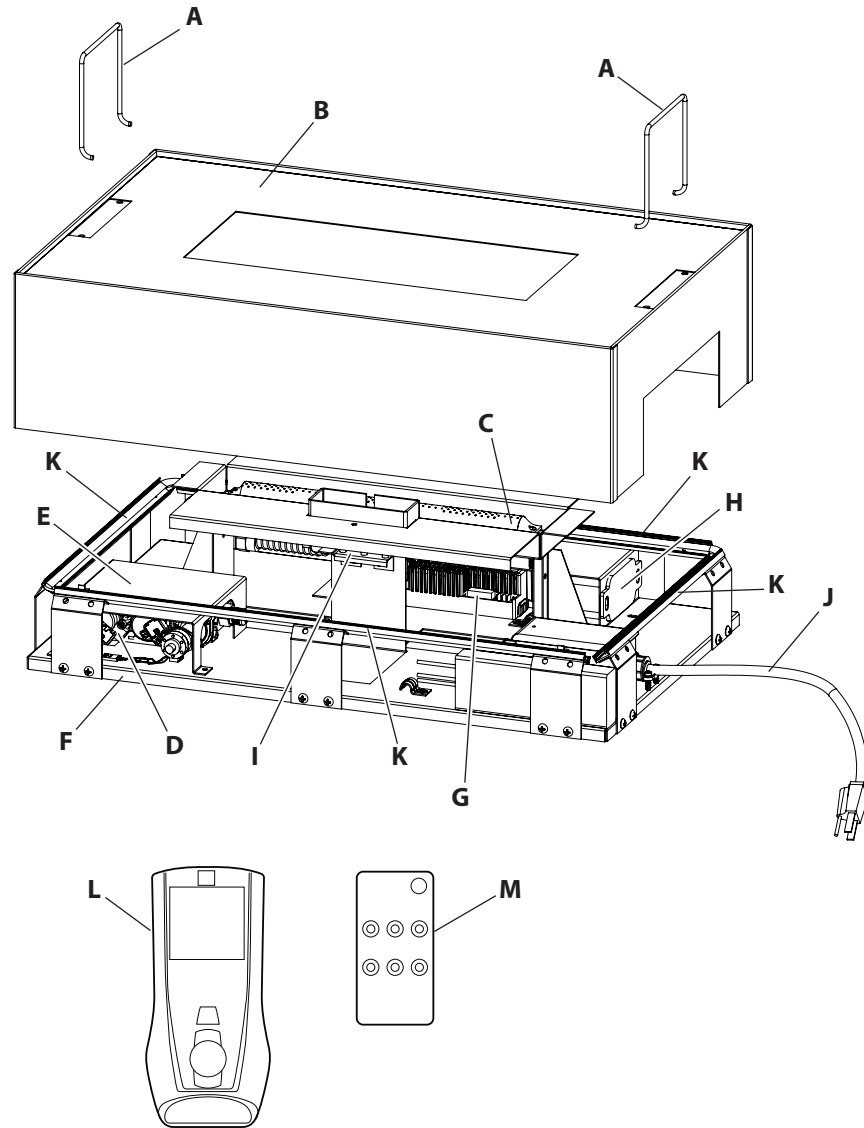

Product Features

Operation

This heater is clean burning. It requires no outside venting. There is no heat loss out a vent or up a chimney. Heat is generated by realistic, dancing yellow flames. This heater is designed for vent-free operation with flue damper closed. State and local codes in some areas prohibit the use of vent-free heaters. You can operate heater as a vented product by opening the flue damper.

Safety Pilot

This heater has a pilot with an Oxygen Depletion Sensor (ODS) safety pilot system. The ODS/pilot is a required feature for vent-free room heaters. The ODS/pilot senses the amount of oxygen available in the room and shuts the burner off if the oxygen drops below 18%.

Figure 2.1 - Opalescence Vent-Free Burner

3 specifications

NG Models	BTU High	BTU Low	Manifold Pressure	Inlet Pressure Minimum	Inlet Pressure Maximum
VFLDB24L-EN	16,000	10,000	3.5" W.C.	5"	10.5"
VFLDB36L-EN	32,000	20,000	3.5" W.C.	5"	10.5"
VFLDB48L-EN	39,500	27,000	3.5" W.C.	7"	10.5"
VFLDB60L-EN	39,500	27,000	3.5" W.C.	7"	10.5"
VFLDB24B-EN	16,000	10,000	3.5" W.C.	7"	10.5"
VFLDB36B-EN	32,000	20,000	3.5" W.C.	5"	10.5"
VFLDB48B-EN	39,500	27,000	3.5" W.C.	5"	10.5"
VFLDB60B-EN	39,500	27,000	3.5" W.C.	5"	10.5"
LP Models					
VFLDB24L-EP	16,000	9,000	10" W.C.	11"	14"
VFLDB36L-EP	32,000	16,000	10" W.C.	11"	14"
VFLDB48L-EP	39,500	18,000	10" W.C.	11"	14"
VFLDB60L-EP	39,500	18,000	10" W.C.	11"	14"
VFLDB24B-EP	16,000	9,000	10" W.C.	11"	14"
VFLDB36B-EP	32,000	16,000	10" W.C.	11"	14"
VFLDB48B-EP	39,500	18,000	10" W.C.	11"	14"
VFLDB60B-EP	39,500	18,000	10" W.C.	11"	14"

Table 1 - Specifications

4 air for combustion and ventilation

⚠ WARNING: This heater shall not be installed in a confined space unless you provide adequate combustion and ventilation air. Read the following instructions to insure proper fresh air for this and other fuel-burning appliances in your home.

All fuel-burning appliances need fresh air for proper combustion and ventilation.

Exhaust fans, fireplaces, clothes dryers, and fuel burning appliances draw air from the house to operate. You must provide adequate fresh air for these appliances. This will insure proper venting of vented fuel-burning appliances.

Providing Adequate Ventilation

The following is excerpts from National Fuel Gas Code. NFPA 54/ANSI Z223.1, Section 5.3, Air for Combustion and Ventilation.

All spaces in homes fall into one of the three following ventilation classifications:

1. Unusually Tight Construction
2. Unconfined Space
3. Confined Space.

The information on pages 6 through 8 will help you classify your space and provide adequate ventilation.

Unusually Tight Construction

The air that leaks around doors and windows may provide enough fresh air for combustion and ventilation. However, in buildings of unusually tight construction, you must provide additional fresh air.

Unusually tight construction is defined as construction where:

- a. **Walls and ceilings exposed to the outside atmosphere have a continuous water vapor retarder with a rating of one perm (6×10^{-11} kg per pa-sec- m^2) or less with openings gasketed or sealed and**
- b. **Weather stripping has been added on openable windows and doors and**
- c. **Caulking or sealants are applied to areas such as joints around window and door frames, between sole plates and floors, between wall-ceiling joints, between wall panels, at penetrations for plumbing, electrical, and gas lines, and at other openings.**

If your home meets all of the three criteria above, you must provide additional fresh air. See *Ventilation Air From Outdoors*, page 8.

If your home does not meet all of the three criteria above, proceed to *Determining Air Flow For Heater Location*, page 7.

Confined and Unconfined Space

The National Fuel Gas Code (ANSI Z223.1, 1992 Section 5.3) defines confined and unconfined spaces.

A confined space is a space where the volume is less than 50 cubic feet per 1,000 Btu per hour (4.8 m^3 per kw) of the aggregate input rating of all appliances installed in that space.

An unconfined space as a space where the volume is at least 50 cubic feet per 1,000 Btu per hour (4.8 m^3 per kw) of the aggregate input rating of all appliances installed in that space.

Rooms communicating directly with the space in which the appliances are installed*, through openings not furnished with doors, are considered a part of the unconfined space.

* Adjoining rooms are communicating only if there are doorless passageways or ventilation grills between them.

Determining Air Flow For Heater Location

Determining if You Have a Confined or Unconfined Space

Use this work sheet to determine if you have a confined or unconfined space.

Space: Includes the room in which you will install heater plus any adjoining rooms with doorless passageways or ventilation grills between the rooms.

1. Determine the volume of the space (length x width x height).

$$\text{Length} \times \text{Width} \times \text{Height} = \text{cu. ft. (volume of space)}$$

Example: Space size 20 ft. (length) x 16 ft. (width) x 8 ft. (ceiling height) = 2560 cu. ft. (volume of space)

If additional ventilation to adjoining room is supplied with grills or doorless openings, add the volume of these rooms to the total volume of the space.

2. Divide the space volume by 50 cubic feet to determine the maximum Btu/Hr the space can support.

$$\frac{\text{_____ (volume of space)}}{\div 50 \text{ cu. ft.}} = \text{(maximum Btu/Hr the space can support)}$$

Example: 2560 cu. ft. (volume of space) ÷ 50 cu. ft. = 51.2 or 51,200 (maximum Btu/Hr the space can support)

3. Add the Btu/Hr of all fuel burning appliances in the space.

Vent-free heater	_____	Btu/Hr
Gas water heater*	_____	Btu/Hr
Gas furnace	_____	Btu/Hr
Vented gas heater	_____	Btu/Hr
Gas fireplace burner	_____	Btu/Hr
Other gas appliances*	_____	Btu/Hr
TOTAL	_____	Btu/Hr

Example:
 Gas water heater 40,000 Btu/Hr
 Vent-free heater 31,500 Btu/Hr
TOTAL 71,500 Btu/Hr

* Do not include direct-vent gas appliances. Direct-vent draws combustion air from the outdoors and vents to the outdoors.

4. Compare the maximum Btu/Hr the space can support with the actual amount of Btu/Hr used.

_____ Btu/Hr (maximum the space can support)

_____ Btu/Hr (actual amount of Btu/Hr used)

Example: 51,200 Btu/Hr (maximum the space can support)

71,500 Btu/Hr (actual amount of Btu/Hr used)

The space in the above example is a confined space because the actual Btu/Hr used is more than the maximum Btu/Hr the space can support. You must provide additional fresh air. Your options are as follows:

- A. Rework worksheet, adding the space of an adjoining room. If the extra space provides an unconfined space, remove door to adjoining room or add ventilation grills between rooms. See *Ventilation Air From Inside Building*, page 8.

- B. Vent room directly to the outdoors. See *Ventilation Air From Outdoors*, page 8.

- C. Install a lower Btu/Hr heater, if lower Btu/Hr size makes room unconfined.

If the actual Btu/Hr used is less than the maximum Btu/Hr the space can support, the space is an unconfined space. You will need no additional fresh air ventilation.

⚠ WARNING: If the area in which the heater may be operated is smaller than that defined as an unconfined space, provide adequate combustion and ventilation air by one of the methods described in the *National Fuel Gas Code, ANSI Z223.1, 1992, Section 5.3* or applicable local codes.

Ventilation Air

Ventilation Air From Inside Building

This fresh air would come from an adjoining unconfined space. When ventilating to an adjoining unconfined space, you must provide two permanent openings: one within 12" of the ceiling and one within 12" of the floor on the wall connecting the two spaces (see options 1 and 2, Figure 4.1). You can also remove door into adjoining room (see option 3, Figure 4.1). Follow the National Fuel Gas Code NFPA 54/ANSI Z223.1, Section 5.3, Air for Combustion and Ventilation for required size of ventilation grills or ducts.

⚠ WARNING: Rework worksheet, adding the space of the adjoining unconfined space. The combined spaces must have enough fresh air to supply all appliances in both spaces.

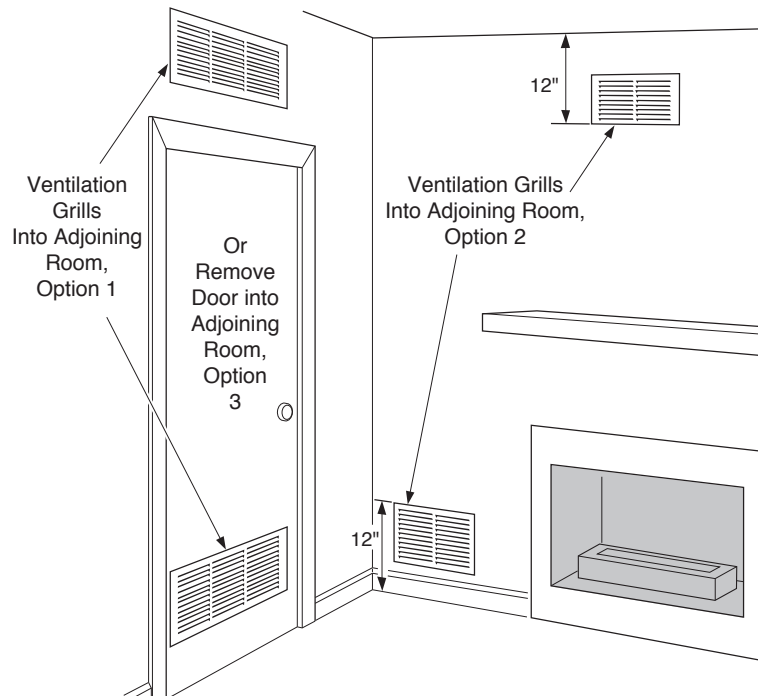

Figure 4.1 - Ventilation Air from Inside Building

Ventilation Air From Outdoors

Provide extra fresh air by using ventilation grills or ducts. You must provide two permanent openings: one within 12" of the ceiling and one within 12" of the floor. Connect these items directly to the outdoors or spaces open to the outdoors. These spaces include attics and crawl spaces.

IMPORTANT: Do not provide openings for inlet or outlet air into attic if attic has a thermostat-controlled power vent. Heated air entering the attic will activate the power vent.

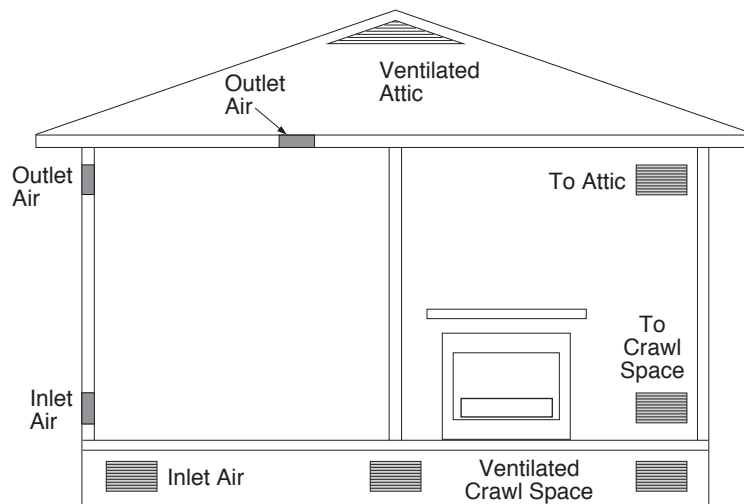

Figure 4.2 - Ventilation Air from Outdoors

5 installation

NOTICE: A qualified service person must install heater. Follow all local codes.

NOTICE: State or local codes may only allow operation of this appliance in a vented configuration. Check your state or local codes.

⚠ WARNING: Before installing in a solid fuel burning fireplace, the chimney flue and firebox must be cleaned of soot, creosote, ashes and loose paint by a qualified chimney cleaner. Creosote will ignite if highly heated. Inspect chimney flue for damage. If damaged, operate heater with flue damper closed.

⚠ WARNING: Seal any fresh air vents or ash clean-out doors located on floor or wall of fireplace. If not, drafting may cause pilot outage or sooting. Use a heat-resistant sealant. Do not seal chimney flue damper.

⚠ WARNING: Never install the heater

- In a bedroom or bathroom unless installed as a vented appliance (see page 9)
- In a recreational vehicle
- Where curtains, furniture, clothing, or other flammable objects are less than 36 inches from the front, top, or sides of the heater
- In high traffic areas
- In windy or drafty areas

⚠ CAUTION: This heater creates warm air currents. These currents move heat to wall surfaces next to heater. Installing heater next to vinyl or cloth wall coverings or operating heater where impurities in the air (such as tobacco smoke) exist, may discolor walls.

IMPORTANT: Vent-free heaters add moisture to the air. Although this is beneficial, installing heater in rooms without enough ventilation air may cause mildew to form from too much moisture. See *Air for Combustion and Ventilation*, pages 6 through 8.

Check Gas Type

⚠ WARNING: This appliance is equipped for either Natural Gas or Liquid Propane (LP) gas. Only use the type of gas indicated on the rating plate. Field conversion for use with other gases is not permitted.

Use only the gas type indicated on the heater's rating plate. If your gas supply is different, do not install heater. Call dealer where you bought heater for proper type heater.

Installation and Clearances (Vent-Free Operation Only)

⚠ WARNING: Maintain the minimum clearances. If you can, provide greater clearances from floor, ceiling, and adjoining wall.

Carefully follow the clearances to combustible materials specified in this manual. This will ensure safe installation into a masonry, U.L.-listed manufactured fireplace, or AGA design certified vent free firebox listed for use with these models.

Minimum Clearances to Combustibles

- A. Provide at least 12 inches clearance from the side of the fireplace opening to combustible walls, furniture, or other objects.
- B. Provide at least 36 inches clearance from the top of the fireplace opening to the ceiling.
- C. Provide at least 36 inches clearance from the front of the fireplace opening to combustible objects.
- D. Provide at least 1 inch clearance from the back of the burner

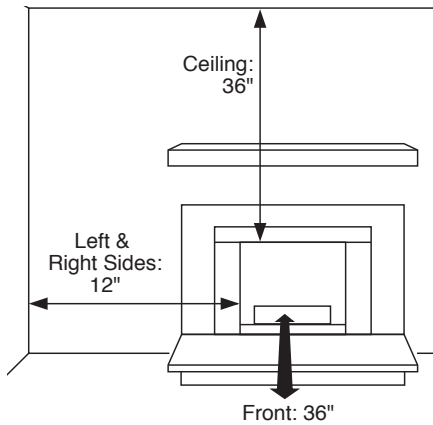

Figure 5.1 - Minimum Clearance to Wall and Ceiling

Minimum Clearances to Combustible Materials (inches) All Models				
Front	Ceiling	Left	Right	
36"	36"	12"	12"	

Table 2 - Minimum Clearances to Combustible Materials

Minimum Firebox Size				
NG/LP	Front Width	Rear Width	Depth	Height
24	24"	24"	15"	20"
36	36"	36"	15"	20"
48	48"	48"	15"	20"
60	60"	60"	15"	20"

Table 3 - Minimum Firebox Size

NOTICE: Manual control heaters may be used as a vented product. If so, you must always run heater with chimney flue damper open. If running heater with damper open, non-combustible material above fireplace opening is not needed. Go to Vented Installation, page 12.

Minimum Noncombustible Material Clearances

If Not Using Mantel

You must have noncombustible material(s) above the fireplace opening. Noncombustible materials (such as slate, marble, tile, etc.) must be at least 5/8-inch thick. Do not install sheet metal over combustible material. With sheet metal, you must have noncombustible material behind it. Noncombustible material must extend at least 22.5 inches up (for all models). If noncombustible material is less than 22.5 inches, you must install a fireplace hood. See Figures 5.3, page 11 for minimum clearances.

IMPORTANT: If you cannot meet these minimum clearances, you must operate heater with chimney flue damper open. Go to *Vented Installation*, page 12.

If Using Mantel

You must have noncombustible material(s) above the fireplace opening. Noncombustible materials (such as slate, marble, tile, etc.) must be at least 5/8-inch thick. Do not install sheet metal over combustible material. With sheet metal, you must have noncombustible material behind it. Noncombustible material must extend at least 22.5 inches up (for all models). If noncombustible material is less than 22.5 inches, you must install the fireplace hood. Even if noncombustible material is more than 22.5 inches, you may need a hood accessory to deflect heat away from your mantel shelf. See Figures 5.3, page 11 for minimum clearances.

IMPORTANT: If you cannot meet these minimum clearances, you must operate heater with chimney flue damper open. Go to *Vented Installation*, page 12.

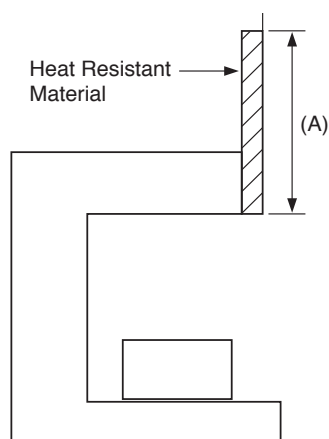

Figure 5.2 - Heat Resistant Material (Slate, Marble, Tile, etc.) Above Fireplace

Mantel Clearances

In addition to meeting non-combustible material clearances, you must also meet required clearances between fireplace opening and mantel shelf. If you do not meet the clearances listed below, you will need a hood.

Determining Minimum Mantel Clearance

If you meet minimum clearance between mantel shelf and top of fireplace opening, a hood is not required (see Figure 5.3).

If your installation does not meet the above minimum clearances, you must:

- Operate the burner only with the flue damper open, OR
- Raise the mantel to an acceptable height, OR
- Remove the mantel.

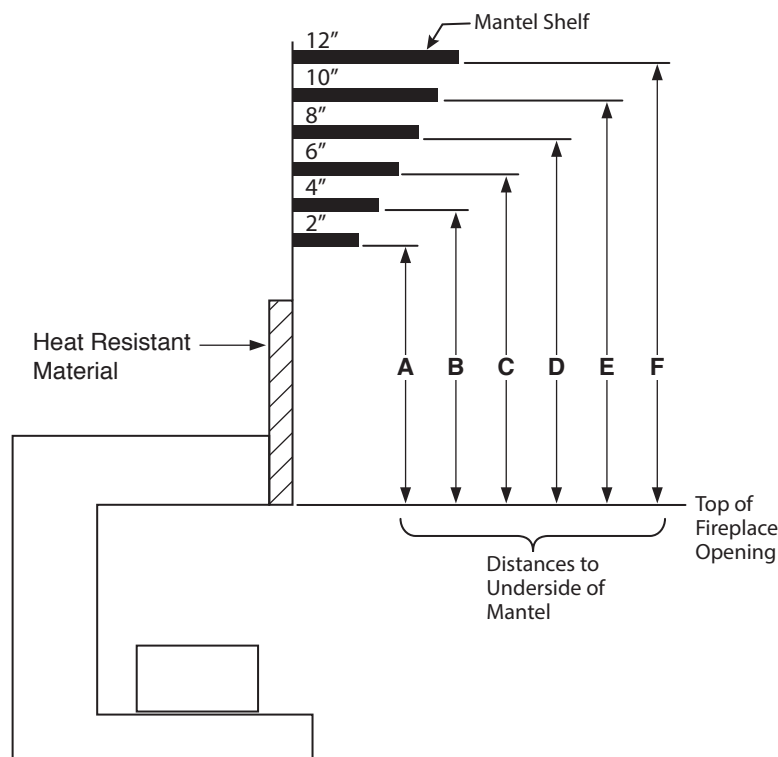

Figure 5.3 - Minimum Mantel Clearances Without Using Hood

Minimum Clearances to Underside of Mantel (without hood)						
Model	Dimensions in Inches					
	A	B	C	D	E	F
24	18	20	22	24	26	28
36	18	20	22	24	26	28
48	18	20	22	24	26	28
60	18	20	22	24	26	28

Table 4 - Minimum Clearances to Underside of Mantel

Vented Installation

State and local codes may only allow operation of this appliance in a vented configuration. Check your state or local codes.

When installing as a decorative vented appliance, the unit must conform to all local codes or, in the absence of local codes, to the National Fuel Gas Code ANSI Z223.1/NFPA 54.

Installing Damper Clamp Accessory for Vented Operation

NOTE: When used as a vented heater, appliance must be installed only in a solid-fuel burning fireplace with a working flue and constructed of noncombustible material.

You may use this heater as a vented product. There are three reasons for operating your heater in the vented mode.

1. The fireplace does not meet the clearance to combustibles requirements for vent-free operation.
2. State or local codes do not permit vent-free operation.
3. You prefer vented operation.

If reasons 1 or 2 apply, you must permanently open the chimney flue damper and provide a minimum flue opening. There are various methods for doing this. Some methods may be restricted in your area. Check all local codes that apply to you.

For your convenience, a damper clamp is provided with this heater. Use this clamp where not prohibited by local codes. This will insure vented operation (see Figure 5.7). The damper clamp will keep the damper open, allowing the heater to vent up the fireplace flue.

Use the 3" adjustable bolt to adjust the damper to the correct opening, based on the venting chart in Table 3.

Chimney Damper Openings for Vented Operation

Free Opening Area of Chimney Damper for Factory-Built Fireplaces				
Chimney Height (ft)*	Appliance Input Rating (kBTU/hr)			
	16k	20k	30k	40k
	Minimum Opening inches ²			
10	11.3	11.3	16.6	22.11
15	8.6	8.6	12.6	17.3
20	7.5	7.5	10.8	14.5
25	6.6	6.6	9.6	12.6
30	6.2	6.2	9.1	11.3
35	5.7	5.7	8	10.8
40	5.6	5.6	7.5	10.2

Free Opening Area of Chimney Damper for Masonry-Built Fireplaces				
Chimney Height (ft)	Appliance Input Rating (kBTU/hr)			
	16k	20k	30k	40k
	Minimum Opening inches ²			
6	17.6	17.6	25.7	33.8
8	16.5	16.5	23.7	31.2
10	15.1	15.1	21.7	28.7
15	14.1	14.1	19.9	26.1
20	12.9	12.9	18.5	23.7
30	12.2	12.2	16.9	21.6

* Height is from hearth to top of chimney and the minimum height is 10 feet.

Table 3 - Chimney Damper Openings for Vented Operation

Area of Various Standard Round Flues	
Diameter	Area (sq. ins.)
5"	20 Sq. Inches
6"	29 Sq. Inches
7"	39 Sq. Inches
8"	51 Sq. Inches

Table 4 - Area of Round Flues

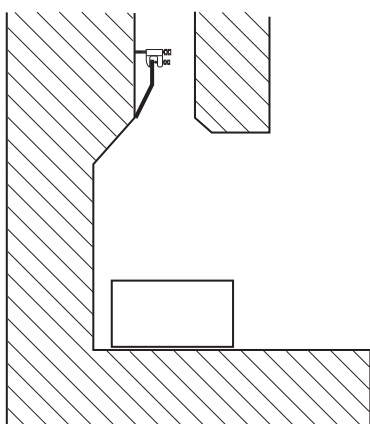
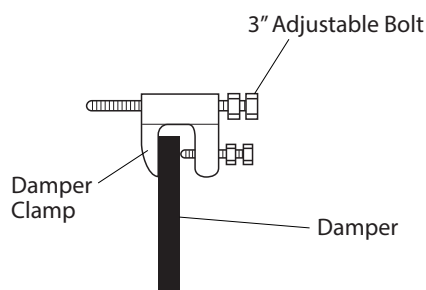

Masonry Fireplace

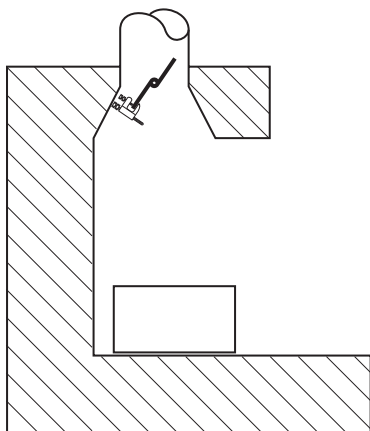

Manufactured Fireplace

Figure 5.7 - Attaching Damper Clamp

Installing Gas Supply

NOTICE: A qualified service person must connect heater to gas supply. Follow all local codes.

Installation Items Needed

Before installing heater, make sure you have the items listed below.

- Piping (check local codes)
- Approved pipe joint sealant (resistant to LP gas)
- Manual shutoff valve *
- Test gauge connection *
- Sediment trap
- Tee joint
- Pipe wrench

* An A.G.A. design-certified manual shutoff valve with 1/8" NPT tap is an acceptable alternative to test gauge connection. Purchase the optional A.G.A. design-certified manual shutoff valve from your dealer.

WARNING: Never connect heater to private (non-utility) gas wells. This gas is commonly known as well-head gas.

CAUTION: Use only new, black iron or steel pipe. Internally-tinned copper tubing may be used in certain areas. Check your local codes. Use pipe of 1/2" diameter or greater to allow proper gas volume to heater. If pipe is too small, undue loss of pressure will occur.

Installation must include a manual shutoff valve, union, and plugged 1/8" NPT tap. Locate NPT tap within reach for test gauge hook up. NPT tap must be upstream from heater (see Figure 5.8).

Apply pipe joint sealant lightly to male threads. This will prevent excess sealant from going into pipe. Excess sealant in pipe could result in clogged heater valves.

CAUTION: Use pipe joint sealant that is resistant to liquid petroleum (LP) gas.

Install sediment trap in supply line as shown in Figure 5.8. Locate sediment trap where it is within reach for cleaning. Locate sediment trap where trapped matter is not likely to freeze. A sediment trap traps moisture and contaminants. This keeps them from going into heater controls. If sediment trap is not installed or is installed wrong, heater may not run properly.

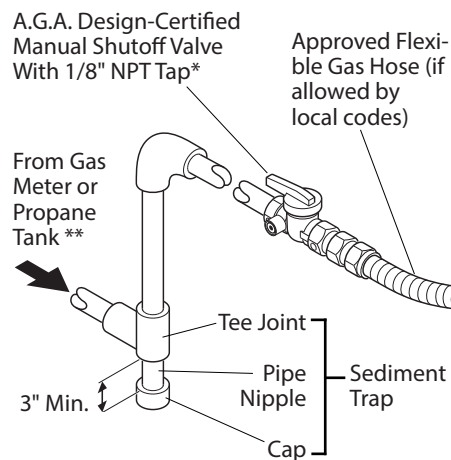

Figure 5.8 - Gas Connection

* Purchase the optional A.G.A. design-certified manual shutoff valve from your dealer.

** See *Specifications*, page 5, for minimum inlet pressure for purpose of input adjustment for each burner model.

Installing Opalescence Burner

⚠ WARNING: Installation should be done by a qualified service person. The appliance should be inspected before use and at least annually by a professional service person.

⚠ CAUTION: Do not pick up heater base assembly by the burner. This could damage heater. Only handle assembly by base.

Do not separate the aluminum information tags from the heater. These tags contain important information about operating and servicing your heater.

Installation Items Needed

- Adjustable wrench
- Angled cutting pliers
- Safety glasses and gloves
- Approved pipe joint sealant (resistant to LP gas)
- Manometer
- Leak detection fluid (non-corrosive) or electronic gas detector
- Appropriate gas supply line parts

Step 1

Clean the fireplace/firebox of any dirt and debris. Provide openings in the fireplace/firebox for the electrical cord and the inlet gas line.



Step 2

Using angled cutting pliers, cut the shipping wire that holds the LED light tracks in place. Discard this wire.

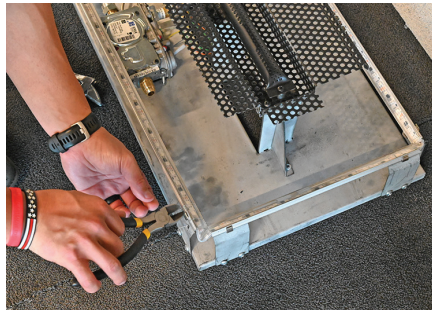

Step 3

Place the burner base assembly in the fireplace/firebox. Orient the burner assembly so the electrical cord and gas valve is closest to the electrical opening and gas inlet hose opening. Center the base front to back and side to side.



Step 4

Unclip and remove the LED light track that runs above the burner's gas valve. This will allow you best access for connecting the inlet gas line.

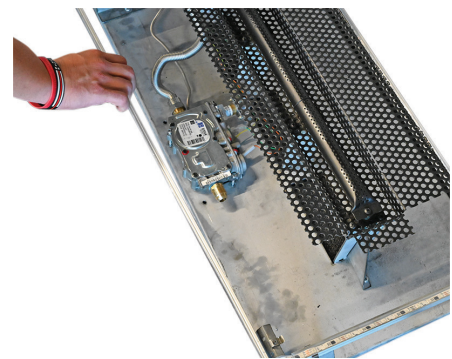

Step 5

Lightly apply pipe joint sealant to the male threads of the gas valve inlet connector. Connect an approved flexible gas hose to the burner assembly gas valve. Tighten the flexible gas hose connector with an adjustable wrench.

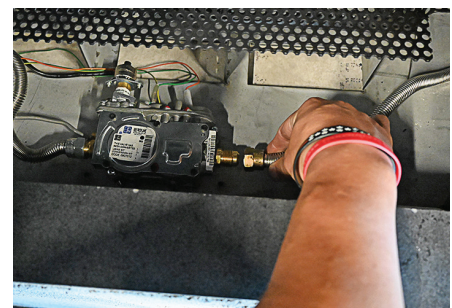

Step 6

Using Six-Foot Power Cord: Feed the power cord through the opening provided in the fireplace/firebox. Plug the cord into a 110v receptacle.



Hard Wire Installation:

⚠️ WARNING: Hard-wired electrical connection should be done by a qualified electrician.

The electrician will do the following: Remove the electrical box cover. Disconnect the pigtail wire nuts. Remove the six-foot electrical cord. Feed line voltage electrical wire through the fireplace wall and to the electrical box. Connect the burner wires to the correct line voltage wires and tighten with wire nuts. Replace the electrical box cover.

Step 7

Syncing and Initializing the Remote System

The remote and receiver are synced at the factory. Steps 4 and 5 below may not be needed. If you need to re-sync the Multifunction Burner Remote and the ProFlame Receiver, follow steps 4 and 5 below.

1. Remove the ProFlame Receiver. Open the battery backup cover. Install four AA batteries and replace the cover.
2. Open the battery cover on the Multifunction Burner Remote. Install three AAA batteries and replace the cover.
3. Set the ProFlame Receiver slide switch to the REMOTE position.

IMPORTANT: Only operate this burner system in the REMOTE position. Never set the slide switch to either OFF or ON.

4. Press and release the "PRG" button on the ProFlame Receiver. The Receiver will beep three times to indicate it is ready to sync with the Multifunction Burner Remote within the next 10 seconds.
5. Quickly take the Multifunction Burner Remote and press the ON button. The ProFlame Receiver will beep four times to indicate the Remote's command is accepted. The ProFlame Receiver set to the matching code of the Multifunction Burner Remote. The system is now synced and initialized.

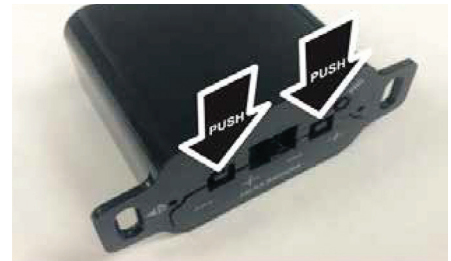

Continued

Step 8

Test the LED lights. Make sure the power cord is plugged in or a hard-wired electrical connection is made (see Step 6, page 15). Make sure batteries are installed in the LED remote. Press the LED remote ON/OFF button. The LED lights should turn on.



Step 9

Check all gas connections between the gas meter (NG models) or supply tank (Liquid Propane/LP gas) to the burner system.

Follow the instruction under *Checking Gas Connections*, page 17.

IMPORTANT: This must be done before moving to Step 10.

Step 10

Grasp the handles on each end of the case. Lift the case and carefully place the case over the burner assembly. Make sure the cover is correctly centered on the burner assembly. The burner tube should be centered in the cover opening.

IMPORTANT: Larger units may require two people to install the case.



Step 11

Wearing protective gloves, pour the 1/2" reflective glass media over the top of the burner tube and the perforated metal of the case.

IMPORTANT: For proper burner ignition, have no more than one layer of glass over the top of the burner tube. Do not cover the pilot shield or any of the burner ports with glass media. You may need to move pieces of glass off the burner ports (holes). It is acceptable to have glass on the burner as long as the ports are not blocked. Keep the pilot and pilot shield clear of all debris.

Follow the chart below to ensure you use the proper amount of glass media.



Glass Media Amount	
Burner Size	Glass Media To Use
24"	10 Pounds
36"	15 Pounds
48"	20 Pounds
60"	25 Pounds

Table 5 - Glass Media

Checking Gas Connections

⚠ WARNING: Test all gas piping and connections for leaks after installing or servicing. Correct all leaks at once.

⚠ WARNING: Never use an open flame to check for a leak. Apply a mixture of liquid soap and water to all joints. Bubbles forming show a leak. Correct all leaks at once.

Pressure Testing Gas Supply Piping System

Test Pressures in Excess of 1/2 PSIG

1. Disconnect burner and its individual manual shutoff valve from gas supply piping system. Pressures in excess of 1/2 psig will damage the burner regulator.
2. Cap off open end of gas pipe where manual shutoff valve was connected.
3. Pressurize supply piping system by either using compressed air or opening main gas valve located on or near gas meter (NG models) or opening supply tank valve (Liquid Propane/LP models).
4. Check all joints of gas supply piping system. Apply mixture of liquid soap and water to gas joints. Bubbles forming show a leak.
5. Correct all leaks at once.
6. Re-connect burner and manual shutoff valve to gas supply. Check re-connected fittings for leaks.

Test Pressures Equal To or Less Than 1/2 PSIG

1. Close manual shutoff valve (see Figure 5.9).
2. Pressurize supply piping system by either using compressed air or opening main gas valve located on or near gas meter (NG models) or opening supply tank valve (Liquid Propane/LP models).
3. Check all joints from gas meter to manual shutoff valve (see Figure 5.10). Apply mixture of liquid soap and water to gas joints. Bubbles forming show a leak.
4. Correct all leaks at once.

Pressure Testing Burner Gas Connections

1. Open manual shutoff valve (see Figure 5.9).
2. Open main gas valve located on or near gas meter (NG models) or open supply tank valve (Liquid Propane/LP models).
3. Make sure burner and pilot are OFF.
4. Check all joints from manual shutoff valve to burner assembly gas valve (see Figure 5.10). Apply mixture of liquid soap and water to gas joints. Bubbles forming show a leak.
5. Correct all leaks at once.
6. Test light the burner (see *Operation*, pages 18). Check all other internal gas joints for leaks.
7. Turn off burner (see *Turning OFF the Burner*, page 19).

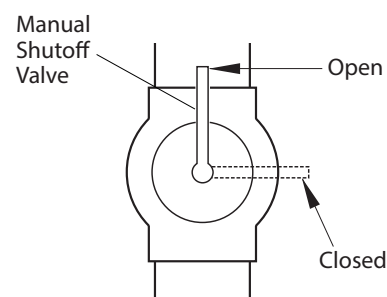

Figure 5.9 - Manual Shutoff Valve

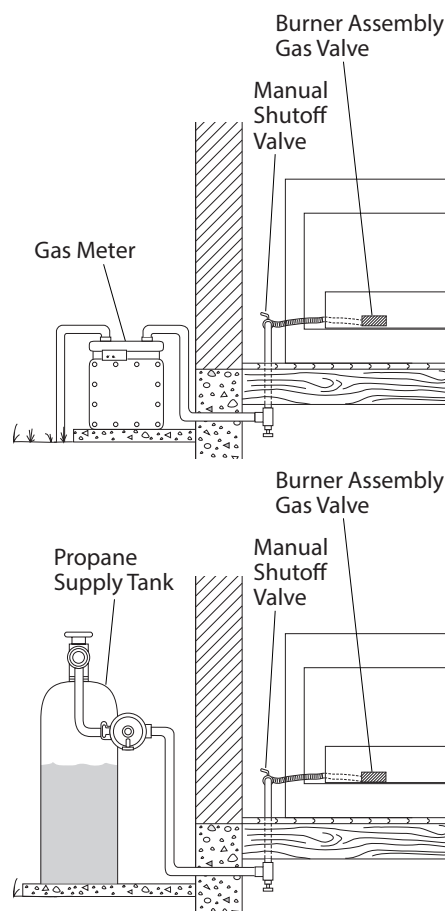

Figure 5.10 - Checking Gas Joints

6 operation

Multifunction Burner Remote Operating Instructions

IMPORTANT: This burner system can only be operated in REMOTE Mode and can not be turned on and off manually.

WARNING: The transmitter and receiver are radio frequency devices. Placing the receiver in or near metal may severely reduce the signal range.

WARNING: Turn off main gas supply and electrical supply to the fireplace during installation and/or maintenance of the receiver device.

WARNING: FIRE HAZARD. Can cause severe injury or death due to burns. The receiver causes ignition of the fireplace. The fireplace can turn on suddenly. Keep away from the fireplace burner when operating the remote system or activating manual bypass of the remote system.

WARNING: PROPERTY DAMAGE HAZARD. Excessive heat can cause property damage. The fireplace can stay lit for many hours. Turn off the fireplace if it is not going to be attended for any length of time. Always place the transmitter where children can not reach it.

WARNING: FIRE OR EXPLOSION HAZARD. Can cause property damage, sever injury, or death. Do not attempt to take apart the gas control or to clean it. Improper assembly and cleaning can cause unreliable operation.

Notes for Remote Operating System

Not all features called out in Figure 6.1 are available on this fireplace.

This control system includes a battery back-up pack that allows the fireplace to operate during a power outage. The accent light will not operate during a power outage.

Replace all batteries at least yearly, preferably before the heating season begins.

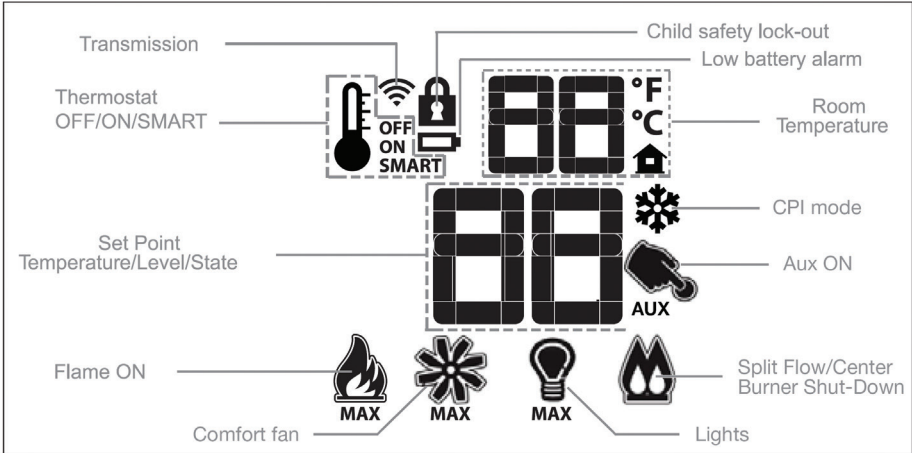

Figure 6.1 - Multifunction Burner Remote and Functions

Temperature Indication Display, °C or °F

With the burner system OFF, press the Thermostat Button and the MODE Button at the same time. Look at the Multifunction Burner Remote LCD screen to verify that a °C or °F is visible to the right of the Room Temperature display. See Figures 6.2 and 6.3.

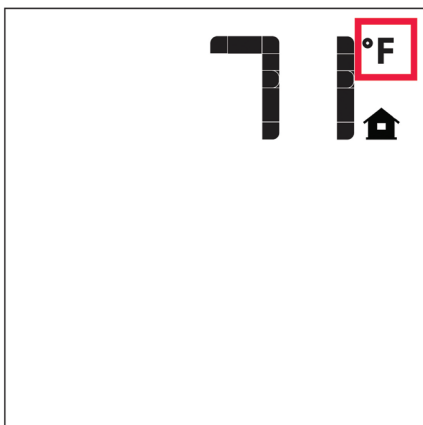

Figure 6.2

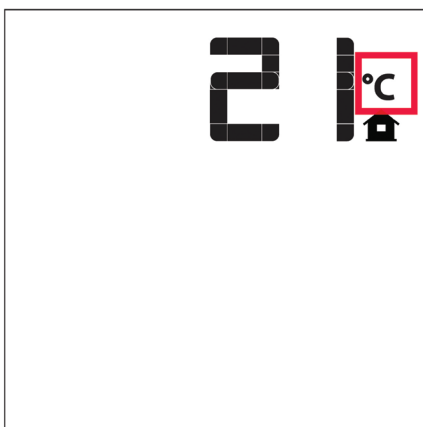

Figure 6.3

Turning ON the Burner

With the burner system OFF, press the ON/OFF Button on the Remote. A single beep will confirm the command. The LCD display will show active icons. At the same time, the Remote will activate the burner. See Figure 6.4.

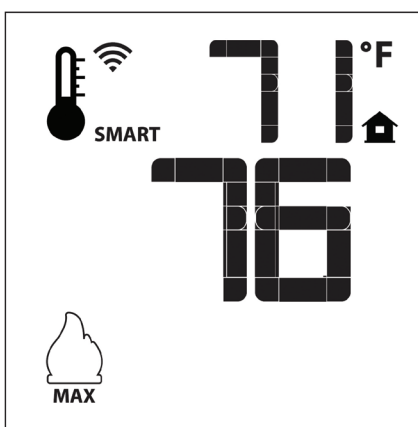

Figure 6.4

Turning OFF the Burner

With the burner system ON, press the ON/OFF Button on the Remote. A single beep will confirm the command. The LCD display will only show the room temperature. At the same time, the Remote will turn off the burner. See Figure 6.5.

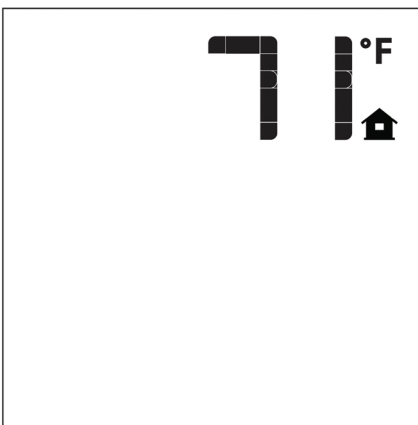

Figure 6.5

Remote Flame Control

The ProFlame control has six flame levels. With the burner system ON and the flame level at maximum, each press of the DOWN Arrow Button will reduce the flame height by one step until the flame is turned off.

Each press of the UP Arrow Button will increase the flame height one step. If you press the UP Arrow Button while the system is ON, but the flame is OFF, the burner will activate with the flame in the HI position. See Figures 6.6 - 6.9.



Figure 6.6 - Flame OFF

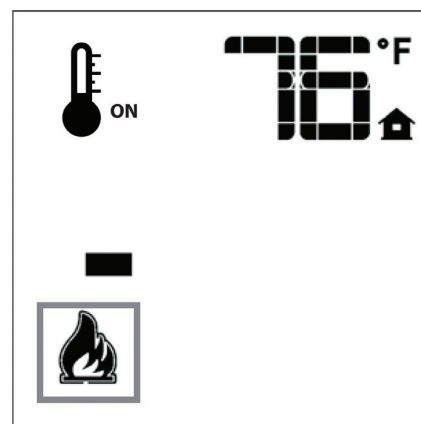

Figure 6.7 - Flame Level 1

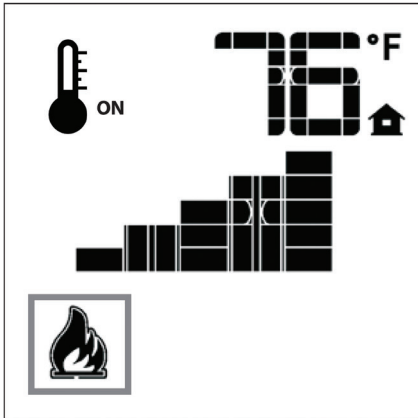

Figure 6.8 - Flame Level 5

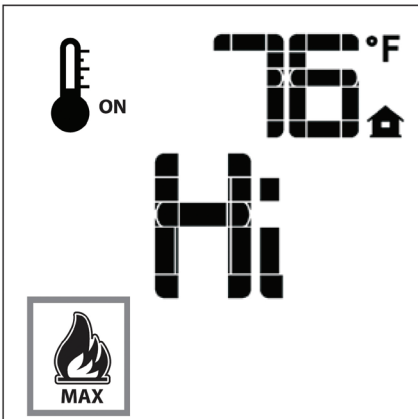

Figure 6.9 - Maximum Flame Level

Continuous Pilot/Intermittent Pilot (CPI/IPI) Selection

During regular operation, the burner system operates in Intermittent Pilot Mode (IPI). During a prolonged power outage, you can switch the fireplace to operate in Continuous Pilot Mode (CPI). This reduces drain on the batteries used to ignite the burner and ensures the fireplace will continue to operate throughout the outage.

With the burner system OFF, press the MODE Button to index to the CPI/IPI mode icon. Press the UP Arrow Button to activate CPI Mode (see Figure 6.10). Press the DOWN Arrow Button to return to IPI Mode (see Figure 6.11). A single beep will confirm each command.

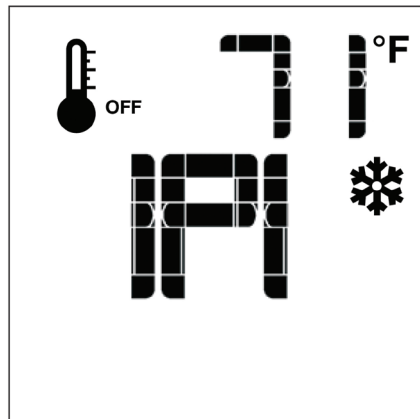

Figure 6.10 - Intermittent Pilot Mode

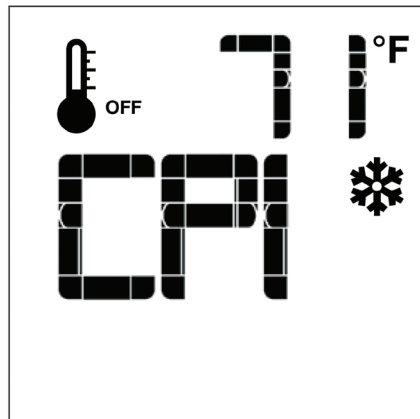

Figure 6.11 - Continuous Pilot Mode

Button Lock

This function will lock the buttons to prevent unintentional or unsupervised operation.

To turn this function on, press the MODE Button and UP Button at the same time. A padlock icon will appear on the LCD screen (see Figure 6.12)

To turn this function off, press the MODE Button and UP Button at the same time. The padlock icon will disappear from the LCD screen.

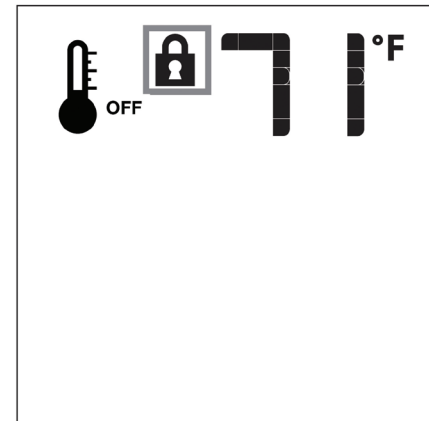

Figure 6.12 - Remote Lock Mode

Low Battery Power Detection - Multifunction Burner Remote

The life span of the remote batteries depends on various factors:

- Quality of the batteries
- How frequently the fireplace cycles on and off

When the remote batteries are low, an icon will appear on the LCD screen (see Figure 6.13). Replace the batteries before all battery power is lost. When you replace the batteries, the icon will disappear.

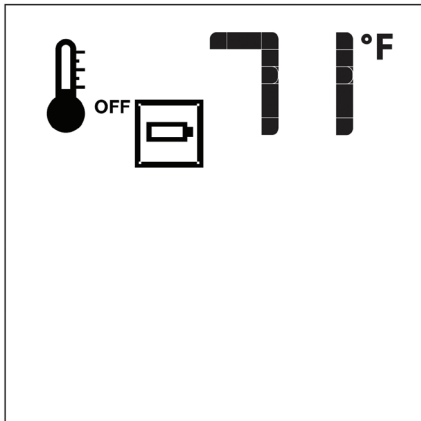

Figure 6.13 - Low Battery Icon

Battery Backup Operation

In case of power loss, the burner will automatically switch to battery mode. The burner will operate normally without the light control when in battery mode.

Battery Backup Low Battery Detection

If backup batteries are low while operating in Battery Backup Mode, the module emits a double-beep when it receives an ON/OFF command. The system will not accept any commands until the batteries are replaced or A/C power is restored.

Lockout State Definition

To prevent damage to the fireplace, the IFC board will automatically lock out the Multifunction Burner Remote if it detects an anomalous flame or too many unsuccessful ignition attempts. The lockout state will remain as long as the power supplies are applied.

When the IFC board goes into lockout state:

1. Both the Pilot and Main Burner solenoids in the gas valve are de-energized.
2. A diagnostic code is sent through the diagnostic red LED.
3. The IFC board will ignore any burner ignition command and remain in the OFF state unless the unlock command is met.

To exit lock out state, turn the system power supplies (to the ProFlame Receiver or Multifunction Burner Remote) OFF for three seconds and then restore power. If the lockout reoccurs, call your dealer. The causes of lockout must be investigated under safe conditions by trained service personnel.

LED Lighting Operating Instructions

Operating LED Lights with Handheld Remote

The LED lighting control allows you to have 9 various lighting scenes to switch between as well as an Auto Scene mode that automatically rotates through the 9 different scenes.

Use the LED lighting remote to operate the lights. Figure 6.15 shows the remote and all the functions.

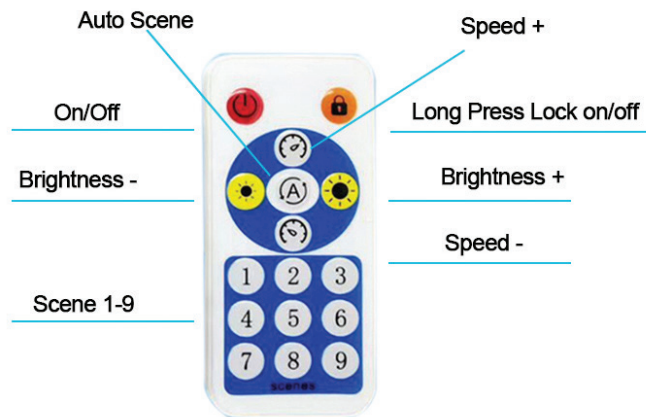

Figure 6.15 - Remote and Functions



Figure 6.14 - SceneX System



Figure 6.16 - SceneX System and Mobile App QR Code

Operating LED Lights with Mobile App

You can control the LED lighting with the full-function mobile app. Scan the QR code on Figure 6.16 to take you to either Google Play or the App Store to download the app.

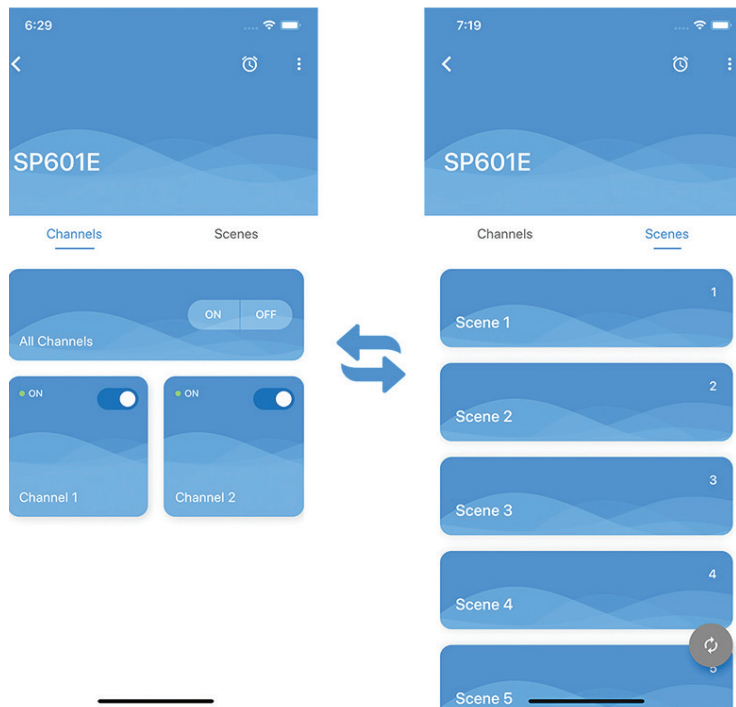
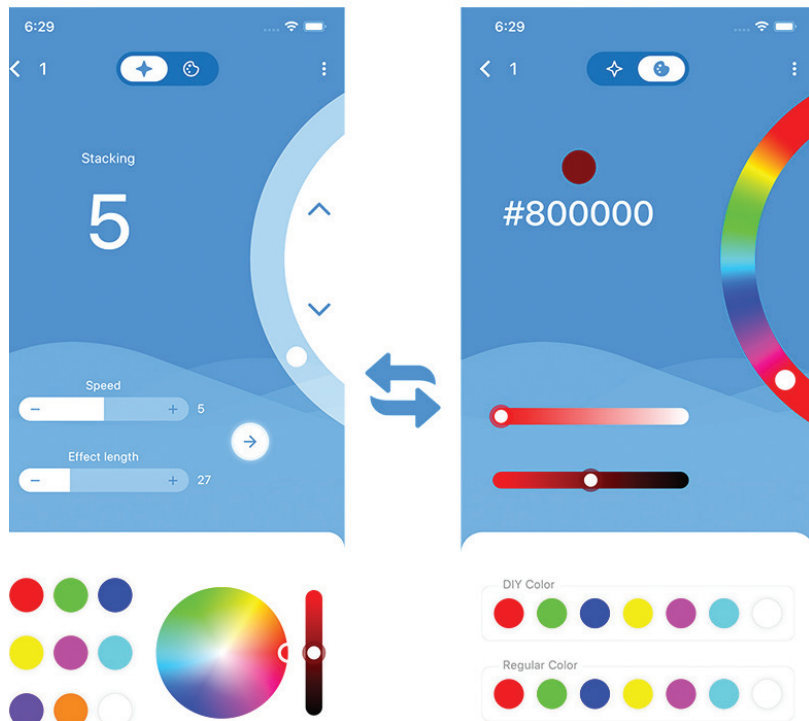

INTERMITTENT PILOT INSTRUCTIONS

FOR YOUR SAFETY READ BEFORE LIGHTING

⚠ WARNING

If you do not follow these instructions exactly, a fire or explosion may result causing property damage, personal injury or loss of life.

- A. **BEFORE LIGHTING** smell all around the appliance area for gas. Be sure to smell next to the floor because some gas is heavier than air and will settle on the floor.
- WHAT TO DO IF YOU SMELL GAS**
- Do not try to light any appliance.
 - Do not touch any electrical switch.
 - Do not use any phone in your building.
 - Immediately call your gas supplier from a neighbor's phone. Follow the gas supplier's instructions.
 - If you can not reach your gas supplier, call the fire department.
- B. Use only your hand to push in or turn the gas control knob. Never use tools. If the knob will not push in or turn by hand, don't try to repair it, call a qualified service technician. Force or attempted repair may result in a fire or explosion.
- C. Do not use this appliance if any part has been under water. Immediately call a qualified service technician to inspect the appliance and to replace any part of the control system and any gas control which has been under water.

LIGHTING INSTRUCTIONS

1. **STOP!** Read the safety information above.
2. Read this Installation and Operation Manual including the section on "Multifunction Burner Remote Operating Instructions".
3. Press the ON/OFF button on remote control transmitter so it displays "OFF".
4. Turn "OFF" all electric power to the appliance at the breaker.
5. Turn gas shutoff valve to ON position.
6. This appliance is equipped with an ignition device which automatically lights the pilot. Do not try to light the pilot by hand.
7. Wait five (5) minutes to clear out any gas. Then smell for gas, including near the floor. If you smell gas, STOP! Follow "B" in the safety information above. If you don't smell gas, go to the next step.
8. Turn on all electric power to the appliance.
9. Press the ON/OFF button on remote control transmitter so it displays "ON".
10. Appliance will begin to light.
11. If the appliance will not operate, follow the instructions "To Turn Off Gas To Appliance" and call your service technician or gas supplier.

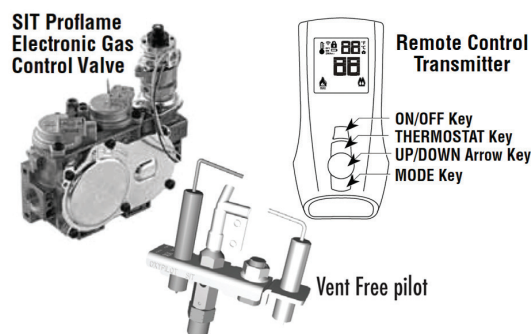

TO TURN OFF GAS TO FIREPLACE

1. Press the ON/OFF button on the remote control transmitter so it displays "OFF".
2. Turn off all electric power to the appliance at the breaker if service is to be performed.
3. Turn gas shut-off valve to "OFF" position.

LINE VOLTAGE



DO NOT REMOVE THIS LABEL

See installation & operating instructions for this model.
Contact local building officials about restrictions and
installation specifications in your area.

TESTED &
LISTED BY:



C **US**
REPORT NO. #

REPORT NO.

ANSI-Z21.11.2.2016
Uncented Room Heater
ANSI-Z21 60-2017
CSA 2.26-2
Decorative gas appliances for
installation in solid-fuel
burning fireplaces.

DATE OF MFG. **SERIAL #**

MODEL: VF LDB <input type="checkbox"/> L-EN	24 <input type="checkbox"/>	36 <input type="checkbox"/>	48 <input type="checkbox"/>	60 <input type="checkbox"/>
HIGH BTU/HR (kW):	16,000 (4.00kW)	32,000 (9.37kW)	39,500 (11.57kW)	39,500 (11.57kW)
LOW BTU/HR (kW):	10,000 (2.93kW)	20,000 (5.36kW)	27,000 (7.91kW)	27,000 (7.91kW)
MODEL: VF LDB <input type="checkbox"/> L-EP	24 <input type="checkbox"/>	36 <input type="checkbox"/>	48 <input type="checkbox"/>	60 <input type="checkbox"/>
HIGH BTU/HR (kW):	16,000 (4.00kW)	32,000 (9.37kW)	39,500 (11.57kW)	39,500 (11.57kW)
LOW BTU/HR (kW):	10,000 (2.93kW)	20,000 (5.36kW)	27,000 (7.91kW)	27,000 (7.91kW)

NG Models
Altitude
Input
Reduced Input
P4
Manifold Pressure: 3.5" w.c.(NG)
Minimum Supply Pressure: 5" w.c. (NG)
Maximum Supply Pressure: 7" w.c. (NG)
Pression au Collecteur: .87wPA d'une colonne d'eau (GN)
Pression d'Alimentation Min.: 1.25wPA d'une colonne d'eau (GN)
Pression d'Alimentation Max.: 10.5wPA ** d'une colonne d'eau (GN) **
Maximum inlet pressure not to exceed 13".
Minimum clearance to combustible materials: Top, sides & back:
per standoff spacers for framing and finishing materials. For non-com-
bustible framing and finishing materials, see installation manual.

MANIFOLD PRESSURE:
ELECTRICAL RATING: 120V/60HZ
GAS TYPE: NATURALGAS /LIQUID PROPANE

LP Models
Élévation
Alimentation / Alimentation Réduite
P4
Manifold Pressure: 10.5" w.c. (LP)
Minimum Supply Pressure: 11" w.c. (LP)
Max. Supply Pressure: 14" w.c. (LP)
Pression au Collecteur: 2.40wPA d'une colonne d'eau (LP)
Pression d'Alimentation Min.: 2.74wPA d'une colonne d'eau (LP)
Pression d'Alimentation Max.: 3.49wPA * d'une colonne d'eau (LP)
** Pression d'alimentation maximale ne devait pas dépasser
3.49wPA. Dégagements minimaux des matériaux combustibles:
Dessus, côtés et arrière: selon les espaceurs de dégagements
pour les matériaux d'ossature selon le manuel du
propriétaire pour les matériaux de finition

VENTED DECORATIVE GAS APPLIANCE: NOT A SOURCE OF HEAT; NOT FOR USE WITH SOLID FUEL.
APPAREIL DÉCORATIF À GAZ VENTILÉ: PAS UNE SOURCE DE CHALEUR; NE PAS UTILISER AVEC DU COMBUSTIBLE SOLIDE.

THIS APPLIANCE NEEDS FRESH AIR FOR SAFE OPERATION AND MUST BE INSTALLED
SO THERE ARE PROVISIONS FOR ADEQUATE COMBUSTION AND VENTILATION AIR.
CET APPAREIL A BESOIN D'AIR FRAIS POUR UN FONCTIONNEMENT SÉCURISÉ ET DOIT ÊTRE INSTALLÉ POUR IL Y A DES
DISPOSITIONS POUR UN AIR DE COMBUSTION ET DE VENTILATION ADÉQUAT.

This appliance is not for installation in manufactured homes. Cet appareil n'est pas destiné à être installé dans des maisons préfabriquées.

The installation, including provisions for combustion, ventilation air, and required minimum permanent vent opening,
must conform with National Fuel Gas Code (ANSI Z223.1/NFPA 54) and applicable local building codes.

L'installation, y compris les dispositions pour la combustion, l'air de ventilation et l'ouverture de ventilation permanente minimale requise,
doit être conforme au National Fuel Gas Code (ANSI Z223.1 / NFPA 54) et aux codes du bâtiment locaux applicables.

⚠ WARNING: This gas appliance **must not** be connected to a chimney fuel servicing a solid fuel burning appliance.
⚠ AVERTISSEMENT: Cet appareil à gaz ne doit pas être raccordé à un combustible
de cheminée desservant un appareil à combustible solide.

⚠ WARNING: THIS FIREPLACE IS NOT INTENDED FOR BURNING SOLID FUELS.
⚠ AVERTISSEMENT: CE FOYER N'EST PAS DESTINÉ À BRÛLER DES COMBUSTIBLES SOLIDES.

7 replacement parts

Exploded View

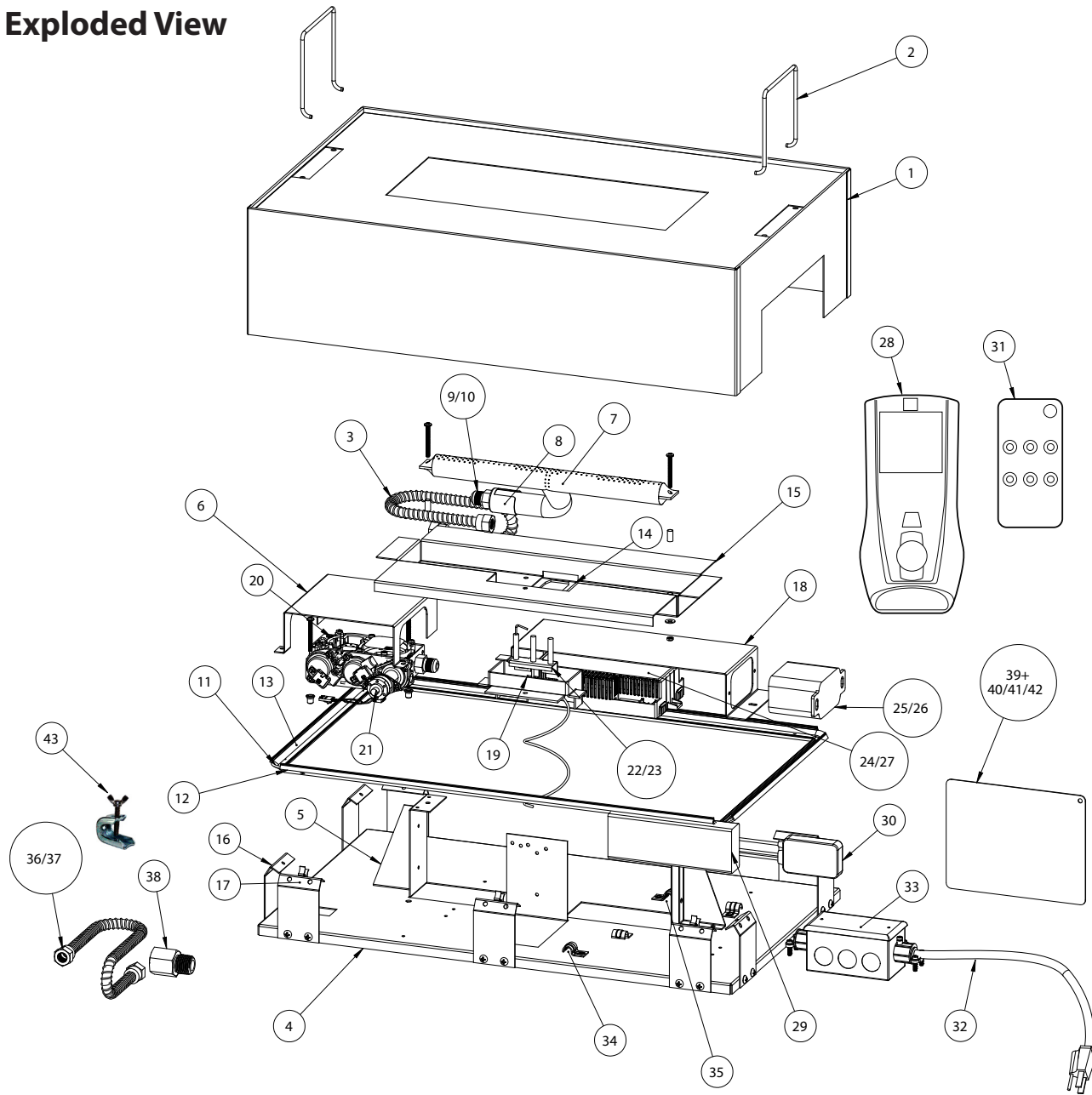

Parts List

Item	Description	Part Number	Item	Description	Part Number
1	24" Case for Drop-In Burner	02-00119-01	15	12" Perf Burner Trough (24" Model)	02-00147-01
	36" Case for Drop-In Burner	02-00119-02		24" Perf Burner Trough (24" Model)	02-00147-02
	48" Case for Drop-In Burner	02-00119-03		36" Perf Burner Trough (24" Model)	02-00147-03
	60" Case for Drop-In Burner	02-00119-04		48" Perf Burner Trough (24" Model)	02-00147-04
2	Handle Set	02-00127	16	LED Angled Support	02-00164-01
3	Flexible Gas Hose, Valve to Burner	10-00002-01	17	LED Angled Support with Clip	02-00164-02
4	24" Base for Linear Drop-in Burner	02-00160-01	18	ProFlame Sheild	02-00165
	36" Base for Linear Drop-in Burner	02-00160-02	19	Pilot Guard	02-00719
	48" Base for Linear Drop-in Burner	02-00160-03	20	SIT Modulating Valve for NG	0.885.506
	60" Base for Linear Drop-in Burner	02-00160-04	21	SIT Step Motor, Valve Conversion to Propane	0.907.015
5	Bookend Bracket (Qty 2)	02-00125	22	SIT OXY ODS Pilot, NG	840.094.27000
6	Valve Shield	02-00132	23	SIT OXY ODS Pilot, LP	840.096.09000
7	12" Burner Tube (24" Model)	02-00130-01	24	ProFlame II Wire Harness X5	0.584.920
	24" Burner Tube (36" Model)	02-00130-02	25	ProFlame II Wire Harness X8	0.584.922
	36" Burner Tube (48" Model)	02-00130-03	26	ProFlame II Receiver	0.584.103
	48" Burner Tube (60" Model)	02-00130-04	27	ProFlame II IFC Control Board	0.584.306
8	Air Shutter Bracket	02-00192	28	ProFlame II Remote Transmitter	0.584.042
9	NPT to Flare 1/2" Pipe Fitting	10-00005	29	LED Power Supply	12V5A
10	NG Brass Orifice (24" Model)	10-00042-01	30	RF Controller	SP601E
	NG Brass Orifice (36" Model)	10-00042-02	31	LED Light Remote	LED-RMT
	NG Brass Orifice (48" Model)	10-00042-03	32	6-Foot Power Cord	A01630
	NG Brass Orifice (60" Model)	10-00042-04	33	Electrical Box	01-00031
	LP Brass Orifice (24" Model)	10-00042-05	34	LED Power Cable	01-00050
	LP Brass Orifice (36" Model)	10-00042-06	35	IFC Board Power Cable, (24" Model)	01-00041-01
	LP Brass Orifice (48" Model)	10-00042-07		IFC Board Power Cable, (36" Model)	01-00041-02
	LP Brass Orifice (60" Model)	10-00042-08		IFC Board Power Cable, (48" Model)	01-00041-03
11	LED Lights String, (24" Model)	01-00052-01		IFC Board Power Cable, (60" Model)	01-00041-04
	LED Lights String, (36" Model)	01-00052-02	36	Flexible Inlet Gas Hose, (10" for 24", 36", & 48" Models)	10-00002-01
	LED Lights String, (48" Model)	01-00052-03	37	Flexible Inlet Gas Hose, (16" for 60" Models)	10-00002-01
	LED Lights String, (60" Model)	01-00052-04	38	1/2" FIP to 1/2" Flare	46-46
12	Plastic Optic Lens (24" Model)	03-00039-01	39	Sheet Metal Label Plate	02-00214
	Plastic Optic Lens (36" Model)	03-00039-02	40	Vent-Free Rating Label	07-00031
	Plastic Optic Lens (48" Model)	03-00039-03	41	Carbon Warning Label	07-00034
	Plastic Optic Lens (60" Model)	03-00039-04	42	Venting Warning Label	07-00035
13	LED Aluminum Track (24" Model)	02-00124-01	43	Universal Damper Clamp	00F0545
	LED Aluminum Track (36" Model)	02-00124-02			
	LED Aluminum Track (48" Model)	02-00124-03			
	LED Aluminum Track (60" Model)	02-00124-04			
14	Perforated Glass Media Barrier	02-00134			

8 wiring diagram

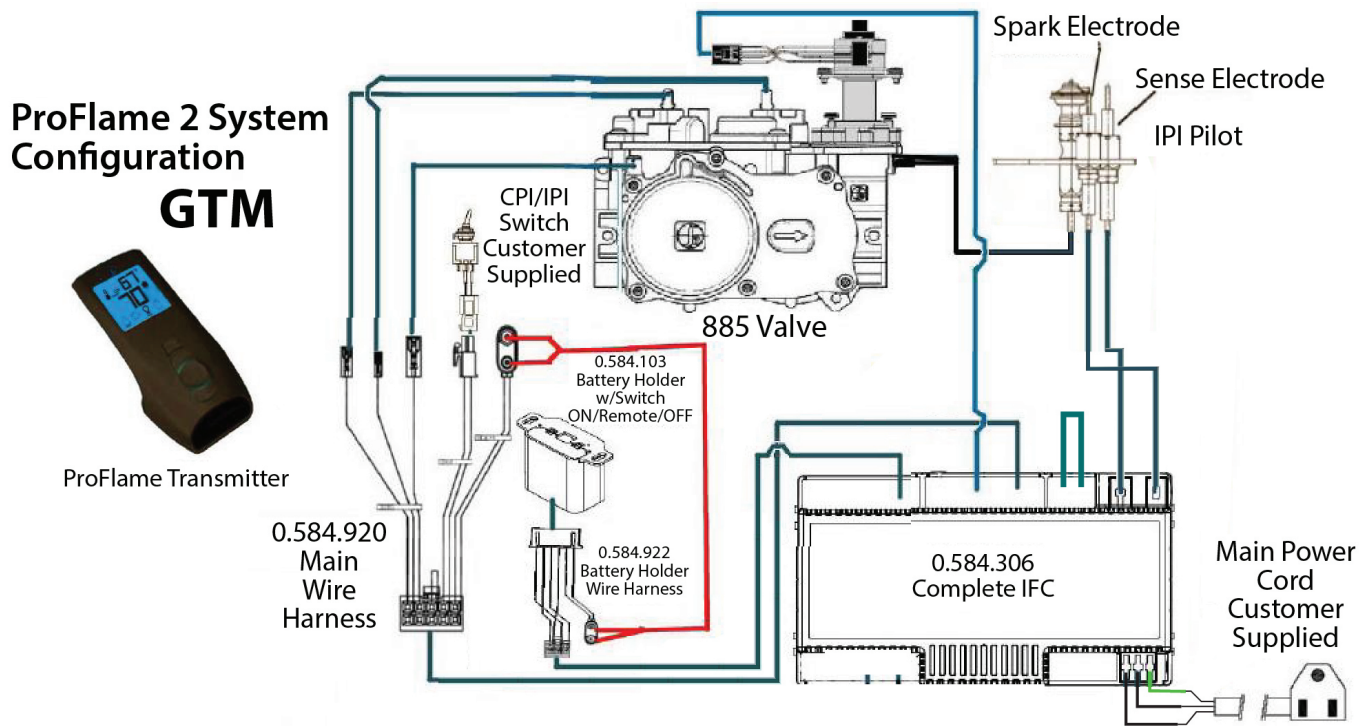

9 maintenance

Cleaning and Maintenance

⚠ WARNING: Turn off the gas and electrical power before servicing the appliance.

⚠ WARNING: Appliance may be hot. Do not service until the appliance has cooled.

⚠ WARNING: When servicing the control, label all wires prior to disconnection. Wiring errors can cause improper and dangerous operation. Verify proper operation after servicing.

⚠ WARNING: Do not paint the pilot assembly.

⚠ CAUTION: Do not use abrasive cleaners on glass.

This appliance and its venting system should be inspected before use and at least annually by a qualified service person. The following suggested checks should be performed by a qualified technician. The appliance area must be kept clear and free of combustible materials, gasoline, or other flammable vapors and liquids. The flow of combustion and ventilation air must not be obstructed.

1. In order to properly clean the burner and pilot assembly, remove the glass media and case to expose both assemblies.
2. Keep the control compartment, media, burner, air shutter opening and the area surrounding the appliance clean by vacuuming or brushing at least once a year.
3. Check to see that all burner ports are burning. Clean out any of the ports which may not be burning or are not burning properly.
4. Check to see that the pilot flame is large enough to engulf the flame sensor and/or thermocouple / thermopile as well as it reaches the burner.
5. If your appliance is equipped with a safety barrier, cleaning may be necessary due to excessive lint / dust from carpeting, pets, etc. Simply vacuum using the brush attachment.
6. If your appliance is equipped with relief doors, ensure the system performs effectively. Check that the gasket is not worn or damaged. Replace if necessary.
7. Replace the cleaned glass media. Failure to properly position the media may cause sooting which can be distributed in the surrounding living area, inside the firebox, and on exterior surfaces surrounding vent termination.
8. Check to see that the main burner ignites completely on all ports when turned on. A 5 to 10 second total light-up period is satisfactory. If ignition takes longer, consult your local authorized dealer / distributor.
9. Visually inspect the appliance for carbon build up. Using a small whisk or brush, remove the carbon and vacuum up or sweep into garbage.

10 troubleshooting

⚠ WARNING: Turn off the gas and electrical power before servicing the appliance.

⚠ WARNING: Appliance may be hot. Do not service until the appliance has cooled.

⚠ WARNING: When servicing the control, label all wires prior to disconnection. Wiring errors can cause improper and dangerous operation. Verify proper operation after servicing.

⚠ WARNING: Do not paint the pilot assembly.

⚠ CAUTION: Do not use abrasive cleaners on glass.

OBSERVED FAULT	POSSIBLE CAUSE	REMEDY
Pilot will not light and/or makes noise with no spark at pilot burner.	<ol style="list-style-type: none"> 1. Batteries low or dead 2. Wiring 3. Loose connection 4. Module 5. Ignitor spark gap is incorrect 6. Electrode 7. A shorted or loose connection 8. Improper switch wiring 9. Module is not grounded 	<ol style="list-style-type: none"> 1. Check batteries 2. Verify the sensor and ignitor wires are connected to the correct terminals (not reversed) on the module. NOTE: Sensor has 3/16" (4.8mm) connection and ignitor has 1/8" (3.2mm) connection. 3. Verify there are no loose connections, electrical shorts in the wiring, or ground outs to any metal object. 4. Turn ON/OFF switch to the OFF position. Remove the ignitor wire from the module. Place the ON/OFF switch to the ON position. Hold a grounded wire about 3/16" (4.8mm) away from the ignitor (spark) terminal on the module. If there is no spark, replace the ignitor terminal module. If there is a spark, the ignitor terminal is fine. 5. Ignitor spark gap should be 1/8" (3.2mm). 6. Inspect pilot assembly for a shorted wire or cracked insulator around the electrode. 7. Remove and reinstall the wiring harness that plugs into the module. Reove and verify continuity of each wire in wiring harness. 8. Troubleshoot the system with the simplest ON/OFF switch. 9. Verify the valve and pilot assemblies are properly grounded to the metal chassis of the appliance.
Pilot Sparks but will not light.	<ol style="list-style-type: none"> 1. Gas supply 2. Out of Liquid Propane/LP gas 	<ol style="list-style-type: none"> 1. Verify that incoming gas line ball valve is open. Verify the inlet pressure is within acceptable limits. Inlet pressure must not exceed 14" w.c. (34.9mb). 2. Fill Liquid Propane/LP tank.

OBSERVED FAULT	POSSIBLE CAUSE	REMEDY
Carbon is being deposited on glass media or combustion chamber surfaces.	<ol style="list-style-type: none"> Air shutter is blocked Flame is impinging on the glass media or combustion chamber 	<ol style="list-style-type: none"> Ensure air shutter opening is free of lint or other obstructions. Check that the glass media are positioned correctly. Open air shutter to increase the primary air. Check the input rate, manifold pressure, and orifice size as specified in this manual.
Continues to spark and pilot lights, but main burner will not light.	<ol style="list-style-type: none"> Short or loose connection in sensor rod Poor flame rectification or contaminated sensor rod Poor grounding between pilot assembly and gas valve Damaged pilot or sensor rod Pilot has been painted Wiring/connection Wiring harness 	<ol style="list-style-type: none"> Verify all connections. Verify all pilot assembly connections are tight and are not grounding to any metal. Verify the flame is engulfing the sensor rod. This will increase the flame rectification. Verify correct pilot orifice is installed and inlet gas pressure is correct. (NOTE: The flame carries the rectification current, not the gas. If the flame lifts from the pilot hood, the circuit is broken. A wrong orifice or too high of an inlet pressure can cause the pilot to lift). The sensor rod may need cleaning. Verify that the wire harness is firmly connected to the module. Verify that the ceramic insulator around the sensor rod is not cracked, damaged, or loose. Verify the connection from the sensor rod to the sensor wire. Clean sensor rod with an emery cloth to remove any contaminations that may have accumulated on the sensor rod. Verify continuity with multimeter with ohms set to the lowest range. Check for shorted wire or cracked insulator. Using a piece of sandpaper or emery cloth, remove the paint from the pilot hood, ignitor, and flame sensor. Inspect all wires and ensure tight connections. Verify that all wiring is installed exactly as specified. Inspect the wiring harness and verify it is tightly connect to the module. Verify that all wires are connected in the right order. See <i>Wiring Diagram</i>, page 28.
Pilot light. Stops sparking / pilot remains lit but burner will not turn on.	<ol style="list-style-type: none"> Pilot has been painted 	<ol style="list-style-type: none"> Using a piece of sandpaper or emery cloth, remove the paint from the pilot hood, ignitor, and flame sensor.

11 warranty information

Refractory Logs:

Mason-Lite logs carry a lifetime warranty against any manufacture defects or breakage as long as the products are installed inside. In the event defect or breakage occurs a replacement will be available to pick-up from the dealer at which the log set was originally purchased. This warranty does not cover breakage caused by excessive handling once installed and fired. Logs installed outdoors carry a (5) year warranty. This warranty is limited to original purchaser only.

Burner:

Mason-Lite burners carry a life time warranty against manufacture defects or breakage as long as the appliance is installed inside and by a professional installer. In the event a defect or breakage occurs a replacement will be available for pick-up from the dealer at which the burner was originally purchased. This warranty is limited to original purchaser only. Indoor burners installed outside carry a (1) year warranty.

Electrical and Valves:

Mason-Lite valves, remotes & receivers carry a (2) year warranty against breakage or defects from date of purchase, by original purchaser, and must be installed by a licensed professional installer. This warranty only covers use with Mason-Lite burners and logs. In the event a defect or breakage occurs a replacement will be available for pick-up from the dealer at which the burner was originally purchased. Batteries are not covered under this warranty. ODS pilot assemblies carry a (1) year warranty.

WARRANTY CARD

Please fill this warrant card and mail it to Mason-Lite to receive a warranty claim

Purchased from (Showroom name) _____

City _____ State _____

Day/Month/Year _____

Model purchased _____

YOUR INFORMATION

Name: _____

City _____ State _____

Phone Number _____ Email _____

Date of install _____

Copy & Mail to:
Mason-Lite
 3515 E. Atlanta Ave., Phoenix, AZ 85040

DO NOT RETURN TO STORE!

STOP, CALL US FIRST

**For immediate help with installation, product information or
if your product arrives damaged, please call our toll free number at:**

1-800-345-7078

(Monday - Friday, 8:00AM - 5:00PM, CA Pacific Daylight Time)

or email us at:

info@mason-lite.com

OUR STAFF IS READY TO PROVIDE ASSISTANCE



Mason-Lite

6391 Jurupa Avenue
Riverside, CA 92504

800-345-7078

mason-lite.com

REV. 1, 1/2023
©2023, Mason-Lite
All rights reserved U.S.A,
and Foreign Patents Pending