



Installation Instructions

Maldives

KA-210-31

Single Handle Pull-Out Kitchen Faucet

Thank you for selecting Lulani.

To ensure that your installation proceeds smoothly, please read these instructions carefully before you begin.

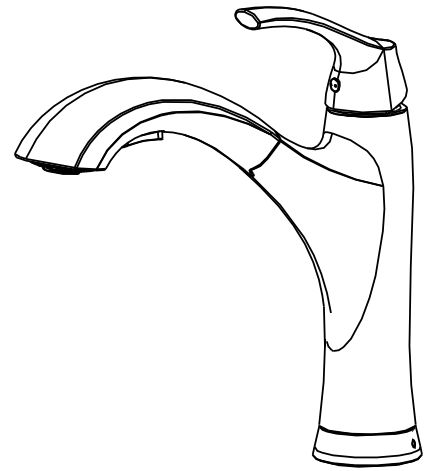

Parts Included

1. Faucet
2. Spray head
3. Above sink hardware: rubber O-ring
4. Below sink hardware: Quick Connector
5. Counterweight
6. Water supply lines

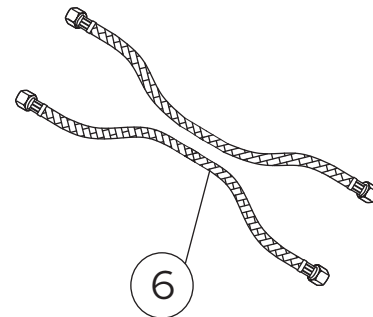
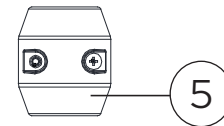
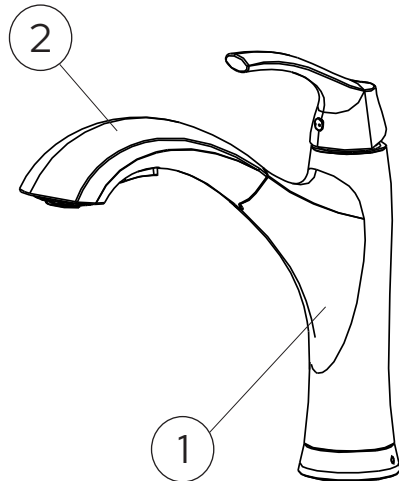

Recommended Tools (not included)

- | | |
|-------------------------|--------------------|
| 1. Adjustable Wrench | 6. Measuring Tape |
| 2. Phillips Screwdriver | 7. Plumber's Putty |
| 3. Safety Goggles | 8. Channel Locks |
| 4. Flashlight | 9. Allen Key |
| 5. Bucket | |



Caution: Tips for removal of old faucet

Always turn off the water supply before removing the existing faucet or replacing any part of the faucet. Open the faucet handle to relieve water pressure and ensure that water is completely shut off.

Maintenance

Your new faucet is designed for years of trouble-free performance. Keep it looking new by cleaning it periodically with a soft cloth. Avoid abrasive cleaners, steel wool, and harsh chemicals as these will dull the finish and void your warranty.

Step 1

Remove the rubber and metal washers and mounting nut from the base by hand twisting off.

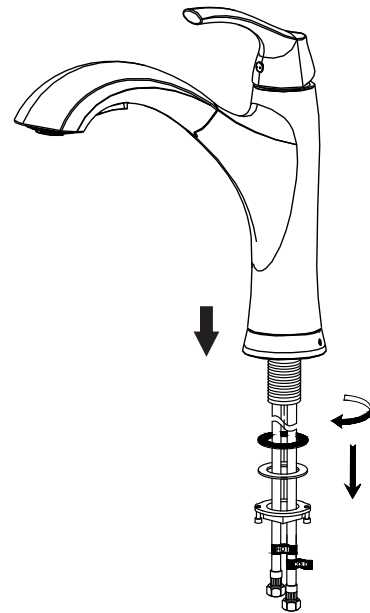

Step 2

Insert the faucet through the installation hole. Secure the faucet by firmly hand tightening the rubber washer, metal washer and mounting nut back on the faucet threads underneath the sink. Tighten the screws on the mounting nut with a Phillips screwdriver.

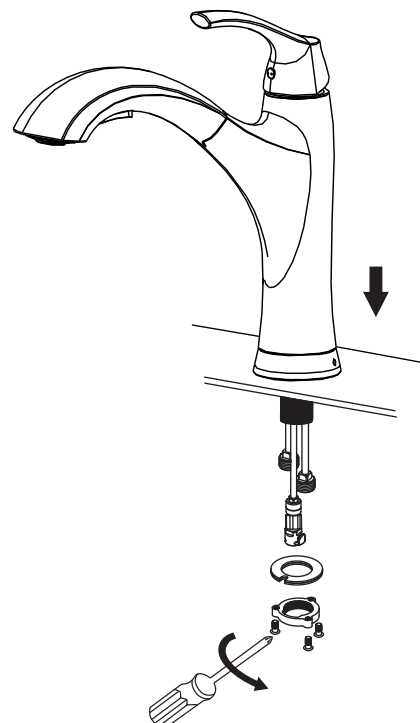

Step 3

Assemble the quick connector (1) by inserting the clip (2) in to place. Attach the pull-out hose (3) to the quick connector. You will hear a light click or popping sound when it has been securely connected.

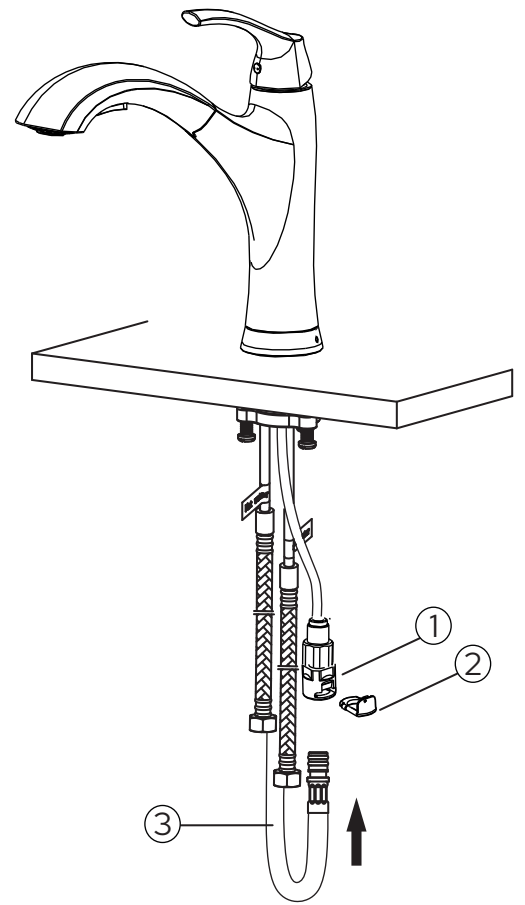

Step 4

Connect the water supply lines to the hot and cold water valves. Tighten with an adjustable wrench. Do not over tighten.

Attention:
Make sure that the
inlet hoses are not
twisted.

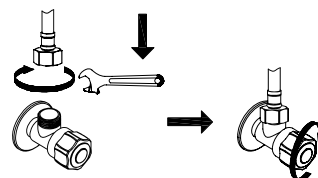
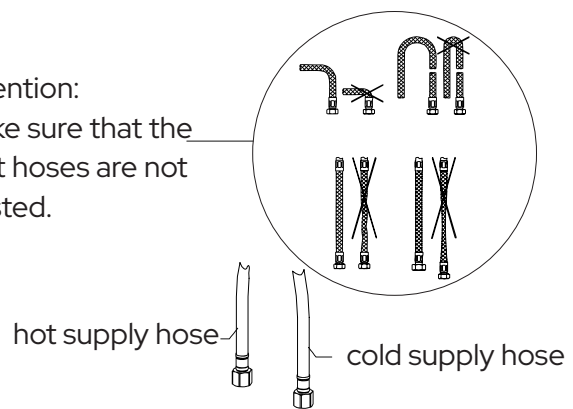

Step 5

The faucet should be flushed for possible debris prior to using. Remove the nozzle head (1) by hand twisting off of the water supply line (2). Turn the faucet handle all the way on, turn on the hot and cold water supply and flush water lines for one minute. Re-install the nozzle head by hand twisting back on to the water supply line.

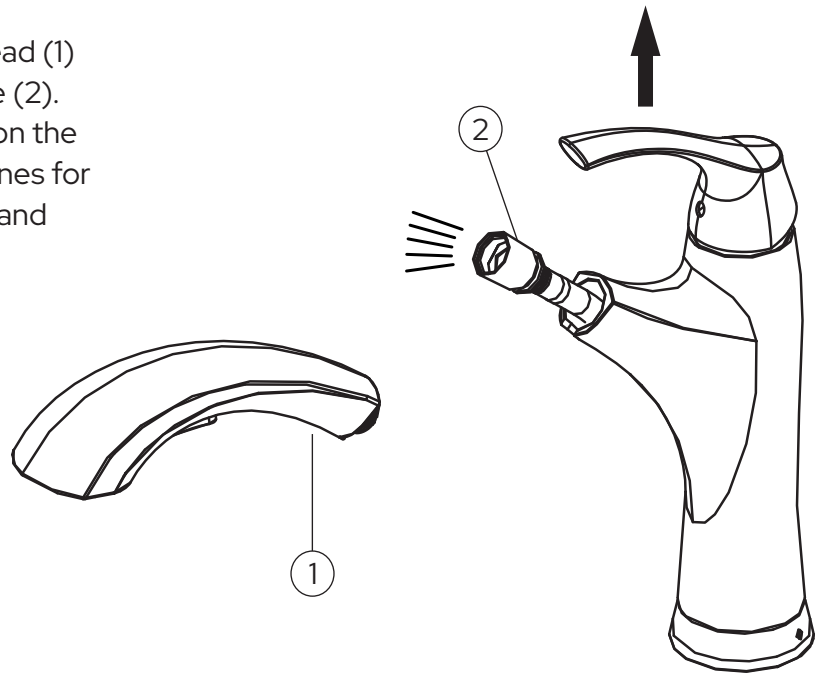

Step 6

Attach the weight to the middle of the spray hose. Use a Phillips screwdriver to secure the weight together.

Turn the water valves back on and then turn on the faucet. Run the water flow for 15 seconds to clean up the lines and check for any leaks.

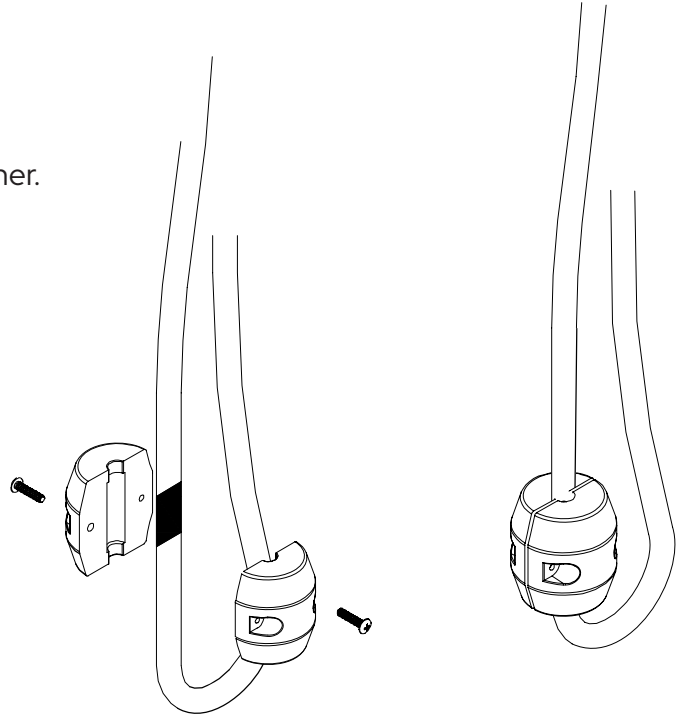

Congratulations! You've successfully finished installing your new faucet. For troubleshooting questions or concerns, please reference the Owner's Manual

We value your opinion! Don't forget to leave us a review.