

HALIFAX

INSTALLATION INSTRUCTIONS

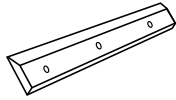

(A) 1x Shelf



(B) 1x Wood Plank

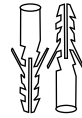

(C) 3x Fischer Plugs



(D) 3x Screws

NOTE: FLOATING COAT RACKS AND WALL SHELVES MUST BE MOUNTED DIRECTLY INTO A CONCRETE WALL OR WALL STUD.

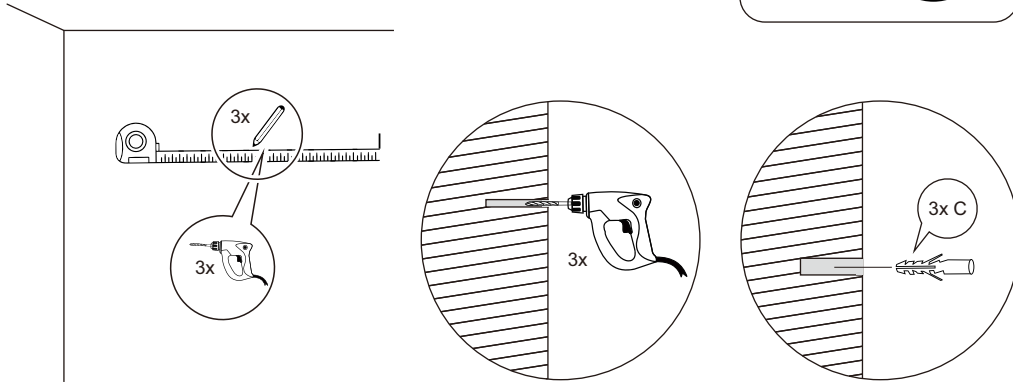
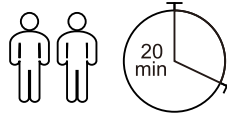

Step 1

Step 2

Step 3

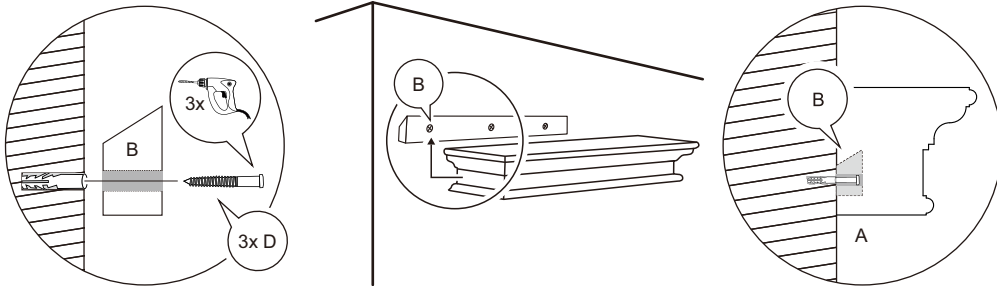

Step 4

Step 5

Step 6

HALIFAX

INSTALLATION INSTRUCTIONS



(A) 1x Shelf

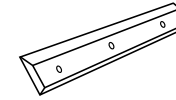

(B) 1x Wood Plank



(C) 3x Fischer Plugs

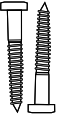

(D) 3x Screws

NOTE: FLOATING COAT RACKS AND WALL SHELVES MUST BE MOUNTED DIRECTLY INTO A CONCRETE WALL OR WALL STUD.

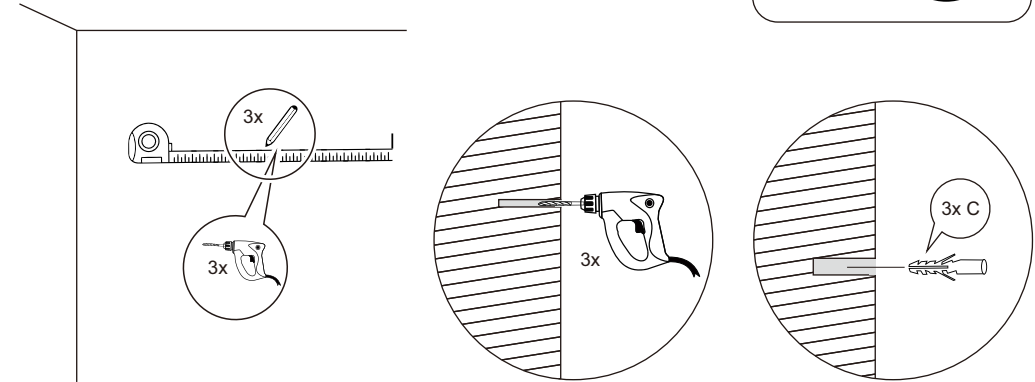
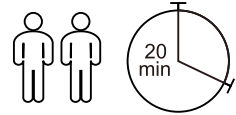

Step 1

Step 2

Step 3

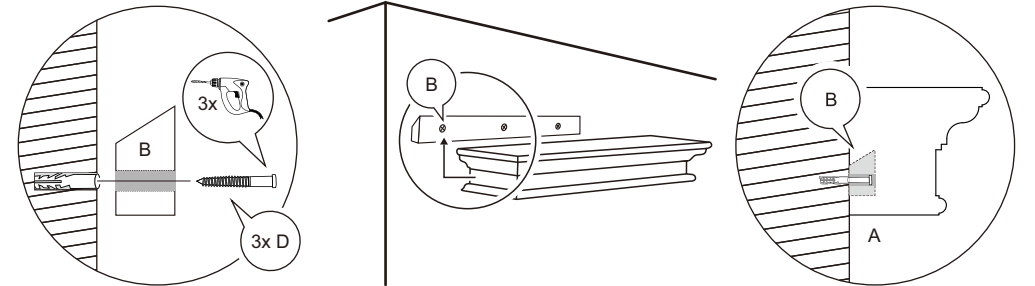

Step 4

Step 5

Step 6

WARNING

Always use the proper tools during assembly. Follow the assembly steps in order. DO NOT skip any steps. Be sure to check all packing materials carefully for assembly hardware. If any parts are missing, contact the retailer from which you purchased the product to obtain any missing parts. DO NOT USE SUBSTITUTE PARTS. During assembly tighten screws first by hand. Once all screws are in place use the tool provided to tighten. Periodically check to ensure that all hardware (bolts, screws, etc.) are tight. DO NOT stand on the product during assembly. Where assembly instructions state that assembly requires two or more people, DO NOT attempt to assemble by yourself as there is a risk of injury.

WARNING

Always use the proper tools during assembly. Follow the assembly steps in order. DO NOT skip any steps. Be sure to check all packing materials carefully for assembly hardware. If any parts are missing, contact the retailer from which you purchased the product to obtain any missing parts. DO NOT USE SUBSTITUTE PARTS. During assembly tighten screws first by hand. Once all screws are in place use the tool provided to tighten. Periodically check to ensure that all hardware (bolts, screws, etc.) are tight. DO NOT stand on the product during assembly. Where assembly instructions state that assembly requires two or more people, DO NOT attempt to assemble by yourself as there is a risk of injury.