

# PVV-SLP

## Power Vent Vertical

- Installation Instructions -

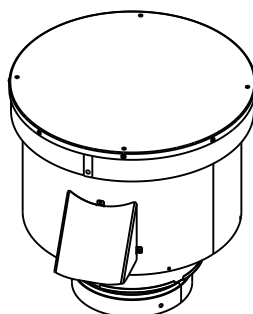

### NOTICE



#### DO NOT DISCARD THIS MANUAL

- Important operating and maintenance instructions included.
- Read, understand and follow these instructions for safe installation and operation.
- Leave this manual with party responsible for use and operation.

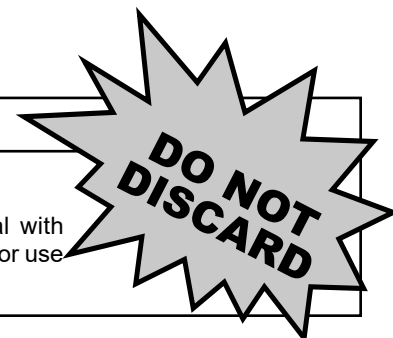

# 1 Introduction

## Table of Contents

### 1 Introduction

A. Installation of PVV-SLP . . . . . 2

### 2 Vent Information and Diagrams

A. Installation of Vent Pipe . . . . . 3  
 B. Vent/Pipe Regulations. . . . . 3  
 C. Venting Length - Model Categories and Length Requirements by Termination Type . . . . . 5  
 D. Setting the PVV-SLP Flue Restrictor . . . . . 7

### 3 Framing and Clearances

A. Framing and Clearances . . . . . 8  
 B. Vent Termination Minimum Clearances . . . . . 8  
 C. Vent Cap Preparation. . . . . 10  
 D. PVV-SLEEVE Preparation. . . . . 13  
 E. PVV-SLEEVE Installation. . . . . 14

### 4 Electrical Information

A. Wiring the Appliance for the PVV-SLP with IntelliFire Touch® (IFT) Controls . . . . . 16  
 B. Wiring the Appliance for the PVV-SLP with IntelliFire® and IntelliFire® Plus (IPI) Controls . . . . . 20  
 C. Pairing or Re-pairing the IFT-RC400 to the Electronic Control Module (IFT-ECM). . . . . 25

### 5 Operating Instructions

A. Installation Inspection . . . . . 26  
 B. Power Vent Operating Instructions. . . . . 26  
 C. Maintenance . . . . . 27  
 D. Replace Blower/Pressure Switch. . . . . 27

### 6 Reference Materials

A. Components and Service Parts List . . . . . 30  
 B. IFT-Controls and PVV-SLP Power Vent Troubleshooting 31  
 C. IntelliFire Plus Controls and PVV-SLP Power Vent Troubleshooting . . . . . 32

Installation of the PVV-SLP may be done by a qualified service technician only. Installation **MUST** comply with local, regional, state and national codes and regulations.

**IMPORTANT:** Failure to read and follow these instructions may create a possible hazard and will void the fire-place warranty.

**These instructions must remain with the equipment.**

**CAUTION! Risk of Cuts or Abrasions.** Wear protective gloves and safety glasses during installation. Sheet metal edges are sharp.

### KIT COMPONENTS

- Vertical Power Vent
- Storm Collar
- Flue Restrictor

A minimum of one PVV-SLEEVE is required. Additional sleeves may be needed based on installation. Order separately.

## INTRODUCTION

The Power Vent Vertical (PVV-SLP) is certified for use as a vertical termination cap only on fireplaces manufactured by Hearth & Home Technologies with IPI (intermittent pilot ignition) gas controls. Fireplaces equipped with millivolt type gas controls CANNOT use this product.

**NOTE:** PVV-SLP requires special control system configurations:

- For IntelliFire® and IntelliFire Plus models, a RC100, RC200 or RC300 and PV-IPI-CK control system is required for installation (except on PRIMO models). The PV-IPI-CK is sold separately.
- For IntelliFire Touch® models, an IFT-ACM and IFT-RC400 are required for installation. The IFT-ACM and IFT-RC400 may need to be purchased separately if the appliance is not already equipped with IFT. IFT-RC400 comes with the needed ACM.

**NOTE:** The battery back-up and wired wall switch feature of any IPI system are removed when the PVV-SLP power vent is installed. The fireplace may no longer be operated with battery back-up and/or a wired wall switch.

The PVV-SLP operates on 120VAC, 60Hz electrical service which is supplied at the fireplace junction box.

**IMPORTANT OPERATIONAL NOTE:** When the control being used to run the fireplace is activated, a 120 seconds delay will occur before pilot ignition will begin. This is to allow a pre-purge by the PVV-SLP. If, after 135 seconds, the pilot and burner do not light, refer to the Troubleshooting section of this instruction for further direction. There will also be a 20-minute post-purge in which the PVV-SLP will continue to run after appliance is turned off.

**NOTICE:** The blower motor present in this power vent will generate sound during operation. The effects of the increased sound level can be minimized with careful planning during installation of the system.

## A. Installation of PVV-SLP

### 1. INSTALLATION PRECAUTIONS

- This device must be installed by a qualified installer in accordance with these instructions.
- Safety inspection of the venting system should be performed before and after installation of this power vent. Consult local code officials and follow applicable installation codes.
- DO NOT INSTALL DAMAGED EQUIPMENT OR VENT COMPONENTS.**
- Disconnect electrical power supply before making wiring connections.
- Venting of more than one appliance in a common vent system is prohibited.
- A protective sleeve (PVV-SLEEVE-12 or PVV-SLEEVE-48) is required to install the PVV-SLP. The sleeve will protect the electrical wire harness from the elements. The PVV-SLEEVE will penetrate the roof/chase top and is the same diameter as DVP pipe (8 inches).

**CAUTION!** Failure to install, operate, and maintain the power venting system in accordance with manufacturer's instructions will result in conditions which may produce bodily injury and/or property damage.

**BLOWER ASSEMBLY**  
4052-796

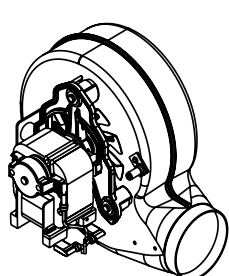

**PRESSURE SWITCH**  
4052-840

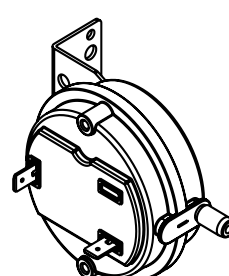

Required Wire Harness and PVV-SLEEVE	
Lengths Available	Part Number
10 ft. PV Wire Harness	PVI-WH10
20 ft. PV Wire Harness	PVI-WH20
40 ft. PV Wire Harness	PVI-WH40
60 ft. PV Wire Harness	PVI-WH60
80 ft. PV Wire Harness	PVI-WH80
100 ft. PV Wire Harness	PVI-WH100
Description	Part Number
12 in. Wire Harness Sleeve	PVV-SLEEVE-12
48 in. Wire Harness Sleeve	PVV-SLEEVE-48

**NOTE:** Wire Harness connecting PVV-SLP to appliance sold separately. The length of wire harness needed varies by installation. For all appliances equipped with IntelliFire or IntelliFire Plus ignition, other than the PRIMO, PV-IPI-CK conversion kit and one of the following; RC100, RC200 or RC300 are required. This kit includes all components to install the PVV-SLP to IntelliFire or IntelliFire Plus appliances. For appliances equipped with IntelliFire Touch (IFT) controls, an RC400 remote and an IFT-ACM are required on the appliance.

Figure 1.1 Service Parts

## 2 Vent Information and Diagrams

### A. Installation of Vent Pipe

For information on standard procedures for venting the appliance, refer to the "Vent Information and Diagrams" section of the appliance installation manual.

The allowable pipe lengths and elbow combinations for an appliance utilizing the PVV-SLP are discussed in the following sections of this instruction manual. The PVV-SLP uses SLP pipe (6-5/8 inch) connections.

In certain cases, a pipe adapter may be used in the vent run. The DVP-2SL adapts from 5 in. / 8 in. DVP series starting collars to 4 in. / 6-5/8 in. SLP series vent pipe. A DVP-SLP24 may also be used to transition from a DVP to SLP pipe when using the PVV-SLP.

Either SLP or DVP venting may be used throughout the vent run except on certain models that require DVP pipe. See Table 2.1. Refer to Section 2.B for more information regarding venting regulations.

All outer pipe joints must be sealed.

- Apply a bead of silicone sealant (with a minimum of 300 °F continuous exposure rating) inside the female outer pipe joint prior to joining sections. See Figure 2.1.

#### **OR**

- Apply aluminum foil tape (300 °F minimum continuous exposure rating) to the outside of connecting joint after joining sections. On horizontal pipe runs, it is recommended that the tape seam is positioned on the bottom side of the vent pipe.
- Only outer pipes need to be sealed. All unit collar, pipe, slip section, elbow and cap outer flues shall be sealed in this manner, unless otherwise stated.



Figure 2.1 Silicone Sealant

### B. Vent/Pipe Regulations

#### **WARNING! Risk of Fire!**

*Maintain minimum pipe length requirement between appliance and PVV-SLP on all models. Combustible materials surrounding pipe may overheat.*

1. A minimum length of venting is required between the appliance and the PVV-SLP. This minimum length requirement varies for the specific appliance. Refer to Table 2.1. for requirements for specific models.
2. Clearances between the vent pipe and combustible materials must be maintained at 1-1/2 inches top and one inch on the sides and bottom.
3. A mechanical drafting venting system shall terminate at least three feet above any forced air inlet located within 10 feet.

## B. Vent/Pipe Regulations (continued)

### WARNING! Risk of Fire!

- A minimum length run of initial vent pipe is required between the appliance and the inlet of the PVV-SLP on some appliance models.
- Some models require DVP Series pipe for the initial minimum vent section directly off the appliance.

MODEL	MINIMUM VENTING BETWEEN APPLIANCE AND PVV-SLP
ALL 6000C, ALL 6000CL, ALL 6000CLX, 6K, 6KL, 6KX ALL 8000C, ALL 8000CL, ALL 8000CLX, 8K, 8KL, 8KX	Six feet minimum venting required for all appliances. Must have a 90 degree elbow for rear vent appliances.
ALL 6000CMOD, ALL 8000CMOD, 6KMOD, 8KMOD	
ALL CD4236, ALL CD4842, CAL36, CAL42	
ALL CNXT4236, ALL CNXT4842, CAL36X, CAL42X	
MER36, MER42, MER36P, MER42P, MER36MN, MER42MN MERID36, MERID42, MERIDPLA36, MERIDPLA42	
GDST3831, GDST4336, GDCR4136, GDCL4136, GDFL4136, ST-550T-IP1	
RCOR-DV36IN, LCOR-DV36IN, PIER-DV36IN, ST-DV36IN	
ALL NDV3630, ALL NDV3933, ALL NDV4236, ALL NDV4842, NDV30-IFT, NDV33-IFT, NDV36-IFT, NDV42-IFT	
PEARL36PRIN, PEARL36STIN	
ALL NNXT3933, ALL NNXT4236, NNXT33-IFT, NNXT36-IFT	
ST-36TR, ST-36TRB, PIER-36TR, PIER-36TRB, LCOR-36TRB, RCOR-36TRB	
PRIMO48, PRIMO60, PRIMO72, PRIMO48ST, PRIMO60ST, PRIMO72ST	
ALL QUARTZ32, QUARTZ36, QUARTZ42, QUARTZPLA36	
ALL RAVE3012I, ALL RAVE4013I, ALL RAVE32, ALL RAVE 36, ALL RAVE42	
ALL COSMO42-IFT, ALL COSMO36-IFT, ALL COSMO32-IFT, ALL JADE32IN, ALL JADE42IN(L), DVLINEAR36	
SL-550METRO	
SL-550F, SL-750F, SL-5F, SL-7F, SL-5F-IFT, SL-7F-IFT	
SL-5, SL-7, SL-9, SL-5-IFT, SL-7-IFT, SL-9-IFT	
ALL SL-3X, ALL SL-5X, ALL SL-7X, ALL SL-9X	
ODMEZG-36	
MODEL	MINIMUM VENTING BETWEEN APPLIANCE AND PVV-SLP
ALL ESC-42ST	Minimum of one DVP-2SL or DVP-SLP24 adapter followed by six feet of vertical SLP pipe.
ALL HEIR36, ALL HEIR42, ALL HEIR50	
ALL TRUE-36, ALL TRUE-42, ALL TRUE-50 ALL CERONA-36, CERONA-42	
ALL MEZZO36, ALL MEZZO36ST, ALL MEZZO48, ALL MEZZO48ST ALL MEZZO60, ALL MEZZO60ST, ALL MEZZO72, ALL MEZZO72ST ALL CRAVE4836, ALL CRAVE4836ST, ALL CRAVE6048, ALL CRAVE6048ST, ALL CRAVE7260, ALL CRAVE7260ST, ALL CRAVE8472, ALL CRAVE8472ST	
ALL ECHEL36IN, ALL ECHEL36STIN, ALL ECHEL48IN, ALL ECHEL48STIN, ALL ECHEL60IN, ALL ECHEL72IN	
ALL MARQ36IN, ALL MARQ42IN, ALL MARQ42STIN	
ODFORTG-36	

Table 2.1

ADAPTER KITS	
PART NUMBER	PART DESCRIPTION
DVP-SLP24	24 inch section that adapts from 5 in./ 8 in. DVP-series starting collars to 4 in./ 6-5/8 SLP-series vent pipe.
DVP-2SL	Adapts from 5 in./ 8 in. DVP-series starting collars to 4 in./ 6-5/8 SLP-series vent pipe.

### C. Venting Length - Model Categories and Length Requirements by Termination Type

The Model Category (0, 1, 2 or 3) in Table 2.2 (Heat & Glo / Heatilator Models) and Table 2.3 (Majestic and HHT Models) corresponds with the number in the shaded area of the Allowable Vent Length Chart In Table 2.4.

**NOTE:** See the PRIMO install manual (2310-970) for allowed vent configurations for the following SKUs: PRIMO48, PRIMO60, PRIMO72, PRIMO48ST, PRIMO60ST, PRIMO72ST.

HEAT & GLO			HEATILATOR		
Category 0 & 1	Category 0, 1 & 2	Category 0, 1, 2 & 3	Category 0 & 1	Category 0, 1 & 2	Category 0, 1, 2 & 3
	ALL 6000C ALL 6000CL ALL 6000CLX 6K, 6KL, 6KX	ALL COSMO42-IFT	ALL RAVE32-IFT ALL RAVE36-IFT	ALL NDV3630 ALL NDV3933 ALL NDV4236 ALL NDV4842 NDV30-IFT, NDV33-IFT NDV36-IFT, NDV42-IFT	ALL RAVE4013i
	ALL 8000C ALL 8000CL ALL 8000CLX 8K, 8KL, 8KX	ALL ESC-42ST		CAL36, CAL42, ALL CD4236 ALL CD4842	ALL HEIR36 ALL HEIR42 ALL HEIR50
	ALL 6000CMOD ALL 8000CMOD 6KMOD, 8KMOD	ALL TRUE-36 ALL TRUE-42 ALL TRUE-50		CAL36X, CAL42X ALL CNXT4236 ALL CNXT4842	
ALL COSMO32-IFT ALL COSMO32-IFT	SL-550METRO	ALL CERONA-36 ALL CERONA-42		ALL DV3732 ALL DV4236	
	ST-36TR ST-36TRB ST-550T-IPI PIER-36TR PIER-36TRB LCOR-36TRB RCOR-36TRB			GDST3831 GDST4336 GDFL4136 GDCR4136 GDCL4136	
	ALL MEZZO60 ALL MEZZO60ST ALL MEZZO72 ALL MEZZO72ST			ALL CRAVE4836 ALL CRAVE4836ST ALL CRAVE6048 ALL CRAVE6048ST	
	ALL MEZZO36 ALL MEZZO36ST ALL MEZZO48 ALL MEZZO48ST				
	SL-550F, SL-750F SL-5F, SL-7F, SL-5F-IFT, SL-7F-IFT			ALL CRAVE7260 ALL CRAVE7260ST ALL CRAVE8472 ALL CRAVE8472ST	
	SL-5, SL-7, SL-9, SL-5-IFT, SL-7-IFT, SL-9-IFT			NNXT3933 NNXT4236 NNXT33-IFT NNXT36-IFT	
	ALL SL-3X ALL SL-5X ALL SL-7X ALL SL-9X				

**Table 2.2 Models (Heat & Glo and Heatilator Models)**

MAJESTIC			HHT		
Category 0 & 1	Category 0, 1 & 2	Category 0, 1, 2 & 3	Category 0 & 1	Category 0, 1 & 2	Category 0, 1, 2 & 3
ALL JADE32IN	MER36, MER42 MER36P, MER42P MER36MN, MER42MN MERID36, MERID42 MERIDPLA36 MERIDPLA42	ALL MARQ36IN ALL MARQ42IN ALL MARQ42STIN	DVLINEAR36	RCOR-DV36IN LCOR-DV36IN PIER-DV36IN ST-DV36IN	ODFORTG-36
	ALL QUARTZ32 ALL QUARTZ36 ALL QUARTZ42 QUARTZPLA36	ALL JADE42IN ALL JADE 42IL		ODMEZG-36	
	PEARL36PRIN PEARL36STIN				
	ALL ECHEL36IN ALL ECHEL36STIN ALL ECHEL48IN ALL ECHEL48STIN				
	ALL ECHEL60IN ALL ECHEL72IN				

Table 2.3 Models (Majestic and HHT Models)

Vertical Termination														
Total Venting Length (Feet) Includes both horizontal and vertical section of pipe														
# of Elbows	10	20	30	40	50	60	70	80	90	100	110	120	130	140
1	0	0	0	0	1	1	1	1	2	3	These configurations are not allowed.			
2	0	0	0	0	1	1	1	2	3					
3	0	0	0	0	1	1	1	2						
4	0	0	0	1	1	1	2	3						
5	0	0	0	1	1	1	2							
6	0	0	1	1	1	2	3							
7	0	0	1	1	1	2	3							
8	0	1	1	1	1	2								
9	0	1	1	1	1	2								
10	1	1	1	1	2	3								
11	1	1	1	1	2									
12	1	1	1	1	2									

**Note: Maximum number of 90 degree elbows allowed = 6.  
Maximum number of 45 degree elbows = 12.**

Table 2.4 Allowable Vent Runs - Vertical Termination

## D. Setting the PVV-SLP Flue Restrictor

**CAUTION! Risk of Burns! DO NOT install flue restrictor when using PVV-SLP with PRIMO models. Hot glass could cause burns. See appliance Installation Manual for details and PRIMO48 exception.**

- If the burner flames are short, active and jumping, install the flue restrictor. Check the flames and adjust the restrictor again as necessary until flames are stable, strong, and steady.
- If the burner flames are tall, lifting, floating and ghost-like, the restrictor is closed too far and **MUST** be opened.
- If the pilot continuously sparks and does not become steady, the flue restrictor may need to be closed. The requirements in Table 2.5 must still be met.

Distance from PVV-SLP to Appliance	Maximum Allowable Flue Restrictor Setting
6-15 ft.	4-4
16-39 ft.	3-3
Greater than 40 ft.	1-1

Table 2.4

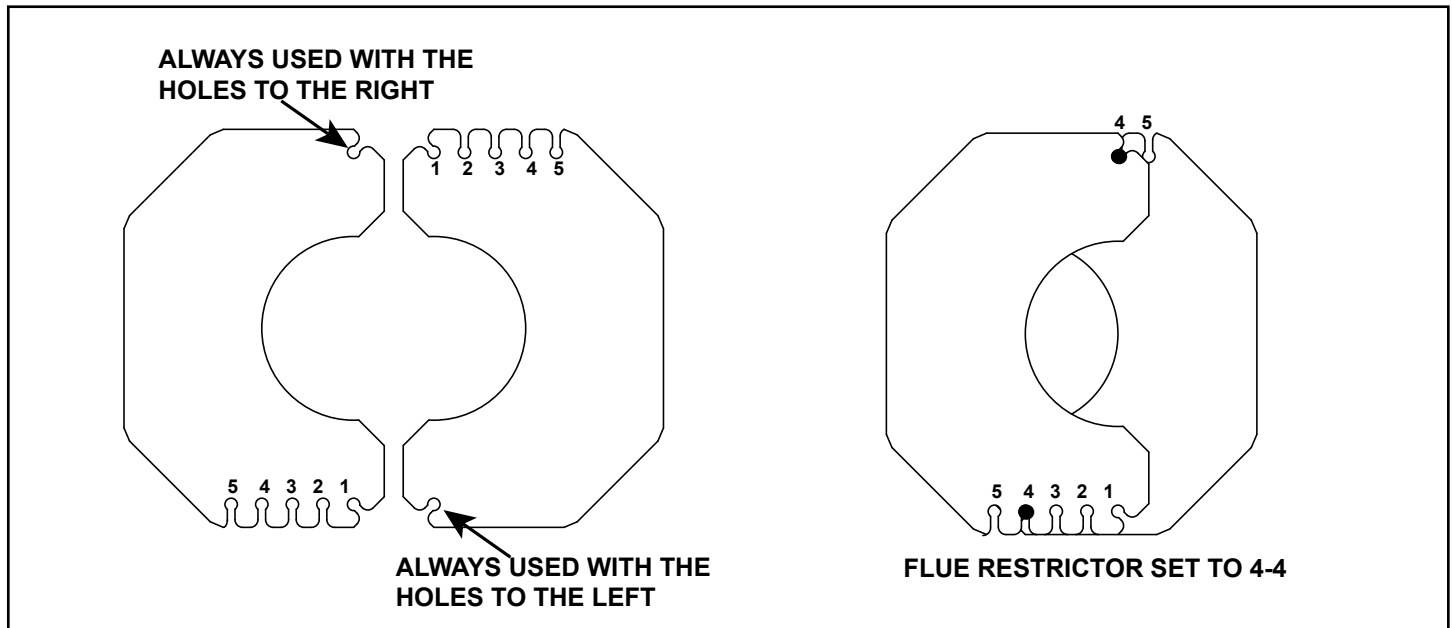

Figure 2.5

# 3 Framing and Clearances

## A. Framing and Clearances

### Chassis Dimensions

The dimensions are measured as shown in Figure 3.1.

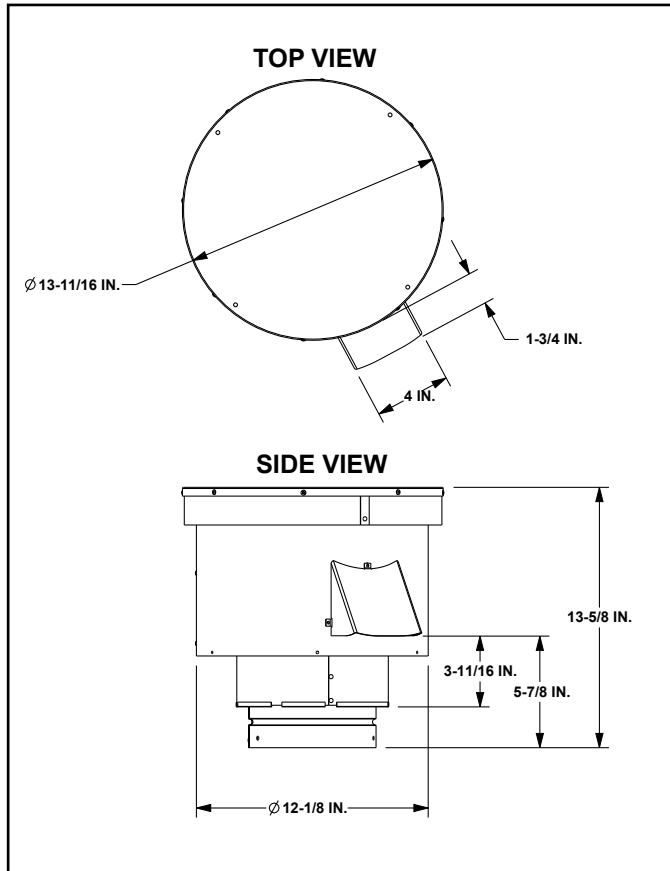

Figure 3.1 Dimensions

## B. Vent Termination Minimum Clearances

⚠ WARNING

**Fire Risk.**  
Maintain vent clearance to combustibles as specified.

- **DO NOT** pack air space with insulation or other materials.

Failure to keep insulation or other materials away from vent pipe may cause overheating and fire.

Refer to the appliance installation manual for information on minimum clearances for vent termination.

Roof Pitch	H (Min.) IN.
Flat to 6/12.....	33.5*
Over 6/12 to 7/12.....	35*
Over 7/12 to 8/12.....	36*
Over 8/12 to 9/12.....	37.5*
Over 9/12 to 10/12.....	39*
Over 10/12 to 11/12.....	40.5
Over 11/12 to 12/12.....	42.5
Over 12/12 to 14/12.....	46
Over 14/12 to 16/12.....	50
Over 16/12 to 18/12.....	54
Over 18/12 to 20/12.....	58
Over 20/12 to 21/12.....	60

\* H minimum may vary depending on regional snowfall. Refer to local codes.

Figure 3.2 Minimum Height From Roof To Lowest Discharge Opening Against Pitch



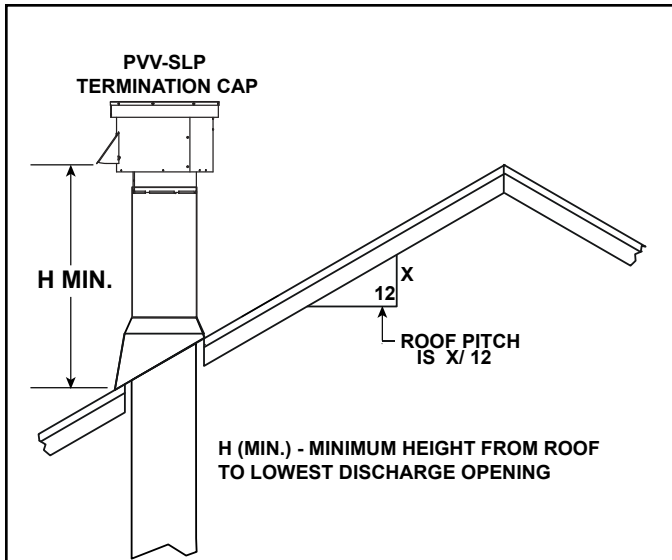

Roof Pitch	H (Min.) IN.
Flat to 6/12.....	25*
Over 6/12 to 7/12.....	23*
Over 7/12 to 8/12.....	21*
Over 8/12 to 9/12.....	19*
Over 9/12 to 10/12.....	17*
Over 10/12 to 11/12.....	16
Over 11/12 to 12/12.....	15
Over 12/12 to 14/12.....	15
Over 14/12 to 16/12.....	15
Over 16/12 to 18/12.....	15
Over 18/12 to 20/12.....	15
Over 20/12 to 21/12.....	15

\* H minimum may vary depending on regional snowfall. Refer to local codes.

**Figure 3.3 Minimum Height From Roof To Lowest Discharge Opening With Pitch**

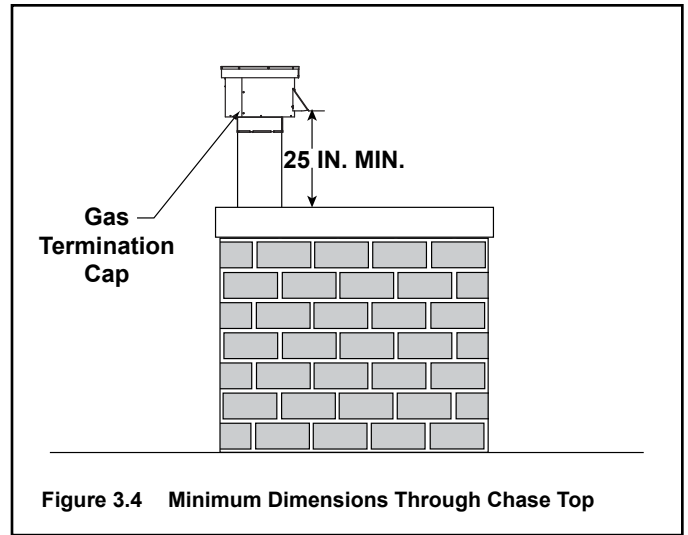

**Figure 3.4 Minimum Dimensions Through Chase Top**

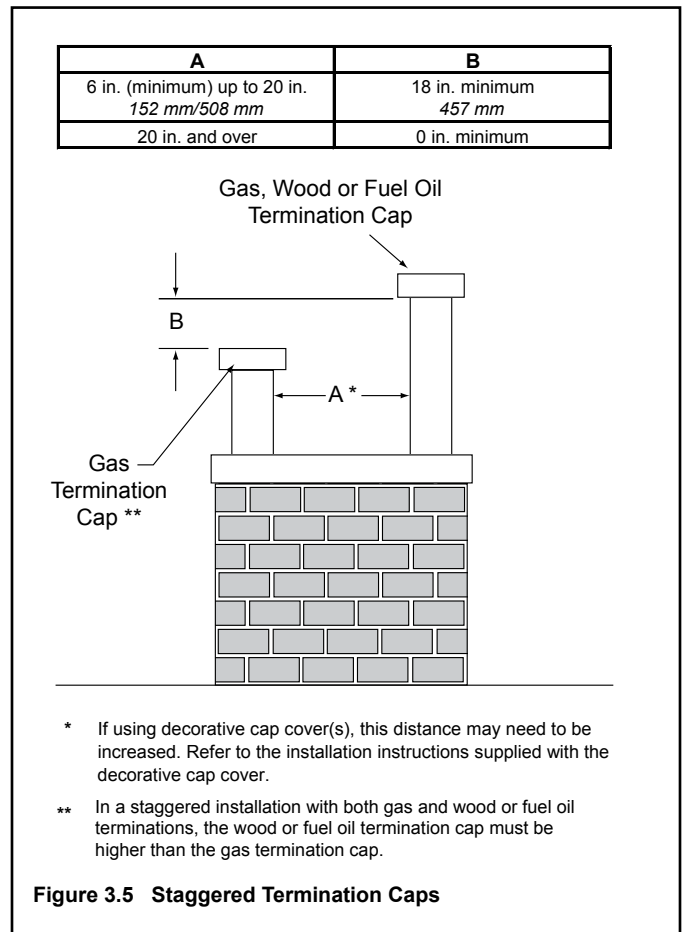

**Figure 3.5 Staggered Termination Caps**

### C. Vent Cap Preparation

1. Remove 4 screws from top cap and lift off the housing assembly. See Figure 3.6.



Figure 3.6 Remove Top Cap Screws

3. Place the PVV-SLP upside down on a flat surface and remove the 4 screws from the PVV-SLEEVE starting collar. Remove the starting collar and set aside. See Figure 3.8.



Figure 3.8 Remove Screws from PVV-SLEEVE Starting Collar

2. Remove the foam shipping support from the PVV-SLP. See Figure 3.7.



Figure 3.7 Remove Shipping Support Foam

4. Ensure there are 8-9 inches of wire extending out of the 90° PVI wire harness fitting. See Figure 3.9.



Figure 3.9 Sufficient Wire Extending Through Bracket

5. Route the PVI wiring harness through the PVV-SLEEVE starting collar and into the cap as shown in Figure 3.10. Reattach the starting collar to the cap as shown in Figure 3.11.

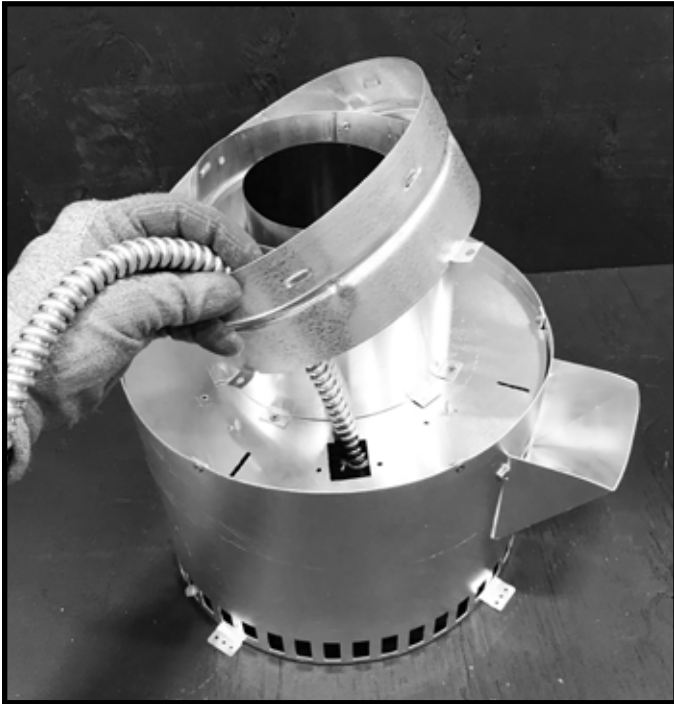

Figure 3.10 Route PVI Wiring Harness

6. Position the cap right side up and attach the PVI wiring harness to the wire harness bracket that came in the manual bag. The orientation of the harness and bracket is shown in Figure 3.12.



Figure 3.12 Attach PVI Wiring Harness to Bracket



Figure 3.11 Attach Starting Collar

7. Attach wire harness bracket to the bottom dish of the cap. See Figure 3.13.



Figure 3.13 Attach Wire Harness Bracket to Bottom Dish

8. Use silicone sealant (300° F minimum continuous exposure rating) to seal around the wire harness where it penetrates the bottom dish from either the inside or the outside of the power vent. See Figure 3.13.
9. Attach the red and brown wires to the pressure switch. See Figure 3.14. Red or brown may be attached to either connector.

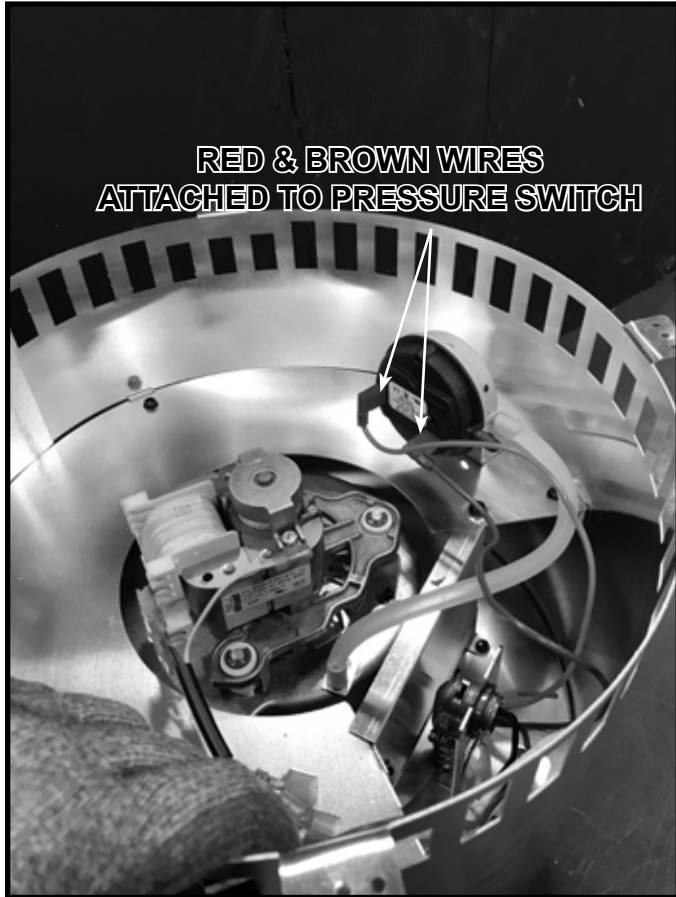

Figure 3.14

10. Attach the white and black wires from the PVI harness to the two black wires coming from the blower. Attach the green wire from the PVI harness to the green/yellow wire coming from the blower. See Figure 3.15.

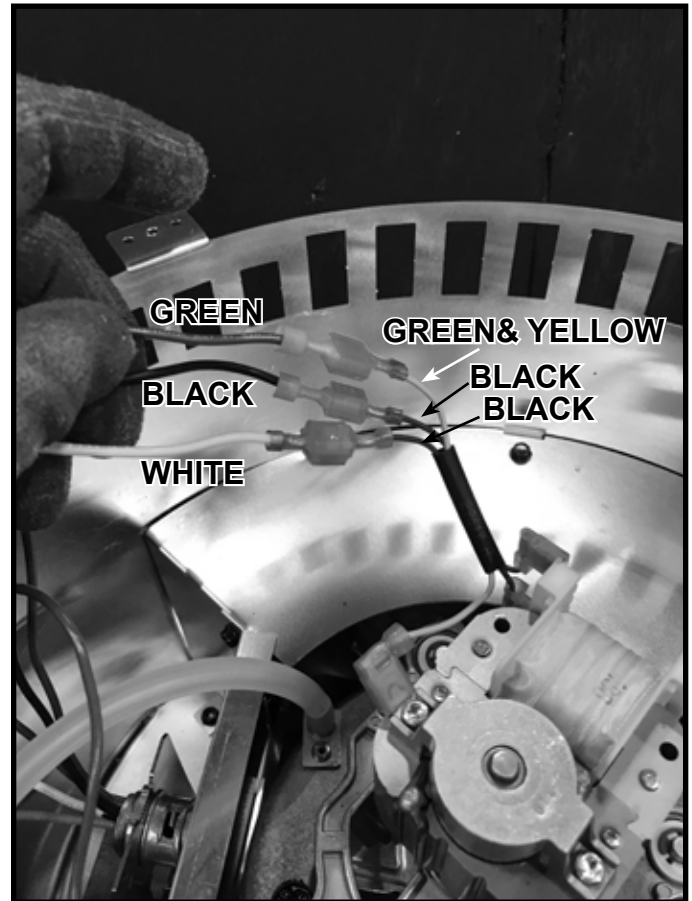

Figure 3.15

11. Use the included zip tie to secure the black, white, and green wires to the PVV-SLP housing. See Figure 3.16.

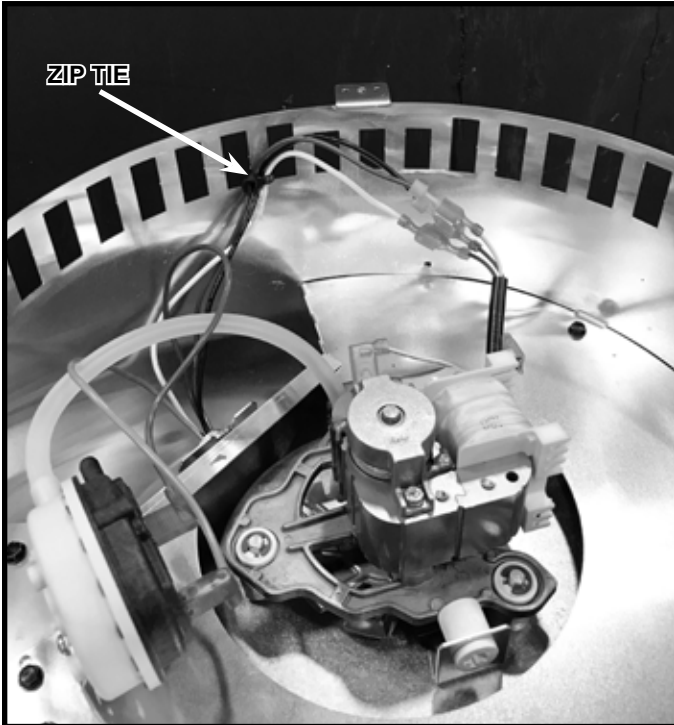

Figure 3.16

12. Reinstall the top cap using the four screws that were removed earlier. The PVV-SLP is now ready to install onto the SLP pipe. See Figure 3.17.



Figure 3.17

## D. PVV-SLEEVE Preparation

**NOTE:** The PVV-SLEEVE must be long enough to penetrate through the roof flashing a minimum of two inches. The PVV-SLEEVE can be cut to size if the vent run does not allow the excess to extend down into the home or chase.

1. Slide the storm collar over the PVV-SLEEVE and use the included bolt and nut to secure it into the formed groove on the PVV-SLEEVE. This will prevent the PVV-SLEEVE from sliding down through the flashing and into the home/chase during installation. See Figure 3.18.

**NOTE:** If more than one PVV-SLEEVE will be used, attach the storm collar to the lowest section of PVV-SLEEVE. Secure all sections of PVV-SLEEVE with self tapping screws.



Figure 3.18 Bolt and Nut Installed

## E. PVV-SLEEVE Installation

1. Route the PVI harness through the sections of PVV-SLEEVE that will be installed. Then route the harness into the flashing opening. See Figure 3.19.



Figure 3.19 Route PVI Harness Through Flashing

2. Slide the PVV-SLEEVE over the SLP pipe and into the opening. Lower the PVV-SLEEVE down to allow the storm collar to rest on the flashing. See Figure 3.20.

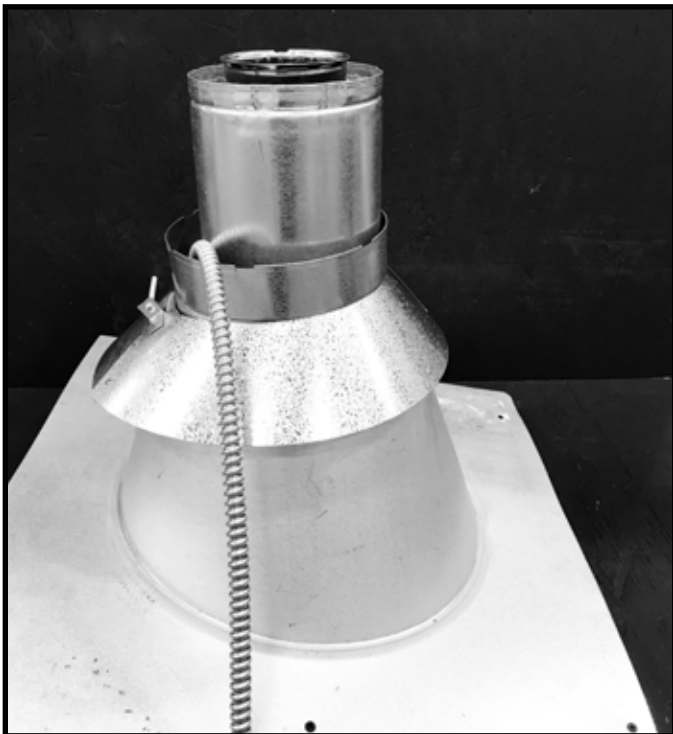

Figure 3.20 Storm Collar Resting on Flashing

3. Feed the PVI harness into the PVV-SLEEVE and install the PVV-SLP onto the SLP pipe. Rotate the PVV-SLP to preferred direction of exhaust flow based on the required clearances. Refer to Section 3.B for more information regarding the positioning of the exhaust. Attach using 3 self tapping screws. See Figure 3.21.



Figure 3.21 Attach PVV-SLP to SLP Pipe

4. Lift the PVV-SLEEVE up to the PVV-SLP and attach to the collar on the PVV-SLP using 3 self tapping screws. Figure 3.22.

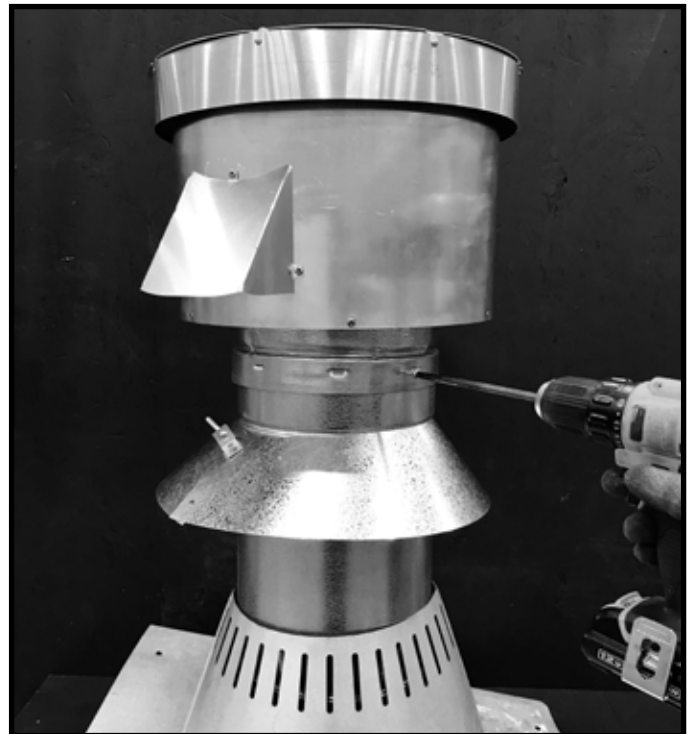

Figure 3.22 Attach PVV-SLEEVE to PVV-SLP Collar

5. Loosen the storm collar and slide it down to the flashing. Secure the storm collar. See Figure 3.23.
6. Using silicone sealant (300 °F minimum continuous exposure rating) seal the seams shown in Figure 3.24



Figure 3.23 Secure Storm Collar in Position on Flashing



Figure 3.24

# 4 Electrical Information

## A. Wiring the Appliance for the PVV-SLP with IntelliFire Touch® (IFT) Controls

**NOTICE:** When integrating the PVV-SLP onto an appliance with IntelliFire Touch (IFT) controls, the RC400 remote control and the Auxiliary Control Module (IFT-ACM) must be equipped on the appliance. The IFT-RC400 kit includes the RC400 and the IFT-ACM.

**NOTICE:** Electrical wiring must be done in accordance with national, provincial, and/or local electric codes.

**CAUTION! Risk of shock!** Disconnect electrical power from fireplace/power vent before performing any maintenance, repair, or electrical wiring.

**NOTICE:** Electrical service of 120 VAC-60Hz must be supplied to the junction box of the fireplace in order for the power vent to operate correctly.

## REMOVAL OF UNNECESSARY PARTS

Refer to Figure 4.1 for steps 1 through 4. Some features may or may not exist on appliance. The shaded portion corresponding to the numbered step is the task to be performed.

1. Unplug control module power.
2. Remove and discard battery pack (if present).
3. Detach wires from 6 pin harness that connect an optional appliance on/off control (if present) and discard.
4. Remove jumper/splitter wire (if present) and discard.



## WARNING



### Risk of Fire!



### Explosion Hazard!

- Power Vent must be paired to IFT-ACM before installation is complete.
- If you have 120 VAC Power & Gas to appliance:
  - Immediately after connecting the PVI-WH connector to the IFT-ACM, the IFT control must be paired to recognize the Power Vent as part of the control configuration.
  - Appliance and Power Vent function must be verified before installation is complete.
  - Consult installation manuals for details.
- If you DO NOT have 120 VAC Power & Gas:
  - DO NOT connect PVI-WH connector to IFT-ACM.
  - Disconnect 6V power to lock-out appliance.

**Failure to follow instructions could result in a fire or explosion.**



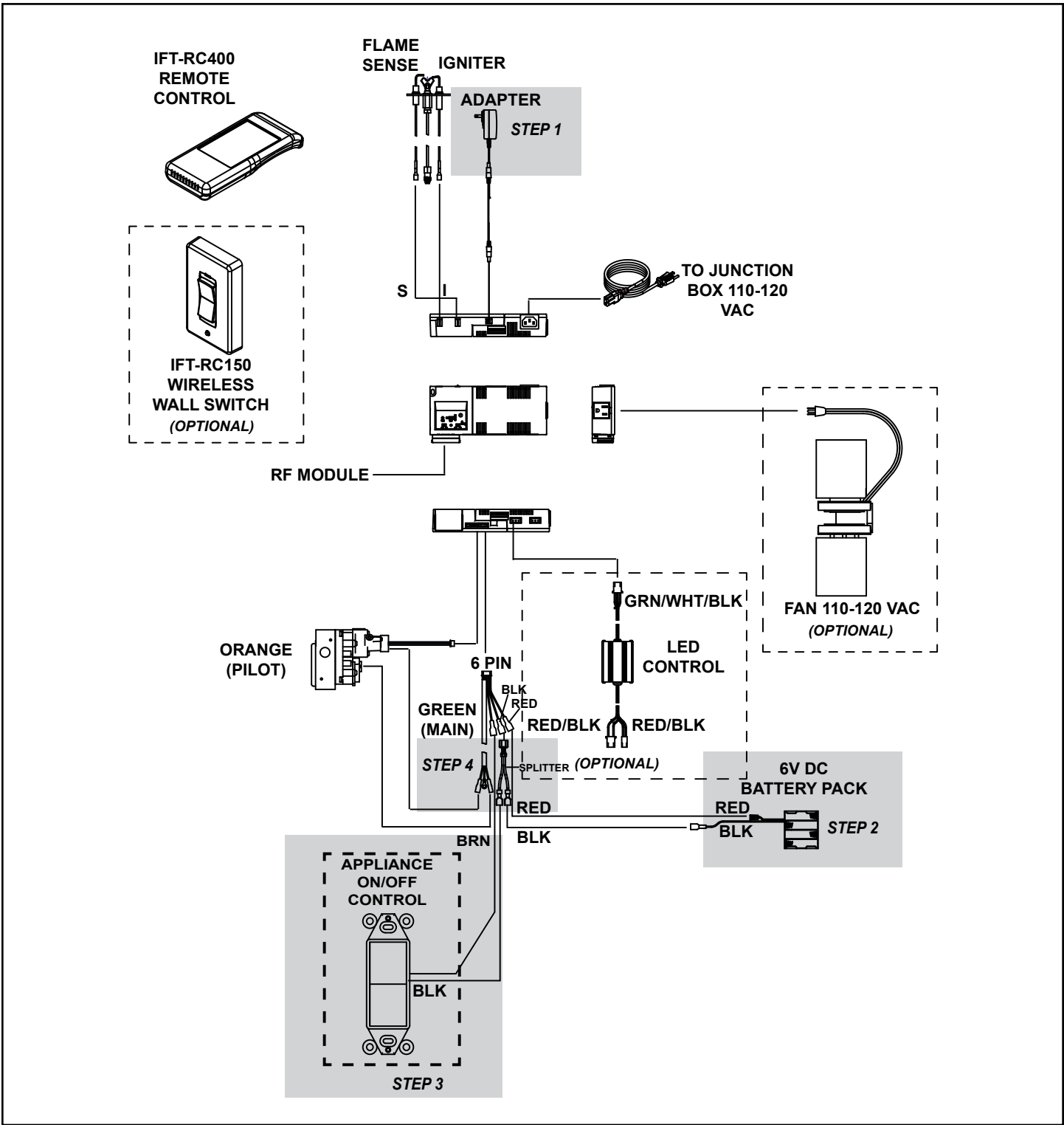

Figure 4.1 IFT-RC400 Wiring Diagram without Power Vent

## Installation Steps:

If the appliance is equipped with an IFT-ACM, proceed to step 10. If not, proceed to next step.

5. Locate the IntelliFire Touch electronic control module (IFT-ECM) in the control cavity of the appliance and move the three-position switch to the OFF position. See Figure 4.2.
6. Remove protective rubber cap from connector on the top of the IFT-ECM. See Figure 4.2.

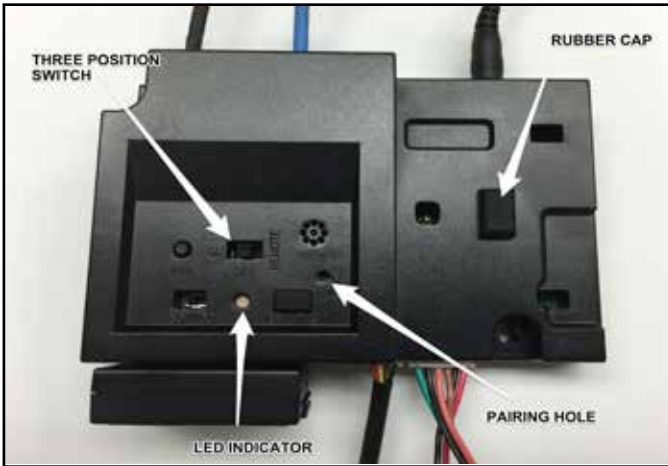

Figure 4.2 IFT-ECM

7. Attach velcro included with the IFT-ACM to the bottom of the ACM. See Figure 4.3.
8. Connect the IFT-ACM to the IFT-ECM by aligning the pins and tabs and pushing the IFT-ACM into the IFT-ECM until both tabs latch in place. Ensure the IFT-ECM and IFT-ACM are aligned with each other and fastened securely. See Figure 4.3.



Figure 4.3 Connecting IFT-ACM and IFT-ECM

**WARNING! Risk of Shock! DO NOT touch male pins.** Leave rubber cap on all ports unless port is being connected to a load.

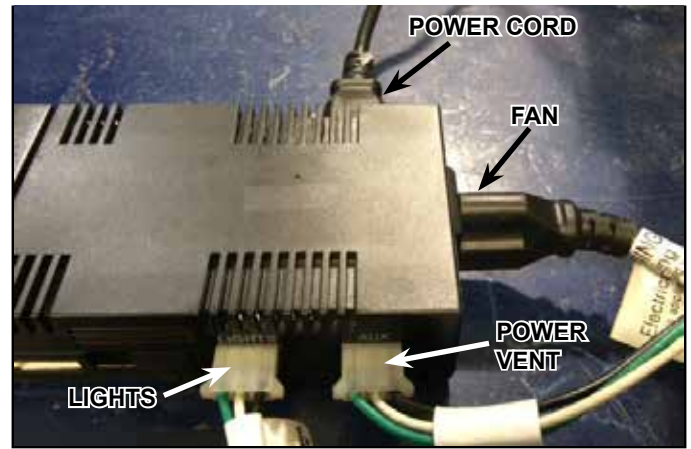

Figure 4.4 Fan, Lights and Power Vent Connection

9. The IFT-ACM can provide power to HHT approved options including fan, lights and power vent.
  - To connect a fan kit to the IFT-ACM, insert the three prong male plug from the fan into the receptacle located on the right side of the IFT-ACM. See Figure 4.4.
  - To connect a light kit to the IFT-ACM, remove protective rubber cap labeled 'LIGHTS' and connect to the female cord that was supplied in your lights kit into the three male pins on the IFT-ACM. See Figure 4.4.
  - To connect a power vent kit to the IFT-ACM, remove protective rubber cap labeled 'AUX' and connect to the female cord of the PVI-WH wire harness into the three male pins on the IFT-ACM. See Figure 4.4.

**WARNING! Risk of Shock! DO NOT touch male pins.** Leave rubber cap on all ports unless port is being connected to a lead.

**NOTE:** It will be necessary to re-pair the remote after installing HHT approved options to the appliance. Refer to Section 4C for pairing the remote.

10. Refer to wiring diagram with Power Vent to make remaining connections. See Figure 4.5.

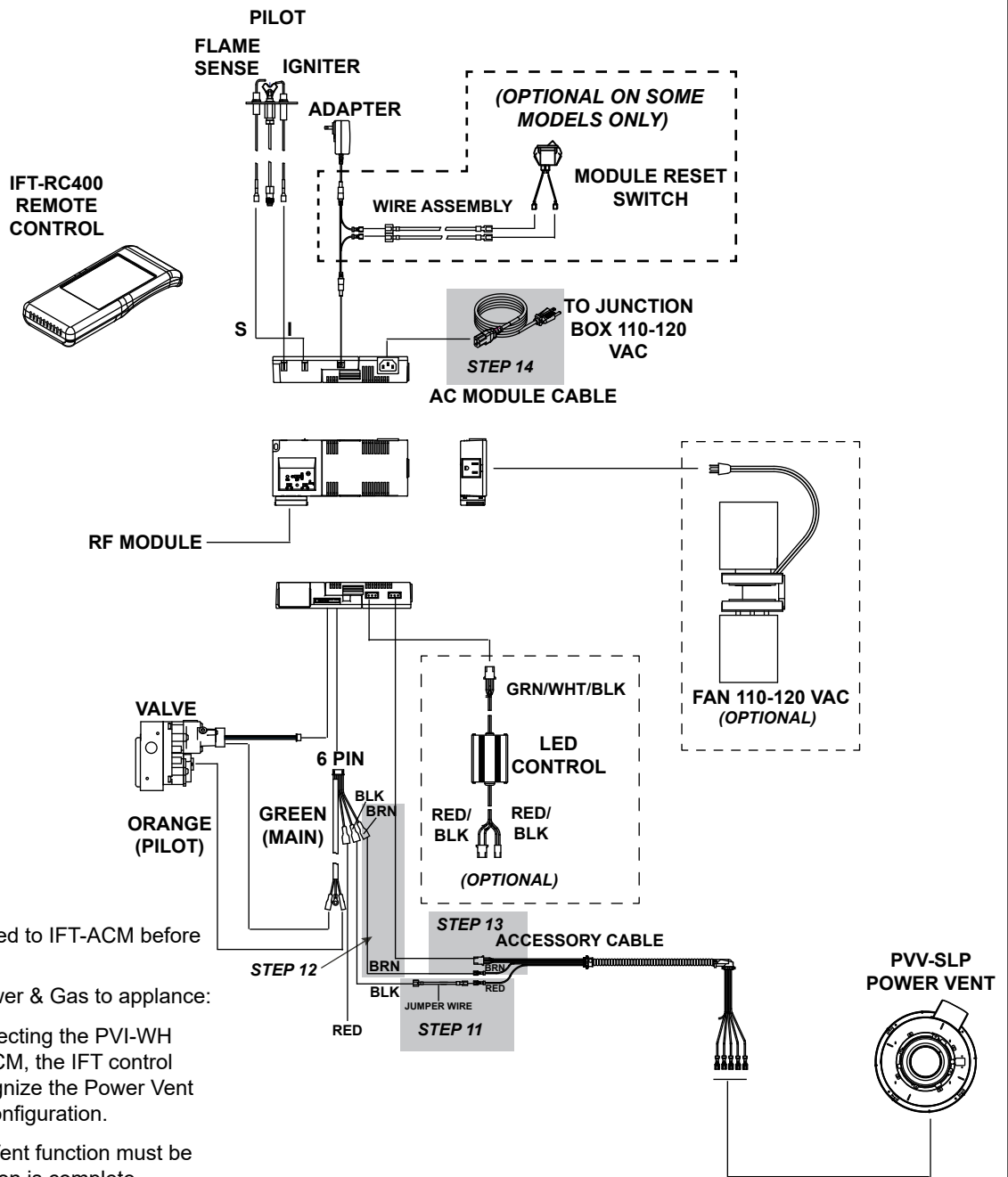

**WARNING!**

- Power Vent must be paired to IFT-ACM before installation is complete.
- If you have 120 VAC Power & Gas to appliance:
  - Immediately after connecting the PVI-WH connector to the IFT-ACM, the IFT control must be paired to recognize the Power Vent as part of the control configuration.
  - Appliance and Power Vent function must be verified before installation is complete.
  - Consult installation manuals for details.
- If you DO NOT have 120 VAC Power & Gas:
  - DO NOT connect PVI-WH connector to IFT-ACM.
  - Disconnect 6V power to lock-out appliance.

**Failure to follow instructions could result in a fire or explosion.**

Figure 4.5 IFT-RC400 Wiring Diagram with Power Vent

11. Attach jumper wire included in manual bag of Power Vent between black wire on 6 pin harness and red wire on accessory cable. See Figure 4.5.
12. Attach brown wire from 6 pin harness to brown wire on accessory cable. See Figure 4.5.
13. Plug connector plug on accessory cable into AUX port on IFT-ACM. See Figure 4.5.
14. Plug power cord from IFT-ACM to junction box. This will already be plugged in if equipped on appliance, or it is included in the IFT-ACM kit if the appliance is not equipped with an IFT-ACM
15. Restore Power to the control module.

## B. Wiring the Appliance for the PVV-SLP with IntelliFire® and IntelliFire® Plus (IPI) Controls

**NOTICE:** The 8K1-PVI control module must be used to integrate the PVV-SLP to the fireplace. (The 8K1-PVI is included with the PV-IPI-CK which is sold separately. When installing the PVV-SLP on PRIMO models the 8K1-PVI is included with the fireplace.)

**NOTICE:** Electrical wiring must be done in accordance with national, provincial, and/or local electric codes.

**CAUTION! Risk of shock!** Disconnect electrical power from fireplace/power vent before performing any maintenance, repair, or electrical wiring.

**NOTICE:** Electrical service of 120 VAC-60Hz must be supplied to the junction box of the fireplace in order for the power vent to operate correctly.

## REMOVAL OF UNNECESSARY PARTS

Refer to the appropriate directions depending on the color of the IPI module (Black or Green.)

### IntelliFire Plus IPI Module (Black)

Refer to Figure 4.6 for steps 1 through 7. The shaded portion corresponding to the numbered step is the task to be performed.

1. Unplug control module power.
2. Detach the white and orange wires from the control module.
3. Detach the remaining harnesses from the control module.
4. Remove the black control module. This will no longer be needed.
5. Remove and discard battery pack (if present).
6. Unplug wall switch wires (if present).
7. Remove and discard IPI wire harness.

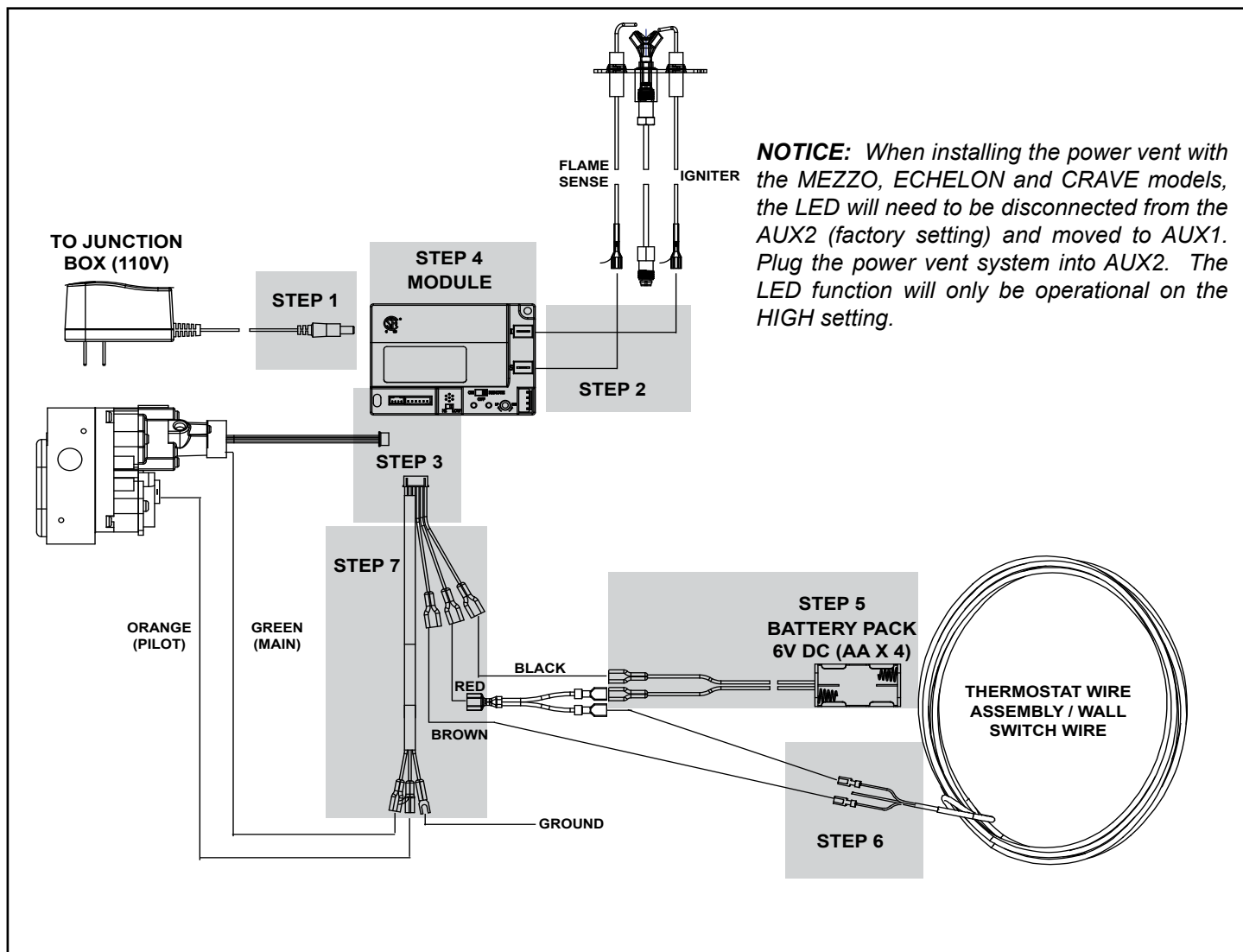

Figure 4.6 IntelliFire Plus (Black) IPI Module Wiring as Shipped from Factory

## INSTALLATION

The type of control used to power the appliance is the determining factor in making the appliance compatible with the PVV-SLP.

- A 7/8 in. diameter hole must be bored in the side of the fireplace outer wrap in which the 5 wires from the power vent will be routed. The hole should be located 2 inches to the side of the junction box and 4-inches up from the base of the fireplace.

## IntelliFire Plus IPI Module (Black)

1. Attach the new 8K1-PVI module to the 6V transformer.
2. Connect the pilot wires (white to S and orange to I) to the 8K1-PVI module.
3. Connect the new Aux RC300 to the 8K1-PVI module.
4. Plug the Aux RC300 into the Junction Box.
5. Attach the 8K1-PVI wire harness to the 8K1-PVI module. Connect green and orange valve wires and reconnect ground wire to chassis.
6. Connect the accessory cable coming from the PVV-SLP to the AUX RC300 (AUX 2 port) and the corresponding colored wire on the wire harness.
7. Connect the stepper motor wires to the 8K1-PVI module.

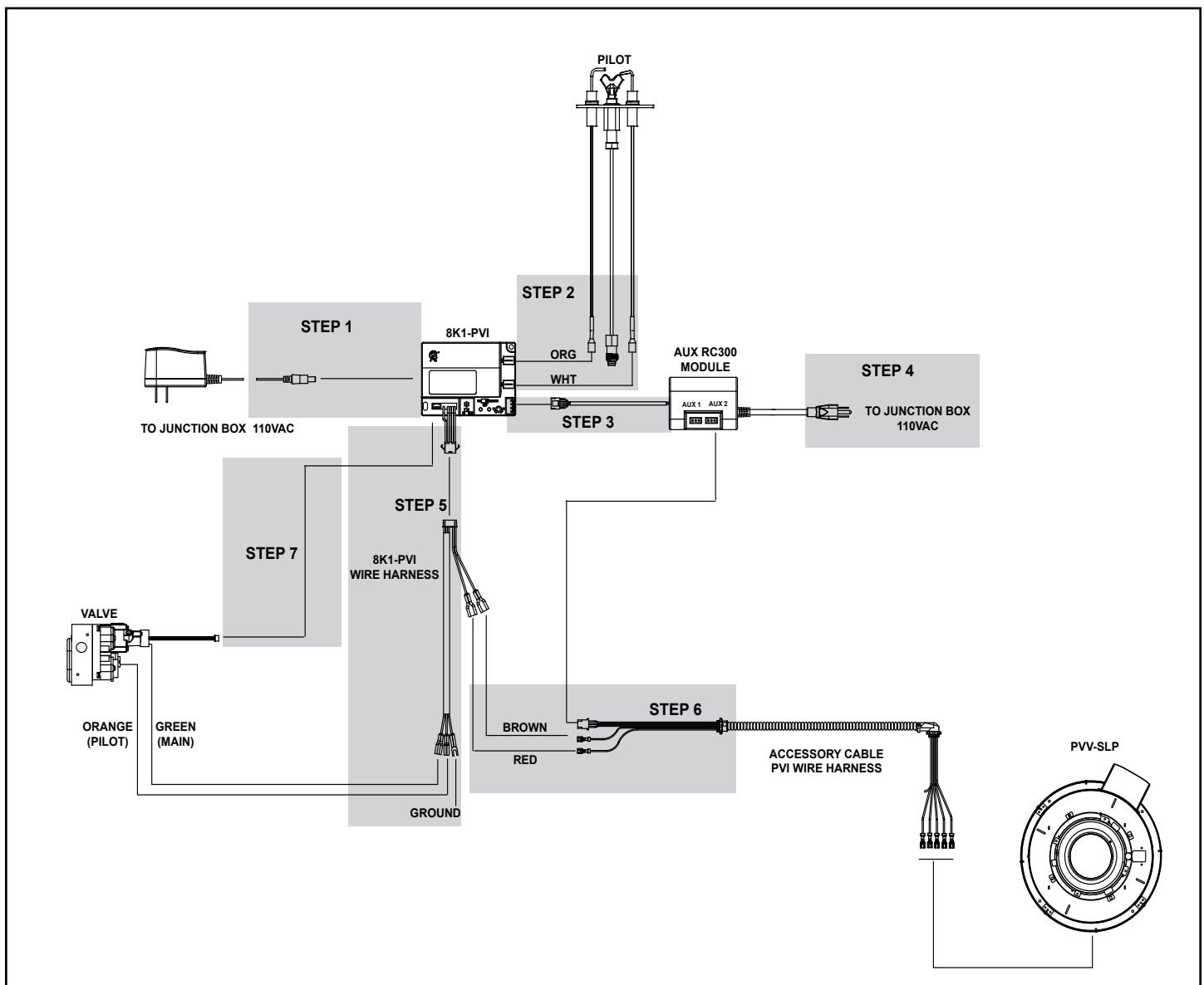

Figure 4.7 PVV-SLP Wiring for IntelliFire Plus RC100, RC200, RC300 Controls

## IntelliFire IPI Module (Green)

Refer to Figure 4.8 for steps 1 through 6.

1. Remove and discard wire harness connecting the valve to the control module.
2. Unhook the 3V transformer and discard. This will no longer be used.
3. Remove and discard battery pack (if present).
4. Detach the white and orange wires from the control module.
5. Remove the green control module. This will no longer be used.
6. Unplug wall switch wires (if present).

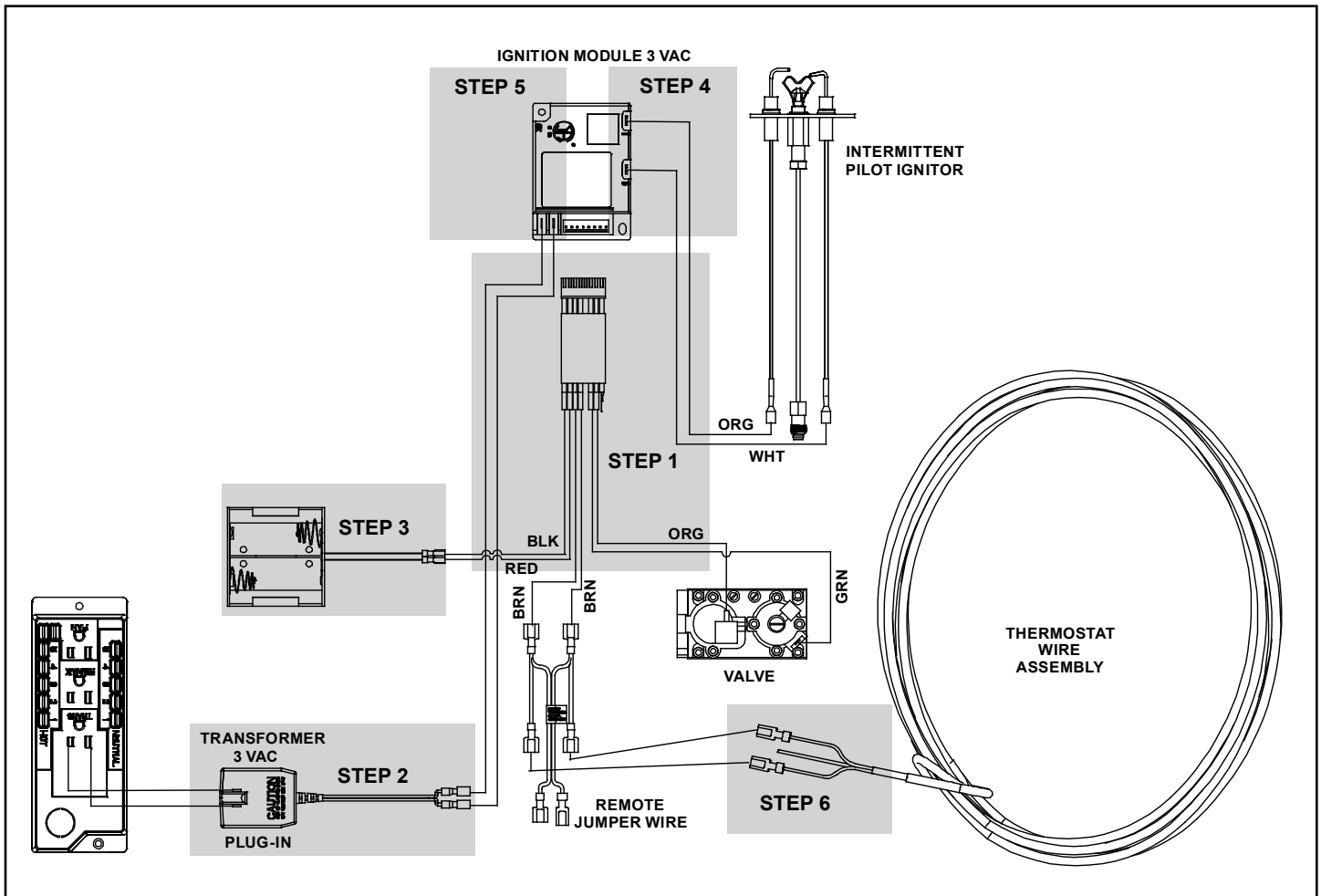

Figure 4.8 IntelliFire (Green) IPI Module Wiring as Shipped from Factory

## IntelliFire IPI Module (Green)

1. Attach the new 8K1-PVI module to the 6V transformer.
2. Connect the pilot wires (white to S and orange to I) to the 8K1-PVI module.
3. Connect the new Aux RC300 to the 8K1-PVI module.
4. Plug the Aux RC300 into the Junction Box.
5. Attach the 8K1-PVI wire harness to the 8K1-PVI module. Connect green and orange valve wires and reconnect ground wire to chassis.
6. Connect the accessory cable coming from the PVV-SLP to the AUX RC300 (AUX 2 port) and the corresponding colored wire on the wire harness.

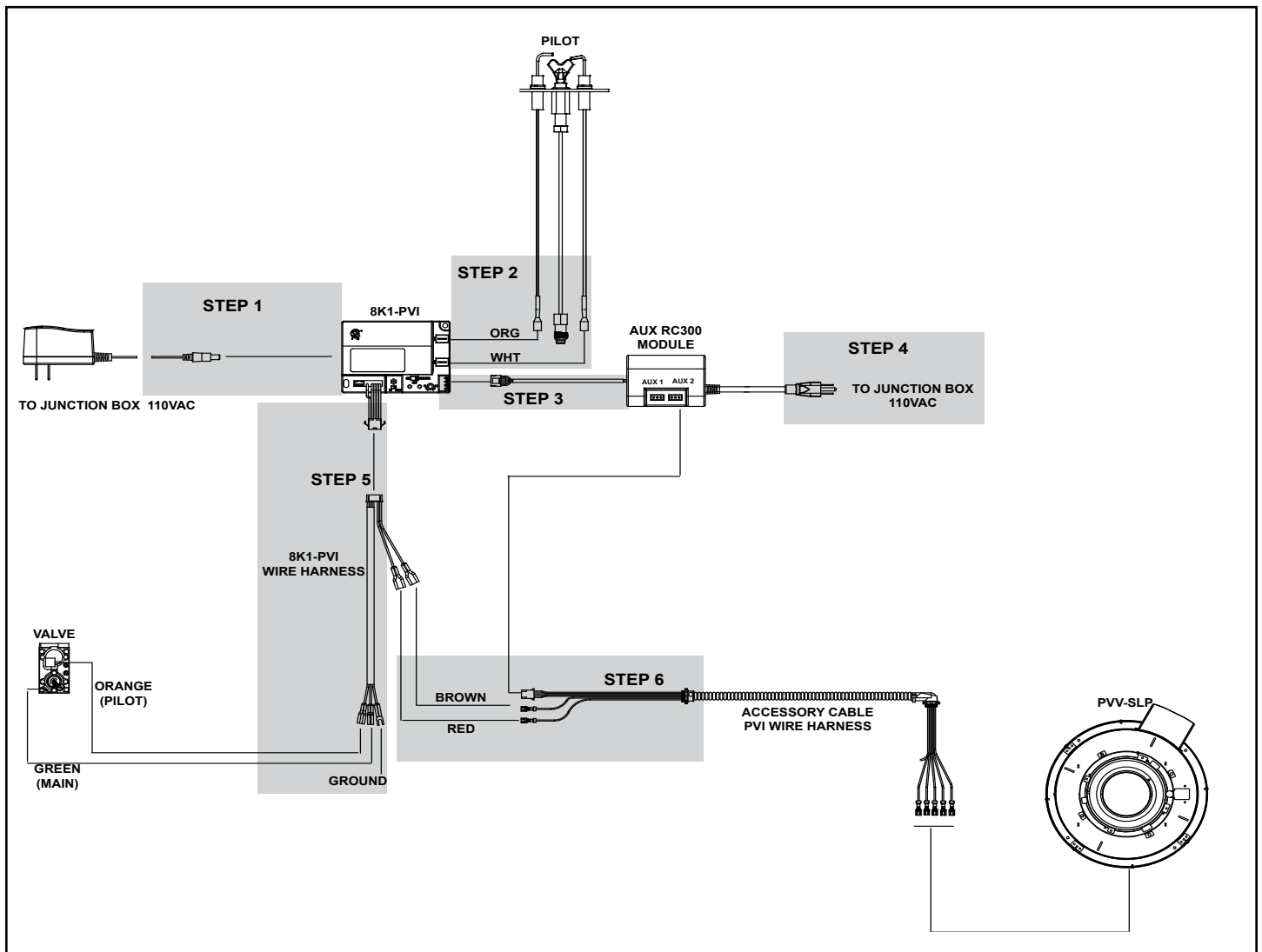

Figure 4.9 PVV-SLP Wiring for IntelliFire IPI Module

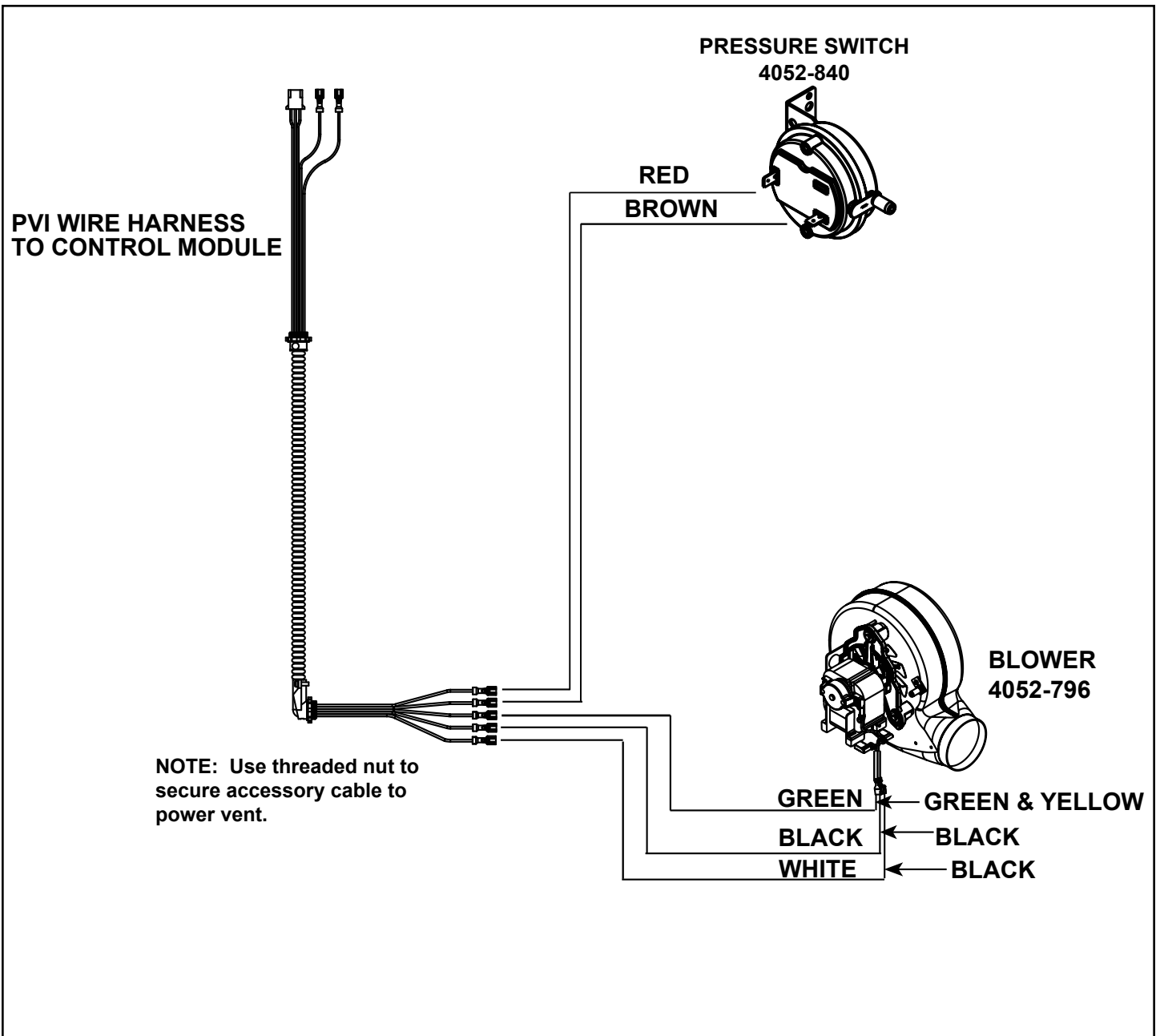

Figure 4.10 Internal PVV Wiring



### C. Pairing or Re-pairing the IFT-RC400 to the Electronic Control Module (IFT-ECM)

**WARNING!** After installation of Power Vent components, the RC400 and IFT-ECM **MUST BE** Re-Paired for safe operation.

**CAUTION! Risk of Burns!** DO NOT program the IFT Remote Controls to the IFT-ECM when flame or cold climate function is on or when appliance is hot.

1. On the IFT-ECM, move the ON/OFF/REMOTE switch to the REMOTE position. The green LED will blink three times. A few seconds later, an audible “beep” will occur to indicate that the system is ready.

**NOTE:** If the green LED continues to blink slowly (system is searching for a clear channel), wait until it stops before proceeding to step 2.

2. Locate the pairing hole on the IFT-ECM. See Figure 4.11. Using a paper clip or similar item, press and release the pairing button. The IFT-ECM will “beep” once and the green LED will blink for 14 seconds. During the 14 seconds, it is normal for installed accessories such as lights, fan, and Power Vent to energize momentarily.

While the green LED on the IFT-ECM is blinking, tap anywhere on the gray indicator bar located at the top of the IFT-RC400 screen. Tap on the pairing function as shown in Figure 4.12. If the IFT-RC400 has been paired successfully to the IFT-ECM, a double audible “beep” will be heard from the IFT-ECM.

**NOTE:** If the RC400 displays the 'Now pairing remote to product' display as shown below **before** able to reach the diagnostic menu on remote, you must repeat the process as follows;

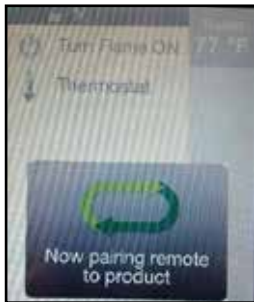

- A. Remove one battery from the RC400.
  - B. Press the pairing button on the IFT-ECM.
  - C. Quickly install the battery into the RC400.
  - D. As soon as the main screen appears, tap on the RC400 gray indicator bar. Then immediately tap the pairing icon. Successful pairing will be indicated by a double beep from the IFT-ECM.
3. If the pairing is unsuccessful, repeat steps 1 & 2.

**NOTE:** If additional components are added such as blowers, lights or Power Vent after initial pairing, the pairing process must be repeated again to detect additional components.

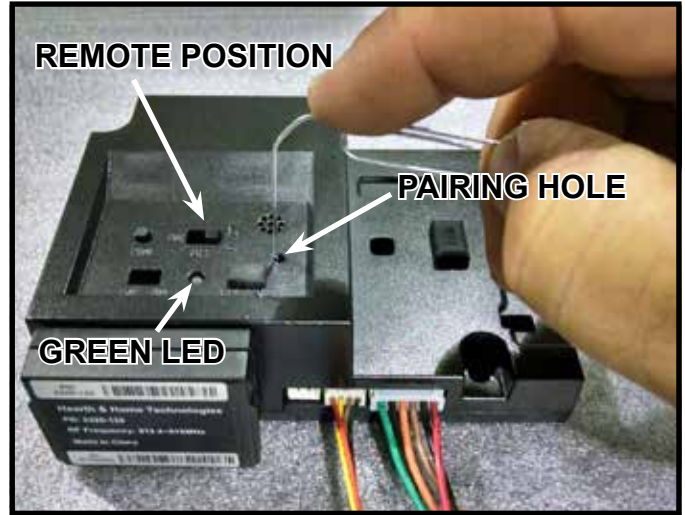

Figure 4.11 Pairing IFT-ECM



Figure 4.12 IFT-RC400 Wall Mount / Pairing Screen

**NOTE:** Refer to Operating Guide and Troubleshooting Section of IFT-RC400 Installation Manual for Operation and Maintenance Sections of Remote Control.

# 5 Operating Instructions

## A. Installation Inspection

1. Follow safety inspection procedures recommended by national, provincial, and/or local codes.
2. Be certain all electrical connections are properly made and secure.
3. Visually inspect the vent system and determine that there is no flue gas spillage, blockage or restriction, leakage, corrosion or other unsafe deficiencies.
4. Verify that the flue restrictor is set correctly. See Section 2.D.

**CAUTION! Risk of electrical shock! DO NOT allow 120VAC wires to contact hot metal surfaces. Use supplied wire ties to bundle wires away from flue pipe, fan housing and other metal surfaces.**

## B. Power Vent Operating Instructions

After installation of the power vent, follow the operation instructions below for the type of control system/remote control used (IPI Plus/RC300, IFT/RC400/RC150).

### IFT/RC400

1. Touch screen on RC400 to wake up.
2. Touch 'Turn Flame On'.
3. Observe touch screen - if system is configured properly for Power Vent Operation, a 2 min countdown timer will be displayed next to 'Turn Flame OFF'. See Figure below.

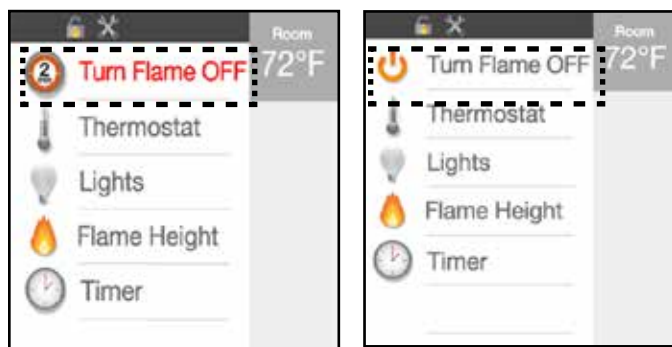

**CORRECT PV DISPLAY      INCORRECT PV DISPLAY**

If RC400 display is incorrect, touch 'Turn Flame OFF' and refer to troubleshooting section.

4. If the RC400 display is correct, the Power Vent will be running and the 2-minute countdown timer will run, after which the pilot will ignite followed by the main burner.
5. Touch 'Turn Flame OFF' on the RC400. The pilot and main will extinguish. The Power Vent will continue to run for 20 min.

**WARNING! After installation of Power Vent components, the RC400 and IFT-ECM MUST BE re-paired for safe operation.**

### IPI Plus/RC300

1. Turn the remote "ON".

**NOTE:** During the period of operation after turning the fireplace "ON", there will be a delay (approx. 120 seconds) before the fireplace ignites. This is due to the time necessary for the fan to reach operating speed and to remove any gases from the combustion chamber.

2. After turning the remote to the "ON" position, if the fireplace does not turn on, turn the remote to "OFF" refer to the troubleshooting section.
3. Turn the remote to "OFF" to turn off the burner. The power vent will continue to run for 20 minutes.

## C. Maintenance

**WARNING! Risk of Shock!** Before performing any maintenance or repair to the power vent assembly, make sure electrical power is disconnected to the fireplace.

1. Vent System: Inspect all components and connections annually. Replace, seal, or tighten pipe connections if necessary.
2. Motor: The fan motor bearings are sealed and no further lubrication is necessary. To access the motor, pressure switch or pressure sense tube, refer to Section 5.D.

## D. Replace Blower/Pressure Switch

**WARNING! Risk of Shock!** Before performing any maintenance or repair to the power vent assembly, make sure electrical power is disconnected to the fireplace.

**NOTE:** Retain all fasteners for use in the reassembly process. Follow instructions in reverse order to assemble.

1. Remove top cap and set aside. See Figure 5.1.
2. Note that the light gray (-) port has the teflon tubing attached. Remove Teflon tubing from pressure switch. See Figure 5.2.
3. Remove the 2 wires from the pressure switch. See Figure 5.3.



Figure 5.2 Remove Teflon Tubing

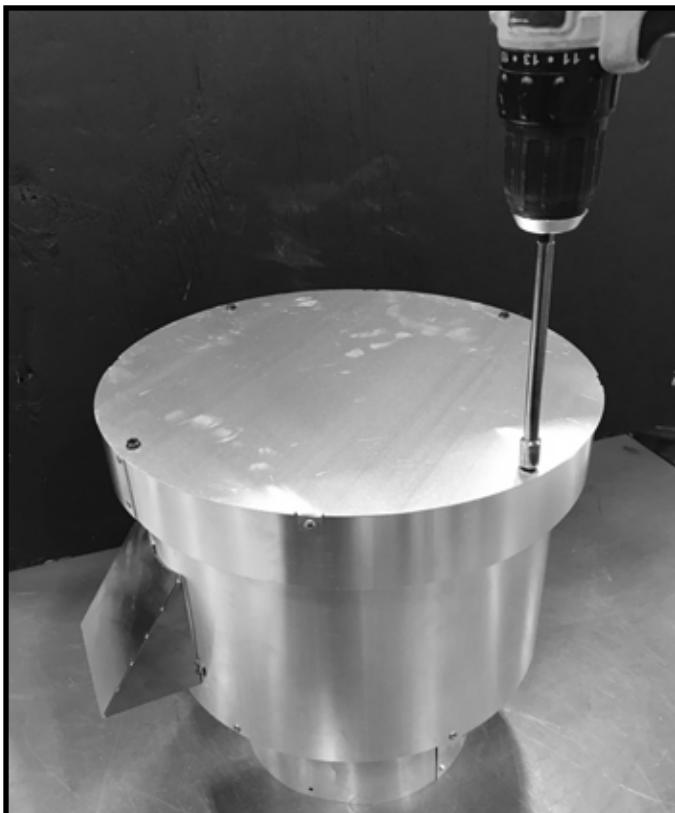

Figure 5.1 Remove Top Cap



Figure 5.3 Remove Wires from Pressure Switch

4. Remove the screws holding the pressure switch bracket to the heat shield. See Figure 5.4.
5. Remove the teflon tubing from the blower. See Figure 5.5.

6. Remove hot, neutral, ground wires from the blower. See Figure 5.6.

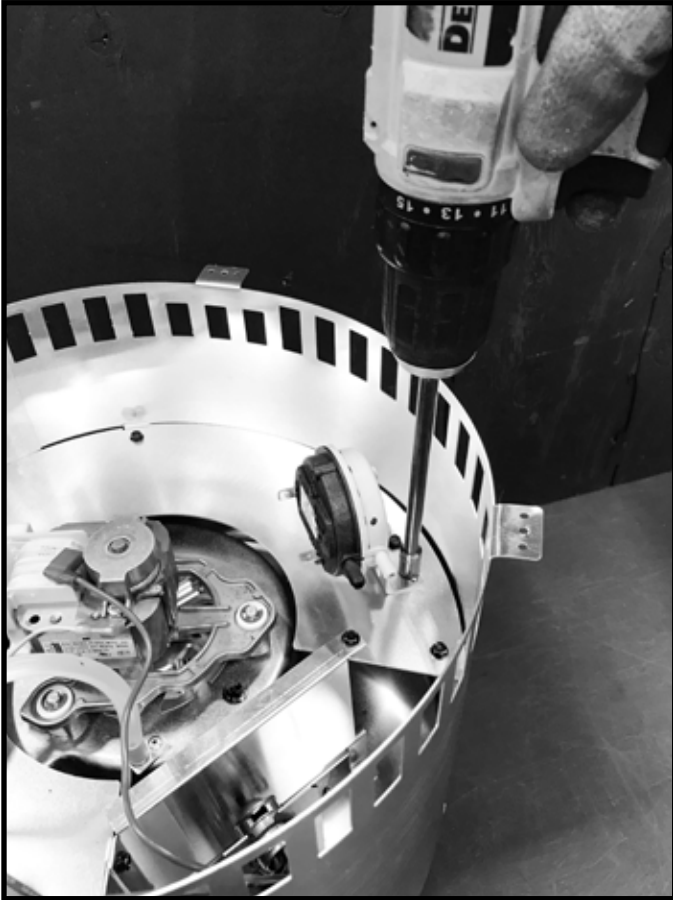

**Figure 5.4 Remove Screw**

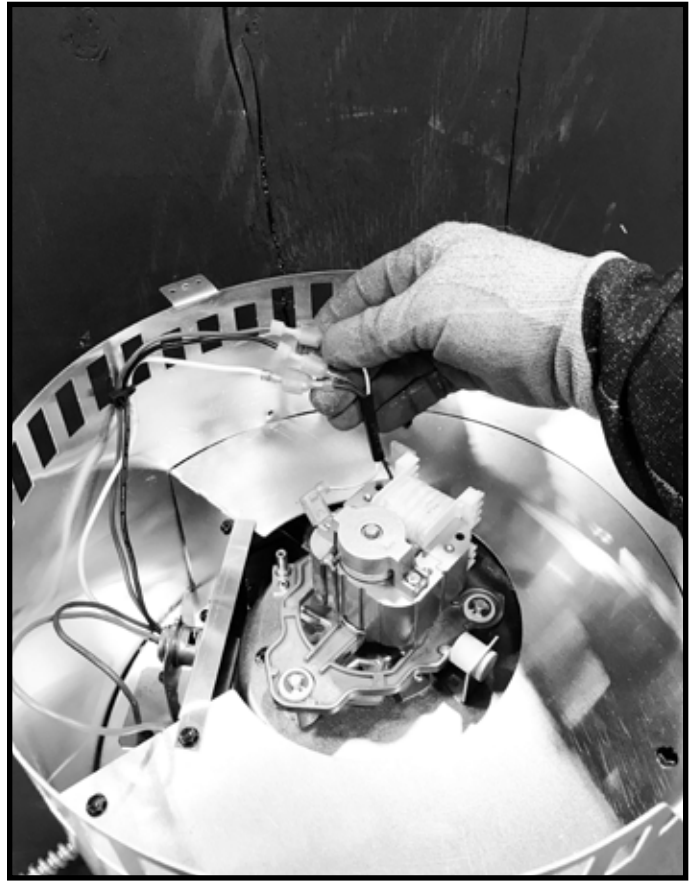
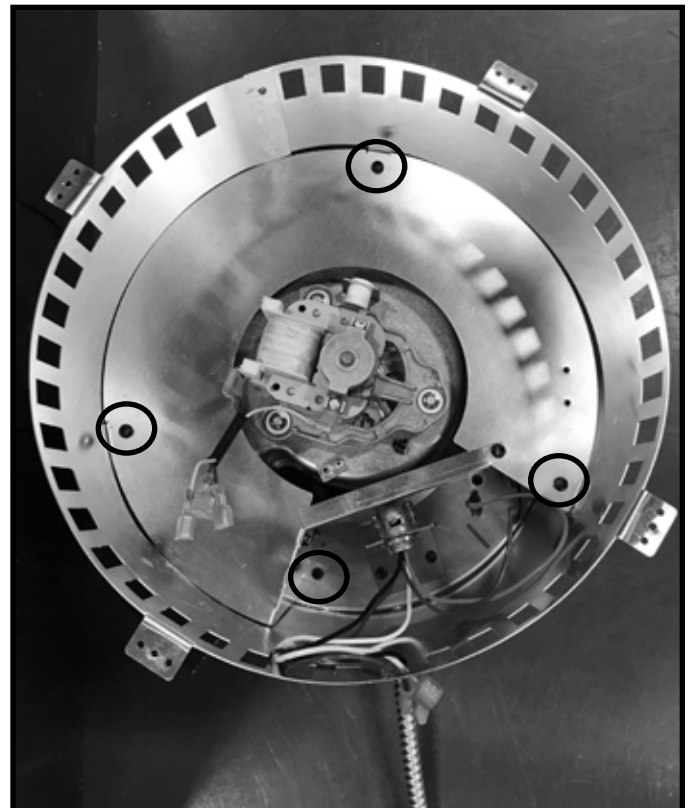

**Figure 5.6 Remove Hot, Neutral and Ground Wires**

7. Remove the four screws from the heat shield assembly and carefully lift it from the power vent. See Figure 5.7.



**Figure 5.5 Remove Teflon Tubing from Blower**



**Figure 5.7 Remove Heat Shield**

8. Remove the 4 screws holding the blower plate to the blower bracket assembly and the screw attached to the blower extension. See Figure 5.8.

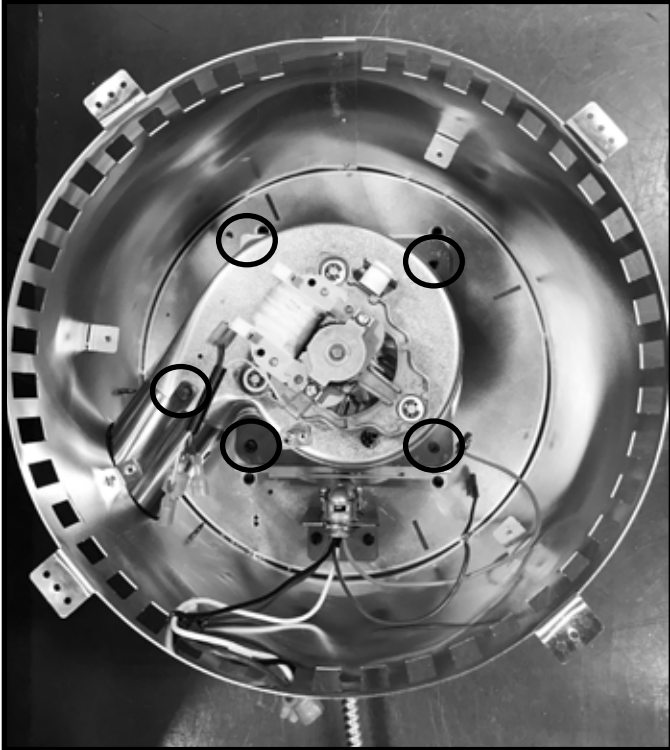

Figure 5.8

9. Slide the blower out of the blower extension and lift it out of the power vent housing. See Figure 5.9.

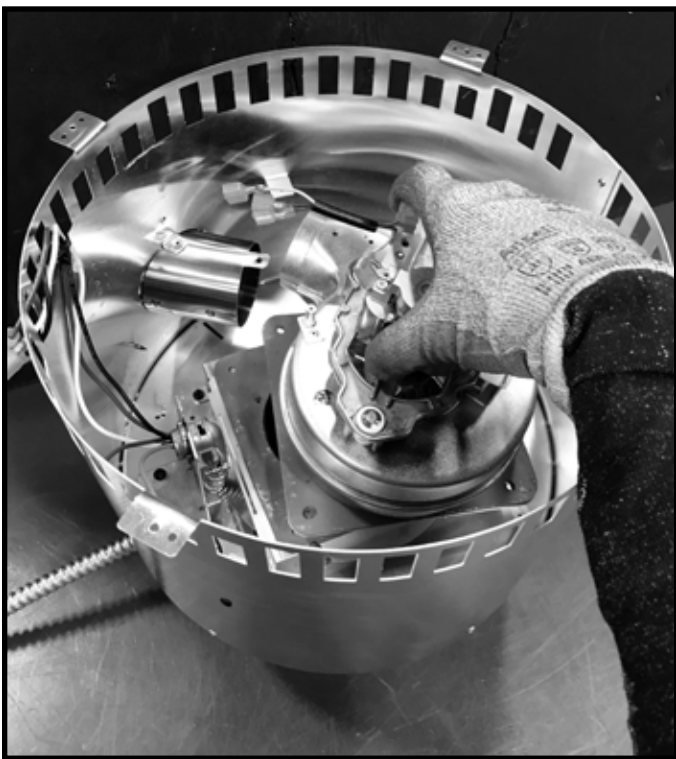

Figure 5.9 Remove Blower Assembly

10. Remove the three screws holding the blower to the blower plate. See Figure 5.10.

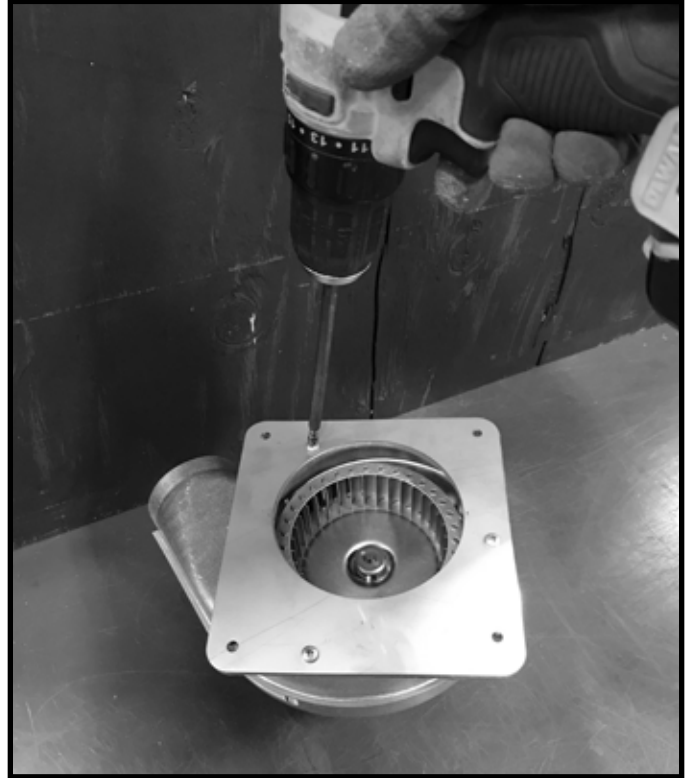

Figure 5.10

# 6 Reference Materials

---

## A. Components and Service Parts List

### Service Parts List

Replacement parts can be obtained from your dealer. Repair of the Power Vent should only be done by a qualified service technician.

### Service Parts List

DESCRIPTION	PART NUMBER
Blower	SRV4052-796
Pressure Switch	SRV4052-840
Teflon Tubing	SRV4052-804
Cable Bracket	SRV4071-220
Gasket	SRV4071-226
Bracket Assembly	SRV4071-203
Cover Assembly	SRV4071-234
Starting Collar Assembly	SRV4071-235
Extension Assembly	SRV4071-231
Heat Shield	SRV4071-236
Heat Shield Fill	SRV4071-237

## B. IFT-Controls and PVV-SLP Power Vent Troubleshooting

Symptoms	Possible Causes	Corrective Action
IntelliFire Touch System		
System will not respond to 'ON' command. IFT-ECM in lockout with 5 RED:1 GREEN LED Error Code. RC400 shows 'Call Dealer - Power Vent Error' Message	<ol style="list-style-type: none"> <li>1. Power Vent Motor Failure</li> <li>2. Power Vent Over Heating</li> <li>3. Power Vent Pressure Switch Open</li> <li>4. Blocked Flue</li> <li>5. Insufficient Draft</li> <li>6. IFT-ECM selector switch in 'ON' Mode</li> <li>7. IFT-ECM not paired to remote and Power Vent,</li> </ol>	<ol style="list-style-type: none"> <li>1. Verify that the wiring within the Power Vent is correct. Verify that the PVV-SLP Cord assembly is correctly connected to the IFT switch wires, and the AUX port on the IFT-ACM.</li> <li>2. Verify that blower operates during 'ON' command.</li> <li>3. Verify that the PVV-SLP is correctly installed such that it is properly vented and will not over-heat.</li> <li>4. Verify that venting is connected and sealed properly. Verify termination is not blocked.</li> <li>5. Verify the Teflon tube between the blower and pressure switch is securely connected.</li> <li>6. Verify that the 'ON' command is provided with IFT-ECM in 'REMOTE' mode with approved remote control.</li> <li>7. Re-pair the ECM to the Power Vent.</li> </ol>
System responds to 'ON' command. After PVV-SLP completes 120 second pre-purge, IFT system fails to rectify proven pilot flame. IFT-ECM in lockout with 3 RED:1 GREEN LED. RC400 shows 'Call Dealer - Appliance safety disabled' Message	<p>Pilot Rectification Failure resulting from:</p> <ol style="list-style-type: none"> <li>1. Soot or embers contaminating pilot and burner</li> <li>2. Shorted/melted pilot white 'S' sensor wire</li> <li>3. Disconnected pilot white 'S' sensor wire</li> <li>4. Excessive draft turbulence acting on the pilot flame</li> <li>5. Oxidation or resistance on the IPI pilot flame sense electrode</li> <li>6. Supply gas pressure out of specification</li> </ol>	<ol style="list-style-type: none"> <li>1. Verify that the IPI Pilot is clean. If necessary, remove any soot or ember deposits, and clean/polish flame sensor electrode with fine steel wool. If sooting is present, determine possible causes to correct issue.</li> <li>2. Verify that the IPI pilot white 'S' wire is securely connected to the IFT-ECM, and is not melted/pinched/shorted along its length. Replace pilot if damage exists.</li> <li>3. Verify that the gas supply working inlet pressure is within the specification range.</li> <li>4. Verify that the black wire on the IFT wiring harness is securely attached to the chassis ground.</li> <li>5. Verify that the pilot flame is igniting easily, and the pilot flame is not compromised by excessive draft. With glass assembly fully installed, verify that the pilot flame is stable and fully engulfing the flame sensor electrode.</li> <li>6. Verify that the pilot sensor/wire resistance is &lt; 1 ohm. If &gt; 1 ohm, and flame rectification is occurring slowly, replace the pilot.</li> </ol>
Pilot ignites and rectifies flame, but burner fails to light, or does not fully light.	Excessive draft.	<ol style="list-style-type: none"> <li>1. Verify that the glass is properly installed and all latches are engaged.</li> <li>2. Place ember material along the back side of the affected burner ports – that can reduce draft affect and promote ignition.</li> </ol>

## C. IntelliFire Plus Controls and PVV-SLP Power Vent Troubleshooting

Symptoms	Possible Causes	Corrective Action
IntelliFire Plus System		
Main Closes/ Pilot open, 5 seconds later pilot sparking with-blower ON. If condition persists for 60 seconds, 8K-1 locks out with 3 LED alarm.	Pilot Rectification Failure	<ol style="list-style-type: none"> <li>1. Verify that black wire on IPI wire harness is properly grounded to the fireplace chassis.</li> <li>2. Verify that pilot is not being compromised by draft such that it fails to rectify. With the glass assembly in place, verify that the pilot flame is engulfing the flame sensing rod on the left side of the pilot hood. With a multi-meter, verify that the current in series between the module and the sense lead is at least 0.14 microamps.</li> <li>3. Verify that line inlet pressure is within range on rating plate and correct pilot orifice is in pilot.</li> <li>4. If #1-3 are correct, replace IPI module.</li> </ol>
Pilot and Main shut down and 8K1-PVI locks out with 4, 5, or 6 LED alarm.	Blocked Flue/Insufficient Draft	<ol style="list-style-type: none"> <li>1. Verify the teflon pressure tube is connected between blower impeller housing and pressure switch.</li> <li>2. Verify that wiring within PVV-SLP is correct and that the blower operates during the ignition command.</li> <li>3. Verify that the venting is connected and sealed properly.</li> <li>4. Verify that the vent termination is not blocked.</li> <li>5. If #1 thru #4 are complete, connect black and red wires to bypass pressure switch. If malfunction is corrected, lock-out system until the pressure switch can be replaced.</li> </ol>
Main Closes, 5 seconds later pilot sparking with Blower ON. If condition persists for 60 seconds, 8K-1 locks out with 3 LED alarm.	Shorted Pilot Sense	<ol style="list-style-type: none"> <li>1. Verify that the white sensor lead is properly connected to the S-terminal on the module.</li> <li>2. Check for soot deposits on the pilot sense rod, adjacent shielding, or logs. If so, clean affected parts.</li> <li>3. Verify that the white sense lead from the pilot is not damaged or melted within the firebox or valve compartment. Replace pilot if damage exists.</li> </ol>
Main Closes, 5 seconds later pilot sparking with Blower ON. If condition persists for 60 seconds, 8K-1 locks out with 3 LED alarm.	Disconnected Pilot Sense	Verify that white sensor lead is properly connected to the S-terminal and the orange ignitor lead is connected to the I-terminal on the module
If given ignition command in both ON and REMOTE modes, system immediately locks-out with 3 LED alarm. Does not spark or attempt to ignite.	Pre-Existing/False Pilot Flame	Check for pre-existing pilot flame. If so, the valve is defective and should be replaced.
Pilot rectifies, burner begins to light, but has a difficult time fully lighting.	Draft from back of firebox is too strong due to power vent.	Make sure air baffle is properly adjusted. If it is adjusted properly, place ember material along the back side of the ports that are experiencing the difficult lighting. This will block a portion of the strong draft.

Please contact your Hearth & Home Technologies dealer with any questions or concerns.

For the location of your nearest Hearth & Home Technologies dealer, please visit [www.hearthnhome.com](http://www.hearthnhome.com).

Hearth & Home Technologies  
7571 215th Street West, Lakeville, MN 55044  
[www.hearthnhome.com](http://www.hearthnhome.com)