

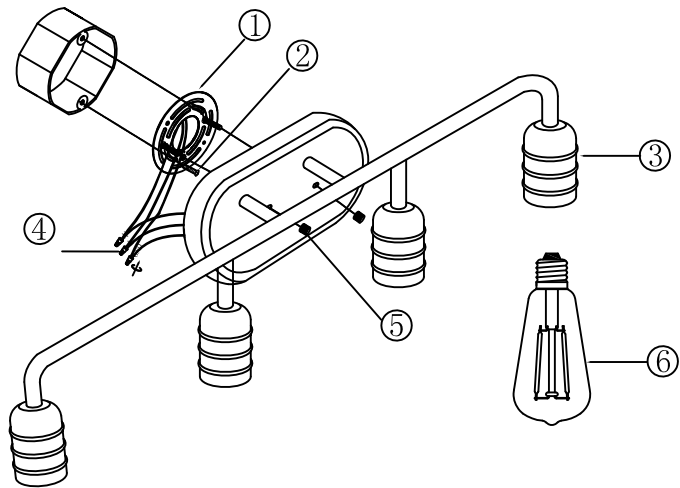



ITEM NO.: 10504

FIXTURE ASSEMBLY STEPS:

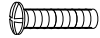

DESCRIPTION	PICTURE	CODE	QTY
Mounting Plate with +Screws+Canopy Nut		1 / 5	1 SET
Mounting Box Screw		2	2 PCS
P3 Wiring Cap		4	3 PCS
Lamp Body		3	1 SET
			

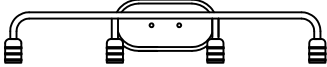
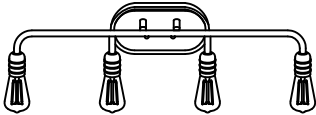
WARNING - if any Special Control Devices are used with this Fixture, Follow the instructions Carefully to assure fun compliance With N.E.C. requirements. if there are any questions, contact a Qualified Electrical Contractor.
 CAUTION - All glass is fragile, use care when handling Glass component(s) and or Lamp(s).
 WARNING - This product contains chemicals known to the State of California to cause cancer, birth defects and /or other reproductive harm. Thoroughly wash hands after installing. handling. cleaning, or otherwise touching this product

CANOPY MOUNTING & WIRE CONNECTION ASSEMBLY STEPS:

Attach(N),(P) to achieve overall desired length.
 Una (N),(P) para lograr la longitud deseada.
 Joignez(N),(P) pour obtenir la Longueur voulue.

FIXTURE ASSEMBLY STEPS:

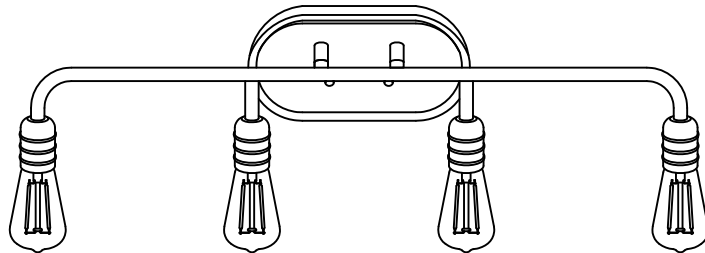
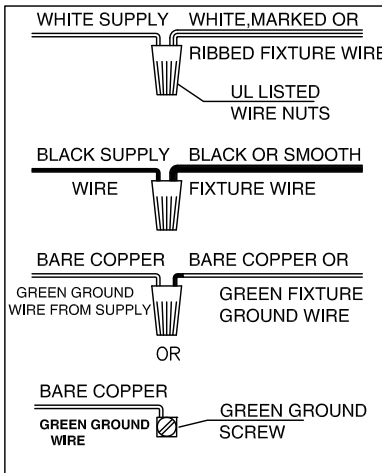

ITEM NO.: 10504

110-120V / 60Hz
 E26 4*MAX 60W TYPE S
 (Do not contain light bulb)

1. AC110~120V,50~60Hz.The Max lamps power is 60W TYPE S Bulb.
2. Avoid to scratch the surface of lighting and the wires when install it.
3. Connect the live wire with the white wire, the netural wire with the parti-colored one, the earth one with the earth symbol (L-L,N-N).
4. Don't install it to the ceiling before it's completely dry, the surrounding around must be ventilated and dry.
5. Keep away from the acid, basicity objects and gases, clean with soft cloth, water washing is not allowed.
6. Be careful when you install glass lamp shade
7. The lighting must be installed by professional electrician and used indoor only.
8. Please keep attention to cut off the power supply when installing, cleaning, and replacing bulb.