

Sumner
Tools

12

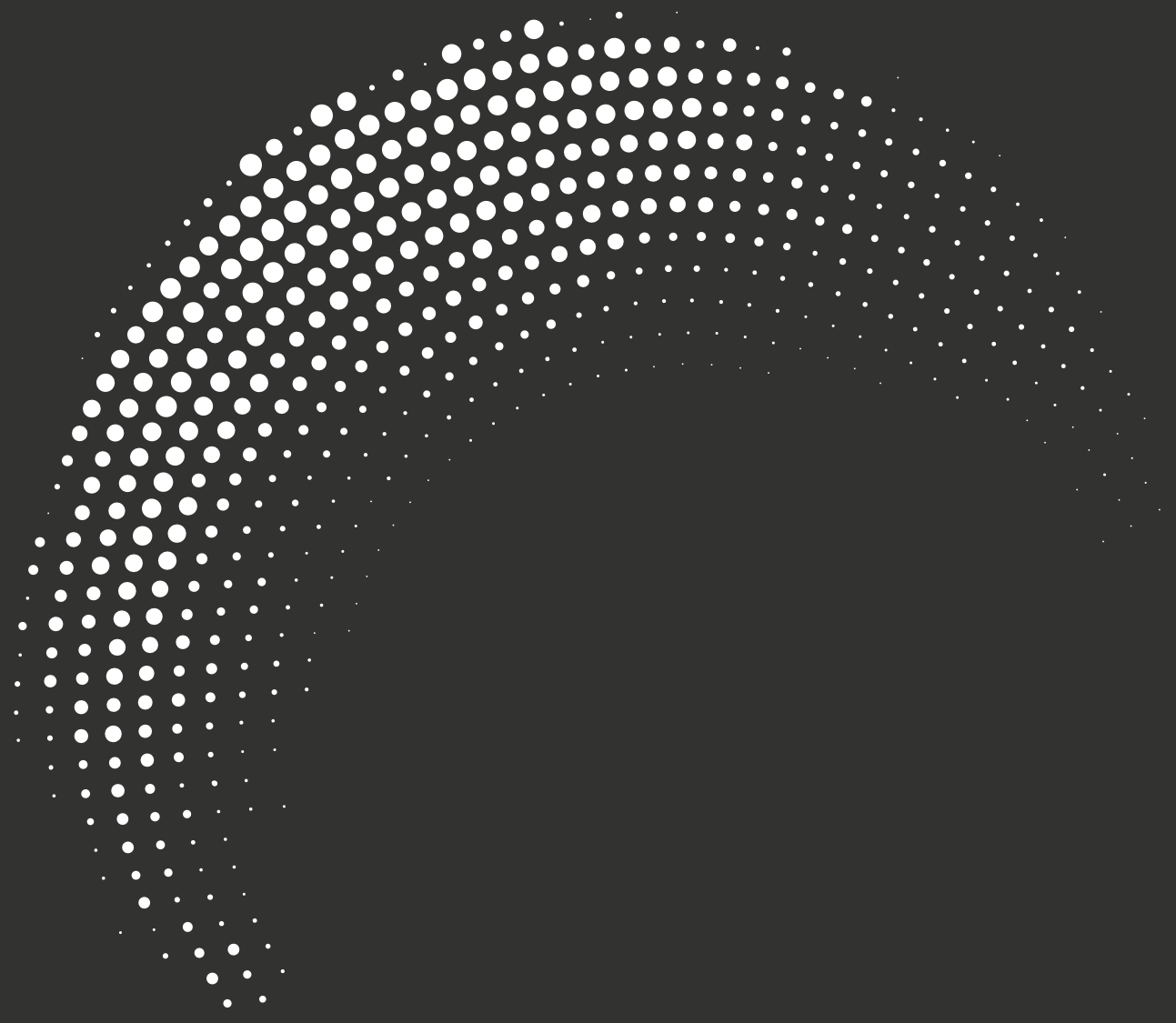



H.M. PHREY
COMPANY LTD.
MICHIGAN
DIVISION

Contents

Pipe Trolley	
Cricket Pipe Trolley	380
Jacks	
Hi Pro-Jack	381
Hi Heavy Duty Jack	381
Hi Fold-A-Jack	381
Jacks Heads & Accessories	382
Large Jacks	
Hi Boy Jack Stand	383
Max Jax	383
Big Vee Jack	384
Vee Heads	384
Roller Heads	
Pro Roll	385
Adjust-A-Roll	385
Quick Change Roller Heads Choices	385
Pipe Fitting Tools	
Internal Fit-Up Clamps	386
Hold-Down Device	386
Rotary Earth Clamp	387
Adjust-A-Flange	387
Adjust-A-Fit	387
Flange Pins & Leveller	387
Clamps	
Ultra Qwik Clamps	388

Cricket Pipe Trolley

More than a pipe trolley – uses leverage to lift pipes

- Ideal for carrying flanges, fittings and valves
- Transport 6.1m pipe lengths up to 450kg
- Supplied with ratchet hold-down strap and 16" pneumatic tyres
- Weighs just 37.2kg
- Quick handle disconnect for compact storage
- Flat free tyres



Replacement Wheels:
779107 – Pneumatic
779104 – Flat Free

Summer
Tools



1. Use ratchet to secure Cricket to pipe



2. Use ratchet to flip Cricket and pipe



3. Reposition handle

Part No.	Description	Height	Width	Width between wheels	Length	Weight
782685	Cricket with flat free tyres	53cm	71cm	41cm	71cm	37.2kg

Hi Pro-Jack



- Formed steel legs
- 1135kg load capacity
- Strut tension plate for superior lateral support
- Quick action lock washer
- Height: Maximum 125 cm
Minimum 71 cm

FALL GUARD™

Patented Fall Guard™ feature allows 25mm safety zone around lock washer

Part No.	Description	Weight
780311	Hi Pro-Jack - base assembly Height: 710-1250mm	6.3kg

HEAD NOT SUPPLIED – for choice of head options see opposite

Hi Heavy Duty Jack



- Replaceable legs
- Tough 25mm square tube base construction
- 1135kg load capacity
- Strut tension plate for superior lateral support
- Quick action lock washer
- Built for heavy use and abuse!

FALL GUARD™

Patented Fall Guard™ feature allows 25mm safety zone around lock washer

Part No.	Description	Weight
780523	Hi Heavy Duty Jack – base assembly Height: 710-1250mm	6.8kg

HEAD NOT SUPPLIED – for choice of head options see opposite

Hi Fold-A-Jack



- Folds up for easy storage
- 25mm square tube base construction
- 1135kg capacity
- Quick action lock washer
- Height: Maximum 125 cm
Minimum 71 cm

FALL GUARD™

Patented Fall Guard™ feature allows 25mm safety zone around lock washer





Part No.	Description	Weight
780312	Hi Fold-A-Jack – base assembly Height: 710-1250mm	6.3kg

HEAD NOT SUPPLIED – for choice of head options see opposite



a choice of 5 head styles for every application



	Vee Head	Ball Transfer Head*	Steel Roller Head	Rubber Roller Head	Bar Stock Head
					
Pro Jack capacity	1135kg	450kg	900kg	450kg	900kg
Fold-A-Jack capacity	1135kg	450kg	900kg	450kg	900kg
Heavy Duty Jack capacity	1135kg	450kg	900kg	450kg	900kg
Pipe size	3-600mm	10-300mm	30-600mm	40-600mm	3-250mm
Application	General welding of pipe shapes, solids and rounds	Rotation of pipe or tubing in all directions	Welding of pipe and rounds	Non-marring surface, roll welding of pipes and rounds	Welding of flats and shapes

Jack Parts & Accessories

Part No.	Description	Stainless Steel Vee-Head Attachment
780330	Setscrew (set of 6)	Fits over vee and secures with two bolts – no tools required!
780333	Lockwasher (set of 6)	
780422	Lo ID Barrel	
780424	Hi ID Barrel	



Part No. **780502**

Spare Heads for Stands

Part No.	Description	Weight
780305	Vee-Head	4.2kg
780551	Ball Transfer Head (mild steel)*	3.0kg
780274	Ball Transfer Head (stainless steel)*	3.0kg
780307	Roller Head (mild steel)	5.7kg
780308	Roller Head (stainless steel)	5.9kg
780309	Roller Head with Rubber Wheels	5.0kg
780310	Bar Stock Head	4.5kg

*Requires 780305 Vee-Head – supplied separately.

Hi Boy Jack Stand



The Hi Boy is a tall jack specifically designed for tight pipe installation such as in mechanical rooms or tunnels.

The Hi Boy is a safe, portable folding stand that is easy to transport and holds up to a hefty 450kg. In its lowest position at 98cm and its highest at 180cm, the Hi Boy is ideal for everyday fabrication of weld pipe. Legs fold up for convenient storage in job boxes or truck beds.

Part No.	Description	Weight
783250	Hi Boy Jack Stand	20.4kg

Max Jax



Part No. **781464** Five 203mm heavy duty casters make up the Max Jax Caster Kit. The rubber casters have a quick action braking system.

The versatile Sumner Max Jax is the ideal fabricator stand. The large 305mm vee head and heavy duty 5-leg design offers the welder an extra margin of safety on pipes up to 900mm diameter.

- Sturdy 3-leg construction for greater stability
- 100-900mm diameter pipe capacity
- 1135kg load capacity

SPECIFICATIONS

Load capacity		1135 kg
Basic Unit	A Height	686 mm
	B Width	752 mm
Basic Unit with Casters	Height	927 mm
	Width	1003 mm
Vee-Head height	C Min	533 mm
	C Max	838 mm
Vee-Head height with Casters	Min	775 mm
	Max	1080 mm

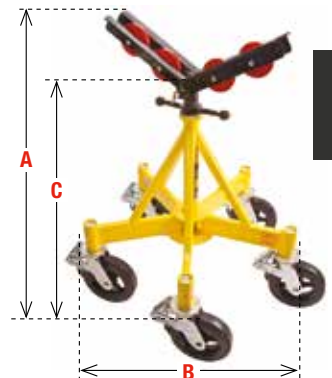

Part No.	Description	Weight
781460	Max Jax c/w Vee Head (basic)	26.4kg

For head options – see page 000

Big Vee Jack



The Sumner Big Vee Jack is ideal for fabricators of large diameter pipes. With a wider base, 45mm Acme adjustment screw and greater load capacity, the Big Vee is the ideal stand for this application. The heavy duty 3-leg stand is built tough enough for the demands of larger pipes.

- Heavy duty 25mm square leg tubing can support
- Quick and precise height adjustment
- 1135kg loads
- Wide base for extra stability
- Takes up to 914mm diameter pipe
- Optional roller wheels

SPECIFICATIONS

Load capacity		1135 kg
Basic Unit	A	Height 902 mm
	B	Width 749 mm
Vee-Head height	C	Min 749 mm
	C	Max 1041 mm

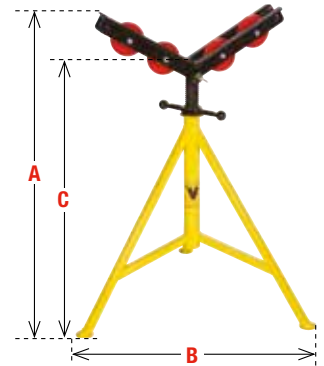

Part No.	Description	Weight
780260	Big Vee Jack (basic) with Vee head	16.4kg

Vee Heads

781406*

Steel Roller Head Kit
Weight: 4.1kg



781383*

Standard Ball Transfer Kit
Weight: 2.3kg



781407*

Stainless Steel Roller Head Kit
900kg capacity
Weight: 4.1kg



781397*

Stainless Steel Ball Transfer Kit
450kg capacity
Weight: 2.3kg



781381*

Large Roller Wheel Kit
Weight: 15.5kg



781382*

Stainless Steel Sleeves
Weight: 2.3kg



781394*

Rubber Wheel Kit
450kg capacity
Weight: 1.8kg



*Vee head for illustration purposes only

Pro Roll



Pro Roll shown with Steel Wheels

- Holds up to 914mm pipe
- Levelling on either side of stand
- Easily adjustable height (see diagram)
- Maximum capacity 1135kg

Easily adjustable height on Pro Roll

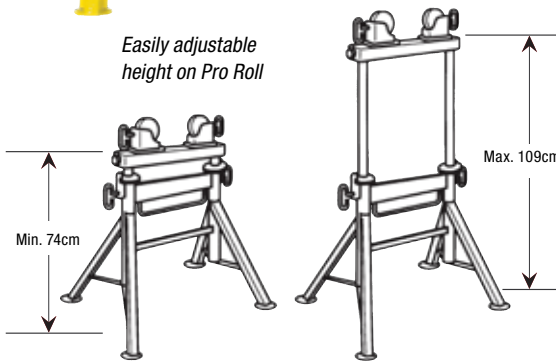

Part No.	Description	Weight
780440	Pro Roll – Base Only	16.4kg

HEAD NOT SUPPLIED – for choice of head options see below

Adjust-A-Roll



Adjust-A-Roll with Bar Stock Head

- Fixed Height 77.5cm
- Maximum capacity 1135kg

Part No.	Description	Weight
780399	Adjust-A-Roll – Base Only	10.9kg

HEAD NOT SUPPLIED – for choice of head options see below

Table Adjust-A-Roll



Table Adjust-A-Roll with Ball Transfer Head

Part No.	Description	Weight
780500	Table Adjust-A-Roll – Base Only	10.9kg

HEAD NOT SUPPLIED – for choice of head options see below

Quick Change Roller Heads Choices

Sumner's innovative Quick Change Roller Housings increase the utility of its roller stands. Roller housings can be changed with ease, without tools, to adapt to changing job requirements. Roller wheels are available in steel, stainless steel or rubber. Bar stock and ball transfer heads (with carbon or stainless steel balls) are also available.

Part No.	Description	Cap. Weight	Weight
783151	Steel Wheels (set of 2)	1130kg	3.6kg
783152	Rubber Wheels (set of 2)	550kg	3.2kg
783153	Stainless Steel Wheels (set of 2)	1130kg	3.6kg
783154	Ball Transfer Head (set of 2)	450kg	3.2kg
783155	Bar Stock Head	900kg	7.2kg
783159	Stainless Steel Ball Transfer Head (set of 2)	450kg	10.5kg



Internal Fit-Up Clamps



784100
50-145mm

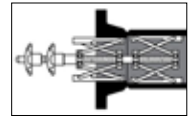

Two independently operated internal clamps align flange to pipe, even if internal dimensions differ

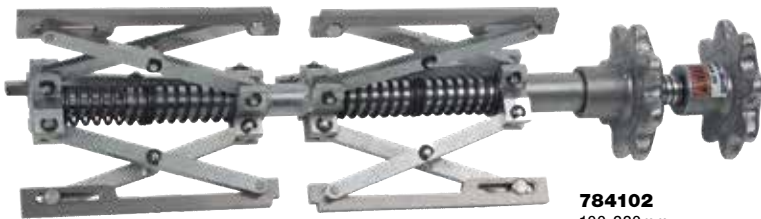

784102
100-220mm

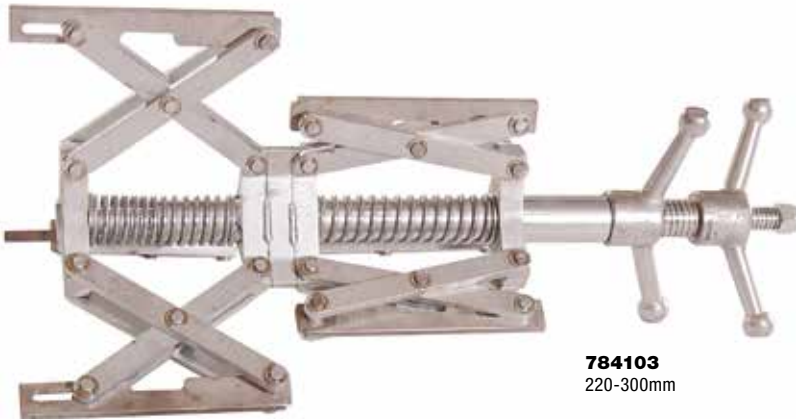

784103
220-300mm

Hold-Down Device

Holds pipe or shape up to 305mm diameter

- Similar in operation to a chain vice for pipe, the Hold-Down Device uses high tensile strength chain to grip material in any Sumner vee-head jack
- Ideal for fitting up flanges, fittings or valves and a must when working with short lengths
- Can be used with both standard and large vee-head jacks

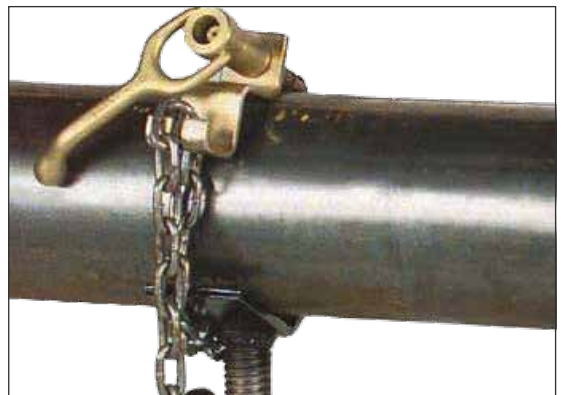

Part No.	Description	Weight
781050	Hold-Down Device	3.0kg

Rotary Earth Clamp

780435



Adjust-A-Flange

780425



Adjust-A-Fit

780420

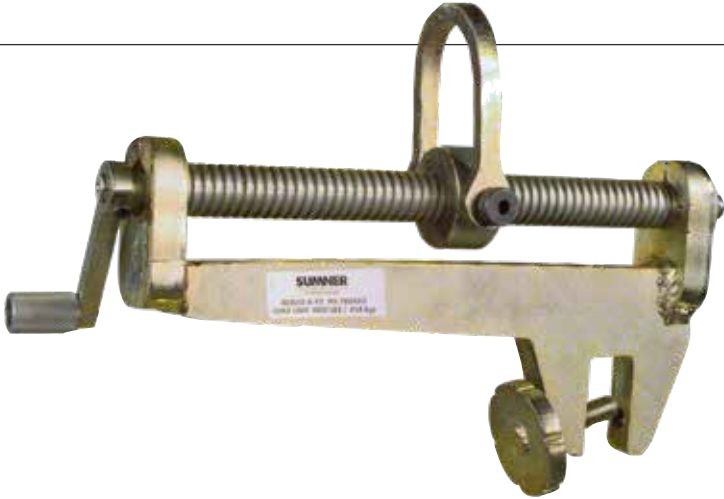

Flange Pins & leveller

781235

Quick Release Steel (2)



780429

Stainless Steel (2)



780430

Steel (2)

781240



Automatically centres in flange holes to 16-42mm

Ultra™ Qwik Clamps

The Sumner Ultra™ Clamp is a fast, accurate fit-up tool for pipe to pipe, pipe to fitting and other fit-up needs.



781130
25-65mm / 1.6kg



781150
50-150mm / 3.9kg



781170
127-300mm / 6.6kg

- Push button design allows for rapid action setting and fine tune thread adjustment
- Accurate fit-up of 1" to 12" pipe
- Rugged frame, built for jobsite use
- Stainless steel alignment screws
- Operating handle repositions for close work
- Fine adjustment screws for quick fit-up
- Lightweight for overhead work
- Available in three sizes



Pipe to pipe



Pipe to flange



Pipe to tee



Pipe to fitting