

Mig  
Welding

5

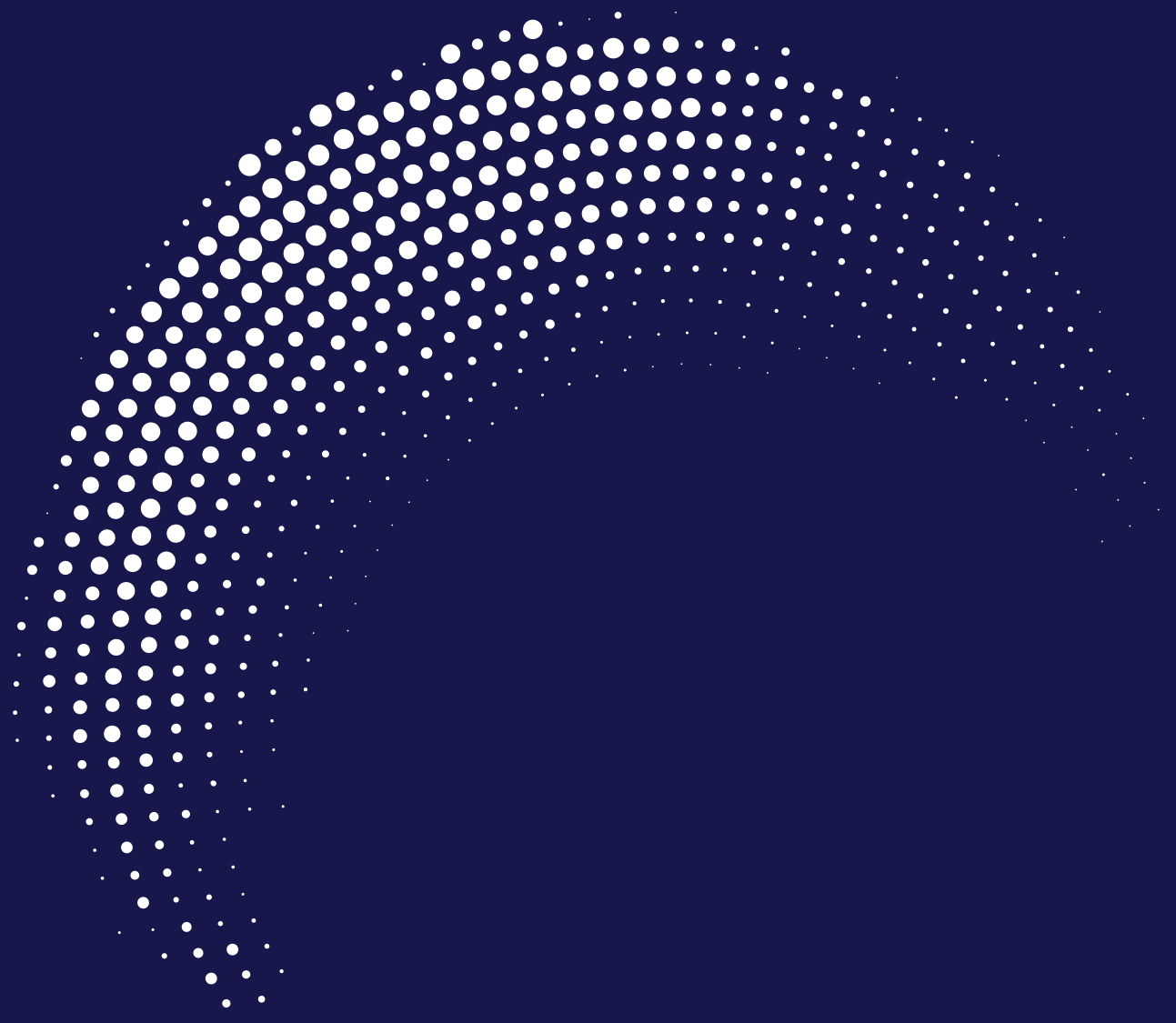



Stealth  
DIGI-TECH

www.specialisedwelding.co.uk

## Contents

<b>Binzel</b>	M14 Compatible Torch & Consumables	115
	M15 Compatible Torch & Consumables	116
	M25 Compatible Torch & Consumables	118
	M36 Compatible Torch & Consumables	120
	M38 Compatible Torch & Consumables	122
	M501 Compatible Torch & Consumables	124
	MSP360 Compatible Spool Gun	126
<b>SWP</b>	Soft Grip & Eco Handles – Edition 6	128
<b>Conversion Kits &amp; Parts</b>		129
<b>Tweco</b>	TW2 Compatible Torch & Consumables	130
	TW4 Compatible Torch & Consumables	132
<b>Bernard</b>	BE302/302E Compatible Torch & Consumables	134
	BE352 Compatible Torch & Consumables	136
	BE402/402E Compatible Torch & Consumables	138
<b>Murex</b>	MX253 Compatible Torch & Consumables	140
	MX363 Compatible Torch & Consumables	142
	MX403 Compatible Torch & Consumables	144
<b>Esab PSF</b>	Compatible Consumables	146
<b>Tregaskiss</b>	T400 Compatible Torch & Consumables	148
	T500 Compatible Torch & Consumables	150
<b>Fronius</b>	Compatible Consumables	152
<b>Kemppi</b>	Compatible Consumables	153

## Disclaimer

Specialised Welding Products are in no way connected to or affiliated with any of the manufacturers referred to in the MIG section of this catalogue.

None of the equipment listed in this MIG section originates from the manufacturer with whose products it is compatible.

In this MIG section, the use of:

- (i) original equipment manufacturer's part numbers and/or
- (ii) any manufacturer's registered or unregistered trade marks is solely to indicate that the intended purpose of the equipment in question is to act as a spare part and/or accessory for the relevant original equipment.



All consumable parts are interchangeable with most common brands.

- Lightweight
- Well balanced
- Robust

Hanger hook

Robust switch system

Trigger guard

Oval shaped handle for optimum grip

Soft grip

Available in capacities from 150 to 500 amps

Soft grip

Smooth rotatable cable support

**SWP**  
**Stealth**  
**GRIP**

Rating 160A CO<sub>2</sub> / 140A Mixed Gases @ 60% Duty Cycle – Wire Sizes 0.6-0.9mm

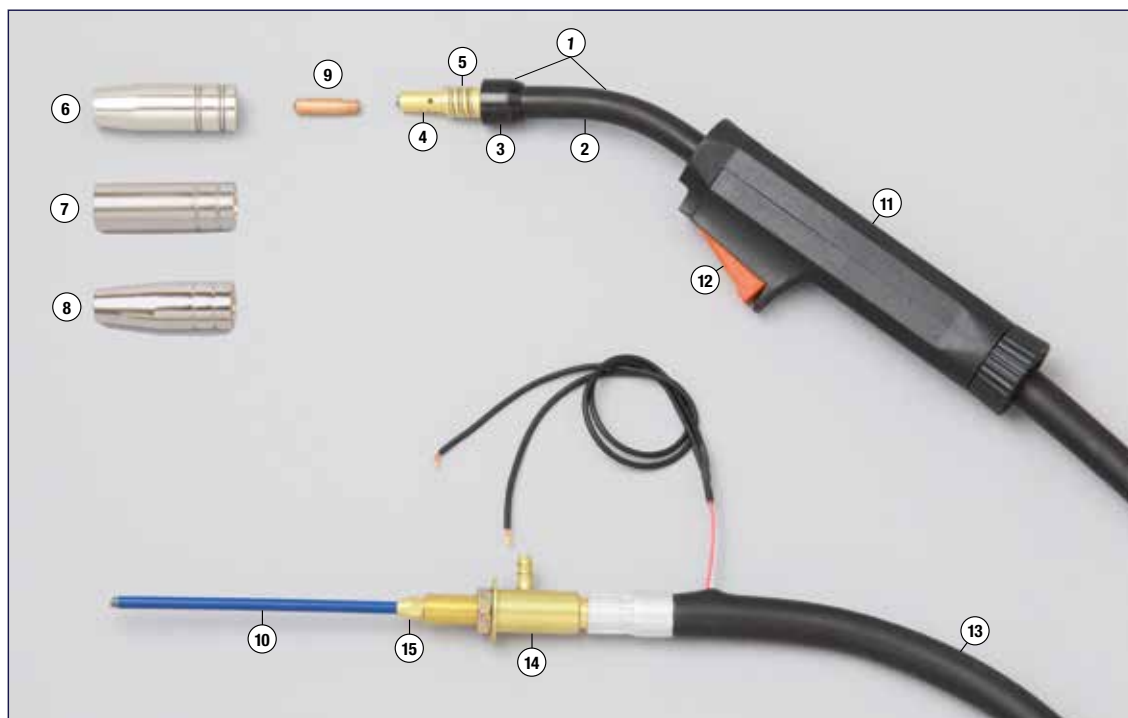

## M14 Torch Packages

Part No.	Description
<b>M14-3T</b>	Torch Package x 3m Direct Fitting
<b>M14-4T</b>	Torch Package x 4m Direct Fitting

## Consumables

Item	Part No.	Description	Qty
<b>MAIN CONSUMABLES</b>			
1	M1454	Swan Neck c/w Items 2 and 3	1
2	M1503	Insulation Sleeve	5
3	M1505	Insulator	5
4	M1502	Tip Adaptor – Right Hand	5
5	M1504	Nozzle Spring	10
6	M1506	Conical Nozzle	5
7	M1507	Cylindrical Nozzle	5
8	M1508	Tapered Nozzle	5
<b>CONTACT TIPS (ECU M6 x 25mm)</b>			
9	M1509-06	0.6mm Wire	25
	M1509-08	0.8mm Wire / 0.6mm Aluminium	25
<b>LINERS – STEEL</b>			
10	M1438	0.6-0.9mm Wire x 3m	1
	M1448	0.6-0.9mm Wire x 4m	1

Item	Part No.	Description	Qty
<b>SECONDARY CONSUMABLES</b>			
11	M1463	Handle	1
12	M1464	Trigger	1
13	M1517-3	3 Cable Assembly	1
	M1517-4	4m Cable Assembly	1
14	M1468	T Piece c/w Nut and Washer	1
15	M1469	Collet	5

## Also available: Mini Mig Consumables

Part No.	Description	Qty
M1406	0.6mm Contact Tip – M5 Thread	25
M1408	0.8mm Contact Tip – M5 Thread	25
M1409	0.9mm Contact Tip – M5 Thread	25
M1410	1.0mm Contact Tip – M5 Thread	25
M1418	PVC Liner x 3m 0.6-0.8mm wire	1
M1429	White P C Steel Liner x 3m 0.6-0.8mm wire	1
M1402	Conical Nozzle Screw On	5

# M15 Binzel Compatible Torch

**AIR COOLED**

Rating 150A @ 60% Duty Cycle Mixed Gases/Wire Sizes 0.6-1.0mm

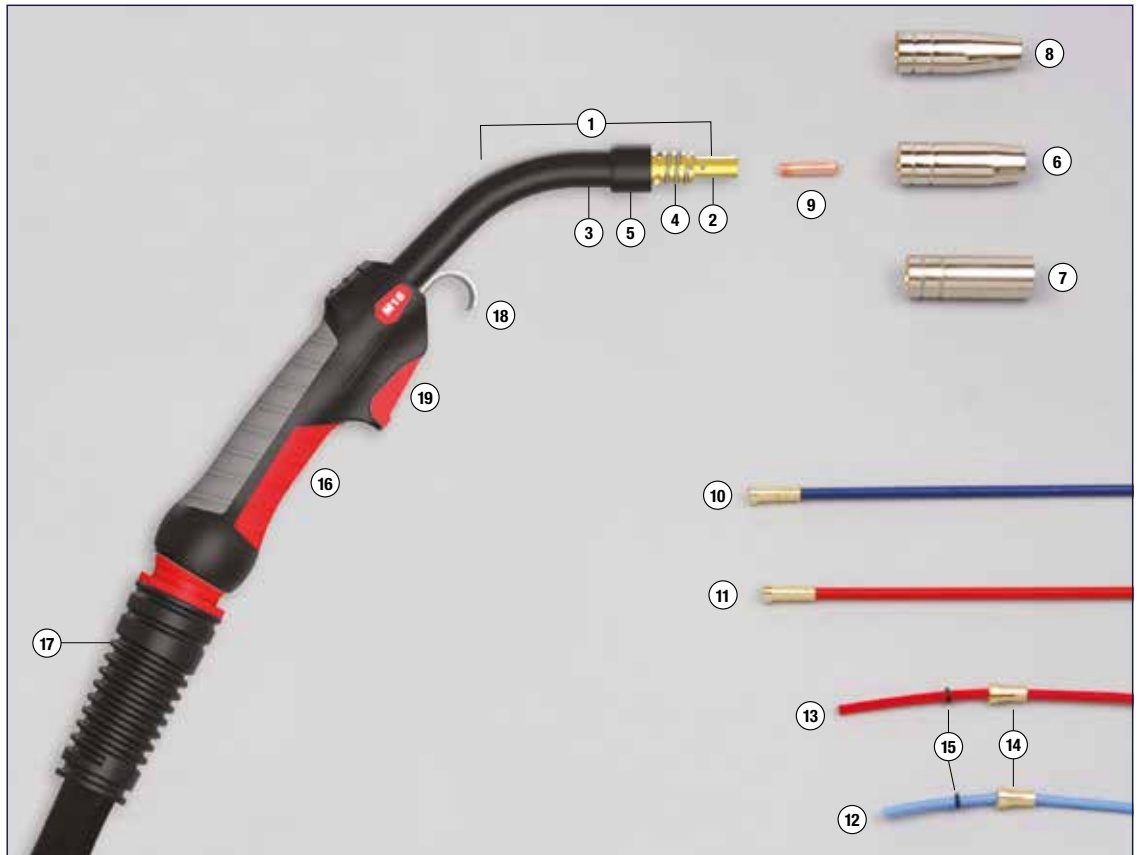

## M15 Torch Packages

Part No.	Description
<b>M15-3</b>	Torch x 3m Bladeswitch complete with Euro Fitting
<b>M15-4</b>	Torch x 4m Bladeswitch complete with Euro Fitting
<b>M15-5</b>	Torch x 5m Bladeswitch complete with Euro Fitting

## M15



## Euro Fitting – M Series





## Consumables

Item	Part No.	Description	Qty
<b>MAIN CONSUMABLES</b>			
1	M1501	Swan Neck c/w Items 2-5 below	1
2	M1502-LH	Tip Adaptor – Left Hand Thread (standard)	5
	M1502	Tip Adaptor – Right Hand Thread	5
3	M1503	Insulation Sleeve	5
4	M1504	Nozzle Spring	10
5	M1505	Insulator	5
6	M1506	Conical Nozzle	5
7	M1507	Cylindrical Nozzle	5
8	M1508	Tapered Nozzle	5
<b>CONTACT TIPS (ECU M6 x 25mm)</b>			
9	M1509-06	0.6mm Wire	25
	M1509-08	0.8mm Wire / 0.6mm Aluminium	25
	M1509-09	0.9mm Wire	25
	M1509-10	1.0mm Wire / 0.8mm Aluminium	25
	M1509-12	1.2mm Wire / 1.0mm Aluminium	25
<b>LINERS – STEEL</b>			
10	M1510-3	0.6-0.9mm Wire x 3m	1
	M1510-4	0.6-0.9mm Wire x 4m	1
	M1510-5	0.6-0.9mm Wire x 5m	1
11	M1511-3	1.0-1.2mm Wire x 3m	1
	M1511-4	1.0-1.2mm Wire x 4m	1
	M1511-5	1.0-1.2mm Wire x 5m	1
<b>LINERS – ALUMINIUM</b>			
12	M1512-3	0.6-0.8mm Aluminium Wire x 3m	1
	M1512-4	0.6-0.8mm Aluminium Wire x 4m	1
	M1512-5	0.6-0.8mm Aluminium Wire x 5m	1
13	M1513-3	1.0-1.2mm Aluminium Wire x 3m	1
	M1513-4	1.0-1.2mm Aluminium Wire x 4m	1
	M1513-5	1.0-1.2mm Aluminium Wire x 5m	1
14	M1514	Collet for Aluminium Liner – up to 1.2mm	5
15	M1515	O-Ring for Aluminium Liner	10

Item	Part No.	Description	Qty
<b>SECONDARY CONSUMABLES</b>			
16	M8060	Handle c/w trigger	1
17	M1517-3	3m Cable Assembly	1
	M1517-4	4m Cable Assembly	1
	M1517-5	5m Cable Assembly	1
18	M1519	Hanger Hook	1
19	M8061	Trigger	1



**1490**  
Anti-spatter paste  
See page 41

## M Series Liner Colour Chart

### STEEL LINERS

Colour	Wire Size
Blue	0.6mm-0.9mm
Red	1.0mm-1.2mm
Yellow	1.6mm

### ALUMINIUM LINERS

Colour	Wire Size
Blue	0.8mm-1.0mm
Red	1.0mm-1.2mm
Yellow	1.6mm

Rating 200A @ 60% Duty Cycle Mixed Gases/Wire Sizes 0.6-1.2mm

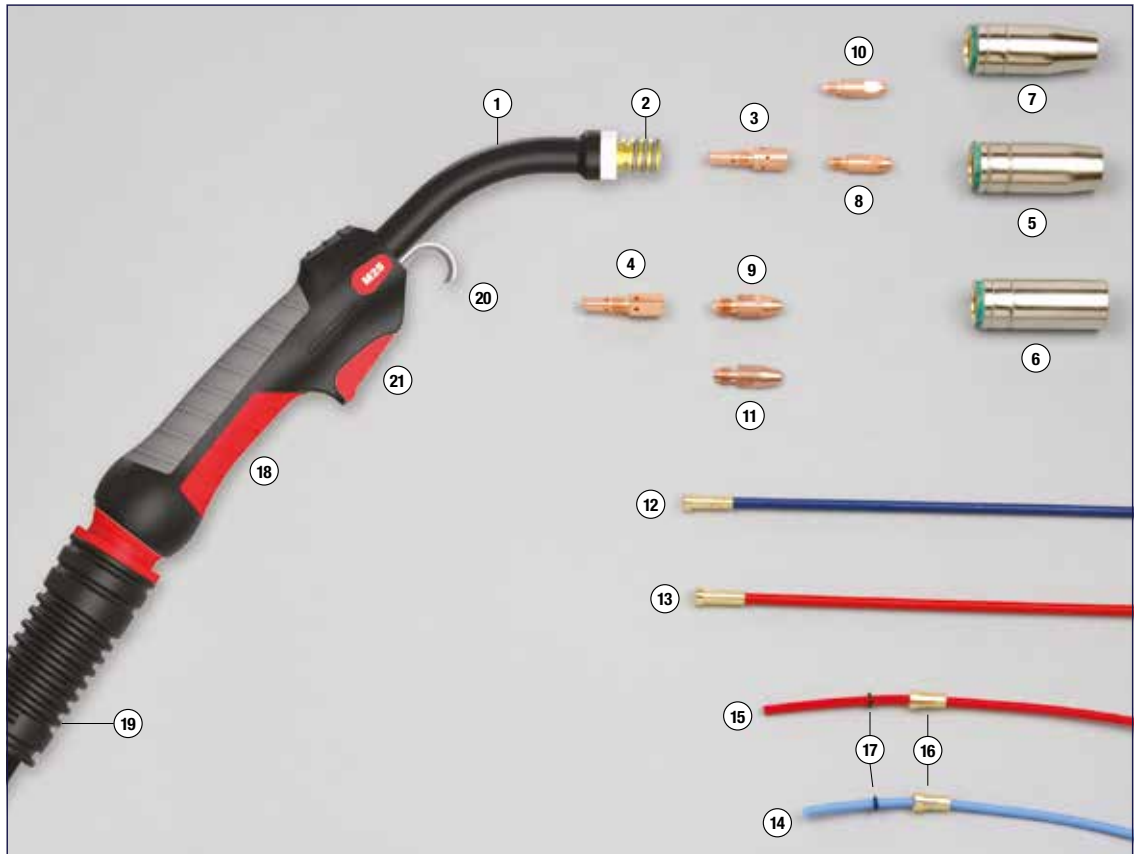

MIG  
Torches

## M25 Torch Packages

Part No.	Description
<b>M25-3</b>	Torch x 3m Bladeswitch complete with Euro Fitting
<b>M25-4</b>	Torch x 4m Bladeswitch complete with Euro Fitting
<b>M25-5</b>	Torch x 5m Bladeswitch complete with Euro Fitting

## M25



## Euro Fitting – M Series





## Consumables

Item	Part No.	Description	Qty
<b>MAIN CONSUMABLES</b>			
1	M2501	Swan Neck c/w Item 2	1
2	M2502	Nozzle Spring	10
3	M2503	Tip Adaptor for M6 Tips	5
4	M2504	Tip Adaptor for M8 Tips	5
5	M2505	Conical Nozzle	5
6	M2506	Cylindrical Nozzle	5
7	M2507	Tapered Nozzle	5
<b>CONTACT TIPS (ECU M6 x 28mm)</b>			
8	M2508-06	0.6mm Wire	25
	M2508-08	0.8mm Wire / 0.6mm Aluminium	25
	M2508-09	0.9mm Wire	25
	M2508-10	1.0mm Wire / 0.8mm Aluminium	25
	M2508-12	1.2mm Wire / 1.0mm Aluminium	25
	M2508-14	1.2mm Aluminium	25
<b>CONTACT TIPS (ECU M8 x 30mm)</b>			
9	M2509-08	0.8mm Wire / 0.6mm Aluminium	25
	M2509-09	0.9mm Wire	25
	M2509-10	1.0mm Wire / 0.8mm Aluminium	25
	M2509-12	1.2mm Wire / 1.0mm Aluminium	25
	M2509-14	1.2mm Aluminium	25
<b>CONTACT TIPS (CuCrZr M6 x 28mm)</b>			
10	M2510-08	0.8mm Wire / 0.6mm Aluminium	25
	M2510-09	0.9mm Wire	25
	M2510-10	1.0mm Wire / 0.8mm Aluminium	25
	M2510-12	1.2mm Wire / 1.0mm Aluminium	25
<b>CONTACT TIPS (CuCrZr M8 x 30mm)</b>			
11	M2511-08	0.8mm Wire / 0.6mm Aluminium	25
	M2511-09	0.9mm Wire	25
	M2511-10	1.0mm Wire / 0.8mm Aluminium	25
	M2511-12	1.2mm Wire / 1.0mm Aluminium	25
	M2511-14	1.2mm Aluminium	25

Item	Part No.	Description	Qty
<b>LINERS – STEEL</b>			
12	M1510-3	0.6-0.9mm Wire x 3m	1
	M1510-4	0.6-0.9mm Wire x 4m	1
	M1510-5	0.6-0.9mm Wire x 5m	1
13	M1511-3	1.0-1.2mm Wire x 3m	1
	M1511-4	1.0-1.2mm Wire x 4m	1
	M1511-5	1.0-1.2mm Wire x 5m	1
<b>LINERS – ALUMINIUM</b>			
14	M1512-3	0.6-0.8mm Aluminium Wire x 3m	1
	M1512-4	0.6-0.8mm Aluminium Wire x 4m	1
	M1512-5	0.6-0.8mm Aluminium Wire x 5m	1
15	M1513-3	1.0-1.2mm Aluminium Wire x 3m	1
	M1513-4	1.0-1.2mm Aluminium Wire x 4m	1
	M1513-5	1.0-1.2mm Aluminium Wire x 5m	1
16	M1514	Collet for Aluminium Liner – up to 1.2mm	5
17	M1515	O-Ring for Aluminium Liner	10
<b>SECONDARY CONSUMABLES</b>			
18	M8060	Handle c/w Trigger	1
19	M2519-3	3m Cable Assembly	1
	M2519-4	4m Cable Assembly	1
	M2519-5	5m Cable Assembly	1
20	M1519	Hanger Hook	1
21	M8061	Trigger	1



**1362**  
Premium Anti-Spatter Spray  
See page 41

## M Series Liner Colour Chart

### STEEL LINERS

Colour	Wire Size
Blue	0.6mm-0.9mm
Red	1.0mm-1.2mm
Yellow	1.6mm

### ALUMINIUM LINERS

Colour	Wire Size
Blue	0.8mm-1.0mm
Red	1.0mm-1.2mm
Yellow	1.6mm

Rating 300A @ 60% Duty Cycle Mixed Gases/Wire Sizes 0.6-1.6mm

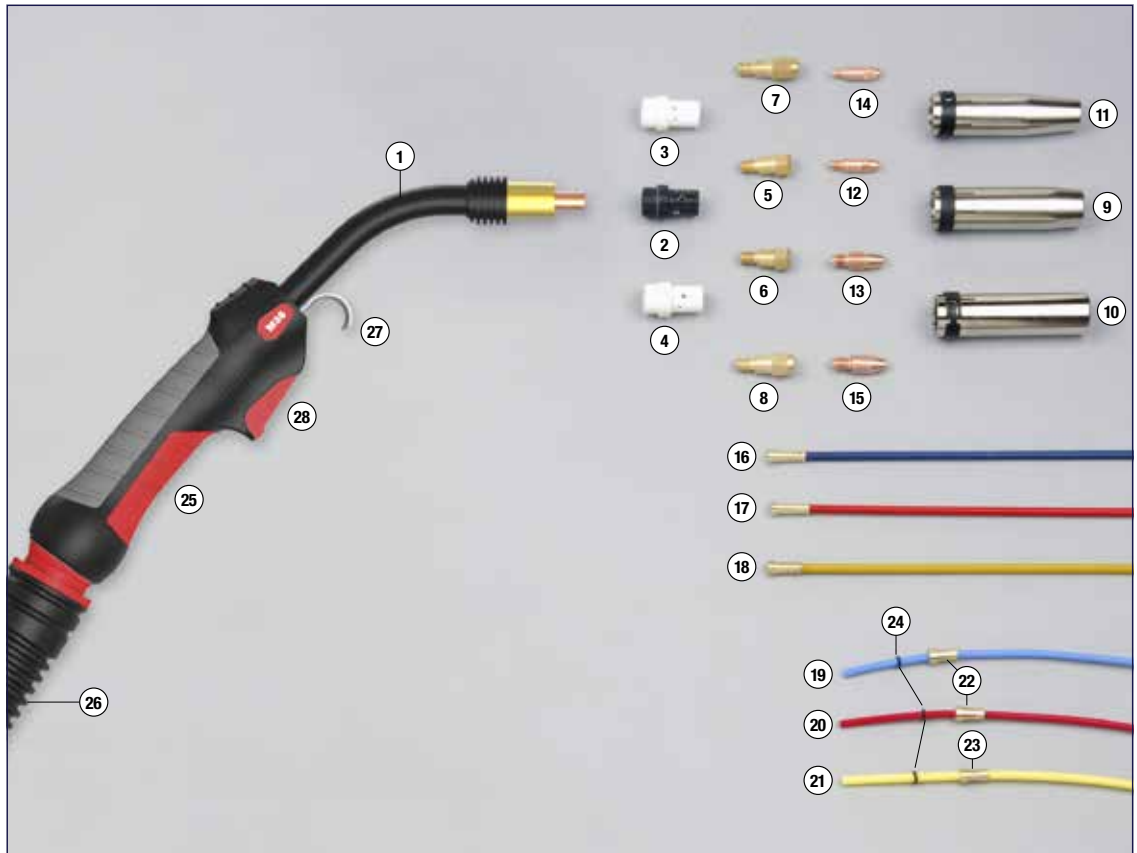

MIG  
Torches

## M36 Torch Packages

Part No.	Description
<b>M36-3</b>	Torch x 3m Bladeswitch complete with Euro Fitting
<b>M36-4</b>	Torch x 4m Bladeswitch complete with Euro Fitting
<b>M36-5</b>	Torch x 5m Bladeswitch complete with Euro Fitting

## M36



## Euro Fitting – M Series



## Consumables

Item	Part No.	Description	Qty
<b>MAIN CONSUMABLES</b>			
1	M3601	Swan Neck	1
2	M3602	Black Diffuser	5
3	M3603	White Diffuser	5
4	M3604	Ceramic Diffuser	5
5	M3605	Short Tip Adaptor for M6 Tips	5
6	M3606	Short Tip Adaptor for M8 Tips	5
7	M3607	Long Tip Adaptor for M6 Tips	5
8	M3608	Long Tip Adaptor for M8 Tips	5
9	M3609	Conical Nozzle	5
10	M3610	Cylindrical Nozzle	5
11	M3611	Tapered Nozzle	5
<b>CONTACT TIPS (ECU M6 x 28mm)</b>			
12	M2508-06	0.6mm Wire	25
	M2508-08	0.8mm Wire / 0.6mm Aluminium	25
	M2508-09	0.9mm Wire	25
	M2508-10	1.0mm Wire / 0.8mm Aluminium	25
	M2508-12	1.2mm Wire / 1.0mm Aluminium	25
	M2508-14	1.2mm Aluminium	25
	M2508-16	1.6mm Wire	25
<b>CONTACT TIPS (ECU M8 x 30mm)</b>			
13	M2509-08	0.8mm Wire / 0.6mm Aluminium	25
	M2509-09	0.9mm Wire	25
	M2509-10	1.0mm Wire / 0.8mm Aluminium	25
	M2509-12	1.2mm Wire / 1.0mm Aluminium	25
	M2509-14	1.2mm Aluminium	25
	M2509-16	1.6mm Wire	25
<b>CONTACT TIPS (CuCrZr M6 x 28mm)</b>			
14	M2510-08	0.8mm Wire / 0.6mm Aluminium	25
	M2510-09	0.9mm Wire	25
	M2510-10	1.0mm Wire / 0.8mm Aluminium	25
	M2510-12	1.2mm Wire / 1.0mm Aluminium	25
	M2510-16	1.6mm Wire	25

Item	Part No.	Description	Qty
<b>CONTACT TIPS (CuCrZr M8 x 30mm)</b>			
15	M2511-08	0.8mm Wire / 0.6mm Aluminium	25
	M2511-09	0.9mm Wire	25
	M2511-10	1.0mm Wire / 0.8mm Aluminium	25
	M2511-12	1.2mm Wire / 1.0mm Aluminium	25
	M2511-14	1.2mm Aluminium	25
	M2511-16	1.6mm Wire	25
<b>LINERS – STEEL</b>			
16	M1510-3	0.6-0.9mm Wire x 3m	1
	M1510-4	0.6-0.9mm Wire x 4m	1
	M1510-5	0.6-0.9mm Wire x 5m	1
17	M1511-3	1.0-1.2mm Wire x 3m	1
	M1511-4	1.0-1.2mm Wire x 4m	1
	M1511-5	1.0-1.2mm Wire x 5m	1
18	M3618-3	1.6mm Wire x 3m	1
	M3618-4	1.6mm Wire x 4m	1
	M3618-5	1.6mm Wire x 5m	1
<b>LINERS – ALUMINIUM</b>			
19	M1512-3	0.6-0.8mm Aluminium Wire x 3m	1
	M1512-4	0.6-0.8mm Aluminium Wire x 4m	1
	M1512-5	0.6-0.8mm Aluminium Wire x 5m	1
20	M1513-3	1.0-1.2mm Aluminium Wire x 3m	1
	M1513-4	1.0-1.2mm Aluminium Wire x 4m	1
	M1513-5	1.0-1.2mm Aluminium Wire x 5m	1
21	M3621-3	1.6mm Aluminium Wire x 3m	1
	M3621-4	1.6mm Aluminium Wire x 4m	1
	M3621-5	1.6mm Aluminium Wire x 5m	1
22	M1514	Collet for Aluminium Liner – up to 1.2mm	5
23	M3623	Collet for Aluminium Liner – up to 1.6mm	5
24	M1515	O-Ring for Aluminium Liner	10
<b>SECONDARY CONSUMABLES</b>			
25	M8060	Handle c/w Trigger	1
26	M3626-3	3m Cable Assembly	1
	M3626-4	4m Cable Assembly	1
	M3626-5	5m Cable Assembly	1
27	M1519	Hanger Hook	1
28	M8061	Trigger	1

## M Series Liner Colour Chart

**STEEL LINERS**

Colour	Wire Size
Blue	0.6mm-0.9mm
Red	1.0mm-1.2mm
Yellow	1.6mm

**ALUMINIUM LINERS**

Colour	Wire Size
Blue	0.8mm-1.0mm
Red	1.0mm-1.2mm
Yellow	1.6mm

# M38 Binzel Compatible Torch

**AIR COOLED**

Rating 320A @ 60% Duty Cycle Mixed Gases/Wire Sizes 0.8-1.6mm

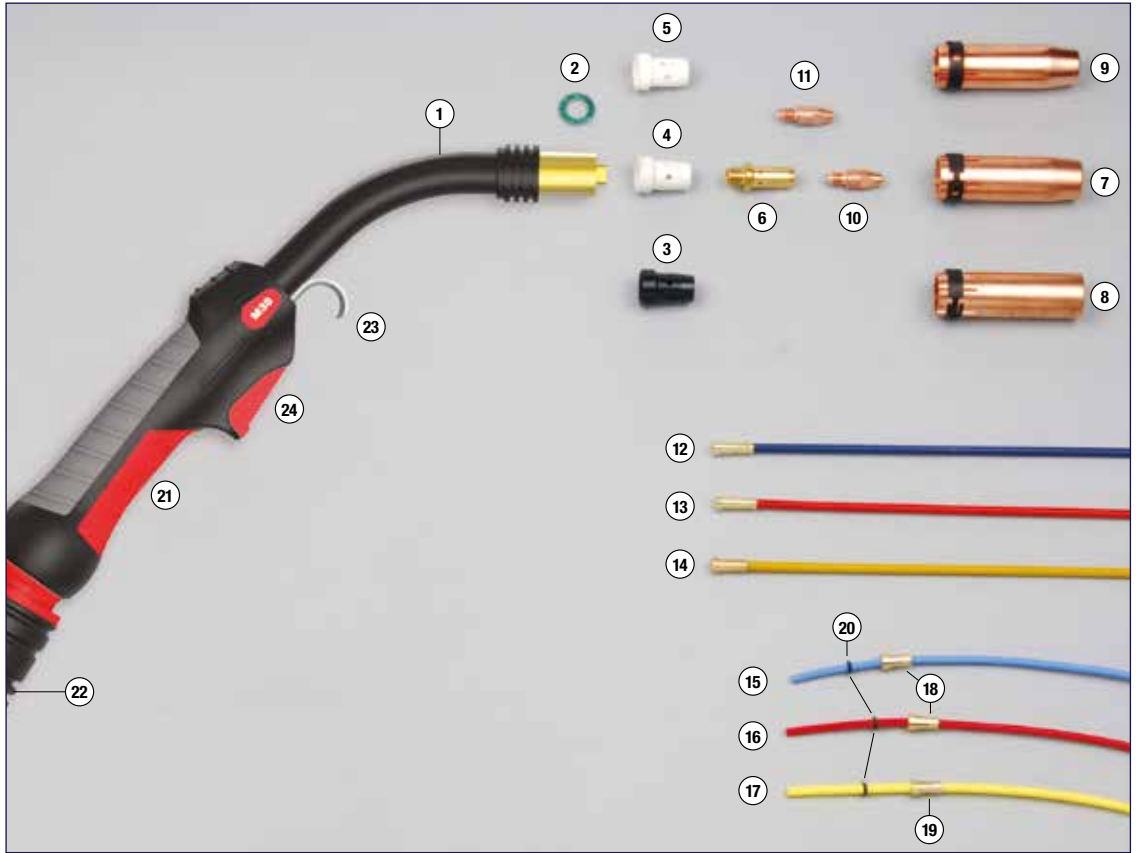

## M38 Torch Packages

Part No.	Description
<b>M38-3</b>	Torch x 3m Bladeswitch complete with Euro Fitting
<b>M38-4</b>	Torch x 4m Bladeswitch complete with Euro Fitting
<b>M38-5</b>	Torch x 5m Bladeswitch complete with Euro Fitting

## M38



## Euro Fitting – M Series



## Consumables

Item	Part No.	Description	Qty
<b>MAIN CONSUMABLES</b>			
1	M3801	Swan Neck	1
2	M3802	Insulating Washer for Tip Adaptor	10
3	M3803	Black Diffuser	5
4	M3804	White Diffuser	5
5	M3805	Ceramic Diffuser	5
6	M3806	Tip Adaptor	5
7	M3807	Conical Nozzle – Copper	5
8	M3808	Cylindrical Nozzle – Copper	5
9	M3809	Tapered Nozzle – Copper	5
<b>CONTACT TIPS (ECU M8 x 30mm)</b>			
10	M2509-08	0.8mm Wire / 0.6mm Aluminium	25
	M2509-09	0.9mm Wire	25
	M2509-10	1.0mm Wire / 0.8mm Aluminium	25
	M2509-12	1.2mm Wire / 1.0mm Aluminium	25
	M2509-14	1.2mm Aluminium	25
	M2509-16	1.6mm Wire	25
<b>CONTACT TIPS (CuCrZr M8 x 30mm)</b>			
11	M2511-08	0.8mm Wire / 0.6mm Aluminium	25
	M2511-09	0.9mm Wire	25
	M2511-10	1.0mm Wire / 0.8mm Aluminium	25
	M2511-12	1.2mm Wire / 1.0mm Aluminium	25
	M2511-14	1.2mm Aluminium	25
	M2511-16	1.6mm Wire	25
<b>LINERS – STEEL</b>			
12	M1510-3	0.6-0.9mm Wire x 3m	1
	M1510-4	0.6-0.8mm Wire x 4m	1
	M1510-5	0.6-0.8mm Wire x 5m	1
13	M1511-3	1.0-1.2mm Wire x 3m	1
	M1511-4	1.0-1.2mm Wire x 4m	1
	M1511-5	1.0-1.2mm Wire x 5m	1
14	M3618-3	1.6mm Wire x 3m	1
	M3618-4	1.6mm Wire x 4m	1
	M3618-5	1.6mm Wire x 5m	1

Item	Part No.	Description	Qty
<b>LINERS – ALUMINIUM</b>			
15	M1512-3	0.6-0.8mm Aluminium Wire x 3m	1
	M1512-4	0.6-0.8mm Aluminium Wire x 4m	1
	M1512-5	0.6-0.8mm Aluminium Wire x 5m	1
16	M1513-3	1.0-1.2mm Aluminium Wire x 3m	1
	M1513-4	1.0-1.2mm Aluminium Wire x 4m	1
	M1513-5	1.0-1.2mm Aluminium Wire x 5m	1
17	M3621-3	1.6mm Aluminium Wire x 3m	1
	M3621-4	1.6mm Aluminium Wire x 4m	1
	M3621-5	1.6mm Aluminium Wire x 5m	1
18	M1514	Collet for Aluminium Liner – up to 1.2mm	5
19	M3623	Collet for Aluminium Liner – 1.6mm	5
20	M1515	O-Ring for Aluminium Liner	10
<b>SECONDARY CONSUMABLES</b>			
21	M8060	Handle c/w Trigger	1
22	M3626-3	3m Cable Assembly	1
	M3626-4	4m Cable Assembly	1
	M3626-5	5m Cable Assembly	1
23	M1519	Hanger Hook	1
24	M8061	Trigger	1



**1356**  
Multi Purpose MIG pliers  
*Order online*

## M Series Liner Colour Chart

### STEEL LINERS

Colour	Wire Size
Blue	0.6mm-0.9mm
Red	1.0mm-1.2mm
Yellow	1.6mm

### ALUMINIUM LINERS

Colour	Wire Size
Blue	0.8mm-1.0mm
Red	1.0mm-1.2mm
Yellow	1.6mm

Rating 500A @ 100% Duty Cycle Mixed Gases/Wire Sizes 0.8-2.4mm

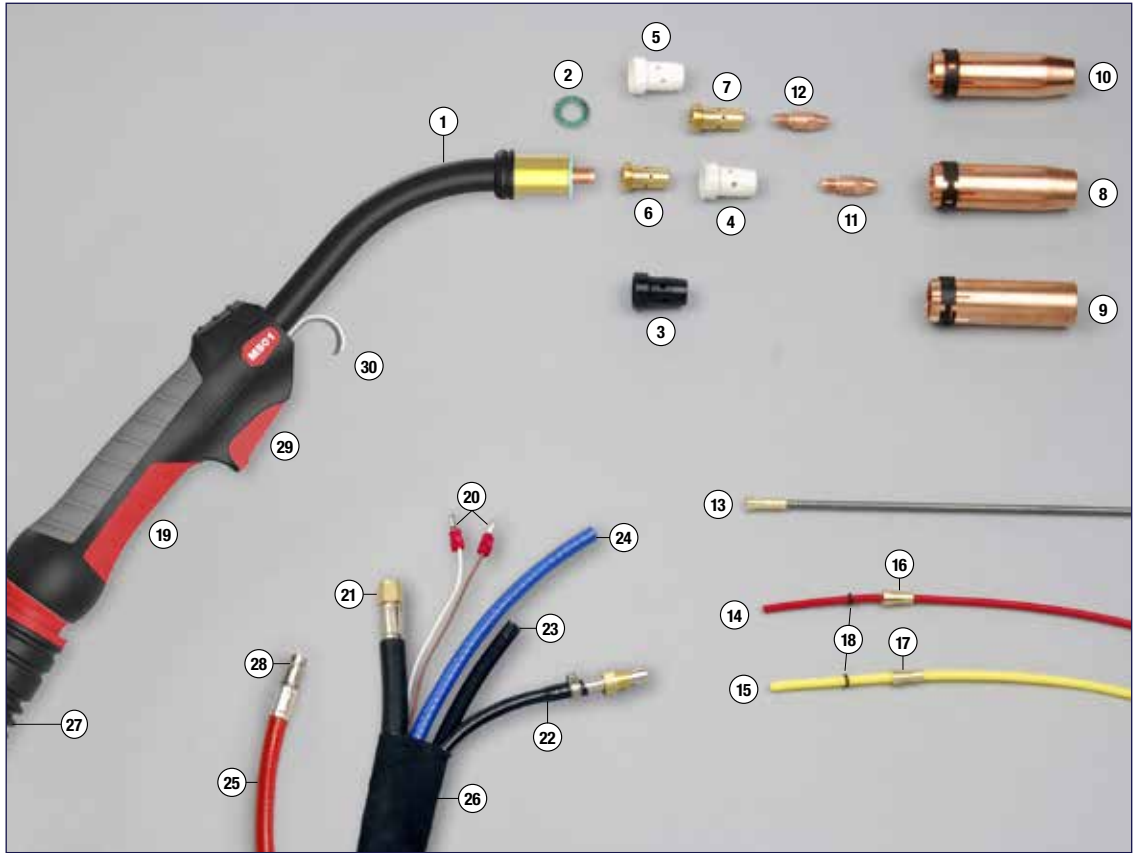

MIG  
Torches

## M501 Torch Packages

Part No.	Description
<b>M501-3</b>	Torch x 3m Bladeswitch complete with Euro Fitting
<b>M501-4</b>	Torch x 4m Bladeswitch complete with Euro Fitting
<b>M501-5</b>	Torch x 5m Bladeswitch complete with Euro Fitting

### M501



### Euro Fitting – M Series





## Consumables

Item	Part No.	Description	Qty
<b>MAIN CONSUMABLES</b>			
1	M5001	Swan Neck	1
2	M3802	Ins. Washer for Tip Adaptor	10
3	M3803	Black Diffuser	5
4	M3804	White Diffuser	5
5	M3805	Ceramic Diffuser	5
6	M5006-8	Short Tip Adaptor for M8 Tips	5
	M5006-6	Short Tip Adaptor for M6 Tips	5
7	M5007-8	Long Tip Adaptor for M8 Tips	5
	M5007-6	Long Tip Adaptor for M6 Tips	5
8	M3807	Conical Nozzle – Copper	5
9	M3808	Cylindrical Nozzle – Copper	5
10	M3809	Tapered Nozzle – Copper	5
<b>CONTACT TIPS (ECU M8 x 30mm)</b>			
11	M2509-08	0.8mm Wire / 0.6mm Aluminium	25
	M2509-09	0.9mm Wire	25
	M2509-10	1.0mm Wire / 0.8mm Aluminium	25
	M2509-12	1.2mm Wire / 1.0mm Aluminium	25
	M2509-14	1.2mm Aluminium	25
	M2509-16	1.6mm Wire	25
	M2509-20	2.0mm Wire / 1.6mm Aluminium	25
	M2509-24	2.4mm Wire	25
<b>CONTACT TIPS (CuCrZr M8 x 30mm)</b>			
12	M2511-08	0.8mm Wire / 0.6mm Aluminium	25
	M2511-10	1.0mm Wire / 0.8mm Aluminium	25
	M2511-09	0.9mm Wire	25
	M2511-12	1.2mm Wire / 1.0mm Aluminium	25
	M2511-14	1.2mm Aluminium	25
	M2511-16	1.6mm Wire	25
<b>LINERS – STEEL</b>			
13	M5031	0.8-1.0mm Wire x 3m	1
	M5041	0.8-1.0mm Wire x 4m	1
	M5051	0.8-1.0mm Wire x 5m	1
	M5032	1.2mm Wire x 3m	1
	M5042	1.2mm Wire x 4m	1
	M5052	1.2mm Wire x 5m	1

Item	Part No.	Description	Qty
<b>LINERS – STEEL (CONTINUED)</b>			
	M5036	1.6mm Wire x 3m	1
	M5046	1.6mm Wire x 4m	1
	M5056	1.6mm Wire x 5m	1
	M5034	2.0-2.4mm Wire x 3m	1
	M5044	2.0-2.4mm Wire x 4m	1
	M5054	2.0-2.4mm Wire x 5m	1
<b>LINERS – ALUMINIUM</b>			
14	M1513-3	1.0-1.2mm Aluminium Wire x 3m	1
	M1513-4	1.0-1.2mm Aluminium Wire x 4m	1
	M1513-5	1.0-1.2mm Aluminium Wire x 5m	1
15	M3621-3	1.6mm Aluminium Wire x 3m	1
	M3621-4	1.6mm Aluminium Wire x 4m	1
	M3621-5	1.6mm Aluminium Wire x 5m	1
16	M1514	Collet for Aluminium Liner – up to 1.2mm	5
17	M3623	Collet for Aluminium Liner – 1.6mm	5
18	M1515	O-Ring for Aluminium Liner	10
<b>SECONDARY CONSUMABLES</b>			
19	M8060	Handle c/w Trigger	1
20	M5020	Trigger Cable / per metre	1
21	M5021-3	3m Power Cable Assembly	1
	M5021-4	4m Power Cable Assembly	1
	M5021-5	5m Power Cable Assembly	1
22	M5022-3	3m Liner Conduit Assembly	1
	M5022-4	4m Liner Conduit Assembly	1
	M5022-5	5m Liner Conduit Assembly	1
23	M5023-3	3m Gas Hose	1
	M5023-4	4m Gas Hose	1
	M5023-5	5m Gas Hose	1
24	M5024	Water Inlet Hose / per metre	1
25	M5025	Water Outlet Hose Assembly – 0.5m	1
26	M5026	Canvas Cover / per metre	1
27	M5027-3	3m Cable Assembly Complete	1
	M5027-4	4m Cable Assembly Complete	1
	M5027-5	5m Cable Assembly Complete	1
28	M5028	Quick Disconnect Hose Nipple	10
29	M8061	Trigger	1
30	M1519	Hanger Hook	1

## M Series Liner Colour Chart

### ALUMINIUM LINERS

Colour	Wire Size
Blue	0.8mm-1.0mm
Red	1.0mm-1.2mm
Yellow	1.6mm

Rating 300A @ 100% Duty Cycle Mixed Gases/Wire Sizes 0.8-1.2mm – Spool Sizes 102 x 45mm

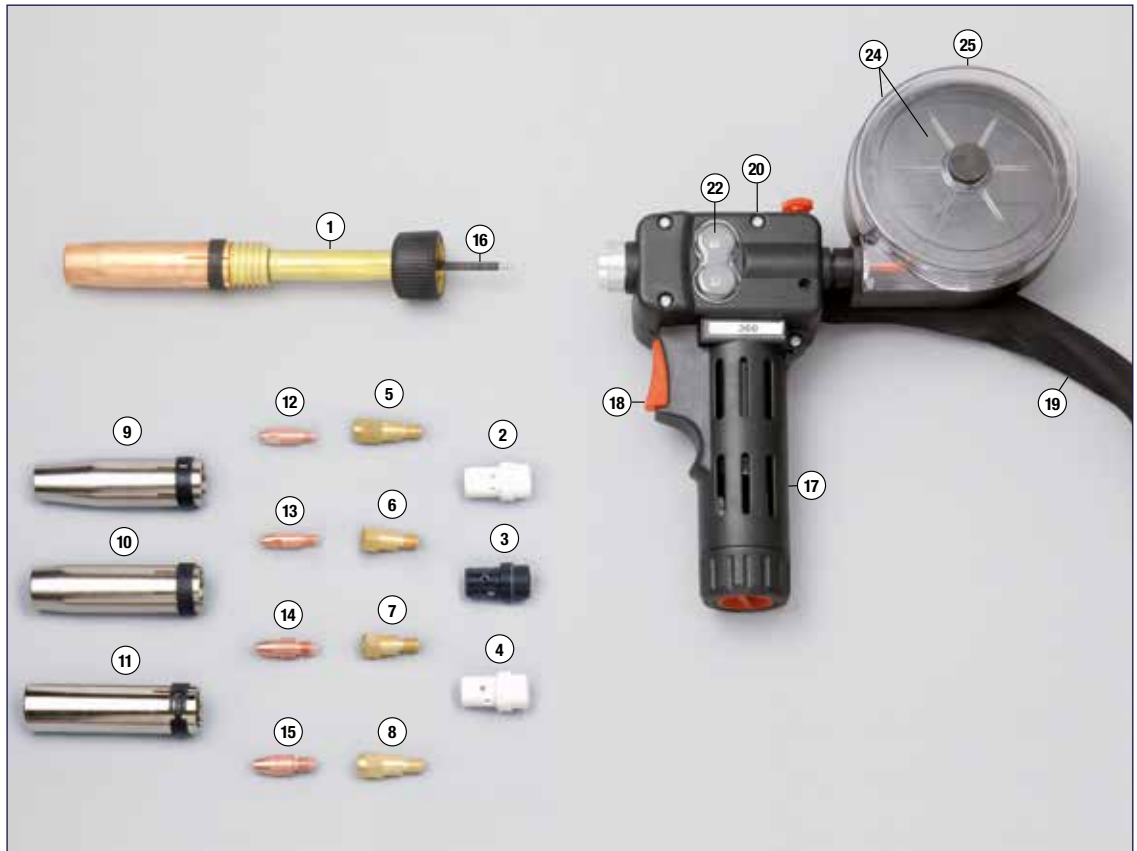

## MSP360 Torch Packages

Part No.	Description
<b>MSP-36-8E</b>	Spool Gun x 8m Straight Neck
<b>MSP-36-8E30</b>	Spool Gun x 8m 30 degree Swan Neck
<b>MSP-36-15E</b>	Spool Gun x 8m Straight Neck
<b>MSP-36-15E30</b>	Spool Gun x 15m 30 degree Swan Neck

### Features

- Flexible rubber sheathed cable assembly
- Recessed wire speed control to prevent damage
- Easy fitting from one machine to another
- No complicated control boxes required
- Standard Euro fitting
- Infinitely variable speed control on the handle

### Technical Data

Wire feed speed	3-20 metres per min
Welding voltage range	15-60v DC
Wire Size	0.8-1.2mm
Spool size	102 x 45mm
Duty cycle	60% max
Welding current	300A @ 60% mixed gases

## Consumables

Item	Part No.	Description	Qty	Item	Part No.	Description	Qty
<b>MAIN CONSUMABLES</b>				<b>SECONDARY CONSUMABLES</b>			
1	MPP3601	Straight Neck	1	16	MPP3602	Neck Liner	1
	MPP3601-30	30 Degree Swan neck	1	17	MSP3603	Complete Handle Assembly	1
2	M3603	White Diffuser	5	18	MSP3604	Trigger Only	1
3	M3602	Black Diffuser	5	19	MSP3619	8m Cable Assembly	1
4	M3604	Ceramic Diffuser	5		MSP3605	15m Cable Assembly	1
5	M3607	Long Tip Adaptor for M6 Tips	5	20	MSP3606	Motor Gear Box Assembly Complete	1
6	M3605	Short Tip Adaptor for M6 Tips	5	21	MSP3607	Electronic Module Complete	1
7	M3606	Short Tip Adaptor for M8 Tips	5	22	MSP3609	Plastic Cover for Rollers	1
8	M3608	Long Tip Adaptor for M8 Tips	5	23	M3627	Euro Connector Complete	1
9	M3611	Tapered Nozzle	5	24	MSP3614	Spool Holder / Cover Complete	1
10	M3609	Conical Nozzle	5	25	MSP3615	Spool Cover Only	1
11	M3610	Cylindrical Nozzle	5	<b>NOT ILLUSTRATED</b>			
<b>CONTACT TIPS (ECU M6 x 28mm)</b>					MSP3608	Set of Rollers 0.8mm Aluminium / Steel	1
12	M2508-06	0.6mm Wire	25		MSP3610	Set of Rollers 1.0mm Aluminium / Steel	1
	M2508-08	0.8mm Wire / 0.6mm Aluminium	25		MSP3612	Set of Rollers 1.2mm Aluminium / Steel	1
	M2508-09	0.9mm Wire	25		MSP3613	Wire Feed Motor Only	1
	M2508-10	1.0mm Wire / 0.8mm Aluminium	25		MSP3616	Potentiometer	1
	M2508-12	1.2mm Wire / 1.0mm Aluminium	25		MSP3617	Pressure Roller and Bush	1
	M2508-14	1.2mm Aluminium	25		MSP3618	Brake Rubber and Nut	1
<b>CONTACT TIPS (CuCrZr M6 x 28mm)</b>							
13	M2510-08	0.8mm Wire / 0.6mm Aluminium	25				
	M2510-09	0.9mm Wire	25				
	M2510-10	1.0mm Wire / 0.8mm Aluminium	25				
	M2510-12	1.2mm Wire / 1.0mm Aluminium	25				
<b>CONTACT TIPS (ECU M8 x 30mm)</b>							
14	M2509-08	0.8mm Wire / 0.6mm Aluminium	25				
	M2509-09	0.9mm Wire	25				
	M2509-10	1.0mm Wire / 0.8mm Aluminium	25				
	M2509-12	1.2mm Wire / 1.0mm Aluminium	25				
	M2509-14	1.2mm Aluminium	25				
<b>CONTACT TIPS (CuCrZr M8 x 30mm)</b>							
15	M2511-08	0.8mm Wire / 0.6mm Aluminium	25				
	M2511-09	0.9mm Wire	25				
	M2511-10	1.0mm Wire / 0.8mm Aluminium	25				
	M2511-12	1.2mm Wire / 1.0mm Aluminium	25				
	M2511-14	1.2mm Aluminium	25				

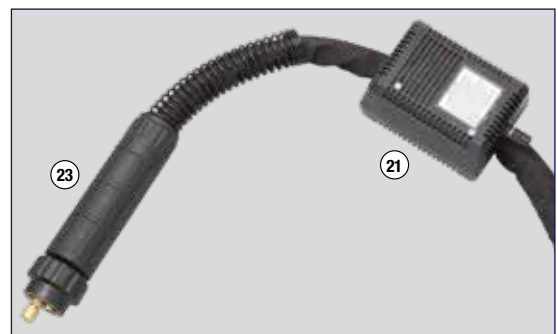



Item	Part No.	Description	Qty
1	M8050	Handle Shell – Air Cooled models	1
	M8055	Handle Shell – Water Cooled models	1
2	M8051	Swivel Joint c/w Support – M15, M25, M36 & M38	1
	M8054	Swivel Joint c/w Support – M501	1
3	M8052	Trigger – All models	1



Item	Part No.	Description	Qty
1	M8035	Handle Shell – All models	1
2	M8036	Swivel Joint c/w Support – E15 & E25	1
	M8038	Swivel Joint c/w Support – E36	1
3	M8037	Trigger – All models	1

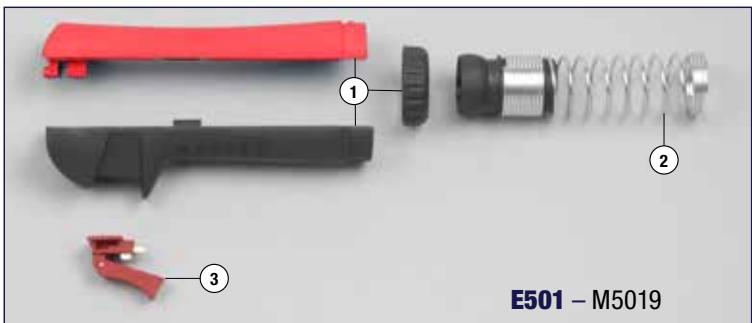

Item	Part No.	Description	Qty
1	M8030	Handle Shell Top / Bottom c/w Locking Nut	1
2	M8031	Swivel Joint c/w Support	1
3	M8032	Trigger	1

# Conversion Kits & Parts



MIG  
Torches

Item	Part No.	Description	Qty
<b>COMPLETE CONVERSION KITS</b>			
	ECK1	Universal Kit – Items 1, 4, 9, 10	1
	ECK2	Standard Long Kit – Items 1, 4, 8, 11 & 13	1
	ECK3	Standard Short Kit – Items 1, 4, 7, 10 & 13	1
	ECK4	Esab A10 Kit – Items 3, 4 & 10	1
<b>MACHINE EURO BODY</b>			
1	ECK10	Standard Connection Block	1
2	ECK11	Side Entry Connection Block	1
3	ECK12	Esab A10 Connection Block	1
<b>MACHINE PLASTIC FLANGES</b>			
4	ECK13	Plastic Flange – 85mm Diameter	1
5	ECK14	Plastic Flange – 50mm Diameter	1
6	ECK15	Square Plastic Flange	1
<b>BRASS GUIDES</b>			
7	ECK16	Standard Short	1
8	ECK17	Standard Long	1
9	ECK18	Threaded Brass Guide	1
<b>CAPILLARY TUBES</b>			
10	ECK19	150mm x 5mm OD x 2mm ID	1
11	ECK20	300mm x 5mm OD x 2mm ID	1
12	ECK21	100mm x 5mm OD x 2mm ID	1

Item	Part No.	Description	Qty
<b>MISCELLANEOUS COMPONENTS</b>			
13	ECK22	Current Clamp	1
14	M5028	Quick Release Nipple	10
15	ECK23	Quick Release Coupler	1
16	ECK24	Quick Release Coupler – 1/4" Male	1
	ECK25	Quick Release Coupler – 3/8" Male	1
17	ECK26	Quick Release Coupler – 1/4" Female	1
	ECK27	Quick Release Coupler – 3/8" Female	1
18	ECK29	Quick Release Coupler – Blue	1
19	ECK30	Quick Release Coupler – Red	1
20	T5024	8.0mm Clamp	10
	T5025	8.7mm Clamp	10
	ECK31	9.5mm Clamp	10
21	ECK33	M12 x 1 Nut	10
22	ECK34	Washer	10

# TW2 Tweco Compatible Torch

**AIR COOLED**

Rating 200A @ 80% Duty Cycle CO<sub>2</sub> Gases/Wire Sizes 0.6-1.2mm

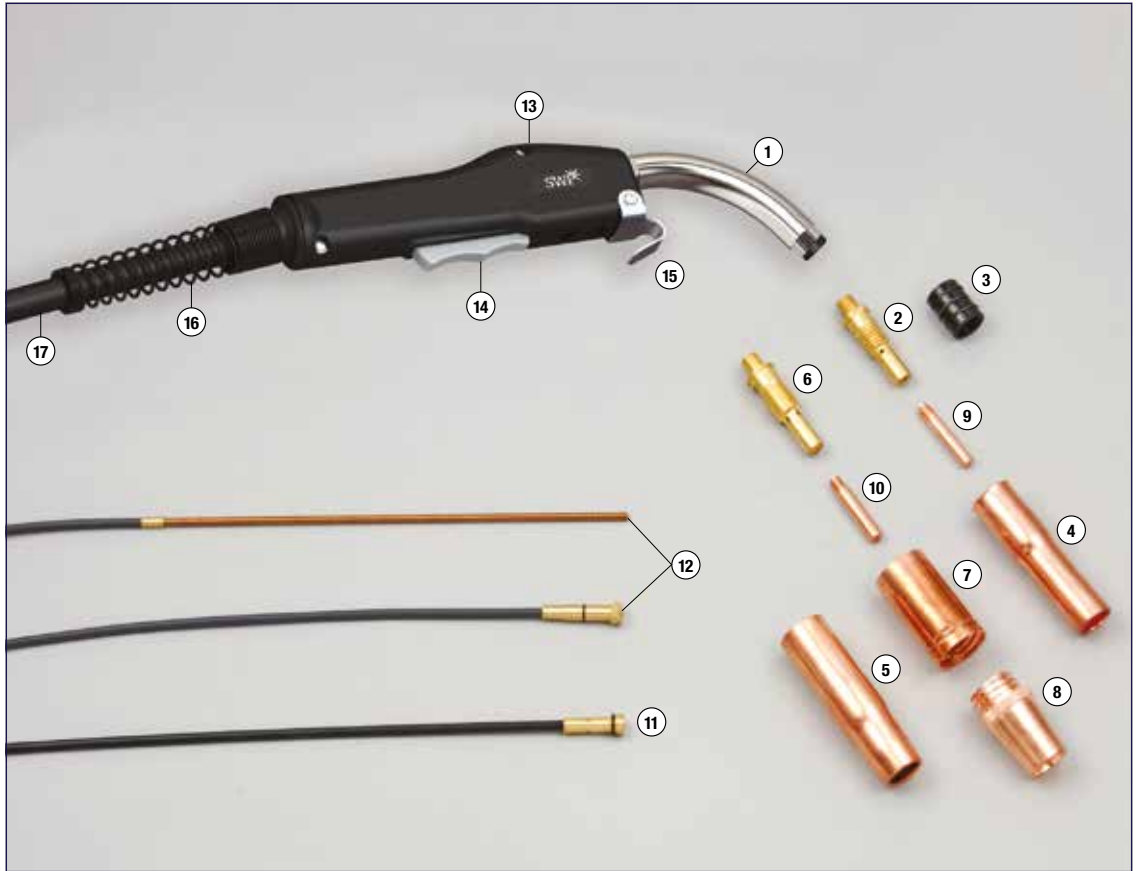

MIG  
Torches

## TW2 Torch Packages

Part No.	Description
<b>TW2-10E</b>	Torch x 10ft complete with Euro Fitting
<b>TW2-12E</b>	Torch x 12ft complete with Euro Fitting
<b>TW2-15E</b>	Torch x 15ft complete with Euro Fitting

Part No.	Description
<b>TW2-10T</b>	Torch x 10ft complete with Tweco Fitting
<b>TW2-12T</b>	Torch x 12ft complete with Tweco Fitting
<b>TW2-15T</b>	Torch x 15ft complete with Tweco Fitting

## Euro Fitting



## Tweco Termination





### Consumables

Item	Part No.	Description	Qty
<b>MAIN CONSUMABLES</b>			
1	62J60	60° Metal Jacket Conductor Tube	1
	62A60	60° Conductor Tube – Neoprene Insulation	1
	62A45	45° Conductor Tube – Neoprene Insulation	1
2	52-23	Gas Diffuser – 0.6mm Wire	5
	52	Gas Diffuser – 0.8-1.2mm Wire	5
3	32	Nozzle Insulator – Adjustable	5
4	22-50	Nozzle Adjustable – 12mm Bore	5
	22-62	Nozzle Adjustable – 16mm Bore	5
5	23-37	Nozzle c/w Insulation – 9mm Bore	5
	23-50	Nozzle c/w Insulation – 12mm Bore	5
	23-62	Nozzle c/w Insulation – 16mm Bore	5
	23-75	Nozzle c/w Insulation – 19mm Bore	5
6	52FN	Gas Diffuser for CT Nozzles	5
7	34CT	Insulator for CT Nozzles	5
8	24CT-37S	CT Nozzle – 9mm Bore	5
	24CT-50S	CT Nozzle – 12mm Bore	5
	24CT-62S	CT Nozzle – 16mm Bore	5
	24CT-75S	CT Nozzle – 19mm Bore	5
<b>CONTACT TIPS – STANDARD</b>			
9	14-23	Standard Ecu – 0.6mm Wire	25
	14-30	Standard Ecu – 0.8mm Wire	25
	14-35	Standard Ecu – 0.9mm Wire	25
	14-40	Standard Ecu – 1.0mm Wire	25
	14-45	Standard Ecu – 1.2mm Wire	25
<b>CONTACT TIPS – HEAVY DUTY</b>			
10	14H30	Heavy Duty Ecu – 0.8mm Wire	25
	14H35	Heavy Duty Ecu – 0.9mm Wire	25
	14H40	Heavy Duty Ecu – 1.0mm Wire	25
	14H45	Heavy Duty Ecu – 1.2mm Wire	25
<b>LINERS – STEEL &amp; ALUMINIUM</b>			
11	42-23-15	Steel – 0.6mm Wire x 15ft	1
	42-3035-15	Steel – 0.8-0.9mm Wire x 15ft	1
	42-4045-15	Steel – 1.0-1.2mm Wire x 15ft	1
12	42N-3035-15	Aluminium – 0.6-0.9mm Wire x 15ft	1

Item	Part No.	Description	Qty
<b>SECONDARY CONSUMABLES</b>			
13	82B	Handle – New Style c/w Swivel Joint	1
	82	Handle – Old Style	1
14	92	Switch	1
15	152	Hanger Hook	1
16	142-6B	Cable Support – 82B Handle	1
	142-6	Cable Support – 82 Handle	1
17	200-10E	10ft Cable Assembly – Euro Fitting	1
	200-12E	12ft Cable Assembly – Euro Fitting	1
	200-15E	15ft Cable Assembly – Euro Fitting	1
	200-10	10ft Cable Assembly – Tweco Fitting	1
	200-12	12ft Cable Assembly – Tweco Fitting	1
	200-15	15ft Cable Assembly – Tweco Fitting	1
<b>EURO FITTING PARTS</b>			
	TW2318	Complete Euro Connection Kit	1
18	TW2001	Gun Plug Housing	1
	M1518-2	Screw for Housing (not illustrated)	5
19	M1518-3	Gun Plug Nut	1
20	TW2318-4	Gun Plug Body c/w Spring Pins	1
21	M1518-5	O-Ring for Gun Plug Body	10
22	174EX-1C	Liner Retaining Nut	5
23	TW2002	Cable Support – Euro Fitting	1
<b>TWECO TERMINATION</b>			
24	TW2319	Complete Tweco Connection	1
25	TW2320	Switch Lead for Tweco Connection	1

### TW2



# TW4 Tweco Compatible Torch

**AIR COOLED**

Rating 400A @ 80% Duty Cycle CO<sub>2</sub> Gases/Wire Sizes 0.6-2.0mm

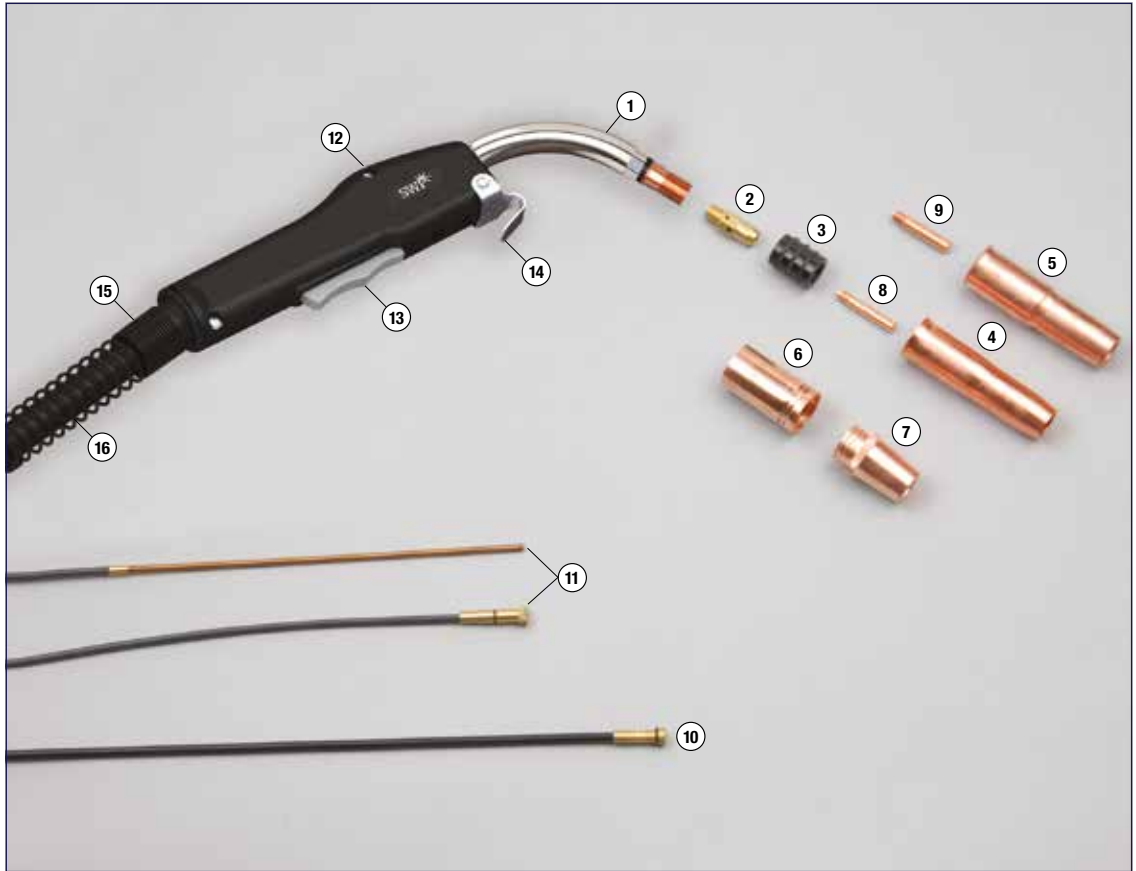

MIG  
Torches

## TW4 Torch Packages

Part No.	Description
<b>TW4-10E</b>	Torch x 10ft complete with Euro Fitting
<b>TW4-12E</b>	Torch x 12ft complete with Euro Fitting
<b>TW4-15E</b>	Torch x 15ft complete with Euro Fitting

Part No.	Description
<b>TW4-10T</b>	Torch x 10ft complete with Tweco Fitting
<b>TW4-12T</b>	Torch x 12ft complete with Tweco Fitting
<b>TW4-15T</b>	Torch x 15ft complete with Tweco Fitting

## Euro Fitting



## Tweco Termination



### Consumables

Item	Part No.	Description	Qty
<b>MAIN CONSUMABLES</b>			
1	64J60	60° Metal Jacket Conductor Tube	1
	64A60	60° Conductor Tube – Neoprene Insulation	1
	64A45	45° Conductor Tube – Neoprene Insulation	1
	64A80	80° Conductor Tube – Neoprene Insulation	1
2	54A	Gas Diffuser	5
3	34A	Nozzle Insulator – Adjustable	5
4	24A50	Nozzle Adjustable – 12mm Bore	5
	24A62	Nozzle Adjustable – 16mm Bore	5
	24A75	Nozzle Adjustable – 19mm Bore	5
5	24AH-50	Heavy Duty Nozzle – Adjustable 12mm Bore	5
	24AH-62	Heavy Duty Nozzle – Adjustable 16mm Bore	5
	24AH-75	Heavy Duty Nozzle – Adjustable 19mm Bore	5
6	34CT	Insulator for CT Nozzles	5
7	24CT-37S	CT Nozzle – 9mm Bore	5
	24CT-50S	CT Nozzle – 12mm Bore	5
	24CT-62S	CT Nozzle – 16mm Bore	5
	24CT-75S	CT Nozzle – 19mm Bore	5
<b>CONTACT TIPS – STANDARD</b>			
8	14-23	Standard Ecu – 0.6mm Wire	25
	14-30	Standard Ecu – 0.8mm Wire	25
	14-35	Standard Ecu – 0.9mm Wire	25
	14-40	Standard Ecu – 1.0mm Wire	25
	14-45	Standard Ecu – 1.2mm Wire	25
	14-52	Standard Ecu – 1.3mm Wire	25
	14-116	Standard Ecu – 1.6mm Wire	25
	14-564	Standard Ecu – 2.0mm Wire	25
<b>CONTACT TIPS – HEAVY DUTY</b>			
9	14H30	Heavy Duty Ecu – 0.8mm Wire	25
	14H35	Heavy Duty Ecu – 0.9mm Wire	25
	14H40	Heavy Duty Ecu – 1.0mm Wire	25
	14H45	Heavy Duty Ecu – 1.2mm Wire	25
	14H52	Heavy Duty Ecu – 1.3mm Wire	25
	14H116	Heavy Duty Ecu – 1.6mm Wire	25
	14H564	Heavy Duty Ecu – 2.0mm Wire	25
<b>LINERS – STEEL &amp; ALUMINIUM</b>			
10	44-3545-15	Steel – 0.9-1.2mm Wire x 15ft	1
	44-116-15	Steel – 1.6mm Wire x 15ft	1
	44-564-15	Steel – 2.0mm Wire x 15ft	1
11	44N-3545-15	Aluminium – 0.9-1.2mm Wire x 15ft	
	44N-116-15	Aluminium – 1.6mm Wire x 15ft	1

Item	Part No.	Description	Qty
<b>SECONDARY CONSUMABLES</b>			
12	84B	Handle – New Style c/w Swivel Joint	1
	84A	Handle – Old Style	1
13	94R	Switch	1
14	154	Hanger Hook	1
15	144-6B	Cable Support – 84B Handle	
	144-6	Cable Support – 84A Handle	1
16	400-10E	10ft Cable Assembly – Euro Fitting	1
	400-12E	12ft Cable Assembly – Euro Fitting	1
	400-15E	15ft Cable Assembly – Euro Fitting	1
	400-10	10ft Cable Assembly – Tweco Fitting	1
	400-12	12ft Cable Assembly – Tweco Fitting	1
	400-15	15ft Cable Assembly – Tweco Fitting	1
<b>EURO FITTING PARTS</b>			
	TW4517	Complete Euro Connection Kit	1
17	T2004	Gun Plug Housing	1
	M1518-2	Screw for Housing (not illustrated)	5
18	M1518-3	Gun Plug Nut	1
19	TW2318-4	Gun Plug Body c/w Spring Pins	1
20	M1518-5	O-Ring for Gun Plug Body	10
21	174EX-1C	Liner Retaining Nut	5
22	T2005	Cable Support – Euro Fitting	1
<b>TWECO TERMINATION</b>			
23	TW2319	Complete Tweco Connection	1
24	TW2320	Switch Lead for Tweco Connection	1

### TW4



# BE302/302E Bernard Compatible Torch

**AIR COOLED**

**BE302** – Rating 300A @ 100% Duty Cycle CO<sub>2</sub> Gases for BE302/Wire Sizes 0.6-1.3mm

**BE302E** – Rating 300A @ 60% Duty Cycle CO<sub>2</sub> Gases for BE302E/Wire Sizes 0.6-1.3mm



## BE302 Torch Packages

Part No.	Description
<b>2-4310AE</b>	Torch x 10ft complete with Euro Fitting
<b>2-4312AE</b>	Torch x 12ft complete with Euro Fitting
<b>2-4315AE</b>	Torch x 15ft complete with Euro Fitting

## BE302E Torch Packages

Part No.	Description
<b>4E310AE</b>	Torch x 10ft complete with Euro Fitting
<b>4E312AE</b>	Torch x 12ft complete with Euro Fitting
<b>4E315AE</b>	Torch x 15ft complete with Euro Fitting

## Euro Fitting



## BE302/BE302E Torch



MIG  
Torches

## Consumables

Item	Part No.	Description	Qty
<b>MAIN CONSUMABLES</b>			
1	4786	Body Tube	1
2	R4323-R	Cap – Rubber	5
	R4323	Cap – Phenolic	5
3	4335	Head Assembly for 74 Series Short Tips	5
4	4235	Head Assembly for 15 Series Long Tips	5
5	B4780	Insulator – Hexagonal Nut	5
6	4391	Nozzle – Brass 5/8" Bore	5
7	4392	Nozzle – Brass 1/2" Bore	5
8	4295	Pipeline Nozzle	5
9	4394	Nozzle – Copper 1/2" Bore	5
10	4393	Nozzle – Copper 5/8" Bore	5
<b>CONTACT TIPS – SHORT</b>			
11	7497	Standard Short – 31mm – 0.6mm Wire	10
	7488	Standard Short – 31mm – 0.8mm Wire	10
	7489	Standard Short – 31mm – 0.9mm Wire	10
	7496	Standard Short – 31mm – 1.0mm Wire	10
	7490	Standard Short – 31mm – 1.2mm Wire	10
	7498	Standard Short – 31mm – 1.3mm Wire	10
<b>CONTACT TIPS – LONG</b>			
12	1597	Standard Long – 50mm – 0.6mm Wire	10
	1588	Standard Long – 50mm – 0.8mm Wire	10
	1589	Standard Long – 50mm – 0.9mm Wire	10
	1596	Standard Long – 50mm – 1.0mm Wire	10
	1590	Standard Long – 50mm – 1.2mm Wire	10
	1598	Standard Long – 50mm – 1.3mm Wire	10
<b>CONTACT TIPS – PIPELINE</b>			
13	4281	Standard Pipeline – 0.9mm Wire	10
	4282	Standard Pipeline – 1.2mm Wire	10
	4283	Standard Pipeline – 1.3mm Wire	10
<b>LINERS – STEEL &amp; ALUMINIUM</b>			
14	43010	Steel – 0.6-0.8mm Wire x 10ft	1
	43015	Steel – 0.6-0.8mm Wire x 15ft	1
	43110	Steel – 0.9-1.2mm Wire x 10ft	1
	43115	Steel – 0.9-1.2mm Wire x 15ft	1
15	43115X	Aluminium – 0.9-1.2mm Wire x 15ft	1

Item	Part No.	Description	Qty
<b>SECONDARY CONSUMABLES</b>			
16	1780006	Handle	1
17	5662	Trigger	1
18	1880004	Handle Screw Kit	1
19	R4238	Hook	1
20	B2001	Cable Support – Handle	1
21	4261TE	10ft Cable Assembly for BE302E	1
	4262TE	12ft Cable Assembly for BE302E	1
	4265TE	15ft Cable Assembly for BE302E	1
	4361TE	10ft Cable Assembly for BE302	1
	4362TE	12ft Cable Assembly for BE302	1
	4365TE	15ft Cable Assembly for BE302	1
<b>EURO FITTING PARTS</b>			
	B2420	Complete Euro Connection Kit	1
22	T2004	Gun Plug Housing	1
	M1518-2	Screw for Housing (not illustrated)	5
23	M1518-3	Gun Plug Nut	1
24	B2420-4	Gun Plug Body c/w Spring Pins	1
25	M1518-5	O-Ring for Gun Plug Body	10
26	T2005	Cable Support – Euro Fitting	1



**1356**  
Multi Purpose MIG pliers  
*Order online*

Rating 350A @ 100% Duty Cycle CO<sub>2</sub> Gases/Wire Sizes 0.6-1.6mm



## BE352 Torch Packages

Part No.	Description
<b>2-43510AE</b>	Torch x 10ft complete with Euro Fitting
<b>2-43512AE</b>	Torch x 12ft complete with Euro Fitting
<b>2-43515AE</b>	Torch x 15ft complete with Euro Fitting

### Euro Fitting



### BE352 Torch





## Consumables

Item	Part No.	Description	Qty
<b>MAIN CONSUMABLES</b>			
1	4790	Body Tube	1
2	R4423-R	Cap – Rubber	5
3	4435	Head Assembly for 74 Series Short Tips	5
4	4635	Head Assembly for 15 Series Long Tips	5
5	B4780	Insulator – Hexagonal Nut	5
6	4491	Nozzle – Brass 3/4" Bore	5
7	4492	Nozzle – Brass 1/2" Bore	5
8	4591	Nozzle – Copper 3/4" Bore	5
9	4592	Nozzle – Copper 1/2" Bore	5
<b>CONTACT TIPS – SHORT</b>			
10	7497	Standard Short – 31mm – 0.6mm Wire	10
	7488	Standard Short – 31mm – 0.8mm Wire	10
	7489	Standard Short – 31mm – 0.9mm Wire	10
	7496	Standard Short – 31mm – 1.0mm Wire	10
	7490	Standard Short – 31mm – 1.2mm Wire	10
	7498	Standard Short – 31mm – 1.3mm Wire	10
	7491	Standard Short – 31mm – 1.6mm Wire	10
<b>CONTACT TIPS – LONG</b>			
11	1597	Standard Long – 50mm – 0.6mm Wire	10
	1588	Standard Long – 50mm – 0.8mm Wire	10
	1589	Standard Long – 50mm – 0.9mm Wire	10
	1596	Standard Long – 50mm – 1.0mm Wire	10
	1590	Standard Long – 50mm – 1.2mm Wire	10
	1598	Standard Long – 50mm – 1.3mm Wire	10
	1591	Standard Long – 50mm – 1.6mm Wire	10
<b>CONTACT TIPS – PIPELINE</b>			
12	4281	Standard Pipeline – 0.9mm Wire	10
	4282	Standard Pipeline – 1.2mm Wire	10
	4283	Standard Pipeline – 1.3mm Wire	10
<b>LINERS – STEEL &amp; ALUMINIUM</b>			
13	43010	Steel – 0.6-0.8mm Wire x 10ft	1
	43015	Steel – 0.6-0.8mm Wire x 15ft	1
	43110	Steel – 0.9-1.2mm Wire x 10ft	1
	43115	Steel – 0.9-1.2mm Wire x 15ft	1
14	43115X	Aluminium – 0.9-1.2mm Wire x 15ft	1

Item	Part No.	Description	Qty
<b>SECONDARY CONSUMABLES</b>			
15	1780006	Handle	1
16	5662	Trigger	1
17	1880004	Handle Screw Kit	1
18	R4238	Hook	1
19	144-6B	Cable Support – Handle	1
20	4361TE	10ft Cable Assembly	1
	4362TE	12ft Cable Assembly	1
	4365TE	15ft Cable Assembly	1
<b>EURO FITTING PARTS</b>			
	B2420	Complete Euro Connection Kit	1
21	T2004	Gun Plug Housing	1
	M1518-2	Screw for Housing (not illustrated)	5
22	M1518-3	Gun Plug Nut	1
23	B2420-4	Gun Plug Body c/w Spring Pins	1
24	M1518-5	O-Ring for Gun Plug Body	10
25	T2005	Cable Support – Euro Fitting	1



**1356**  
Multi Purpose MIG pliers  
*Order online*

# BE402/402E Bernard Compatible Torch

**AIR COOLED**

**BE402** – Rating 400A @ 100% Duty Cycle CO<sub>2</sub> Gases for BE302/Wire Sizes 0.6-2.0mm

**BE402E** – Rating 400A @ 60% Duty Cycle CO<sub>2</sub> Gases for BE302E/Wire Sizes 0.6-1.6mm



## BE402 Torch Packages

Part No.	Description
<b>2-4410AE</b>	Torch x 10ft complete with Euro Fitting
<b>2-4412AE</b>	Torch x 12ft complete with Euro Fitting
<b>2-4415AE</b>	Torch x 15ft complete with Euro Fitting

## BE402E Torch Packages

Part No.	Description
<b>4E410AE</b>	Torch x 10ft complete with Euro Fitting
<b>4E412AE</b>	Torch x 12ft complete with Euro Fitting
<b>4E415AE</b>	Torch x 15ft complete with Euro Fitting

## Euro Fitting

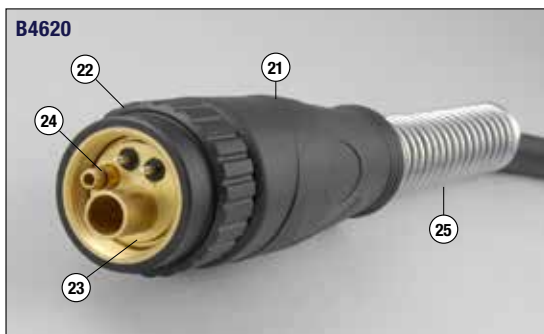

## Euro Fitting



MIG  
Torches

## Consumables

Item	Part No.	Description	Qty
<b>MAIN CONSUMABLES</b>			
1	4790	Body Tube	1
2	R4423-R	Cap – Rubber	5
3	4435	Head Assembly for 74 Series Short Tips	5
4	4635	Head Assembly for 15 Series Long Tips	5
5	B4780	Insulator – Hexagonal Nut	5
6	4491	Nozzle – Brass 3/4" Bore	5
7	4492	Nozzle – Brass 1/2" Bore	5
8	4591	Nozzle – Copper 3/4" Bore	5
9	4592	Nozzle – Copper 1/2" Bore	5
<b>CONTACT TIPS – SHORT</b>			
10	7497	Standard Short – 31mm – 0.6mm Wire	10
	7488	Standard Short – 31mm – 0.8mm Wire	10
	7489	Standard Short – 31mm – 0.9mm Wire	10
	7496	Standard Short – 31mm – 1.0mm Wire	10
	7490	Standard Short – 31mm – 1.2mm Wire	10
	7498	Standard Short – 31mm – 1.3mm Wire	10
	7491	Standard Short – 31mm – 1.6mm Wire	10
	7492	Standard Short – 31mm – 2.0mm Wire	10
<b>CONTACT TIPS – LONG</b>			
11	1597	Standard Long – 50mm – 0.6mm Wire	10
	1588	Standard Long – 50mm – 0.8mm Wire	10
	1589	Standard Long – 50mm – 0.9mm Wire	10
	1596	Standard Long – 50mm – 1.0mm Wire	10
	1590	Standard Long – 50mm – 1.2mm Wire	10
	1598	Standard Long – 50mm – 1.3mm Wire	10
	1591	Standard Long – 50mm – 1.6mm Wire	10
	1592	Standard Long – 50mm – 2.0mm Wire	10
<b>CONTACT TIPS – PIPELINE</b>			
12	4281	Standard Pipeline – 0.9mm Wire	10
	4282	Standard Pipeline – 1.2mm Wire	10
	4283	Standard Pipeline – 1.3mm Wire	10
<b>LINERS – STEEL &amp; ALUMINIUM</b>			
13	44110	Steel – 0.9-1.2mm Wire x 10ft	1
	44115	Steel – 0.9-1.2mm Wire x 15ft	1
	44210	Steel – 1.2-1.6mm Wire x 10ft	1
	44215	Steel – 1.2-1.6mm Wire x 15ft	1
	44310	Steel – 2.0mm Wire x 10ft	1
	44315	Steel – 2.0mm Wire x 15ft	1
14	43115X	Aluminium – 0.9-1.2mm Wire x 15ft	1
	44215X	Aluminium – 1.6mm Wire x 15ft	1

Item	Part No.	Description	Qty
<b>SECONDARY CONSUMABLES</b>			
15	4408	Handle for BE402	1
	1780006	Handle for BE402E	1
16	4422	Trigger for BE402	1
	5662	Trigger for BE402E	1
17	4426	Handle Screw Kit for BE402	1
	1880004	Handle Screw Kit for BE402E	1
18	R4238	Hook – BE402E	1
19	144-6B	Cable Support c/w Ball Joint – BE402E	1
20	4361TE	10ft Cable Assembly for BE402E	1
	4362TE	12ft Cable Assembly for BE402E	1
	4365TE	15ft Cable Assembly for BE402E	1
	4461TE	10ft Cable Assembly for BE402	1
	4462TE	12ft Cable Assembly for BE402	1
	4465TE	15ft Cable Assembly for BE402	1
<b>EURO FITTING PARTS – B4620</b>			
21	X6RC	Gun Plug Housing	1
	M1518-2	Screw for Gun Plug Housing (not illustrated)	5
22	M1518-3	Gun Plug Nut	1
23	B2420-4	Gun Plug Body c/w Spring Pins	1
24	M1518-5	O-Ring for Gun Plug Body	10
25	TW4517-7	Cable Support – Euro Fitting	1
<b>EURO FITTING PARTS – B2420</b>			
26	T2004	Gun Plug Housing	1
	M1518-2	Screw for Gun Plug Housing (not illustrated)	5
27	M1518-3	Gun Plug Nut	1
28	B2420-4	Gun Plug Body c/w Spring Pins	1
29	M1518-5	O-Ring for Gun Plug Body	10
30	T2005	Cable Support – Euro Fitting	1

**BE402**

**BE402E**

Rating 250A @ 60% Duty Cycle CO<sub>2</sub> Gases/Wire Sizes 0.6-1.2mm

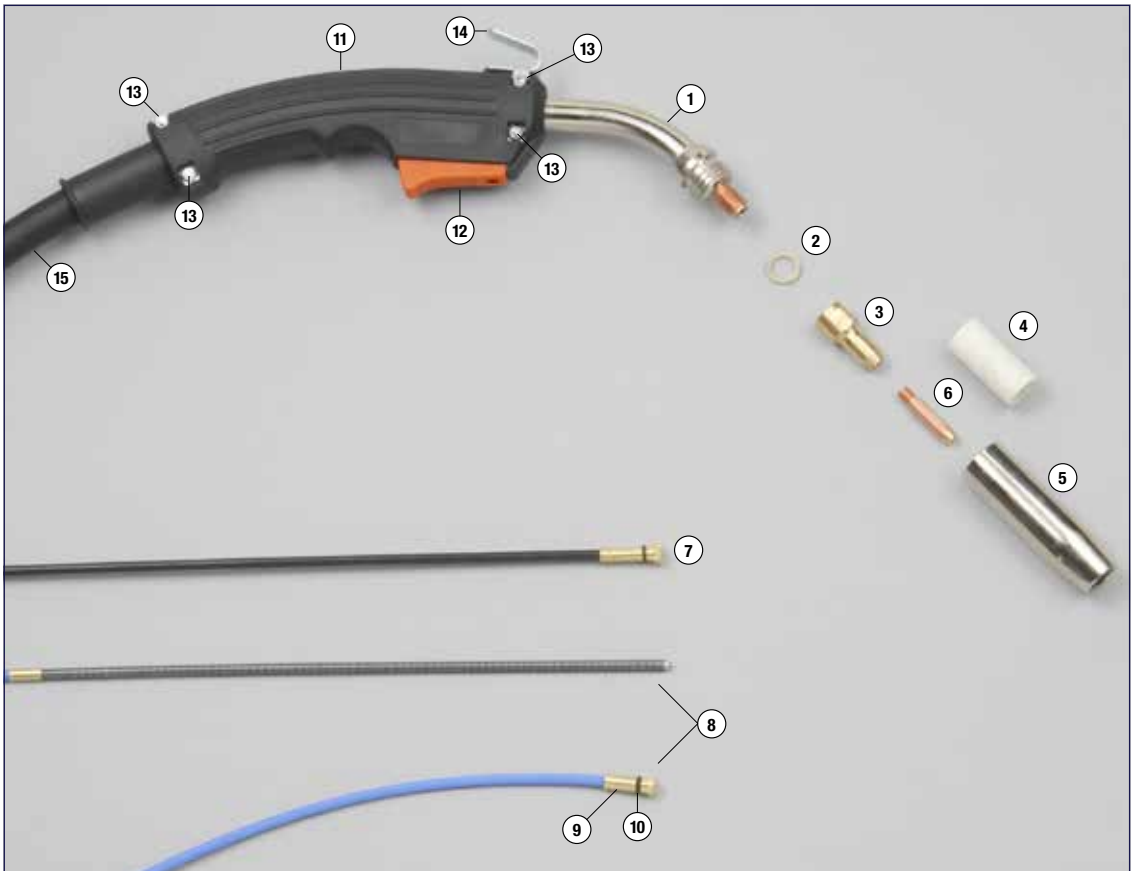

MIG  
Torches

## MX253 Torch Packages

Part No.	Description
<b>1415030</b>	Torch x 3m complete with Euro Fitting
<b>1415031</b>	Torch x 4m complete with Euro Fitting

### Euro Fitting



### MX253 Torch



## Consumables

Item	Part No.	Description	Qty
<b>MAIN CONSUMABLES</b>			
1	1412552	Swan Neck	1
2	1412560	Neck Washer	5
3	1408655	Gas Diffuser	5
4	1408620	Nozzle Insulator	5
5	1408602	Conical Nozzle – Short 65mm	5
	1411350	Conical Nozzle – Long 70mm	5
	1408604	Cylindrical Nozzle – Long 70mm	5
	1408603	Spot Welding Nozzle	5
<b>CONTACT TIPS</b>			
6	1408700	Contact Tip – Hexagonal – 0.6mm Wire	25
	1408701	Contact Tip – Hexagonal – 0.8mm Wire	25
	1408703	Contact Tip – Hexagonal – 1.0mm Wire	25
	1408704	Contact Tip – Hexagonal – 1.2mm Wire	25
	1415255	Contact Tip – Hexagonal – 1.4mm Wire	25
<b>LINERS – STEEL &amp; ALUMINIUM</b>			
7	1412530	Steel 0.6-0.8mm Wire x 3m	1
	1412531	Steel 0.6-0.8mm Wire x 4.5m	1
	1412532	Steel 0.8-1.2mm Wire x 3m	1
	1412533	Steel 0.8-1.2mm Wire x 4.5m	1
8	57155	Aluminium – 0.8-1.0mm Wire x 3m	1
	57157	Aluminium – 0.8-1.0mm Wire x 4m	1
	57200	Aluminium – 1.0-1.2mm Wire x 3m	1
	57202	Aluminium – 1.0-1.2mm Wire x 4m	1
	1414764	Aluminium – 1.0-1.2mm Wire x 4.5m	1
9	1412540	Liner Nipple – Small	5
10	1412596	Liner O-Ring – Small	10

Item	Part No.	Description	Qty
<b>SECONDARY CONSUMABLES</b>			
11	1415044	Handle Only	1
12	1412567	Switch Assembly with Spring	1
13	1412614	Handle Screw Kit	1
14	1412564	Gun Hook for Handle	1
15	1412571	3m Cable Assembly	1
	1412572	4m Cable Assembly	1
<b>EURO FITTING PARTS</b>			
16	1412605	Support Sleeve	1
17	1412601	Gun Plug Housing	1
18	1408652	Gun Plug Nut	1
19	1412598	Gun Plug Body c/w Spring Pins	1
20	1408650	Liner Retaining Nut	1



**6044**  
Welding and Grinding PAPR System  
See page 286

## MX253 Liner Colour Chart

**STEEL LINERS**

Colour	Wire Size
Black	0.6mm-0.8mm
Blue	0.8mm-1.2mm
Grey	1.2mm-1.4mm
Red	1.4mm-2.0mm

**ALUMINIUM LINERS**

Colour	Wire Size
Black	0.8mm-1.0mm
Blue	1.0mm-1.2mm
Red	1.6mm

Rating 360A @ 60% Duty Cycle CO<sub>2</sub> Gases/Wire Sizes 0.8-1.6mm

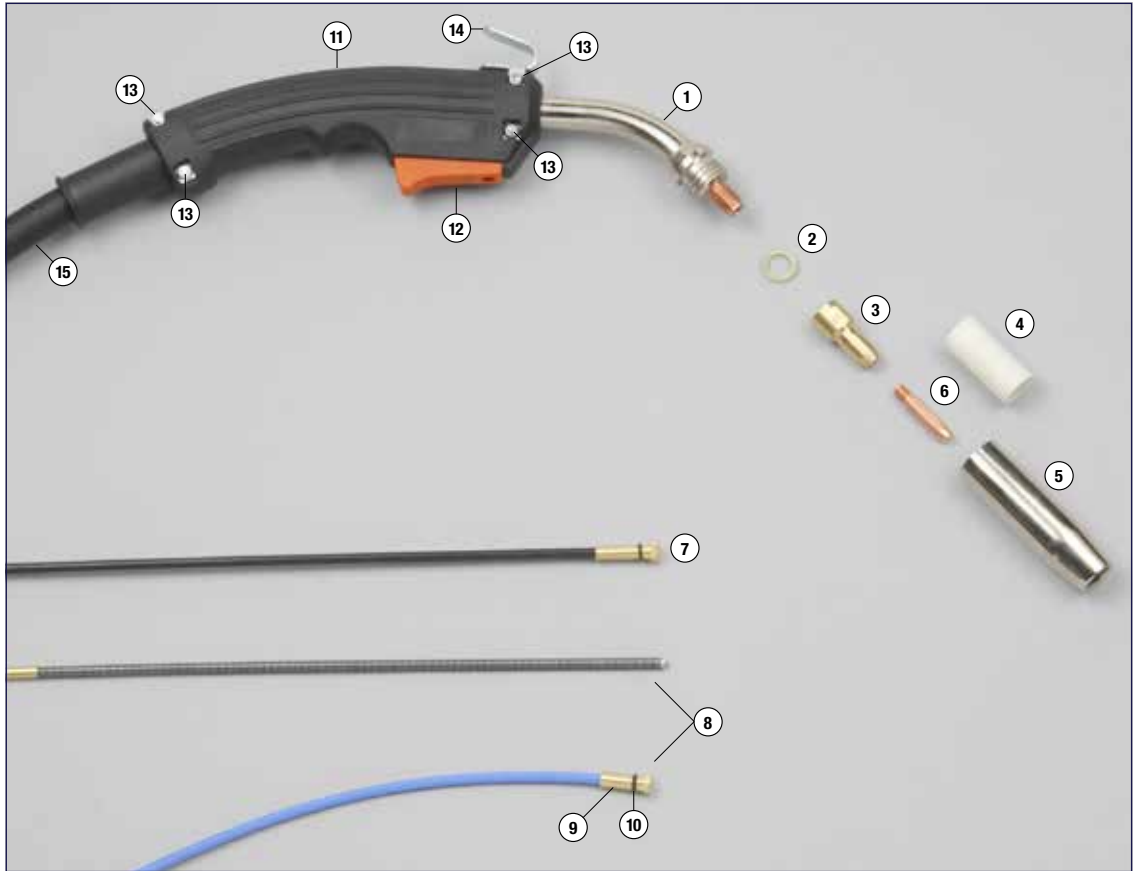

MIG  
Torches

## MX363 Torch Packages

Part No.	Description
<b>1415032</b>	Torch x 3m complete with Euro Fitting
<b>1415033</b>	Torch x 4m complete with Euro Fitting

### Euro Fitting



### MX363 Torch





## Consumables

Item	Part No.	Description	Qty
<b>MAIN CONSUMABLES</b>			
1	1415049	Swan Neck	1
2	1413540	Neck Washer	5
3	1412563	Gas Diffuser	5
4	1408621	Nozzle Insulator	5
	1412490	Nozzle Insulator – Small Bore	5
5	1408605	Conical Nozzle – Short 72mm	5
	1406336	Conical Nozzle – Long 80mm	5
	1414717	Spray Nozzle – 80mm – Small Bore	5
	1412488	Spray Nozzle – 80mm – Large Bore	5
	1408606	Spot Welding Nozzle	5
<b>CONTACT TIPS</b>			
6	1408710	Contact Tip – Hexagonal – 0.8mm Wire	25
	1408712	Contact Tip – Hexagonal – 1.0mm Wire	25
	1408713	Contact Tip – Hexagonal – 1.2mm Wire	25
	1415251	Contact Tip – Hexagonal – 1.4mm Wire	25
	1408714	Contact Tip – Hexagonal – 1.6mm Wire	25
<b>LINERS – STEEL &amp; ALUMINIUM</b>			
7	1412534	Steel 0.8-1.2mm Wire x 3m	1
	1412535	Steel 0.8-1.2mm Wire x 4.5m	1
	1412536	Steel 1.4-2.0mm Wire x 3m	1
	1412537	Steel 1.4-2.0mm Wire x 4.5m	1
8	57200	Aluminium – 1.0-1.2mm Wire x 3m	1
	57202	Aluminium – 1.0-1.2mm Wire x 4m	1
	1414764	Aluminium – 1.0-1.2mm Wire x 4.5m	1
9	57250	Aluminium – 1.2-1.6mm Wire x 3m	1
	57252	Aluminium – 1.2-1.6mm Wire x 4m	1
	1414765	Aluminium – 1.2-1.6mm Wire x 4.5m	1
10	1412540	Liner Nipple – Small	5
11	1412542	Liner Nipple – Large	5
12	1412596	Liner O-Ring – Small	10
13	1412597	Liner O-Ring – Large	10

Item	Part No.	Description	Qty
<b>SECONDARY CONSUMABLES</b>			
14	1415044	Handle Only	1
15	1412567	Switch Assembly with Spring	1
16	1412614	Handle Screw Kit	1
17	1412564	Gun Hook for Handle	1
18	1415042	3m Cable Assembly	1
	1415043	4m Cable Assembly	1
<b>EURO FITTING PARTS</b>			
19	1412605	Support Sleeve	1
20	1412601	Gun Plug Housing	1
21	1408652	Gun Plug Nut	1
22	1412599	Gun Plug Body c/w Spring Pins	1
23	1412595	Liner Retaining Nut	1



**1942**  
MIG Gauntlet  
See page 366

## MX363 Liner Colour Chart

### STEEL LINERS

Colour	Wire Size
Black	0.6mm-0.8mm
Blue	0.8mm-1.2mm
Grey	1.2mm-1.4mm
Red	1.4mm-2.0mm

### ALUMINIUM LINERS

Colour	Wire Size
Black	0.8mm-1.0mm
Blue	1.0mm-1.2mm
Red	1.6mm

Rating 400A @ 60% Duty Cycle CO<sub>2</sub> Gases/Wire Sizes 0.8-1.6mm

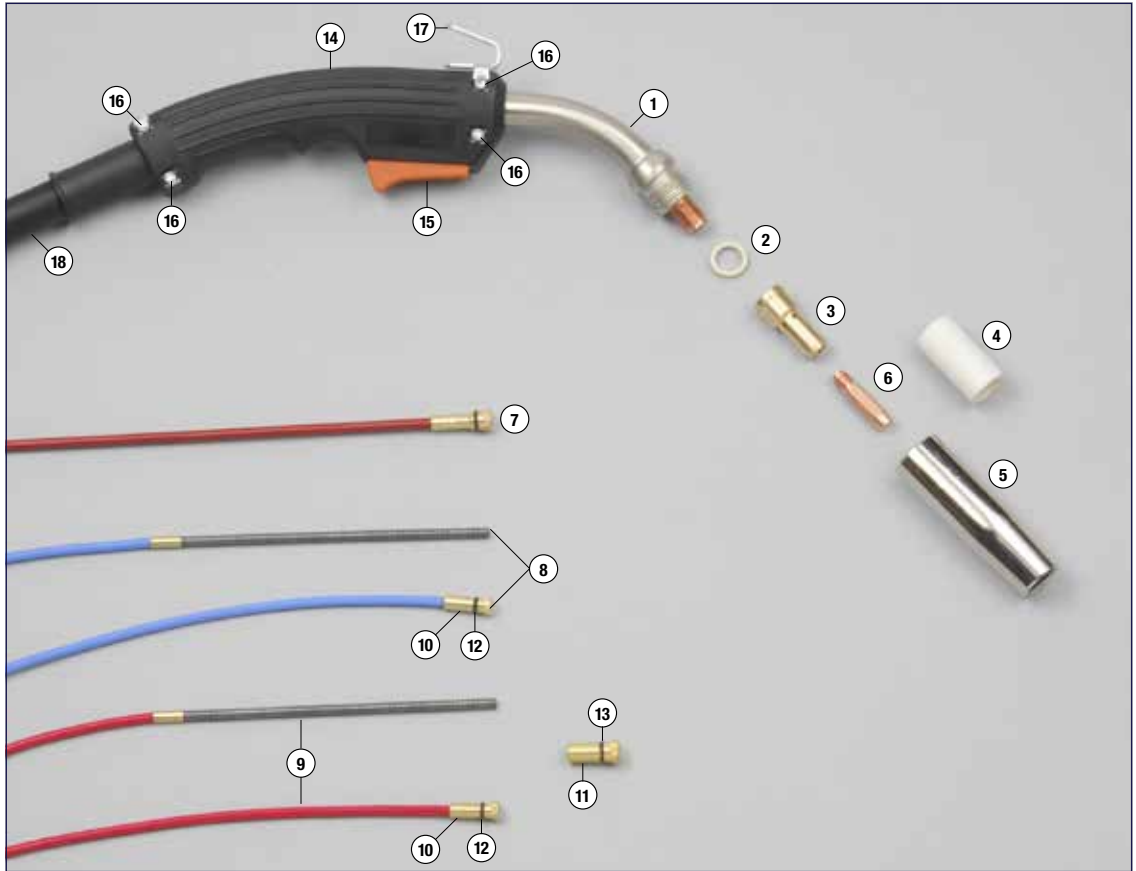

MIG  
Torches

## MX403 Torch Packages

Part No.	Description
<b>1412506</b>	Torch x 3m complete with Euro Fitting
<b>1412507</b>	Torch x 4m complete with Euro Fitting

### Euro Fitting



### MX403 Torch



## Consumables

Item	Part No.	Description	Qty
<b>MAIN CONSUMABLES</b>			
1	1412476	Swan Neck	1
2	1413540	Neck Washer	5
3	1412563	Gas Diffuser	5
4	1408621	Nozzle Insulator	5
	1412490	Nozzle Insulator-Small Bore	5
5	1408605	Conical Nozzle-Short 72mm	5
	1406336	Conical Nozzle-Long 80mm	5
	1414717	Spray Nozzle-80mm-Small Bore	5
	1412488	Spray Nozzle-80mm-Large Bore	5
	1408606	Spot Welding Nozzle	5
<b>CONTACT TIPS</b>			
6	1408710	Contact Tip – Hexagonal – 0.8mm Wire	25
	1408712	Contact Tip – Hexagonal – 1.0mm Wire	25
	1408713	Contact Tip – Hexagonal – 1.2mm Wire	25
	1415251	Contact Tip – Hexagonal – 1.4mm Wire	25
	1408714	Contact Tip – Hexagonal – 1.6mm Wire	25
<b>LINERS – STEEL &amp; ALUMINIUM</b>			
7	1412534	Steel 0.8-1.2mm Wire x 3m	1
	1412535	Steel 0.8-1.2mm Wire x 4.5m	1
	1412536	Steel 1.4-2.0mm Wire x 3m	1
	1412537	Steel 1.4-2.0mm Wire x 4.5m	1
8	57200	Aluminium – 1.0-1.2mm Wire x 3m	1
	57202	Aluminium – 1.0-1.2mm Wire x 4m	1
	1414764	Aluminium – 1.0-1.2mm Wire x 4.5m	1
9	57250	Aluminium – 1.2-1.6mm Wire x 3m	1
	57252	Aluminium – 1.2-1.6mm Wire x 4m	1
	1414765	Aluminium – 1.2-1.6mm Wire x 4.5m	1
10	1412540	Liner Nipple – Small	5
11	1412542	Liner Nipple – Large	5
12	1412596	Liner O-Ring – Small	10
13	1412597	Liner O-Ring – Large	10

Item	Part No.	Description	Qty
<b>SECONDARY CONSUMABLES</b>			
14	1412566	Handle Only	1
15	1412567	Switch Assembly with Spring	1
16	1412614	Handle Screw Kit	1
17	1412564	Gun Hook for Handle	1
18	1412477	3m Cable Assembly	1
	1412478	4m Cable Assembly	1
<b>EURO FITTING PARTS</b>			
19	1412605	Support Sleeve	1
20	1412601	Gun Plug Housing	1
21	1408652	Gun Plug Nut	1
22	1412599	Gun Plug Body c/w Spring Pins	1
23	1412595	Liner Retaining Nut	1



**3049-ST**  
Stealth-Digi-Tech Variable Shade Welding Helmet  
See page 328

## M Series Liner Colour Chart

STEEL LINERS		ALUMINIUM LINERS	
Colour	Wire Size	Colour	Wire Size
Blue	0.6mm-0.9mm	Blue	0.8mm-1.0mm
Red	1.0mm-1.2mm	Red	1.0mm-1.2mm
Yellow	1.6mm	Yellow	1.6mm

## PSF 160

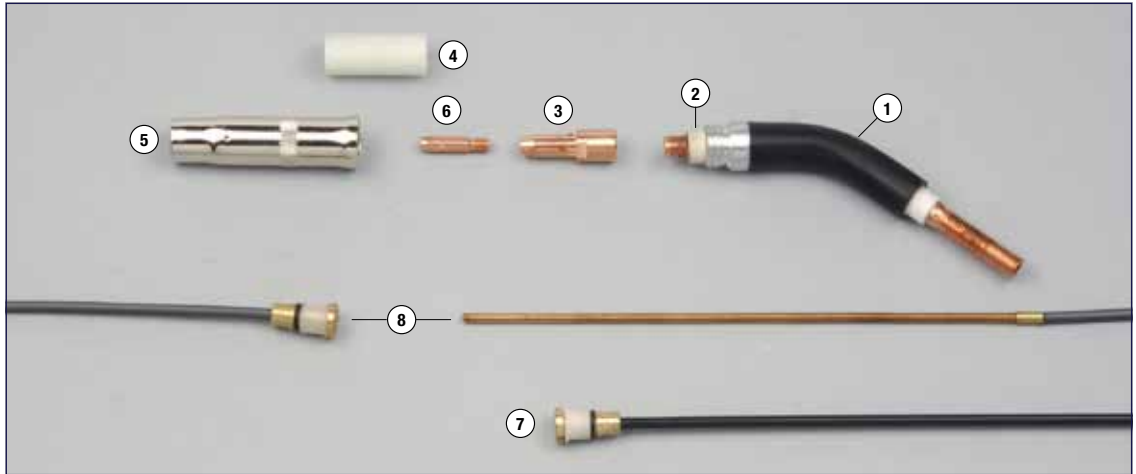

Item	Part No.	Description	Qty
1	336-315-880	Swan Neck	1
2	366-397-001	Diffuser Insulation	5
3	469-249-001	Gas Diffuser	5
4	366-396-001	Nozzle Insulator	5
5	366-854-880	Nozzle c/w Insulator – 13mm Bore	5

Item	Part No.	Description	Qty
6	See Page 147	Contact Tips – Standard	10
	See Page 147	Contact Tips – CuCrZr	10
7	See Page 147	Steel Liners	1
8	See Page 147	Aluminium Liners	1

## PSF 250

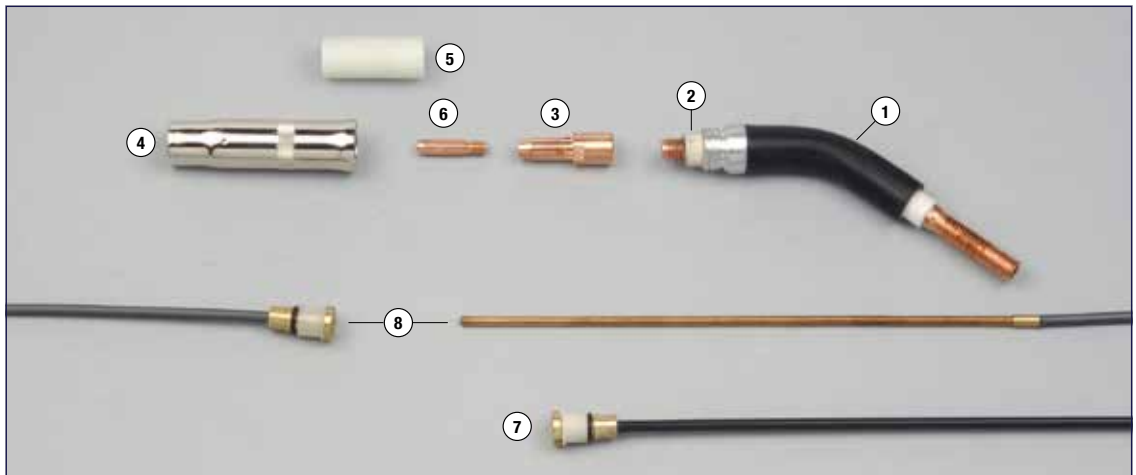

Item	Part No.	Description	Qty
1	366-315-880	Swan Neck	1
2	366-397-001	Diffuser Insulation	5
3	366-314-001	Gas Diffuser	5
4	366-854-881	Nozzle c/w Insulator-14mm Bore	5
	366-946-881	Nozzle c/w Insulator-12mm Bore	5

Item	Part No.	Description	Qty
5	366-396-002	Nozzle Insulator	5
6	See Page 147	Contact Tips-Standard	10
	See Page 147	Contact Tips-CuCrZr	10
7	See Page 147	Steel Liners	1
8	See Page 147	Aluminium Liners	1

## PSF 315, 400 & 500

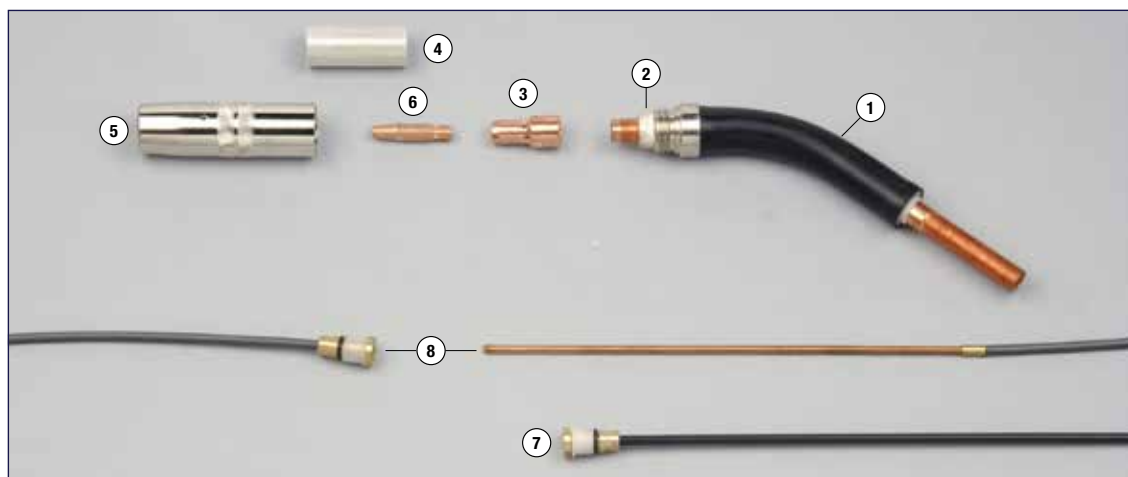

MIG  
Torches

Item	Part No.	Description	Qty
1	366-388-880	Swan Neck – PSF 315	1
	366-389-880	Swan Neck – PSF 400	1
	366-390-880	Swan Neck – PSF 500	1
2	366-397-002	Diffuser Insulation – PSF 315/400	5
	366-397-003	Diffuser Insulation – PSF 500	5
3	366-394-001	Gas Diffuser M6 – PSF 315	5
	366-394-002	Gas Diffuser M8 – PSF 400	5
	366-395-001	Gas Diffuser M6 – PSF 500	5
4	366-396-003	Nozzle Insulator – PSF 315	5
	366-396-004	Nozzle Insulator – PSF 400	5
	366-396-005	Nozzle Insulator – PSF 500	5

Item	Part No.	Description	Qty
5	366-854-882	Nozzle c/w Ins. – PSF 315 – 16mm Bore	5
	366-854-883	Nozzle c/w Ins. – PSF 400 – 17mm Bore	5
	366-854-884	Nozzle c/w Ins. – PSF 500 – 18mm Bore	5
6	See Chart A Below	Contact Tips – Standard	10
	See Chart A Below	Contact Tips – CuCrZr	10
7	See Chart B Below	Steel Liners	1
8	See Chart B Below	Aluminium Liners	1

### CHART A – Contact Tips

Standard M6 x 30mm	CuCrZr M6 x 27mm	Argon gas	CO2 gas	Stamped
153-500-001	468-500-001	-	0.6mm	0.8
	468-500-002	0.6mm	-	0.9
153-500-002	468-500-003	0.6mm	0.8mm	1.0
153-500-003	468-500-004	0.8mm	0.9mm	1.1
153-500-004	468-500-005	0.9mm	1.0mm	1.2
153-500-005	468-500-006	-	1.2mm	1.4
	468-500-007	1.0	1.2	1.5
153-500-006	468-500-008	1.2mm	1.4mm	1.7
153-500-007	468-500-009	-	1.6mm	1.9
	468-500-010	1.6mm	-	2.1
Standard M8 x 40mm	CuCrZr M8 x 37mm	Argon gas	CO2 gas	Stamped
153-502-009	468-502-003	-	0.8mm	1.0
153-502-001	468-502-004	0.8mm	0.9mm	1.2
	468-502-005	0.9mm	1.0mm	1.2
153-502-002	468-502-006	-	1.2mm	1.5
	468-502-007	1.0	1.2	-
153-502-003	468-502-008	1.2mm	1.4mm	1.7

### CHART A – Contact Tips – Continued

Standard M6 x 30mm	CuCrZr M6 x 27mm	Argon gas	CO2 gas	Stamped
153-502-004	468-502-009	-	1.6mm	1.9
153-502-005	468-502-010	1.6mm	-	2.1
153-502-006	468-502-011	2.0mm	2.0mm	2.4
153-502-007	468-502-012	2.4mm	2.4mm	2.8

### CHART B – Liners

Steel	Aluminium	Wire Size	Length
366-549-882	366-550-882	0.6-0.8mm	3m
366-549-883	366-550-883	0.6-0.8mm	4.5m
366-549-884	366-550-884	0.9-1.0mm	3m
366-549-885	366-550-885	0.9-1.0mm	4.5m
366-549-886	366-550-886	1.2mm	3m
366-549-887	366-550-887	1.2mm	4.5m
366-549-888	-	1.4mm	3m
366-549-889	-	1.4mm	4.5m
366-549-890	366-550-890	1.6mm	3m
366-549-891	366-550-891	1.6mm	4.5m

# T400 Tregaskiss Compatible Torch

**AIR COOLED**

Rating 400A @ 60% Duty Cycle CO<sub>2</sub> Gases/Wire Sizes 0.6-1.6mm

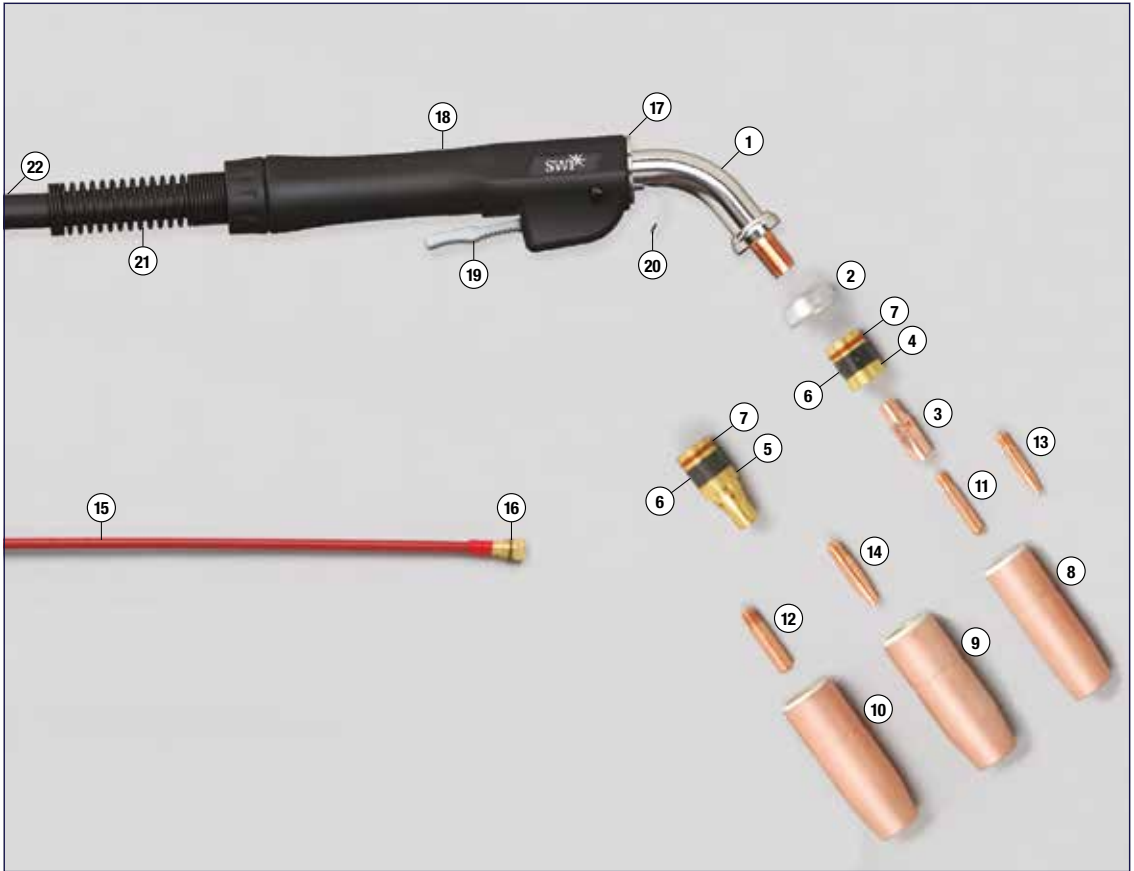

## T400 Torch Packages

Part No.	Description
<b>T4010E</b>	Torch x 10ft complete with Euro Fitting
<b>T4012E</b>	Torch x 12ft complete with Euro Fitting
<b>T4015E</b>	Torch x 15ft complete with Euro Fitting

### Euro Fitting



### T400 Torch



## Consumables

Item	Part No.	Description	Qty
<b>MAIN CONSUMABLES</b>			
1	R405-45	45° Swan Neck	1
	R405-60	60° Swan Neck	1
2	R402-5	Shock Washer	5
3	R404	Gas Diffuser	5
	R404-10	Gas Diffuser c/w Screw – Standard Tips	5
	R404-1	Gas Diffuser – HD Tips	5
	R404-11	Gas Diffuser c/w Screw – HD Tips	5
4	R402-3	Nozzle Retainer	5
5	R404-3	Nozzle Retainer – Heavy Duty	5
	R404-13	Nozzle retainer – HD c/w Screw	5
6	R402-4	Retaining Ring	10
7	R402-6	O-Ring for Nozzle Retainer	10
8	R401-4-38	Nozzle 3/8" – 9mm Bore – Flush Tip	5
	R401-4-50	Nozzle 1/2" – 12mm Bore – 1/8" recess	5
	R401-4-62	Nozzle 5/8" – 16mm Bore – 1/8" recess	5
	R401-4-75	Nozzle 3/4" – 19mm Bore – 1/8" recess	5
9	R401-5-50	HD Nozzle 1/2" – 12mm Bore – 1/4" recess	5
	R401-5-62	HD Nozzle 5/8" – 16mm Bore – 1/4" recess	5
	R401-5-75	HD Nozzle 3/4" – 19mm Bore – 1/4" recess	5
	R401-6-50	HD Nozzle 1/2" – 12mm Bore – 1/8" recess	5
	R401-6-62	HD Nozzle 5/8" – 16mm Bore – 1/8" recess	5
	R401-6-75	HD Nozzle 3/4" – 19mm Bore – 1/8" recess	5
10	R401-7-62	HD Nozzle 5/8" – 16mm Bore – 1/8" recess	5
	R401-7-75	HD Nozzle 3/4" – 19mm Bore – 1/8" recess	5
<b>CONTACT TIPS – STANDARD &amp; HEAVY DUTY</b>			
11	R403-23	Standard Contact Tip – 0.6mm Wire	10
	R403-30	Standard Contact Tip – 0.8mm Wire	10
	R403-35	Standard Contact Tip – 0.9mm Wire	10
	R403-1.0	Standard Contact Tip – 1.0mm Wire	10
	R403-45	Standard Contact Tip – 1.2mm Wire	10
	R403-52	Standard Contact Tip – 1.4mm Wire	10
	R403-116	Standard Contact Tip – 1.6mm Wire	10
12	R403-1-30	Heavy Duty Tip – 0.8mm Wire	10
	R403-1-35	Heavy Duty Tip – 0.9mm Wire	10
	R403-1-1.0	Heavy Duty Tip – 1.0mm Wire	10
	R403-1-45	Heavy Duty Tip – 1.2mm Wire	10
	R403-1-52	Heavy Duty Tip – 1.4mm Wire	10
	R403-1-116	Heavy Duty Tip – 1.6mm Wire	10
	R403-1-364	Heavy Duty Tip – 1.2mm Aluminium Wire	10
	R403-1-18	Heavy Duty Tip – 1.6mm Aluminium Wire	10

Item	Part No.	Description	Qty
<b>TAPERED CONTACT TIPS – STANDARD &amp; HEAVY DUTY</b>			
13	R403-2-23	Standard Tapered Tip – 0.6mm Wire	10
	R403-2-30	Standard Tapered Tip – 0.8mm Wire	10
	R403-2-35	Standard Tapered Tip – 0.9mm Wire	10
	R403-2-1.0	Standard Tapered Tip – 1.0mm Wire	10
	R403-2-45	Standard Tapered Tip – 1.2mm Wire	10
14	R403-3-30	Heavy Duty Tapered Tip – 0.8mm Wire	10
	R403-3-35	Heavy Duty Tapered Tip – 0.9mm Wire	10
	R403-3-1.0	Heavy Duty Tapered Tip – 1.0mm Wire	10
	R403-3-45	Heavy Duty Tapered Tip – 1.2mm Wire	10
	R403-3-52	Heavy Duty Tapered Tip – 1.4mm Wire	10
	R403-3-116	Heavy Duty Tapered Tip – 1.6mm Wire	10
<b>LINERS – STEEL &amp; ALUMINIUM</b>			
15	R415-23-15	Liner Steel – 0.6mm Wire x 15ft	1
	R415-30-15	Liner Steel – 0.8mm Wire x 15ft	1
	R415-35-15	Liner Steel – 0.9-1.0mm Wire x 15ft	1
	R415-116-15	Liner Steel – 1.6mm Wire x 15ft	1
	R415-32-2	Liner Aluminium – 0.8-1.0mm Wire x 15ft	1
	R415-116-2	Liner Aluminium – 1.2-1.6mm Wire x 15ft	1
16	R415-1	Conduit Liner O-Ring	10
<b>SECONDARY CONSUMABLES</b>			
17	R407	Torch Body Assembly	1
18	T3001	Handle	1
19	R411-1	Switch	1
20	T3002	Hanger Hook	1
21	T3003	Cable Support – Handle	1
22	R413-10	10ft Cable Assembly	1
	R413-12	12ft Cable Assembly	1
	R413-15	15ft Cable Assembly	1
<b>EURO FITTING PARTS</b>			
23	R425-10K	Euro Gun Plug Body	1
24	M1518-5	O-Ring for Gun Plug Body	10
25	M1518-3	Gun Plug Nut	1
26	T2004	Gun Plug Housing	1
	M1518-2	Screw for Housing (not illustrated)	5
27	T2005	Cable Support – Euro Fitting	1



# T500 Tregaskiss Compatible Torch

**AIR COOLED**

Rating 500A @ 60% Duty Cycle CO<sub>2</sub> Gases/Wire Sizes 0.6-2.4mm

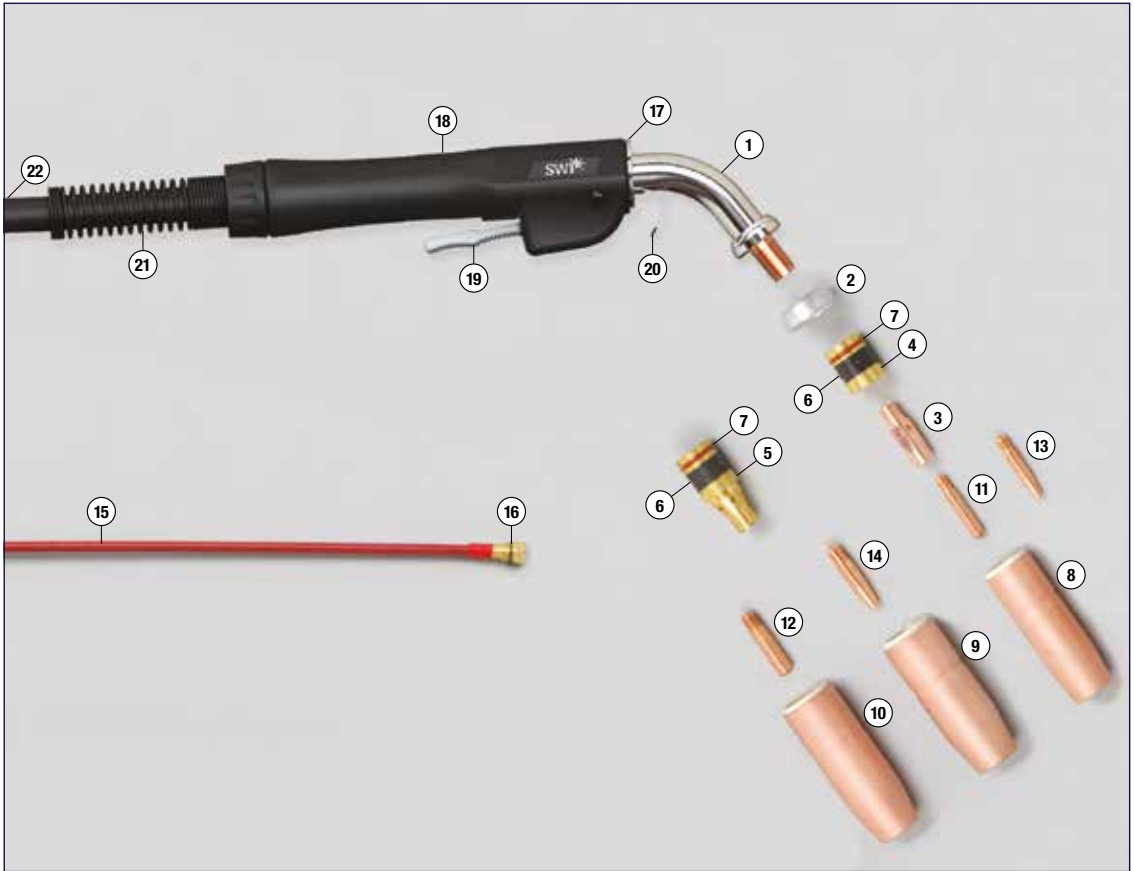

MIG  
Torches

## T500 Torch Packages

Part No.	Description
<b>T5010E</b>	Torch x 10ft complete with Euro Fitting
<b>T5012E</b>	Torch x 12ft complete with Euro Fitting
<b>T5015E</b>	Torch x 15ft complete with Euro Fitting

### Euro Fitting



### T500 Torch



## Consumables

Item	Part No.	Description	Qty	
<b>MAIN CONSUMABLES</b>				
<b>1</b>	R505-45	45° Swan Neck	1	
	R505-60	60° Swan Neck	1	
<b>2</b>	R402-5	Shock Washer	5	
<b>3</b>	R404	Gas Diffuser	5	
	R404-10	Gas Diffuser c/w Screw – Standard Tips	5	
	R404-1	Gas Diffuser – HD Tips	5	
<b>4</b>	R404-11	Gas Diffuser c/w Screw – HD Tips	5	
	R402-3	Nozzle Retainer	5	
<b>5</b>	R404-3	Nozzle Retainer – Heavy Duty	5	
	R404-13	Nozzle retainer – HD c/w Screw	5	
<b>6</b>	R402-4	Retaining Ring	10	
<b>7</b>	R402-6	O-Ring for Nozzle Retainer	10	
<b>8</b>	R401-4-38	Nozzle 3/8" – 9mm Bore – Flush Tip	5	
	R401-4-50	Nozzle 1/2" – 12mm Bore – 1/8" recess	5	
	R401-4-62	Nozzle 5/8" – 16mm Bore – 1/8" recess	5	
	R401-4-75	Nozzle 3/4" – 19mm Bore – 1/8" recess	5	
	R401-5-50	HD Nozzle 1/2" – 12mm Bore – 1/4" recess	5	
<b>9</b>	R401-5-62	HD Nozzle 5/8" – 16mm Bore – 1/4" recess	5	
	R401-5-75	HD Nozzle 3/4" – 19mm Bore – 1/4" recess	5	
	R401-6-50	HD Nozzle 1/2" – 12mm Bore – 1/8" recess	5	
	R401-6-62	HD Nozzle 5/8" – 16mm Bore – 1/8" recess	5	
	R401-6-75	HD Nozzle 3/4" – 19mm Bore – 1/8" recess	5	
<b>10</b>	R401-7-62	HD Nozzle 5/8" – 16mm Bore – 1/8" recess	5	
	R401-7-75	HD Nozzle 3/4" – 19mm Bore – 1/8" recess	5	
<b>CONTACT TIPS – STANDARD &amp; HEAVY DUTY</b>				
<b>11</b>	R403-23	Standard Contact Tip – 0.6mm Wire	10	
	R403-30	Standard Contact Tip – 0.8mm Wire	10	
	R403-35	Standard Contact Tip – 0.9mm Wire	10	
	R403-1.0	Standard Contact Tip – 1.0mm Wire	10	
	R403-45	Standard Contact Tip – 1.2mm Wire	10	
	R403-52	Standard Contact Tip – 1.4mm Wire	10	
	R403-116	Standard Contact Tip – 1.6mm Wire	10	
	<b>12</b>	R403-1-30	Heavy Duty Tip – 0.8mm Wire	10
		R403-1-35	Heavy Duty Tip – 0.9mm Wire	10
		R403-1-1.0	Heavy Duty Tip – 1.0mm Wire	10
R403-1-45		Heavy Duty Tip – 1.2mm Wire	10	
R403-1-52		Heavy Duty Tip – 1.4mm Wire	10	
R403-1-116		Heavy Duty Tip – 1.6mm Wire	10	
R403-1-564		Heavy Duty Tip – 2.0mm Wire	10	
R403-1-332		Heavy Duty Tip – 2.4mm Wire	10	
R403-1-364	Heavy Duty Tip – 1.2mm Aluminium Wire	10		
R403-1-18	Heavy Duty Tip – 1.6mm Aluminium Wire	10		

Item	Part No.	Description	Qty
<b>TAPERED CONTACT TIPS – STANDARD &amp; HEAVY DUTY</b>			
<b>13</b>	R403-2-23	Standard Tapered Tip – 0.6mm Wire	10
	R403-2-30	Standard Tapered Tip – 0.8mm Wire	10
	R403-2-35	Standard Tapered Tip – 0.9mm Wire	10
	R403-2-1.0	Standard Tapered Tip – 1.0mm Wire	10
	R403-2-45	Standard Tapered Tip – 1.2mm Wire	10
<b>14</b>	R403-3-30	Heavy Duty Tapered Tip – 0.8mm Wire	10
	R403-3-35	Heavy Duty Tapered Tip – 0.9mm Wire	10
	R403-3-1.0	Heavy Duty Tapered Tip – 1.0mm Wire	10
	R403-3-45	Heavy Duty Tapered Tip – 1.2mm Wire	10
	R403-3-52	Heavy Duty Tapered Tip – 1.4mm Wire	10
	R403-3-116	Heavy Duty Tapered Tip – 1.6mm Wire	10
	R403-3-116	Heavy Duty Tapered Tip – 1.6mm Wire	10
<b>LINERS – STEEL &amp; ALUMINIUM</b>			
<b>15</b>	R415-23-15	Liner Steel 0.6mm Wire x 15ft	1
	R415-30-15	Liner Steel 0.8mm Wire x 15ft	1
	R415-35-15	Liner Steel 0.9-1.0mm Wire x 15ft	1
	R415-116-15	Liner Steel 1.6mm Wire x 15ft	1
	R415-564-15	Liner Steel 2.0mm Wire x 15ft	1
	R415-332-15	Liner Steel 2.4mm Wire x 15ft	1
	R415-32-2	Liner Aluminium 0.8-1.0mm Wire x 15ft	1
	R415-116-2	Liner Aluminium 1.2-1.6mm Wire x 15ft	1
<b>16</b>	R415-1	Conduit Liner O-Ring	10
<b>SECONDARY CONSUMABLES</b>			
<b>17</b>	R407	Torch Body Assembly	1
<b>18</b>	T3001	Handle	1
<b>19</b>	R411-1	Switch	1
<b>20</b>	T3002	Hanger Hook	1
<b>21</b>	T5003	Cable Support – Handle	1
<b>22</b>	R513-10	10ft Cable Assembly	1
	R513-12	12ft Cable Assembly	1
	R513-15	15ft Cable Assembly	1
<b>EURO FITTING PARTS</b>			
<b>23</b>	R425-10K	Euro Gun Plug Body	1
<b>24</b>	M1518-5	O-Ring for Gun Plug Body	10
<b>25</b>	M1518-3	Gun Plug Nut	10
<b>26</b>	T2004	Gun Plug Housing	1
	M1518-2	Screw for Housing (not illustrated)	5
<b>27</b>	T2005	Cable Support – Euro Fitting	1

## AL3000 & AW4000

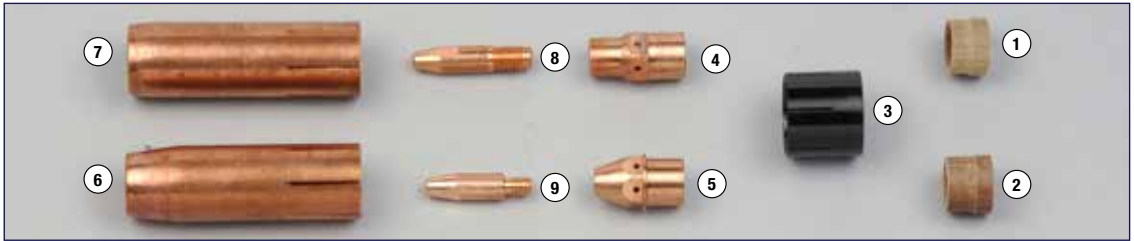

Item	Part No.	Description	Qty
1	42.0100.1010	Insulator (AW4000)	5
2	42.0100.1014	Insulator (AL3000)	5
3	42.0001.2930	Nozzle Holder (AL3000)	1
4	42.0001.5084	Tip Adaptor M8 (AL3000)	5
5	42.0001.5251	Tip Adaptor M6 (AL3000)	5
6	42.0001.5096	Nozzle c/w Insulator – 13mm Bore	5
7	42.0001.5269	Nozzle c/w Insulator – 15.2mm Bore	5
	42.0001.5151	Nozzle c/w Insulator – 11mm Bore	5

Item	Part No.	Description	Qty
8	42.0001.2911	Tip 0.8mm – M8 x 35mm CuCrZr	10
	42.0001.2912	Tip 1.0mm – M8 x 35mm CuCrZr	10
	42.0001.2913	Tip 1.2mm – M8 x 35mm CuCrZr	10
9	42.0001.0052	Contact Tip 0.6mm – M6 x 33mm	10
	42.0001.0053	Contact Tip 0.8mm – M6 x 33mm	10
	42.0001.0054	Contact Tip 1.0mm – M6 x 33mm	10
	42.0001.0055	Contact Tip 1.2mm – M6 x 33mm	10

## AL4000 & AW5000



Item	Part No.	Description	Qty
1	42.0100.1018	Insulator (AL4000)	5
2	42.0100.1016	Insulator (AW5000)	5
3	42.0001.2970	Nozzle Holder	1
4	42.0001.5122	Tip Adaptor M10	5
5	42.0100.1007	Gas Diffuser	5
6	42.0001.5128	Nozzle – 17mm Bore	5
7	42.0001.5129	Nozzle – 15mm Bore	5

Item	Part No.	Description	Qty
8	42.0001.1576	Tip 0.8mm – M10 x 40mm – CuCrZr	10
	42.0001.1577	Tip 1.0mm – M10 x 40mm – CuCrZr	10
	42.0001.1578	Tip 1.2mm – M10 x 40mm – CuCrZr	10
	42.0001.1930	Tip 1.4mm – M10 x 40mm – CuCrZr	10
	42.0001.1579	Tip 1.6mm – M10 x 40mm – CuCrZr	10
	42.0001.2314	Tip 2.0mm – M10 x 40mm – CuCrZr	10

## FRONIUS Combi Liners



Item	Part No.	Description	Qty
<b>EURO FITTING</b>			
1	44.0350.2603	Combi Liner 1.2mm x 3.5m	1
	44.0350.2604	Combi Liner 1.2mm x 4.5m	1
	44.0350.2607	Combi Liner 1.6mm x 3.5m	1
	44.0350.2608	Combi Liner 1.6mm x 4.5m	1

Item	Part No.	Description	Qty
<b>FRONIUS FITTING</b>			
2	44.0350.2307	Combi Liner 0.6 – 0.8mm x 3.5m	1
	44.0350.2308	Combi Liner 0.6-0.8mm x 4.5m	1
	44.0350.1609	Combi Liner 0.6-1.0mm x 3.5m	1
	44.0350.1650	Combi Liner 0.6-1.0mm x 4.5m	1
	44.0350.1606	Combi Liner 1.2mm x 3.5m	1
	44.0350.1651	Combi Liner 1.2mm x 4.5m	1
	44.0350.1612	Combi Liner 1.6mm x 3.5m	1
	44.0350.1665	Combi Liner 1.6mm x 4.5m	1

MIG Torches

## MT/PMT25

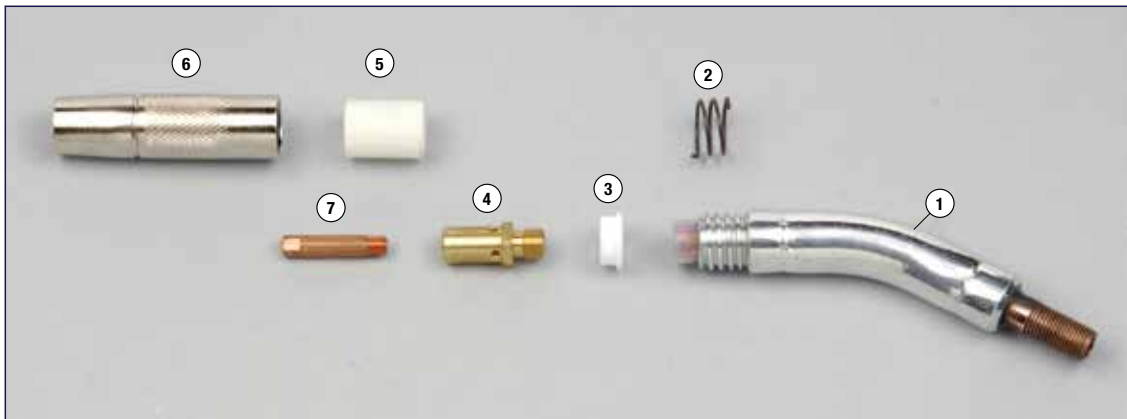

Item	Part No.	Description	Qty	Item	Part No.	Description	Qty
1	4153040S	Swan Neck – Spiral Spring	1	6	9580101	Conical Nozzle – 13.5mm Bore	5
2	4275240	Shroud Spring	5	7	9876634	Contact Tip 0.6mm – M6 x 29mm	25
3	9591079	Insulation Ring – Swan Neck	5		9876635	Contact Tip 0.8mm – M6 x 29mm	25
4	9580173	Tip Adaptor M6	5		9876636	Contact Tip 1.0mm – M6 x 29mm	25
5	9591010	Nozzle Insulator	5		9876637	Contact Tip 1.2mm – M6 x 29mm	25



**WFE-003**  
Stealth-Digi-Fume  
See page 94

## MT38

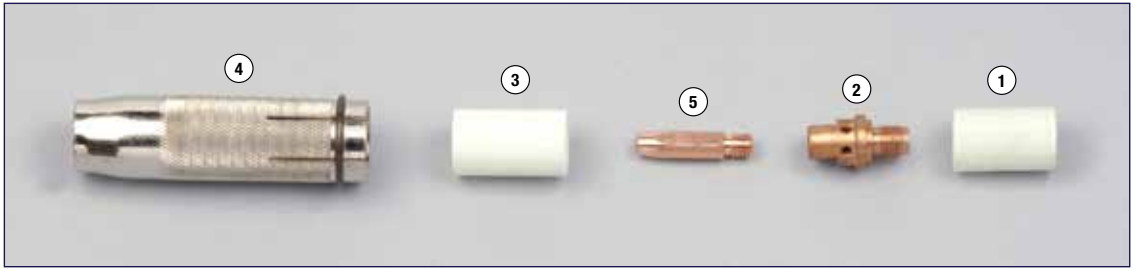

Item	Part No.	Description	Qty
1	4254670	Insulator	5
2	4255421	Tip Adaptor M8	5
3	4248710	Nozzle Insulator	5
4	4255530	Conical Nozzle – 16.5mm Bore	5

Item	Part No.	Description	Qty
5	9580122	Contact Tip 0.8mm – M8 x 35mm	25
	9580123	Contact Tip 1.0mm – M8 x 35mm	25
	9580124	Contact Tip 1.2mm – M8 x 35mm	25
	9580125	Contact Tip 1.4mm – M8 x 35mm	25
	9580126	Contact Tip 1.6mm – M8 x 35mm	25

## PMT27, PMT32 & PMT30W

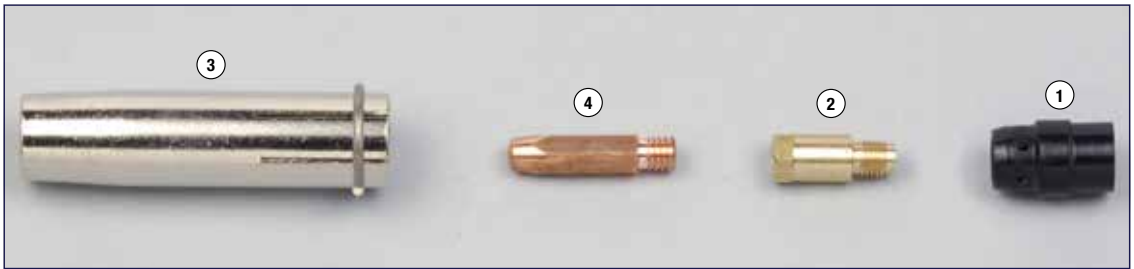

Item	Part No.	Description	Qty
1	4298290	Diffuser	5
2	4295740	Tip Adaptor M8	5
3	4295760	Conical Nozzle – 14mm Bore	5

Item	Part No.	Description	Qty
4	9580122	Contact Tip 0.8mm – M8 x 35mm	25
	9580123	Contact Tip 1.0mm – M8 x 35mm	25
	9580124	Contact Tip 1.2mm – M8 x 35mm	25
	9580125	Contact Tip 1.4mm – M8 x 35mm	25
	9580126	Contact Tip 1.6mm – M8 x 35mm	25

## PMT30, PMT40 & PMT50

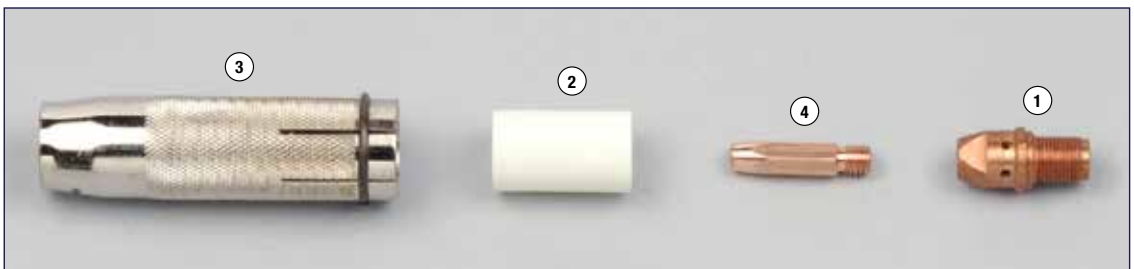

Item	Part No.	Description	Qty
1	4269640	Tip Adaptor M8 – Long	5
2	4248710	Nozzle Insulator	5
3	4255530	Conical Nozzle – 16.5mm Bore	5

Item	Part No.	Description	Qty
4	9580122	Contact Tip 0.8mm – M8 x 35mm	25
	9580123	Contact Tip 1.0mm – M8 x 35mm	25
	9580124	Contact Tip 1.2mm – M8 x 35mm	25
	9580125	Contact Tip 1.4mm – M8 x 35mm	25
	9580126	Contact Tip 1.6mm – M8 x 35mm	25

## PMT42W

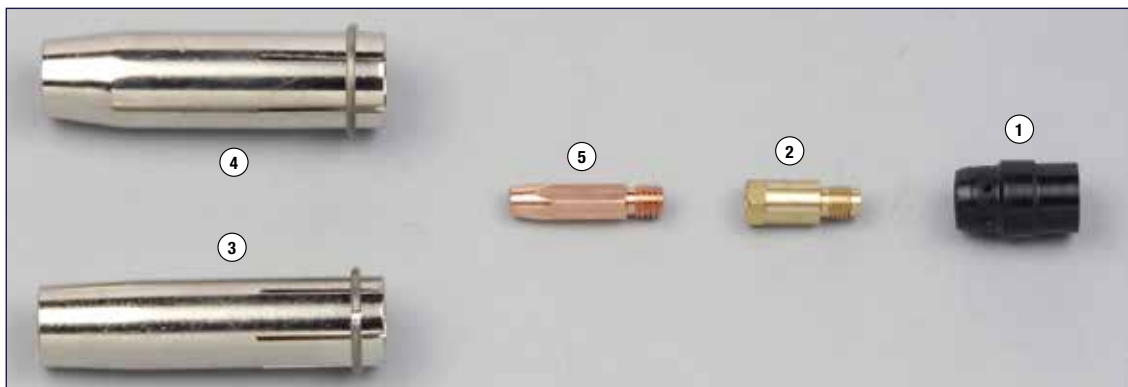

Item	Part No.	Description	Qty
1	4298290	Diffuser	5
2	4295740	Tip Adaptor M8	5
3	4300260	Conical Nozzle – 16mm Bore	5
4	4300260C	Tapered Nozzle – 13mm Bore	5

Item	Part No.	Description	Qty
5	9580122	Contact Tip 0.8mm - M8 x 35mm	25
	9580123	Contact Tip 1.0mm - M8 x 35mm	25
	9580124	Contact Tip 1.2mm - M8 x 35mm	25
	9580125	Contact Tip 1.4mm - M8 x 35mm	25
	9580126	Contact Tip 1.6mm - M8 x 35mm	25

## PMT52W



Item	Part No.	Description	Qty
1	4298300	Diffuser	5
2	4300390	Tip Adaptor M8	5
3	4300380	Conical Nozzle – 18mm Bore	5
	4300380C	Conical Nozzle – 14mm Bore	5
	4300380L	Conical Nozzle – 18mm Bore – Long	5

Item	Part No.	Description	Qty
4	9580122	Contact Tip 0.8mm – M8 x 35mm	25
	9580123	Contact Tip 1.0mm – M8 x 35mm	25
	9580124	Contact Tip 1.2mm – M8 x 35mm	25
	9580125	Contact Tip 1.4mm – M8 x 35mm	25
	9580126	Contact Tip 1.6mm – M8 x 35mm	25

## KEMPPi Liners



Item	Part No.	Description	Qty
1	4188571	0.6-0.8mm Wire x 3m – White	1
2	4188581	0.9-1.2mm Wire x 3m – Red	1
	4188582	0.9-1.2mm Wire x 4.5m – Red	1
3	4188591	1.4-1.6mm Wire x 3m – Yellow	1
	4188592	1.4-1.6mm Wire x 4.5m – Yellow	1

## Other **SWP** Products

**1**

### **CONSUMABLES**

Section for Super 6 and Superon welding and brazing, covers products for joining large fabrications and DIY use.

**2**

### **MACHINES**

As well as the impressive range of Stealth machines, SWP also offer Redline Automotive and Proline Professional Mig machines.

**3**

### **FUME EXTRACTION**

For workplace protection against welding fumes within the Stealth branded range of quality products supplied by SWP.

**4**

### **WELDER GENERATORS**

Petrol and diesel, portable and static – all with a two-year warranty. Designed and manufactured by Genset in Italy.

**6**

### **TIG WELDING**

A wide range of Compatible Torches, Consumables, Cables, Handles, Connectors, Adaptors and Fittings.

**7**

### **PLASMA CUTTING**

Offering Compatible Torches, Consumables, Central Connectors, Circle Cutting Kits and Attachments.

**8**

### **ARC WELDING ACCESSORIES**

Electrode Holders, Clamps, Connectors and other accessories – plus Ovens and Quivers.

**9**

### **ABRASIVES**

Supplied by 3M and WinnerFlex, combining good quality with great value and oSa® approval.

**10**

### **GAS WELDING & CUTTING**

For all you need from Regulators, Nozzles, Hoses and Fittings to Cutting Equipment.

**11**

### **SAFETY & PPE**

Welding Helmets and PAPR plus a comprehensive range of quality PPE, Clothing and Workplace Protection.

**12**

### **SUMNER TOOLS**

For Jacks, Heads, Tools and Clamps to cover most applications from the workshop to oil fields.

**13**

### **STRONGHAND TOOLS**

Including Tables, Pliers, Clamps, Magnetic Fit-Up Tools, plus Markal Industrial Markers and Tempil Temperature Indicators.

**14**

### **AIR EQUIPMENT**

Compressors, Spray Kits & Accessories and Mighty 7 Heavy Duty Air Tools.

**15**

### **AIR LINE ACCESSORIES**

All you need to connect to your air equipment including Couplings, Blow Guns and Hoses.

**16**

### **CORDLESS TOOLS**

This range is particularly suited to the auto workshop. These heavy duty tools include impact drivers, wrenches and grinders etc, plus a range of cordless kits.