

RESTAURANT RANGES

VULCAN**60" ELECTRIC RESTAURANT RANGE
10 FRENCH PLATES**

Model EV60SS-10FP208
shown with adjustable legs

**SPECIFICATIONS**

60" wide electric restaurant range, Vulcan Model No. EV60SS-10FP208. Fully MIG welded aluminized steel frame for added durability. Stainless steel front, sides, back riser, plate shelf and 6" adjustable legs. Ten 9½" round French plates, 2 KW input per plate. Full width pull out stainless steel crumb tray located beneath the cooking top. Comes with one standard oversized oven and one standard oven. Oversized oven interior measures 26½"w x 26¾"d x 14"h. Standard oven interior measures 20"w x 26½"d x 14"h. Each oven comes with one oven rack and three rack positions. Oven doors are heavy duty with integrated door hinge / spring mechanisms, requiring no adjustments. 5 KW input. Top browning heat control. Thermostat adjusts from 200°F to 500°F. Oven controls are protected from heat in an insulated side compartment. Requires 208 or 240 volt, 1 or 3 phase power supply. All ranges are shipped in 3 phase and are field convertible to single phase.

Exterior Dimensions:

34¾"d x 60"w x 58"h on 6" adjustable legs

- EV60SS-10FP208** 10 French Plates / 1 Standard Oversized Oven / 1 Standard Oven / 208V
- EV60SS-10FP240** 10 French Plates / 1 Standard Oversized Oven / 1 Standard Oven / 240V
- EV60SS-10FP480** 10 French Plates / 1 Standard Oversized Oven / 1 Standard Oven / 480V

STANDARD FEATURES

- Fully MIG welded aluminized steel frame for added durability
- Stainless steel front, sides, back riser, shelf and legs
- Ten 9½" round, 2 KW French plates with infinite heat control switches
- Full width pull out stainless steel crumb tray
- 5 KW oven with top browning control
- One standard oversized oven, interior measures 26½"w x 26¾"d x 14"h and one standard oven, interior measures 20"w x 26½"d x 14"h
- Thermostat adjusts from 200°F to 500°F
- Cool to the touch control knobs and oven handles
- Each oven has one oven rack and three rack positions
- 18" x 26" sheet pans fit side to side and front to back in standard oversized oven. 18" x 26" sheet pans fit front to back in standard oven.
- Requires 208 volt or 240 volt, 1 or 3 phase power supply. (Ranges shipped in 3 phase and are field convertible to single phase)
- One year limited parts and labor warranty

ACCESSORIES (Packaged & Sold Separately)

- Extra oven rack with two rack guides
- Set of four casters (two locking)
- 10" stainless steel stub back
- ESB36 salamander broiler
- Reinforced high shelf for ESB36 salamander broiler
- Towel bar
- Cutting board
- Condiment rail
- Fryer shield

VULCAN

a division of ITW Food Equipment Group LLC

P.O. Box 696 ■ Louisville, KY 40201 ■ Toll-free: 1-800-814-2028 ■ Local: 502-778-2791 ■ Quote & Order Fax: 1-800-444-0602



60" ELECTRIC RESTAURANT RANGE
10 FRENCH PLATES

INSTALLATION INSTRUCTIONS

Clearances from Combustible Construction

	Rear	Sides
Range Only	0"	0"
Range and ESB Salamander Broiler	2"	8"

Clearance Note: Electric Ranges are 0 inches, sides and 0 inches rear from combustible and non-combustible constructions *except when hot top sections are incorporated.*

Ranges incorporating hot top sections are 0 inches sides and 0 inches rear to non-combustibles and *6 inches sides and 6 inches rear to combustible constructions.*

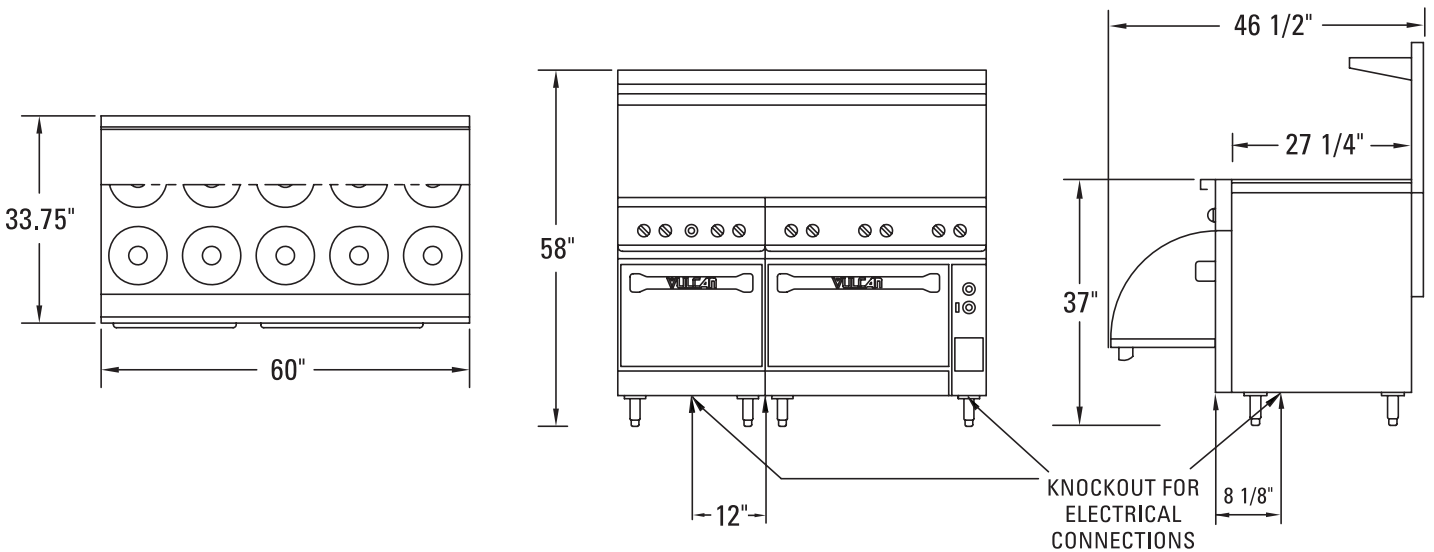

The EV 60 ranges require two separate electrical hook-ups.

AVAILABLE VOLTAGES - 208 OR 240 VOLT - 1 OR 3 PHASE																								
3 PHASE LOADING									NOMINAL AMPS PER LINE WIRE															
MODEL NUMBER	kW		kW PER PHASE						3 PHASE LT						3 PHASE RT						1 PHASE			
			LT 3 PH			RT 3 PH			208 VOLT			240 VOLT			208 VOLT			240 VOLT			LT		RT	
	LT	RT	X-Y	Y-Z	X-Z	X-Y	Y-Z	X-Z	X	Y	Z	X	Y	Z	X	Y	Z	X	Y	Z	208	240	208	240
EV60SS-10FP208	13.0	17.0	5.0	4.0	4.0	4.0	8.0	5.0	37.5	37.5	33.3	--	--	--	37.5	50.0	54.1	--	--	--	62.5	--	81.7	--
EV60SS-10FP240	13.0	17.0	5.0	4.0	4.0	4.0	8.0	5.0	--	--	--	32.5	32.5	28.9	--	--	--	32.5	43.3	46.9	--	54.2	--	70.8

Note: To calculate 480 volt amps, take 240 volt amp ratings shown and divide by two.

This appliance is manufactured for commercial use only and is not intended for home use.



a division of ITW Food Equipment Group LLC

P.O. Box 696 ■ Louisville, KY 40201 ■ Toll-free: 1-800-814-2028 ■ Local: 502-778-2791 ■ Quote & Order Fax: 1-800-444-0602

NOTE: In line with its policy to continually improve its products, Vulcan reserves the right to change materials and specifications without notice.