

# ninebot®

Personal Transportation Robot

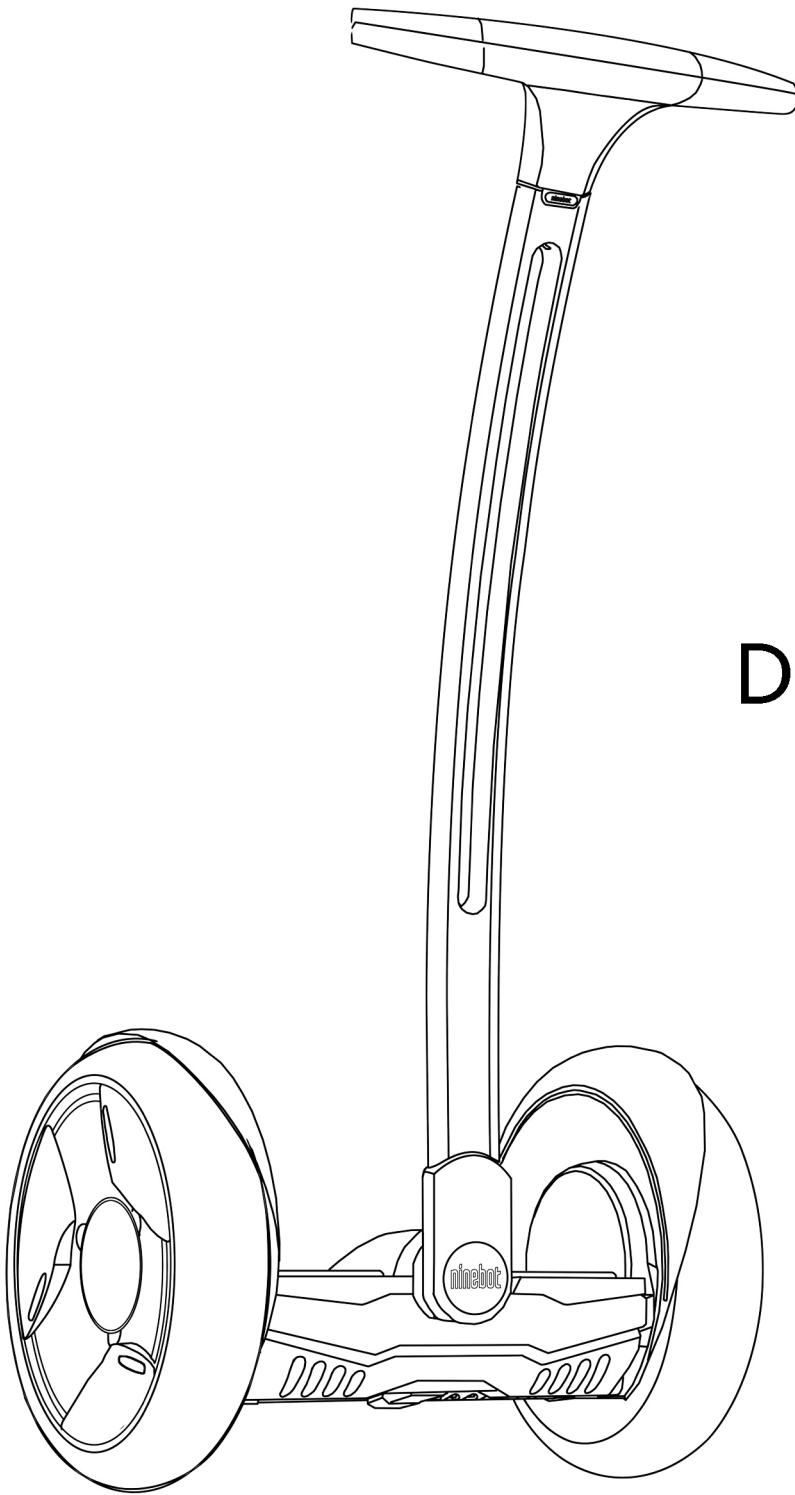

快速使用指南  
Quick Start  
Inicio rápido  
بداية سريعة  
быстрый старт  
Départ rapide  
Schnellstart  
빠른 시작  
クイックスタート



**ninebot®**  
Personal Transportation Robot

Installation  
 Instalación  
 Instalação  
 組裝 تركيب  
 インストール  
 설치

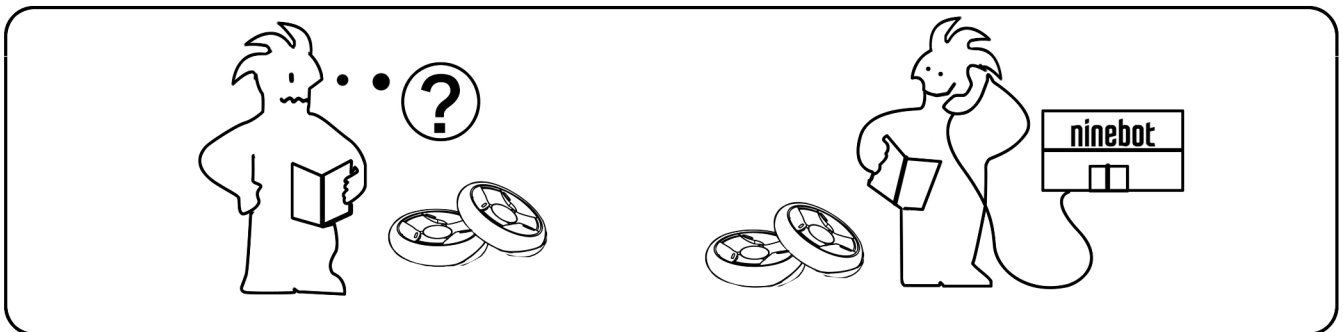
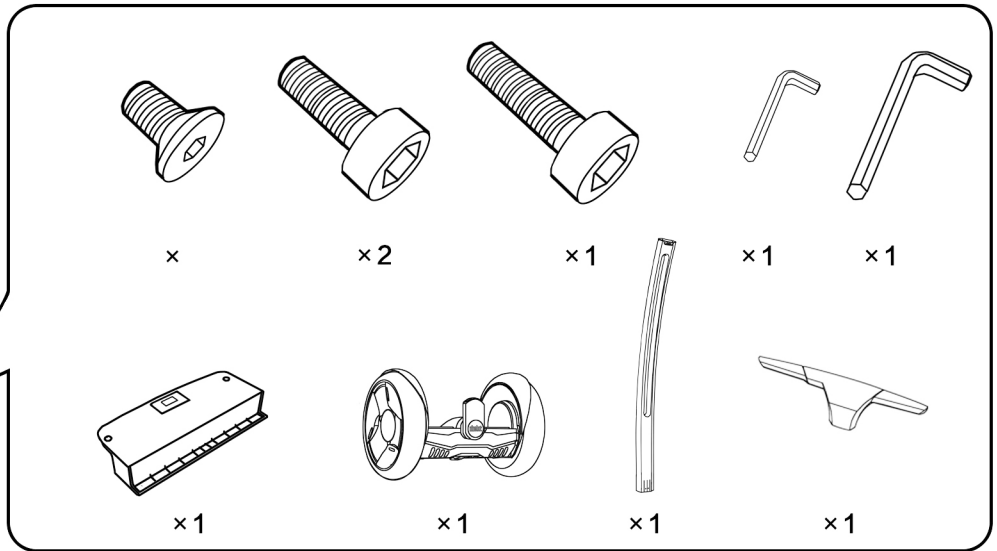

1

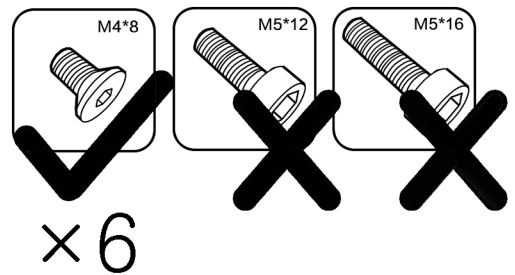
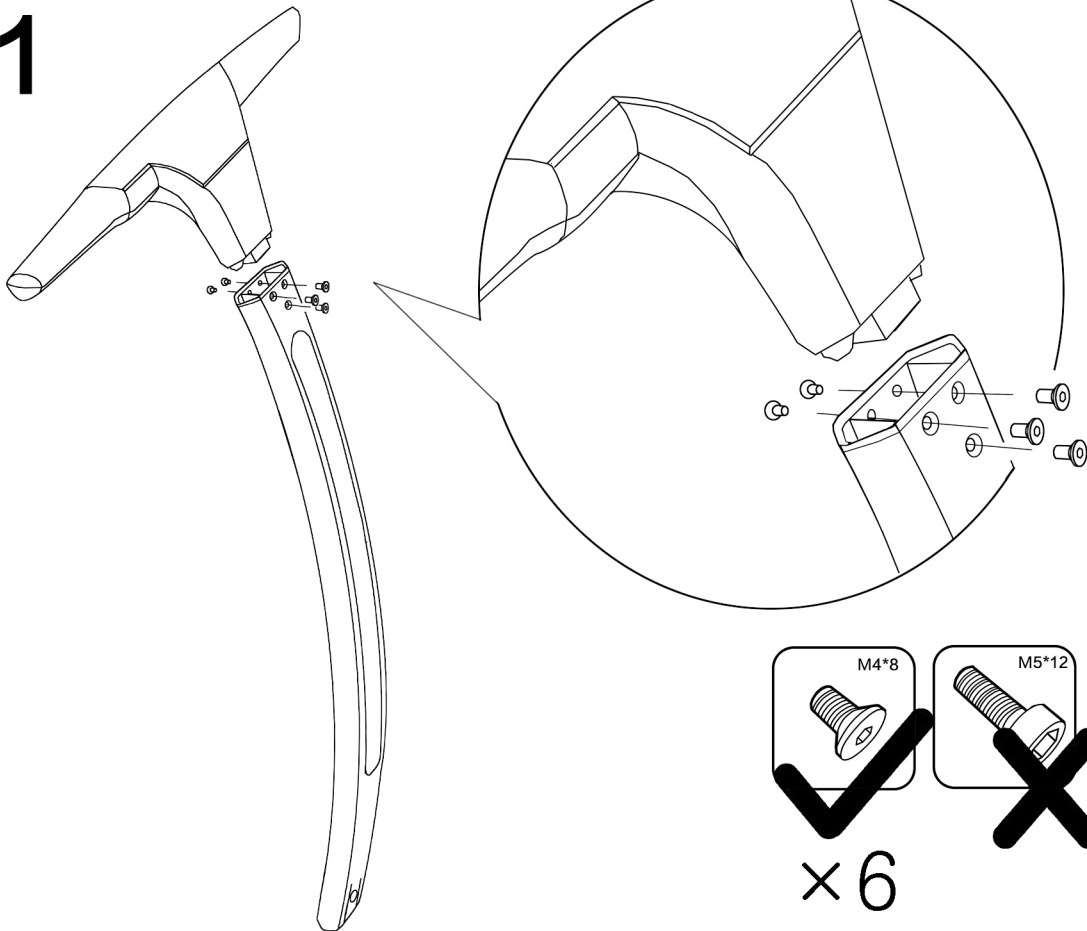

# 2

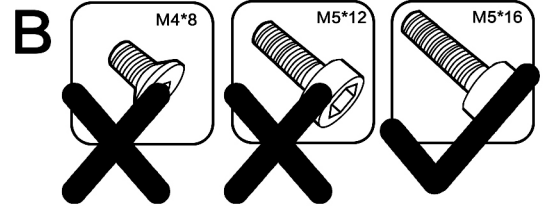
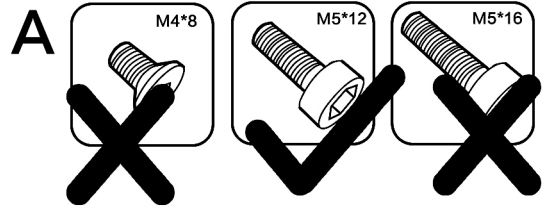
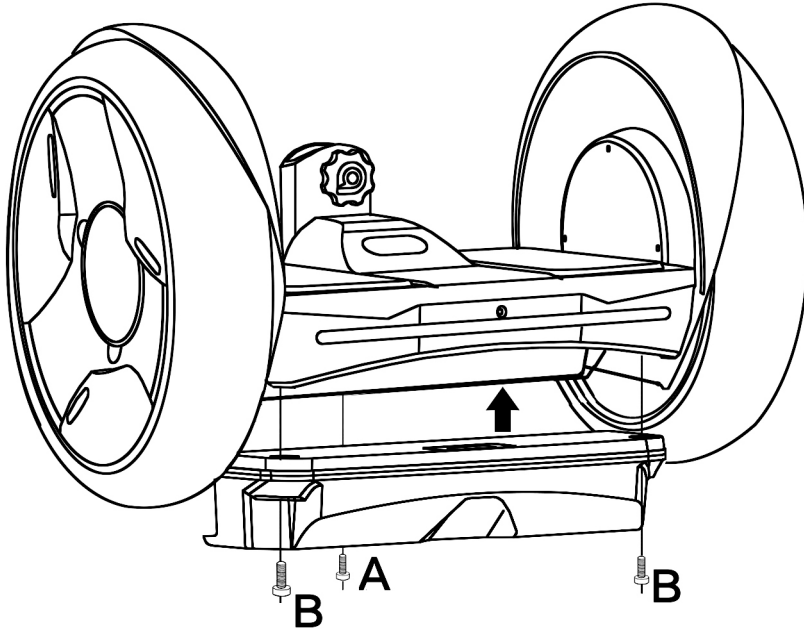

# 3

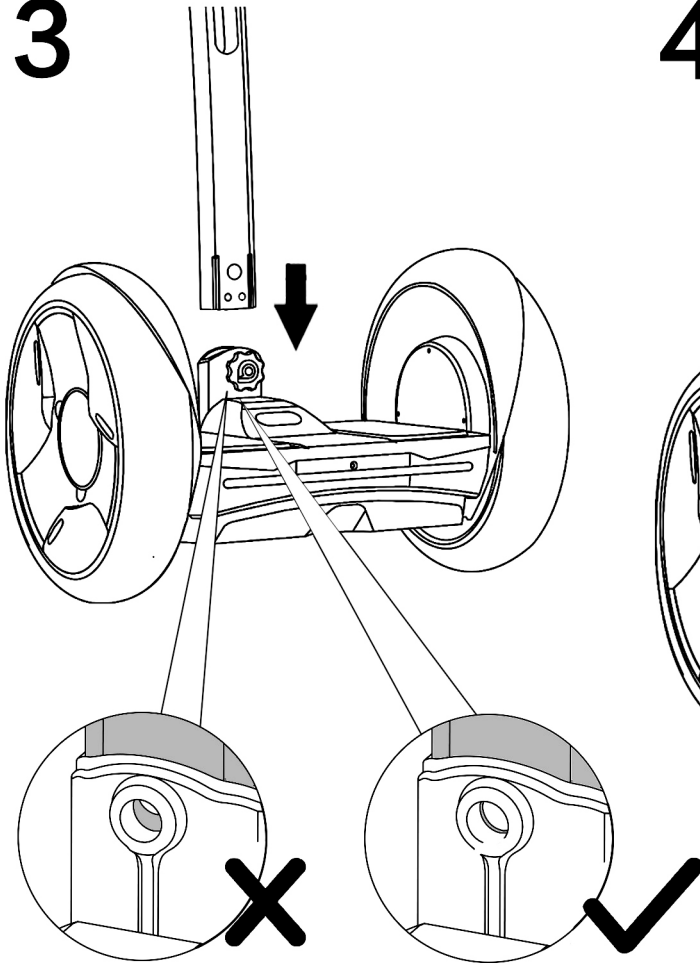

# 4

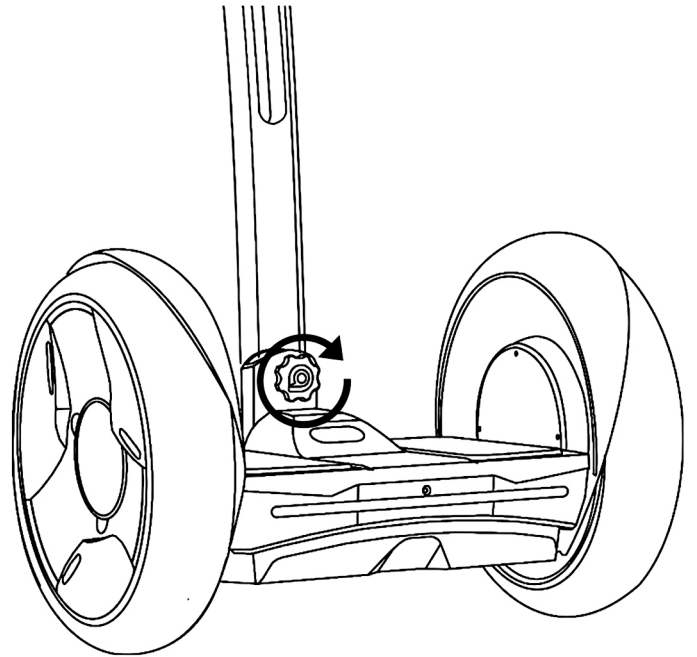

Remote key llave a distancia  
 遥控钥匙 Fernschlüssel

Chave remota  
 مفتاح بعيد

touche de la télécommande  
 원격 키 리모콘키



Power  
 Lock / Unlock  
 Speed limit  
 Information

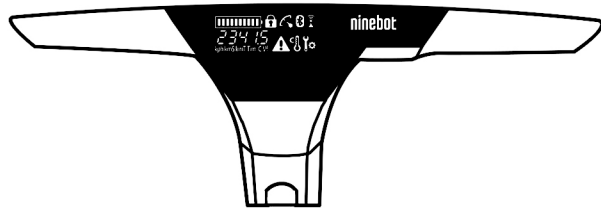
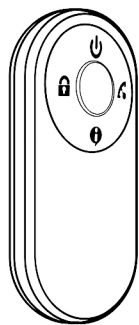

ON  
 开机  
 전원에  
 電源投入

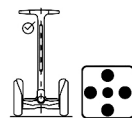
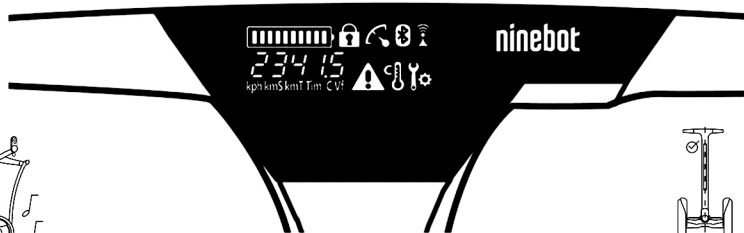

OFF  
 关机  
 전원을 껐다  
 電源オフ

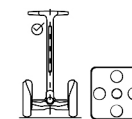
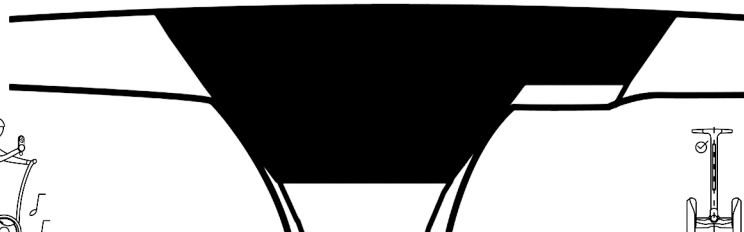

Standby 待机  
 режим ожидания  
 대기 스탠바이

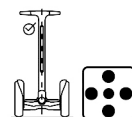
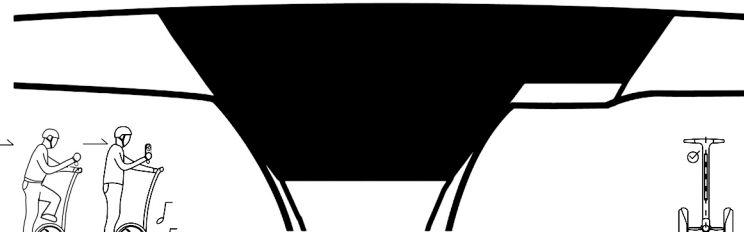

Lock 电子锁车  
 Cerrar Travar  
 قفل bloquer  
 запирать sperren  
 자물쇠 록크

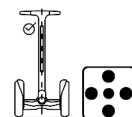
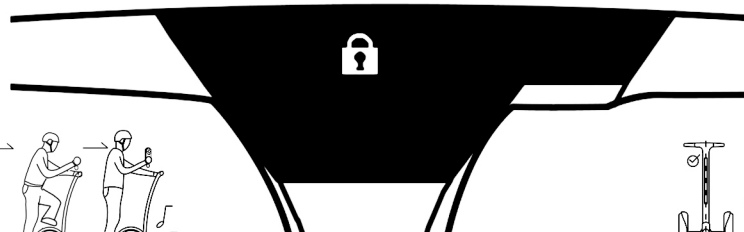
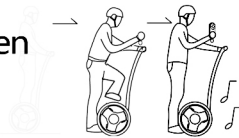

Unlock 解锁  
 Descubrir Destruvar  
 Ouvrir فتح  
 отпереть  
 잠금 해제 안록크

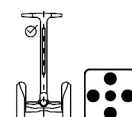
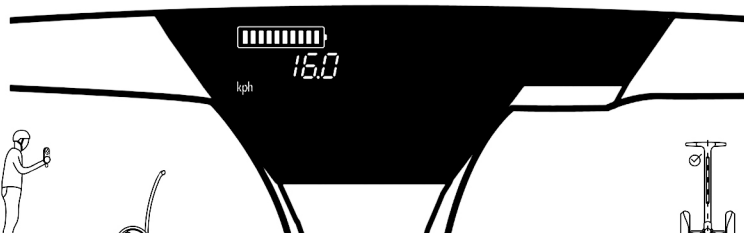





speed limit 限速  
 límite de velocidad  
 Limite de velocidade  
 La limite de vitesse  
 حد السرعة  
 Tempolimit  
 ограничение скорости  
 속도 제한 制限速モード

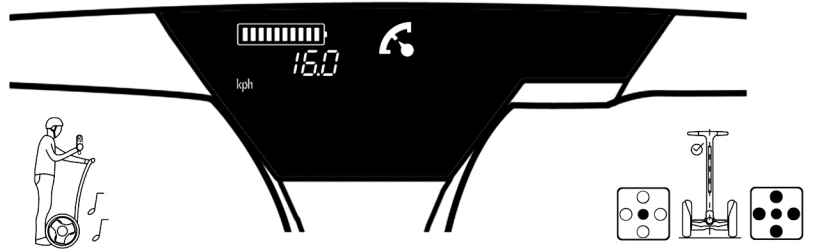

Normal Speed  
 正常速度模式  
 Velocidad normal  
 Velocidade normal  
 Vitesse normale  
 Нормальная скорость  
 السرعة العادية  
 표준 속도 通常速モード

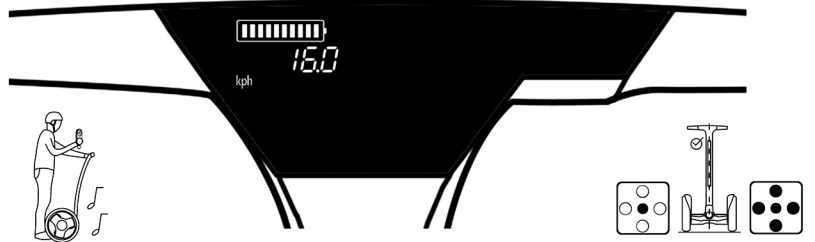

Turn on Bluetooth  
 打开蓝牙功能  
 Activar Bluetooth  
 Ligue o Bluetooth  
 Activez la Bluetooth  
 включить Bluetooth  
 بدوره على بلوتوث  
 >1.5S  
 Schalten Sie die Bluetooth  
 블루투스를 켜  
 Bluetoothをオンにする

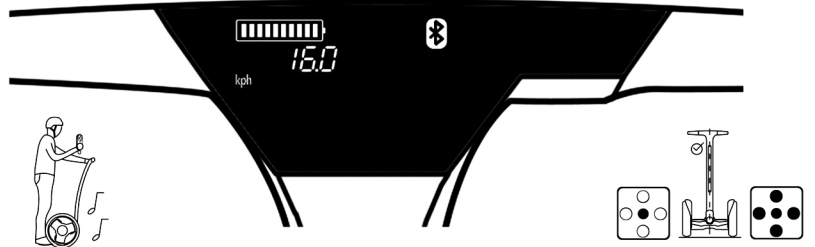

Turn off Bluetooth  
 关闭蓝牙功能  
 Desactive la Bluetooth  
 Desligue o Bluetooth  
 désactiver Bluetooth  
 выключить Bluetooth  
 إيقاف بلوتوث  
 >1.5S  
 ausschalten Bluetooth  
 블루투스를 해제  
 Bluetoothをオフにする

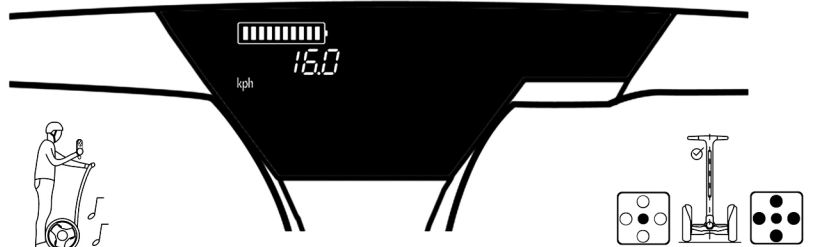

Information display  
 行车信息显示  
 pantalla de información  
 visualização de informações  
 Affichage des informations  
 عرض المعلومات  
 Информационный дисплей  
 Informationsanzeige  
 정보 표시 情報表示

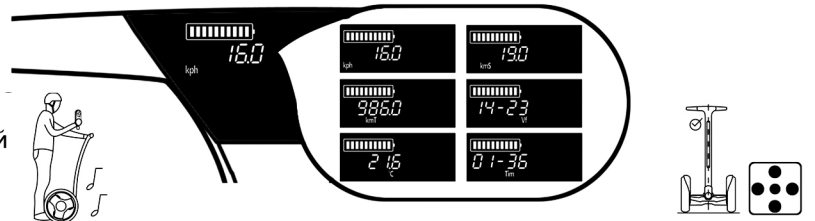

Turn on remote control 进入遥控模式  
 Encienda el control remoto  
 Ligue o controle remoto  
 Tournez sur la télécommande  
 بدوره على جهاز التحكم عن بعد  
 Включите дистанционного управления  
 >1.5S  
 Schalten Sie auf der Fernbedienung  
 원격 제어를 켭니다  
 リモコンの電源を入れます

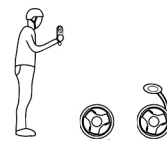

Ninebot E  
 Ninebot T

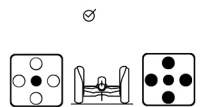

Turn off remote control 退出遥控模式  
 Apague el control remoto  
 Desligue o controle remoto  
 Désactiver télécommande  
 إيقاف التحكم عن بعد  
 Выключите пульт дистанционного  
 >1.5S  
 Schalten Fernbedienung  
 원격 제어를 해제  
 リモコンの電源をオフに



Ninebot E  
 Ninebot T

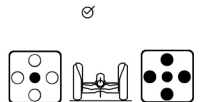

Operation 驾驶操作 Operación Operação opération  
 عملية операция Betrieb 조작 操作

Before ride:  
 上车前检查:  
 Antes de montar:  
 Antes de viagem:  
 Avant tour:  
 قبل الركوب  
 перед поездкой:  
 Vor Fahrt:  
 타기 전에:  
 乗る前に:

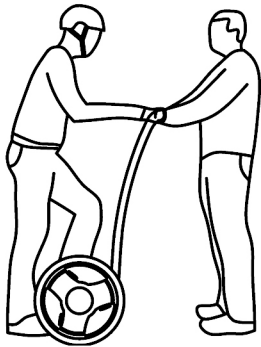
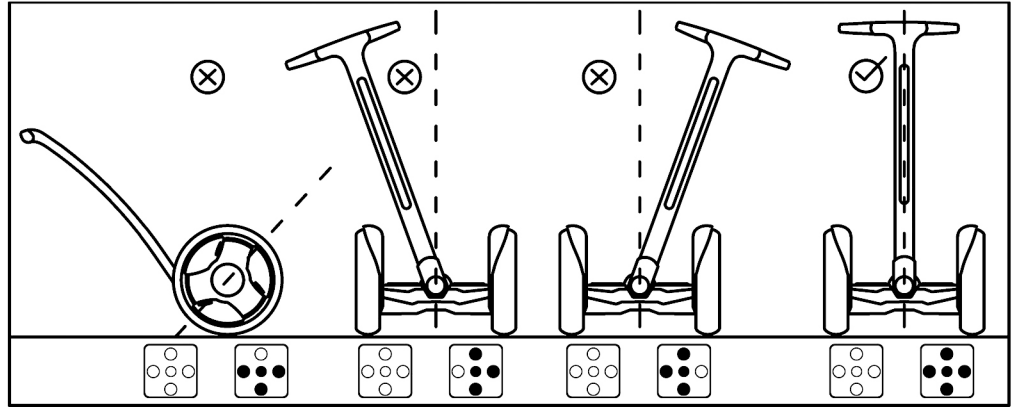

Get on 上车 Subir a



Subir em Monter الركوب

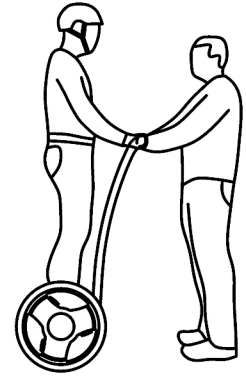

ладить 에 타다 乗る



Accdlerate/Forward

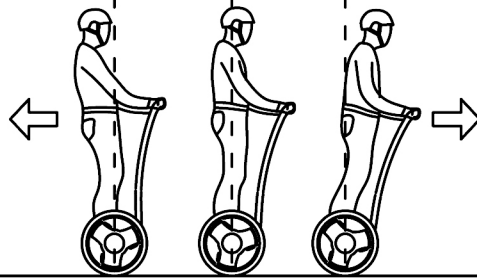

Decelerate/Backward

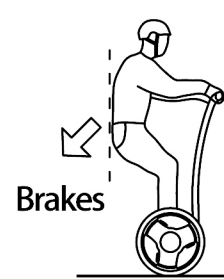

Brakes



Turning 转向 Torneado

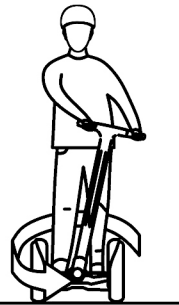

Virada Tournant دوران

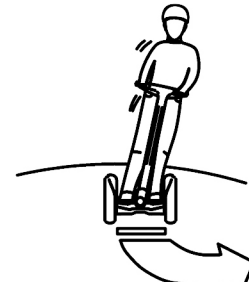

поворотный Drehung 선회 回轉



get off 下车

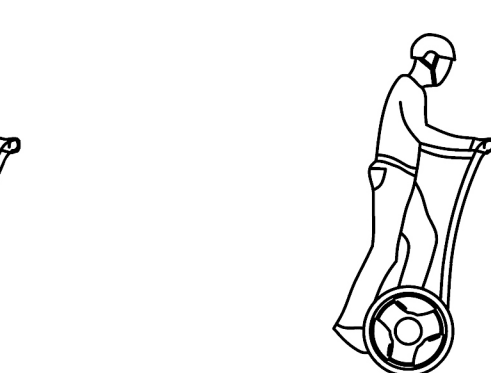

Bajar Sair Descendre



ترجل слезть Steigen Sie 하차 降りる

WARNING!  
ATENÇÃO!  
ВНИМАНИЕ!

警告!

تحذير

WARNING! 경고!

ADVERTENCIA!  
AVERTISSEMENT!

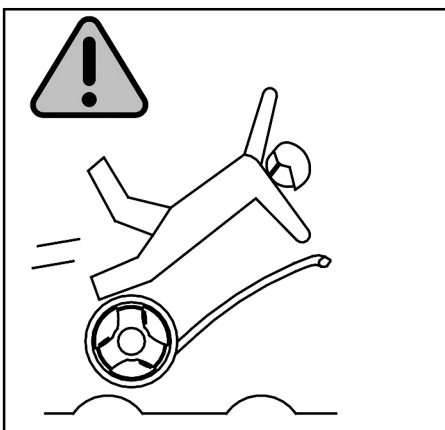
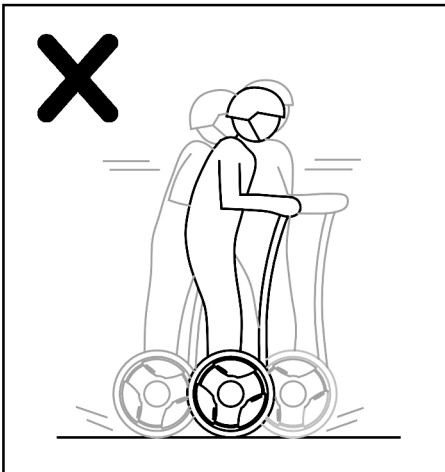
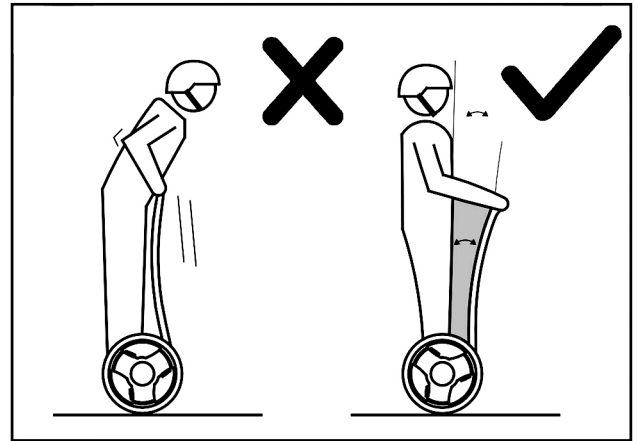
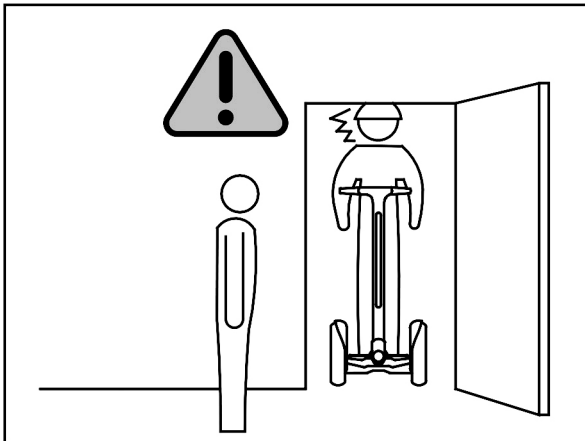
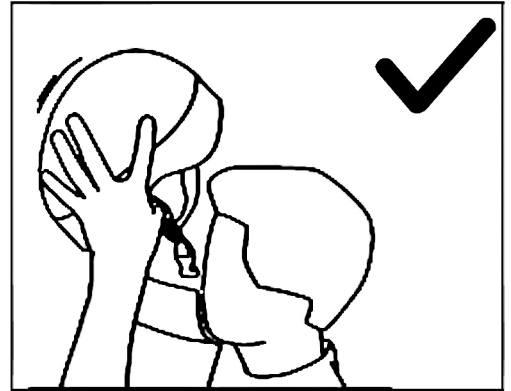

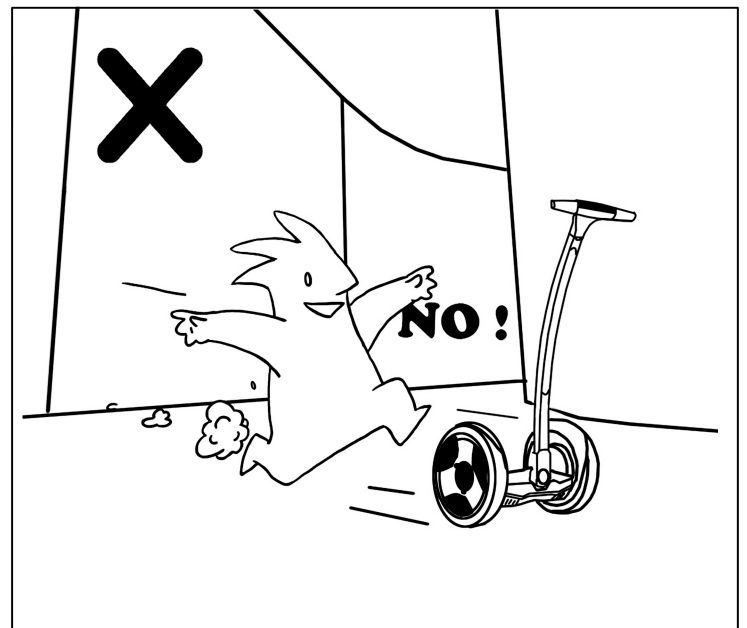
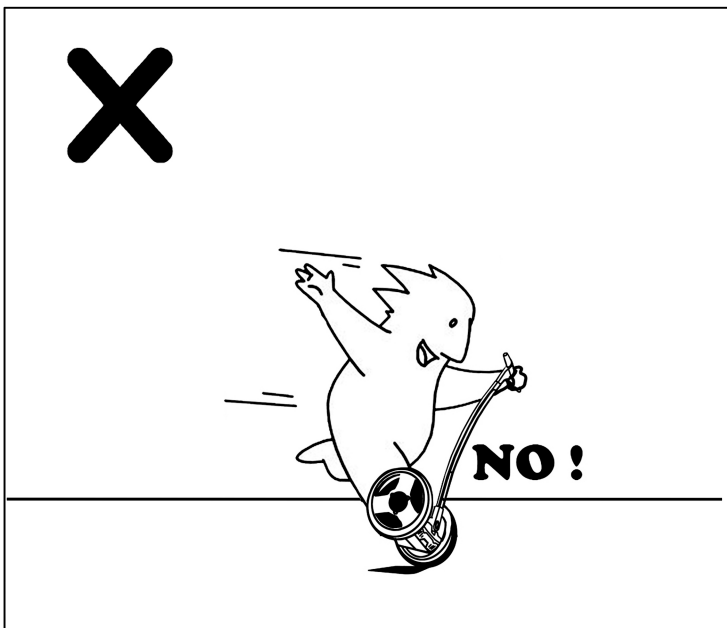
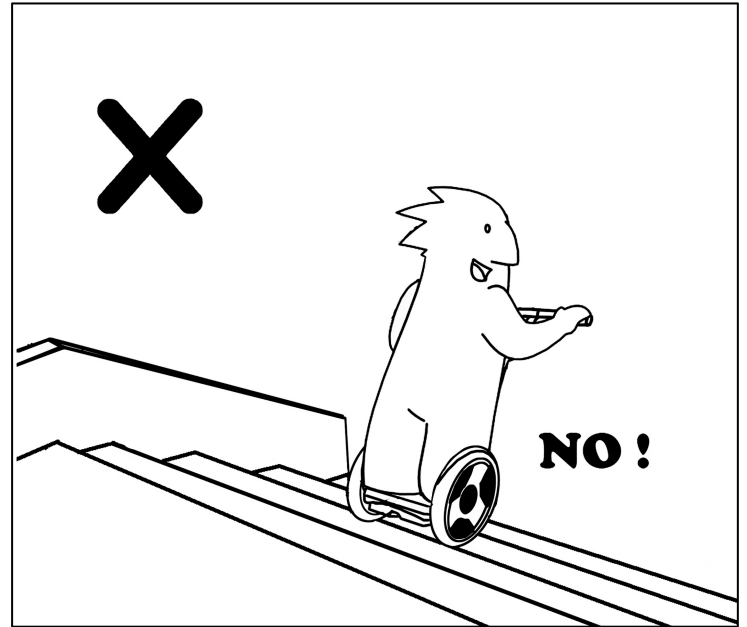
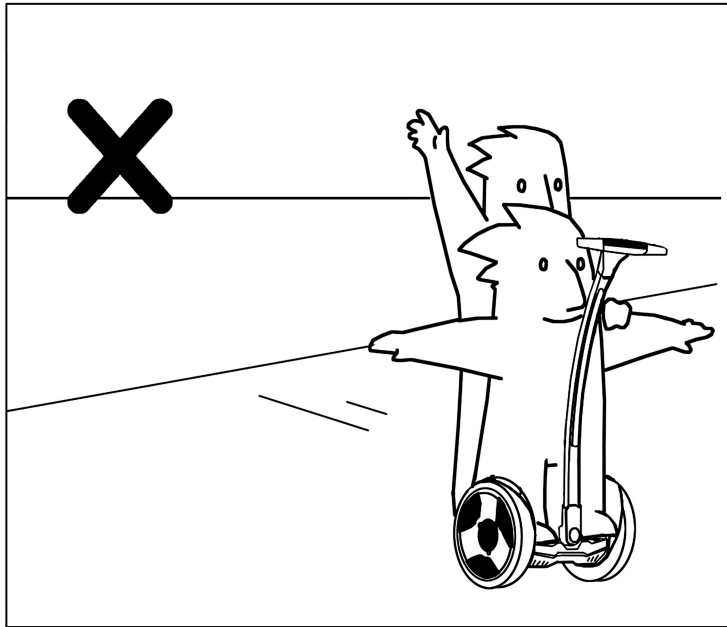
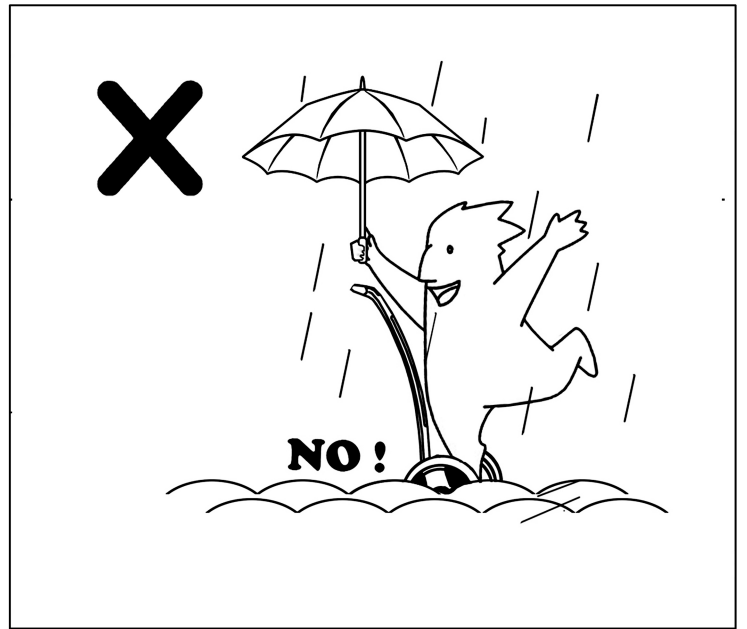
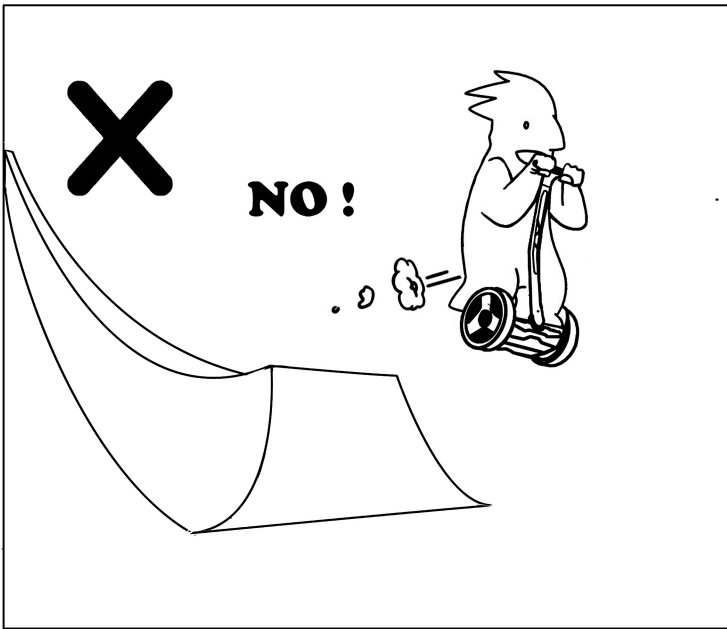

Transport and storage    Transporte y almacenamiento    Transporte e armazenamento  
 транспорт и хранение    Le transport et le stockage    Transport und Lagerung  
 运输与储存    النقل والتخزين    운송 및 저장    トランスポート&ストレージ

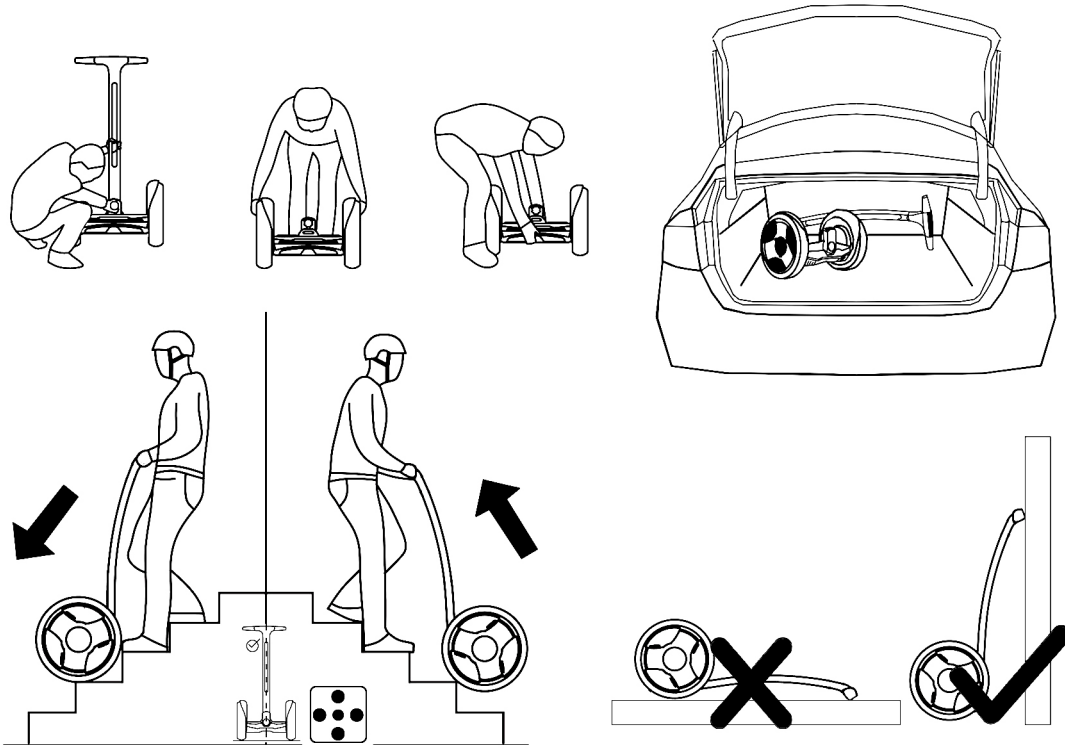

Battery maintenance    Mantenimiento de la batería    manutenção da bateria  
 Entretien de la batterie    обслуживание батареи    Batteriepflege  
 电池保养    صيانة البطارية    배터리 유지 보수    バッテリーのメンテナンス

Remaining battery  
 电池剩余容量  
 Capacidad de la batería  
 A capacidade da bateria  
 La capacité de la batterie  
 قدرة البطارية  
 ёмкость аккумулятора  
 Batterie-Kapazität  
 배터리 용량  
 バッテリー容量

Parking time >  
 存放时间大于  
 tiempo de almacenamiento  
 O tempo de armazenamento  
 Le temps de stockage  
 وقت التخزين  
 время хранения  
 Lagerzeit  
 저장 시간  
 蓄積時間

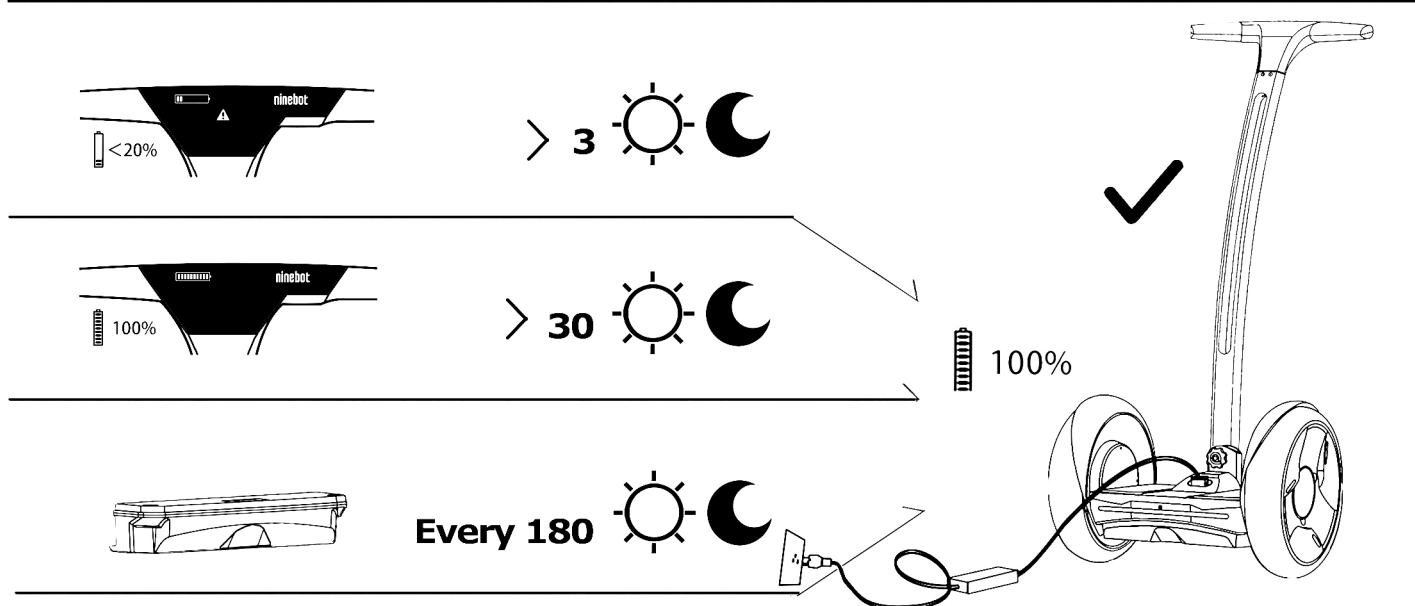



Clean the dirt  
 清洁磨砂表面  
 Limpie la suciedad  
 Limpe a sujeira  
 تنظيف الأوساخ  
 Nettoyer la saleté  
 Очистите грязь  
 Reinigen Sie den Schmutz  
 먼지를 청소  
 汚れをきれいに

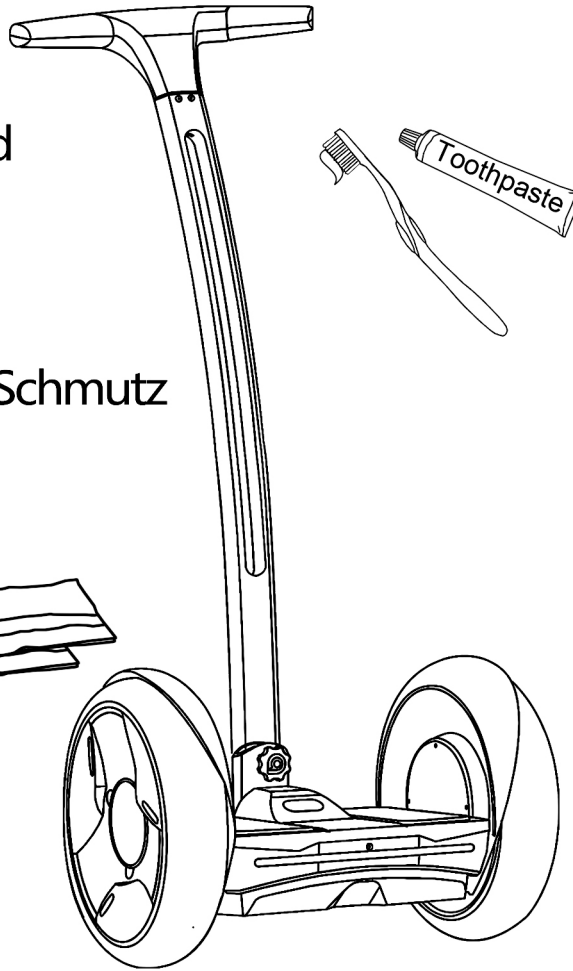

1.

Toothpaste 牙膏  
 pasta dentífrica  
 creme dental  
 معجون أسنان  
 dentifrice  
 зубная паста  
 Zahnpasta  
 치약 齒磨き粉

2.

Clean water 清水  
 Agua limpia  
 água limpa  
 تنظيف المياه  
 L'eau propre  
 чистая вода  
 Sauberes Wasser  
 정수 淨水



3.

Clean with a dry cloth  
 用干抹布擦拭  
 Limpie con un paño seco  
 Limpe com um pano seco  
 بمسح بقطعة قماش جافة  
 Essuyer avec un chiffon sec  
 Протрите сухой тряпкой  
 Wischen Sie mit einem trockenen Tuch  
 마른 천으로 닦아  
 乾いた布で拭いてください



Remove the scratch  
 去除划痕  
 Retire los rasguños  
 Remover os arranhões  
 إزالة الخدوش  
 Enlever les rayures  
 Удалить царапины  
 Entfernen Sie die Kratzer  
 흠집을 제거합니다  
 スクラッチを除去

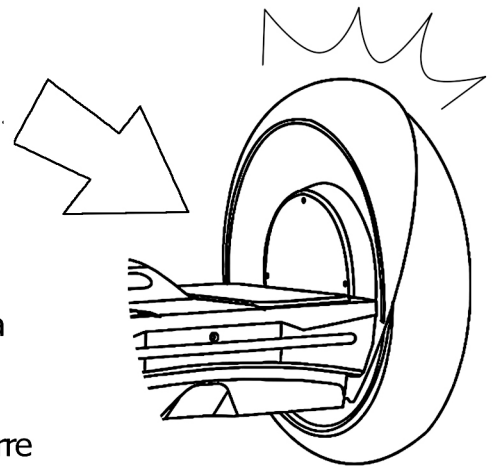
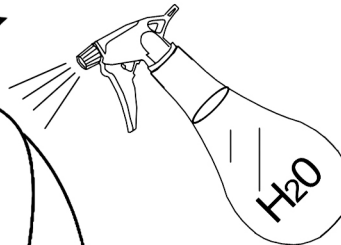
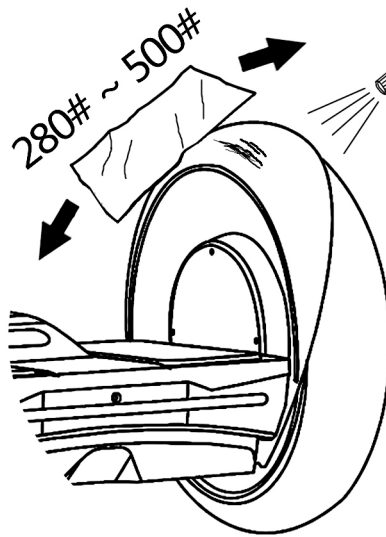

Grinding with sandpaper  
 喷水并用水砂纸打磨  
 Rectificado con papel de lija  
 Moagem com lixa  
 طحن مع الصنفرة  
 Broyage avec du papier de verre  
 Шлифовальные наждачной бумагой  
 Schleifen mit Sandpapier  
 사포와 물 연마  
 サンドペーパー、研磨