

Spares Part Code: F0000419

Safety Relief Valve to be used with 533122 CST Inlet Control Group only

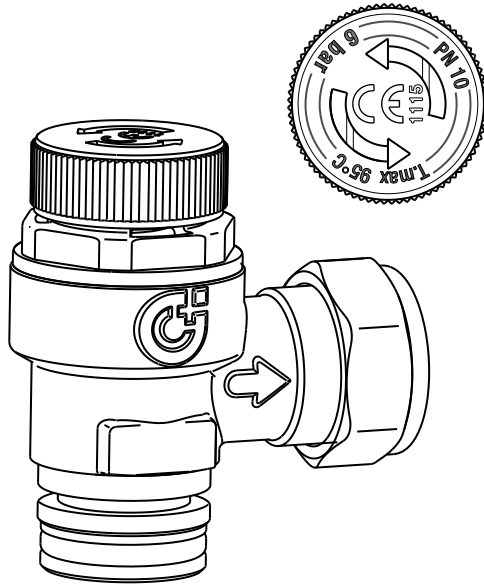

IMPORTANT:

- Only use genuine Caleffi spares.
- The installer needs to ensure the pressure ratings / settings are correct (refer to Altecnic for guidance if necessary).
- Lubricate with neutral silicone grease the 'O' ring before inserting in to existing manifold.
- Care taken to ensure when fitting that no damage to sealing faces or 'O' ring occurs.