

 Part of the
Whitesales Group

RYNO[®]
SUPPORT
SMART STRONG SUPPORT

www.rynogroup.co.uk 01358 726000

Fast, easy and
durable support
systems for paving
and decking



RYNO  DeckSupport™

RYNO  PaveSupport™



GROUND-BREAKING FINISHING SYSTEMS

Ryno is an innovative company, bringing ground-breaking finishing solutions to the construction sector. Every product within the Ryno family is designed to make life easier, safer and better for you.

Not only do we help you meet day-to-day challenges, but we're always looking ahead to develop breakthrough products that revolutionise the industry.

As long as there are challenges out there, Ryno will meet them head-on, with clever solutions that you'll love.

Any questions?
Give us a call on **01358 726000**
or email us at sales@rynogroup.co.uk

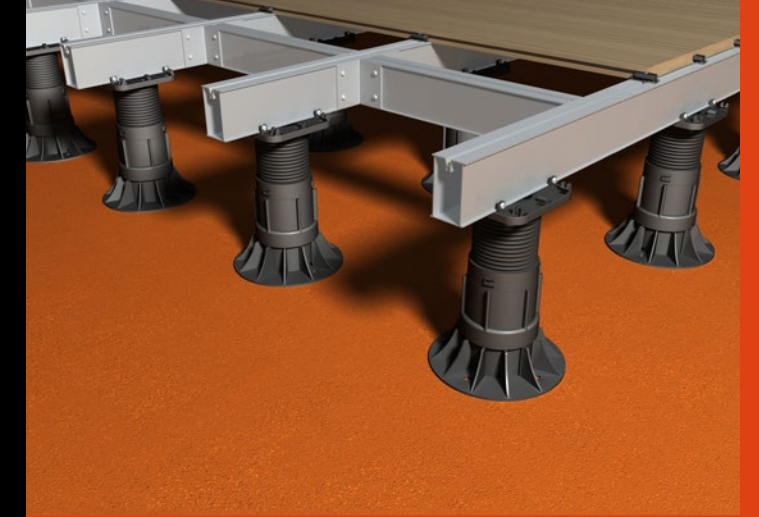

RYNO DeckSupport™

RYNO DeckSupport™

Quick, clean and easy deck building. Suitable for use with all conventional decking systems.

PAGE 4



RYNO PaveSupport™

RYNO PaveSupport™

The fast and versatile, strong and safe paving solution. Suitable for use with all uniform edged paving.

PAGE 22

We have decking support systems to suit every project, on every scale.

Contact our sales team and let us fit you out with a system that's right for you.

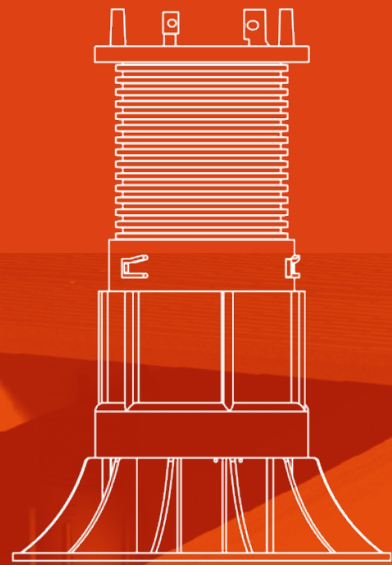

- Quick to install
- Easy to adjust
- Extremely versatile
- Long lifespan

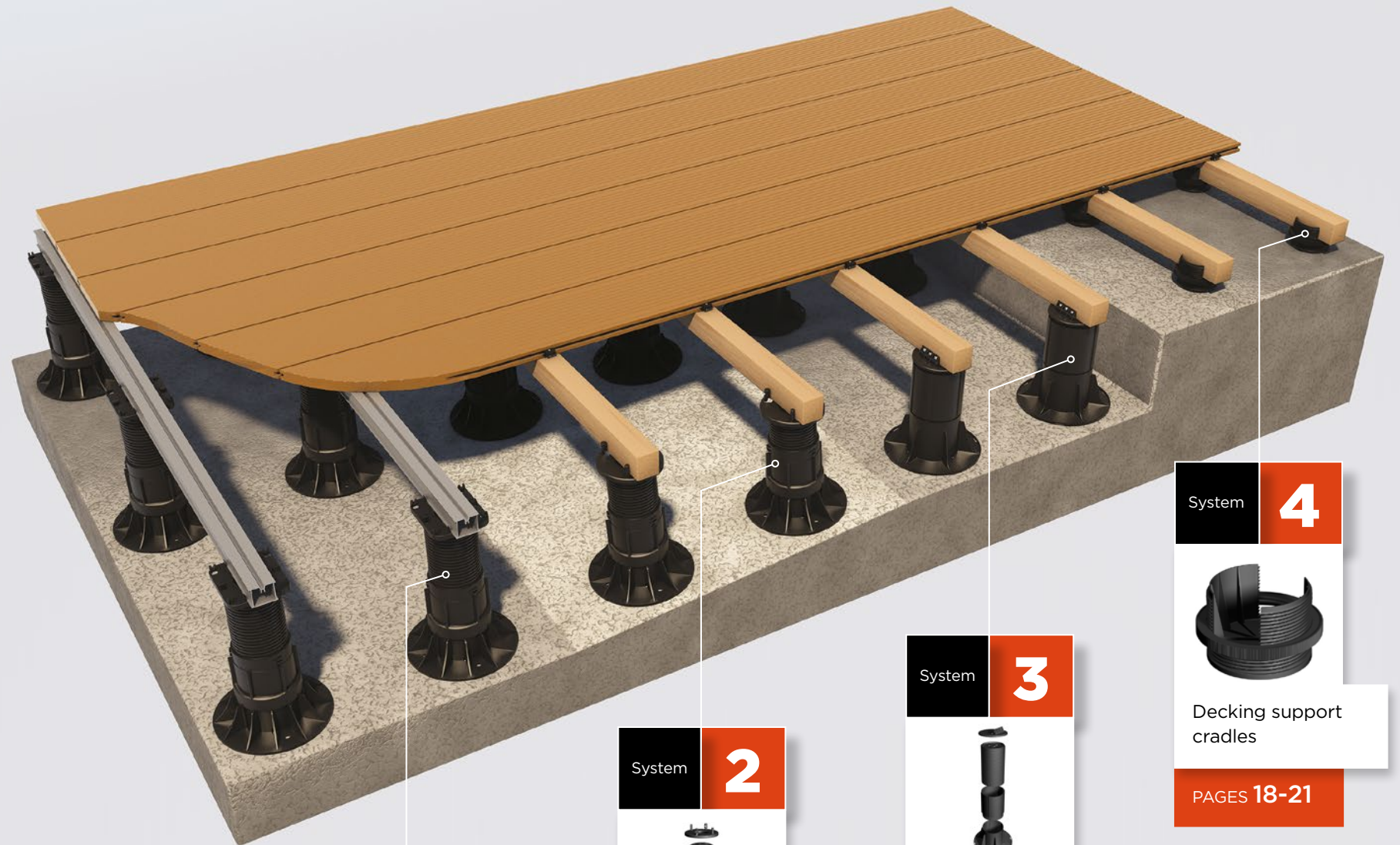

System **1**

Complete Aluminium Substructure System

PAGES 6-9

System **2**

Self-Levelling Adjustable Decking Pedestals (for laying over uneven or sloping surfaces)

PAGES 10-13

System **3**

Fixed-head Adjustable Decking Pedestals (for laying over level surfaces)

PAGES 14-17

System **4**

Decking support cradles

PAGES 18-21

RYNODeckSupport™

Complete Aluminium Substructure System

The RynoDeck aluminium substructure system is the ultimate decking support solution. Guaranteed never to rot, it is a perfect complement to composite decking. Its simple and sturdy design ensures rapid installation, regardless of the complexity of the project. Designed to support any conventional decking system, this is the perfect option for all decking applications.

Strong, versatile support.

Fully compatible with our pedestals and cradles, this system benefits from the unparalleled adjustability and strength of support provided by all of the RynoDeck support products.

- **Ultimate decking support solution**
- **Supports decking boards as low as 48mm, and as high as 1070mm**
- **Simple design - rapid installation**
- **Compatible with all RynoDeck pedestals and cradles**
- **Supports any type of conventional decking boards - softwood, hardwood, composite, PVC**
- **No rotting**

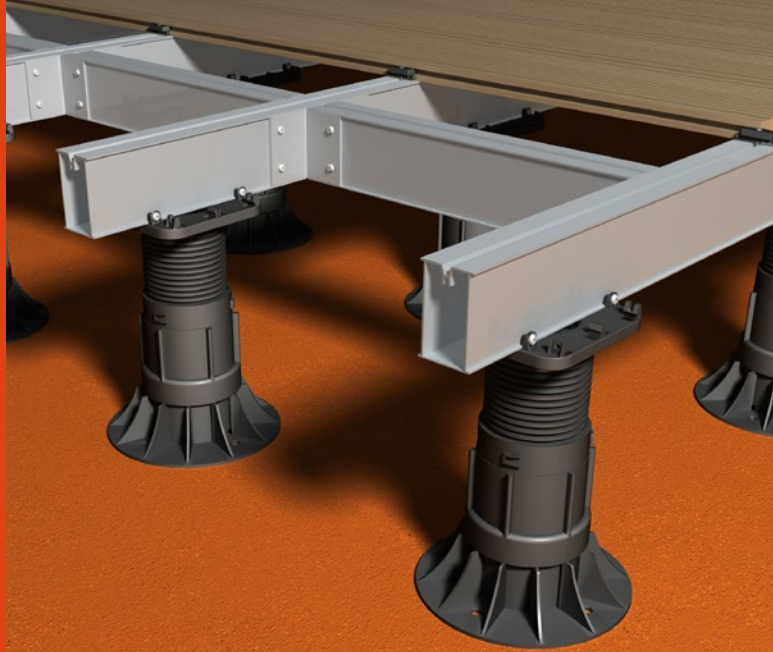

Decking fixing

High quality stainless screws prevent corrosion and ensure long-lasting secure fastening of decking boards to substructure. Designed to work with all conventional hidden deck clips.



Aluminium joist profile

Three sizes of aluminium joist profile cater for any deck support requirements. With a continuous fixing channel designed to offer optimum fixing strength, the profiles are compatible with any board width. Extruded to high quality standards, the RynoDeck aluminium substructure offers numerous benefits over other joist materials.

- **Always completely straight, ensuring perfectly even decking**
- **Will not warp, twist, splinter or crack**
- **Joists will never rot, ensuring superior longevity of decking**
- **Lighter than traditional methods, imposing less weight on supporting roof structures**
- **Greater strength-to-size ratio than traditional joists such as timber, and composite joists**



Joist connector profiles

Very simple connection methods mean the aluminium substructure is ultra-quick to install and gives great versatility when constructing a complex deck area.

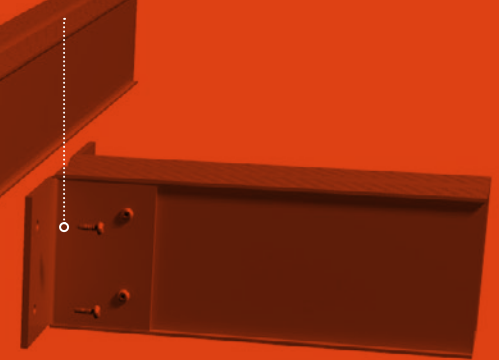

'Clip-on' self-levelling head

Due to its unique features, the newly designed 'clip-on' head makes for significant time saving.

Unique design features allow the RynoDeck aluminium joists to be rapidly 'clicked' into place on the pedestals, without the need for fixings, and effortlessly overcome the most challenging of applications.

- **Allows RynoDeck aluminium joist profiles to simply be 'clicked' into place**
- **Unique multi-directional head allows for single joists, double joists, and perpendicular profiles**
- **Incorporates Self-levelling design to easily accommodate sloping areas of up to 10.5% gradient (6°)**

Features of the self-levelling head:

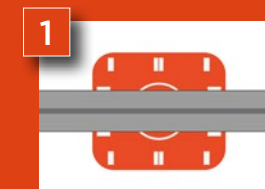

Single joists 'click' into place on the pedestal.



Rotate 'clip-on' head through 90°.



Double joists 'click' into place side by side, perfect for supporting board joints.



Versatile design allows for multi-directional applications.



Joist profiles

			
DS22 Aluminium Joist Width: 48mm Depth: 22mm Finish: Mill finish or powder coated	DS38 Aluminium Joist Width: 48mm Depth: 38mm Finish: Mill finish or powder coated	DS72 Aluminium Joist Width: 48mm Depth: 72mm Finish: Mill finish or powder coated	DS-PF Perimeter/Fascia Profile Fixes to side of joist to allow vertical fixing of boards where step/fascia detail is required. Finish: Mill finish or powder coated

Connections

					
DS-SC Straight Joist Connector Available for 22, 38, 72mm joist profiles	DS-AC 90 Angle Joist Connector 90° Available for 22, 38, 72mm joist profiles	DS-AC 135 Adjustable Angle Joist Connector Available for 38, 72mm joist profiles	DS-VC Perimeter/Fascia Profile Bracket	DS-BB Ballast Bracket	DS-GA Ground Anchor

						
DS-SSDS-38 Stainless Steel Decking Screw for Plastic Clips	DS-SSDS-19 Stainless Steel Decking Screw for Metal Clips	DS-SSJS Stainless Steel Joist Screw for Joist Connectors	Self-levelling pedestal For sloping areas with compatible 'clip-on' head. See RynoDeck System 2 for pedestal size range	Fixed-head pedestal For flat areas with compatible head. See RynoDeck System 3 for pedestal size range	RDC 10-40 Adjustable Cradle For use with DS72	RDC 10-40 LH Adjustable Cradle For use with DS38

Technical Specifications

Material	Aluminium Alloy 6063
Temper	T6
Finish	Mill finish or powder coated to RAL 9005 (black)
Support Height	48 - 1072mm (when used in conjunction with RynoDeck pedestals/cradles)
Allowable load (uniformly distributed)	4.0 kN/m ² (further information available on request)
Allowable load (concentrated)	1.4 kN (further information available on request)
Supporting pedestals/cradles	See systems 2, 3 & 4 for technical specifications

RYNODeckSupport™

Self-levelling Adjustable Decking Pedestals

The RynoDeck self-levelling adjustable pedestal is unrivalled in its field.

Designed to support any type of decking or flooring joist, it offers the highest compressive strength of any pedestal system on the market.

Self-levelling support.

The unique self-levelling pedestal head and impressive height range will accommodate even the most complex decking issues - including sloping areas, drainage and maintenance access.

- **Unique self-levelling design offers slope correction up to 10.5%**
- **Ultimate compression strength for maximum durability**
- **Simple design ensures rapid installation**
- **For use with any joist size or type - timber, composite, aluminium, steel**

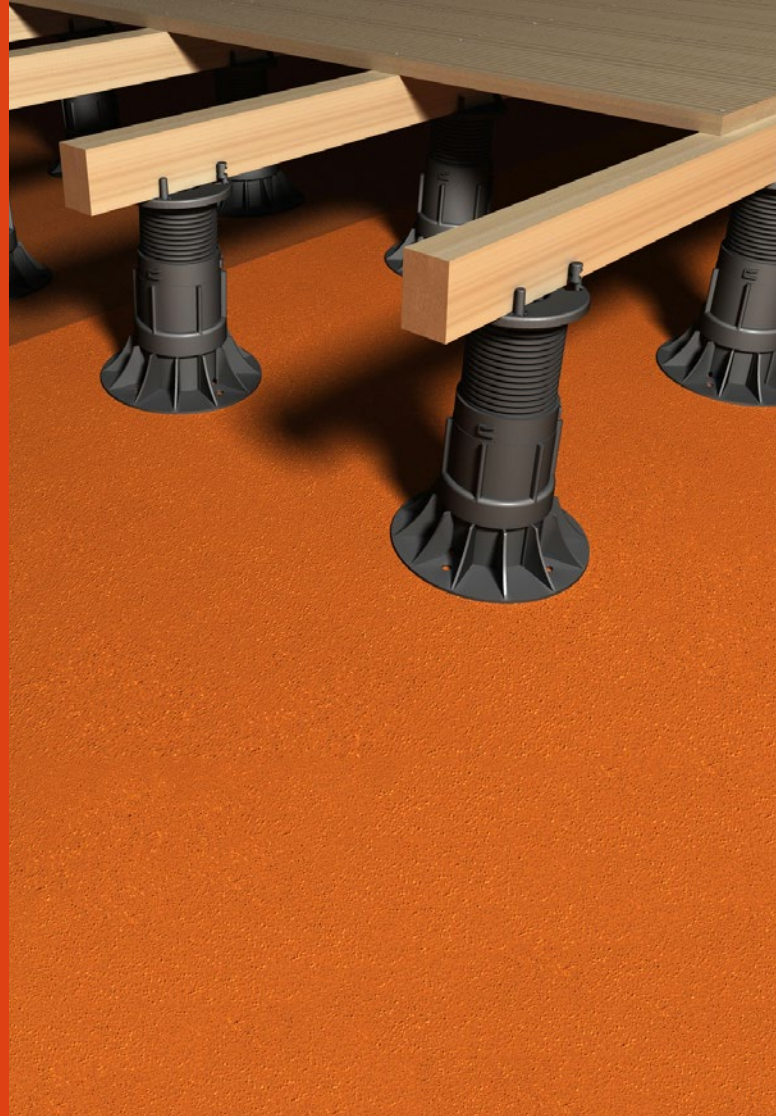

Self-levelling bearer support head

Due to its innovative self-levelling head design, RynoDeck has the fastest installation time of any pedestal system available.

- Utilises the 'ball & socket' joint concept to allow a free moving captive head
- Provides slope correction of up to 10.5% (6°)
- Lay paving or decking directly onto pedestals without manual slope correction
- Offers significant time savings and a perfectly level finished area
- Can accommodate bearer width of up to 100mm
- Alternative head available to support paving

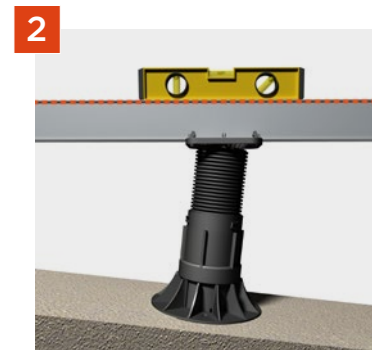
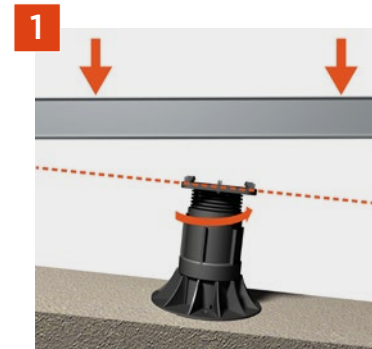

Optional deck tile head

The Self-Levelling Bearer Support Head is replaceable with a Deck Tile Head, if you wish to lay decking tiles.



Adjustable threaded section

This heavy grade threaded section allows you to adjust the height in minute increments, within the given range. It's easy to adjust, simply grab and twist.



Height extension collar

A very simple design with a single 'click' motion to attach, these extension collars build up the pedestals in 100mm increments.



Wide supporting base

Pedestals are loose laid and do not require fixing to the floor.

- Large diameter spreads loads and ensures stability
- Prevents damage to roof membranes and other substructures
- Can be fixed down into concrete, or loose laid on roof membranes, etc.
- Incorporates water drainage holes to prevent moisture build-up



Size range

The vast height range of the RynoDeck self-levelling adjustable pedestal allows it to overcome very large changes in surface level, and also conceal services, ductwork and pipes beneath the deck.

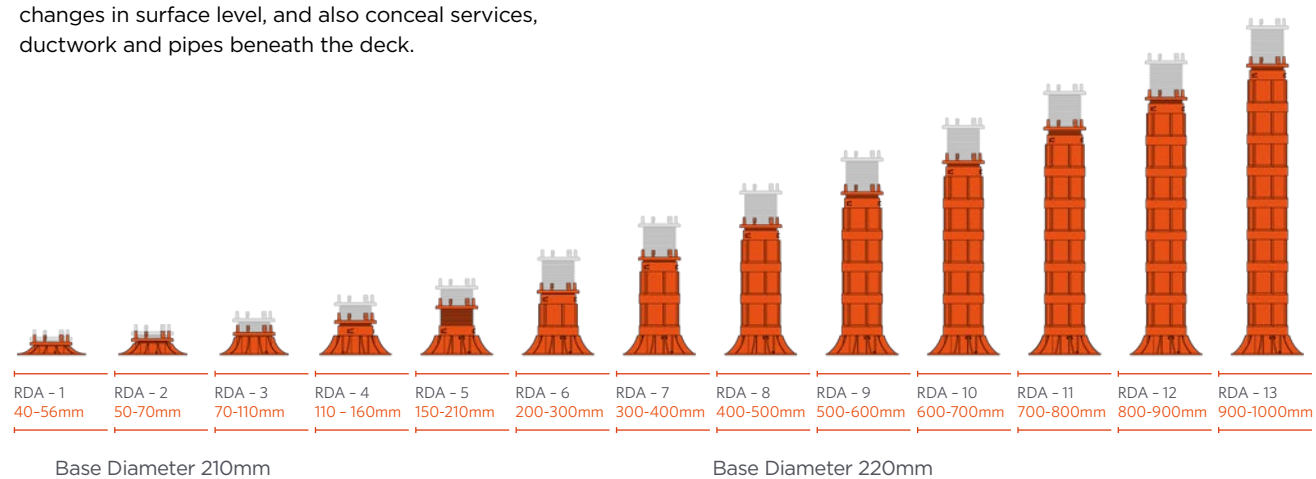

Optional components



RDA - DTH

Deck Tile Head
For use when installing decking tiles.



RDA-BRSP

Base Rubber Shock Pad
Installed to enhance acoustic properties, or where membrane requires additional protection.

RynoDeck pedestal spacing & quantity calculations

For help calculating the quantity of pedestals you require, or for any other guidance regarding your project, call Ryno on:

01358 726000

Technical Specifications

Material

PP Polypropylene (recyclable), UV resistant

Biological/Chemical

Resistant to moulds, algae, alkali, bitumen

Height range

40mm - 1000mm

Compression

2100 Kg
(certified compression data available on request)

Base diameter

210mm / 220mm

Head diameter

135mm

Bearer capacity

Up to 100mm

Working temperature

-40°C - 120°C

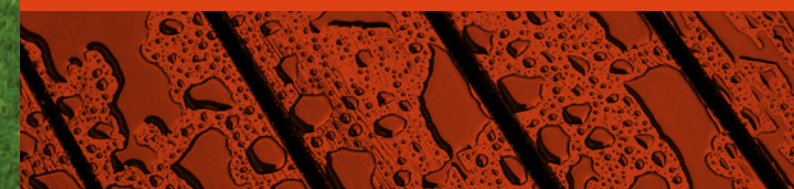

RYNO DeckSupport™

Fixed-head Adjustable Decking Pedestals

The RynoDeck fixed-head adjustable pedestal offers a high quality and economical option for supporting decking systems on completely level surfaces. Its impressive 22–550mm height range makes it perfect for areas with problematic height restrictions, as well as areas where greater height build-up is required.

Support in any space.

With a simple but very effective design, this pedestal makes for a rapid and effortless decking installation.

- **Robust product ensuring stability of decking area**
- **Perfect for very low height installations; adjusts down to 22mm**
- **Accommodates all types and sizes of decking joist**



Bearer support head

Due to its low profile design, the bearer support head allows this pedestal to go right down to 22mm height. The head utilises a clever connection which allows it to turn freely on top of the adjustable threaded section of the pedestal, meaning that the pedestal height can be adjusted once the joist is on top. Joists of up to 80mm can be used and are fixed through a heavy-duty locator bracket.



Adjustable threaded section

The robust threaded section allows for incremental height adjustment within the given range. Effortless to adjust, simply turn the section by hand, even once the joist is in place.

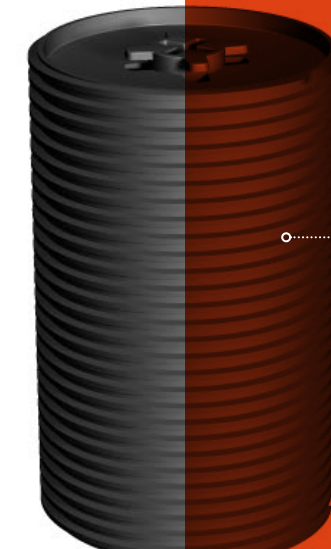

Height extension collar

A very simple design with a single 'click' motion to attach, these extension collars build up the pedestals in 100mm increments.



Support base

The broad base spreads the load on the surface below and ensures stability.

The pedestals are normally loose laid onto roofing membranes which must not be penetrated, or can be mechanically fixed to concrete or other substrates.

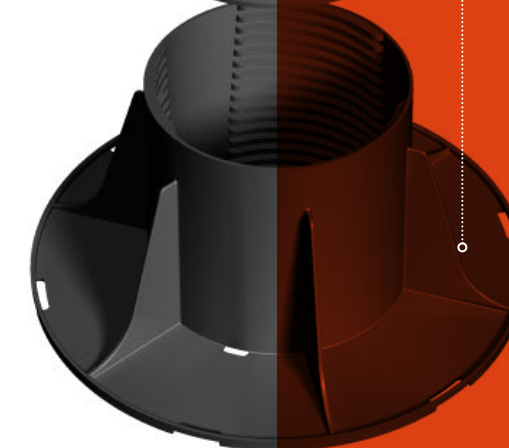

RYNO DeckSupport™ Fixed-head Adjustable Decking Pedestals

Size range

The RynoDeck fixed-head adjustable pedestal is the perfect solution where decking is to be supported on a totally flat area. Capable of supporting joists as low as 22mm off the surface, it will overcome the common problem of height restrictions, as well as quickly and simply elevating decking areas up to 550mm high.

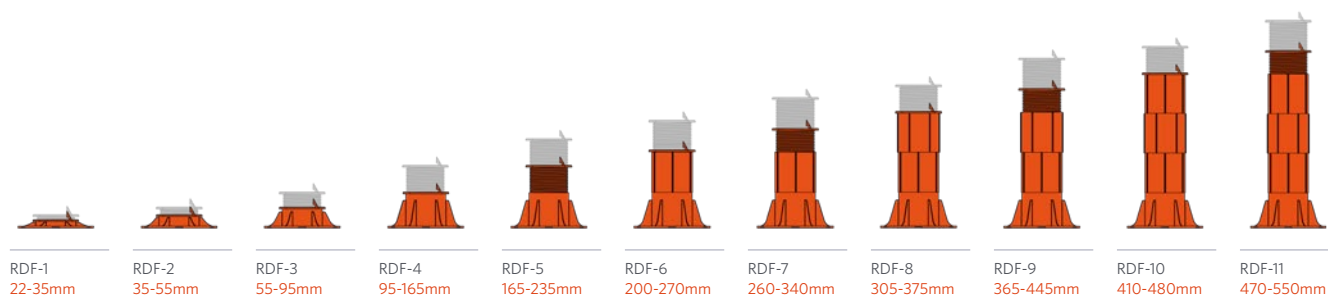

Optional components

RDF - DTH
Deck Tile Head

For use when installing decking tiles.

RDA- BRSP
Base Rubber Shock Pad

Installed to enhance acoustic properties, or where membrane requires additional protection.

RynoDeck pedestal spacing & quantity calculations

For help calculating the quantity of pedestals you require, or for any other guidance regarding your project, call Ryno on:

01358 726000



Technical Specifications

Material

PP Polypropylene (recyclable), UV resistant

Biological/Chemical

Resistant to moulds, algae, alkali, bitumen

Height range

22mm - 550mm

Compression

1000 Kg

Base diameter

200mm

Head diameter

120mm

Bearer capacity

Up to 80mm

Working temperature

-40°C - 120°C

RYNODeckSupport™

Decking Support Cradles

RynoDeck cradles are the perfect solution where decking requires elevating off the ground by a minimal height.

Strong, safe support.

Simple to install and adjust, they are a very economical method of creating a clear space below the decking joists, which improves air circulation and can help to prevent rot.

- Supports very low decking applications, as low as 10mm
- Perfect for patio overlays/renovations
- Ideal for creating balcony decking areas
- For low height applications

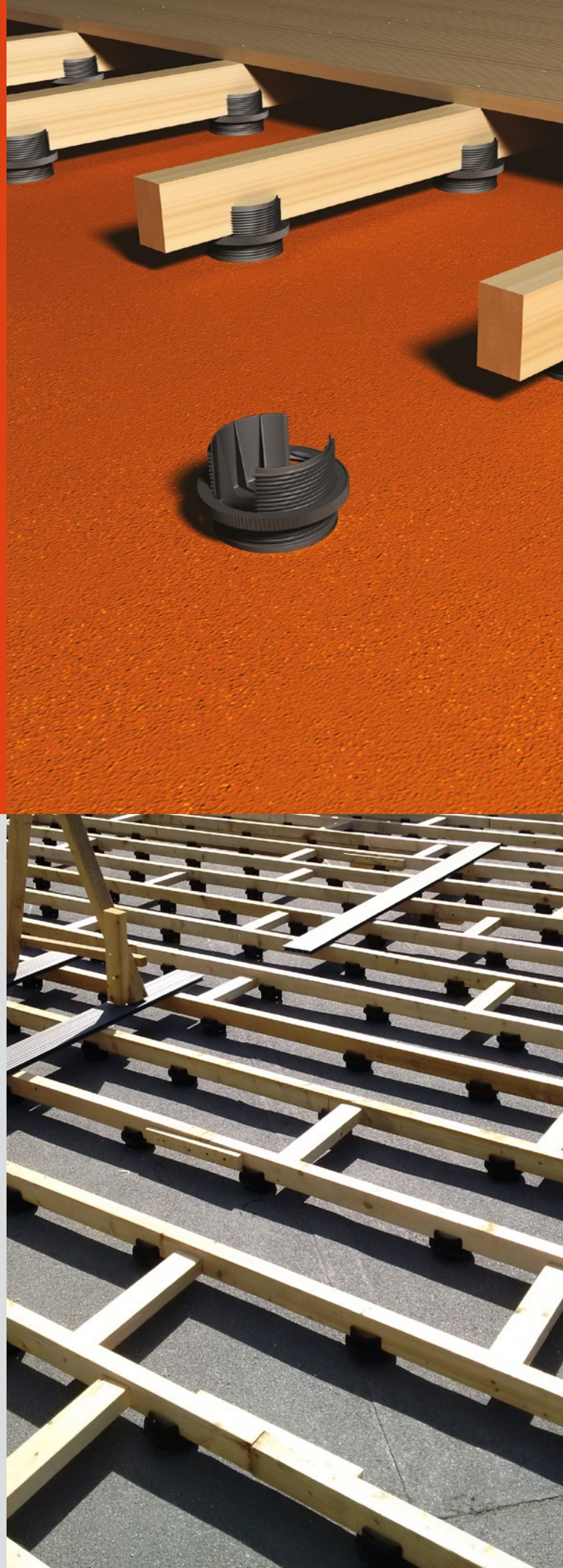

Adjustable decking cradle



Infinite adjustment

The RynoDeck adjustable decking cradle offers joist support with infinite adjustment between 10-40mm.

Fixed height decking cradle



Simple and versatile

RynoDeck fixed height cradles are a simple and versatile option for elevating decking joists off a flat surface. Made from recycled rubber, they evenly spread the load on the supporting surface.

Adjustable decking cradles



RDC - 10-40
10-40mm
Adjustable Cradle
For joists minimum
50mm high.



RDC - 10-40 LH
10-40mm
Adjustable Cradle
For joists less than
50mm high.

Fixed height decking cradles

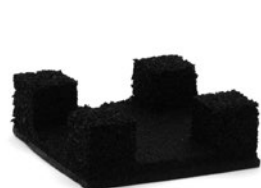

RDC - 10
10mm Cradle

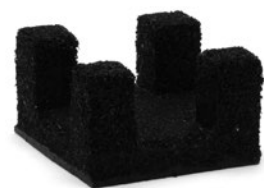

RDC - 20
20mm Cradle



RDC - 2
2mm Shim



RDC - 5
5mm Shim

Shims are for fine height adjustment with RDC - 10 and RDC - 20

RynoDeck cradle spacing & quantity calculations

For help calculating the quantity of cradles you require, or for any other guidance regarding your project, call Ryno on:

01358 726000

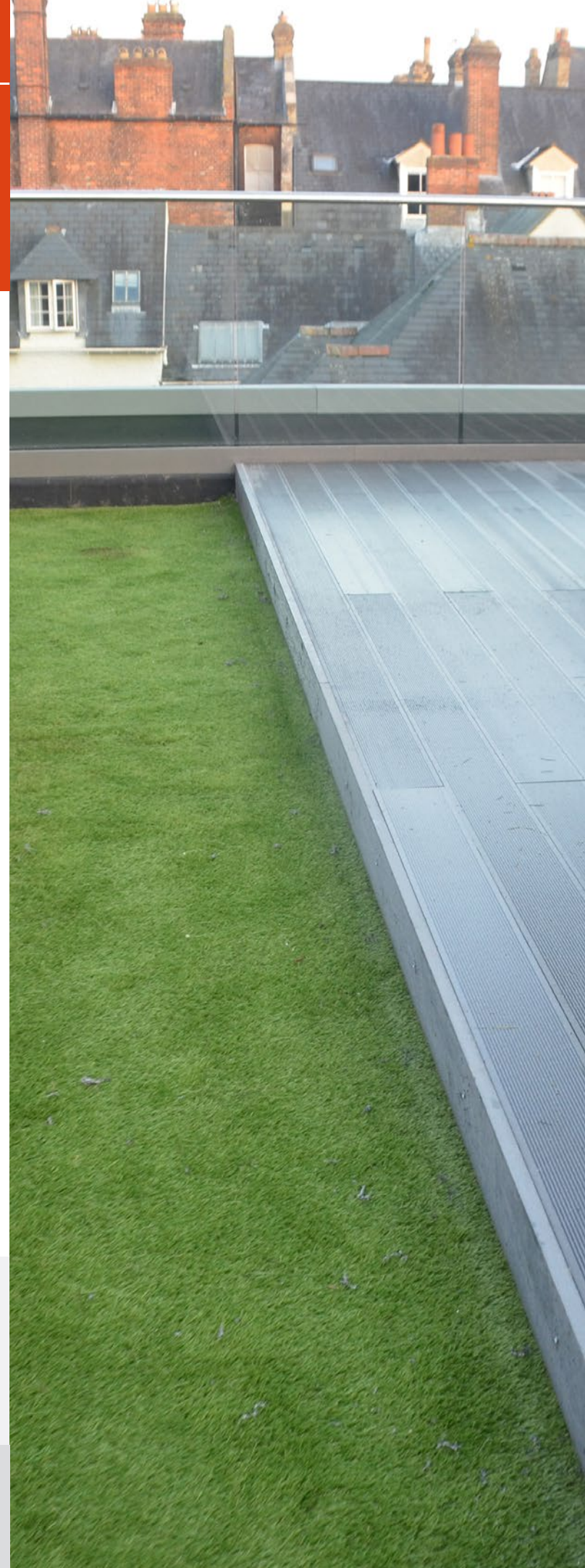

Technical Specifications

Adjustable decking cradles	Fixed height decking cradles
----------------------------	------------------------------

Material	
Recycled Nylon (glass filled)	Rubber (92% recycled tyre tread)
Biological/Chemical	
Resistant to moulds, algae, alkali, bitumen	Resistant to moulds, algae, alkali, bitumen
Height range	
10mm - 40mm	10mm - 40mm (min 2mm increments)
Compression	
6 kN/m ² (min. 6 cradles/m ²)	800 Kg
Base diameter	
90mm	100 x 100mm
Bearer width capacity	
44-48mm	30-48mm
Bonding agent	
Flexible Polyurethane	

RYNO PaveSupport™

We have paving support systems to suit every project, on every scale.

Contact our sales team and let us fit you out with a system that's right for you.

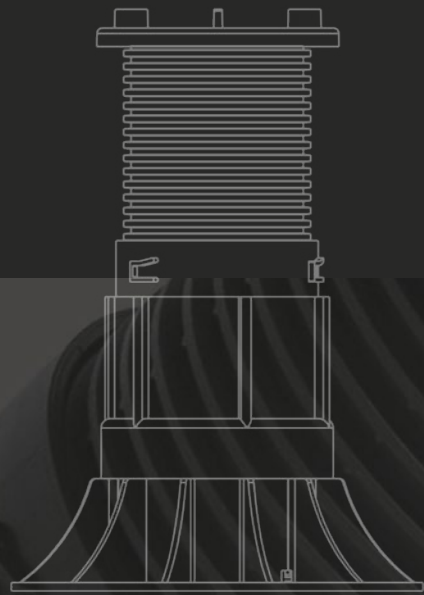

- Easy to install
- Extremely versatile
- Suitable for all areas from small domestic gardens to large scale developments

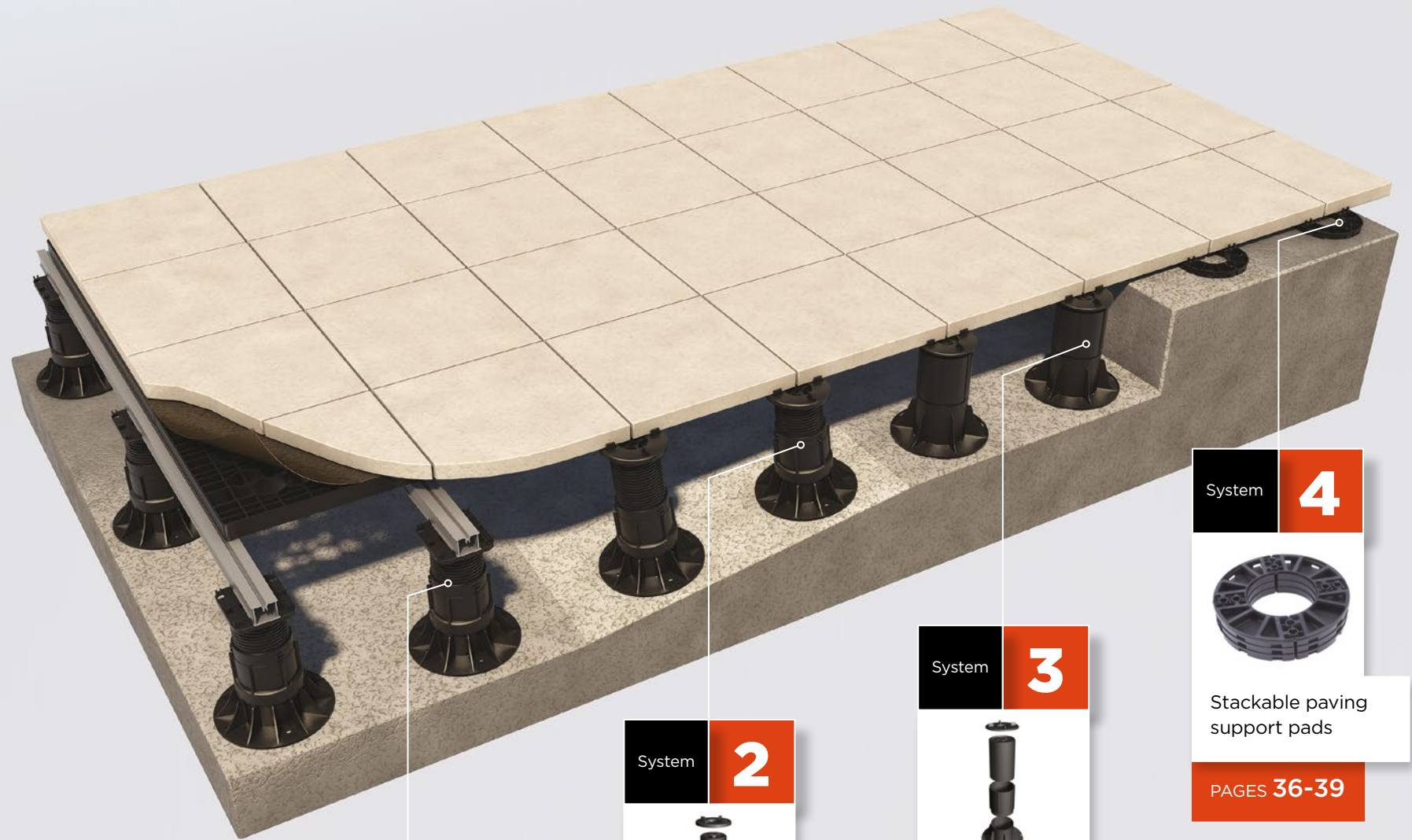

System **1**



Complete paving support grating System

PAGES 24-27

System **2**



Self-Levelling Adjustable Decking Pedestals (for laying over uneven or sloping surfaces)

PAGES 28-31

System **3**



Fixed-head adjustable paving pedestals (for laying over level surfaces)

PAGES 32-35

System **4**



Stackable paving support pads

PAGES 36-39

RYNOPaveSupport™

Complete Paving Support Grating System

The RynoPave paving support grating system takes paving support to a whole new level. The robust polycarbonate grates are specially constructed to provide ultimate stiffness, creating a solid platform to support all types of calibrated paving systems. By creating an elevated paving support surface, RynoPave support grates allow patios and paved areas to be created on very uneven or sloping ground, without having to undertake expensive and disruptive groundworks.

Full Paving support system.

Unlike other systems, RynoPave grates provide full support to the paving system, giving scope to far more intricate paving designs and styles. The grates are supported on two sides by suitable timber joists or Ryno aluminium joists, with RynoPave support pedestals.

- Creates elevated paving areas with ease
- Eliminates the need for extensive groundworks, such as retaining walls and back-filling
- Perfect for roof terraces and balconies
- Suitable for all types of calibrated paving – concrete, block paving, granite, limestone, sandstone, marble
- Unlimited design possibilities; create the pattern format you want!
- Allows rapid water drainage through the paving

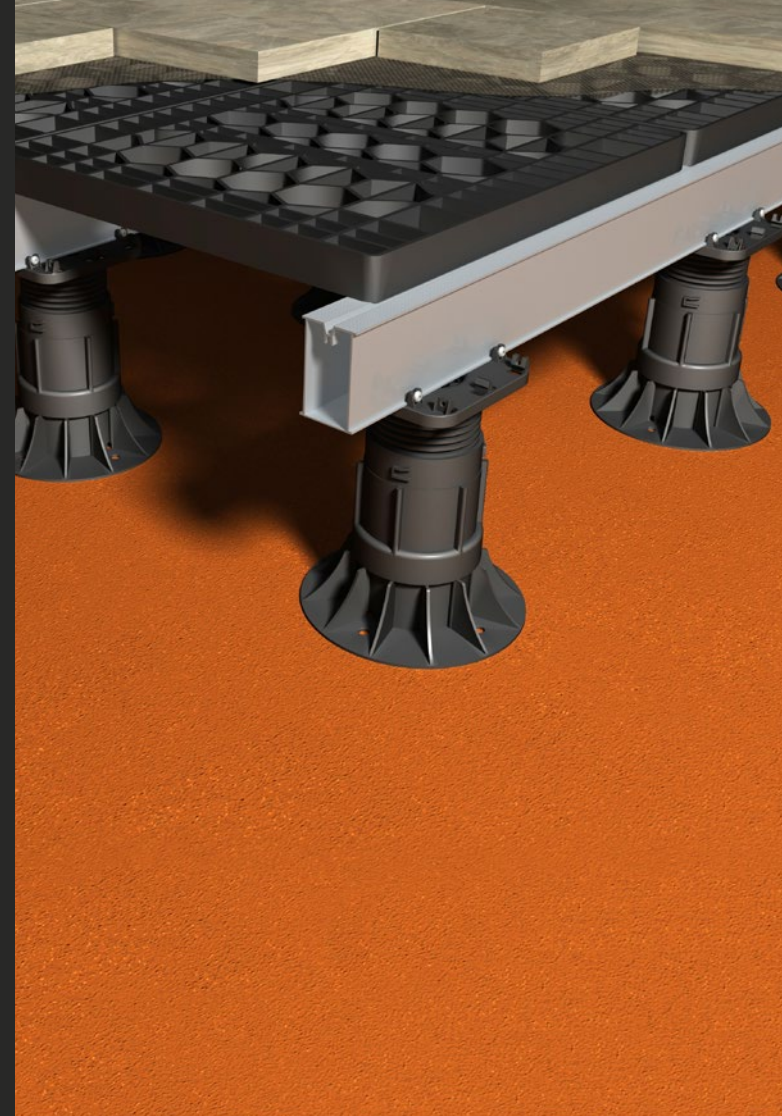

Paving support grate

Constructed from polycarbonate for ultimate strength, and utilising a specially designed 'honeycomb' structure to increase stiffness, the grate fully supports the paving. A landscape fabric is introduced on top of the grates if the paving kiln dried sand is to be brushed into the joints. The grates are fixed down to the supporting joists with screws to ensure a solid finish.

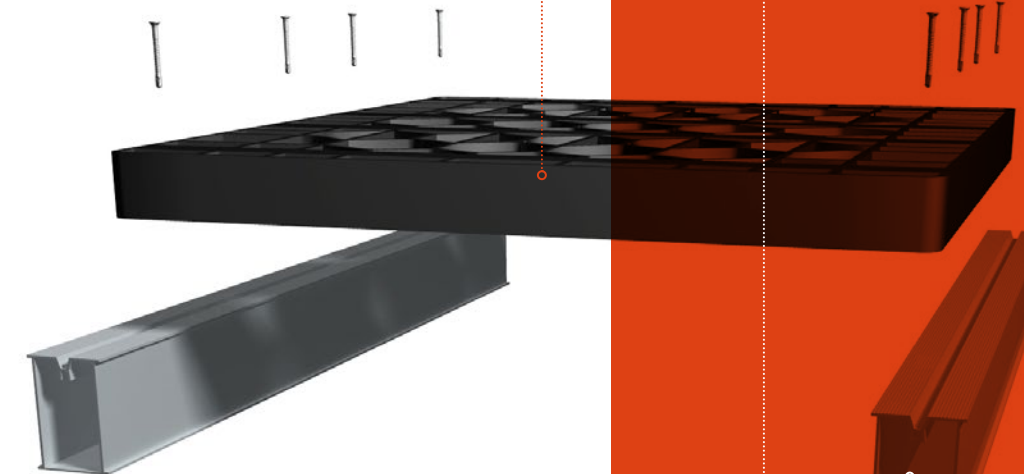

Supporting joist structure

The support grates are fully supported on two sides by either timber joists or Ryno Aluminium substructure. It is imperative that the supporting joist structure is of sufficient strength to ensure there is no movement.



Supporting pedestals

RynoPave paving support grates can be supported by the Ryno pedestal systems. This ensures ultimate support strength and versatility, and means the system is perfect for paving designs on roof terraces and balconies.



RYNO  **PaveSupport™ Complete Paving Support Grating System**

Support grate

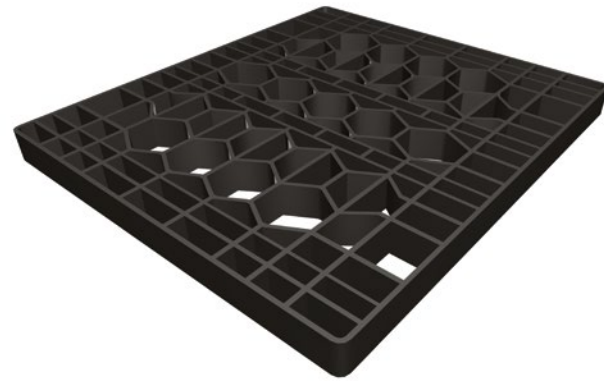

PSG-1
 Length: 450mm
 Width: 400mm
 Thickness: 38mm

Additional components



Landscape Fabric
 Prevents kiln dried sand from falling through the grates

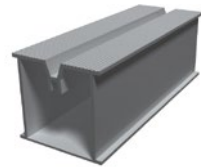

Ryno aluminium joist structure
 Provides a high strength supporting structure for the paving support grates.



Pedestals
 Ryno pedestals provide strong and versatile support for the joists.



Fastening screws
 High quality wood screws are sufficient for fixing the grates to a timber joist structure. However with the Ryno aluminium substructure, stainless steel screws should be used to ensure no corrosion occurs.

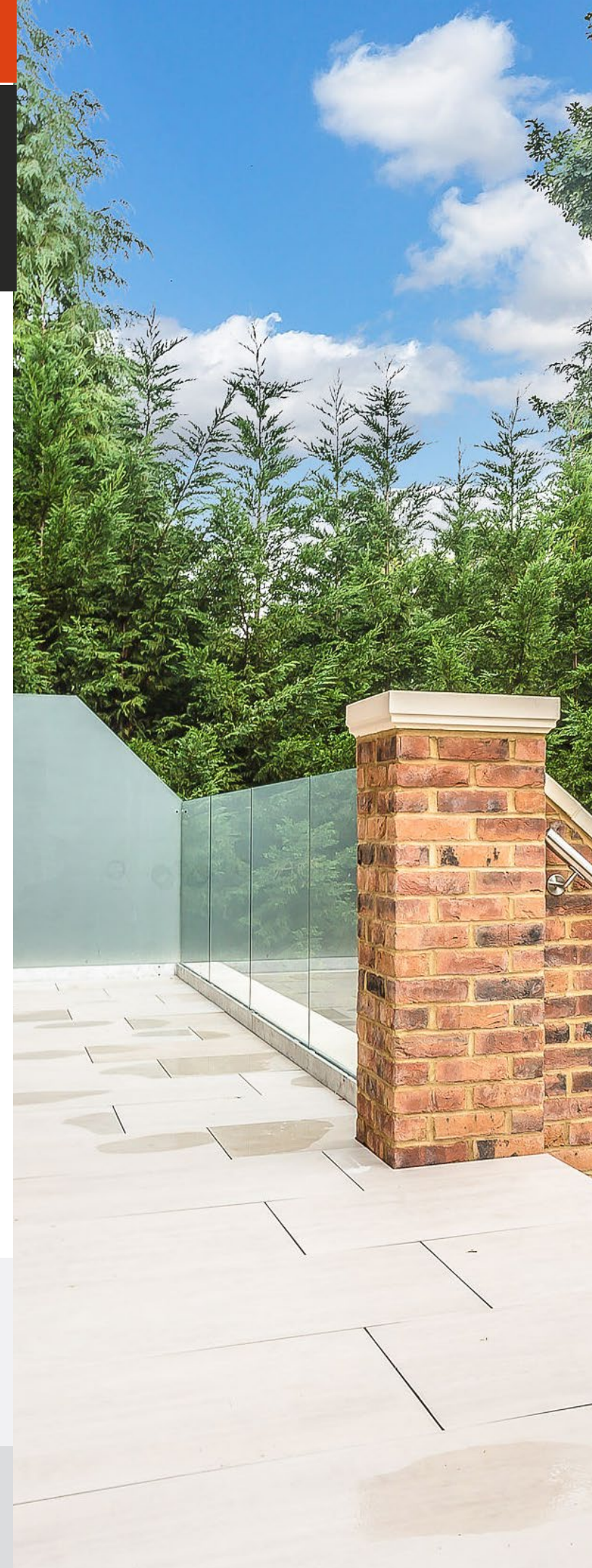

Technical Specifications

Material
 PCABS
 (Polycarbonate/Acrylonitrile Butadiene Styrene)

Biological/Chemical
 Resistant to moulds, algae, alkali, bitumen

Grating Dimensions
 400 x 450 x 38mm

Support Height
 82-1110mm (depending on specific requirement)

Coverage
 0.18 m² per grate

Weight
 1.814Kg per grate

Allowable load, uniformly distributed (UDL)
 Grating only (fully supported on solid flat surface): 52 kN/m²

Complete system (including gratings, support joists and pedestals): 7kN/m²

Allowable load, concentrated
 Complete system (including gratings, support joists and pedestals): 2kN/m²

RynoPave support grating quantity calculations

For help calculating the quantity of paving support grating and components you require, or for any other guidance regarding your project, call Ryno on:

01358 726000

RYNOPaveSupport™

Self-levelling Adjustable Paving Pedestals

The RynoPave self-levelling adjustable pedestal is unrivalled in its field.

Designed to support any type of calibrated paving, it offers the highest compressive strength of any pedestal system on the market.

Self-levelling support.

The unique self-levelling pedestal head and impressive height range will accommodate even the most complex paving issues - including sloping areas, drainage and maintenance access.

- **Unique self-levelling design offers slope correction up to 10.5%**
- **Ultimate compression strength for maximum durability**
- **Simple design ensures rapid installation**
- **For use with any type of calibrated paving - concrete, granite, porcelain, etc.**



Self-levelling paving support head

Due to its innovative self-levelling head design, RynoDeck has the fastest installation time of any pedestal system available.

- Utilises the 'ball & socket' joint concept to allow a free moving captive head
- Provides slope correction of up to 10.5% (6°)
- Lay paving or decking directly onto pedestals without manual slope correction
- Offers significant time savings and a perfectly level finished area
- Alternative head available to support decking

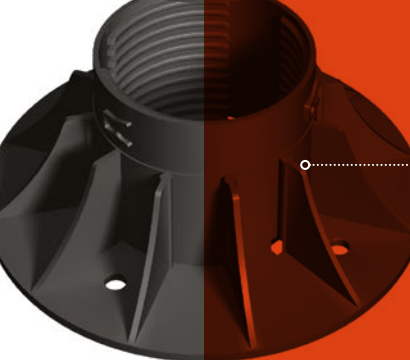
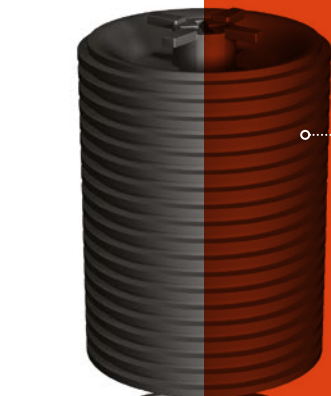
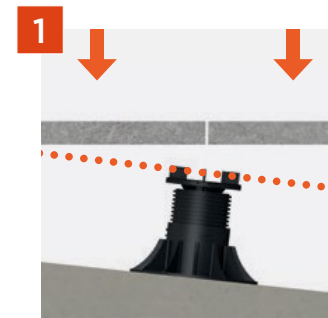

Adjustable threaded section

This heavy grade threaded section allows you to adjust the height in minute increments, within the given range. It's easy to adjust, simply grab and twist.



Height extension collar

A very simple design with a single 'click' motion to attach, these extension collars build up the pedestals in 100mm increments.



Wide supporting base

RynoPave creates an evenly spread load on the surface below, ensuring that membranes are well protected. Pedestals are loose laid and do not require fixing to the floor. Designed with water drainage holes to prevent moisture build-up.

RYNO PavSupport™ Self-levelling Adjustable Paving Pedestals

Size range

The vast height range of the RynoPave self-levelling adjustable pedestal allows it to overcome very large changes in surface level, and also conceal services, ductwork and pipes beneath the paving.

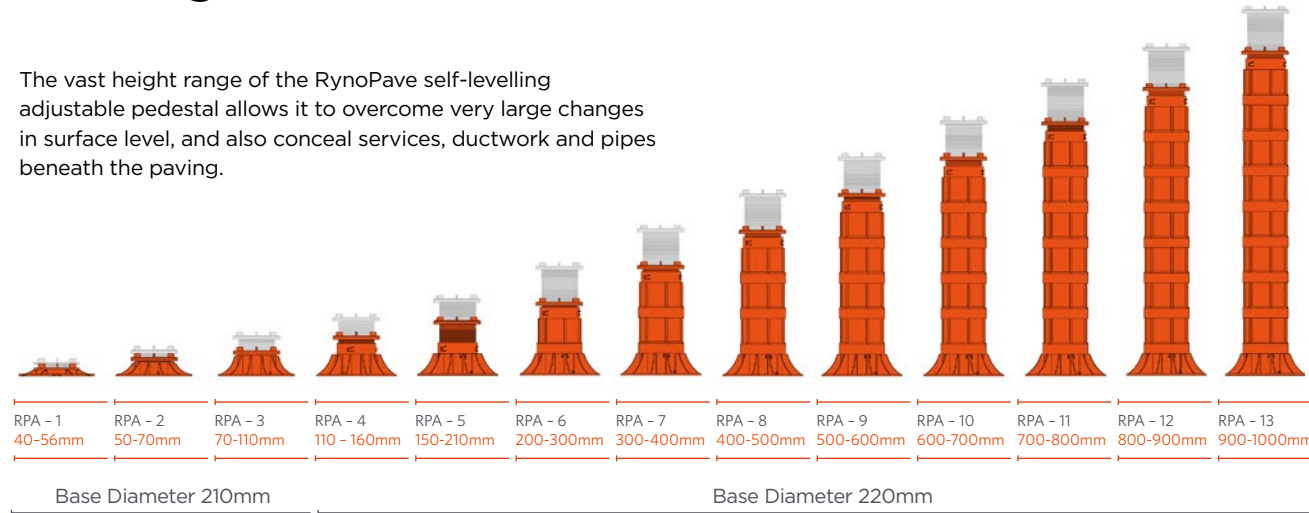

Optional components

- RPA-PS** Perimeter spacer tab
Ensures uniform spacing between perimeter slabs and wall abutment
- RPA-NRH** Non-rocking head
- RPA-FH** Flat head (no tabs)
- RPA-BRSP** Base rubber shock pad
Enhances acoustic performance and protection of the roof membrane
- RPA-HRSP** Head rubber shock pad
Enhances shock absorption and sound reduction. Perfect for lighter or harder paving materials, such as porcelain
- Spacer tab thickness options**
Standard: 4mm
Optional: 2, 6, 8, 10mm
- Pedestal adjustment key**
- Paving slab handler**
For slab sizes from 300 - 500mm

RynoPave pedestal quantity calculations

For help calculating the quantity of pedestals you require, or for any other guidance regarding your project, call Ryno on:

01358 726000

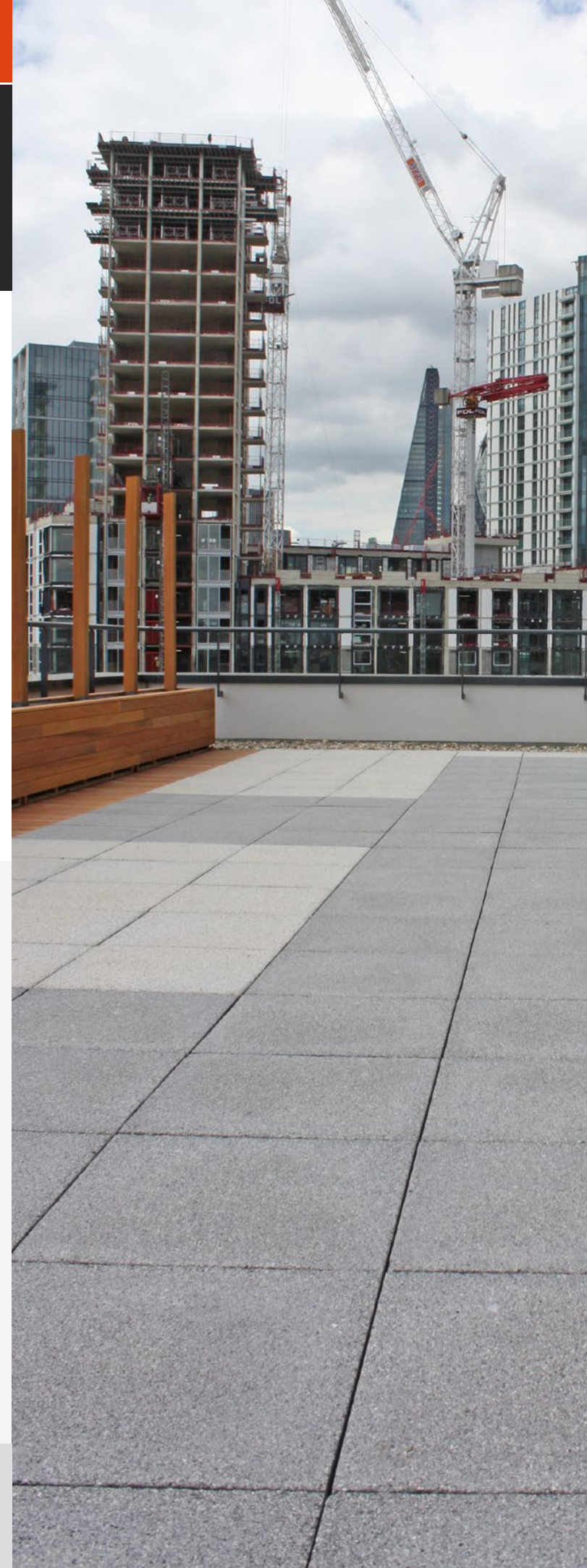

Technical Specifications

Material
PP Polypropylene (recyclable), UV resistant

Biological/Chemical
Resistant to moulds, algae, alkali, bitumen

Height range
40mm-1000mm

Compression
2100 Kg
(certified compression data available on request)

Base diameter
210mm / 220mm

Head diameter
130mm

Spacer tab thickness
2mm / 4mm (standard) / 6mm

Working temperature
-40°C - 120°C

RYNOPaveSupport™

Fixed-head Adjustable Paving Pedestals

The RynoPave fixed-head adjustable pedestal offers a high quality and economical option for supporting paving systems on completely level surfaces. Its impressive 22–550mm height range makes it perfect for areas with problematic height restrictions, as well as areas where greater height build up is required.

Support in any space.

With a simple but very effective design, this pedestal makes for a rapid and effortless paving installation.

- **Robust product ensuring stability of paving area**
- **Perfect for very low height installations; adjusts down to 22mm**
- **Accommodates all types of calibrated paving – concrete, granite, porcelain, etc.**



Paving support head

Due to its low profile design, the RPF support head allows this pedestal to go right down to 22mm height. The head utilises a clever connection which allows it to turn freely on top of the adjustable threaded section of the pedestal, meaning that the pedestal height can be adjusted once the paving is on top. Paving is spaced perfectly by the uniform spacer tabs.



Adjustable threaded section

The robust threaded section allows for incremental height adjustment within the given range. Effortless to adjust, simply turn the section by hand, even once the paving is in place.



Height extension collar

The extension collar adds 126mm of height by simply threading onto the base of the pedestal. This simple yet sturdy connection makes light work of supporting paving areas right up to 550mm. It is not necessary to determine how many of these extension collars are required; the correct quantity is supplied according to what pedestal size is chosen.



Support base

The broad base spreads the load on the surface below and ensures stability.

The pedestals are normally loose laid onto roofing membranes which must not be penetrated, or can be mechanically fixed to concrete or other substrates.

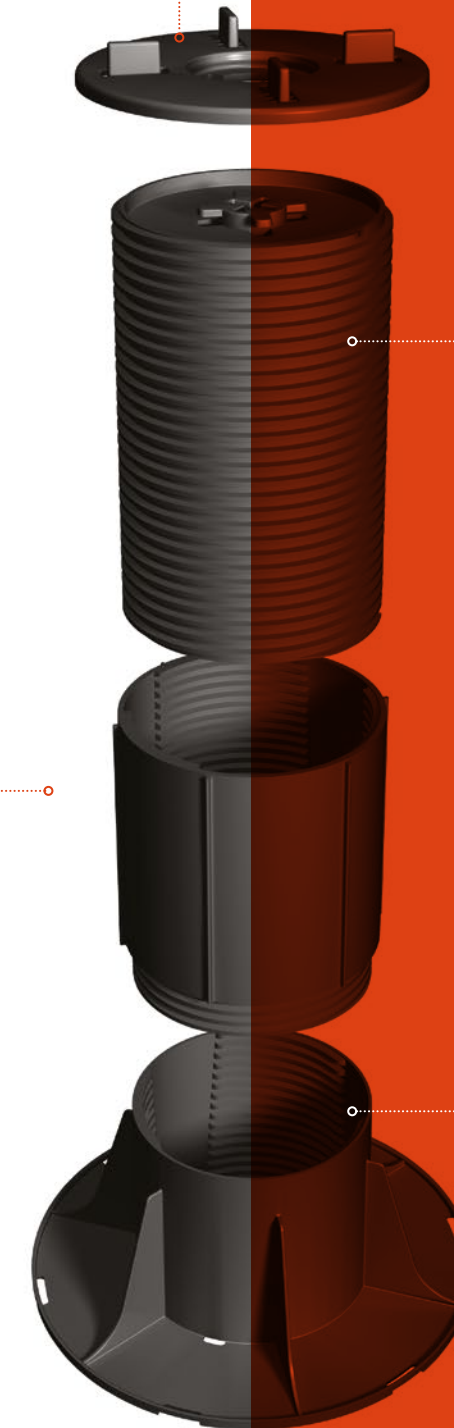

RYNO  **PaveSupport™ Fixed-head Adjustable Paving Pedestals**

Size range

The RynoPave fixed-head adjustable pedestal is the perfect solution where paving is to be supported on a totally flat area. Capable of supporting joists as low as 22mm off the surface, it will overcome the common problem of height restrictions, as well as quickly and simply elevating paving areas up to 550mm high.

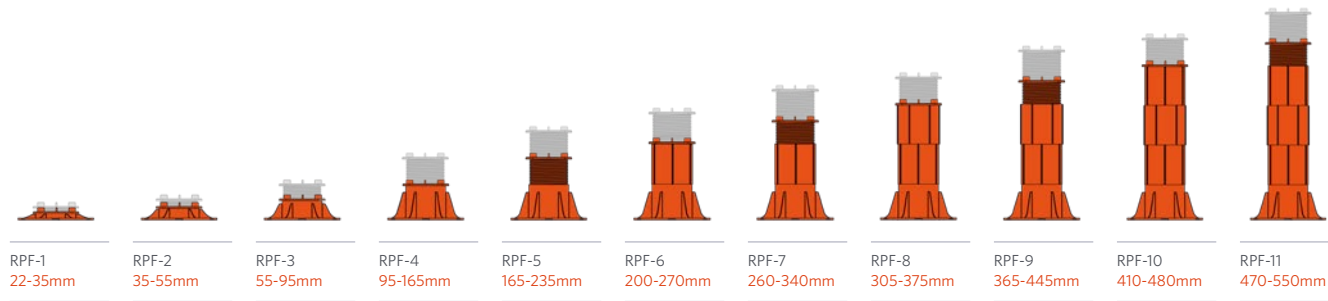

Optional components

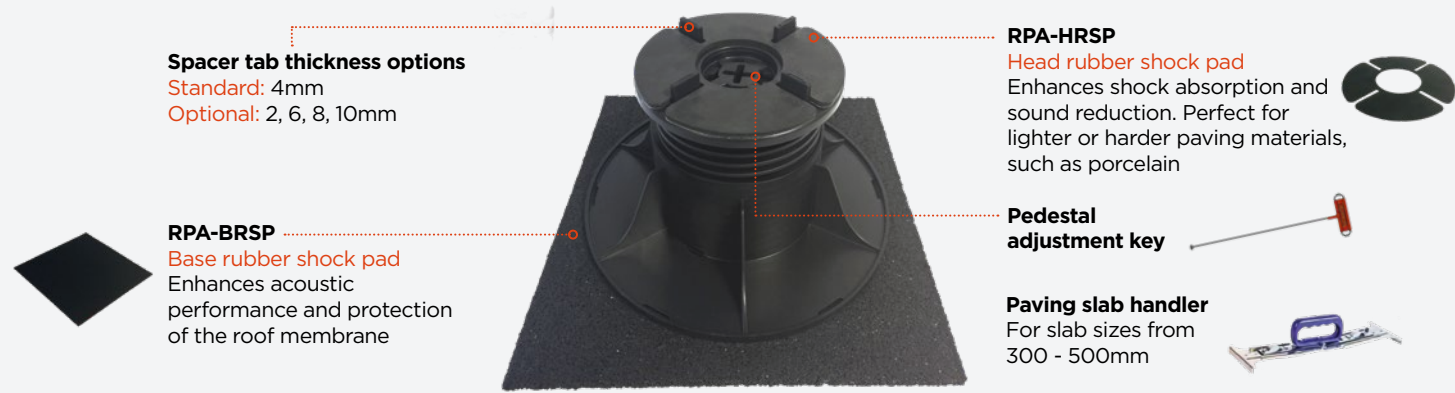

RynoPave pedestal quantity calculations

For help calculating the quantity of pedestals you require, or for any other guidance regarding your project, call Ryno on:

01358 726000



Technical Specifications

Material
PP Polypropylene (recyclable), UV resistant

Biological/Chemical
Resistant to moulds, algae, alkali, bitumen

Height range
22mm-550mm

Compression
1000 Kg

Base diameter
200mm

Head diameter
120mm

Spacer tab thickness
2mm / 4mm (standard) / 6mm

Working temperature
-40°C - 120°C

RYNOPaveSupport™

Stackable Paving Support Pads

RynoPave low height stackable paving supports are the perfect solution where paving requires elevating off the ground by a minimal height.

Strong, safe support.

Simple to install and adjust, they are a very economical method of creating a clear space below the paving, which allows for rapid water drainage.

- Supports very low paving applications, as low as 9mm
- Extensively used for ballasting the insulation on inverted roof systems
- Perfect for patio overlays/renovations
- Ideal for creating balcony decking areas
- Stackable, allowing for increased support height where required
- For low height applications

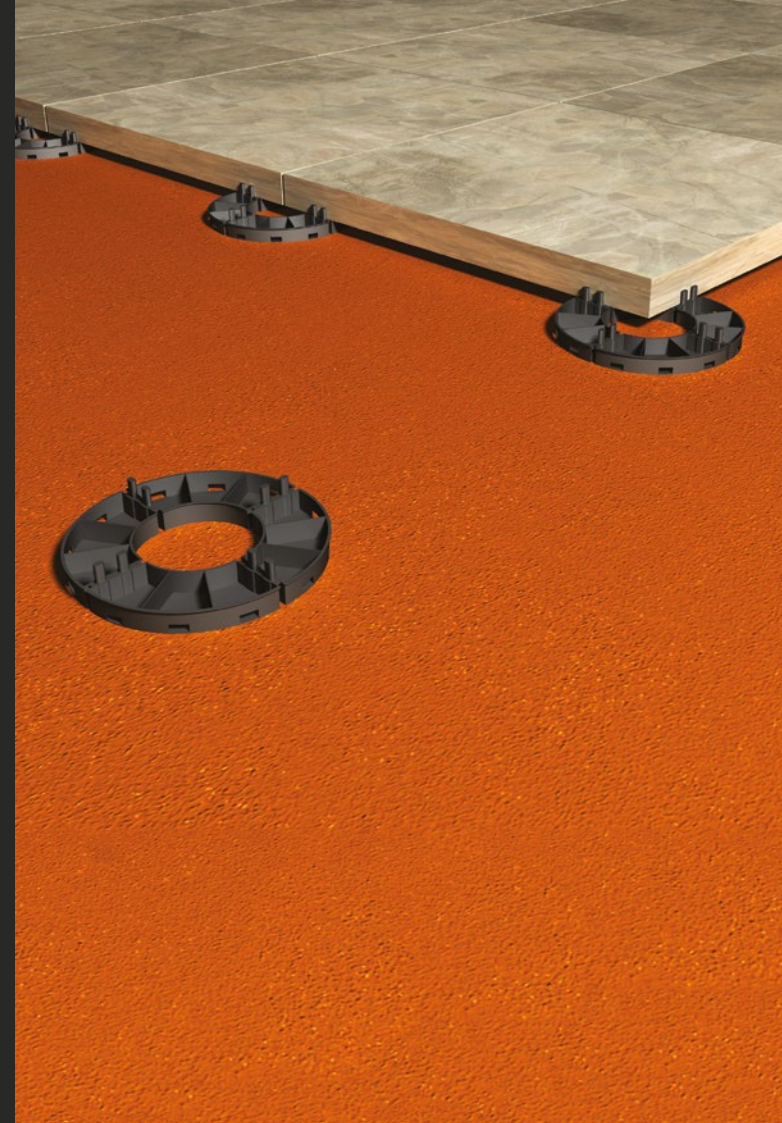

Stackable paving supports

RynoPave stackable paving supports create a perfectly uniform gap below the slabs, and can be stacked up to 3 units high.

Designed for use on totally flat surfaces, such as a roof area with 0° fall, and incorporating a 3mm shim which allows for finer height adjustment where required.



+ Rubber paving support

Rubber paving supports have increased shock absorbent properties, making them ideal for use with old or less durable membranes. Manufactured from solid rubber, they also have enhanced acoustic characteristics over the polypropylene options.



Adaptable height

Supports can be stacked and combined with shims to achieve the exact height requirement.



Snapping sections

Supports can be snapped into halves and quarters to support slabs at edges and corners.

RYNO  **PaveSupport™ Stackable Paving Support Pads**

Stackable paving supports



RPS-15
15mm
Stackable paving support



RPS-10
10mm
Stackable paving support



RPS-1 **RPS-2** **RPS-3**
1mm 2mm 3mm
Stackable paving support shims (For use in conjunction RPS-10/RPS-15, for fine height adjustment)

Rubber paving supports



RPS-9
9mm
Rubber paving support

RynoPave stackable support quantity calculations

For help calculating the quantity of stackable supports you require, or for any other guidance regarding your project, call Ryno on:

01358 726000



Technical Specifications

Stackable paving supports	Rubber paving supports
---------------------------	------------------------

Material

PP Polypropylene (recyclable), UV resistant

Rubber

Biological/Chemical

Resistant to moulds, algae, alkali, bitumen

Resistant to moulds, algae, alkali, bitumen

Height range

1mm - 51mm

9mm

Diameter

150mm

120mm

Spacer tab thickness

3mm

4mm

Working temperature

-40°C - 120°C



Ryno Ltd.
CastlePoint
Castle Way, Ellon
AB41 9RG

01358 726000
sales@rynogroup.co.uk
rynogroup.co.uk

 Part of the
Whitesales Group

RYNO  Deck[™]

RYNO  Pave[™]