



Natural red (600)



Multiblend (875)



Amarant (848)



Matt slate engobe (703)



Burgundy (882)



Matt slate engobe



Matt slate engobe



Amarant



Natural red



Your local Koramic stockist

Wienerberger Ltd.

Adswold Road, Cheadle Hulme,
Cheadle, Cheshire SK8 5QY

T: 0161 485 8211 | F: 0161 486 1968

office@wienerberger.co.uk | www.wienerberger.co.uk

Clay Roof Tiles. Designed for Living.



Vauban

Interlocking plain tile

Vauban

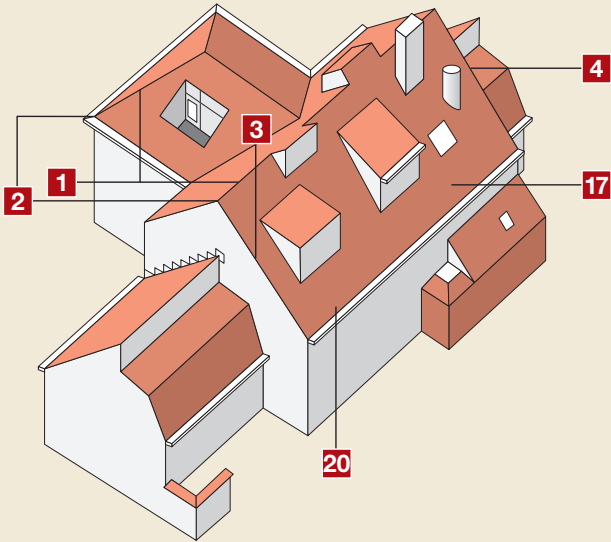

DIMENSIONS



Effective Cover Width

Length/Gauge	± 256-276 mm
Width/Gauge	± 168 mm

Overall Size

Length	± 366 mm
Width	± 202 mm

TECHNICAL DATA



Tiles are laid in broken bond

Model	Vauban
Minimum pitch	25°
Tiles/m ²	± 21.6 with max. batten spacing
Weight/tile	± 2.2 kg
Weight/m ²	± 47.5 kg
Crushing strength	> 900 N (EN538)
Water impermeability	≤ 0.50 cm ³ /cm ² .d (EN539-1)
Frost resistance	guarantee for 30 years
Batten size	50 x 25 mm (BS 1202)
Nails	copper, steel or aluminium alloy (BS 1202)

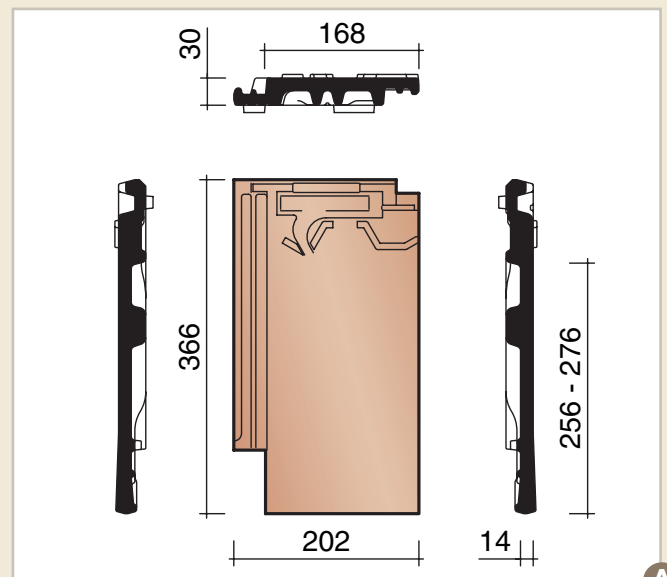

Manufactured to EN1304

ROOF DETAILS

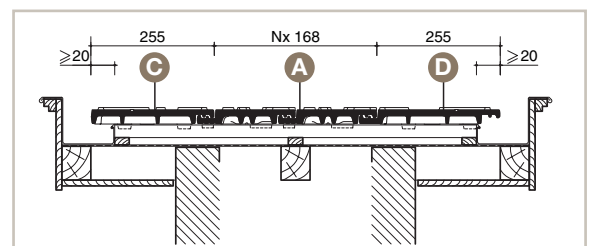
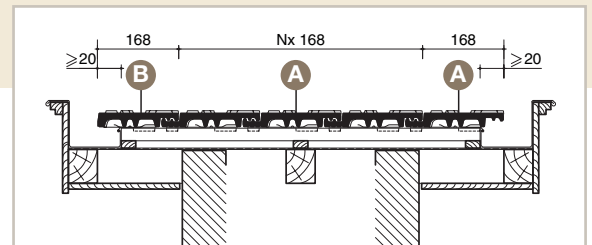
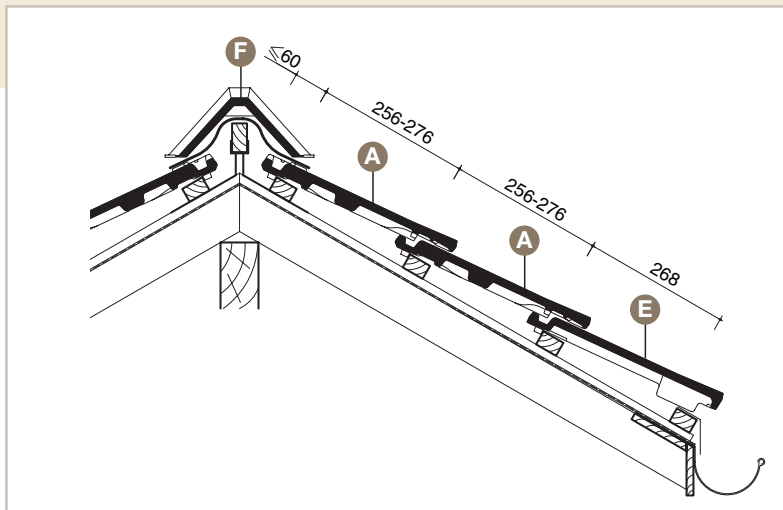
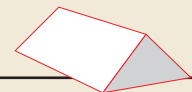

This document does not imply a contract. The colours used in this folder show the natural tint of our clay roof tiles subject to the limitations of the printing process. As clay roof tiles are natural materials, slight variations in colour may occur between batches of tiles, we recommend that they should be taken from several pallets at the same time and mixed at random on the roof. Wienerberger reserves the right to alter the range and the technical data. Dimensions are approximate.

RIDGE, VALLEY AND HIP TILES

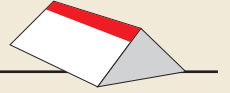

Ventilated angular ridge

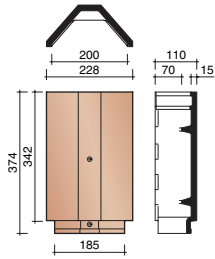

Ref. No. 2800

F 1

Ventilated angular begin ridge

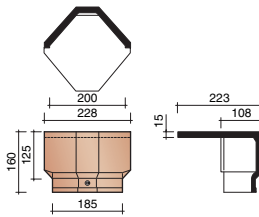

Ref. No. 2810

2

Ventilated angular end ridge

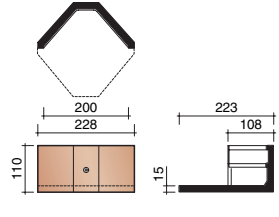

Ref. No. 2820

2

Ventilated angular end hip tile

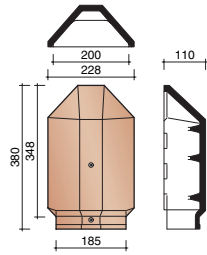

Ref. No. 2860

2

VERGE & VARIOUS FITTINGS

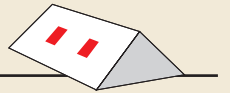

Left tile and a half without interlocking

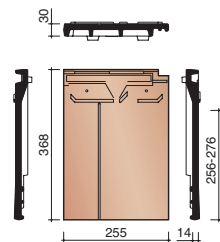

Ref. No. 8070

C 3

Left tile without side interlocking

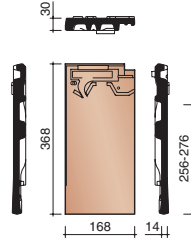

Ref. No. 8050

B 3

Right tile and a half

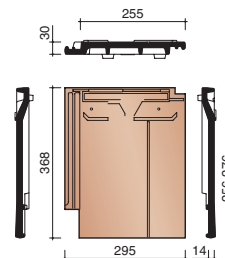

Ref. No. 8080

D 4

Ventilation tile with synthetic grid

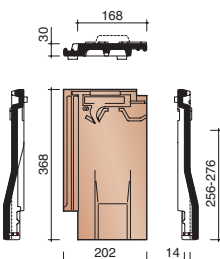

Ref. No. 8640

17

Eave ventilation tile

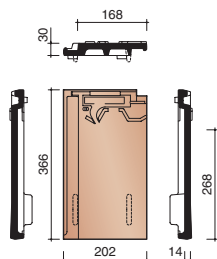

Ref. No. 8690

E 20

Integrated vent tile

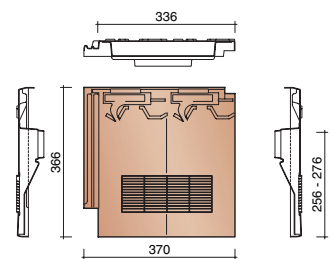

Ref. No. 9770

17



Amarant



Burgundy