

castle
COMPOSITES

RAPTOR SERIES

FOR
JOISTS

FROM
ALLUMINIUM



FROM
WOODEN



FROM
COMPOSITE



castle
COMPOSITES

www.castlecomposites.co.uk
sales@castlecomposites.co.uk

Castle Composites Ltd
Nisbet Way, Ravenstruther
Lanark ML11 7SF UK
+44 01555 870 019
+44 01555 870 003

100%
MADE IN EU



castle
COMPOSITES

ADJUSTABLE PEDESTALS

FOR WOODEN OR COMPOSITE DECKING



www.castlecomposites.co.uk

RAPTOR SERIES

15-245 MM

A new generation of wedge adjustable height pedestals for use under joists.

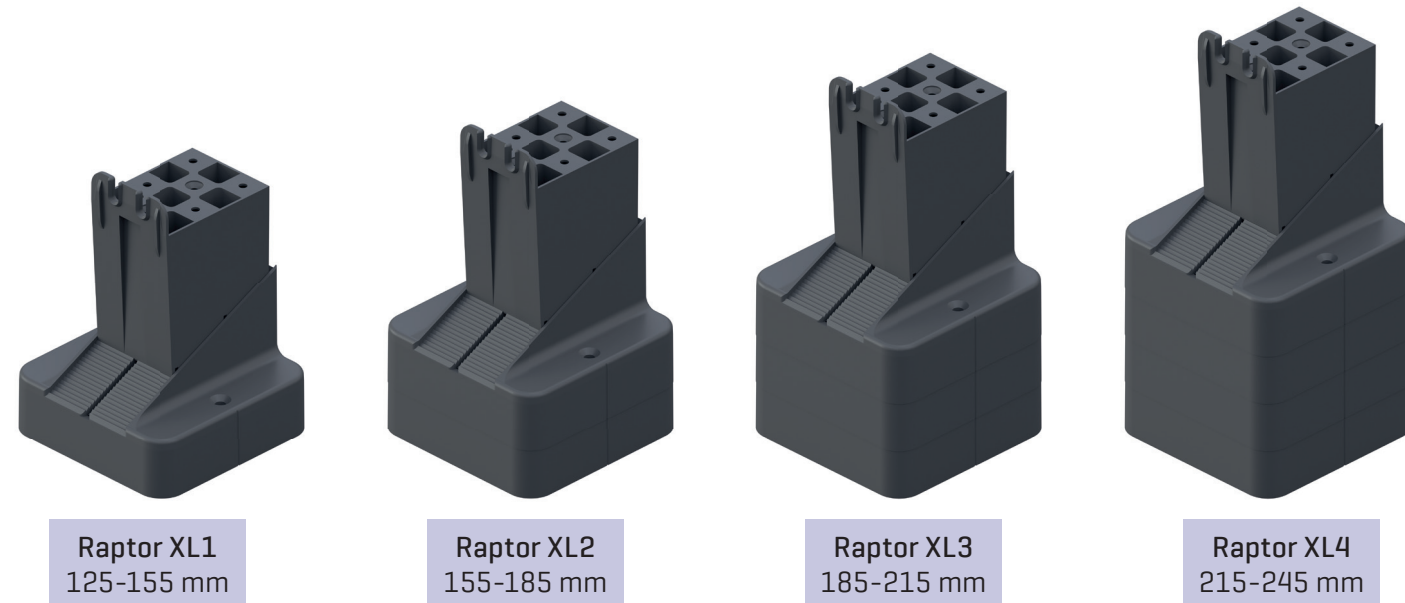
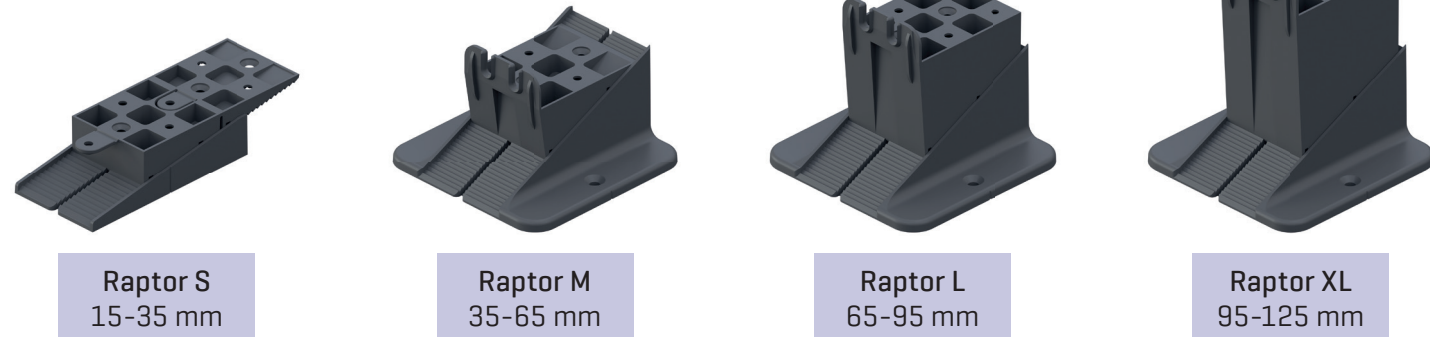
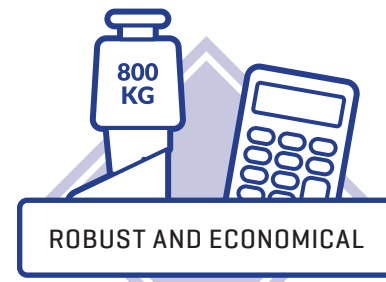

- FASTER ASSEMBLY**
The simple design of the locator for side mounting of the joists significantly reduces installation times.
- STRENGTH**
Load capacity 1000 kg*
- PRECISION OF REGULATION**
Stepped height adjustment every ~1 mm

- UNIVERSAL**
For outdoor terraces and indoor floors under aluminium, composite and wooden joists.
- LOW HEIGHTS**
Adjustment range from 15 mm
- SLOPE CORRECTOR**
Smooth slope regulation to 7%



Basic elements set

Wedge S

Can only be connection with bottom wedge S.

Bottom wedge S

To be connection with wedge S and with supplementary elements if required.

Wedge M / L / XL

To be connection with wedge L.

Bottom wedge L

Connected to one of the M, L or XL wedges, it creates adjustable pedestals with various adjustment ranges. It can be combined with complementary elements as needed.

Wedge raiser 30 mm

Raises the adjustable pedestals. It can be connection with other bottom wedge, maximum 4 pcs in one adjustable pedestals.

Elements extending the possibilities of using the system:

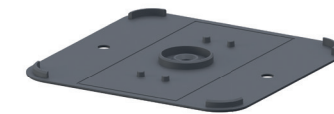

Protection pad

For use on sensitive surfaces such as roofing felt, XPS, waterproofing, etc.



Slope corrector

Necessary on surfaces with significant slopes. It compensates for a 7% slope.

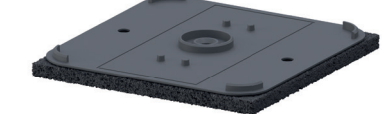

Sound reduction pad

It creates additional sound insulation and increases the comfort of using the terrace or the floor.

Thoughtful and refined design

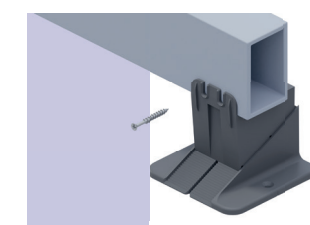

Easy and quick installation thanks to the adjustable pedestals for the side mounting of the joists.

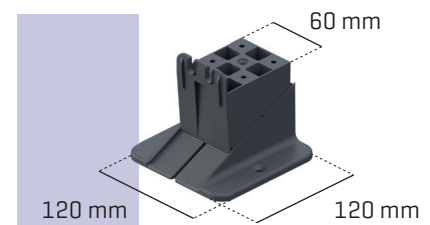

High support stability is ensured by the largest sizes of the ottom wedge and the wedge on the market.

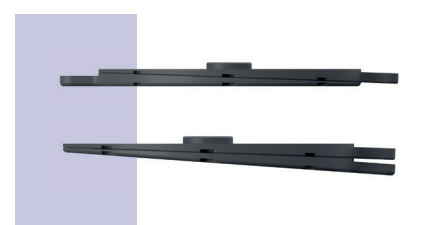

Recommended on surfaces with significant slopes.



Easy stiffening of the adjustable pedestals by means of screws in prepared mounting holes.

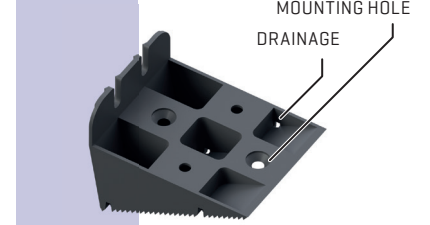

All elements of the system have mounting holes and water drainage holes.

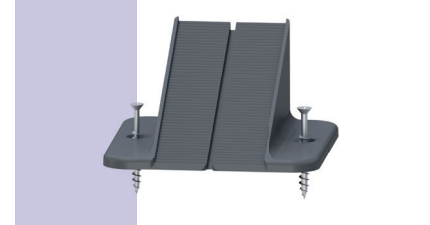

Mounting holes for optional attachment to the ground.

* Detailed values for individual heights are given in the technical specification.

