



Wall Mount Front Load Washing Machine 2.5KG



User Manual

Contents

Safety Precautions	2
Installing the Washing Machine	6
Inspection and preparation before washing.....	9
Using methods of detergents and additives	11
Operation steps	12
Overview of the control panel.....	13
Maintaining the washing machine	16
Drum clean	16
Cleaning the enclosure	17
Cleaning the water supply valve filter.....	18
Handling a frozen washing machine	19
Storing the washing machine	19
Troubleshooting	20
Product Specifications	23
Program Control Board	24

Safety Precautions

Important Safety Symbols and Precautions. Please read this manual carefully before using the product and keep it properly.

Please read the instructions carefully and perform operation with caution and care when installing, maintaining and operating your washing machine to make the most of functions and extend the service life of the machine. We are not liable for damages resulting from improper use.

Meanings of icons and symbols in this manual:



CAUTION: Hazards or unsafe practices that may result in personal injury or property damage.



ATTENTION: To reduce the risk of fire, explosion or personal injury when using your washing machine, follow these basic safety precautions.



WARNING: Hazards or unsafe practices that may result in severe personal injury, death or property damage.



Do NOT try, otherwise it may result in personal injury or damage to objects.

Make sure that the pockets of all clothing to be washed are empty. Do not wash the clothing with hasp or other heavy metals.

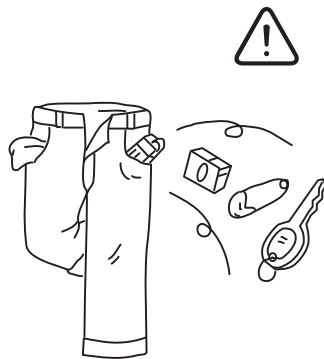

The washing machine shall be installed on a solid wall. Otherwise, abnormal vibration or noise may occur.

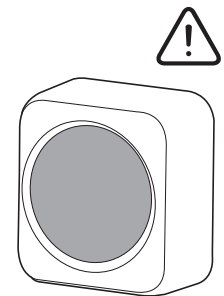

Please use the new hose assembly provided and do not reuse the old hose assembly.

Check the expansion, kink, breakage, wear and tear as well as the leak of the hoses periodically, and replace them promptly when there is something wrong.

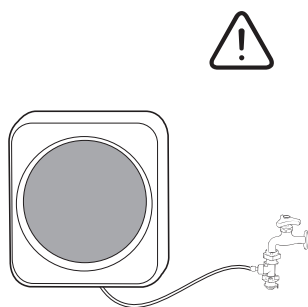

No use of highly acidic cleaner. Do not put gasoline, alcohol, dry cleaners or other flammable and explosive substances into the washing machine as detergents.



Safety Precautions

If the supply cord is damaged, it must be replaced by the manufacturer, its service agent or similarly qualified persons in order to avoid a hazard.

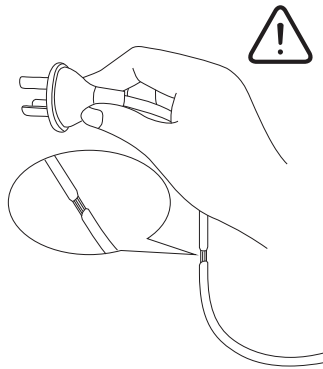

In case of gas leakage, do not touch any button; unplug the power cord and open the window for ventilation; otherwise, sparks may be triggered, thus resulting in explosions, fires or burns.

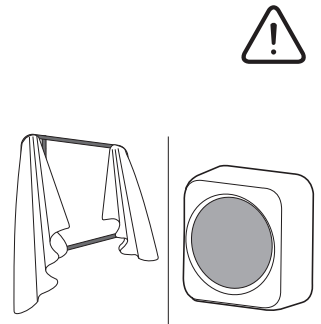

Please prevent pets or other animals from entering the drum of the washing machine, which may cause injury.

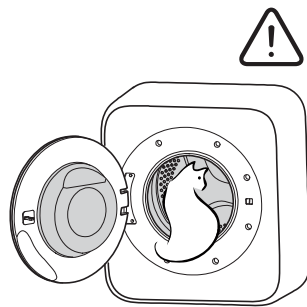

When the door is locked, do not open it by force. Otherwise, the door or the lock may be damaged, thus resulting in technical fault.



If the power cord pins are covered by dust or get wet, wipe them clean with dry cloth before use; otherwise, a fire may be caused.

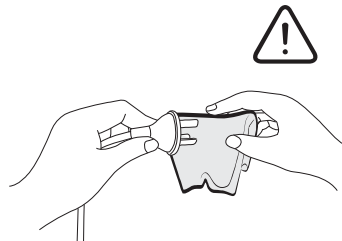

Do not use the washing machine but contact the service center when it is tilted or unbalanced.

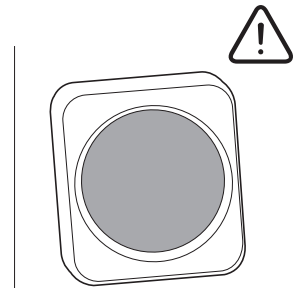

The appliance is not to be used by persons (including children) with reduced physical, sensory or mental capabilities, or lack of experience and knowledge, unless they have been given supervision or instruction.

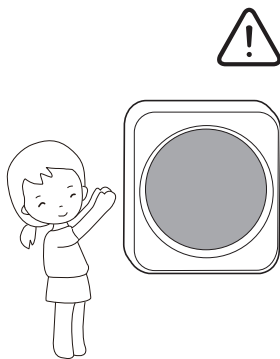

Children being supervised not to play with the appliance.

In case of abnormal power failure, please open the door cautiously because the user may be scalded if water temperature inside the cylinder is high.

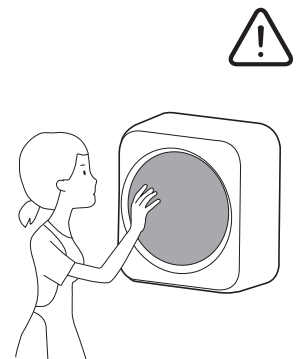

Safety Precautions

Please unplug the washing machine before performing maintenance, cleaning or repair.

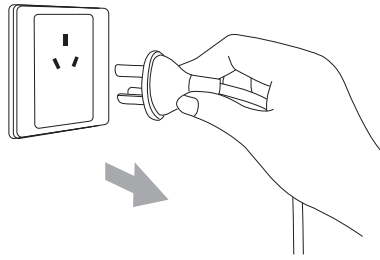

Do not spill water on the washing machine as this may cause a short circuit or electrical shock.

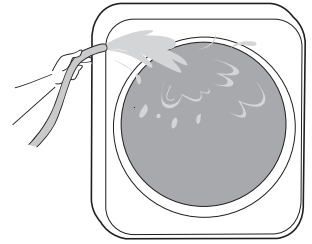

Do not put the magnet near the washing machine when the machine is running.

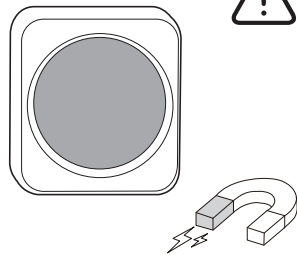

Always unplug the washing machine and turn off the water supply faucet after use.

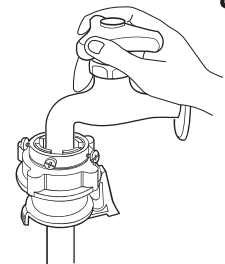

Wipe the washing machine enclosure, including the control panel, with a soft cloth and nonabrasive household detergents.

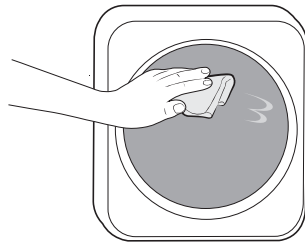

Do not place the washing machine in damp places such as the bathroom or rainy area, since it may cause electric shock or fire.

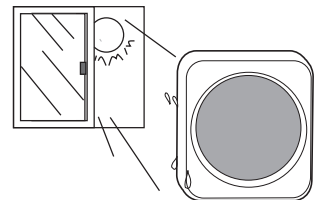

To guarantee your safety, use the three-core socket and check to ensure it is grounded accurately and reliably. (The washing machine has been equipped with a three-core socket.)

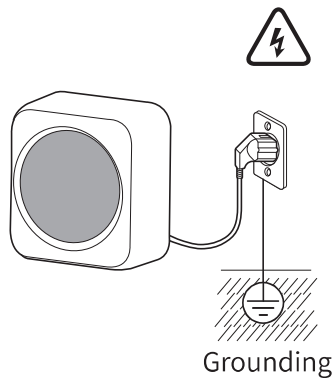

Please exclusively use 230-240V, 50Hz, 10A and above professional AC power outlet.

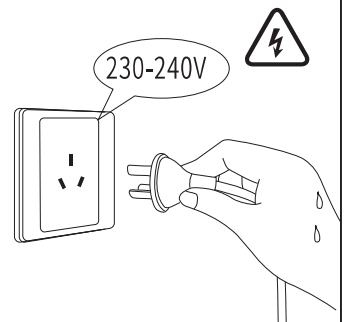

Safety Precautions

Do not allow the washing machine to contact or close to heat source, open fire (such as mosquito coil, candle, cigarette, hair dryer, etc.).

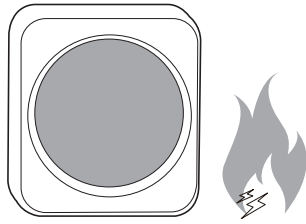

Please open the faucet before use to check whether there is water leakage; otherwise, water leakage will be caused.

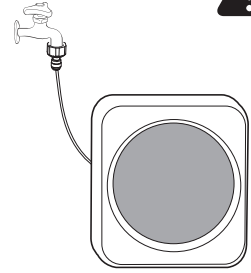

Do not plug in / out with wet hands, since this may cause electric shock hazard.

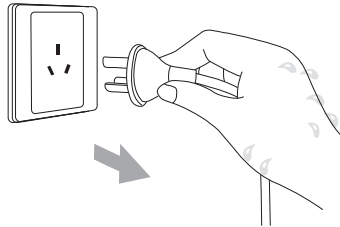

If the washing machine does not run, smokes or emits abnormal smell, please cut off the power immediately and contact the service center; otherwise, it may lead to electric shock, short circuit or fire.

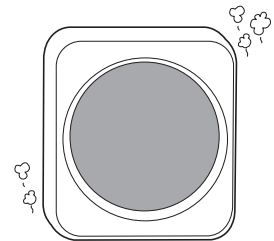

Close the door properly and prevent any clothes from getting stuck; otherwise, the clothes may be damaged or fault of the machine may be caused.

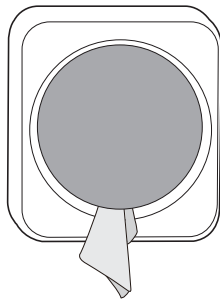

Do not attempt to repair the washing machine by yourself. Repairs made by inexperienced or unqualified persons may make more serious damage to the washing machine and cause personal injury.

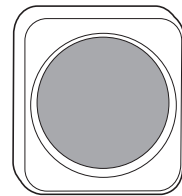

The appliance must not be supplied through an external switching device, such as a timer, or connected to a circuit that is regularly switched on and off by a utility.

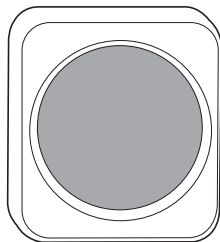

That the appliance must not be installed behind a lockable door, a sliding door or a door with a hinge on the opposite side to that of the tumble washer, in such a way that a full opening of the tumble washer door is restricted.

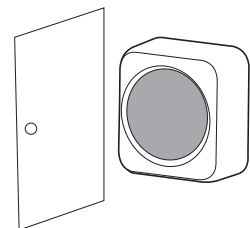

Installing the Washing Machine

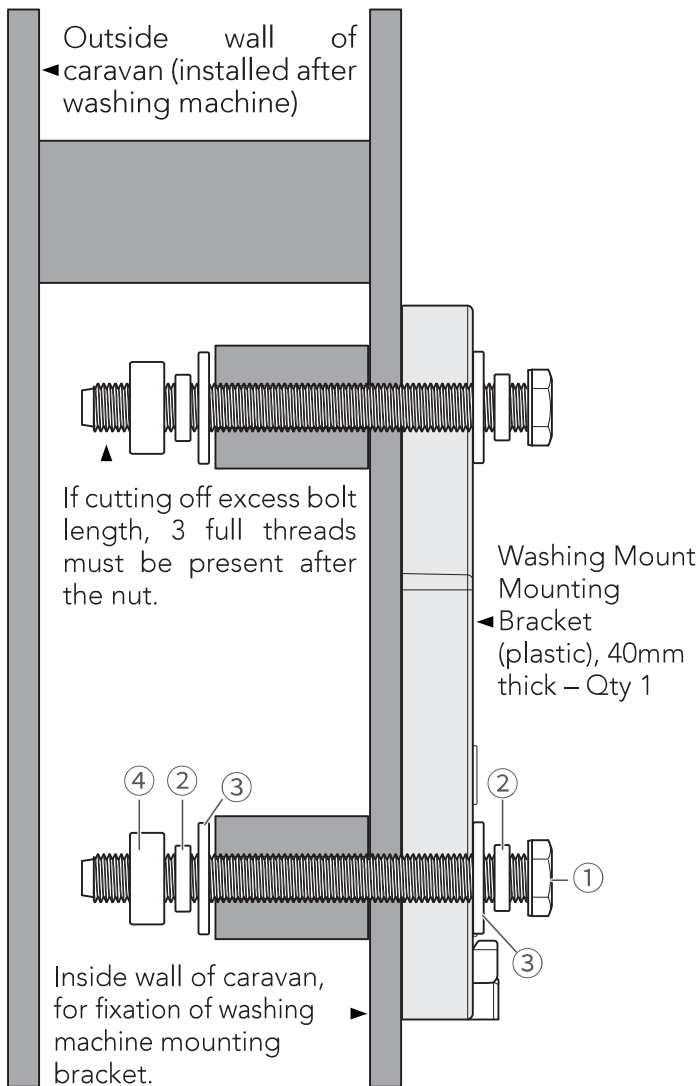

①-M12, 120mm Hex Head Bolt – Qty 6.

②-M12 Spring Washer – Qty 12

③-M12 Washer – Qty 12

④-M12 Nut – Qty 6

Note: The fastener (bolt & nut) must clamp against solid timber, with no airgaps, otherwise a soft joint could result in the bolt or nut coming loose.

M12 Bolt torque: 60Nm – 85Nm*. All 6 bolts should be used for the installation. If the bolts are too long, excess length can be cut off once the fastener is torqued up correctly. Any cutting must leave 3 full threads, exposed past the nut.

This system is designed for mounting the 2.5kg Camec Wall Mount Washing Machine to structurally sound caravan walls that are 20mm - 65mm thick.



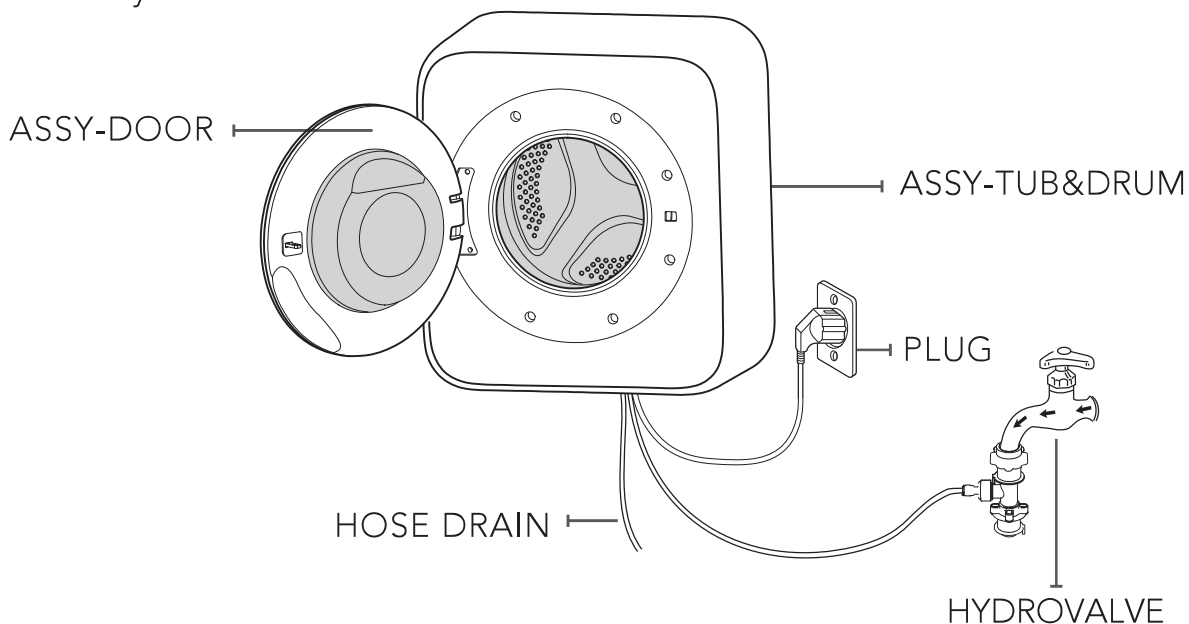

The washing machine must only be mounted to structurally sound caravan walls that are fit for purpose. Care should be taken to ensure adequate clearance to wiring or plumbing when installing the washing machine.

Installing the Washing Machine

Unpack your washing machine and inspect it for shipping damage. Also make sure that you have received all items shown below. If the washing machine was damaged during shipping or you do not have all items, contact Camec National Customer Support Team immediately.

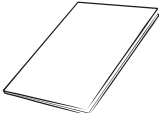
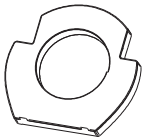
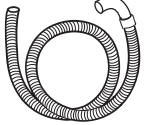

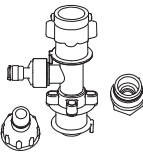
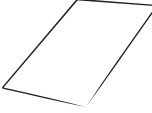
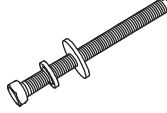
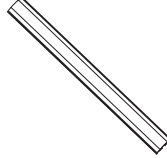
Accessories

MANUAL-BOOK(X1)	ERECTING FIXTURE(X1)	ASSY-HOSE DRAIN(X1)
		
WATER SUPPLY HOSE(X1)	THREE-PORT VALVE(X1)	INSTALLATION GUIDE(X1)
		
SET BOLT(X8)	TRUNKING(X1)	BAND-RING(X1)
		

Installing the Washing Machine

Power supply

- To avoid the unnecessary risk of fire, electric shock or personal injury, all electrical circuit and grounding must be set as per the national electrical standard.
- Do not overload the wall power socket or the extension cord.
- When the heating function is used, the maximum current of the washing machine may reach 10A. Ensure that your power supply unit (current, voltage and cable) can meet the normal load requirements of the appliance.
- Protect the power cord.
- The power cord has to be positioned so that it will not be stepped on, pressed or clamped by the article on or next to it. Pay special attention to the power cord of plug, socket and power cord contact of the appliance.

Water supply

- The working water pressure of the washing machine is 0.05MPa-0.8MPa. When the water pressure is below 0.05MPa, the water supply valve may not work normally, or the time of water supply is longer than that of program control, and the display screen shows "SF".
- The washing machine shall be close to the water faucet.
- Check water leakage conditions of the internal loop regularly.
- Before using the washing machine, first check all connections of the water supply valve and water faucet to prevent water leakage.

Ambient supply

- Avoid direct sunlight, with adequate ventilation.
- Room temperature shall not fall below 0 °C.
- Away from sources of heat such as coal or gas stove.
- The washing machine cannot be positioned in a place where water freezes easily, because some water may be left in the water valve, drainage pump and water pipe. Freeze in the pipeline may cause damage to the belt, drainage pump and other parts.
- Your washing machine should be positioned in the environment with ambient temperature of 0°C~40°C and relative air humidity below 95% (when the temperature is 25°C), thus the washing machine can be used in a convenient and safe way.

Inspection and preparation before washing

To prevent the fault of washing machine and the damage to laundry, you have to pay attention to the following items.

1. Take objects out from the pocket.

- Please check and empty the pockets of the laundry. Such hard objects as decorations and coins may damage the washing machine or result in abnormal fault.
- Remove all objects from pockets such as lighters and matches.

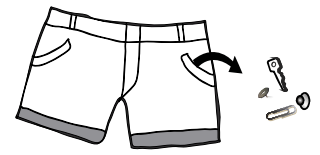

2. You had better wash such easily soiled parts as white stockings, collars, cuffs in advance.

- You had better wash such easily soiled parts as cuffs, collars and pockets with a brush before machine washing.
- Please use powder or liquid detergents. Soap residues may remain in the seams of the clothes or in the washing drum when washing with soaps.

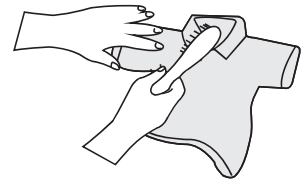

3. Clean dust, sludge and hairs of the pet attached on the laundry.

- Friction of dust and sludge with the laundry may damage the clothes and affect washing results.

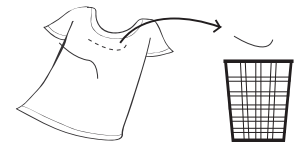

4. To protect the skin of the baby.

- Baby's laundry (baby's clothes and towels) such as diapers shall be washed separately. Try to avoid washing with the laundry of adults.



5. Before washing the laundry, take off the metal decorations and zip up the laundry, buckle the collar, then turn over the laundry.

- Before washing jeans and overalls with such hard objects as zippers and buttons, the buttons shall be buckled. Winter jacket, overalls, bedspread, jeans etc. shall be washed separately.
- Clothes shall be straightened out before putting into the washing machine; curtains with hooks shall be washed after the hooks are taken off. Laundry with buttons or embroidery shall be washed after the laundry is turned over.
- Please take off the decorations on the clothes before washing since they may damage the laundry. All kinds of belts shall be properly tied since they may twine other laundry.



Inspection and preparation before washing

6. Cottony laundry shall be turned over before washing.

- Cottony laundry shall be turned over and washed separately, or other laundry may be stained with dust, thread ends, etc.
- Before washing, please check that if black laundry and cottons are turned over and washed separately since they are easily stained with thread ends of different colors when washed together.

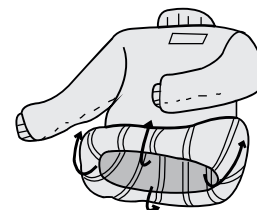

7. Before washing, please confirm if there are stains on the laundry.

- Do not place the laundry in the washing machine for a long time since they may get mildew and stains.
- Confirm if the laundry washed for the first time are fading. Wipe the inconspicuous tails of the laundry with a white towel stained with detergent to see if the towel is dyed with the color of the laundry.

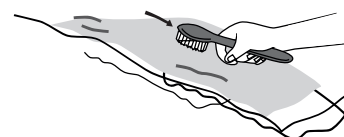

8. Don't wash clothes contaminated with chemicals such as gasoline, petroleum, benzene, thinner and alcohol.

- Do not wash the soaked clothing stained with gasoline or other flammable, explosive and toxic solvent, for the clothing aforesaid will release the substance that may cause fire or explosion.
- Hazardous substances include acetone, alcohol, gasoline, kerosene, certain liquid household cleanser and detergent, turpentine, wax and wax remover.
- Do not use the strong acid cleanser.
- Do not put gasoline, alcohol, dry cleanser or other flammable and explosive substances into the washing machine as detergent.
- Select the household detergent available on the market and applicable to machine wash only.
- Fabric softeners, or similar products, should be used as specified by the fabric softener instructions.

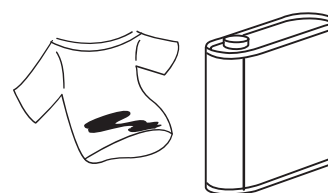

Using methods of detergents and additives

The user shall pour detergent from the mouth of the drum into the washing machine as required. Should the softener be used, please pour the softener into the drum after the washing procedure. Choose "rinse + spin" or other procedure to wash again.

Fabric softeners, or similar products, should be used as specified by the fabric softener instructions

Note:

1. Use "low foam" detergent specific to the drum washing machine.
2. For the details about the usage of washing powder and detergent, please refer to the instruction of the brand.
3. For clotted and viscous detergents or additives, dilute with a small amount of water before pouring into the washing machine.
4. Please select only household detergent sold in the market that is suitable for machine washing.

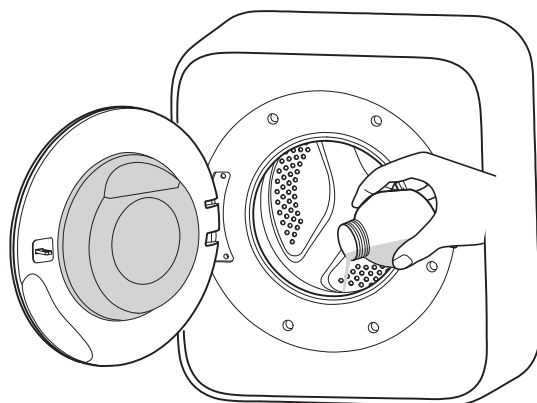

Operation steps

- ① Connect the water inlet, place the drain pipe and turn on the faucet.

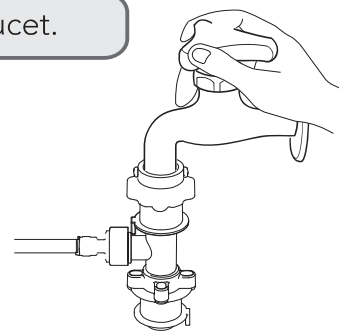

- ② Power on.

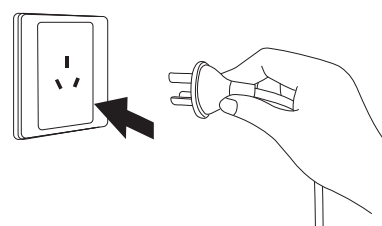

- ③ Open the machine door to put clothes in, add detergent into the drum and then close the machine door.

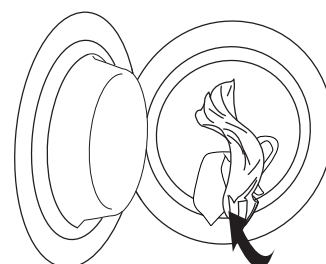

- ④ Press the power button to start up, select the washing procedure and then press the [Start/Pause] button.

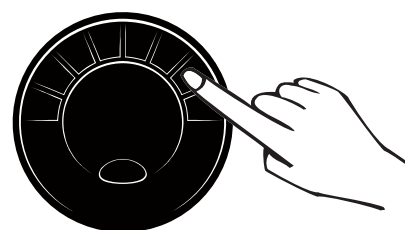

- ⑤ After washing, open the door to take out clothes.

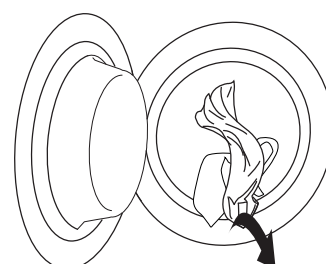

Overview of the control panel



Program mode buttons



Cotton

Suitable for daily mixed washing of cotton, linen and chemical fiber clothing. The Cotton program is for a normally soiled cotton load at rated capacity. Cotton is the recommended washing program of choice for users.



Quick

Suitable for washing slightly soiled laundry that is worn only once or needs washing a little, has a special smell.



High Temp.

High temperature sterilization, up to 58°C, not recommended for clothes likely to fade.



Baby care

Suitable for washing ordinary baby clothes, able to remove common stains.



Delicates

For care of delicate clothing items, it is not recommended to wash together with other clothes. Strap on the back hook before washing.



Spin

Perform the spin procedure only and spin dry excess water from the clothes.

Overview of the control panel



Drum clean



Rinse+Spin

This program is designed to clean the inner drum of washing machine to keep it sanitary (no clothing shall be added when this program is used)

Suitable for clothes for which only rinsing is needed or clothes requiring rinsing with softener.

Icons

Child lock

Child lock function prevents change of the washing machine due to children's wrong operation so that the washing procedure can be normally working.

Child lock setting method

Press the appointment button for 3 seconds to choose this function. At the same time, indicator light will light up.

Note: press this button to prevent running of the washing machine operated by children.

When the washing machine is running, set the child lock function; then, all functions except for the power supply cannot work.

Voice/ mute

If this icon is on, the device will not output any sound.

Setting method: press "Rinse" for 3 seconds to start or close the mute function.

Door lock

When the door lock is in the closed state, the icon is on; when the door lock is in the open state, the indicator icon is off.

18:00

Time display area shows remaining time and delay time.

Note: the remaining time reduces gradually with washing;

If abnormality occurs during washing, corresponding code will be displayed;

If the remaining time is inconsistent with the actual time, it is a normal adjustment made by the program based on actual conditions rather than a fault.



Working process: Corresponding icon flash during operation.

Overview of the control panel

Function buttons

Delay

Press the button repeatedly to cycle through the available preset options (from 1 hour to 24 hours in one hour increments). The washing cycle will be finished in the displayed hours.

Setting method of Delay:

- Select a washing program according to the type of clothes you are washing.
 - Press the Preset button repeatedly to select your desired preset time.
 - Press the Start / Pause button. The clock will begin counting down until it reaches your finish time.
- If the preset time is set to 6 hours, the washing program will be finished completely after 6 hours.

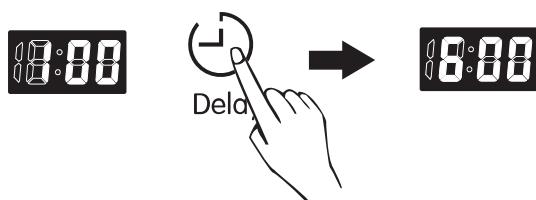

1. Press the Delay button, time displaying "1:00";
2. Continue pressing the Delay button five times in succession, time displaying "6:00";
3. The washing will be finished 6 hours later.

Method of cancellation: press the power button or change to another washing procedure to exit from this function.

Note: The delay function is unsuitable for clothes that are easy to produce static electricity.

Set the delay time at first, then press the "Start / Pause" button to display the remaining time.

If the washing procedure time is less than 1 hour, the appointment time can be ranged from 1 hour to 24 hours; if the washing procedure is of 1-2 hours, the appointment time can be ranged from 2 hours to 24 hours.

Temp. button

The set temperature will be displayed at the temperature display area. Select the appropriate water temperature based on the clothes to be washed.

Power button

Turn on/off the washing machine by pressing this button. If the washing machine is kept unused for 10 minutes after power on, the power supply will be shut off automatically.

Start/pause button

When the washing machine is powered on, select the required washing procedure and press this button to start the washing machine.

If the washing procedure needs to pause, press this button to suspend the machine and press it again to resume work.

Rinse+

Repeat this button to add the number of times for rinsing.

This function may be set before starting the procedure. This function can be set before the program starts and cannot be changed after the program starts.

Maintaining the washing machine

Keep the washing machine clean to enhance the performance, avoid unnecessary maintenance and increase the service life.

Drum clean

This is a drum auto clean program and can remove the possibly bred mould in the drum.

1. Turn on the water supply faucet.
2. Add appropriate amount of detergent into the drum.
3. Touch the screen and select the self-cleaning procedure.
4. Press start/pause button and the self-cleaning procedure will start.

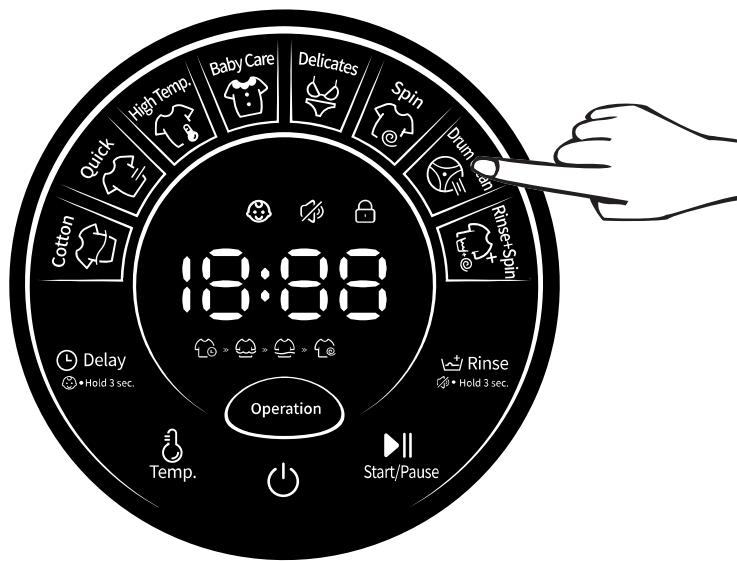

In the drum clean procedure, no clothes can be added in the drum.



Precautions for self-cleaning function:

- When you need to clean the drum by detergent, only dedicated detergent can be used.
- The Drum clean program cannot be used when there are clothes in the washing machine, or the laundry or machine may be damaged.
- Only one tenth of drum cleanser amount recommended by the manufacturer shall be used for the sake of environmental protection.
- Bleach containing chlorine may fade the laundry; be sure to use oxygen bleach only.
- Powder cleanser: Please use powder bleach or the cleanser specialized for the inner drum of the washing machine.
- Liquid cleanser: Please use liquid oxygen bleach or the cleanser specialized for the inner drum of the washing machine.

Maintaining the washing machine

Cleaning the enclosure

- Before cleaning the washing machine, the machine shall be unplugged.

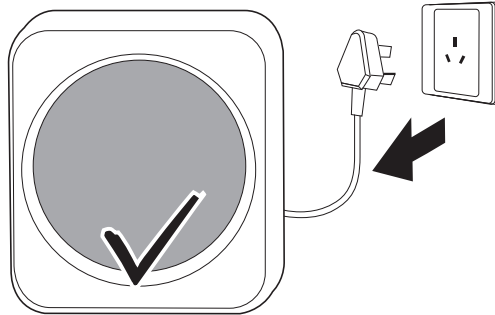

- Wipe the washing machine enclosure, with a soft cloth and nonabrasive household detergents.

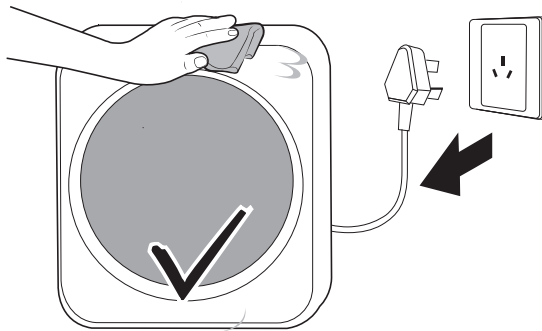

- Do not pour water on the enclosure in case parts of the machine would be damaged.

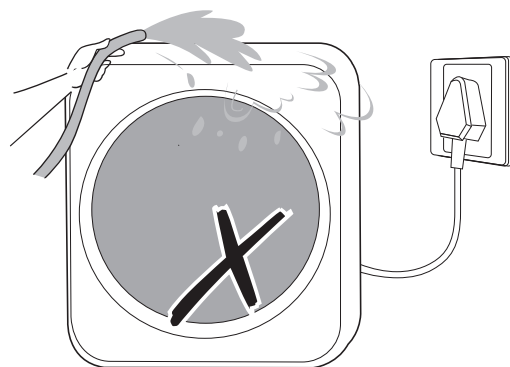

Maintaining the washing machine

Cleaning the water supply valve filter

Clean the head of the water inlet by at least 3-4 times every year; or clean it promptly in case of blockage.

1 Turn off the faucet and remove the power plug;

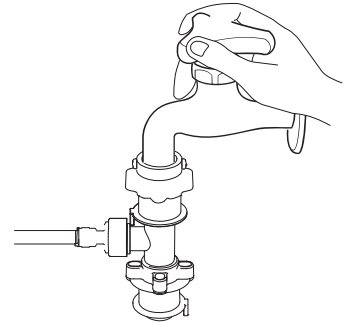

2 Remove the head of water inlet from the faucet and disassemble it;

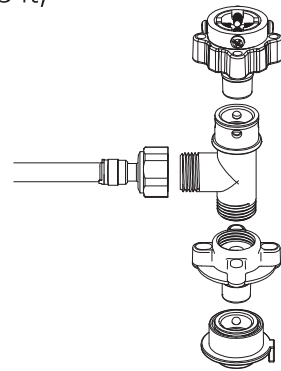

3 Remove residues and stains on each part and ensure no blockage inside.

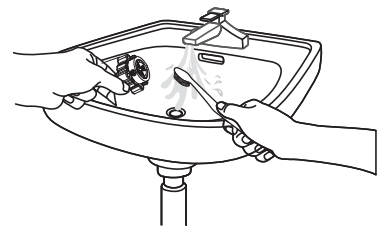

4 Reconnect the water supply hose. Turn on the faucet and make sure the connections are watertight.

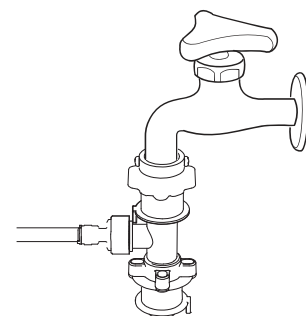

Maintaining the washing machine

Handling a frozen washing machine

If the temperature drops below 0°C and your washing machine is frozen, you can:

- 1 Wrap up the faucet with the towel soaked in warm water and pour warm water on it to unfreeze the water supply hose.

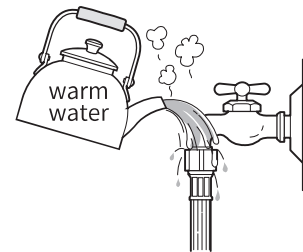

- 2 Remove the water supply hose and soak it in warm water.

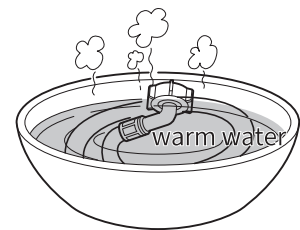

- 3 Pour warm water into the washing machine drum and let it sit for 10 minutes.

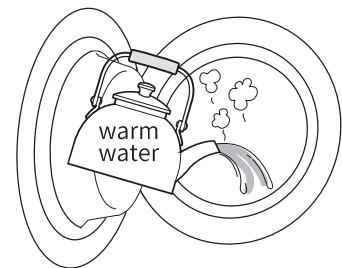

- 4 Reconnect the water supply hose to the water faucet and check if the water supply and drain operations are normal.

- When using the washing machine again, please make sure that the ambient temperature is above 0 °C

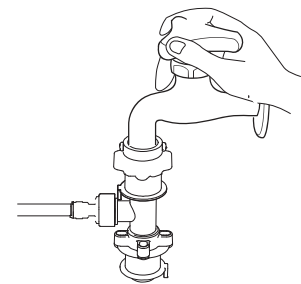

Storing the washing machine

If you need to store your washing machine for a long time, please drain the residual water out from the machine. Otherwise, the residual water will remain in your washing machine for a long time and damage your machine.

1. Select the Spin program to drain the water out with the fastest speed.
2. Turn off the water faucet and separate the water supply hose.
3. Unplug the washing machine and open the machine door to allow ventilation.

Troubleshooting

Phenomenon	Solution
Washing machine vibrates or is too noisy	<ul style="list-style-type: none">● Check whether the installation place of the washing machine is flat or tilted.● Check if the washing machine is touching any other objects.● Check if the laundry load is balanced in the inner drum of the washing machine.
The displayed washing time deviates from the actual washing time	<ul style="list-style-type: none">● There is deviation in the weight of laundry, watery supply time and balancing time.● The washing machine is equipped with a fuzzy logic control system which can automatically detect balance of clothes in spin procedure. To protect the washing machine from being damaged, when poor balance or large eccentricity is detected, the spin time will be extended appropriately to adjust balance of clothes, or the washing machine will run at a lower speed.
The machine stops running and drains away water in the washing process; FO is displayed on the screen	<ul style="list-style-type: none">● A large amount of foam is generated due to excessive detergent added; it is not a fault but foam processing by the machine. Normal procedure will be restored automatically after foam elimination.
Water feeding failure	<ul style="list-style-type: none">● Check whether the faucet is open.● Check whether the water inlet is frozen.● Check whether the water inlet is blocked.

Error messages description

Error code	Code description	Solution
df	Abnormal door lock	<ul style="list-style-type: none"> ● Check if the door is opened and make sure the door is closed firmly. ● Whether the wiring harness of the computer board falls off. ● Check if the plug wire of door switch is loose or has a poor contact.
SF	Abnormal water supply	<ul style="list-style-type: none"> ● Check if the water supply faucet is turned on. ● Check the water pressure. ● Check if the drain valve is plugged up.
_F	Abnormal draining	<ul style="list-style-type: none"> ● Check if the drain hose is properly installed. ● Check if the hose drain is plugged up.
UF	Imbalance alarm	<ul style="list-style-type: none"> ● Excessive eccentricity or winding of clothing, so put the clothing again after tidying up. ● Increase the quantity of clothing to be washed. ● Check whether the washing machine is level.
PF	Water level sensor abnormality	<ul style="list-style-type: none"> ● Check whether the wiring of water level sensor is not in good contact. ● Check whether the computer board wiring harness is normally connected. ● Check the water level sensor for any problems and replace it if any. ● Check the computer board for any problems and replace it if any.
3E	Abnormal running speed due to overloading or winding of clothes	<ul style="list-style-type: none"> ● Press the power button for reboot; run the single spin and drain procedure; turn off the power button, unlock and open the door ● Take out clothes and shake them loose; it is recommended to reduce clothes quantity appropriately. ● Reselect the procedure you need for washing.

HF

Water heating
tube failure

- Check whether the wire harness terminal plugs firmly.
 - Please contact the after-sales service department to replace the heating tube or other parts.
-

LF

Temperature sensor
abnormity

- Check if the NTC plug wire is in poor contact.
 - Test the resistance of temperature sensor in cold state with the multimeter and check if it is above 1.5MΩ.
 - Check if the wire and plug-in between the temperature sensor and the computer board are in poor contact.
-

TF

Too high water level

- Disentangle flexible pipes of the pressure switch, then test-run the machine.
 - Check if there is something wrong with the drainage pump.
-

CE

Abnormal communication
between computer board
and frequency conversion
board

- Power off and check whether the wiring between the computer board and the frequency conversion board is disconnected.
 - Power off and check whether the power cord of the frequency converter is off.
-

Product specification

Model	053224
Rated Voltage	230-240V~
Rated Frequency	50Hz
Tap water pressure(MPa)	0.05MPa-0.8MPa
Net weight (kg)	21
Rotation rate of spin	700RPM
External dimensions (mm)	618×557×373

Enter into the energy efficiency test program:

Energy testing program: turn on the power, press Power button, select standard program, temperature 40 ° C, rinse twice, then enter into energy testing program.

This appliance is intended to be used in household and similar applications such as:

- staff kitchen areas in shops, offices and other working environments;
- farm houses;
- by clients in hotels, motels and other residential type environments;
- bed and breakfast type environments;
- areas for communal use in blocks of flats or in laundrettes.

carpet does not obstruct the openings for washing machines with ventilation openings in the base.

Program Control Board

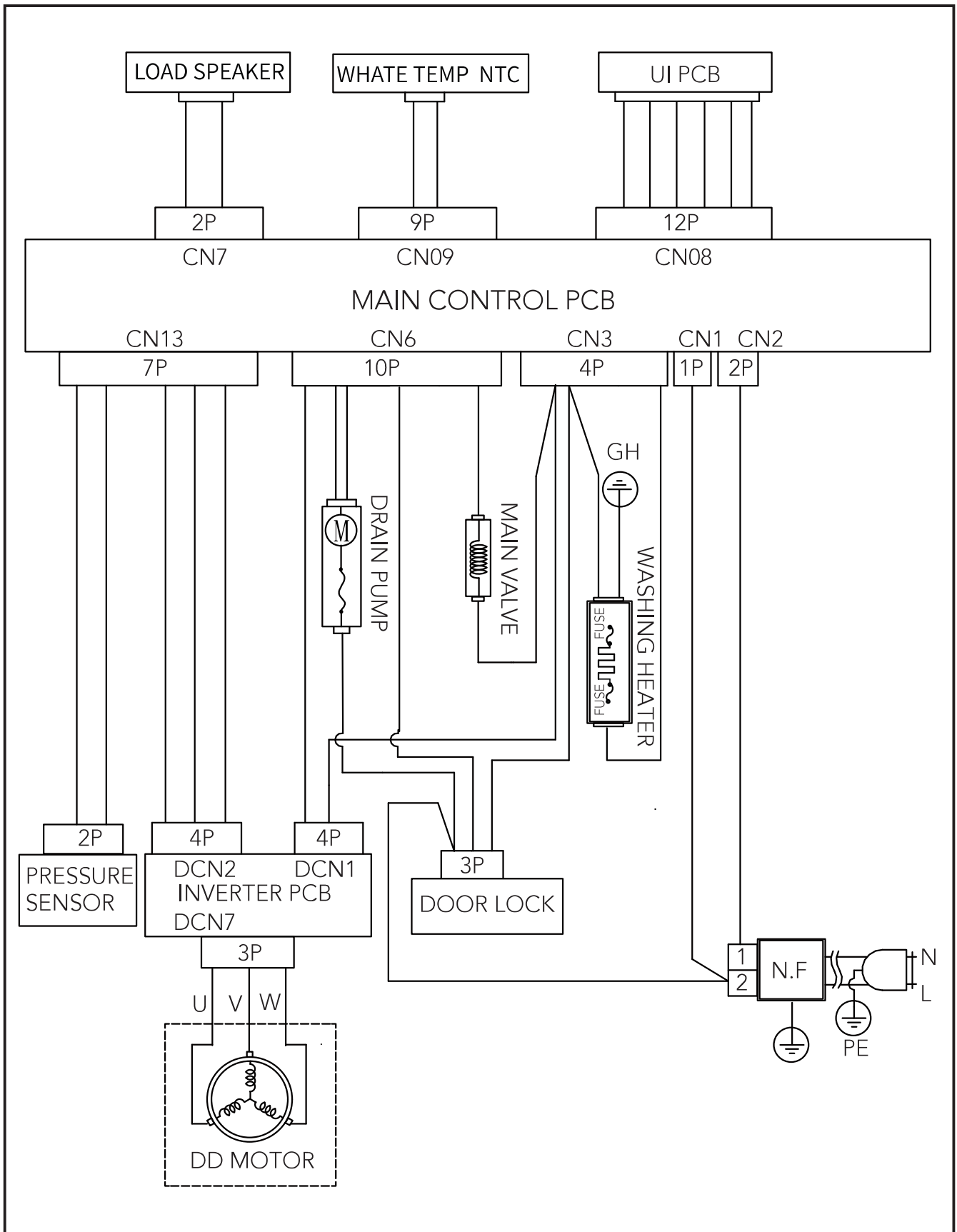

This product is covered under a 12 months warranty period. Kindly refer to the warranty policy terms and conditions available on Camec website.

For further information or assistance, please contact our National Customer Support Team or visit Camec website.

1. Australia on 1300 422 632 or camec.com.au
2. New Zealand on 09 257 2419 or camec.co.nz

For any retail or trade enquiries, please contact our Sales office.

CAMEC VICTORIA

47-63 Remington Drive
Dandenong South VIC 3175
23-27 Freight Drive
Somerton VIC 3062
Phone: 1300 422 632
Email: camec@camec.com.au

CAMEC NEW ZEALAND

44 Montgomerie Road
Mangere Auckland 2022
Phone: 09 2572419
Email: sales@camec.co.nz

CAMEC NEW SOUTH WALES

Units 2 & 3
No. 1 Koonya Circuit
Caringbah NSW 2229
Phone: (02) 9525 2588

CAMEC QUEENSLAND

Building 3
Archerfield Industrial Park
Cnr Kerry & Beaudesert Road
Archerfield QLD 4108
Phone: (07) 3710 9000

CAMEC WESTERN AUSTRALIA

190 Welshpool Road
Welshpool WA 6106 Australia
Phone: (08) 9351 0044