



COMPACT RV Front Loading Washing Machine 2.5KG



User Manual

Contents

Safety Precautions	2
Washing machine appearance	4
Installing the Washing Machine	5
Removing the shipping bolts	5
Adjusting the leveling leg	6
Fixing the cover bottom and guide-leg	7
Connecting the hose-water(in)	8
Connecting the drain hose.....	9
Installation requirements	10
Control panel and program description	13
Using detergents and additives	17
Cleaning the washer drum	18
Cleaning the water supply valve filter	19
Cleaning the washer enclosure	20
Storing the washing machine	21
Troubleshooting	22
Product Specifications	25
Program Control Board	26

Safety Precautions

Important Safety Symbols and Precautions. Please read this manual carefully before using this product. Please read the instructions carefully and perform all installations, maintenance and operation of this machine with caution and care. Proper operation, handling, usage and care for this product will help make the most of the functions of the product and extend the service life of the machine. We are not liable for any damages resulting from improper use.

Meanings of icons and symbols in this manual:



CAUTION: Hazards or unsafe practices that may result in personal injury or property damage.



ATTENTION: To reduce the risk of fire, explosion or personal injury when using your washing machine, follow these basic safety precautions.



WARNING: Hazards or unsafe practices that may result in severe personal injury, death or property damage.

Risk of fire

- ◆ Do not wash or soak any clothing stained with gasoline or other flammable, and toxic solvent, for the clothing will release flammable substance that may cause fire or explosion. Wash the clothing manually first, and ensure that all potentially flammable liquid, solid and particle traces are removed before putting it into the washing machine. Hazardous substances include acetone, alcohol, gasoline, kerosene, certain liquid household cleanser and detergent, turpentine, wax and wax remover.
- ◆ Do not use strong acid cleanser in the washer.
- ◆ Do not put gasoline, alcohol, dry cleanser or other flammable and explosive substances into the washing machine as detergent.
- ◆ Do not overload the wall power socket or the extension cord. Overloading of power wall socket may cause fire and electric shock.
- ◆ Never use this product together with other heating equipment at the same time.

Risks associated to placement and location of product

- ◆ keep children (or pets) away from playing in the washing machine; may result in serious injury.
- ◆ Install the washing machine in a dry and ventilated room; avoid location such as bathroom or a wet room.
- ◆ Position the washing machine on a hard, flat and clean surface without any water or oil.
- ◆ Never stack washing machine on top of other washing machines or appliances.
- ◆ Washing machine must be installed with proper levelling to avoid equipment damage. Use the levelling feet to adjust and make sure product is properly leveled (e.g. in recreational vehicles, caravan and trailers).

Safety Precautions

Risks associated to placement and location of product (continued...)

- ◆ This appliance is not intended for use by any children, persons with physical, sensory or mental disability and by any persons with inadequate knowledge of operating an appliance such as this washer product; unless been adequately supervised or guided by a responsible person and understand the potential hazards to ensure that they can use the appliance safely.
- ◆ The appliance is not intended to be used in places that are subjected to high level of vibration that may disrupt or prevent it from operating normally.
- ◆ Re-levelling of appliances is recommended if equipment has been subjected to a high vibration condition.

Risk of Scalding

- ◆ The water supply hoses may degrade over time. Periodically check and inspect the washing machine for any potential expansion, kink, breakage, wear or tear that may result in leaks on the hoses. Replace any leaking hose promptly if there are any leaks detected.
- ◆ As hot water supply may be used on this machine in one of the washing programs, there may be risk of scalding due to hot water leakage if hoses are worn or torn. Keep children away from the product;

Risk of Electrocutation

- ◆ Please unplug the washing machine before performing maintenance, cleaning or repair. Repairs **MUST** only be carried out by qualified and experienced service personnel. Repairs made by unqualified and inexperienced personnel may lead to further damage to the washing machine and may result in personal injury.
- ◆ Always unplug the washing machine and turn off the water supply faucet after use.
- ◆ Never bend the power cord by force or place heavy objects on the power cord;
- ◆ Never touch the power cord with wet hand;
- ◆ Never overload a power outlet by connecting too many electrical appliances on the power outlet to avoid overloading;
- ◆ Never install the washing machine close to other electrical appliances; never place a candle or cigarette on the washing machine;
- ◆ Never approach the washing machine soaked in water, otherwise an electric shock may occur;
- ◆ Please use a dedicated approved Australian wall type AC power outlet of 220V-240V/50Hz and not less than 10A, installed by a licensed electrician;
- ◆ The specification of the power plug shall comply with the requirements of electricity load current. Use the 220V-240V AC power supply alone with reliable grounding.

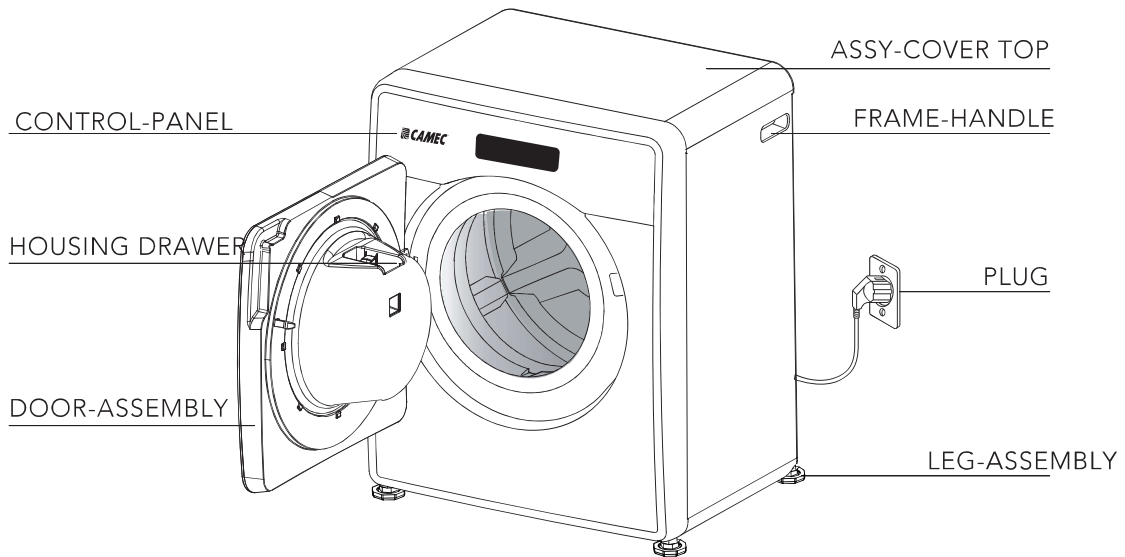

Parts of the Washing machine

Common part names and positions of the mini drum washing machine.

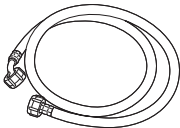
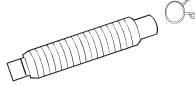
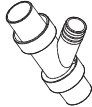
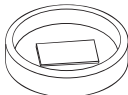

Accessories

Complete accessories and personalized design

BOLT-SPANNAR(1)	HOSE-WATER(IN)(1)	ASSY-HOSE DRAIN(1)	HOSE-DRAIN LINK(1)
			
GUIDE-LEG(4)	COVER BOTTOM(1)	CAP-FIXER(3)	MANUAL-BOOK(1)
			

Installing the Washing Machine

Removing the shipping bolts

Three shipping bolts on the back of the machine must be dismantled before using the washing machine.

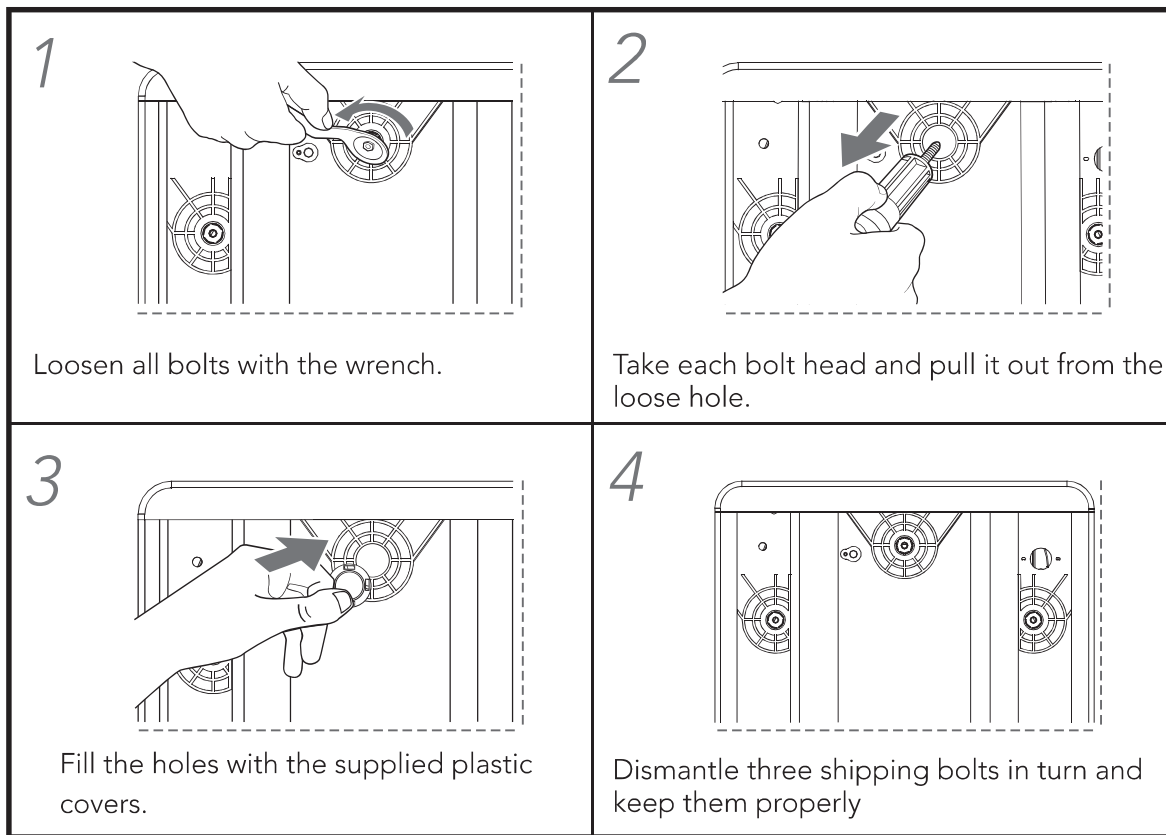

- !** Packing materials can be dangerous to children; keep all packing materials well out of the reach of children.
- this appliance can be used by children aged from 8 years and above and persons with reduced physical, sensory or mental capabilities or lack of experience and knowledge if they have been given supervision or instruction concerning use of the appliance in a safe way and understand the hazards involved.
 - Children shall not play with the appliance.
 - Cleaning and user maintenance must no be carried out by children without supervision.
 - Children of less than 3 years should be kept away from the washing maching unless continuously supervised.

Installing the Washing Machine

Adjusting the leveling leg



- ◆ If the floor is uneven, adjust the leveling leg of the washing machine (do not insert pieces of wood or any other objects under the leg)
- ◆ When tightening the leg bolt with the wrench during adjustments, avoid movement of the leg.

1

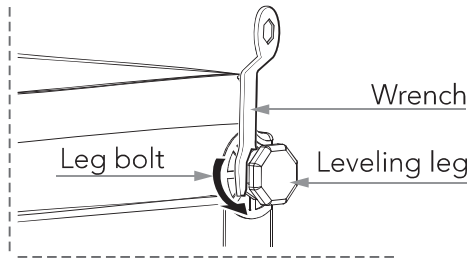

Turn left to loosen the leg bolt with the wrench.

2

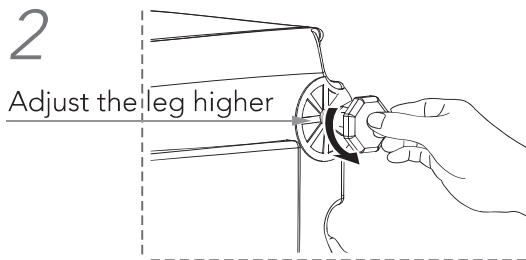

Adjust the leveling leg until it is at the desired height, turn anticlockwise to increase height, and turn clockwise to lower

3

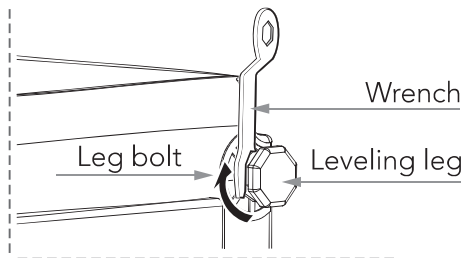

Tighten the feet with a wrench and adjust four feet

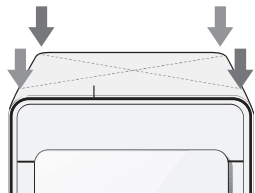

Checking if the leveling leg is level

Press top two diagonal corners in diagonal direction of the washing machine with both hands to test whether the washing machine could shake.

Installing the Washing Machine

Fixing the cover bottom and guide-leg

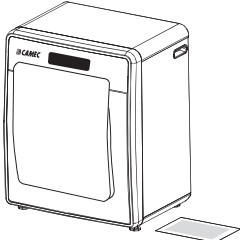
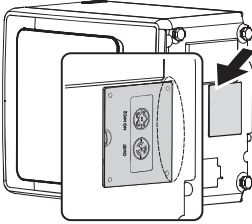
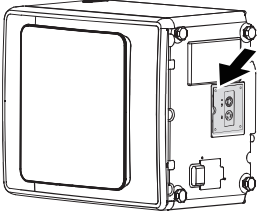
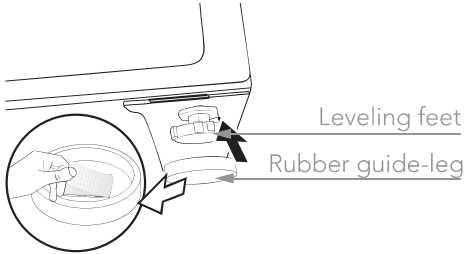
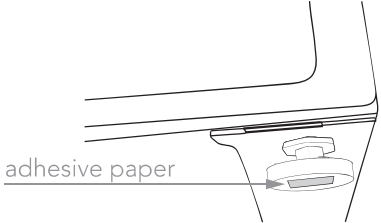
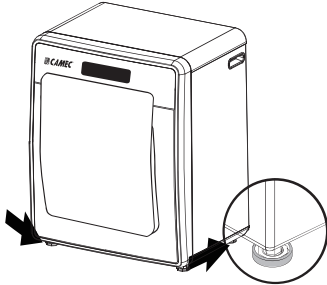
<p>1</p>  <p>Side lay the machine body and place the cover bottom to the bottom;</p>	<p>2</p>  <p>Align one side of the cover bottom and insert it into the groove;</p>
<p>3</p>  <p>Clip four bayonets of the cover bottom into the groove, and press the whole bottom plate into the groove.</p>	<p>4</p>  <p>Leveling feet Rubber guide-leg</p> <p>Tear off the internal adhesive paper of rubber guide-leg and stick it on the leveling feet of machine;</p>
<p>5</p>  <p>adhesive paper</p> <p>Tear off the external adhesive paper, and put down the machine slowly to make the guide-leg stick to the ground.</p>	 <p>Final view of the washing machine with the cover bottom and guide-legs installed.</p>



◆ After sticking the adhesive papers tightly, put down the machine body slowly to make four guide-legs fully stick to the ground.

Installing the Washing Machine

Connecting the hose-water(in)

- Tighten the nut firmly.
- Do not twist, squash, modify or cut the hose.

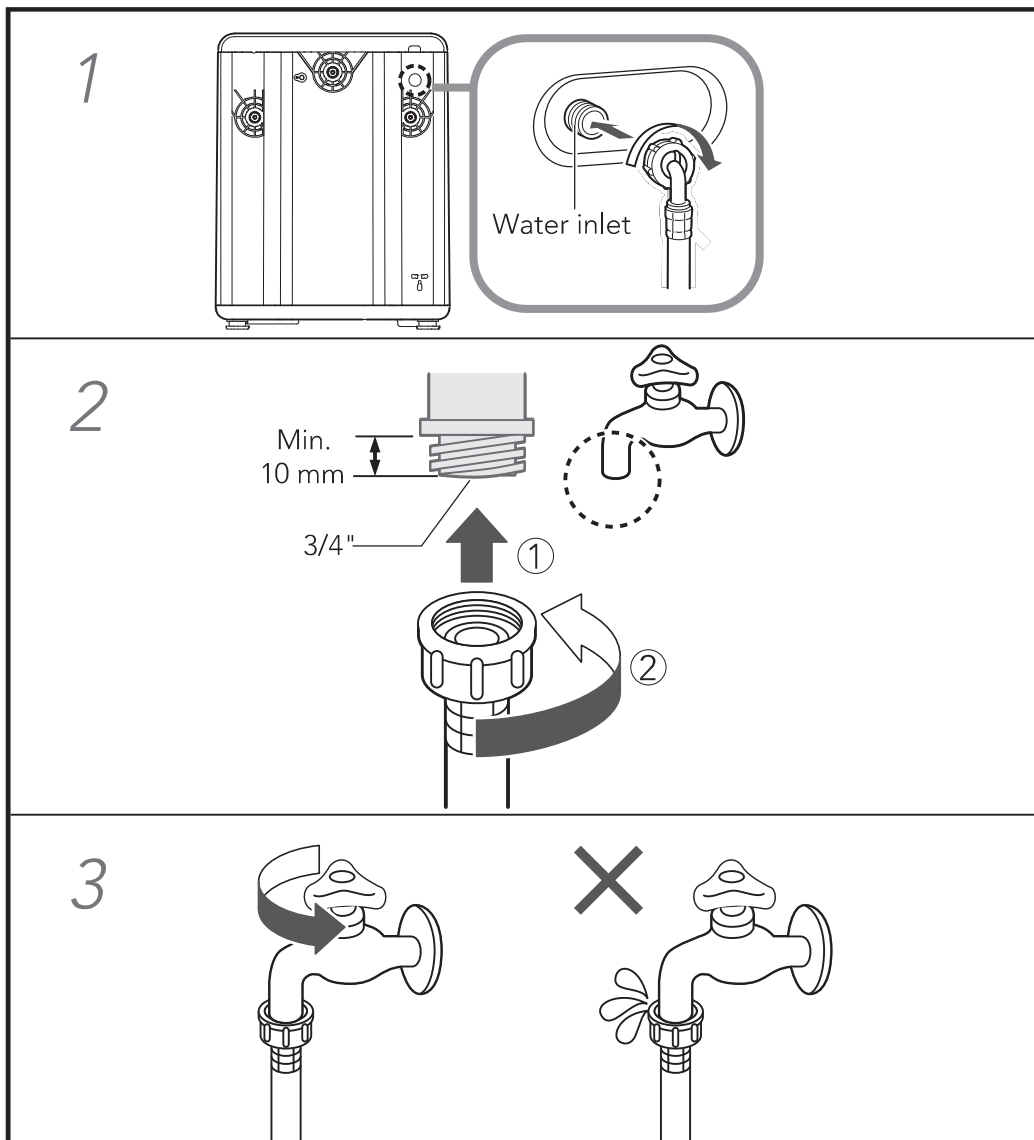

- ⚠ ◆ After installation, turn on the water tap to check for any leakage. The instruction for appliances connected to the water mains by detachable hose-sets supplied with the appliance are to be used and that old hose-sets should not be reused.
- ◆ Unplug the appliance and turn off the water faucet after use.
- ◆ The new hose-sets supplied with the appliance are to be used and that old hose-sets should not be reused.

Installing the Washing Machine

Connecting the hose drain

The end of the hose drain may be positioned in three ways:

1. In a floor drain directly

We recommend that you shall use the hose drain attached to the appliance; it can be directly inserted into the floor drain with the width of the trough entry not less than 4 cm.

2. In a sink hose drain branch:

The end of the hose drain is connected to a sink hose drain branch. If the hose is too long, it cannot be forced into the washing machine, otherwise abnormal noise may occur. Note: the width of the sink entry shall not less than 4 cm.

3. Over the edge of a wash basin:

The end of the hose drain must be placed at a height of between 50 and 90 cm from the ground. To avoid restricting the water flow due to the bending of the hose drain, secure the hose drain over the edge of the wash basin with a hook to prevent the hose from moving.

Note: the end of the hose drain cannot be submerged in water.

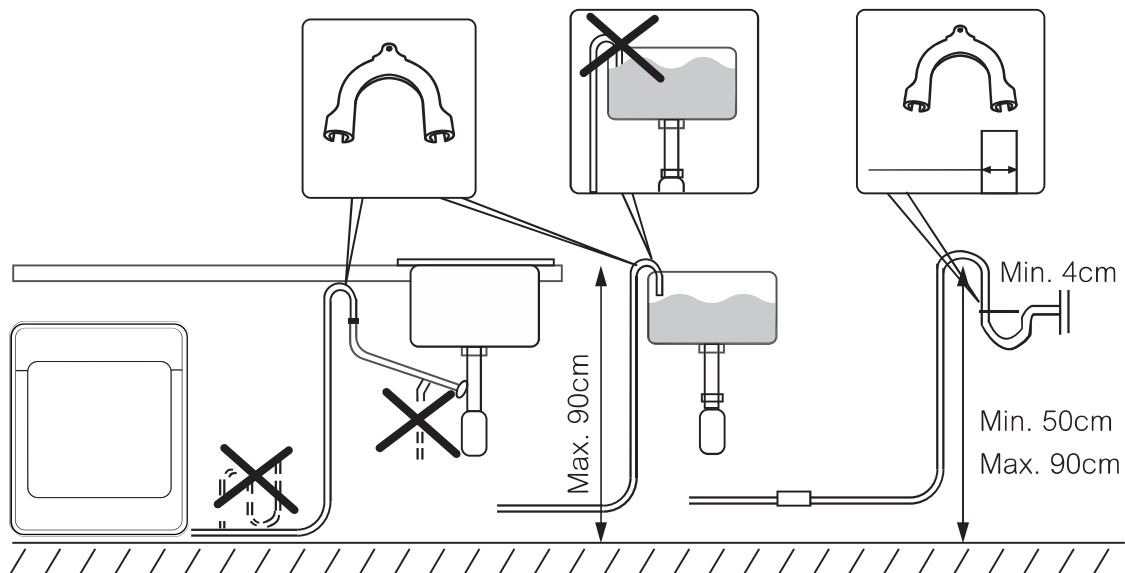

Installation requirements

Power supply

- ◆ To avoid the unnecessary risk of fire, electric shock or personal injury, all electrical circuit and grounding must be set as per the relevant AS/NZS standards. It is the owner's responsibility to provide proper maintenance on the electrical appliance.
- ◆ Do not overload the wall power socket or the extension cord. Otherwise, it may cause fire and electric shock.
- ◆ Only the power cord equipped with the washing machine can be used.
- ◆ When ready for installation, ensure the power supply complies with the following items: Fuse or breaker of 220V-240V, 50Hz, 10A. When the heating function is used, the maximum current of the washing machine may reach 10A. Ensure that your power supply unit (current, voltage and cable) can meet the normal load requirements of the appliance. If you are not sure about the voltage, contact with the manufacturer, product and service agent or qualified person.
- ◆ To guarantee your safety, use the three-core socket and check to ensure it is grounded accurately and reliably. (The washing machine has been equipped with a three-core socket.)
- ◆ The power cord has to be positioned so that it will not be stepped on, pressed or clamped by the article on or next to it. Pay special attention to the power cord of plug, socket and power cord contact of the appliance.

Water supply

- ◆ The working water pressure of the washing machine is 0.05MPa~0.8MPa. When the water pressure is below 0.05MPa, the water supply valve may not work normally, or the time of water supply is longer than that of program control, and the display screen shows "SF".
- ◆ The water supply tap must be less than 122cm away from the rear of the washing machine so that the water supply hose can be easily connected to the washing machine and the water tap.
- ◆ To prevent the risk of water leakage and waterway damage, consider the following:
 - Ensure water tap is at a reasonable position for easy connection.
 - Turn off the water tap when the washing machine is not used.
 - Check water leakage conditions of the internal loop regularly.

Installation requirements

Grounding

- ◆ The instructions for appliances incorporating a functional earth, states that the appliance incorporates an earth connection for functional purposes only.
- ◆ The washing machine must be grounded. If the washing machine has a fault or cannot run normally, the current can be conducted to the ground, minimizing the risk of electric shock.
- ◆ The ground wire cannot be connected to the plastic pipe, gas conduit or hot-water pipeline. If the ground wire is connected to the improper ground conductor, electric shock may occur.
- ◆ If you are not sure whether the washing machine is grounded accurately, check and verification should be performed by the manufacturer, product and service agent or qualified person.
- ◆ If the supply cord is damaged, it must be replaced by the manufacturer, its service agent or similarly qualified persons in order to avoid a hazard. The plug attached to the washing machine cannot be transformed. If the plug cannot match the socket, a suited one should be installed by the manufacturer, product and service agent or qualified person.

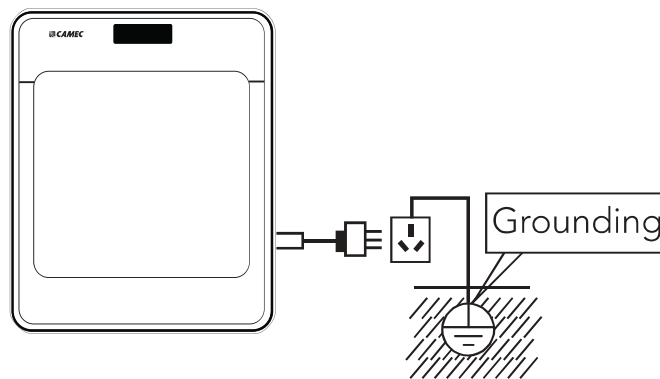

Installed location

To minimize the vibration or unbalanced load, the wood floor has to be reinforced. The carpet and the soft floor tile surface may cause vibration and slight movement of the washing machine in operation.

Before you install the washing machine, select a location with the following characteristics:

- ◆ Do not position the washing machine on a platform or a structure with weak support.
- ◆ A hard, level surface (if the surface is uneven, see "Adjusting the leveling leg").

Installation requirements

Installed location

- ◆ Avoid direct sunlight, with adequate ventilation. (The washing machine shall not be installed in a bathroom or a wet room.)
- ◆ Room temperature shall not fall below 0 °C.
- ◆ Keep away from heat sources such as coal or gas stove

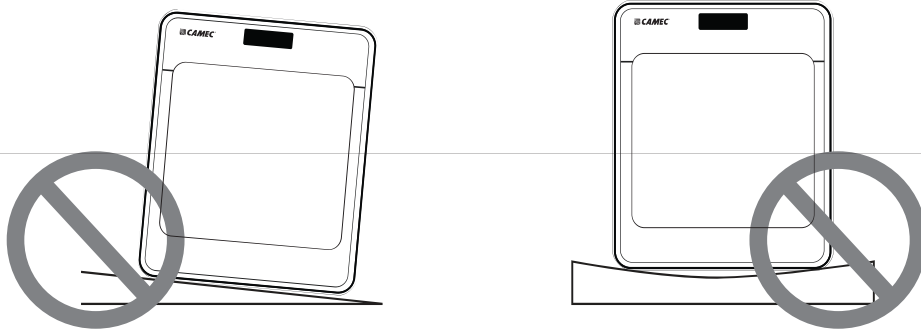

Ensure that the washing machine does not stand on its power cord. Ventilation openings must not be obstructed by carpeting when the washing machine is installed on a carpeted floor.

Control panel and program description

Control panel and program description to facilitate easy operation of the washing machine.

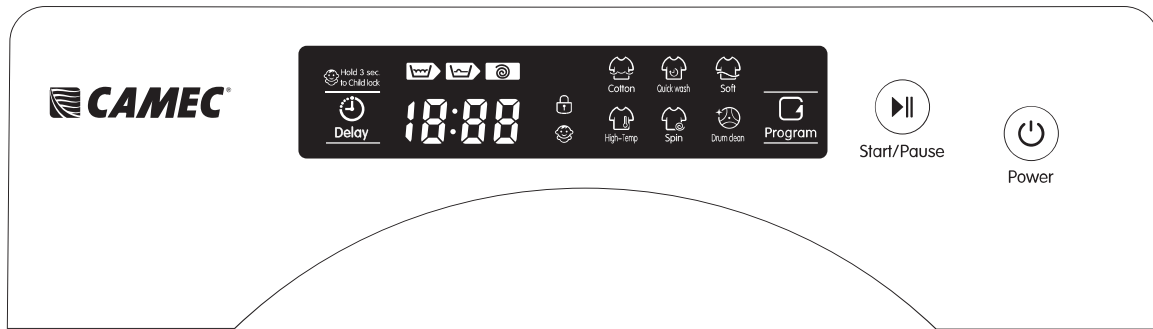

Start/Pause

Press this button to start/pause the operation of the machine; to change washing program, press this button to pause, then press the selected program button to start.



Power button

Turn on/ off the washing machine using this button. If the washing machine is kept unused for 10 minutes after power on, the power supply will be shut off automatically.



Delay button

Press the button repeatedly to cycle through the available preset options (from 3 hour to 19 hours in one hour increments). The washing cycle will complete the displayed hours.



Program button

Press this program button to select the program required.(Cotton / QuickWash / Soft / Hi-Temp / Spin/ Drum Clean)



Door lock

The door lock status indicator, indicates whether the door can be safely opened or not. Door must not be opened when the indicator is solid ON or blinking. Door can be opened when the indicator light is OFF.



Child Lock

This function locks all buttons excluding the Power button so that the selected washing program will not be changed due to unintentional operation resulting in the operational failure of the washing program.



Display module

Display the remaining time required to complete the program. Error code is displayed if the washing machine malfunctions.

Control panel and program description



Cotton

suitable for washing cotton or linen cloth, such as bed sheet, table cloth, underwear, towels, shirts. The default setting wash slightly soiled cotton/linen loads. The energy efficiency test program wash heavy soiled cotton/linen loads.



Quick Wash

suitable for washing slightly soiled laundry that is worn only once or needs washing a little, has a special smell. Washing loading can not be over 1.0kg.



Soft

suitable for washing generally or slightly soiled cotton textiles, linen bed sheet, linen table cloth, underwear, towels, shirts, etc.



High-Temp

High temperature washing and additional rinse will be carried out to ensure children clothing or underclothes free of residual washing powder ;



Spin

perform the spin cycle only and spin dry excess water from the clothes.





Drum clean

This program is designed to clean the inner drum of washing machine to keep it sanitized(no clothing shall be added when this program is used)

High-Temp

Eradicating invisible residual bacteria, facilitating comprehensive protection for health.

Application method of Hi-Temp (boiling) function

- 1.Put clothing into the washing drum and add a proper amount of detergent, then close the door;
- 2.Press the power supply button  ;
- 3.Press the "Program" button to select standard wash or baby care program;
- 4.Press the "start/pause" button  to begin wash.



In order to enhance the washing effect, detergent and bleach may be added into the washing drum before adding clothing.

Control panel and program description

Inspection before carrying out Hi-Temp (boiling) program

A. Check the clothes before washing

a. Separate the clothes based on color and smudginess (for instance, more dirty clothing, unfaded clothing, white clothing, soft clothing etc.).

b. Fasten all attached articles of the clothing and empty the pockets; if there are any damaged parts on the clothing, please repair it before washing.



- Never Hi-Temp (boiling) wash the clothing which may fade;

- Never Hi-Temp (boiling) soft clothing, such as wool product or ladies underwear etc;

B. Check the cover of machine door

a. Check if machine door is properly closed;

b. If clothing is clamped by the cover of machine door during wash, the clothing may be torn or leakage may occur. Please ensure machine door is closed and clothing is not clamped.

Hi-Temp (boiling) wash program precautions



- ◆ Please use a dedicated wall type AC power outlet of 220V-240V/50Hz and 10A;
- ◆ Never use power extension line;
- ◆ Adopting other supply voltage or current may result in fire, electric shock or power failure;
- ◆ Never use this product together with other heating equipment at the same time;
- ◆ The temperature of Hi-Temp (boiling) program may be different due to environment;
- ◆ The internal temperature may be very high in the boiling wash program, so operate carefully to avoid scalding.
- ◆ Provide cold water to cool the hot water, ensure to reach the safe water temperature during drainage;
- ◆ Time required for sterilization by program is based on water inlet temperature, the lower water inlet temperature is, the longer time is required;
- ◆ With specific design for the washing machine, only cold water will be supplied to cool the hot water after the boiling wash program;
- ◆ Boiling wash program can be kept on only after the machine door is closed;

Control panel and program description

Delay

Press the button repeatedly to cycle through the available preset delay options (from 3 hour to 19 hours in one hour increments). The washing cycle will be completed in the displayed hours.

Setting method of the preset time:

1. Select a washing program according to the type of clothes you are washing.
2. Press the Preset button repeatedly to select your desired preset time.
When the time for your selected washing program is more than 3 hours, the preset time shall be set to more than 3 hours.
Press the button for the first time, displaying "3:00" and the time can be set to "19:00" at most in one hour increments. Continue pressing, the time will increase automatically.
3. Press the Start / Pause button. The clock will begin counting down until it reaches your finish time.

If the preset time is set to 6 hours, the washing program will be finished completely after 6 hours.

Cancellation method: press the Power button, this function will be inactivated.

Note: the preset time can be 3 to 19 hours, not less than 3 hours.

The present function is unsuitable for clothes that produces static electricity.

Delay function is not available for Drum clean program.

Set the preset time at first, then press the "Start / Pause" button to display the remaining time.

Child Lock

Child-Lock function can prevent accidental washing process due to unintentional operation.

Setting method of the child lock:

This function will be activated when pressing the "delay" button and hold down for 3 seconds. The  lights will turn on.

Cancellation method: press the delay button for 3 seconds to cancel this feature.

Note: if need to change the program, cancel "child-lock" function then change, and press "start/pause".

Using methods of detergents and additives

Please ensure the cap-drawer is placed at the correct position, and it cannot be taken down during wash

Cap-drawer

Addition level of laundry liquid should not exceed MAX base line marked on the cap-drawer, Laundry power or laundry beads should be added into drum directly.

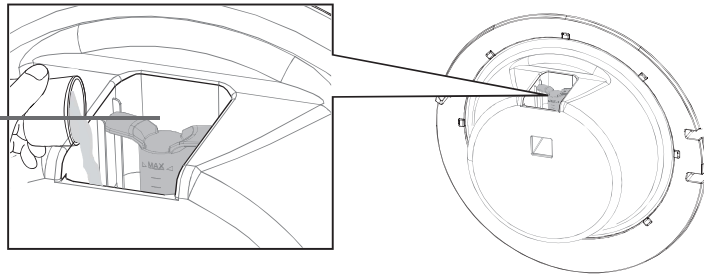

Precautions for using the detergent

A. Determine the amount of laundry liquid

The amount of detergent is based on the water hardness in your area and the detergent manufacturer's recommendations on the package as well as the weight of laundry, the type of fabric, the degree of soiling etc.

B. Selecting proper laundry liquid



The type of detergent you should use is based on the type of fabric (cotton, delicate items, chemical fiber and wool), color, wash temperature, degree and type of soiling. Always use "low foam" washing powder, which is designed for front loading washing machine.

- ◆ Keep detergents and additives in a safe, dry place out of children reach.
- ◆ Please use appropriate amount of detergent according to the type of fabric and the degree of soiling for the sake of environmental protection.
- ◆ Appropriate amount of detergent shall be used according to the weight of laundry, the degree of soiling and product description.

Drum clean

This is a drum auto clean program and can remove possibility of mould that may be present in the drum.

Precautions for using drum cleaning function

- A. Turn on the water tap.
- B. Press the Power button  to start the washing machine.
- C. Press the Program button to select the Drum clean program.
- D. Press Start/Pause button  to start the Drum clean program.

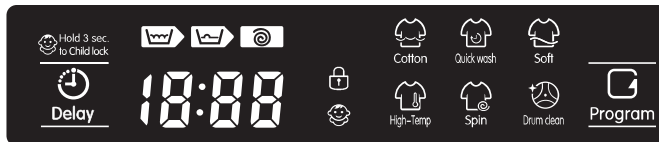

 Never add clothing into the drum in drum cleaning program.

Application method of drum cleaning function

- ◆ Be sure to use the specialized cleansers to clean the inner drum.
- ◆ The drum can be cleaned without cleansers for the Drum clean program.
- ◆ The Drum clean program cannot be used when there are clothes in the washing machine, or the laundry or machine may be damaged.
- ◆ Only one tenth of drum cleanser amount recommended by the manufacturer shall be used for the sake of environmental protection.
- ◆ Bleach containing chlorine may fade the laundry; be sure to use oxygen bleach only.
- ◆ There are powder and liquid cleansers to clean the drum.
- ◆ Powder cleanser: Please use powder bleach or the cleanser specialized for the inner drum of the washing machine.
- ◆ Liquid cleanser: Please use liquid oxygen bleach or the cleanser specialized for the inner drum of the washing machine.
- ◆ Never use foam type detergent.

Cleaning the water supply valve filter

You should clean the supply valve filter at least 3 to 4 times per year, or when you see "SF" error message on the display:

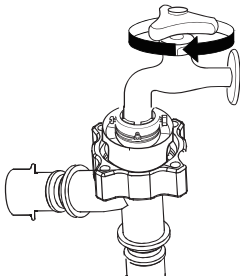
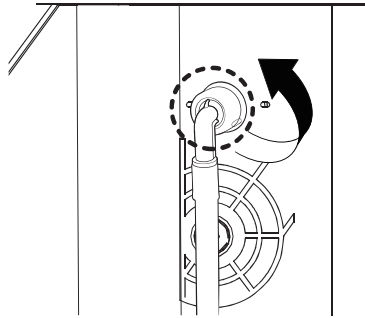
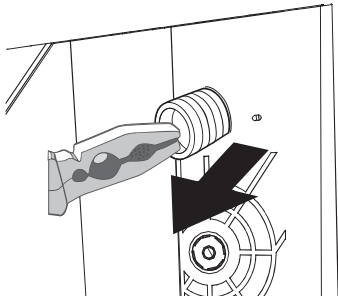
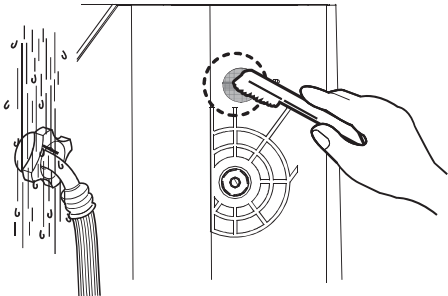
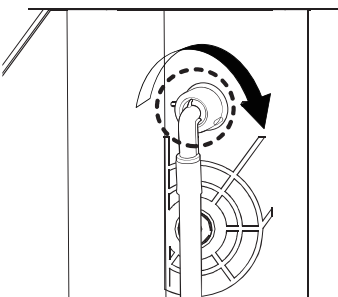
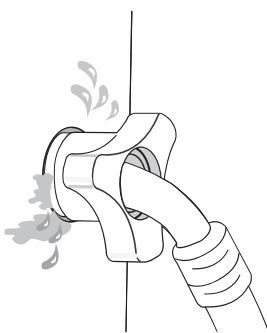
<p>1</p>  <p>Pull out the power plug and turn off the water supply tap of the washing machine.</p>	<p>2</p>  <p>Unscrew the water supply hose from the back of the machine.</p>
<p>3</p>  <p>With a pair of pliers, gently pull out the water supply valve filter and rinse it under water until clean.</p>	<p>4</p>  <p>Clean the inside and outside of the threaded connector.</p>
<p>5</p>  <p>Push the filter back into the original place. Reconnect the water supply hose.</p>	<p>6</p>  <p>Turn on the tap and make sure the connections are watertight.</p>

Cleaning the water supply valve filter

- **Rust** : Rusting may occur if water with rust or rusty article, such as hair pin, is put into the drum, or water has been remained in the drum for too long.
- **Rust cleaning**: Squeeze out the rust removing paste on a soft cloth or sponge, and then wipe the rusty parts.
※ Never use a steel brush, otherwise the drum will be damaged.
- **Residual detergent**: (Dark color and stain) After long service of the washing machine, if excessive detergent is added, or cleaning program is repeated with detergent not dissolved completely, clothing may be contaminated by residual detergent.

Cleaning the enclosure

Clean the housing of washing machine regularly to keep it clean and sanitized

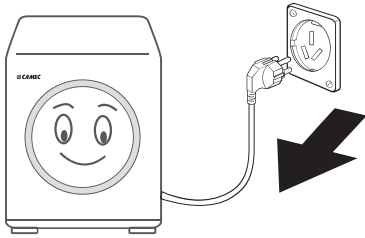
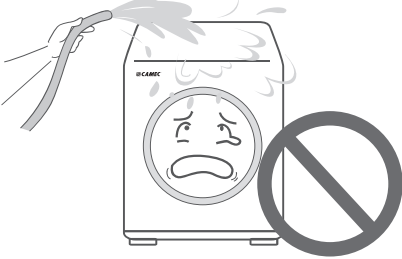
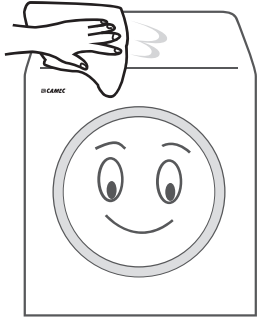
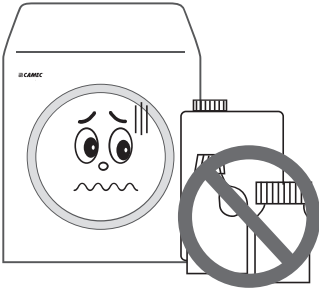
<p>1</p>  <p>1. Unplug the washing machine before cleaning, otherwise electric shock or personal injury may occur.</p>	<p>2</p>  <p>2. Never spill water on the washing machine, otherwise short circuit or electric shock may occur.</p>
<p>3</p>  <p>3. Use a wet cloth to clean the washing machine.</p>	<p>4</p>  <p>4. Never use synthetic detergent, benzene contained detergent or diluents.</p>

Cleaning the enclosure

Precautions for cleaning housing of the washing machine

- ◆ Wipe the washing machine enclosure, including the control panel, with a soft cloth and nonabrasive household detergents.
- ◆ Use a soft cloth to dry the enclosure.
- ◆ Do not pour water on the enclosure, as non water-resistant parts of the machine may get damage.

Storing the washing machine

Drain the residual water out of the machine; otherwise the washing machine may be damaged.



1. Select the Spin program to drain the water out with the fastest speed.

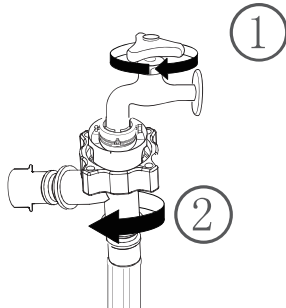

2. Turn off the water tap and separate the water supply hose.

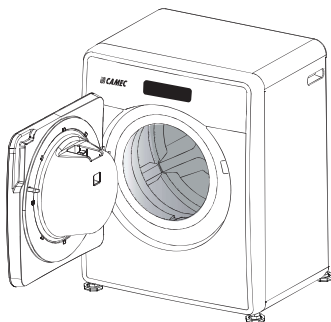

3. Unplug the washing machine and open the machine door to allow ventilation.

Troubleshooting

Problems and solutions

Phenomenon	Solution
Detergent remains in the detergent drawer after the washing is complete	<ul style="list-style-type: none"> ● Check if the water pressure is sufficient when washing. ● Check if the washing powder are damp and caking.
Washing machine vibrates or is too noisy	<ul style="list-style-type: none"> ● Check if the washing machine is set on an uneven surface. If the surface is uneven, adjust the leveling leg to level the appliance. ● Check if the shipping bolts are removed. ● Check if the washing machine is touching any other objects. ● Check if the laundry load is balanced in the inner drum of the washing machine.
The displayed washing time deviates from the actual washing time	<ul style="list-style-type: none"> ● Time deviation is due to the laundry weight, water supply and balancing time.'
The drainage pump has abnormal noise	<ul style="list-style-type: none"> ● Check if the drainage pump filter is blocked by laundry flocks and clean the debris.
Foam overflows from the air return hole on the back of washing machine	<ul style="list-style-type: none"> ● Too much washing powder, so reduce its amount; ● Pour the washing powder into the drum directly; ● Use low foam washing powder or liquid detergent dedicated for drum.

Troubleshooting

Error messages description

Error code	Code description	Solution
df	Abnormal door lock	<ul style="list-style-type: none"> ● Check if the door is opened and make sure the door is closed firmly ● Check if the wiring harness of the computer board was accidentally disconnected. ● Check if the plug wire of door switch is loose or has a poor contact
SF	Abnormal water supply	<ul style="list-style-type: none"> ● Check if the water tap is turned on. ● Clean the water supply valve filter. ● Check the water pressure. ● Check if the drain valve is plugged up.
_F	Abnormal draining	<ul style="list-style-type: none"> ● Clean the drain valve. ● Check if the drain hose is properly installed. ● Check if the hose drain is plugged up.
LF	Extreme low water level with standard watering times	<ul style="list-style-type: none"> ● Check if the drain valve is plugged up. ● Check if the water pressure is normal. ● Check if there is water leakage.
UF	Imbalance alarm	<ul style="list-style-type: none"> ● Excessive eccentricity or winding of clothing, so put the clothing again after tidying up. ● Increase the quantity of clothing to be washed. ● Check if the washing machine feet are level adjusted.
CF	Abnormal communication between PCB and frequency conversion board	<ul style="list-style-type: none"> ● Power off the machine to check if the wire connecting the motor and the electric reactor falls off. ● Check if the patch cord of the motor and cables was accidentally disconnected. ● Check if the PCB wirings fall off.
HO	Overtop water temperature for above 5 seconds	<ul style="list-style-type: none"> ● At this time, keep children off the washing machine and restart it ● Unplug the power cord, and replug it after cooling down.

Troubleshooting

Error messages description

Error code	Code description	Solution
EF	Temperature sensor abnormality	<ul style="list-style-type: none"> ● Check if the temperature sensor wire is in poor contact. ● Test the resistance of temperature sensor in cold state with the multimeter and check if it is above 1.5MΩ. ● Check if the wire and plug-in between the temperature sensor and the PCB are in poor contact.
F	Too high water level	<ul style="list-style-type: none"> ● Disentangle flexible pipes of the pressure switch, then test-run the machine. ● Check if there is something wrong with the drainage pump. ● Check if the hose of pressure switch is clogged.
HU LU	Abnormal voltage	<ul style="list-style-type: none"> ● Power supply voltage is unstable. ● Program will run automatically after the voltage becomes stable. ● Purchase a device which can provide stabilized voltage.
3H 3C	Abnormal speed caused by overload and clothing winding	<ul style="list-style-type: none"> ● the power, operate Spin only program and drainage, turn off the power to unlock the door. ● them. It is recommended to reduce the capacity of clothes appropriately. ● Reselect the program you want to wash.

Problems and solutions

A. Your washing machine is installed with the fuzzy logic control system which can automatically detect the balance of laundry during spinning. When the laundry is detected unbalanced or with strong eccentricity by the washing machine, the machine will properly extend the spin time to adjust the balance of the laundry or run at a lower speed when spinning in order to avoid damage to the machine.

B. When there are excessive foams, the time on the display will stop while the machine eliminates the foam and the machine will automatically return to normal program when finished.

C. Before contacting National Customer Service Team

- ◆ Try to solve the problem (see "Troubleshooting").
- ◆ Restart the program to see if the fault still exists.
- ◆ If the fault persists, call after-sales service and describe the problem.

Product Specifications

051880		
Type	Full automatic washing machine	
Rated voltage and frequency	220V-240V/50Hz	
Wash mode	Drum-type	
Spin mode	Centrifugal type	
Rated wash and Spin capacity	Wash	2.5 kg
	Spin	2.5 kg
Rated consumed power	1300W	
Tap water pressure(MPa)	0.05MPa-0.8MPa	
External dimensions (mm)	500×415×630	
Net weight (kg)	34kg	
Rotation rate of wash	50RPM	
Rotation rate of spin	700RPM	

Enter into the energy efficiency test program: press program button for at least 5 seconds to enter into cotton program. The child lock function is automatically activated when the program starts.

This appliance is intended to be used in household and similar applications such as:

- Recreational Vehicles i.e. Caravans and Motorhomes
- staff kitchen areas in shops, offices and other working environments;
- farm houses;
- by clients in hotels, motels and other residential type environments;
- bed and breakfast type environments;
- areas for communal use in blocks of flats or in launderettes.

Warranty

This product is covered under a 12 months warranty period. Kindly refer to the warranty policy terms and conditions available on Camec website.

For further information or assistance, please contact our National Customer Support Team or visit Camec website.

- 1.Australia on 1300 422 632 or camec.com.au
- 2.New Zealand on 09 257 2419 or camec.co.nz

For any retail or trade enquiries, please contact our Sales office.

CAMEC VICTORIA

47-63 Remington Drive
Dandenong South VIC 3175
23-27 Freight Drive
Somerton VIC 3062
Phone: 1300 422 632
Email: camec@camec.com.au

CAMEC NEW ZEALAND

44 Montgomerie Road
Mangere Auckland 2022
Phone: 09 2572417
Email: sales@camec.co.nz

CAMEC NEW SOUTH WALES

Units 2 & 3
No. 1 Koonya Circuit
Caringbah NSW 2229
Phone: (02) 9525 2588

CAMEC QUEENSLAND

Building 3
Archerfield Industrial Park
Cnr Kerry & Beaudesert Road
Archerfield QLD 4108
Phone: (07) 3710 9000

CAMEC WESTERN AUSTRALIA

190 Welshpool Road
Welshpool WA 6106 Australia
Phone: (08) 9351 0044