

# Digital Inverter Generators Instruction Manual



**iGen1200**  
**iGen2200**  
**iGen2500**  
**iGen4500**



# Westinghouse

INNOVATION YOU CAN BE SURE OF



---

**DISCLAIMERS:**

All instructions, illustrations and specifications in this manual are based on the latest information available at the time of publishing. The illustrations used in this manual are intended as representative reference views only. Moreover, because of our continuous product improvement policy, we may modify information, illustrations or specifications to explain or exemplify a product, service or maintenance improvement. We reserve the right to make any change at any time without notice. Your generator may differ slightly from the models pictured, including optional accessories.

**ALL RIGHTS RESERVED:**

No part of this publication may be reproduced or used in any form by any means – graphic, electronic or mechanical, including photocopying, recording, taping or information storage and retrieval systems – without the written permission of MWE Investments, LLC.

---

## CONGRATULATIONS ON PURCHASING A WESTINGHOUSE DIGITAL INVERTER GENERATOR

Thank you for purchasing a Westinghouse portable generator. It is a high-quality power product that will provide many years of safe and reliable service if properly operated and maintained.

### DANGER



This manual contains important instructions for operating the generator. For your safety and that of others, be sure to read this manual thoroughly before operating the generator. Failure to properly follow all instructions and precautions could cause you or others to be seriously hurt or killed. This manual should be considered a permanent part of the generator and should remain with it if resold.

### For Your Records:

Date of Purchase: \_\_\_\_\_ Generator Model Number: \_\_\_\_\_

Purchased From: \_\_\_\_\_ Generator Serial Number: \_\_\_\_\_

Purchase Receipt: Please retain your tax invoice or purchase receipt to ensure warranty coverage.

# CONTENTS

---

<b>SAFETY</b> .....	<b>6</b>
SAFETY DEFINITIONS .....	6
SAFETY SYMBOL DEFINITIONS.....	6
GENERAL SAFETY RULES.....	7
SAFETY LABELS.....	9
<b>UNPACKING</b> .....	<b>10</b>
UNPACKING THE GENERATOR .....	10
ACCESSORIES.....	10
<b>FEATURES</b> .....	<b>11</b>
MAIN GENERATOR COMPONENTS iGen1200.....	11
CONTROL PANEL FEATURES iGen1200 .....	12
MAIN GENERATOR COMPONENTS iGen2200 & 2500 .....	13
CONTROL PANEL FEATURES iGen2200 & 2500.....	14
MAIN GENERATOR COMPONENTS iGen4500.....	15
CONTROL PANEL FEATURES iGen4500 .....	16
<b>OPERATION</b> .....	<b>18</b>
CONNECTING THE BATTERY iGen4500.....	18
BEFORE STARTING THE GENERATOR .....	19
CHECKING OR ADDING ENGINE OIL AND FUEL .....	20
Checking and Adding Engine Oil .....	20
Checking and Adding Fuel.....	20
STARTING THE GENERATOR.....	21
iGen1200 Starting.....	21
iGen2200 & 2500 Starting.....	22
iGen4500 Electric Starting .....	23
iGen4500 Manual Starting.....	23
ECO THROTTLE CONTROL .....	23
OVERLOAD RESET .....	24
STOPPING THE GENERATOR.....	24
Normal Operation .....	24
During an Emergency.....	24
APPLICATION AND DUTY CYCLE.....	24
AMBIENT CONDITIONS.....	24
CONNECTING ELECTRICAL LOADS .....	25
240-Volt AC Loads.....	25
12-Volt DC Accessory Loads .....	25
5-Volt DC USB Loads.....	25
Power Output and Demand .....	25
240-VOLT AC EXTENSION CORDS.....	26



# CONTENTS

12 VOLT BATTERY CHARGING .....	27
Battery Charging by Direct Connection .....	27
Battery Charging by a Mains-Powered Charger .....	27
TRANSPORTING THE GENERATOR .....	28
<b>MAINTENANCE</b> .....	<b>29</b>
<b>MAINTENANCE PRECAUTIONS</b> .....	<b>29</b>
Maintenance Schedule .....	29
<b>ENGINE OIL MAINTENANCE</b> .....	<b>30</b>
Engine Oil Specification .....	30
Checking Engine Oil .....	30
Adding Engine Oil .....	31
Changing Engine Oil .....	31
<b>AIR FILTER MAINTENANCE</b> .....	<b>32</b>
Cleaning the Air Filter .....	32
<b>FUEL STRAINER MAINTENANCE</b> .....	<b>33</b>
<b>SPARK PLUG MAINTENANCE</b> .....	<b>34</b>
<b>SPARK ARRESTER MAINTENANCE</b> .....	<b>36</b>
<b>CLEANING THE GENERATOR</b> .....	<b>37</b>
<b>12 VOLT BATTERY MAINTENANCE iGEN4500</b> .....	<b>37</b>
Charging the Battery .....	37
Replacing the Battery .....	38
<b>DRAINING THE FUEL</b> .....	<b>38</b>
<b>LONG-TERM STORAGE</b> .....	<b>39</b>
Storage Procedure for 1 – 3 Months .....	39
Storage Procedure for Greater than 3 Months .....	39
Removal from Storage .....	40
<b>DISMANTLING AND DISPOSAL</b> .....	<b>40</b>
<b>TROUBLESHOOTING</b> .....	<b>41</b>
<b>SPECIFICATIONS</b> .....	<b>45</b>
<b>WIRING DIAGRAMS</b> .....	<b>46</b>
<b>WARRANTY</b> .....	<b>49</b>
<b>WARRANTY AGAINST DEFECTS</b> .....	<b>49</b>
Proof of Purchase .....	49
Warranty Conditions .....	49

# SAFETY

## SAFETY DEFINITIONS

The words DANGER, WARNING, CAUTION and NOTICE are used throughout this manual to highlight important information. Be certain that the meanings of these alerts are known to all who work on or near the equipment.



This safety alert symbol appears with most safety statements. It means attention, become alert, your safety is involved! Please read and abide by the message that follows the safety alert symbol.

**DANGER**

Indicates a hazardous situation which, if not avoided, will result in death or serious injury.

**WARNING**

Indicates a hazardous situation which, if not avoided, could result in death or serious injury.

**CAUTION**

Indicates a hazardous situation which, if not avoided, could result in minor or moderate injury.

**NOTICE**

Indicates a situation which, if not avoided, could cause damage to the generator, personal property or the environment, or cause the equipment to operate improperly.

NOTE: Indicates a procedure, practice or condition that should be followed in order for the generator to function in the manner intended.

## SAFETY SYMBOL DEFINITIONS

Symbol	Description
	Safety Alert Symbol
	Asphyxiation Hazard
	Burn Hazard
	Burst / Pressure Hazard
	Don't Leave Tools Around
	Electrical Shock Hazard
	Explosion Hazard
	Fire Hazard
	Lifting Hazard
	Pinch-Point Hazard
	Read Manufacturer's Instructions
	Wear Personal Protective Equipment (PPE)
	Read Safety Messages Before Proceeding

## GENERAL SAFETY RULES

### DANGER



Never use the generator in a location that is wet or damp. Never expose the generator to rain, snow, water spray or standing water while in use. Protect the generator from all hazardous weather conditions. Moisture or ice can cause a short circuit or other malfunction in the electrical system.



Never operate the generator in an enclosed area. Engine exhaust contains carbon monoxide. Only operate the generator outside and away from windows, doors and vents.

### WARNING



Voltage produced by the generator could result in death or serious injury.

- Never operate the generator in rain or a floodplain unless proper precautions are taken to avoid being subject to rain or flood.
- Never use worn or damaged extension cords.
- Always have a licensed electrician connect the generator to any fixed electrical installation.
- Never touch an operating generator if the generator is wet or if you have wet hands.
- Never operate the generator in highly conductive areas such as around metal decking or steel works.
- Always use earthed extension cords. Always use three-wire or double-insulated power tools.
- Never touch live terminals or bare wires while the generator is operating.
- Keep animals and children away from the generator at all times.

### WARNING



Petrol fuel liquid and vapours are extremely flammable and explosive under certain conditions.



- Always refuel the generator outdoors, in a well-ventilated area.
- Never remove the fuel cap while the engine is running.
- Never refuel the generator while the engine is running. Always turn engine off and allow the generator to cool before refuelling.
- Only fill fuel tank with unleaded petrol.
- Keep away from sparks, open flames or other forms of ignition such as matches, cigarettes, CB radios and mobile phones when refuelling.
- Never overfill the fuel tank. Leave room for fuel to expand. Overfilling the fuel tank can result in a sudden overflow of fuel and result in spilled fuel coming in contact with hot surfaces. Spilled fuel can ignite. If fuel is spilled on the generator, wipe it up immediately and dispose of rags properly. Allow area of spilled fuel to dry before operating the generator.
- Wear eye protection while refuelling.
- Never use fuel as a cleaning agent.
- Store any fuel containers in a well-ventilated area, away from any combustibles or source of ignition.
- Check for fuel leaks after refuelling. Never operate the engine if a fuel leak is discovered.
- Equip the operating area with a Class ABE or BE portable fire extinguisher.



# SAFETY

## ⚠️ WARNING



Never operate the generator if: powered items overheat; electrical output drops; there are sparks, flames or smoke coming from the generator; or if the receptacles are damaged.



Never attempt to connect more than one generator to the same electrical device, extension cord or fixed electrical installation.



Never use the generator to power medical support equipment.



Always remove any tools or other service equipment used during maintenance before operating the generator.

## ⚠️ WARNING



Do not operate in a hazardous location, e.g. where there may be a risk of explosion of fumes, leaking fuel or explosive dusts.



Do not operate in a confined area where exhaust gases, smoke or fumes could reach dangerous concentrations.



Do not refuel while engine is running.

## ⚠️ WARNING



You must take reasonable care for the health and safety both of yourself and any others who may be affected by your actions. You must understand and follow all of the safety rules and working instructions described herein. You must also use your own good judgement and common sense.

## NOTICE

Never modify the generator.

Never operate the generator if it vibrates at high levels, if the engine speed changes greatly or if the engine misfires often.

Always disconnect electric tools or appliances from the generator before starting.



## SAFETY LABELS



The safety labels have specific positions and must be replaced if they are unreadable, damaged or missing.



Figure 1 - Safety Labels

# UNPACKING

## UNPACKING THE GENERATOR

<b>⚠ WARNING</b>	
	Always have assistance when lifting the generator. The generator is heavy; lifting it could cause bodily harm.
	Avoid cutting on or near staples to prevent personal injury.

1. Carefully cut the packing tape on top of the carton.
2. Fold back top flaps to reveal the upper packing tray.
3. Remove and save the instruction manual, oil bottle, oil funnel and spark plug socket wrench.
4. Remove and discard the upper packing tray.
5. Unfold the top of the plastic bag enclosing the generator.
6. iGen1200, 2200 & 2500: Lift the generator out of the plastic bag and carton.  
iGen4500: Carefully cut the vertical corners of the carton to access the generator.
7. Recycle or dispose of the packaging materials properly.

## ACCESSORIES

Check the accessories against those shown in Figure 2. If any parts are missing, please contact your local Westinghouse dealer.

**A** – Bottle of SAE 10W-30 Engine Oil (250 ml for iGen1200, 350 ml for iGen2200 & 2500, and 600 ml for iGen4500)

**B** – Oil Funnel

**C** – Spark Plug Socket Wrench

**D** – Instruction Manual



Figure 2 - Accessories

## MAIN GENERATOR COMPONENTS iGen1200



- |                                    |                             |
|------------------------------------|-----------------------------|
| 1 - Carry Handle                   | 6 - Engine Access Cover     |
| 2 - Fuel Cap and Vent              | 7 - Choke Lever             |
| 3 - Control Panel                  | 8 - Spark Plug Access Cover |
| 4 - Engine and Fuel Control Switch | 9 - Exhaust Pipe            |
| 5 - Recoil Starter Handle          | 10 - Muffler Access Cover   |

Figure 3 - iGen1200 Main Generator Components

# FEATURES

## CONTROL PANEL FEATURES iGen1200

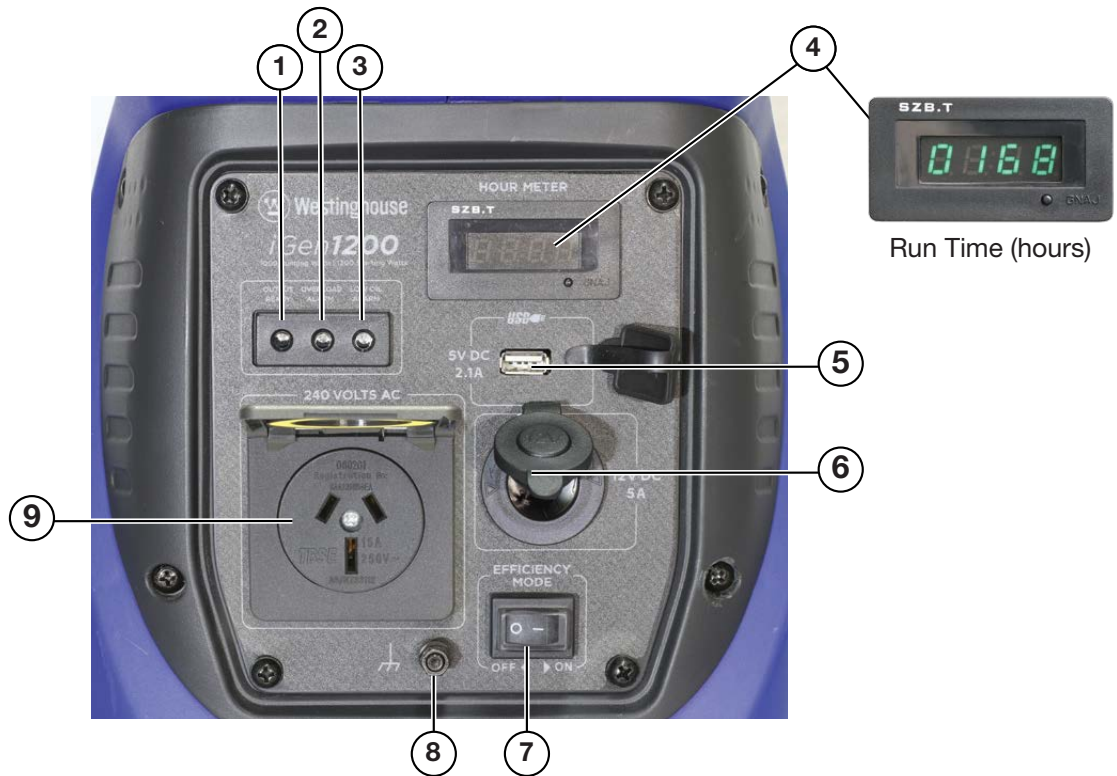

- 1. Output Indicator:** The green status light will illuminate whenever the engine is running and there's AC output available from the generator.
- 2. Overload Alarm:** The red warning light will illuminate if the generator's AC output is overloaded or short-circuited. A brief small overload may be tolerated, but the connected load should be reduced. An extended large overload or short circuit will trip the overload protection feature and disconnect the generator's AC output even though the engine is still running. Stop the engine and then re-start it to restore AC output.
- 3. Low Oil Alarm:** The red warning light will illuminate and the engine will automatically shut down if the oil level becomes too low. Add oil to the correct level before re-starting the engine.
- 4. Hour Meter:** Continuously displays the cumulative running hours whenever the generator is operating.
- 5. 5-Volt DC, 2.1-Amp USB Outlet:** Suitable for charging electronic devices such as phones, tablets and computers with a power demand not exceeding 10 Watts.
- 6. 12-Volt DC Accessory Socket:** Can be used for 12-Volt DC powered devices up to a maximum demand of 60 Watts (i.e. 5 Amps).
- 7. ECO Throttle Switch:** Move the switch to the ON position when powering small resistive loads such as a computer or electric light; the engine speed will automatically be kept to a minimum, thereby reducing fuel consumption and noise. Select the OFF position when powering large inductive loads such as an air conditioner or electric pump; the engine speed will be kept higher for maximum electrical starting power.
- 8. Frame Terminal:** The frame terminal can be used by a licensed electrician to earth the generator if necessary.
- 9. 240-Volt AC, 15-Amp Outlet:** The outlet is capable of delivering the generator's peak output of 1,200 Watts (i.e. 5 Amps at 240 Volts).

Figure 4 - iGen1200 Control Panel Features



## MAIN GENERATOR COMPONENTS iGen2200 & 2500



- |                           |                                      |
|---------------------------|--------------------------------------|
| 1 - Carry Handle          | 5 - Spark Plug Access Cover          |
| 2 - Fuel Cap and Vent     | 6 - Exhaust Pipe with Spark Arrester |
| 3 - Control Panel         | 7 - Muffler Access Cover             |
| 4 - Recoil Starter Handle | 8 - Engine Access Cover              |

Figure 5 - iGen2200 & 2500 Main Generator Components

# FEATURES

## CONTROL PANEL FEATURES iGen2200 & 2500

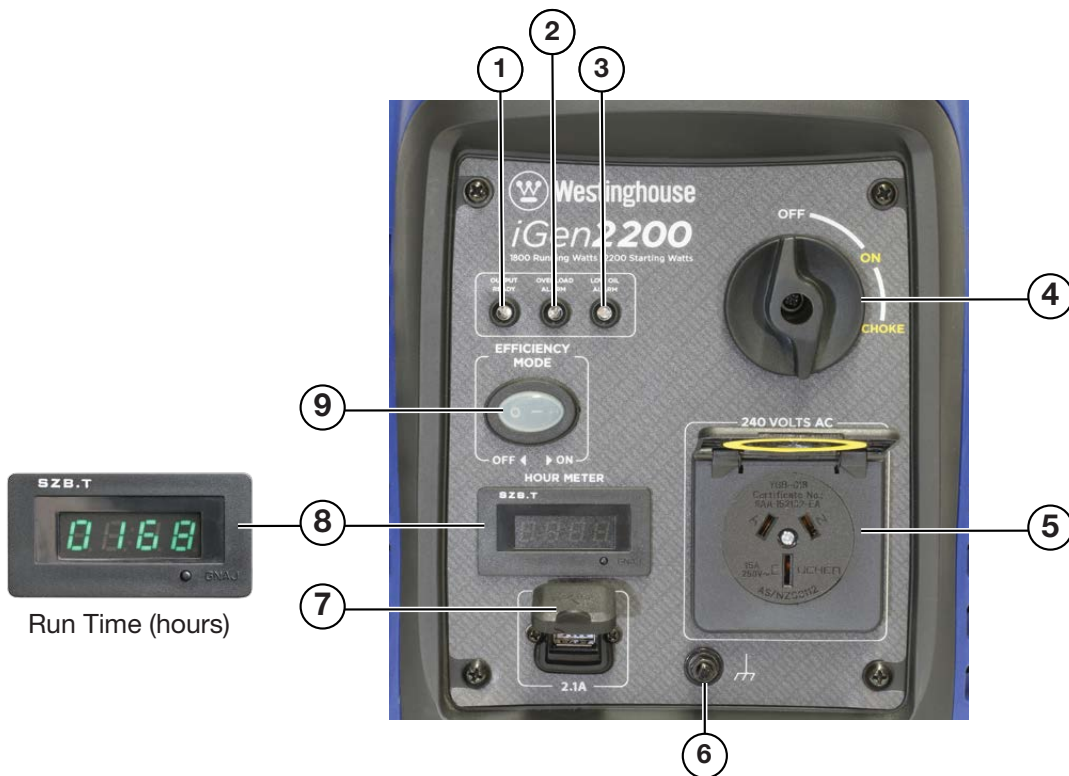

- 1. Output Indicator:** The green status light will illuminate whenever the engine is running and there's AC output available from the generator.
- 2. Overload Alarm:** The red warning light will illuminate if the generator's AC output is overloaded or short-circuited. A brief small overload may be tolerated, but the connected load should be reduced. An extended large overload or short circuit will trip the overload protection feature and disconnect the generator's AC output even though the engine is still running. Stop the engine and then re-start it to restore AC output.
- 3. Low Oil Alarm:** The red warning light will illuminate and the engine will automatically shut down if the oil level becomes too low. Add oil to the correct level before re-starting the engine.
- 4. Engine, Fuel and Choke Control Switch:** Turn the knob to the CHOKE position before starting the generator if its engine is cold. Select the ON position to re-start or run the generator when its engine is warm. Turning the knob to the OFF position stops the generator and cuts off the engine's fuel supply.
- 5. 240-Volt AC, 15-Amp Outlet:** The outlet is capable of delivering the generator's peak output of 2,200 Watts (iGen2200) or 2,500 Watts (iGen2500).
- 6. Frame Terminal:** The frame terminal can be used by a licensed electrician to earth the generator if necessary.
- 7. 5-Volt DC, 2.1-Amp USB Outlet:** Suitable for charging electronic devices such as phones, tablets and computers with a power demand not exceeding 10 Watts.
- 8. Hour Meter:** Continuously displays the cumulative running hours whenever the generator is operating.
- 9. ECO Throttle Switch:** Move the switch to the ON position when powering small resistive loads such as a computer or electric light; the engine speed will automatically be kept to a minimum, thereby reducing fuel consumption and noise. Select the OFF position when powering large inductive loads such as an air conditioner or electric pump; the engine speed will be kept higher for maximum electrical starting power.

Figure 6 - iGen2200 & 2500 Control Panel Features

## MAIN GENERATOR COMPONENTS iGen4500



- |                         |                                      |
|-------------------------|--------------------------------------|
| 1 - Fuel Cap            | 7 - Rear Carry Handle                |
| 2 - Front Carry Handle  | 8 - Muffer Access Cover              |
| 3 - Control Panel       | 9 - Exhaust Pipe with Spark Arrester |
| 4 - Extendable Handle   | 10 - Battery Access Cover            |
| 5 - Wheel               | 11 - Oil Access Cover                |
| 6 - Engine Access Cover | 12 - Recoil Starter Handle           |

Figure 5 - iGen4500 Main Generator Components

# FEATURES

## CONTROL PANEL FEATURES iGen4500

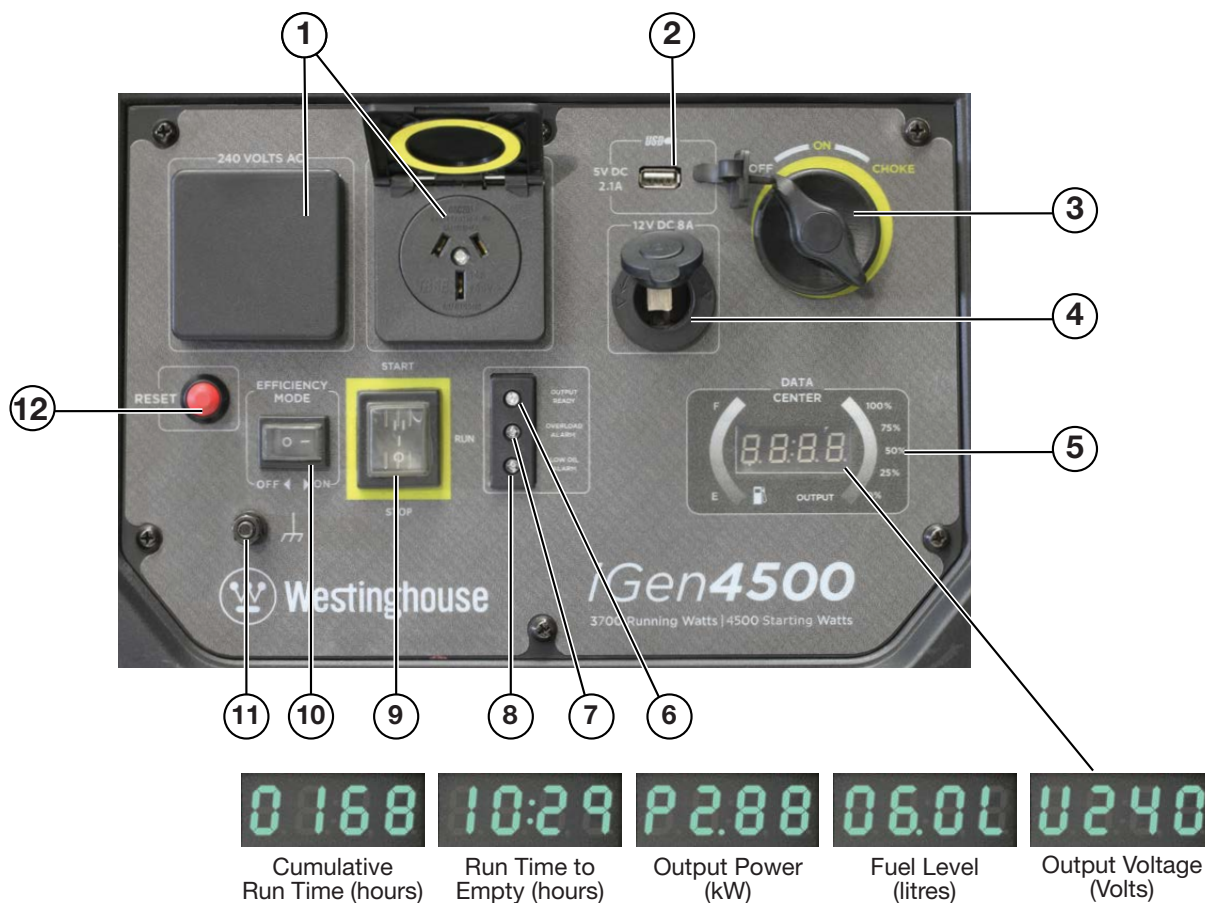

Figure 8 - iGen4500 Control Panel Features

- 240-Volt AC, 15-Amp Outlets:** Each outlet is capable of delivering the generator's peak output of 4,500 Watts (i.e. 18.8 Amps at 240 Volts) intermittently. Continuous supply from a single outlet should not exceed 3,600 Watts (i.e. 15 Amps at 240 Volts).
- 5-Volt DC, 2.1-Amp USB Outlet:** Suitable for charging electronic devices such as phones, tablets and computers with a power demand not exceeding 10 Watts.
- Fuel and Choke Control Switch:** Turn the knob to the CHOKE position before starting the generator if its engine is cold. Select the ON position to re-start or run the generator when its engine is warm. Turn to the OFF position after stopping the engine with the engine control switch for routine shut down. Or select the OFF position and allow the engine to run out of fuel prior to long-term shut down.
- 12-Volt DC Accessory Socket:** Can be used for 12-Volt DC powered devices up to a maximum demand of 100 Watts (i.e. 8 Amps).
- Data Center:** The alphanumeric LED display shows the cumulative run time, run time to empty at current load, output power, fuel level and output voltage in a repeating cycle. The curved LED graphic displays on the left and right-hand sides show the fuel level and output power, respectively.
- Output Indicator:** The green status light will illuminate whenever the engine is running and there's AC output available from the generator.
- Overload Alarm:** The red warning light will illuminate if the generator's AC output is overloaded or short-circuited. A brief small overload may be tolerated, but the connected load should be reduced. An extended large overload or short circuit will trip the overload protection feature and disconnect the generator's AC output even though the engine is still running. Reduce the connected load or rectify the electrical fault before pressing the generator reset button to restore AC output.



- 8. Low Oil Alarm:** The red warning light will illuminate and the engine will automatically shut down if the oil level becomes too low. Add oil to the correct level before re-starting the engine.
- 9. Engine Control Switch:** When the switch is momentarily depressed and held in the START position, the electric starter motor engages and starts the engine. Once the engine starts, release the switch and it will automatically return to the RUN position. Once started, the switch will remain in the RUN position. To stop the engine, move the switch to the STOP position.
- 10. ECO Throttle Switch:** Move the switch to the ON position when powering small resistive loads such as a computer or electric light; the engine speed will automatically be kept to a minimum, thereby reducing fuel consumption and noise. Select the OFF position when powering large inductive loads such as an air conditioner or electric pump; the engine speed will be kept higher for maximum electrical starting power.
- 11. Frame Terminal:** The frame terminal can be used by a licensed electrician to earth the generator if necessary.
- 12. Generator Reset Button:** Press and hold down this button to reset the generator's electrical output when safe to do so after reducing the applied load or rectifying the electrical fault that has caused an overload trip.

# OPERATION

## CONNECTING THE BATTERY iGen4500

### ⚠ WARNING



To avoid electric shock:

- ALWAYS connect the positive (+) battery cable (red boot) first when connecting battery cables.
- ALWAYS disconnect the negative (-) battery cable (black boot) first when disconnecting battery cables.
- NEVER connect the negative (-) battery cable (black boot) to the positive (+) terminal on the battery.
- NEVER connect the positive (+) battery cable (red boot) to the negative (-) terminal on the battery.
- NEVER touch both battery terminals simultaneously.
- NEVER place a tool or other metal object across both battery terminals.
- NEVER place a tool or other metal object between either of the battery terminals and any part of the generator.
- ALWAYS use insulated or non-conducting tools when installing the battery.

**NOTE:** The generator comes equipped with the positive battery cable (red boot) already attached.

Tools required – Flat blade screwdriver and 10 mm spanner.

1. Remove the battery access cover (see Figure 7).
2. Pull down on the battery strap clip and unhook it from the mounting base (see Figure 9).
3. Lift the battery up, withdraw it bottom-first through the battery access port and then stand it up vertically in its normal orientation (see Figure 10).
4. Verify the positive (+) battery cable (red boot) is securely tightened to the positive (+) battery terminal. Ensure boot is properly fitted over battery terminal.
5. Carefully remove the protective wrapping around the lug of the negative (-) battery cable (black boot).

6. Remove the temporary cable tie on the negative (-) cable and then route the cable towards the negative (-) battery terminal.
7. Pull back the black boot and securely attach the negative (-) battery cable (black boot) to the negative (-) battery terminal as shown in Figure 11. Replace the black boot so it protects the cable lug and battery terminal.
8. Insert the battery top-first through the battery access port and stand it up vertically on its mounting base.
9. Check that the battery is positioned correctly and that the battery cables are not kinked or pinched.
10. Pass the battery strap under the negative (-) battery cable and centrally over the top of the battery. Then pull down on the battery strap clip and hook it onto the mounting base.
11. Replace the battery access cover.

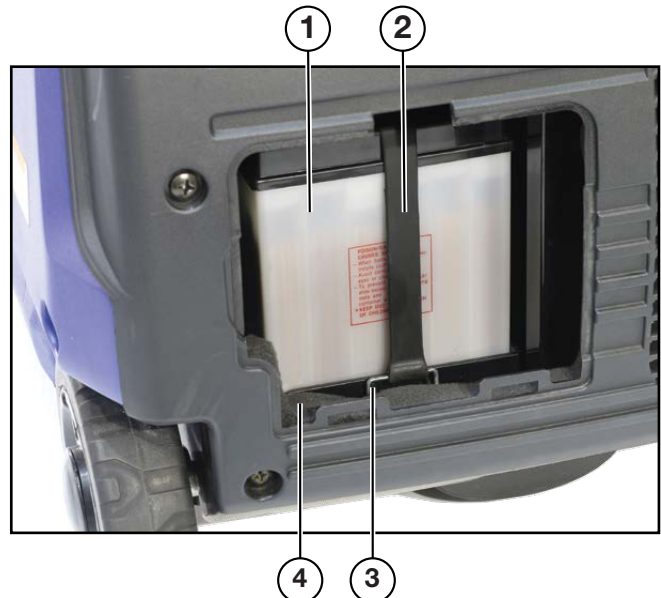

- 1 - Battery
- 2 - Battery Strap
- 3 - Battery Strap Clip
- 4 - Battery Mounting Base

Figure 9 – Battery Mounting Inside Generator



Figure 10 – Battery Removed from Generator for Connection

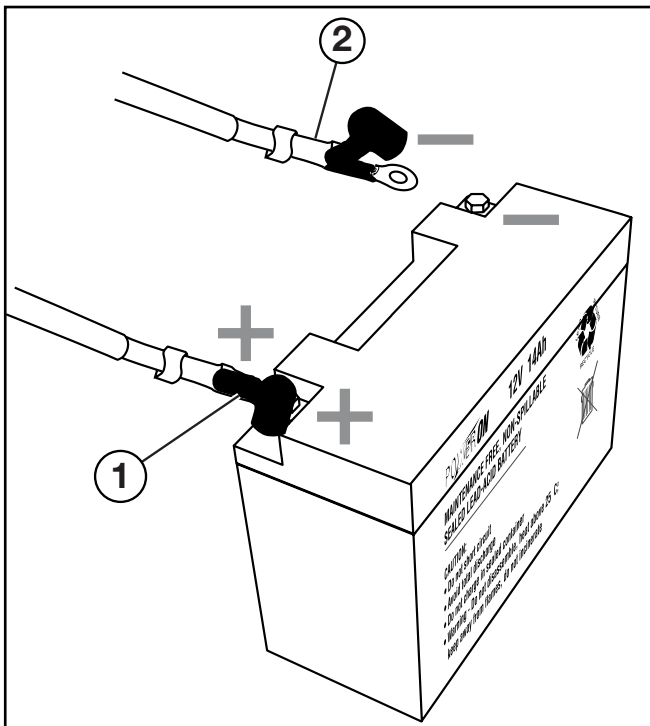

1 - Positive (+)  
Battery Cable  
(Red)

2 - Negative (-)  
Battery Cable  
(Black)

Figure 11 – Attaching the Negative (-) Battery Cable (Black) to the Negative (-) Battery Terminal

## BEFORE STARTING THE GENERATOR

**Location Selection** – Before starting the generator, avoid exhaust and location hazards by verifying that:

- You have selected a location to operate the generator that is outdoors and well ventilated.
- You have selected a location with a level and solid surface on which to place the generator.
- You have selected a location that is at least 1.8 m away from any building, other equipment or combustible material.
- If the generator is located close to a building, it is not located near any windows, doors or vents.

**⚠ DANGER**

Using a generator indoors **can kill you** in minutes. Generator exhaust contains carbon monoxide. This is a poison you cannot see or smell.

**Never** use inside a home or garage, **even if** doors and windows are open.

Only use **outside** and far away from windows, doors and vents.

The output of this generating set is potentially **lethal**. The set should not be connected to a fixed electrical installation except by an appropriately licensed person.

**⚠ WARNING**

Always operate the generator on a level surface. Placing the generator on a non-level surface can cause the generator to tip over, causing fuel and oil to spill. Spilt fuel can ignite if it comes into contact with an ignition source such as a very hot surface.

**NOTICE**

Only operate the generator on a solid, level surface. Operating the generator on a surface with loose material such as sand or grass clippings can cause debris to be ingested by the generator that could:

- Block cooling vents
- Block air intake system

**NOTICE**

Ensure that the generator is always kept horizontal during handling, operation, storage and transport. Flipping the generator over onto its side, end or top will damage it.

# OPERATION

**Weather** – Never operate your generator outdoors during rain, snow or any combination of weather conditions that could lead to moisture collecting on, in or around the generator.

**Dry Surface** – Always operate the generator on a dry surface free of any moisture.

**No Connected Loads** – Make sure the generator has no connected loads before starting it. To ensure there are no connected loads, unplug any electrical cords or devices from the 240-Volt AC, 12-Volt DC accessory and 5-Volt DC USB receptacles on the control panel

## NOTICE

Starting the generator with loads already connected to it could result in damage to any device being powered by the generator during the brief start-up period.

**Earthing the Generator** – The generator's equipotential bonding system including the frame terminal on the control panel should not be connected to the general mass of earth through a separate earth electrode. For more information, refer to AS/NZS 3010:2005 Electrical Installations – Generating Sets or consult a licensed electrician.

## WARNING



Be sure the generator is properly installed to reduce the possibility of electric shock. Any connection to an electrical installation such as in a building, for example, must be carried out by a licensed electrician.

## CHECKING OR ADDING ENGINE OIL AND FUEL

## DANGER



Filling the fuel tank with fuel while the generator is running can cause fuel to spill and come in contact with hot surfaces that can ignite the fuel.

Before starting the generator, always check the engine oil and fuel levels.

After starting the generator, it is not safe to add fuel to the fuel tank or engine oil to the engine while the engine is running or immediately after stopping while the engine and muffler are still hot.

## Checking and Adding Engine Oil

### WARNING



Internal pressure can build up in the engine crankcase while the engine is running. Removing the oil fill plug while the engine is hot can cause hot oil to spray out of the crankcase and cause severe skin burns. Allow engine oil to cool for several minutes before removing the oil fill plug.

The generator as shipped does not contain oil in the engine. You must add engine oil before starting the generator for the first time. See Checking Engine Oil on page 30 and Adding Engine Oil on page 31 for instructions on checking engine oil level and the procedure for adding engine oil.

## NOTICE

The generator does not contain engine oil as shipped. Attempting to start the engine before adding engine oil can permanently damage internal engine components.

## Checking and Adding Fuel

### WARNING



Never refuel the generator while the engine is running.



Always turn the engine off and allow the generator to cool before refuelling.

With the generator switched off and stationary on a horizontal surface, check the fuel level in the tank visually by removing the fuel cap. It is good practice to always fill the fuel tank before operating the generator.

**Required Fuel** – Use only unleaded petrol with an octane rating not less than 91 and ethanol content not greater than 10%. Where possible it is preferable to use regular unleaded petrol without ethanol.

**Filling the Fuel Tank** – Follow the steps below to fill the fuel tank:

1. Stop the generator, if running.
2. Allow the generator to cool down until the muffler access cover is cool to the touch.
3. Move the generator to a flat surface.
4. Clean area around the fuel cap.
5. Turn the fuel cap vent clockwise to the ON position (not applicable to the iGen4500).

6. Remove the fuel cap by unscrewing it anti-clockwise.
7. Slowly add fuel into the fuel tank. Be careful not to overfill the tank. The fuel level should NOT be higher than the red ring inside the fuel strainer (see Figure 12).
8. Replace the fuel cap by screwing it on clockwise and turn the fuel cap vent anti-clockwise to the OFF position (if equipped).



Figure 12 – Maximum Fuel Fill Level

## CAUTION



Avoid prolonged skin contact with fuel. Avoid prolonged inhalation of fuel vapours.

## NOTICE

Do not overfill the fuel tank. Spilt fuel may damage some plastic parts.

## STARTING THE GENERATOR

Before attempting to start the generator, verify the following:

- The engine is filled with engine oil (see Checking Engine Oil on page 30).
- The generator is situated in a proper location (see Location Selection on page 19).
- The generator is on a dry surface (see Weather and Dry Surface on page 20).
- All loads are disconnected from the generator (see No Connected Loads on page 20).

## DANGER



Never use the generator in a location that is wet or damp. Never expose the generator to rain, snow, water spray or standing water while in use. Protect the generator from all hazardous weather conditions. Moisture or ice can cause a short circuit or other malfunction in the electrical system.



Never operate the generator in an enclosed area. Engine exhaust contains carbon monoxide. Only operate the generator outside and away from windows, doors and vents.

## NOTICE

The generator is equipped with a low oil shutdown switch. If the oil level becomes too low, the engine will shut down automatically and cannot be re-started until the oil is filled to the proper level.

Be sure the engine has the proper oil level before using. Failure to verify that the engine has the proper oil level could result in severe engine damage or shorten the engine life.

Disconnect all loads from the generator before starting. Failure to verify all loads are disconnected prior to starting the generator could result in damage to the connected electrical devices.

## iGen1200 Starting

The primary touch points that the user needs to interact with when starting the generator are identified with yellow coloured markings.

1. Turn the fuel cap vent to the ON position (see Figure 13).



Figure 13 – Fuel Cap Vent in the ON Position





# OPERATION

- Turn the engine and fuel control switch anti-clockwise to the ON position (see Figure 14).



Figure 14 – Engine and Fuel Control Switch in the ON Position

- Move the choke lever rightwards to the START position if starting a cold engine (see Figure 15). To re-start a warm engine, leave the choke lever pushed left to the RUN position.

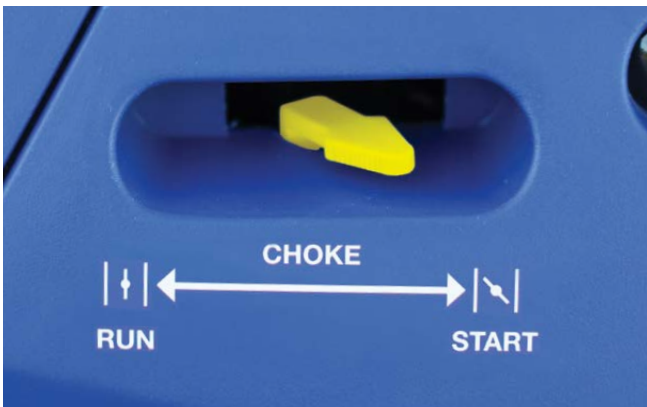

Figure 15 – Choke Lever in the START Position

- Whilst holding the generator down with one hand, firmly grasp the recoil starter handle with your other hand and pull it slowly until you feel increased resistance. At this point, pull it briskly up and away from the generator (see Figure 16). Do not allow the starter handle to snap back against the engine, but instead return it gently to prevent starter damage. Do not allow the starter cord to rub against other parts of the generator.
- As the engine starts running and warms up, gradually move the choke lever leftwards to the RUN position.
- Connect electrical cords or devices into the 240-Volt AC, 12-Volt DC accessory or 5-Volt DC USB outlets, as required.



Figure 16 – Recoil Starter Handle Operation

## iGen2200 & 2500 Starting

- Turn the fuel cap vent to the ON position (see Figure 13).
- Turn the engine, fuel and choke control switch clockwise to the CHOKE position if starting a cold engine (see Figure 17). To re-start a warm engine, turn the knob to the ON position.



Figure 17 – Engine, Fuel and Choke Control Switch in the CHOKE Position

- Whilst holding the generator down with one hand, firmly grasp the recoil starter handle with your other hand and pull it slowly until you feel increased resistance. At this point, pull it briskly up and away from the generator (see Figure 16). Do not allow the starter handle to snap back against the engine, but instead return it gently to prevent starter damage. Do not allow the starter cord to rub against other parts of the generator.
- As the engine starts running and warms up, turn the engine, fuel and choke control switch anti-clockwise to the ON position.
- Connect electrical cords or devices into the 240-Volt AC, 12-Volt DC accessory or 5-Volt DC USB outlets, as required.

## iGen4500 Electric Starting

1. Turn the fuel and choke control switch clockwise to the CHOKE position if starting a cold engine (see Figure 18). To re-start a warm engine, turn the knob to the ON position.



Figure 18 – Fuel and Choke Control Switch in the CHOKE Position

2. Push and hold the engine control switch in the START position until the engine starts. Once the engine starts, release the engine control switch; the switch will automatically move into the central RUN position (see Figure 19).

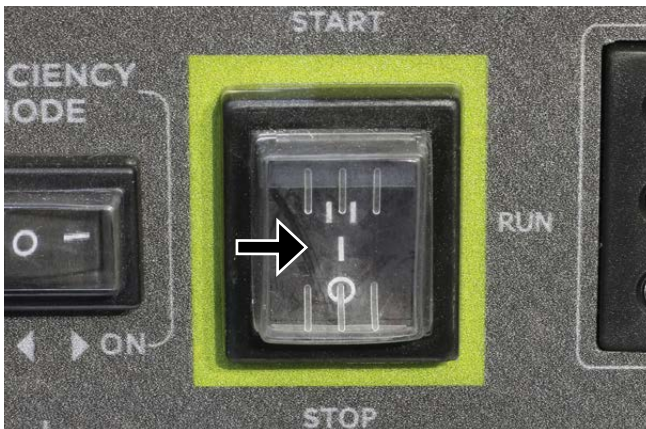

Figure 19 – Engine Control Switch in the RUN Position

### NOTICE

Failure to release the engine control switch once the engine starts can result in damage to the generator. Never push the engine control switch to the START position while the engine is running; this can damage the generator.

**NOTE:** If the engine fails to start after 5 seconds, release the engine control switch. Let the generator rest for 15 seconds and then repeat Step 2. If the cranking speed drops after each unsuccessful attempt, the battery may not be adequately charged; manually start the generator as instructed on page below.

**NOTE:** The electric start generator is equipped with a battery charging feature. Once the engine is running, a small charge is supplied to the battery via the battery cables that will slowly recharge the battery.

3. As the engine starts running and warms up, turn the fuel and choke control switch anti-clockwise to the ON position.
4. Connect electrical cords or devices into the 240-Volt AC, 12-Volt DC accessory or 5-Volt DC USB outlets, as required.

## iGen4500 Manual Starting

1. Turn the fuel and choke control switch clockwise to the CHOKE position if starting a cold engine (see Figure 18). To re-start a warm engine, turn the knob to the ON position.
2. Push the engine control switch to the central RUN position (see Figure 19).
3. Firmly grasp the recoil starter handle with your hand and pull it slowly until you feel increased resistance. At this point, pull it briskly up and away from the generator (see Figure 16). Do not allow the starter handle to snap back against the engine, but instead return it gently to prevent starter damage. Do not allow the starter cord to rub against other parts of the generator.
4. As the engine starts running and warms up, turn the fuel and choke control switch anti-clockwise to the ON position.
5. Connect electrical cords or devices into the 240- Volt AC, 12-Volt DC accessory or 5-Volt DC USB outlets, as required.

## ECO THROTTLE CONTROL

The generator is equipped with ECO Throttle Control to minimise fuel consumption. In ECO mode, the generator senses the electrical load demand and adjusts the engine speed and power output to match it; if there is no electrical load connected, the engine speed drops down to idle. ECO mode should only be used once the generator has reached normal operating temperature after running for at least five minutes. When starting large inductive loads such as an air conditioner or pump, ECO mode should be switched off so that the engine speed will be kept higher for maximum electrical starting power availability.





# OPERATION

To activate ECO mode, move the ECO throttle switch to the ON position (see Figure 20).



Figure 20 – ECO Throttle Switch in the ON Position

To deactivate ECO mode, move the ECO throttle switch to the OFF position.

## OVERLOAD RESET

An electrical overload or short circuit will trip the overload protection system by disconnecting the generator's AC output even though the engine is still running. If this occurs, the overload alarm light will be illuminated red and the output indicator light will be off. The AC output can be restored as follows:

1. Turn off and unplug any electrical devices or cords from the 240-Volt AC, 12-Volt DC accessory and 5-Volt DC USB receptacles on the control panel.
2. iGen1200, 2200 & 2500: Stop and re-start the generator.  
  
iGen4500: Press the generator reset button on the control panel until the overload alarm light goes off and the output indicator light is illuminated green.
3. Check that the intended electrical running and starting loads do not exceed the generator's capacity or have a licensed electrician rectify any fault causing a short circuit in the load.
4. Reconnect any electrical devices or cords to the receptacles on the control panel and then turn on the electrical loads as required.

## STOPPING THE GENERATOR

### Normal Operation

During normal operation, use the following steps to stop the generator:

1. Unplug any electrical cords or devices from the 240-Volt AC, 12-Volt DC accessory and 5-Volt DC USB receptacles on the control panel.

2. Allow the generator to run unloaded for at least one minute to cool and stabilise the engine and alternator temperatures.
3. iGen1200: Turn the engine and fuel control switch clockwise to the OFF position.  
  
iGen2200 & 2500: Turn the engine, fuel and choke control switch anti-clockwise to the OFF position.  
  
iGen4500: Push the engine control switch to the STOP position and then turn the fuel and choke control switch to the OFF position.
4. Turn the fuel cap vent anti-clockwise to the OFF position (if equipped).

### During an Emergency

If there is an emergency and the generator must be stopped quickly, follow the procedure in Step 3 above with haste.

## APPLICATION AND DUTY CYCLE

All models within this range of Westinghouse generators are portable, air-cooled, petrol-engine driven, self-contained units designed for independent supply of electrical power. They are ideal as a backup power supply in the event of mains power failure or as a remote area power supply for use when camping, caravanning or working out in the field.

For most common applications, users can connect a Westinghouse generator to power electrical devices by detachable plug and socket-outlet connection as described in this manual.

Westinghouse generators can also be connected to a fixed electrical installation such as in a house or business premises, for example, by a licensed electrician.

## AMBIENT CONDITIONS

The generator is designed to operate within the following range of ambient conditions:

- Temperature: -5 to +40°C
- Altitude: Up to 1,000 m

Where possible, the generator should be operated in the shade to prevent additional heat load due to solar radiation.

The engine's power output will decrease by approximately 3.5% for each 300 m increase in altitude above sea level. This is normal for spark-ignition engines and is attributable to the decrease in atmospheric pressure (and thus the available air for combustion) as altitude increases.



## CONNECTING ELECTRICAL LOADS

The generator can be used to power (a) 240-Volt AC, 50 Hz, single phase, (b) 12-Volt DC accessory or (c) 5-Volt DC USB electrical devices.

### 240-Volt AC Loads

240-Volt AC devices can be connected either directly or via electrical extension cords into the 240-Volt AC outlet(s) on the generator's control panel. Lift up the spring-loaded weather resistant cover on each outlet for access to connect the electrical device or cord.

240-Volt AC devices may be fitted with either a three-pin 15 Ampere (typically abbreviated "15 Amp" or "15 A") plug or a three-pin 10 Ampere ("10 Amp" or "10 A") plug as shown in Figure 21. Certain double-insulated devices may be fitted with a two-pin 10 A plug that doesn't have an earth pin (which is the longer, vertical pin).



A - 15 Ampere      B - 10 Ampere

Figure 21 – 240-Volt AC Three-Pin Plugs

### NOTICE

DO NOT connect any 240-Volt AC device that is fitted with a three-pin 20 A plug. This can overload the generator.

See 240-Volt AC Extension Cords on page 26 for detailed instructions concerning their selection and use.

### 12-Volt DC Accessory Loads (iGen1200 & 4500)

12-Volt DC devices can be connected either directly or via an electrical extension cord not exceeding 3.5 m in length into the 12-Volt DC outlet on the generator's control panel. Pull out the weather resistant stopper on the outlet for access to connect the electrical accessory or cord, and re-insert it after use.

12-Volt DC devices or extension cords must be fitted with a cigarette lighter plug for connection to the generator as shown in Figure 22.



Figure 22 – 12-Volt DC Cigarette Lighter Plug

### WARNING



Never insert an automotive cigarette lighter into the 12-Volt DC outlet. The heated lighter may ignite the fuel causing an explosion or fire.

### 5-Volt DC USB Loads

5-Volt DC USB devices can be connected either directly or via an electrical extension cord not exceeding 2 m in length into the 5-Volt DC USB outlet on the generator's control panel. Pull out the weather resistant stopper on the outlet for access to connect the USB device or cord, and re-insert it after use.

5-Volt DC USB devices or extension cords must be fitted with a standard Type "A" USB male plug for connection to the generator as shown in Figure 23.

The USB receptacle on the generator's control panel supplies electrical power only for charging and not any form of electronic communication, data or signal.



Figure 23 - Type "A" USB Male Plug

### Power Output and Demand

There are two limits to the amount of electric power that the generator can usefully provide: (a) its total 240-Volt AC, 12-Volt DC or 5-Volt DC electric power generating capacity or power output and (b) the electric current or power output capacity of each individual 240-Volt AC, 12-Volt DC or 5-Volt DC outlet.



# OPERATION

The generator's total power output measured in Watts is listed in the Specifications (see page 45). Two 240-Volt AC power outputs are specified for the generator, namely the running power and the starting power. The 12-Volt DC and 5-Volt DC power outputs are also specified.

## NOTICE

DO NOT overload the generator's 240-Volt AC, 12-Volt DC or 5-Volt DC circuits beyond their rated capacities. This can result in damage to the generator or to the connected devices.

The generator should not be run completely unloaded for extended periods otherwise the engine may be damaged. It is recommended that the generator should always be operated with at least one-third of its rated 240-Volt AC power output.

240-Volt AC devices have two different electric power demands that must be taken into consideration, namely the running power and the starting power. Both are measured in Watts (typically abbreviated as "W").

The steady state continuous load is the running power demand and this is often marked on the device near its model number or serial number. Sometimes the device might only be marked with its voltage (i.e. 240 Volt or 240 V) and current draw (e.g. 6 Ampere or 6 Amp or 6 A), in which case the running power demand in Watts can be obtained by multiplying the voltage times the current, e.g.  $240\text{ V} \times 6\text{ A} = 1,440\text{ W}$ .

Simple resistive 240-Volt AC devices such as incandescent bulbs, toasters, heaters, etc. have no extra power demand when starting, and so their starting power demands are the same as their running power demands.

More complex 240-Volt AC devices containing inductive or capacitive elements such as electric motors have a momentary extra power demand when starting, which can be up to seven times the running power demand or more. Manufacturers of such devices rarely publish this starting power demand and so it's often necessary to estimate it.

A rule of thumb for devices fitted with an electric motor is to apply a starting power multiplier of 1.2 for small hand-held or portable devices and a value of 3.5 for larger stationary devices. For example, a 900 W angle grinder can be assumed to have a starting power demand of at least  $1.2 \times 900\text{ W}$ , which equals 1,080 W. Similarly, a 1,650 W air compressor can be assumed to have a starting power demand of at least  $3.5 \times 1,650\text{ W}$ , which equals 5,775 W.

To prevent overloading of the generator's 240-Volt AC system:

1. Add up the running power demand of all the 240-Volt AC devices that will be connected to the generator at one time. This total must not be greater than the generator's specified running power output.
2. Add up the running power demand again, but for the largest motor-driven device use the value of its starting power demand instead of its running power demand. This total must not be greater than the generator's specified starting power output.
3. The total running power demand of all the devices that will be connected to any one of the generator's outlets must not exceed the generator's specified running power output or 3,600 W, whichever is the lesser.

The above guidelines serve as approximations only of determining the running and starting power demands of 240-Volt AC devices. If in doubt, always err on the conservative side to avoid overloading the generator. In the absence of any power demand information whatsoever, one can assume that any device fitted with a standard domestic 10 A plug has a maximum running power demand of 2,400 W (i.e.  $240\text{ V} \times 10\text{ A} = 2,400\text{ W}$ ). Similarly, a device fitted with a heavy duty 15 A plug can be assumed to have a maximum running power demand of 3,600 W (i.e.  $240\text{ V} \times 15\text{ A} = 3,600\text{ W}$ ). And then apply the appropriate multiplying factor for starting power demand if the device has an electric motor.

## 240-VOLT AC EXTENSION CORDS

Wherever possible, it is recommended to connect 240-Volt AC devices directly to the generator's 240-Volt AC outlet(s). This ensures that the device is supplied with the best quality electricity.

In those instances where it's not practicable or safe to directly plug an electrical device into the generator, the use of an electrical extension cord is necessary.

1. Use only the shortest possible extension cord for the task. Voltage drop increases proportionately with the length of an extension cord and may result in damage to the powered device.
2. Use only a single extension cord and not multiple cords joined together. This will minimize voltage drop and prevent any hazard or inconvenience arising from the joint(s) becoming disconnected.
3. Use only extra heavy duty 15 A extension cords made from 3-core cable of at least 1.5 mm<sup>2</sup> conductor size and fitted with 15 A plugs and sockets (see Figure 21). A 15 A plug cannot be inserted into a standard domestic 10 A socket.

4. Extension cords with conductor size of 1.5 mm<sup>2</sup> or 2.5 mm<sup>2</sup> should not exceed 25 m or 40 m in length, respectively, for general use in accordance with AS/NZS 3199:2007.

## NOTICE

DO NOT use extension cords with only 2-pin (active and neutral) plugs and sockets. These extension cords lack the earth connection that is provided by a 3-pin plug and socket joined with a 3-core cable; the vertical pin is the earth connection.

5. DO NOT use extension cords with any visible signs of damage to the plug, socket or cable.
6. DO NOT use extension cords that are rolled up or knotted as they may overheat.

## 12 VOLT BATTERY CHARGING

Depending on the model, there are either one or two methods by which the generator can be used to charge an external 12 Volt battery:

- A. **iGen1200 & 4500:** By direct connection to the generator's 12-Volt DC electrical outlet; or
- B. **iGen1200, 2200, 2500 & 4500:** By using a mains-powered 12 Volt battery charger connected to one of the generator's 240-Volt AC outlets.

## DANGER



Wet cell batteries produce explosive hydrogen gas while charging. If ignited, the hydrogen gas mixture can explode the battery and cause serious injury or blindness. Only charge a battery in a well-ventilated area away from any sources of ignition such as sparks, open flames, matches, cigarettes, CB radios and mobile phones.



The electrolyte fluid inside a battery contains highly corrosive sulphuric acid, which upon contact with the skin or eyes can cause severe burns or blindness. Always wear protective glasses and clothing – including gloves – when working on a battery. Any electrolyte spill should be thoroughly flushed clean with water.

### Battery Charging by Direct Connection (iGen1200 & 4500)

This method is NOT RECOMMENDED and should only be used in an emergency. The generator's 12-Volt DC electrical output is unregulated and may damage the battery due to overcharging.

**Tools required** – 12 V DC, 10 A minimum battery charging cable with cigarette lighter plug for connection to the generator and alligator clips (both positive and negative) for connection to the battery.

1. Prepare the battery for charging if it is a user-maintainable type by removing the vent caps and adding demineralized or distilled water until the electrolyte level is just above the internal battery plates. This may not be possible with a maintenance-free battery.
2. Connect the positive (+) alligator clip (red) to the positive (+) terminal on the battery.
3. Connect the negative (-) alligator clip (black) to the negative (-) terminal on the battery.
4. Start the generator.
5. Insert the cigarette lighter plug into the generator's 12-Volt DC accessory socket. The battery is now charging. Keep the battery as far away as possible from the generator due to the explosive gas hazard.
6. Monitor the battery; stop charging if the battery gets hot to the touch and the electrolyte boils violently.
7. Variables such as battery size and initial state of charge make it impossible to definitively recommend the charging period. Some batteries have a state of charge indicator that can be visually checked. Otherwise a voltmeter or hydrometer is necessary to accurately determine the battery's condition. A fully charged battery will have an open circuit voltage of at least 12.6 V and an electrolyte specific gravity of at least 1.265. In the absence of any state of charge tools, stop the charging after approximately three hours and check whether the battery is capable of powering the required application, e.g. to start a car's engine.
8. Remove the cigarette lighter plug from the generator's 12-Volt DC accessory socket.
9. Stop the generator unless it's being used to power some other 240-Volt AC device(s).
10. Disconnect the negative (-) alligator clip (black) from the negative (-) terminal on the battery.
11. Disconnect the positive (+) alligator clip (red) from the positive (+) terminal on the battery.
12. Re-fit the battery's vent caps, if applicable. The battery can now be used.

### Battery Charging by a Mains-Powered Charger (iGen1200, 2200, 2500 & 4500)

This method is RECOMMENDED. Using a proper mains-powered 12 Volt battery charger will ensure that the battery is optimally charged and without risk of damage due to overcharging.





# OPERATION

Tools required – 240-Volt AC powered 12 V DC battery charger.

1. Prepare the battery for charging if it is a user-maintainable type by removing the vent caps and adding demineralized or distilled water until the electrolyte level is just above the internal battery plates. This may not be possible with a maintenance-free battery.
2. Connect the battery charger's positive (+) alligator clip or terminal clamp (red) to the positive (+) terminal on the battery.
3. Connect the battery charger's negative (-) alligator clip or terminal clamp (black) to the negative (-) terminal on the battery.
4. Start the generator.
5. Make any necessary pre-charging adjustments or settings on the battery charger in accordance with its operating instructions.
6. Insert the battery charger's power supply plug into one of the generator's 240-Volt AC outlet sockets and then switch the battery charger ON. The battery is now charging. Keep the battery as far away as possible from the generator due to the explosive gas hazard.
7. Monitor the battery; stop charging if the battery gets hot to the touch and the electrolyte boils violently.
8. Monitor the battery charger in accordance with its operating instructions and switch it off when indicated to do so.
9. Switch the battery charger OFF and unplug its power supply cord from the generator.
10. Stop the generator unless it's being used to power some other 240-Volt AC device(s).
11. Disconnect the battery charger's negative (-) alligator clip or terminal clamp (black) from the negative (-) terminal on the battery.
12. Disconnect the battery charger's positive (+) alligator clip or terminal clamp (red) from the positive (+) terminal on the battery.
13. Re-fit the battery's vent caps, if applicable. The battery is now charged and ready for use.

## TRANSPORTING THE GENERATOR

The generator should be stopped and both the fuel control switch and fuel cap vent should be turned to the OFF position before transporting the generator. Keep the unit level during transport to minimise the possibility of fuel leakage or, if practicable, drain out the fuel prior to transport as described in Draining the Fuel on page 38.

If the generator has been operating, allow the unit to cool down before loading it onto the transport vehicle.

The iGen4500's wheels are only intended for ease of moving the generator around by hand. The wheels are not suitable for towing the generator either on or off-road.

Use only the generator's fixed handle(s) for lifting the unit or attaching any load restraints such as ropes or tie-down straps. Do not attempt to lift or secure the generator by holding onto any of its other components.

The iGen4500 is also equipped with an extendable handle. To deploy it, push on the locking button and pull on the handle until it's fully extended (see Figure 24). To stow it, push on the locking button and push on the handle until it's fully retracted. Only extend or retract the handle while the generator is stationary and resting on a horizontal surface.

The extendable handle is intended for ease of wheeling the generator around by hand (see Figure 25). Do not use the extendable handle to lift the generator entirely off the ground, tow it or up-end it.

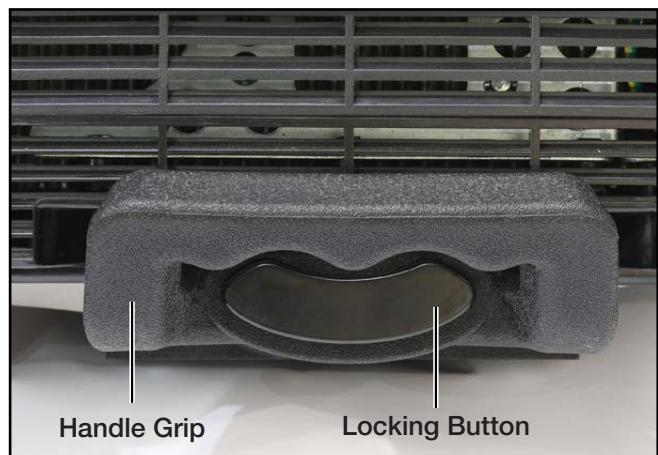

Figure 24 - iGen4500 Extendable Handle



Figure 25 - iGen4500 Handling

## MAINTENANCE PRECAUTIONS

### ⚠ WARNING



Avoid accidentally starting the generator during maintenance by removing the spark plug boot from the spark plug.



Allow hot components to cool to the touch prior to performing any maintenance procedure.



Internal pressure can build in the engine crankcase while the engine is running. Removing the oil fill plug while the engine is hot can cause hot oil to spray out of the crankcase and cause severe skin burns. Allow engine oil to cool for several minutes before removing the oil fill plug.



Always perform maintenance in a well-ventilated area. Fuel and fuel vapours are extremely flammable and can ignite under certain conditions.

### ⚠ CAUTION



Avoid skin contact with engine oil or fuel. Prolonged skin contact with engine oil or fuel can be harmful. Frequent and prolonged contact with engine oil may cause skin cancer. Take protective measures and wear protective clothing and equipment. Wash all exposed skin with soap and water.

## Maintenance Schedule

### ⚠ WARNING



Failure to perform periodic maintenance or not following maintenance procedures can cause the generator to malfunction and could result in death or serious injury.

### NOTICE

Periodic maintenance intervals vary depending on generator operating conditions. Operating the generator under severe conditions, such as sustained high-load, high-temperature, or unusually wet or dusty environments, will require more frequent periodic maintenance. The intervals listed in the maintenance schedule should be treated only as a general minimum guideline. Use only genuine Westinghouse spare parts or others as specified herein. Non-genuine spare parts may be of inferior quality and cause damage to the generator.

Following the maintenance schedule is essential to keep the generator in good operating condition. Table 1 provides a summary of routine inspection procedures and simple maintenance tasks that can be performed by someone with mechanical proficiency using commonly available hand tools. Alternatively, an authorised Westinghouse service dealer can carry out this work for a fee.

Table 1: Basic Maintenance Schedule - Owner Performed

Maintenance Item	Before Every Use	After First 20 Hours or First Month *	After 50 Hours or Every 3 Months *	After 100 Hours or Every 6 Months *	After 250 Hours or Every Year *
Engine Oil	Check / Add	Change	–	Change	–
Air Filter	Check / Clean	–	Clean ^	–	–
Spark Plug	–	–	–	Check / Clean	Replace
Fuel Strainer	–	–	–	Clean	–
Spark Arrester #	–	–	–	Clean	–
Exterior Surfaces	Check / Clean	–	–	–	–

\* Whichever occurs first. ^ Service more frequently if operating in dusty conditions. # N/A for iGen1200.

# MAINTENANCE

Table 2 lists the more complicated maintenance tasks that are best performed by a qualified mechanic using specialised tools. It is recommended to engage an authorised Westinghouse service dealer to carry out this work.

**Table 2: Advanced Maintenance Schedule - Authorised Westinghouse Service Dealer Performed**

Maintenance Item	After 250 Hours or Every Year *	After 500 Hours or Every 2 Years *
Valve Clearance	Check / Adjust	–
Combustion Chamber	–	Clean

\* Whichever occurs first.

## ENGINE OIL MAINTENANCE

### Engine Oil Specification

Use premium quality 4-stroke engine oil with an API Service Classification of at least SF. A SAE multigrade viscosity of 10W-30 is suitable for use in ambient temperatures of up to 40°C. For temperatures above 40°C, a multigrade viscosity of 15W-40 is recommended.

NEVER use 2-stroke engine oil either directly in the engine or mixed with the fuel.

Mineral based, semi-synthetic or fully synthetic oils may be used, but different types of oils should not be mixed together. The engine oil supplied originally with the generator is a mineral type with SAE 10W-30 viscosity.

### Checking Engine Oil

#### NOTICE

Always maintain proper engine oil level. Failure to maintain proper engine oil level can damage the engine. Always use the specified engine oil. Failure to use the specified engine oil can damage the engine.

**Tools required** - iGen1200, 2200 & 2500: Phillips head screwdriver. iGen4500: None.

Engine oil level should be checked before every use.

1. Always operate or maintain the generator on a flat surface.
2. Stop engine if running.
3. Let engine sit and cool for several minutes (allow crankcase pressure to equalize).
4. iGen1200: Remove the engine access cover (see Figure 26).

iGen2200 & 2500: Remove the engine access cover (see Figure 27).

iGen4500: Remove the oil access cover (see Figure 28).



**Figure 26 - iGen1200 Removing the Engine Access Cover**



**Figure 27 - iGen2200 & 2500 Removing the Engine Access Cover**



**Figure 28 - iGen4500 Removing the Oil Access Cover**



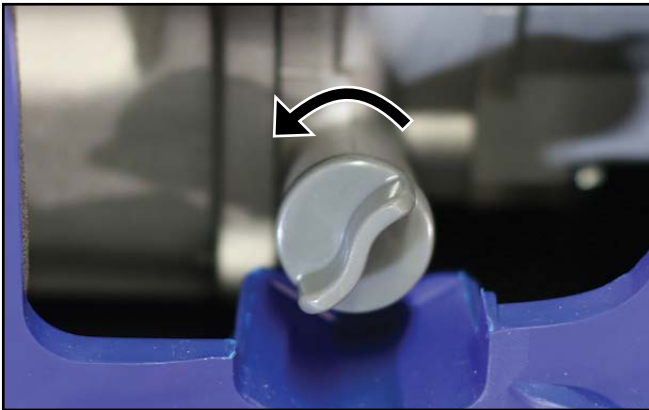

Figure 29 - Removing the Oil Fill Plug

5. Remove oil fill plug by unscrewing it anti-clockwise (see Figure 29).
6. Check oil level:
  - Acceptable Oil Level – Oil surface is at the bottom lip of the oil fill plug opening (see Figure 30).
  - Low Oil Level – Oil surface is below the bottom lip of the oil fill plug opening. Add oil as required.
  - Too High Oil Level - Oil flows out when the oil fill plug is removed. Allow the excess oil to drain out into a waste oil container.

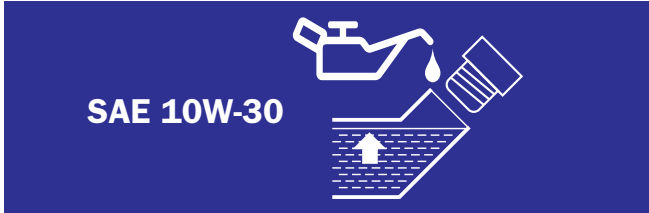

Figure 30 – Checking Oil Level

## Adding Engine Oil

**Tools required** - iGen1200, 2200 & 2500: Phillips head screwdriver. iGen4500: None.

1. Always operate or maintain the generator on a flat surface.
2. Stop the engine, if running.
3. Let engine cool down for several minutes allowing crankcase pressure to equalise.
4. Remove the engine access cover or oil access cover (see Figure 26, 27 or 28, as applicable).
5. Thoroughly clean around the oil fill plug.
6. Remove oil fill plug.
7. Select the proper engine oil as described in Engine Oil Specification on page 30.
8. Using the supplied oil funnel, slowly add engine oil to the engine as shown in Figure 31. Check the oil level periodically to avoid overfilling.

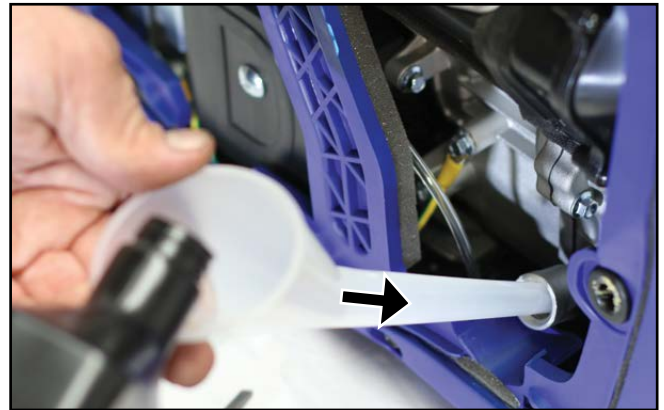

Figure 31 – Adding Engine Oil

9. Continue to add oil until the oil is at the correct level. See Checking Engine Oil on page 30. A simple visual guide is to observe the oil level relative to the bottom lip of the oil filler neck in the engine (into which the oil fill plug is screwed). If the oil reaches the bottom lip, then it's at the high level. If the oil is above the bottom lip and flows out of the hole, then it's too full and the excess must be drained out.
10. Reinstall the oil fill plug and engine or oil access cover.

## Changing Engine Oil

**Tools required** - iGen1200, 2200 & 2500:

Phillips head screwdriver and oil drain pan or oil extractor vacuum pump. iGen4500: Oil drain pan or oil extractor vacuum pump.

1. Stop the engine, if running.
2. Let engine cool down for several minutes allowing crankcase pressure to equalise.
3. Remove the engine access cover or oil access cover (see Figure 26, 27 or 28, as applicable).
4. Place oil pan or other suitable container under the oil fill plug.
5. With a damp rag, thoroughly clean around the oil fill plug.
6. Remove the oil fill plug. Once removed, place the oil fill plug on a clean surface.



Figure 32 – Draining the Engine Oil



# MAINTENANCE

7. Tilt the generator over to drain oil into a waste oil pan or container (see Figure 32).
8. Allow oil to drain completely.
9. Fill crankcase with new oil following the steps outlined in Adding Engine Oil.
10. Re-install the oil fill plug and engine or oil access cover.

An alternate and superior method for draining is to use an oil extractor vacuum pump to remove the used oil via the oil fill plug hole.

## NOTICE

Never dispose of used engine oil by dumping the oil into a sewer, on the ground, or into groundwater or waterways. Always be environmentally responsible. Follow the guidelines of the government agencies for proper disposal of hazardous materials. Consult local authorities or reclamation facility.

## AIR FILTER MAINTENANCE

### WARNING



Never use fuel or other flammable solvents to clean the air filter. Use only household detergent and warm water or alternatively a non-flammable solvent.

### NOTICE

Do not operate the generator without an air filter element or with a damaged air filter element. This will allow dirt to enter the engine and cause accelerated wear.

## Cleaning the Air Filter

**Tools required** - iGen1200, 2200 & 2500: Phillips head screwdriver. iGen4500: Phillips head screwdriver and 10 mm socket wrench.

The air filter must be cleaned after every 50 hours of use or 3 months (frequency should be increased if generator is operated in a dusty environment).

1. Turn off the generator and let it cool for several minutes if it's been running.
2. Move the generator to a flat, level surface.
3. Remove the engine access cover (see Figure 26, 27 or 33, as applicable).



Figure 33 - iGen4500 Removing the Engine Access Cover

4. iGen1200: Remove the air filter cover by pressing down on the locking tab and tipping the cover forwards (see Figure 34). Clean the air filter cover with a rag and place it aside.

iGen2200 & 2500: Remove the air filter cover by undoing the central fixing screw (see Figure 35) to release the cover. Clean the air filter cover with a rag and place it aside.



Figure 34 - iGen1200 Removing the Air Filter Cover

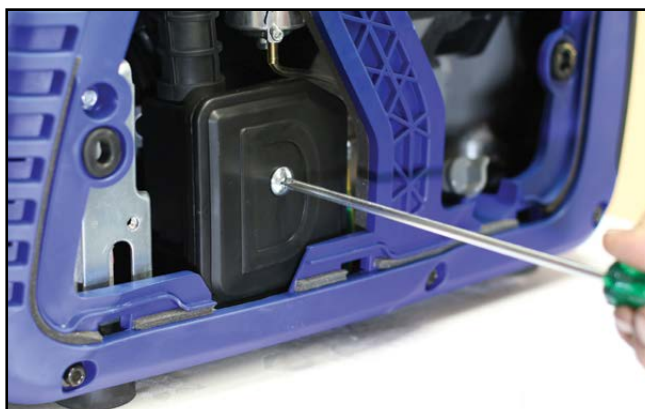

Figure 35 - iGen2200 & 2500 Removing the Air Filter Cover



iGen4500: Remove the air filter cover by turning the twistlocks anti-clockwise and tipping the cover forwards (see Figure 36). Clean the air filter cover with a rag and place it aside.



Figure 36 - iGen4500 Removing the Air Filter Cover

5. Remove the foam air filter element while taking care to note its shape and orientation (see Figure 37). The air filter element must be re-installed later in the same position.



Figure 37 - Removing the Air Filter Element

6. Wash the air filter element in a solution of household detergent and warm water or alternatively in non-flammable solvent. Slowly squeeze the foam in the liquid for a thorough cleaning action. Then remove the foam and squeeze out the liquid.

## NOTICE

NEVER twist or tear the air filter element during cleaning or drying. Apply only a slow and firm squeezing action.

7. Rinse the air filter element by immersing it in fresh water and applying a slow squeezing action.

## NOTICE

Never dispose of the used cleaning solution or solvent by dumping it into a sewer, on the ground, into groundwater or into a waterway. Always be environmentally responsible. Follow the guidelines of the governmental agencies for proper disposal of hazardous materials. Consult local authorities or reclamation facility.

8. Dry the air filter element by repeatedly applying a slow firm squeezing action.
9. Coat the air filter element in clean engine oil and then thoroughly squeeze out the excess liquid.
10. Re-install the air filter element inside the air filter housing while taking care to ensure that the element is correctly positioned.
11. Re-install the air filter and engine access covers.

## FUEL STRAINER MAINTENANCE

Check and clean the fuel strainer after every 100 hours of use or 6 months. It is recommended that this maintenance task also be performed each time when filling with fuel from any source other than directly from a service station bowser.

1. Stop the generator, if running.
2. Allow the generator to cool down until the muffler access cover is cool to the touch.
3. Remove the generator to a flat surface.
4. Clean area around the fuel cap.
5. Turn the fuel cap vent to the ON position, if equipped.
6. Remove the fuel cap and set it aside on a clean surface.
7. Remove the fuel strainer by hand from inside the filler hole on top of the fuel tank (see Figure 38) taking care not to tear or otherwise damage the fine mesh screen. Keep the fuel strainer vertical so that any trapped liquid or solids do not spill onto the generator.

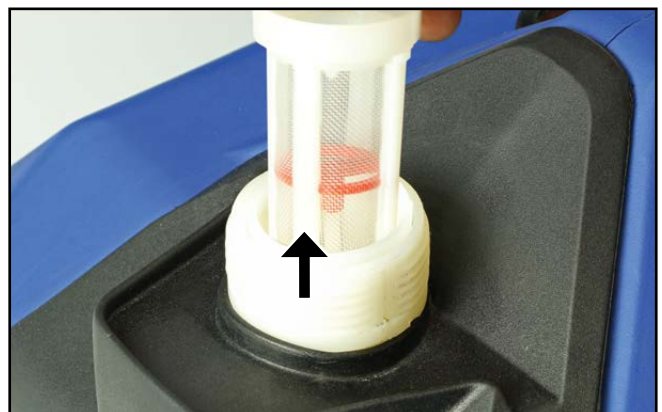

Figure 38 - Removing the Fuel Strainer



# MAINTENANCE

- Pour the contents of the fuel strainer into a suitable waste receptacle. Low pressure compressed air can be used if necessary for blowing onto the outside of the strainer mesh to remove any trapped fine grit.

**NOTICE**

Never dispose of fuel or fuel contaminants by dumping either of them into a sewer, on the ground, or into groundwater or waterways. Always be environmentally responsible. Follow the guidelines of the government agencies for proper disposal of hazardous materials. Consult local authorities or reclamation facility.

- Re-install the fuel strainer by hand inside the filler hole on top of the fuel tank (see Figure 39). Make sure it is fully inserted into the opening.

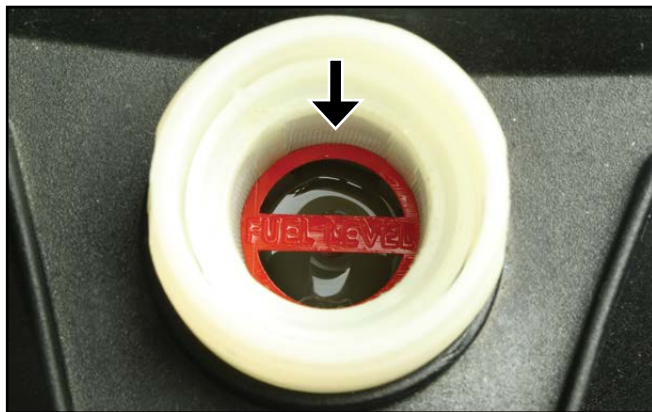

Figure 39 – Re-installing the Fuel Strainer

- Re-install the fuel cap.

## SPARK PLUG MAINTENANCE

Tools required – Phillips head screwdriver (iGen1200 & 4500), 10 mm socket wrench (iGen4500), spark plug socket wrench, spark plug gap tool or feeler gauge, and wire brush.

The spark plug should be checked and cleaned after every 100 hours of use or 6 months and then replaced after 250 hours of use or every year.

- Stop the generator and let it cool for several minutes if it's been running.
- Move the generator to a flat, level surface.
- iGen1200: Loosen the locking screw on the spark plug access cover and then slide open and remove the cover (see Figure 40).  
iGen2200 & 2500: Slide open and remove the spark plug access cover (see Figure 41).  
iGen4500: Remove the engine access cover (see Figure 33).



Figure 40 - iGen1200 Removing the Spark Plug Access Cover



Figure 41 - iGen2200 & 2500 Removing the Spark Plug Access Cover

Table 3: Replacement Spark Plugs

Generator Model	Spark Plug Make and Model				
	Torch	Bosch	Champion	Denso	NGK
iGen1200	A5RTC	-	RZ11Y	U16FSR-U	CR5HSA
iGen2200	E6RTC	WR7BC+	-	W20FPR-U	BPR6HS
iGen2500	E6RTC	WR7BC+	-	W20FPR-U	BPR6HS
iGen4500	F7RTC	WR5DC+	RN7Y	W22EPR-U	BPR7ES



Figure 42 – Removing the Spark Plug Boot

4. Remove the spark plug boot by firmly pulling it up and away from the engine (see Figure 42).

### NOTICE

Never apply any side load or move the spark plug laterally when removing the spark plug. Applying a side load or moving the spark plug laterally may crack and damage the spark plug insulator.

5. Clean area around the spark plug.
6. Use a spark plug socket wrench to remove the spark plug from the cylinder head by unscrewing it anti-clockwise (see Figure 43).



Figure 43 – Removing the Spark Plug

7. Place a clean rag over the opening created by the removal of the spark plug to make sure no dirt can get into the combustion chamber.
8. Inspect the spark plug for:
  - Cracked or chipped insulator; replace the spark plug.
  - Excessive wear of the electrodes; replace the spark plug.
  - Excessive carbon or oil fouling of the electrodes; clean the electrodes with a wire brush or replace the spark plug.

- Spark plug gap of 0.7 mm or 0.028 inch (see Figure 44); after cleaning with a wire brush, check using a spark plug gap tool or feeler gauge and adjust by carefully bending the ground electrode. Always check the gap of a new spark plug before installing it.

When replacing the spark plug, use only the specified part as listed in Table 3.

### NOTICE

Use only the recommended spark plug (Torch brand) or equivalent. The use of a non-recommended spark plug can damage the engine.

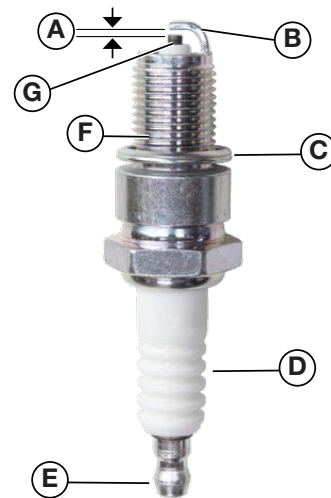

- |                      |                      |
|----------------------|----------------------|
| A - Gap              | E - Terminal         |
| B - Ground Electrode | F - Thread           |
| C - Gasket           | G - Centre Electrode |
| D - Insulator        |                      |

Figure 44 – Spark Plug

9. Install the spark plug by following the steps outlined below:
  - a - Carefully insert the spark plug back into the cylinder head. Hand screw the spark plug clockwise until it bottoms out (seats).
  - b - Use a spark plug socket wrench to finish tightening the spark plug. If re-installing a used spark plug, tighten approximately 1/8 to 1/4 of a turn after the spark plug seats. If installing a new spark plug, tighten approximately 1/4 to 1/2 a turn after the spark plug seats. The tightening torque should not exceed 12 Nm (9 lb-ft) for the iGen1200 or 17 Nm (13 lb-ft) for the iGen2200, 2500 & 4500.
  - c - Replace the spark plug boot, making sure the boot fully engages onto the spark plug's terminal.
10. Re-install the spark plug access cover.





# MAINTENANCE

## SPARK ARRESTER MAINTENANCE

Tools required – iGen2200 & 2500: Phillips head screwdriver and wire brush. iGen4500: Phillips head screwdriver, 10 mm socket wrench and wire brush.

Check and clean the spark arrester after every 100 hours of use or 6 months.

1. Stop the generator and let it cool for several minutes if it's been running.
2. Move the generator to a flat, level surface.
3. iGen2200 & 2500: Remove the muffler access cover by undoing the six screws affixing it to the generator casing (see Figure 45). Clean the cover and especially its vent holes with a rag or brush and then place it aside.  
iGen4500: Remove the engine access cover (see Figure 33) and then the muffler access cover (see Figure 46).
4. Loosen the spark arrester band clamp and slide it off the spark arrester collar (see Figure 47).



Figure 45 – iGen2200 & 2500 Removing the Muffler Access Cover



Figure 46 – iGen4500 Removing the Muffler Access Cover



Figure 47 – Removing the Spark Arrester Band Clamp

5. Loosen the locking screw and pull the spark arrester collar and screen off the muffler exhaust pipe (see Figure 48).



Figure 48 - Removing the Spark Arrester Collar and Screen

6. Use a wire brush to remove any exhaust deposits that may have collected on the spark arrester screen.
7. If the spark arrester screen shows signs of wear such as rips, tears or large openings, it should be replaced.
8. Re-install the spark arrester components in the following order:
  - a - Insert the spark arrester screen into its collar and then slide this assembly onto the muffler exhaust pipe. Take care to align one of the slots in the collar with the locking screw. Push the collar on firmly to ensure that the screen is well seated and tighten the locking screw.
  - b - Place the spark arrester band clamp over the collar with the gap in the band clamp aligned with the collar locking screw. Then tighten the adjusting screw on the band clamp.
9. iGen2200 & 2500: Re-install the muffler access cover.  
iGen4500: Re-install the muffler access cover and then the engine access cover.

## CLEANING THE GENERATOR

The generator should be kept clean and dry at all times to ensure its reliable and safe operation. This must be checked each time before using the generator.

Use a damp cloth which has been soaked in a mixture of household detergent and warm water and then wrung out to remove excess liquid. Wipe the exterior surfaces of the generator clean and then repeat with a damp cloth which has been rinsed in clean water and wrung out. Finish by wiping off all moisture with a dry cloth. Do not use abrasive or solvent cleaners.

A soft, non-metallic bristle brush or a vacuum cleaner may be used to loosen and remove any built-up dirt, mud or other debris. Low pressure compressed air may also be used to blow off any dirt or dust.

Make sure all of the ventilation grilles are clean of any dirt or other debris otherwise the generator may overheat and be damaged.

### NOTICE

NEVER use a water hose or pressure washer to clean the generator. Water may enter the fuel or electric systems and damage the generator. The risk of electric shock is also possible.

## 12 VOLT BATTERY MAINTENANCE iGen4500

The generator's 12 Volt battery is a sealed-for-life type that requires no regular maintenance. It is automatically charged whenever the generator is running.

The battery will self-discharge slowly when not in use and after some time it may have insufficient charge to start the generator; in such an event, the generator can be started manually

### DANGER



Wet cell batteries produce explosive hydrogen gas while charging. If ignited, the hydrogen gas mixture can explode the battery and cause serious injury or blindness. Only charge a battery in a well-ventilated area away from any sources of ignition such as sparks, open flames, matches, cigarettes, CB radios and mobile phones.



The electrolyte fluid inside a battery contains highly corrosive sulphuric acid, which upon contact with the skin or eyes can cause severe burns or blindness. Always wear protective glasses and clothing – including gloves – when working on a battery. Any electrolyte spill should be thoroughly flushed clean with water.

## Charging the Battery

When the generator is not in use, its 12 Volt battery can be charged using a mains-powered 12 Volt battery charger.

Tools required – Flat blade screwdriver, 10 mm spanner and mains-powered 12 Volt battery charger.

1. Ensure the generator is stopped and the engine control switch is in the STOP position.
2. Allow the generator to cool down if it has been running.

### WARNING



NEVER touch both battery terminals simultaneously.  
NEVER place a tool or other metal object across both battery terminals.  
NEVER place a tool or other metal object between either of the battery terminals and any part of the generator.

3. Remove the battery from the generator taking care not to touch the battery terminals against the generator's frame or any other metal surface (see Connecting the Battery on page 18). Keep the battery upright at all times.
4. Disconnect the negative (-) battery cable (black boot) from the negative (-) terminal on the battery.
5. Disconnect the positive (+) battery cable (red boot) from the positive (+) terminal on the battery.



# MAINTENANCE

6. Move the battery to a well-ventilated work bench or other suitable location adjacent to the battery charger.
7. Charge the battery in accordance with the battery charger's instructions.
8. When the battery has finished charging, disconnect it from the battery charger and then re-install it on the generator (see Connecting the Battery on page 18).

## Replacing the Battery

The procedure for replacing the generator's 12 Volt battery with a new one is essentially the same as that described in the preceding section, except a new battery should be re-installed at Step 8 instead of the old one.

## DRAINING THE FUEL

Occasionally it may be necessary to drain all of the fuel out of the generator. For example, to remove contaminated or stale fuel or to prepare the generator for transport or storage.

**Tools required** – Flat blade screwdriver (iGen1200 & 4500), Phillips head screwdriver (iGen2200 & 2500), fuel siphon hand pump and fuel storage container.

1. Turn the fuel cap vent to the ON position (iGen1200, 2200 & 2500).
2. Remove the fuel cap.
3. Clean the fuel strainer (see Fuel Strainer Maintenance on page 33), but do not re-install it.
4. Pour or siphon the contents of the fuel tank into a fuel storage container (see Figure 49).



Figure 49 – Emptying the Fuel Tank

5. Remove the engine access cover (see Figure 26, 27 or 33, as applicable).
6. Locate the fuel drain hose connected to the bottom of the carburettor float bowl. Take note of the hose's stowed position routed downwards and then gently pull the loose end of the hose out of the generator casing.
7. Position the fuel storage container to collect the remaining fuel discharged from the drain hose.
8. Turn the fuel control switch to the ON position.
9. Use the screwdriver to loosen the fuel drain screw and then carefully drain the fuel out (see Figure 50, 51 or 52, as applicable). Take care to wipe up any spills immediately.
10. When all of the fuel has been drained out, tighten the fuel drain screw. Move the storage container and any fuel soaked rags away from the generator. It is preferable to consume the fuel in another engine-powered device straight away or dispose of it properly rather than storing it for a long time with fuel stabiliser for later re-use.



Figure 50 – iGen1200 Draining the Carburettor

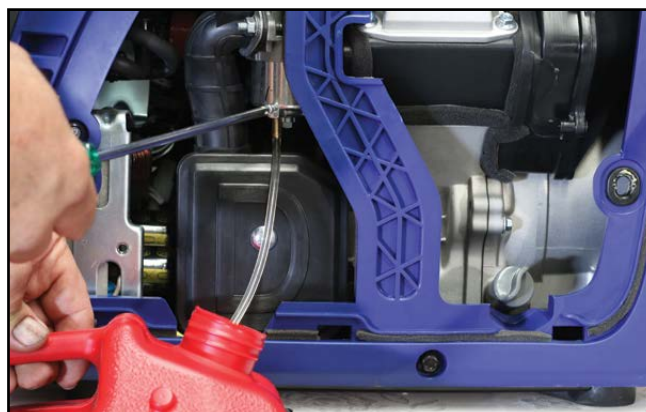

Figure 51 – iGen2200 & 2500 Draining the Carburettor



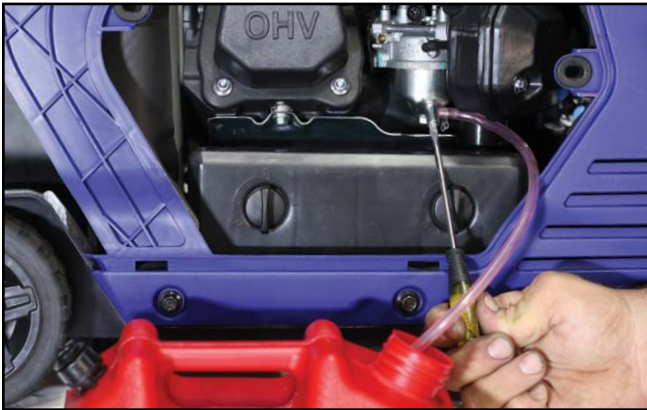

Figure 52 – iGen4500 Draining the Carburettor

## NOTICE

Never dispose of fuel or fuel contaminants by dumping either of them into a sewer, on the ground, or into groundwater or waterways. Always be environmentally responsible. Follow the guidelines of the governmental agencies for proper disposal of hazardous materials. Consult local authorities or reclamation facility.

11. Turn the fuel control switch to the OFF position.
12. Re-stow the fuel drain hose back to its original position routed downwards within the generator casing. Take care to ensure that the hose is correctly routed and not touching any potentially hot components.
13. Re-install the engine access cover.
14. Re-install the fuel strainer.
15. Re-install the fuel cap.
16. Turn the fuel cap vent to the OFF position (iGen1200, 2200 & 2500).

## LONG-TERM STORAGE

### ⚠ WARNING



Never store a generator with fuel in the tank indoors or in a poorly ventilated area where the fumes can come into contact with an ignition source such as: a pilot light of a stove, water heater, clothes dryer or any other gas appliance; or a spark from an electric appliance.

## NOTICE

Fuel stored for as little as 30 days can go bad, causing gum, varnish and corrosive build-up in fuel lines, fuel passages and the engine. This corrosive build-up restricts the flow of fuel, preventing an engine from starting after a prolonged period of storage.

The most commonly experienced faults with portable generators are directly attributable to stale fuel. Such faults are not covered by the generator's warranty.

The generator should be run at least once per month for 30 minutes under no less than one-third load. If this is not possible, the generator should be prepared for long-term storage as described hereunder.

Proper care should be taken to prepare the generator for any long-term storage. This will protect the generator's function and appearance, and will make it easier to start when next required.

## Storage Procedure for 1 – 3 Months

1. Clean the generator as outlined in Cleaning the Generator on page 37.
2. Add a proprietary fuel stabiliser to the fuel tank and then add fresh fuel up to the tank's maximum capacity (see checking and Adding Fuel on page 20). Follow the manufacturer's recommendation for correct amount of stabiliser to add.
3. Start the generator and run it for 10 minutes to ensure that treated fuel is distributed throughout the engine's fuel system.
4. Stop the generator (see Stopping the Generator on page 24).
5. Turn the fuel control switch to the OFF position if not already done in Step 4.
6. Turn the fuel cap vent to the OFF position.
7. Allow the unit to cool down and then move it to a clean, dry place for storage.

## Storage Procedure for Greater than 3 Months

1. Clean the generator as outlined in Cleaning the Generator on page 37.
2. Drain the fuel (see Draining the Fuel on page 38).
3. Start the generator, if possible, and run the engine without load until it stops when the last remnants of fuel have been used. (See Starting the Generator on page 21 and Stopping the Generator on page 24).
4. Change the engine oil (see Changing Engine oil on page 31).



# MAINTENANCE

5. Remove the spark plug (see Spark Plug Maintenance on page 34) and pour a tablespoon of clean engine oil into the spark plug opening. While placing a clean rag over the spark plug opening, slowly pull the recoil starter handle to rotate the engine several times. This will distribute the oil and protect the cylinder wall from corrosion during storage.
6. Re-install the spark plug (see Spark Plug Maintenance on page 34).
7. Slowly pull the recoil starter handle until resistance is felt, at which point the piston is coming up on its compression stroke and both the intake and exhaust valves are closed. Storing the engine in this position will help to prevent internal corrosion.
8. Move the unit to a clean, dry place for storage.

## Removal from Storage

Follow the normal procedures for pre-operation checks and starting (see Before Starting the Generator on page 19).

Use only fresh fuel to re-fill the tank, if necessary, rather than re-using any old fuel.

If oil was inserted into the cylinder prior to storage, the exhaust may smoke for a short while after starting the generator; this is normal and will cease within a minute or so of running time.

## DISMANTLING AND DISPOSAL

There is no requirement for the generator to be dismantled during normal operation other than for major repair / overhaul or prior to final disposal at the end of its service life.

Dismantling should only be carried out by a mechanically proficient person with access to proper tools or alternatively by your authorised Westinghouse service dealer for a fee.

Before dismantling:

1. Stop the generator (see Stopping the Generator on page 24).
2. Drain the engine oil (see Changing Engine Oil on page 31).
3. Drain the fuel (see Draining the Fuel on page 38).

### NOTICE

Do not pollute the environment by improper or illegal disposal of the waste fluids. Dispose of these hazardous items only at an authorised waste collection / recycling facility.

Do not pollute the environment by improper or illegal disposal of the generator either as a whole or in parts. Take the unwanted unit or components to your local recycling centre instead. The generator is made almost entirely of metal that can be recycled.



## TROUBLESHOOTING

### WARNING



Before attempting to service or troubleshoot the generator, the owner or service technician must first read and understand this instruction manual and comply with all safety instructions. Failure to follow all instructions may result in conditions leading to voiding of the product warranty, serious personal injury, property damage or even death.

PROBLEM	POTENTIAL CAUSE	SOLUTION
Engine will not start or starts and runs rough.	1. Low oil level.	1. Check oil level and add oil if necessary.
	2. Generator is out of fuel.	2. Check fuel level and add fuel if necessary.
	3. Fuel is stale or contaminated with water or other foreign substance.	3. Drain fuel and refill with fresh fuel.
	4. Electrical load connected to generator.	4. Unplug any electrical cords or devices from the 240-Volt AC receptacles.
	5. Fuel cap vent is in the OFF position.	5. Move fuel cap vent to the ON position.
	6. Fuel control switch is in the OFF position.	6. Move fuel control switch to the ON or CHOKE position.
	7. Engine control switch is in the STOP position (iGen4500).	7. Push engine control switch into the RUN position (iGen4500).
	8. Engine is not choked (if cold).	8. Move choke control to the START or CHOKE position.
	9. Engine is over choked (if hot).	9. Move choke control to either midway between the START and RUN positions or fully to the RUN or ON position.
	10. Spark plug boot is not properly connected onto spark plug terminal.	10. Push spark plug boot firmly onto spark plug.
	11. Spark plug is dirty or faulty.	11. Clean or replace spark plug.
	12. Air filter is dirty or blocked.	12. Check air filter element and clean if necessary.
	13. Spark arrester is dirty or blocked.	13. Check spark arrester and clean if necessary.
	14. If above possible causes are checked and eliminated, generator may be faulty.	14. Take generator to an authorised Westinghouse service dealer.



# TROUBLESHOOTING

PROBLEM	POTENTIAL CAUSE	SOLUTION
Electric starter will not crank engine fast enough or at all (iGen4500).	1. Electrical load connected to generator.	1. Unplug any electrical cords or devices from the 240-Volt AC receptacles.
	2. Flat battery.	2. Start engine manually or recharge battery using an external battery charger.
	3. Faulty battery.	3. Replace battery.
	4. If above possible causes are checked and eliminated, generator may be faulty.	4. Take generator to an authorized Westinghouse service dealer.
Engine is running, but no 240-Volt AC output is available.	1. If output indicator light is green, 240-Volt AC output should be available.	1. Check connected electrical cord(s) or appliance(s) as described below.
	2. Connected electrical cord or appliance plug is not properly inserted into 240-Volt AC outlet socket.	2. Check connected electrical cord or appliance plug is fully inserted into 240-Volt AC outlet socket.
	3. Connected electrical cord or appliance is faulty.	3. Connect known functioning appliance directly into generator's 240-Volt AC outlet socket to verify electrical output.
	4. If output indicator light is not illuminated, there is no 240-Volt AC output available. In such case: <ul style="list-style-type: none"> <li>If overload alarm light is not illuminated, generator may be faulty.</li> <li>If overload alarm light is red, there is an overload or short circuit in the connected 240-Volt AC load.</li> </ul>	<ul style="list-style-type: none"> <li>Disconnect all electrical cords and devices from generator and press the generator reset button (iGen4500 only). If unresolved, stop and re-start engine with ECO throttle switch in the OFF position. If still unresolved, take generator to an authorised Westinghouse service dealer.</li> <li>Disconnect all electrical cords and devices from generator and press the generator reset button (iGen4500 only). If unresolved, stop and re-start engine with ECO throttle switch in the OFF position. Reconnect and test run 240-Volt AC loads individually; any single cord or device that trips overload alarm is either faulty or too great a load for the generator. Any faulty device must not be used further until checked and approved by a licensed electrician. Check running and starting power demands of total connected electrical load versus generator's rating.</li> </ul>
	5. If above possible causes are checked and eliminated, generator may be faulty.	5. Take generator to an authorised Westinghouse service dealer.

# TROUBLESHOOTING

PROBLEM	POTENTIAL CAUSE	SOLUTION
Engine is running, but no 5 or 12-Volt DC output is available.	1. Connected electrical cord or appliance plug is not properly inserted into the DC outlet socket.	1. Check connected electrical cord or appliance plug is fully inserted into the DC outlet socket.
	2. Connected electrical cord or appliance is faulty.	2. Connect known functioning appliance directly into generator's 12-Volt DC outlet socket to verify electrical output.
	3. Overload or short circuit in the connected DC load	3. Disconnect all electrical cords and devices from generator. Re-start engine with ECO throttle switch in the OFF position. Check that the DC device(s) do not overload the generator's rated DC output(s). Check that the DC device(s) are not faulty, e.g. short circuit. Damage caused to the generator by excessive or faulty DC loads is not covered by warranty.
	4. If above possible causes are checked and eliminated, generator may be faulty.	4. Take generator to an authorised Westinghouse service dealer.
Engine stops during operation.	1. Generator is out of fuel.	1. Check fuel level and add fuel if necessary.
	2. Fuel is contaminated with water or other foreign substance.	2. Drain fuel and refill with fresh fuel.
	3. Fuel cap vent is in the OFF position.	3. Move fuel cap vent to the ON position.
	4. Fuel control switch is in the OFF position.	4. Move fuel control switch to the ON position.
	5. Low oil level.	5. Check oil level and add oil if necessary.
	6. Spark plug boot is not properly connected onto spark plug terminal.	6. Push spark plug boot firmly onto spark plug.
	7. Overload or short circuit in the connected 240-Volt AC load.	7. Disconnect all electrical cords and devices from generator. Re-start generator with ECO throttle switch in the OFF position and then re-connect electrical loads individually if possible. If only single load, check running and starting power demands versus generator's AC output rating.
	8. If above possible causes are checked and eliminated, generator may be faulty.	8. Take generator to an authorised Westinghouse service dealer.

# TROUBLESHOOTING

PROBLEM	POTENTIAL CAUSE	SOLUTION
Engine runs erratically or does not hold steady speed.	1. Power demand of connected 240-Volt AC load may be varying.	1. Engine speed varies when electrical load changes; this is normal operation. It is most noticeable when ECO throttle switch is in the ON position. No fault.
	2. If output indicator and overload alarm are both illuminated, there is an overload in the connected 240-Volt AC load.	2. Switch off or unplug connected 240-Volt AC device(s) to reduce electrical power demand.
	3. Engine is not warm enough.	3. Disconnect all electrical cords and appliances from generator. Allow engine to run for at least 2 minutes after the choke control has been moved to the RUN or ON position before reconnecting electrical loads.
	4. Choke control is in the START or CHOKE position and engine is already warm or hot.	4. Move choke control to the RUN or ON position.
	5. Fuel is stale or contaminated.	5. Drain fuel and refill with fresh fuel.
	6. Air filter is dirty or blocked.	6. Check air filter element and clean if necessary.
	7. If above possible causes are checked and eliminated, generator may be faulty.	7. Take generator to an authorised Westinghouse service dealer.



# SPECIFICATIONS

	PARAMETER	iGen1200	iGen2200	iGen2500	iGen4500
ENGINE	Type	1-Cylinder, 4-Stroke, Overhead Valve, Air Cooled			
	Displacement (cm <sup>3</sup> )	54	79	98	224
	Max. Speed (rpm)	5,200	5,300	5,500	3,600
	Rated Power (kW / hp)	1.3 / 1.8	2.2 / 3.0	2.5 / 3.4	5.4 / 7.3
	Oil Capacity (mL)	250	350	350	600
	Low Oil Shutdown	Yes	Yes	Yes	Yes
	Spark Plug	Torch A5RTC	Torch E6RTC	Torch E6RTC	Torch F7RTC
	Fuel	Unleaded Petrol			
	Fuel Tank Capacity (L)	2.8	4.3	4.3	13.5
	Fuel Gauge	No	No	No	Yes
	Starting Method	Recoil	Recoil	Recoil	Electric
	Battery Included	N/A	N/A	N/A	Yes
	Hour Meter	Yes	Yes	Yes	Yes
	240 V AC ELECTRICAL	Voltage (V)	240	240	240
Frequency (Hz)		50	50	50	50
No. of Phases		1	1	1	1
Running Power (W)		1,000	1,800	2,200	3,700
Starting Power (W)		1,200	2,200	2,500	4,500
Max. Output @ 1.0 PF (kVA)		1.2	2.2	2.5	4.5
Max. Running Current @ 1.0 PF		4.2	7.5	9.2	15.4
Max. Starting Current @ 1.0 PF		5	9.2	10.4	18.8
Voltage & Waveform Control		Digital Inverter, Pure Sine Wave Output			
Receptacle(s)		1 x 15 A, IP44	1 x 15 A, IP44	1 x 15 A, IP44	2 x 15 A, IP44
Overload Protection		Electronic			
Alternator		Brushless, Permanent Magnet			
Output Power Meter		No	No	No	Yes
12 V DC ELECTRICAL		Voltage (V)	12	N/A	N/A
	Maximum Current (A)	5	N/A	N/A	8
	Maximum Power (W)	60	N/A	N/A	100
	Receptacle	1 x 5 A, IP44	N/A	N/A	1 x 8 A, IP44
5 V DC ELECTRICAL	Voltage (V)	5	5	5	5
	Maximum Current (A)	2.1	2.1	2.1	2.1
	Maximum Power (W)	10	10	10	10
	Receptacle	USB Type A, IP44			
DIMENSIONS & WEIGHT	Length (mm)	463	500	500	650
	Width (mm)	262	285	285	480
	Height (mm)	395	450	450	520
	Weight - Dry (kg)	15	21	21.5	49.5
	Weight - Wet (kg)	17	24.5	25	60



Westinghouse

# WIRING DIAGRAMS

## iGen1200 WIRING DIAGRAM

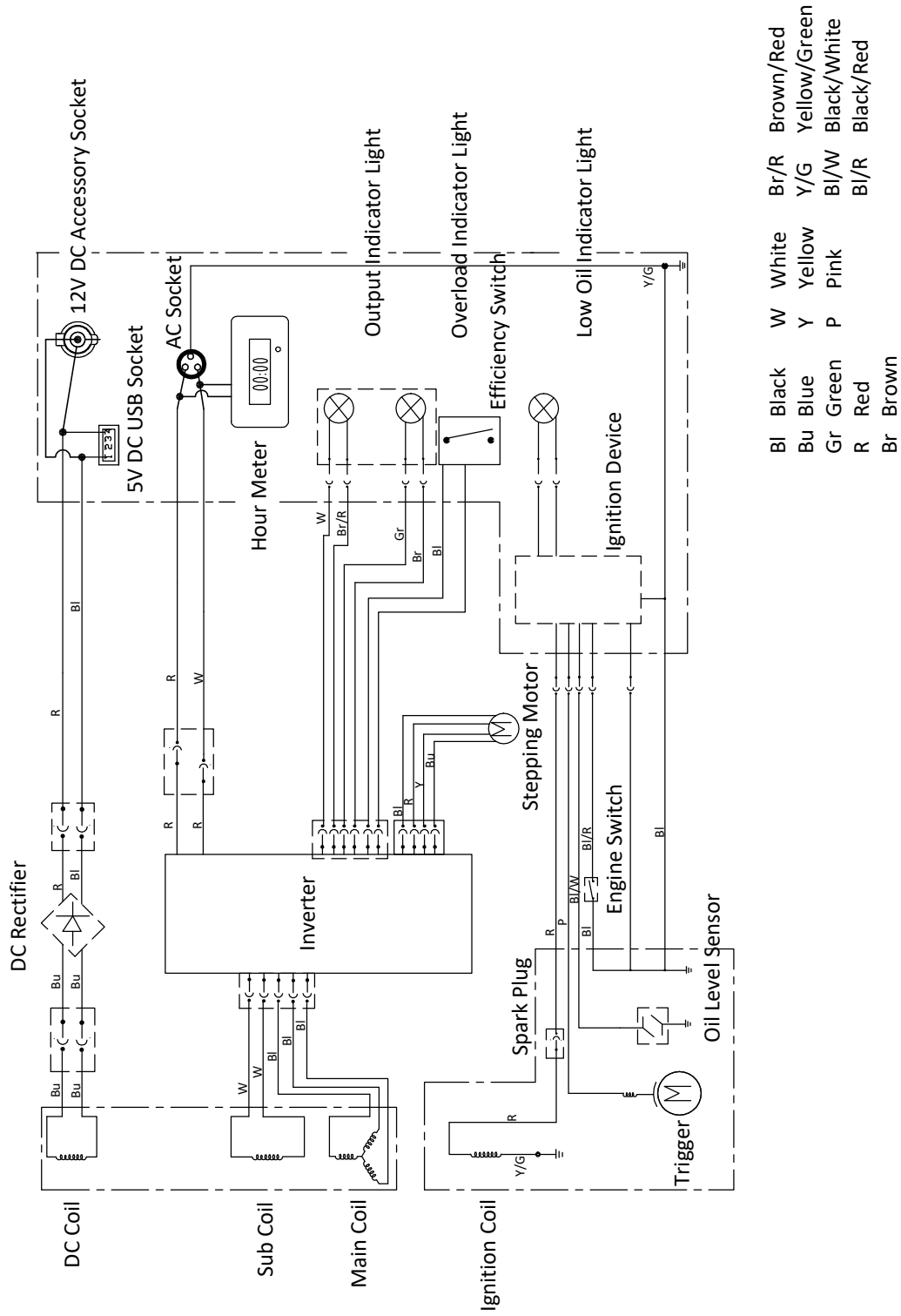

## iGen2200 & 2500 WIRING DIAGRAM

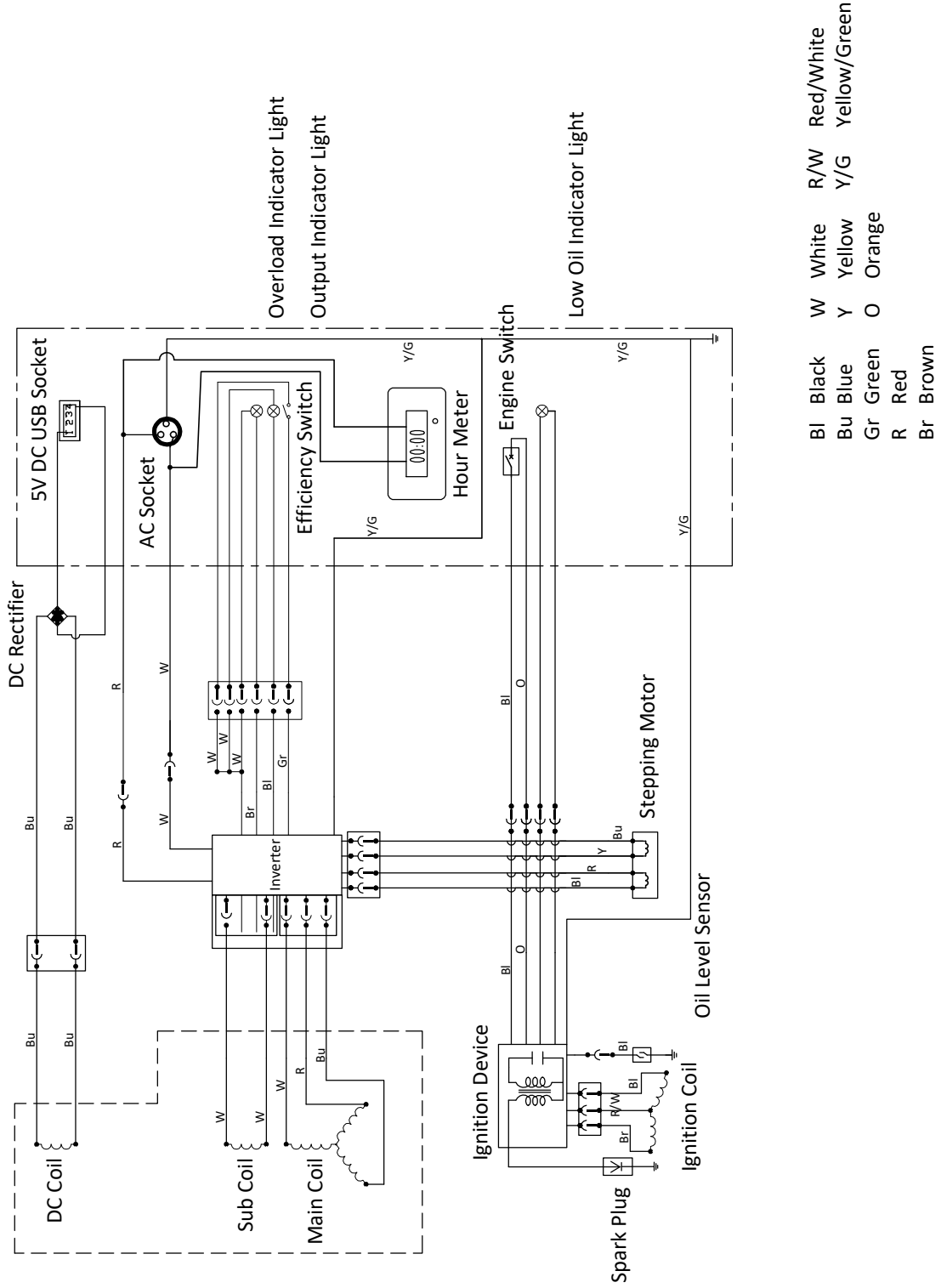

# WIRING DIAGRAMS

## iGen4500 WIRING DIAGRAM

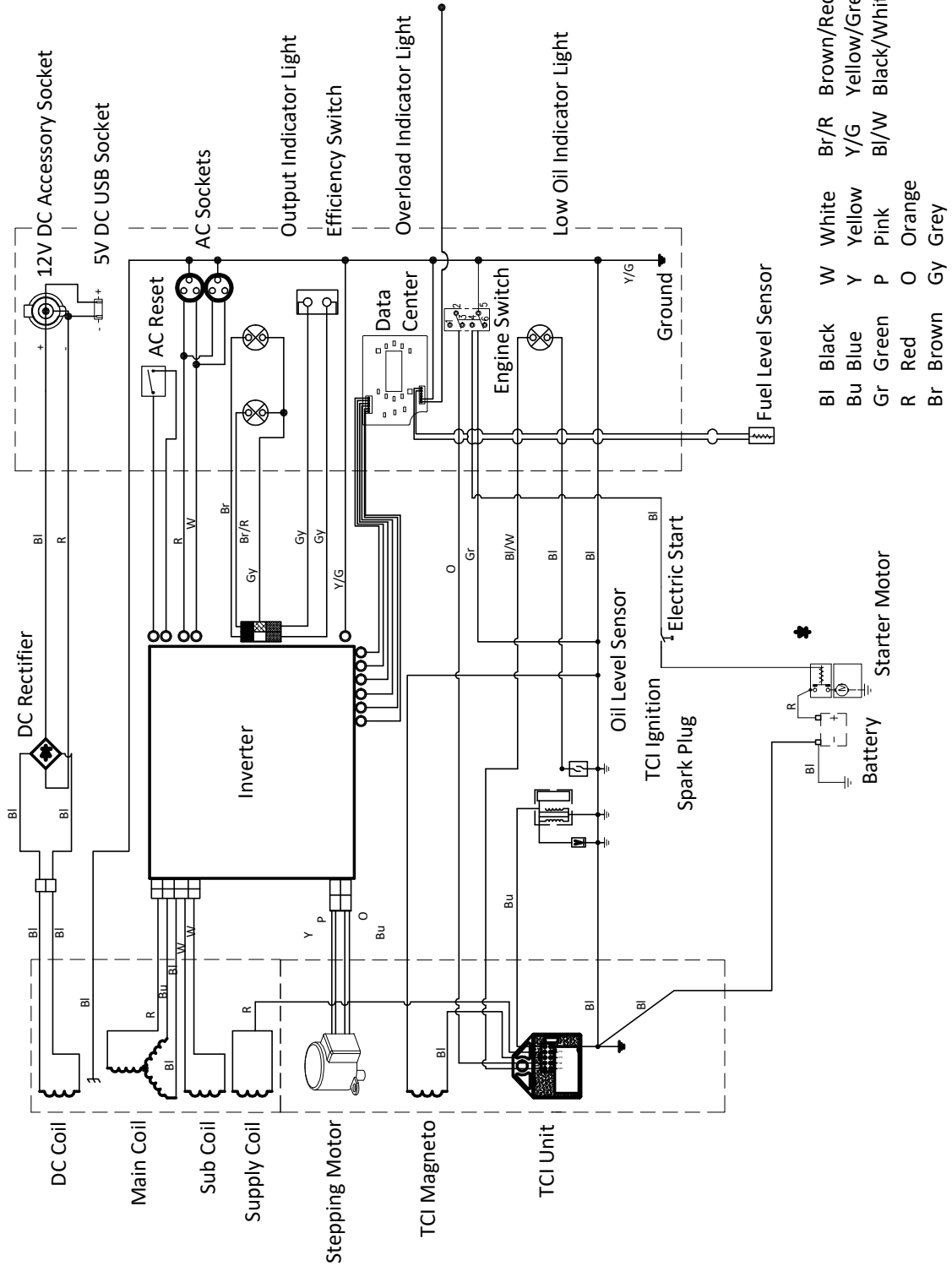



## WARRANTY AGAINST DEFECTS

### Proof of Purchase

It is recommended that you keep a copy of the original tax invoice together with this manual.

#### Warrantor

Name: Glenco Air & Power Pty Ltd  
(ABN 21101370085)  
Address: 21 Resource Street,  
Parkinson, QLD, 4115, Australia  
Phone: (07) 3386 9999  
Fax: (07) 3386 9988  
Email: sales@glencomfg.com.au  
Web: www.glencoairpower.com.au

### Warranty Conditions

Glenco Air & Power Pty Ltd (the "Company") warrants that its Westinghouse portable electric generators (the "Goods") shall be free from defects in material and workmanship for a period of two years (2) years or five hundred (500) operating hours, whichever occurs first, from the date of original sale (hereinafter the "Warranty Period") in normal domestic applications such as personal, residential household or recreational use.

A Warranty Period of one (1) year or five hundred (500) operating hours, whichever occurs first, shall apply in commercial applications such as income producing, rental or other business-related use. Goods sold to a Consumer with an Australian Business Number shall be deemed as being used in a commercial application.

The Warranty Period is continuous from the date of original sale and does not restart upon the repair or replacement of the Goods or any part thereof.

Upon return – transportation charges prepaid by the Consumer – to the Company's or its nominated dealer's premises within the Warranty Period, the Company shall repair or replace, at its option, any Goods which it determines to contain defective material or workmanship, and shall return said Goods to the Consumer free-on-board (FOB) at the Company's or agent's premises. The repair or replacement work will be scheduled and performed according to the Company's normal work flow and availability of replacement parts.

The Company shall not be obligated, however, to repair or replace Goods which have been: repaired by others; abused; improperly installed, operated,

maintained, repaired, transported or stored; not serviced to schedule using genuine spare parts; altered or otherwise misused or damaged in any way.

The Company shall not be responsible for any diagnosis, communication, dismantling, packing, handling, freight, and reassembly or reinstallation charges.

Freight damage, pre-delivery service, normal operating adjustments, preventative maintenance service, consumable items, cosmetic damage, corrosion, erosion, normal wear and tear, performance, merchantability, and fitness for a particular purpose are not covered under this Warranty. Consumable items include batteries, filters, fuel, lubricants and spark plugs.

The Company shall not be liable for any repairs, replacements, or adjustments to the Goods or any costs of labour performed by the Consumer or others without the Company's prior written approval.

To the extent permissible by law and notwithstanding any other clause in these Warranty Conditions, the Company excludes all liability whatsoever to the Consumer arising out of or in any way connected with a contract for any consequential or indirect losses of any kind howsoever arising and whether caused by breach of statute, breach of contract, negligence or other tort.

The Company's liability will be limited to, in the case of products, the replacement of the products, the supply of equivalent products or the payment of the cost of replacing the products or of acquiring equivalent products or, in the case of services, the supply of the services again or the payment of the cost of having the services supplied again. The choice of remedy will be at the discretion of the Company and the Consumer acknowledges that this limitation of liability is fair and reasonable.

This Warranty is available only to the original Consumer bearing the original tax invoice from the Company or one of its authorised dealers as proof of purchase. Goods purchased from any other party such as a private seller, auction house, eBay seller, etc. are not covered by this Warranty.

Our Goods come with guarantees that cannot be excluded under the Australian Consumer Law. You are entitled to a replacement or refund for a major failure and compensation for any other reasonably foreseeable loss or damage. You are also entitled to have the Goods repaired or replaced if the Goods fail to be of acceptable quality and the failure does not amount to a major failure.



# NOTES

---





# Westinghouse

INNOVATION YOU CAN BE SURE OF

**Westinghouse Portable Power**

777 Manor Park Drive  
Columbus OH 43228 USA  
[www.westinghouse.net.au](http://www.westinghouse.net.au)

© 2018 All rights reserved. Content may change without notice.  
Ⓜ, Westinghouse, and INNOVATION YOU CAN BE SURE OF  
are trademarks of the Westinghouse Electric Corporation used  
under license by MWE Investments, LLC. All rights reserved.

February 2018