



Section H

08/2013

Web Revision 12/17/2015



Ford Water Meter Couplings and Accessories



Contents

	Page
Information	
Meter Coupling Numbering System	3
Pack Joint Couplings - How the Pack Joint Works	4
Quick Joint Couplings - How the Quick Joint Works	4
Grip Joint Couplings - How the Grip Joint Works	5
Ultra-Tite Couplings - How the Ultra-Tite Works	5
Code Marks for Ford Compression Coupling Nuts	5
Types of Pipe and Tubing - Explanation of Abbreviations	5
Straight Meter Couplings with Pack Joints	6
Lok-Pak Meter Couplings	6
Insert Stiffeners	7
Dimension Comparison Table for Plastic, Copper and Galvanized Iron	7
Copper Rounding Tool	7
Meter Gaskets	8
Resetter Gaskets	8
Hex Bars for Body Style C Couplings	8
Dielectric Bushings	8
Straight Meter Couplings	
Meter Coupling Nuts Only	8
Straight Meter Couplings by Male Iron Pipe Thread	9
Straight Meter Couplings with Integral Check Valves	9
Straight Meter Couplings by Female Iron Pipe Thread and Flare Copper	9
Straight Meter Couplings with Pack Joints	10
Angle Meter Couplings	10
Flanged Meter Couplings	
Flanged Ells for 1-1/2" and 2" Meters	11
Lok-Pak Meter Couplings for Flanged Meters	11
Lok-Pak Meter Couplings for Tapped Meters	11
Meter Flanges	12
Meter Adapters	12
Meter Idlers	13
Meter Coupling Bushings (3/4" through 2")	13
“U” Branch Pieces	14
Angle “U” Branch Pieces	14
Warranty	16

Due to design improvements, product images in the catalog do not always reflect the most current design detail.

Ford Water Meter Couplings and Accessories Numbering System

TYPE OF COUPLING OR ACCESSORY	SIZE OF INLETS - OUTLETS (one end - other end)	METER CONNECTION SIZE
C = Straight Coupling	1 = 1/2" (or 5/8" for meter nut)	1 = 5/8"
CF = Couplings for Flanged Meters	2 = 5/8" (or 5/8"x3/4" & 3/4" for meter nut)	2 = 5/8"x3/4" & 3/4"
CT = Couplings for Tapped Meters	3 = 3/4"	4 = 1"
L = 90° Elbow	4 = 1"	6 = 1-1/2"
LA = Eighth Bend	5 = 1-1/4"	7 = 2"
LF = Flanged Ells	6 = 1-1/2"	
TA = Tapped Meter Adapter	7 = 2"	
U = Branch Piece (7-1/2" standard length)		
UA = Angle Branch Piece (6-1/2" length)		

Note: Separate meter nuts, gaskets, adapters and bushings are item specific, please refer to catalog for number.

L 3 1 - 2 3 D - NL ← -NL = No Lead Alloy ▲

TYPE OF INLETS - OUTLETS (one end - other end)	
1 = Female Iron Pipe Threads	6 = Pack Joint for PE Pipe
2 = Flare Copper Tube Nut	7 = Pack Joint for PVC Pipe (Schedule 40 & 80)
3 = Meter Nut or Flange	8 = Male Iron Pipe Threads
4 = Pack Joint for Plastic or Copper Tube (CTS)	0 = Female Copper Tube Nut Thread or 'Special'
5 = Pack Joint for Iron Pipe	

OPTIONAL FEATURES
D = Test/Drain Valve
-G = Grip Joint
NE = New England Threads
-Q = Quick Joint (for indicated items)
TW-Q = CTS Quick Joint with Tracer Wire Terminal
U-AWT = Ultra-Tite (components assembled watertight)

▲ Ford Meter Box no-lead brass products manufactured from UNS/CDA No. 89833 alloy shall contain no more than 0.25% total lead content by weight. United States federal and state laws allow the use of products manufactured from UNS C83600 85-5-5-5 brass alloy for only non-potable water systems within the United States. The same UNS C83600 85-5-5-5 brass alloy, also referenced as gunmetal or LG2, is specified and used in potable water systems in most other countries.

Remove "-NL" from catalog number to have products manufactured from UNS C83600 85-5-5-5 brass alloy.

Parties responsible for monitoring and maintaining proper water system design must exercise full responsibility in understanding and upholding the full intent and scope of applicable lead laws.

Note: See item listings in catalog section H to ensure desired sizes and options are available.

Ford offers many products listed to specific standards and classifications. Due to the forthcoming standards changes understood during the publication of this catalog, product listings will evolve to meet the changing standards requirements. Please contact the Ford Meter Box Customer Service Department at 260-563-3171 or local Ford distributor to verify a product meets a specific standard. Ford Meter Box meets your needs for products that are proven and reliable.



Pack Joint Couplings

In a compression coupling, too much can hurt as much as too little. Excessive mechanical pullout resistance, for example, could mean ripping the corporation stop from the main if a backhoe catches the service line. Ford Pack Joints offer a balanced design on every type of pipe. Stab the pipe into the fitting, tighten the EPDM gasketed nut for a watertight seal, and tighten the clamp screw. You get all the pullout resistance you need for the heaviest backfill loads, but not more than you need.

Pack Joint Connections - How the Pack Joint Works

1. Tightening the large Pack Joint nut compresses an EPDM beveled gasket to make it watertight around the pipe or tubing.
2. For copper or plastic tubing and pipe there is a locking device, a split clamp, which is drawn down securely on the tubing or pipe by tightening a stainless steel screw. Machined grooves in the clamp provide positive gripping action.
3. For iron pipe a stainless steel set screw on the Pack Joint bites into and locks on to hold the pipe.

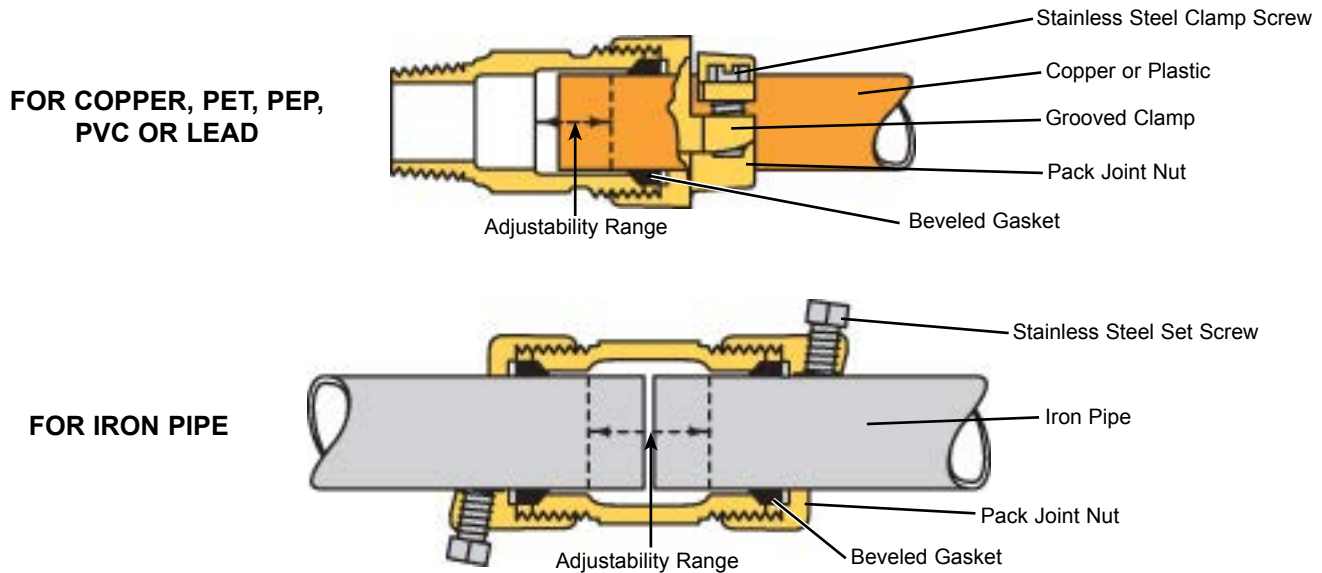

Quick Joint Couplings

The Ford Quick Joint offers traditional Ford features of quality and reliability. This easy-to-use fitting is available on a wide variety of Ford products. Just stab the copper or plastic tubing into the fitting and tighten down the compression nut to the stop. That's it! The Quick Joint provides excellent pullout resistance and superior hydraulic blow-off protection. Note: The Ford Quick Joint Nut **IS NOT** interchangeable with other compression fittings.

Quick Joint Connections - How the Quick Joint Works

1. A stainless steel gripper ring, molded into a large gasket, is drawn down when the nut is tightened, providing the hydraulic seal and mechanical restraint.
2. A transparent fluorocarbon coating covers the interior of the nut, providing smooth torque transfer. This coating eliminates "back drive", reduces tightening torque and minimizes gasket distortion.
3. A positive, external and visual stop ensures correct installation, providing maximum performance.

The Ford Quick Joint is designed and manufactured for copper or for copper tube size SDR 9 Polyethylene plastic with a solid tubular metal insert.

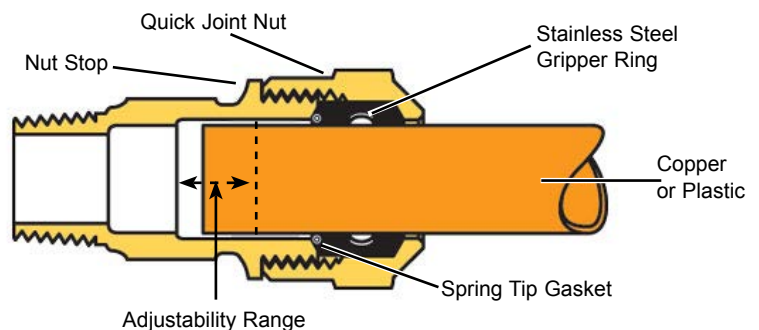

Grip Joint Couplings

Grip Joint Connections - How the Grip Joint Works

1. Tightening the Grip Joint nut compresses an EPDM beveled gasket to form a watertight seal around the pipe or tubing.
2. The bronze gripper ring is drawn down when the nut is tightened, providing the mechanical lock on the pipe.
3. Grip Joint couplings are to be used only with 3/4" through 2" copper or PET, and 3/4" & 1" PEP.



Ford Grip Joint

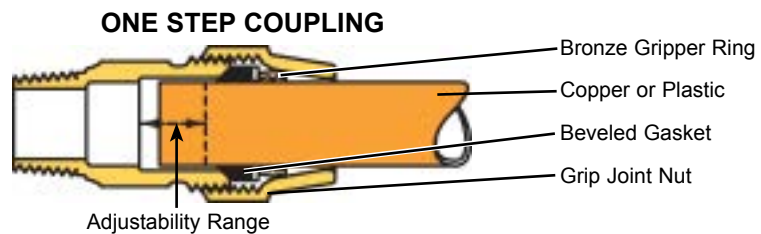

Ford Ultra-Tite Couplings

The Ford Ultra-Tite compression coupling provides an immediate lock onto Polyethylene Pipe (PEP/IPS) or Polyethylene Tubing (PET/CTS) when inserted to the internal stop.

Ford Ultra-Tite Connections - How the Ultra-Tite Works

1. An integral stop within the coupling ensures full pipe insertion.
2. The directional serrations of the plastic grip ring engage the outside diameter of the pipe or tubing providing a mechanical seal and lock.
3. The internal O-ring provides a hydraulic seal.

STAB COUPLING FOR 3/4" AND 1" PEP AND PET (No insert required or recommended.)

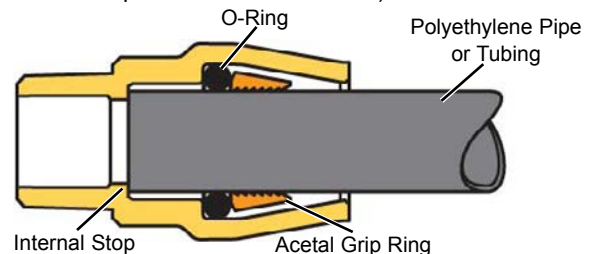

Installation instructions are shipped with product and posted on the Ford Meter Box website. Consult pipe or tubing manufacturer for specific installation requirements.

Ultra-Tite couplings on corporation stops are assembled hand tight and must be removed for drilling or tapping machine adaptation to corporation stop outlet thread. Once the tap is made, the Ultra-Tite should be securely tightened to the corporation stop outlet thread. A female iron pipe adapter will be needed for drilling or tapping machine adaptation when using corporation stops with Ultra-Tite connections. **Contact factory if using adapters other than female iron pipe.**

Code Marks for Ford Compression Coupling Nuts

- CTS - Copper and PET
- PEP - PE pipe
- PVC - PVC pipe



Ford Pack Joint

Types of Pipe and Tubing

Explanation of Abbreviations

Copper Tube - CTS - Copper tubing is widely used as a service line and the **outside diameter** is closely held by manufacturers. The outside diameter of copper tubing has become a standard in the industry and is known as "copper tube size."

Plastic Tubing - CTS - Flexible water service tubing in what is referred to as "copper tube size." Plastic tube refers to *any* plastic with the same **outside diameter** as corresponding sizes of copper tube. PET - Polyethylene tubing.

Plastic Pipe - PEP - Flexible water service pipe in what is referred to as "pipe size." Plastic pipe refers to *any* pipe having the same **inside diameter** as corresponding sizes of standard iron pipe. PEP - Polyethylene pipe.

PVC Pipe - PVC - Polyvinyl Chloride rigid plastic pipe. PVC pipe refers to polyvinyl chloride rigid plastic pipe having the same **outside diameter** as corresponding sizes of standard iron pipe.

Ford Pack Joints for PVC are recommended for use only with Schedule 40 and Schedule 80 PVC.

Meter Couplings

Straight Meter Couplings with Pack Joints

Connecting meters to iron, copper or plastic service lines, old or new, is expedited with Ford Pack Joint Meter Couplings. The Pack Joint connection makes a tight, permanent joint on copper, plastic or iron pipe *without flaring, soldering or threading*. The Pack Joint provides adjustability for inaccuracies in pipe length and alignment. See page 4 for further information on how the Pack Joint works.

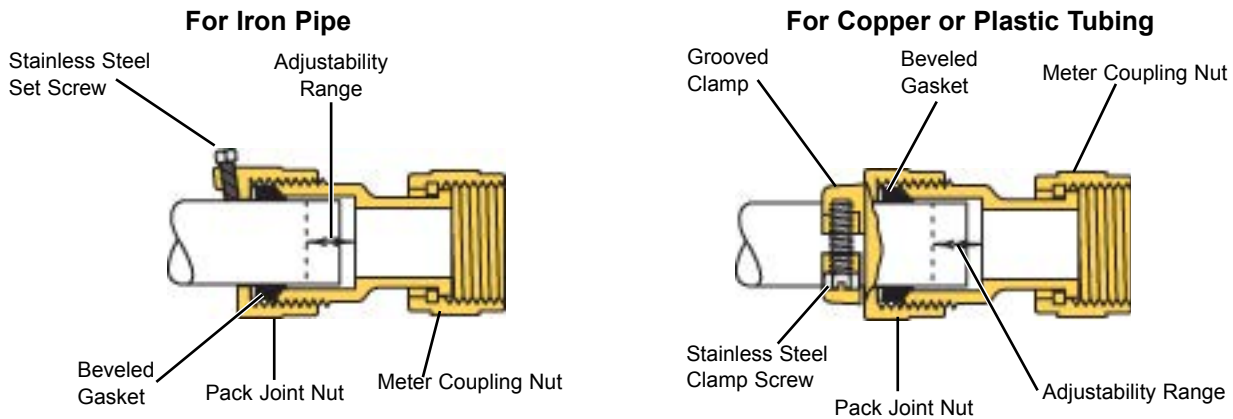

Lok-Pak Meter Couplings

Lok-Pak Couplings simplify the installation of 1-1/2" and 2" water meters and facilitate meter changing. They provide adjustability of spacing for the meter, and a measure of flexibility in the piping. Joints are dependably and permanently watertight and eliminate pipe threading and/or tube flaring.

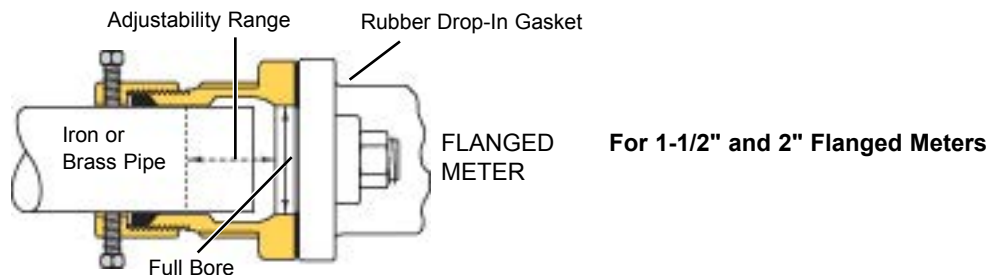

As shown in the drawing, each Lok-Pak Coupling for a flanged meter has a lateral adjustment of 2".

The Pack Joint on all Lok-Pak Couplings tightens easily. The Pack Joint nut is locked in place on iron or brass pipe by two stainless steel set screws, and on copper or plastic by a grooved split clamp with a clamp screw. Details of the Ford Pack Joint are shown and described on page 4.

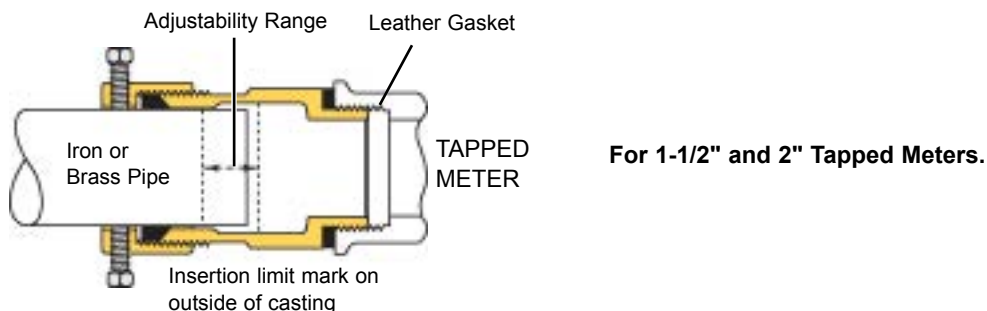

Each coupling for a tapped meter provides adjustment of about 1". To assure space for retraction from the meter, each coupling for tapped meters has a line on the casting to show the limit to which iron, brass or copper pipe can be inserted.

Accessories

Insert Stiffeners

Ford Insert Stiffeners are solid 304 tubular stainless steel, dimpled and flanged to retain placement within the service line.

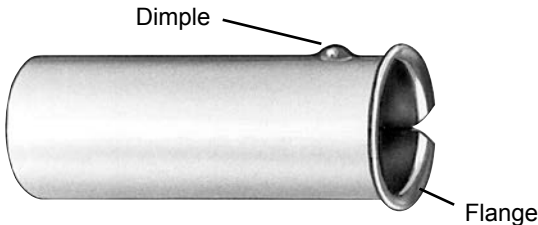

Before using Ford Insert Stiffeners, be sure inside tubing or pipe dimensions correspond to the table below.

Ford recommends using insert stiffeners with plastic pipe or tubing.

Note: Consult pipe or tubing manufacturer for specific installation requirements.

50 Series For Polyethylene Tubing (PET)

CATALOG NUMBER	NOMINAL SIZE	PET ID	APPROX. WT. LBS.*	STD. PKG. QTY.
INSERT-51	3/4"	0.681	4.8	200
INSERT-52	1"	0.875	4.2	100
** INSERT-53-72	1-1/4"	1.069	2.4	50
**♦ INSERT-53-72-Q	1-1/4"	1.069	2.4	50
INSERT-54	1-1/2"	1.263	3.1	25
INSERT-55	2"	1.653	6.0	40
♦INSERT-54-Q	1-1/2"	1.263	2.6	30
♦INSERT-55-Q	2"	1.653	5.8	50

70 Series For Polyethylene Pipe (PEP)

CATALOG NUMBER	NOMINAL SIZE	PEP ID	APPROX. WT. LBS.*	STD. PKG. QTY.
INSERT-71	3/4"	0.824	4.4	100
** INSERT-53-72	1"	1.049	2.9	50
**♦ INSERT-53-72-Q	1"	1.049	2.9	50
INSERT-73	1-1/4"	1.380	5.8	75
INSERT-74	1-1/2"	1.610	5.5	45
INSERT-75	2"	2.067	9.7	50

Inserts For OD Controlled High Density Polyethylene (HDPE) Pipe with PVC O.D.

CATALOG NUMBER	NOMINAL SIZE AND PIPE TYPE	DR	HDPE OD	NOMINAL ID
** INSERT-53-72	1" IPS	11	1.315	1.06
INSERT-73-DR11	1-1/4" IPS	11	1.660	1.34
INSERT-74-DR11	1-1/2" IPS	11	1.900	1.53
INSERT-75-DR11	2" IPS	11	2.375	1.92

* Weights for insert stiffeners are for standard package quantities.

** INSERT-53 (-Q) and INSERT-72 (-Q) fit 1-1/4" plastic tubing (1.069 I.D.), 1" plastic pipe (1.049 I.D.) and 1" IPS HDPE (1.055 I.D.)

♦ These inserts are specifically designed and required for Quick Joint Fittings. They **ARE NOT** interchangeable for use with any other types of compression fittings.

DIMENSION COMPARISON TABLE FOR PLASTIC, COPPER AND GALVANIZED IRON

PIPE AND TUBING TYPE	PSI	SDR	CONTROL	O.D.						I.D.					
				1/2"	3/4"	1"	1-1/4"	1-1/2"	2"	1/2"	3/4"	1"	1-1/4"	1-1/2"	2"
Copper	-	-	OD	0.625	0.875	1.125	1.375	1.625	2.125	-	-	-	-	-	-
PET	PE3408 200 PE4710 250	SDR9	OD	0.625	0.875	1.125	1.375	1.625	2.125	-	0.681	0.875	1.069	1.263	1.653
PEP	PE3408 200 PE4710 250	SIDR7	ID	-	1.060	1.349	1.774	2.070	2.657	-	0.824	1.049	1.380	1.610	2.067
PVC	-	-	OD	0.840	1.050	1.315	1.660	1.900	2.375	-	-	-	-	-	-
Galv IP	-	-	OD	0.840	1.050	1.315	1.660	1.900	2.375	-	-	-	-	-	-

Ford Pack Joints for PVC are recommended for use only with Schedule 40 and Schedule 80 PVC.

Copper Rounding Tool

When copper tubing is used, Ford recommends that it be checked to see if it is perfectly round. Compression couplings do not perform properly if the tubing is out-of-round. Unrounded copper can result in a marginal gasket seal that may eventually permit leakage. The Copper Rounding Tool forms the copper tubing for a proper fit.



CATALOG NUMBER	TUBE SIZE	APPROX. WT. LBS.
CRT-3	3/4"	0.7
CRT-4	1"	1.4
CRT-5	1-1/4"	2.3
CRT-6	1-1/2"	3.8
CRT-7	2"	8.0

Meter Gaskets



CATALOG NUMBER	DESCRIPTION - USAGE	APPROX. WT. LBS.*	STD. PKG. QTY.
GT-109	5/8" Composition Coupling Gasket - 5/8" Meter	3.0	1000
GT-116	3/4" Composition Coupling Gasket - 5/8"x3/4" & 3/4" Meter	2.3	500
GT-121	1" Composition Coupling Gasket - 1" Meter	2.8	400
GT-167	5/8" Leather Coupling Gasket - 5/8" Meter	2.2	1000
GT-113	3/4" Leather Coupling Gasket - 5/8"x3/4" & 3/4" Meter	1.8	500
GT-163	1" Leather Coupling Gasket - 1" Meter	2.2	400
GT-110	Leather Changeover Coupling Gasket for changing 5/8" Meter to 5/8"x3/4" Meter	-	-
GT-108	5/8" Rubber Coupling Gasket - 5/8" Meter	2.8	1000
GT-114	3/4" Rubber Coupling Gasket - 5/8"x3/4" & 3/4" Meter	2.0	500
GT-120	1" Rubber Coupling Gasket - 1" Meter	2.6	400
GT-124	1-1/4" Rubber Coupling Gasket - 1-1/4" Meter	-	-
GT-140	1-1/2" Rubber Drop-In Gasket - 1-1/2" Flanged Meter	2.2	50
GT-141	2" Rubber Drop-In Gasket - 2" Flanged Meter	2.5	50
GT-131	1-1/2" Rubber Gasket - 1-1/2" Tapped Meter	-	-
GT-135	2" Rubber Gasket - 2" Tapped Meter	-	-
GT-126	1-1/2" Rubber Coupling Gasket - 1-1/2" Male Threaded Meter	-	-
GT-127	2" Rubber Coupling Gasket - 2" Male Threaded Meter	-	-

Gaskets are furnished with all meter coupling connections in 5/8", 3/4" and 1" sizes. Rubber drop-in gaskets are furnished with all flanges. All gaskets are 1/8" thick.

* Weights for gaskets are for standard package quantities.

Rubber Resetter Gaskets



CAT. NO.	DESCRIPTION - USAGE
GT-108	5/8" Rubber Resetter Gasket for 5/8" meter
GT-114	3/4" Rubber Resetter Gasket for 5/8"x3/4" and 3/4" meter
GT-120	1" Rubber Resetter Gasket for 1" meter

Hex Bars for Body Style C



CATALOG NUMBER	DESCRIPTION	WRENCH SIZE	APPROX. WT. LBS.	STD. PKG. QTY.
HBW-3	for 3/4" Couplings, body style C	11/16"	0.6	-
HBW-4	for 1" Couplings, body style C	13/16"	0.6	-

Dielectric Bushings (for insulating service lines)

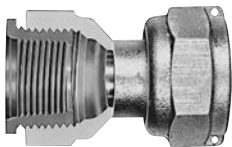

CATALOG NUMBER	DESCRIPTION	APPROX. WT. LBS.	STD. PKG. QTY.
DB-34	3/4" Female Pipe Thread x 1" Male Pipe Thread	-	-
DB-45	1" Female Pipe Thread x 1-1/4" Male Pipe Thread	-	-
DB-56	1-1/4" Female Pipe Thread x 1-1/2" Male Pipe Thread	-	-
DB-67	1-1/2" Female Pipe Thread x 2" Male Pipe Thread	-	-
DB-78	2" Female Pipe Thread x 2-1/2" Male Pipe Thread	-	-

Examples: DB-34 and C31-24-NL assembly will insulate a 3/4" line, a DB-45 and C31-45-NL will insulate a 1" line.

Meter Coupling Nuts Only

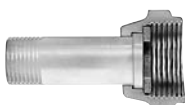

CATALOG NUMBER	DESCRIPTION	APPROX. WT. LBS.	STD. PKG. QTY.
MN-1	5/8" Meter Coupling Nut Only for "A" and "C" Body Style Straight Meter Couplings	0.14	-
CMC	5/8" to 3/4" Changeover Meter Coupling Nut for Changing 5/8" "A" Body Style Coupling from 5/8" meter to 5/8"x3/4" Meter	0.23	50
MN-2	3/4" Meter Coupling Nut Only for "A" and "C" Body Style Straight Meter Couplings	0.24	-
MN-4	1" Meter Coupling Nut Only for "A" and "C" Body Style Straight Meter Couplings	0.31	-
MN-7	2" Meter Coupling Nut Only for "A" and "C" Body Style Straight Meter Couplings	-	-

Straight Meter Couplings

Straight Meter Couplings by Male Iron Pipe Thread



Body Style A
(hex on barrel)



Body Style B
(heavy hex on barrel)



Body Style C
(short with inside
wrench hex)

CATALOG NUMBER	Description of Coupling			APPROX. WEIGHT LBS.	STANDARD PACKAGE QUANTITY
	BODY STYLE	MALE IRON PIPE THREAD SIZE	COUPLING LENGTH		
FOR 5/8" METERS					
C38-11-2-NL	A	1/2"	2"	0.3	50
C38-11-2-188-NL	A	1/2"	2-3/16"	0.4	50
**C38-11-2-375-NL	A	1/2"	2-3/8"	0.4	40
C38-13-2-188-NL	B	3/4"	2-3/16"	0.4	40
FOR 5/8" x 3/4" AND 3/4" METERS					
C38-21-1-625-NL	B	1/2"	1-5/8"	0.5	35
C38-21-2-375-NL	A	1/2"	2-3/8"	0.6	25
C38-23-1-437-NL	C	3/4"	1-7/16"	0.4	35
C38-23-1-5-NL	C	3/4"	1-1/2"	0.4	35
C38-23-1-625-NL	C	3/4"	1-5/8"	0.4	35
C38-23-2-NL	A	3/4"	2"	0.5	30
C38-23-2-25-NL	A	3/4"	2-1/4"	0.5	25
**C38-23-2-5-NL	A	3/4"	2-1/2"	0.5	25
C38-23-2-75-NL	A	3/4"	2-3/4"	0.5	25
C38-23-3-NL	A	3/4"	3"	0.5	25
C38-23-8-5-NL	A	3/4"	8-1/2"	1.6	35
C38-23-12-NL	B	3/4"	12"	2.3	25
C38-24-2-5-NL	B	1"	2-1/2"	0.6	24
FOR 1" METERS					
C38-44-1-5-NL	C	1"	1-1/2"	0.6	20
C38-44-2-NL	C	1"	2"	0.6	18
C38-44-2-25-NL	B	1"	2-1/4"	0.8	18
**C38-44-2-625-NL	A	1"	2-5/8"	0.7	15
C38-44-3-5-NL	A	1"	3-1/2"	0.7	15
C38-44-8-5-NL	A	1"	8-1/2"	1.6	5
FOR 1-1/4" METERS					
C38-54-2-75-NL	A	1"	2-3/4"	1.2	12
FOR 1-1/2" METERS					
C38-66-2-875-NL	A	1-1/2"	2-7/8"	1.8	8
FOR 2" METERS					
C38-77-NL	A	2"	3-1/16"	3.0	4

** Standard coupling length

Straight Meter Couplings by Female Iron Pipe Thread and Flare Copper

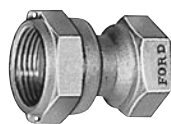

Catalog Number	Description		Coupling Length	Approx. Wt. Lbs.	Std. Pkg. Qty.
METER SWIVEL NUT BY FEMALE IRON PIPE THREAD					
C31-13-NL	5/8" Meter	x 3/4" Female Iron Pipe	1-7/8"	0.5	30
C31-23-NL	5/8"x3/4" & 3/4" Meter	x 3/4" Female Iron Pipe	1-3/4"	0.6	30
C31-24-NL	5/8"x3/4" & 3/4" Meter	x 1" Female Iron Pipe	2"	0.7	25
C31-44-NL	1" Meter	x 1" Female Iron Pipe	2-3/8"	0.9	15
C31-45-NL	1" Meter	x 1-1/4" Female Iron Pipe	2-3/8"	1.1	12
METER SWIVEL NUT BY FLARE COPPER					
C32-13-NL	5/8" Meter	x 3/4" Flare Copper	2-3/16"	0.8	20
C32-23-NL	5/8"x3/4" & 3/4" Meter	x 3/4" Flare Copper	2-3/16"	0.9	20
C32-44-NL	1" Meter	x 1" Flare Copper	2-1/2"	1.4	12

Note: Length of couplings for flare copper is measured less the copper tube nut.

Straight Meter Couplings with Integral Check Valves

Straight Meter Couplings by Male Iron Pipe Thread



CATALOG NUMBER	BODY STYLE	MALE IRON PIPE THREAD SIZE	COUPLING LENGTH	NUMBER OF CHECK VALVES	APPROX. WT. LBS.	STD. PKG. QTY.
For 5/8" x 3/4" and 3/4" Meters						
C38-23H1-2-5-NL	B	3/4"	2-1/2"	1	0.6	-
C38-23H2-2-5-NL	B	3/4"	2-1/2"	2	0.6	20
For 1" Meters						
C38-44H1-2-625-NL	B	1"	2-5/8"	1	0.8	15
C38-44H2-3-NL	B	1"	3"	2	1.0	15

Straight Meter Couplings With Pack Joints



CATALOG NUMBER	DESCRIPTION	APPROX. WT. LBS.	STD. PKG. QTY.
METER SWIVEL NUT BY PACK JOINT FOR COPPER OR PLASTIC TUBING (CTS)			
C34-11-NL	5/8" Meter x 1/2" CTS P.J.	0.7	25
▶♦ C34-13-NL	5/8" Meter x 3/4" CTS P.J.	0.7	20
C34-21-NL	5/8"x3/4" & 3/4" Meter x 1/2" CTS P.J.	0.9	20
C34-22-NL	5/8"x3/4" & 3/4" Meter x 5/8" CTS P.J.	0.8	-
▶♦ C34-23-NL	5/8"x3/4" & 3/4" Meter x 3/4" CTS P.J.	0.8	18
▶♦ C34-24-NL	5/8"x3/4" & 3/4" Meter x 1" CTS P.J.	0.9	15
▶♦ C34-44-NL	1" Meter x 1" CTS P.J.	1.2	12
■♦ C34-44-4-75-NL	1" Meter x 1" CTS P.J.	1.7	10
C34-45-NL	1" Meter x 1-1/4" CTS P.J.	1.7	8
METER SWIVEL NUT BY PACK JOINT FOR IRON PIPE			
C35-11-NL	5/8" Meter x 1/2" Iron Pipe P.J.	0.6	24
C35-13-NL	5/8" Meter x 3/4" Iron Pipe P.J.	0.6	20
C35-21-NL	5/8"x3/4" & 3/4" Meter x 1/2" Iron Pipe P.J.	0.7	20
C35-23-NL	5/8"x3/4" & 3/4" Meter x 3/4" Iron Pipe P.J.	0.8	18
■ C35-23-4-875-NL	5/8"x3/4" & 3/4" Meter x 3/4" Iron Pipe P.J.	1.2	10
C35-44-NL	1" Meter x 1" Iron Pipe P.J.	1.5	10
■ C35-44-4-75-NL	1" Meter x 1" Iron Pipe P.J.	1.9	-
METER SWIVEL NUT BY PACK JOINT FOR PE PIPE			
▶ C36-13-NL	5/8" Meter x 3/4" PE Pipe P.J.	0.9	20
▶ C36-23-NL	5/8"x3/4" & 3/4" Meter x 3/4" PE Pipe P.J.	0.9	15
▶ C36-44-NL	1" Meter x 1" PE Pipe P.J.	1.8	8
METER SWIVEL NUT BY PACK JOINT FOR PVC PIPE			
C37-13-NL	5/8" Meter x 3/4" PVC Pipe P.J.	0.8	20
C37-21-NL	5/8"x3/4" & 3/4" Meter x 1/2" PVC Pipe P.J.	0.7	-
C37-23-NL	5/8"x3/4" & 3/4" Meter x 3/4" PVC Pipe P.J.	0.9	15
■ C37-23-4-875-NL	5/8"x3/4" & 3/4" Meter x 3/4" PVC Pipe P.J.	1.4	12
C37-44-NL	1" Meter x 1" PVC Pipe P.J.	1.7	8
■ C37-44-4-75-NL	1" Meter x 1" PVC Pipe P.J.	2.2	10

Grip Joint for CTS and PEP is available. Add "-G" to the catalog number.

♦ Quick Joint can be ordered by adding "-Q" to the catalog number.

Note: Insert Stiffeners are listed on page 7 of this section.

▶ Ultra-Tite available. Add "-U-AWT" to the catalog number (consists of components assembled watertight).

■ Extended coupling length (4-75 for 4-3/4" and 4-875 for 4-7/8")

Angle Meter Couplings



CATALOG NUMBER	DESCRIPTION	APPROX. WT. LBS.	STD. PKG. QTY.
METER SWIVEL NUT BY FEMALE IRON PIPE THREAD			
L31-13-NL	5/8" Meter x 3/4" Female Iron Pipe	0.6	20
L31-23-NL	5/8"x3/4" & 3/4" Meter x 3/4" Female Iron Pipe	0.8	20
L31-23D-NL (Test Valve)	5/8"x3/4" & 3/4" Meter x 3/4" Female Iron Pipe	0.9	15
L31-24-NL	5/8"x3/4" & 3/4" Meter x 1" Female Iron Pipe	0.9	15
L31-44-NL	1" Meter x 1" Female Iron Pipe	1.2	12
METER SWIVEL NUT BY FLARE COPPER			
L32-13-NL	5/8" Meter x 3/4" Flare Copper	0.8	16
L32-23-NL	5/8"x3/4" & 3/4" Meter x 3/4" Flare Copper	1.0	14
L32-44-NL	1" Meter x 1" Flare Copper	1.6	8
METER SWIVEL NUT BY MALE IRON PIPE THREAD			
L38-11-NL	5/8" Meter x 1/2" Male Iron Pipe	0.4	30
L38-23-NL	5/8"x3/4" & 3/4" Meter x 3/4" Male Iron Pipe	0.7	16
L38-24-NL	5/8"x3/4" & 3/4" Meter x 1" Male Iron Pipe	0.7	15
L38-44-NL	1" Meter x 1" Male Iron Pipe	1.1	10
L38-45-AWT-NL	1" Meter x 1-1/4" Male Iron Pipe	1.3	-
L38-66-NL	1-1/2" Meter x 1-1/2" Male Iron Pipe	3.0	6
METER SWIVEL NUT BY PACK JOINT FOR COPPER OR PLASTIC TUBING (CTS)			
▶ L34-13-NL	5/8" Meter x 3/4" CTS P.J.	0.8	15
▶♦ L34-23-NL	5/8"x3/4" & 3/4" Meter x 3/4" CTS P.J.	1.0	15
▶ L34-44-NL	1" Meter x 1" CTS P.J.	1.3	8
L34-45-NL	1" Meter x 1-1/4" CTS P.J.	0.9	6
METER SWIVEL NUT BY PACK JOINT FOR PE PIPE			
▶ L36-23-NL	5/8"x3/4" & 3/4" Meter x 3/4" PE Pipe P.J.	1.1	14
▶ L36-44-NL	1" Meter x 1" PE Pipe P.J.	1.9	6

Grip Joint for CTS and PEP is available. Add "-G" to the catalog number.

♦ Quick Joint can be ordered by adding "-Q" to the catalog number

▶ Ultra-Tite available. Add "-U-AWT" to the catalog number (consists of components assembled watertight).

Flanged Meter Couplings

Flanged Ells for 1-1/2" and 2" meters

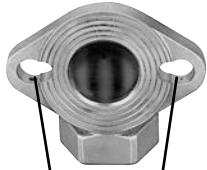

2" Flanges have slotted bolt holes to fit 1-1/2" meters

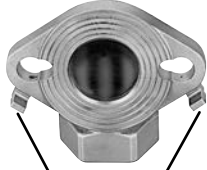

Optional Support Brackets (add "-MSB" to catalog number)

CATALOG NUMBER	DESCRIPTION		APPROX. WT. LBS.	STD. PKG. QTY.
METER FLANGE BY FEMALE IRON PIPE THREAD				
LF31-66-NL	1-1/2" Meter Flange	x 1-1/2" Female Iron Pipe	3.7	4
LF31-67-NL	1-1/2" Meter Flange	x 2" Female Iron Pipe	4.2	2
LF31-77-NL	1-1/2" & 2" Meter Flange	x 2" Female Iron Pipe	4.6	3
METER FLANGE BY FLARE COPPER				
LF32-66-NL	1-1/2" Meter Flange	x 1-1/2" Flare Copper	5.1	2
LF32-67-NL	1-1/2" Meter Flange	x 2" Flare Copper	6.8	1
LF32-77-NL	1-1/2" & 2" Meter Flange	x 2" Flare Copper	7.5	1
METER FLANGE BY PACK JOINT FOR COPPER OR PLASTIC TUBING (CTS)				
LF34-66-NL	1-1/2" Meter Flange	x 1-1/2" CTS P.J.	4.3	2
LF34-77-NL	1-1/2" & 2" Meter Flange	x 2" CTS P.J.	6.2	2

Grip Joint for CTS is available. Add "-G" to the catalog number.

For **meter support brackets**, two per flange, add "-MSB" to catalog number.

Lok-Pak Meter Couplings

Lok-Pak Meter Couplings for Flanged Meters



CATALOG NUMBER	DESCRIPTION		APPROX. WT. LBS.	STD. PKG. QTY.
METER FLANGE BY PACK JOINT FOR COPPER OR PLASTIC TUBING (CTS)				
CF34-66-NL	1-1/2" Meter Flange	x 1-1/2" CTS P.J.	3.7	3
CF34-77-NL	2" Meter Flange	x 2" CTS P.J.	4.8	5
METER FLANGE BY PACK JOINT FOR IRON PIPE				
CF35-66-NL	1-1/2" Meter Flange	x 1-1/2" Iron Pipe P.J.	3.6	3
CF35-77-NL	2" Meter Flange	x 2" Iron Pipe P.J.	5.1	3
METER FLANGE BY PACK JOINT FOR PVC PIPE				
CF37-66-NL	1-1/2" Meter Flange	x 1-1/2" PVC Pipe P.J.	4.0	3
CF37-77-NL	2" Meter Flange	x 2" PVC Pipe P.J.	6.0	5

Grip Joint for CTS is available. Add "-G" to the catalog number.

For **meter support brackets**, two per flange, add "-MSB" to catalog number.

Lok-Pak Meter Couplings for Tapped Meters



CATALOG NUMBER	DESCRIPTION		APPROX. WT. LBS.	STD. PKG. QTY.
CONNECTION FOR TAPPED METER BY PACK JOINT FOR COPPER OR PLASTIC TUBING (CTS)				
CT34-66-NL	1-1/2" Tapped Meter Connection	x 1-1/2" CTS P.J.	2.1	4
CT34-77-NL	2" Tapped Meter Connection	x 2" CTS P.J.	3.4	3
CONNECTION FOR TAPPED METER BY PACK JOINT FOR IRON PIPE				
CT35-66-NL	1-1/2" Tapped Meter Connection	x 1-1/2" Iron Pipe P.J.	2.2	4
CT35-77-NL	2" Tapped Meter Connection	x 2" Iron Pipe P.J.	3.3	3

Grip Joint for CTS only is available. Add "-G" to the catalog number.

Gaskets are furnished with all meter couplings, flat drop-in gaskets for flanged meters, flat ring gaskets for tapped meters.

Steel bolts and nuts (5/8" x 2-1/2" zinc plated) for attaching 1-1/2" & 2" flanges and flanged ells are sold separately and are supplied in pairs. (Cat. No. **PSB**)

Meter Flanges



CF33-66S-2-125-NL



Female Iron Pipe



Male Iron Pipe

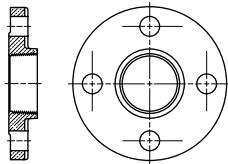

RF-2I-NL Flange

CATALOG NUMBER	DESCRIPTION	APPROX. WT. LBS.	STD. PKG. QTY.
CF31-66-NL	1-1/2" Meter Flange x 1-1/2" Female Iron Pipe Thread	2.2	8
CF31-67-NL	1-1/2" Meter Flange x 2" Female Iron Pipe Thread	1.9	8
+ CF31-77-NL	2" Meter Flange x 2" Female Iron Pipe Thread	2.8	6
CF31-78-NL	2" Meter Flange x 2-1/2" Female Iron Pipe Thread	3.2	5
CF33-66S-2-125-NL	1-1/2" Meter Flange x 1-1/2" Meter Swivel Nut	7.0	2 pair
CF33-77S-2-25-NL	2" Meter Flange x 2" Meter Swivel Nut	8.5	2 pair
* CF38-66-2-NL	1-1/2" Meter Flange x 1-1/2" Male Iron Pipe Thread	2.4	5
+ CF38-77-1-937-NL	2" Meter Flange x 2" Male Iron Pipe Thread	3.2	3
+ CF38-77-2-125-NL	2" Meter Flange x 2" Male Iron Pipe Thread	3.2	3

* Standard length

+ Slotted bolt holes are available on 2" meter flanges to allow 1-1/2" meter installations.

For meter support brackets, two per flange, add "-MSB" to the catalog number.

Note: Drop-in rubber gaskets are included with all 1-1/2" and 2" meter flanges and flanged ells. Flange couplings are not supplied with bolts. Steel bolts and nuts (5/8" x 2-1/2" zinc plated) for attaching 1-1/2" & 2" flanges and flanged ells are sold separately and are supplied in pairs. (Cat. No. **PSB**)

Four Bolt Round Flange

CATALOG NUMBER	DESCRIPTION	APPROX. WT. LBS.	STD. PKG. QTY.
RF-2I-NL	2" 4-Bolt Meter Flange x 2" Female Iron Pipe Thread	4.4	5

Meter Adapters



A47-NL Adapter



Adapt from 1" to 2" meter with A47-NL Adapter



Adapt from 1" to 5/8" meter with A14-NL Adapter

CATALOG NUMBER	DESCRIPTION - USAGE	APPROX. WT. LBS.	STD. PKG. QTY.
ADAPTER RINGS TO BUSH METER SPUDS (NO CHANGE IN METER LENGTH)			
□ A12S	Pair short adapter rings to bush 5/8" meter spuds to 5/8"x3/4" meter spud size	0.1	100 Pair
□ A12M	Pair medium adapter rings to bush 5/8" meter spuds to 5/8"x3/4" meter spud size	0.1	100 Pair
□ A12L	Pair long adapter rings to bush 5/8" meter spuds to 5/8"x3/4" meter spud size	0.2	75 Pair
□ A34S	Pair short adapter rings to bush 3/4" meter spuds to 1" meter spud size	0.3	50 Pair
□ A45	Pair adapter rings to bush 1" meter spuds to 1-1/4" meter spud size	0.2	35 Pair
ADAPTERS TO CHANGE METER SPUD SIZE AND/OR LENGTH			
A13-NL	Pair adapters to change 5/8" meter to 3/4" meter spud size and length	0.5	35 Pair*
A14-NL	Pair adapters to change 5/8" meter to 1" meter spud size and length	0.8	15 Pair*
A21-NL	One adapter to change 5/8"x3/4" and 3/4" to 5/8" meter spud size	0.3	40 Each*
A23-NL	One adapter to change 5/8"x3/4" meter to 3/4" meter length	0.4	30 Each*
A24-NL	Pair adapters to change 5/8"x3/4" meter to 1" spud size and length	1.1	12 Pair*
A34-NL	Pair adapters to change 3/4" meter to 1" meter spud size and length	0.8	24 Pair*
A44-NL	One adapter to change 3/4"x1" meter to 1" meter length	0.8	16 Each*
A46-NL	Pair adapters to change 1" meter to 1-1/2" flanged meter size and length	4.0	3 Pair*
A47-NL	Pair adapters to change 1" meter to 2" flanged meter size and length	7.1	1 Pair*
A67-NL	Pair adapters to change 1-1/2" flanged meter to 2" flanged meter size and length (eight special length bolts included)	8.7	2 Pair
A77-15-25-NL	Pair adapters to change 2" meter 17" length to 2" meter 15-1/4" length	7.2	2 Pair*
TA46-NL	Pair adapters to change 1" meter to 1-1/2" tapped meter size and length	1.5	8 Pair*
TA47-NL	Pair adapters to change 1" meter to 2" tapped meter size and length	3.0	4 Pair*

□ Brass components that **do not** come in contact with potable water shall be cast of UNS C83600 85-5-5-5 and conform to AWWA Standard C800 (ASTM B62 and ASTM B584).

* Gasket included.

Note: Adapter numbers A21-NL, A23-NL and A44-NL extend the meter length only and therefore only one per meter is required. All other adapters are sold in pairs; the part number and weight reflects a pair.

Meter Idlers



For 5/8" x 3/4" through 1" meters (plastic)



For 5/8" through 1" meters

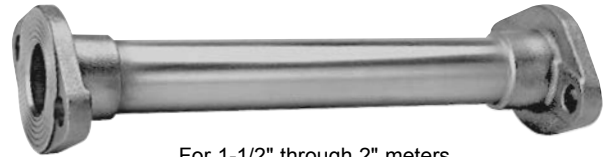

For 1-1/2" through 2" meters

CATALOG NUMBER	DESCRIPTION	APPROX. WT. LBS.	STD. PKG. QTY.
IDLER-1-NL	Replaces 5/8" Meter	0.6	40
IDLER-2-NL	Replaces 5/8"x3/4" Meter	0.9	25
IDLER-2P	Replaces 5/8"x3/4" Meter (plastic)	0.2	25
IDLER-3-NL	Replaces 3/4" Meter	0.9	18
IDLER-3P	Replaces 3/4" Meter (plastic)	0.2	18
IDLER-4-NL	Replaces 1" Meter	1.8	10
IDLER-4P	Replaces 1" Meter (plastic)	0.2	10
IDLER-6-NL	Replaces 1-1/2" Flanged Meter	5.8	4
IDLER-7-NL	Replaces 2" Flanged Meter	10.8	3

Note: Steel bolts and nuts (5/8" x 2-1/2" zinc plated) for attaching 1-1/2" and 2" Flange Lok-Pak couplings, adapters & idlers, must be ordered separately and are supplied in pairs. (Cat. No. **PSB**)

Meter Coupling Bushings

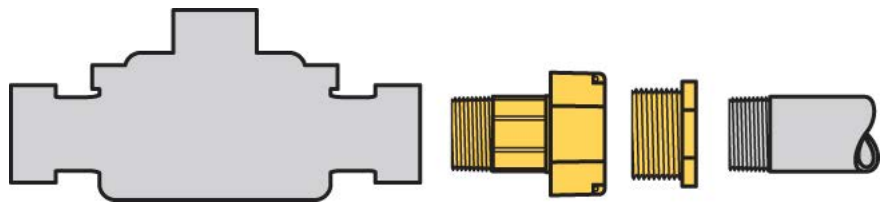

CATALOG NUMBER	DESCRIPTION	APPROX. WT. LBS.	STD. PKG. QTY.
BBIM-33-NL	3/4" Female Iron Pipe Thread x 3/4" Male Meter Thread	0.2	60
BBIM-34-NL	3/4" Female Iron Pipe Thread x 1" Male Meter Thread	0.5	54
BBIM-44-NL	1" Female Iron Pipe Thread x 1" Male Meter Thread	0.4	-
BBIM-66-NL	1-1/2" Female Iron Pipe Thread x 1-1/2" Meter Spud	1.0	15
BBIM-77-NL	2" Female Iron Pipe Thread x 2" Meter Spud	1.4	8

Example: The male iron pipe thread end of a C38-66-2-875-NL threads into an 1-1/2" tapped meter. The female iron pipe thread of a BBIM-66-NL will thread onto the service line. This allows a swivel connection between the swivel nut on the C38-66-2-875-NL and the male meter thread on the BBIM-66-NL.

"U" Branch Pieces

(7-1/2" Standard Spacing)
(6-1/2", 12-1/2" or 14" Spacing Optional)



CATALOG NUMBER	DESCRIPTION	APPROX. WEIGHT LBS.					
		6-1/2" SPACING	7-1/2" STD SPACING	9" SPACING	12-1/2" SPACING	14" SPACING	18" SPACING
"U" BRANCH PIECES							
U11-43-spacing-NL	1" Female Iron Pipe x Two 3/4" Female Iron Pipe Outlets	2.2	2.3	N/A	2.4	N/A	N/A
U11-43-18-AWT-NL	1" Female Iron Pipe x Two 3/4" Female Iron Pipe Outlets	N/A	N/A	N/A	N/A	N/A	3.4
U11-44-18-NL	1" Female Iron Pipe x Two 1" Female Iron Pipe Outlets	N/A	N/A	N/A	N/A	N/A	4.0
U18-33-spacing-NL	3/4" Female Iron Pipe x Two 3/4" Male Iron Pipe Outlets	1.8	1.9	N/A	N/A	N/A	N/A
U18-43-spacing-NL	1" Female Iron Pipe x Two 3/4" Male Iron Pipe Outlets	1.6	1.8	N/A	2.8	2.9	N/A
U18-44-14-NL	1" Female Iron Pipe x Two 1" Male Iron Pipe Outlets	N/A	N/A	N/A	N/A	3.1	N/A
U18-64-9-NL	1-1/2" Female Iron Pipe x Two 1" Male Iron Pipe Outlets	N/A	N/A	3.6	N/A	N/A	N/A
U21-33-spacing-NL	3/4" Flare Copper x Two 3/4" Female Iron Pipe Outlets	2.4	2.5	N/A	N/A	N/A	N/A
U21-43-spacing-NL	1" Flare Copper x Two 3/4" Female Iron Pipe Outlets	2.1	2.8	N/A	3.5	3.5	N/A
U28-33-spacing-NL	3/4" Flare Copper x Two 3/4" Male Iron Pipe Outlets	2.0	2.1	N/A	N/A	N/A	N/A
U28-43-spacing-NL	1" Flare Copper x Two 3/4" Male Iron Pipe Outlets	2.1	2.2	N/A	3.4	3.5	N/A
U28-64-9-NL	1-1/2" Flare Copper x Two 1" Male Iron Pipe Outlets	N/A	N/A	4.6	N/A	N/A	N/A
U88-33-spacing-NL	3/4" Male Iron Pipe x Two 3/4" Male Iron Pipe Outlets	1.5	1.8	N/A	N/A	3.2	N/A
U88-43-spacing-NL	1" Male Iron Pipe x Two 3/4" Male Iron Pipe Outlets	2.0	1.7	N/A	N/A	2.8	N/A
U88-64-9-NL	1-1/2" Male Iron Pipe x Two 1" Male Iron Pipe Outlets	N/A	N/A	3.0	N/A	N/A	N/A
"U" BRANCH PIECES WITH PACK JOINT INLETS FOR COPPER OR PLASTIC TUBING (CTS)							
▶ U41-43-spacing-NL	1" CTS P.J. x Two 3/4" Female Iron Pipe Outlets	2.1	2.4	N/A	N/A	N/A	N/A
▶ U48-33-spacing-NL	3/4" CTS P.J. x Two 3/4" Male Iron Pipe Outlets	1.8	2.1	N/A	N/A	N/A	N/A
▶ U48-43-spacing-NL	1" CTS P.J. x Two 3/4" Male Iron Pipe Outlets	1.8	▶1.9	N/A	2.9	▶3.1	N/A
U48-63-spacing-NL	1-1/2" CTS P.J. x Two 3/4" Male Iron Pipe Outlets	N/A	3.2	N/A	N/A	N/A	N/A
◆ U48-64-9-NL	1-1/2" CTS P.J. x Two 1" Male Iron Pipe Outlets	N/A	N/A	◆4.0	N/A	N/A	N/A
"U" BRANCH PIECES WITH PACK JOINT INLET FOR PE PIPE							
▶ U68-33-spacing-NL	3/4" PE Pipe P.J. x Two 3/4" Male Iron Pipe Outlets	2.0	2.1	N/A	N/A	N/A	N/A
▶ U68-43-spacing-NL	1" PE Pipe P.J. x Two 3/4" Male Iron Pipe Outlets	2.0	2.7	N/A	N/A	3.1	N/A
U68-53-NL	1-1/4" PE Pipe P.J. x Two 3/4" Male Iron Pipe Outlets	N/A	3.0	N/A	N/A	N/A	N/A

Grip Joint for CTS and PEP (3/4" & 1") is available. Add "-G" to the catalog number.

◆ Quick Joint can be ordered by adding "-Q" to the catalog number.

Note: To order, use the catalog number plus the desired spacing; 6-1/2", 7-1/2", 9", 12-1/2" or 14" as shown available in the table above.
Example: U21-43-65-NL is a "U" branch with a 1" flare inlet and two 3/4" FIP outlets with a 6-1/2" spacing between the outlets.

A 7-1/2" spacing will be provided unless otherwise specified

▶ Ultra-Tite available. Add "-U-AWT" to the end of the catalog number (consists of components assembled watertight).

Angle "U" Branch Pieces

(6-1/2" Spacing)



CATALOG NUMBER	DESCRIPTION	APPROX. Wt. LBS.	STD. PKG. QTY.
ANGLE "U" BRANCH PIECES - 6-1/2" SPACING ONLY			
UA11-43-65-NL	1" Female Iron Pipe x Two 3/4" Female Iron Pipe Outlets	2.0	2
UA18-43-65-NL	1" Female Iron Pipe x Two 3/4" Male Iron Pipe Outlets	1.8	2
UA21-43-65-NL	1" Flare Copper x Two 3/4" Female Iron Pipe Outlets	2.5	1
UA28-43-65-NL	1" Flare Copper x Two 3/4" Male Iron Pipe Outlets	2.2	2
ANGLE "U" BRANCH PIECES WITH PACK JOINT INLET FOR COPPER OR PLASTIC TUBING (CTS)			
▶ UA41-43-65-NL	1" CTS P.J. x Two 3/4" Female Iron Pipe Outlets	2.2	2
▶ UA48-43-65-NL	1" CTS P.J. x Two 3/4" Male Iron Pipe Outlets	2.0	2

Grip Joint for CTS is available. Add "-G" to the catalog number.

Note: All angle "U" branch pieces have 6-1/2" spacing.

▶ Ultra-Tite available. Add "-U-AWT" to the end of the catalog number (consists of components assembled watertight).

Section H

Ford Water Meter Couplings and Accessories

Warranty

All merchandise is warranted to be free from defects in material and factory workmanship for one year from date of shipment from our factory. We will provide, free of charge, new products in equal quantities for any that prove defective within one year from date of shipment from our factory. Manufacturer shall not be liable for any loss, damage, or injury, direct or consequential, arising out of the use of or the inability to use the product. Before using, user shall determine the suitability of the product for user's intended use and user assumes all risk and liability whatever in connection therewith. No claims for labor or consequential damage will be allowed. The foregoing may not be changed except by agreement signed by an officer of the manufacturer.

No other warranties are applicable or may be implied, including the implied warranty of merchantability and the implied warranty of fitness for particular purpose and any warranty relating to infringement or the like, all of which are disclaimed.

Parties responsible for monitoring and maintaining proper water system design must exercise full responsibility in understanding and upholding the full intent and scope of applicable lead laws.

Please Note:

Consult The Ford Meter Box Company, Inc. website (www.fordmeterbox.com) for the most recent catalog information. The Ford Meter Box Company considers the information in this catalog to be correct at the time of publication. Items and option availability, including specifications, are subject to change without notice. Please verify that your product information is current.



The Ford Meter Box Co., Inc. 775 Manchester Avenue, P.O. Box 443, Wabash, Indiana, USA 46992-0443
Telephone: 260/563-3171 FAX: 1-800-826-3487 Overseas FAX: 260/563-0167 <http://www.fordmeterbox.com>