

CHANGE DIMENSIONS AS NEEDED FOR CUSTOM TRAYS

		REVISIONS			
ZONE	REV.	DESCRIPTION	DATE	APPROVED	

Precision Sheet Metal
 Design ♦ Engineering ♦ Fabrication
www.acumetalfab.com

5/8-18 X 3" LONG
 BRASS DRAIN W/HARDWARE

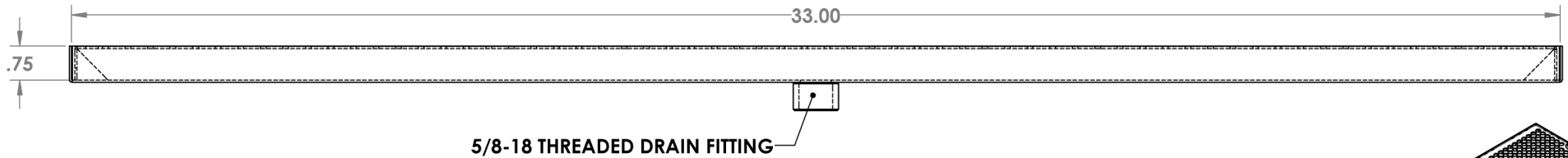
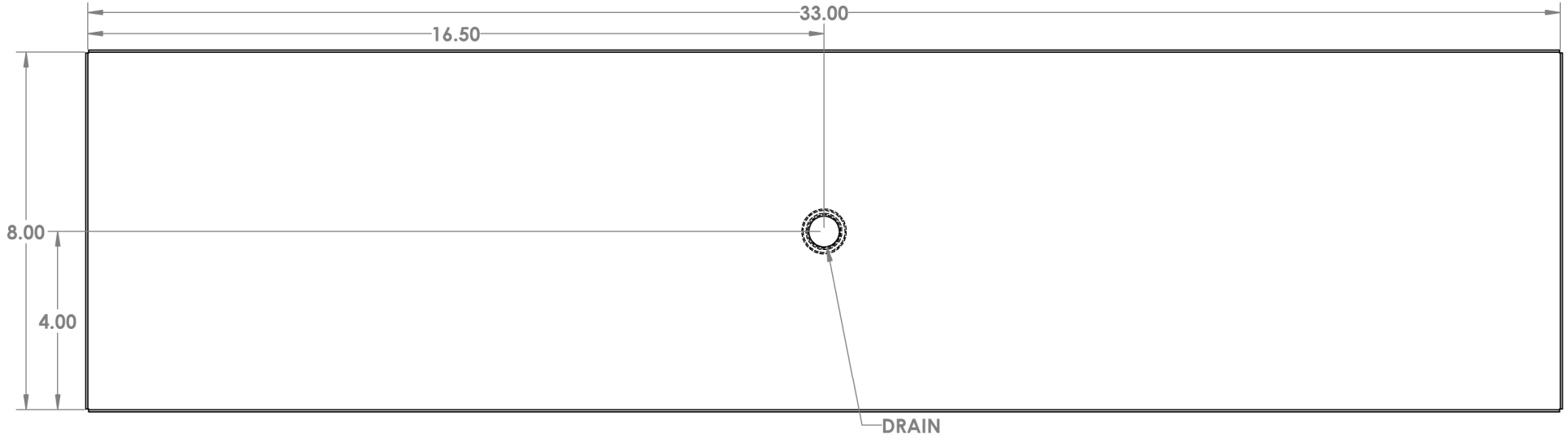

PERFORATED SCREEN
 (Ø .375 ON .50 CENTERS)
 STANDARD

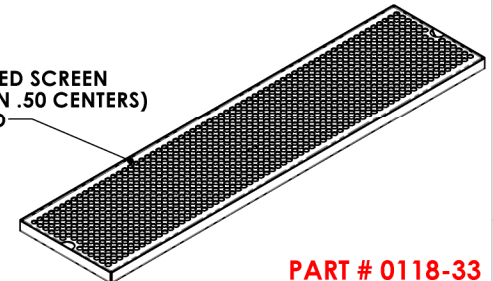

PART # 0118-33

NOTES:

**ALL DIMENSIONS ARE INSIDE DIMENSIONS
 (UNLESS OTHERWISE NOTED)**

www.acumetalfab.com

PROPRIETARY AND CONFIDENTIAL

THE INFORMATION CONTAINED IN THIS DRAWING IS THE SOLE PROPERTY OF ACU PRECISION SHEET METAL. ANY REPRODUCTION IN PART OR AS A WHOLE WITHOUT THE WRITTEN PERMISSION OF ACU PRECISION SHEET METAL IS PROHIBITED.

ACU PRECISION SHEET METAL IS :
 AMERICAN COFFEE URN MANUFACTURING CO., INC

	NAME	DATE	TITLE:
DRAWN	L. WILLIAMS	10/16	SM-D SURFACE MOUNT W/DRAIN 8" X 33"
MATERIAL	16 GA. BRASS		
FINISH	#8 POLISHED		
			AMERICAN COFFEE URN

DO NOT SCALE DRAWING