

**CHANGE DIMENSIONS AS NEEDED FOR CUSTOM TRAYS**

		REVISIONS			
LINE	REV.	DESCRIPTION	DATE	APPROVED	

5/8-18 X 3" LONG  
 BRASS DRAIN W/HARDWARE

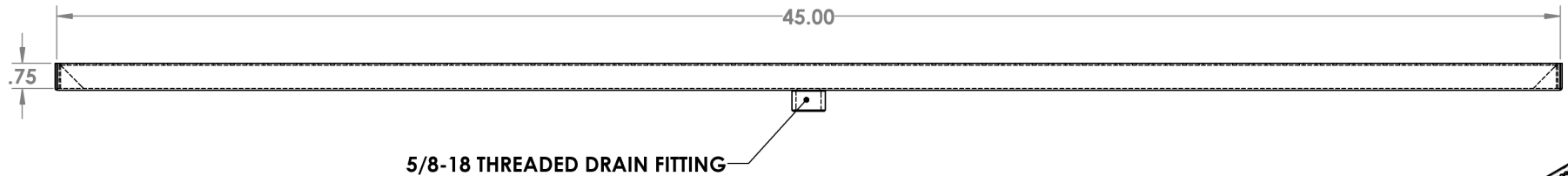
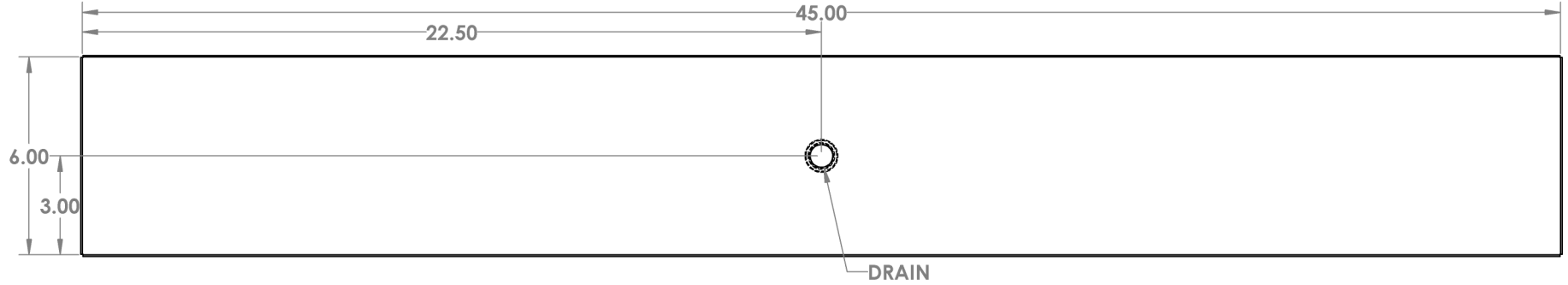

PERFORATED SCREEN  
 (Ø .375 ON .50 CENTERS)  
 STANDARD

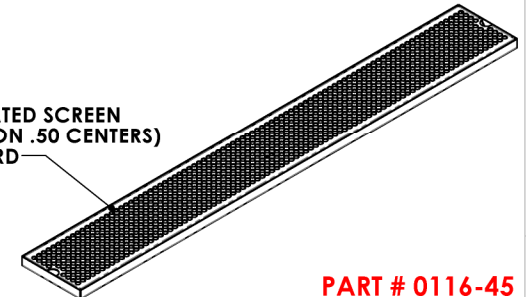

**PART # 0116-45**

**NOTES:**

**ALL DIMENSIONS ARE INSIDE DIMENSIONS  
 (UNLESS OTHERWISE NOTED)**

**PROPRIETARY AND CONFIDENTIAL**

THE INFORMATION CONTAINED IN THIS DRAWING IS THE SOLE PROPERTY OF ACU PRECISION SHEET METAL. ANY REPRODUCTION IN PART OR AS A WHOLE WITHOUT THE WRITTEN PERMISSION OF ACU PRECISION SHEET METAL IS PROHIBITED.

ACU PRECISION SHEET METAL IS :  
 AMERICAN COFFEE URN MANUFACTURING CO., INC

	NAME	DATE	TITLE:
<b>DRAWN</b>	L. WILLIAMS	10/16	<b>SM-D SURFACE MOUNT W/DRAIN 6" X 45"</b>
<b>MATERIAL</b>	16 GA. BRASS		
<b>FINISH</b>	#8 POLISHED		
			<b>AMERICAN COFFEE URN</b>