

**CHANGE DIMENSIONS AS NEEDED FOR CUSTOM TRAYS**

		REVISIONS			
ZONE	REV.	DESCRIPTION	DATE	APPROVED	

5/8-18 X 3" LONG  
 BRASS DRAIN W/HARDWARE

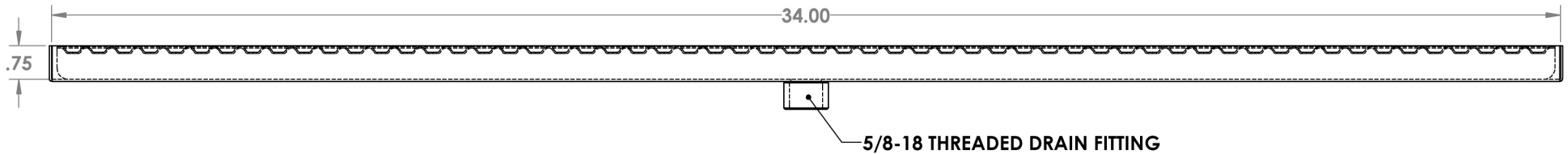
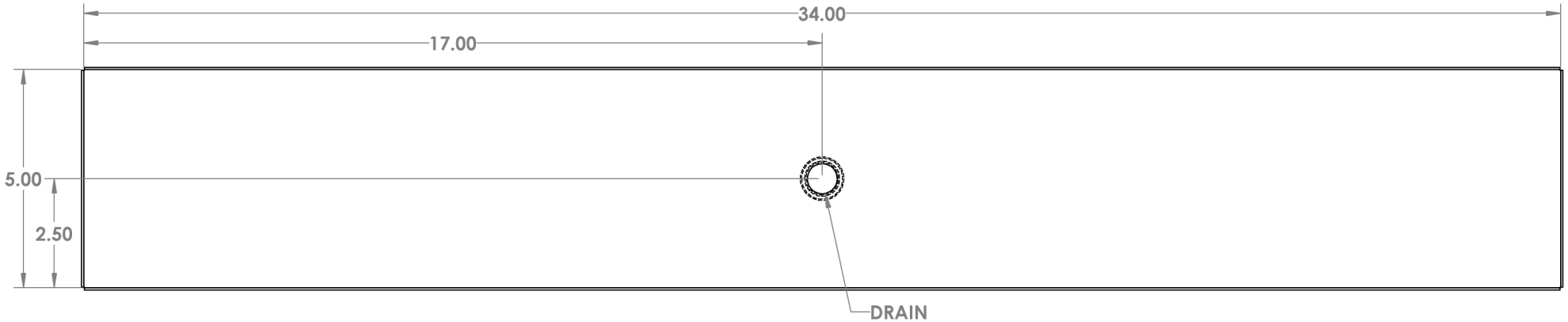
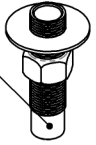

20 GA. LOUVER SCREEN\*  
 (3.50 X .50 ON .50 CENTERS)  
 STANDARD

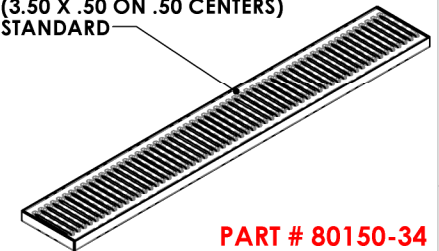

**PART # 80150-34**

**NOTES:**

**ALL DIMENSIONS ARE INSIDE DIMENSIONS  
 (UNLESS OTHERWISE NOTED)**

**\* OPTIONAL 18 GA. PERFORATED SCREEN  
 AVAILABLE ON CUSTOM TRAYS**

PROPRIETARY AND CONFIDENTIAL

THE INFORMATION CONTAINED IN THIS DRAWING IS THE SOLE PROPERTY OF ACU PRECISION SHEET METAL. ANY REPRODUCTION IN PART OR AS A WHOLE WITHOUT THE WRITTEN PERMISSION OF ACU PRECISION SHEET METAL IS PROHIBITED.

ACU PRECISION SHEET METAL IS :  
 AMERICAN COFFEE URN MANUFACTURING CO., INC

	NAME	DATE
DRAWN	L. WILLIAMS	10/16
MATERIAL	18 GA. 304 STAINLESS STEEL	
FINISH	#8 POLISHED	

DO NOT SCALE DRAWING

TITLE:
<b>SM-D                  SURFACE MOUNT W/DRAIN                  5" X 34"</b>
<b>AMERICAN COFFEE URN</b>