

**CHANGE DIMENSIONS AS NEEDED FOR CUSTOM TRAYS**

		REVISIONS	
ZONE	REV.	DESCRIPTION	DATE

5/8-18 X 3" LONG  
 BRASS DRAIN W/HARDWARE

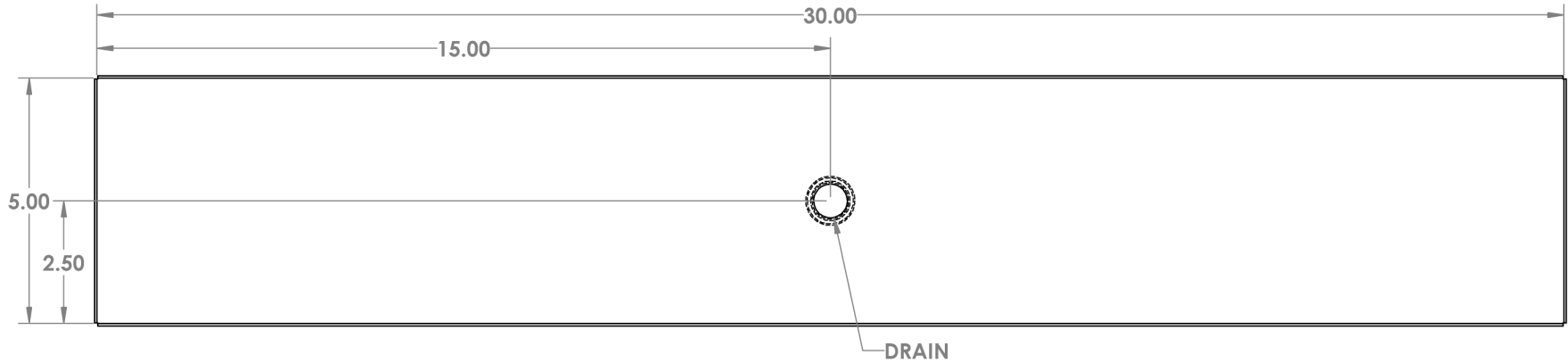
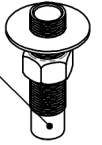

DRAIN

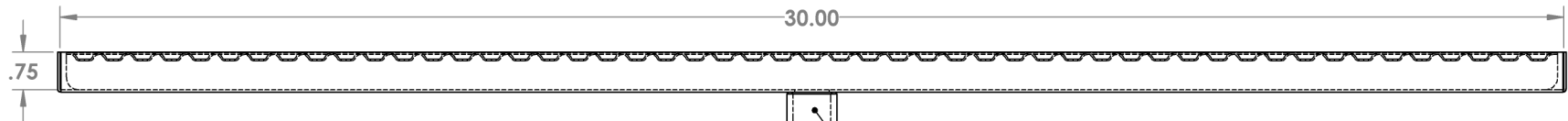

5/8-18 THREADED DRAIN FITTING

20 GA. LOUVER SCREEN\*  
 (3.50 X .50 ON .50 CENTERS)  
 STANDARD

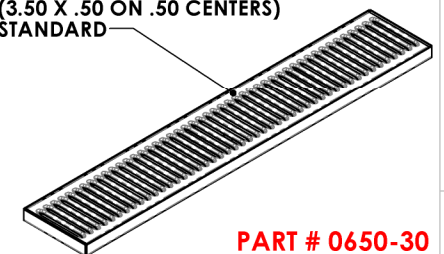

**PART # 0650-30**

**NOTES:**  
 ALL DIMENSIONS ARE INSIDE DIMENSIONS  
 (UNLESS OTHERWISE NOTED)

\* OPTIONAL 18 GA. PERFORATED SCREEN  
 AVAILABLE ON CUSTOM TRAYS

PROPRIETARY AND CONFIDENTIAL  
 THE INFORMATION CONTAINED IN THIS  
 DRAWING IS THE SOLE PROPERTY OF  
 ACU PRECISION SHEET METAL. ANY  
 REPRODUCTION IN PART OR AS A WHOLE  
 WITHOUT THE WRITTEN PERMISSION OF  
 ACU PRECISION SHEET METAL IS  
 PROHIBITED.  
 AMERICAN COFFEE URN MANUFACTURING CO., INC

	NAME	DATE
DRAWN	L. WILLIAMS	10/16
MATERIAL	16 GA. BRASS	
FINISH	#8 POLISHED	

TITLE:
SM-D SURFACE MOUNT W/DRAIN 5" X 30"
AMERICAN COFFEE URN