

CHANGE DIMENSIONS AS NEEDED FOR CUSTOM TRAYS

		REVISIONS			
ZONE	REV.	DESCRIPTION	DATE	APPROVED	

Precision Sheet Metal
 Design ♦ Engineering ♦ Fabrication
www.acumetalfab.com

5/8-18 X 3" LONG
 BRASS DRAIN W/HARDWARE

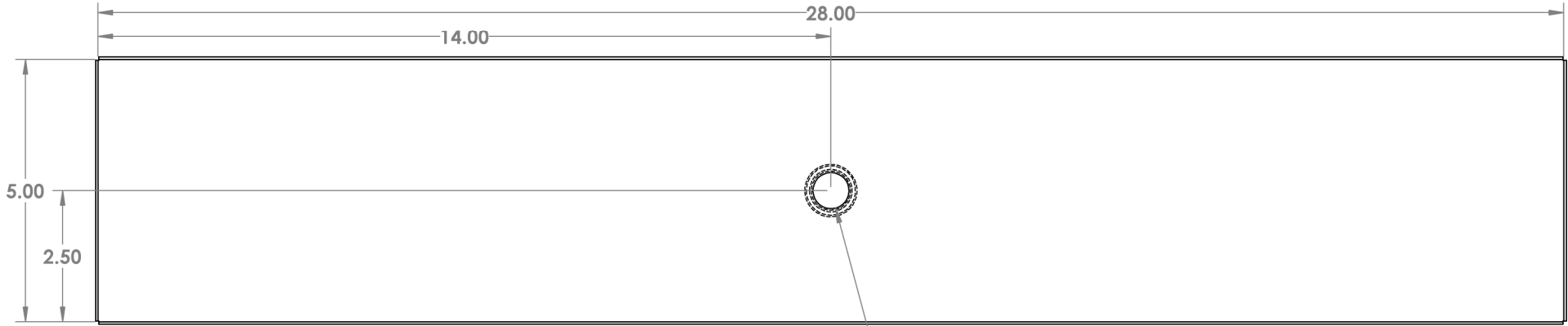
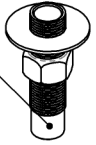

DRAIN

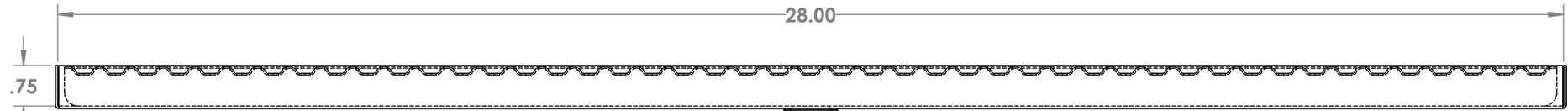

5/8-18 THREADED DRAIN FITTING

20 GA. LOUVER SCREEN*
 (3.50 X .50 ON .50 CENTERS)
 STANDARD

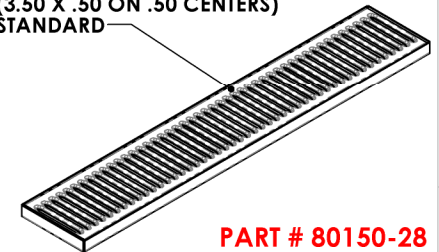

PART # 80150-28

NOTES:

**ALL DIMENSIONS ARE INSIDE DIMENSIONS
 (UNLESS OTHERWISE NOTED)**

*** OPTIONAL 18 GA. PERFORATED SCREEN
 AVAILABLE ON CUSTOM TRAYS**

PROPRIETARY AND CONFIDENTIAL

THE INFORMATION CONTAINED IN THIS DRAWING IS THE SOLE PROPERTY OF ACU PRECISION SHEET METAL. ANY REPRODUCTION IN PART OR AS A WHOLE WITHOUT THE WRITTEN PERMISSION OF ACU PRECISION SHEET METAL IS PROHIBITED.

ACU PRECISION SHEET METAL IS :
 AMERICAN COFFEE URN MANUFACTURING CO., INC

	NAME	DATE
DRAWN	L. WILLIAMS	10/16
MATERIAL	18 GA. 304 STAINLESS STEEL	
FINISH	#8 POLISHED	

DO NOT SCALE DRAWING

TITLE:
SM-D SURFACE MOUNT W/DRAIN 5" X 28"
AMERICAN COFFEE URN