

CHANGE DIMENSIONS AS NEEDED FOR CUSTOM TRAYS

REV. NO.		REVISIONS	DATE	APPROVED
		DESCRIPTION		

Precision Sheet Metal
 Design ♦ Engineering ♦ Fabrication
 www.acumetalfab.com

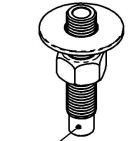

5/8-18 X 3" LONG BRASS DRAIN W/HARDWARE

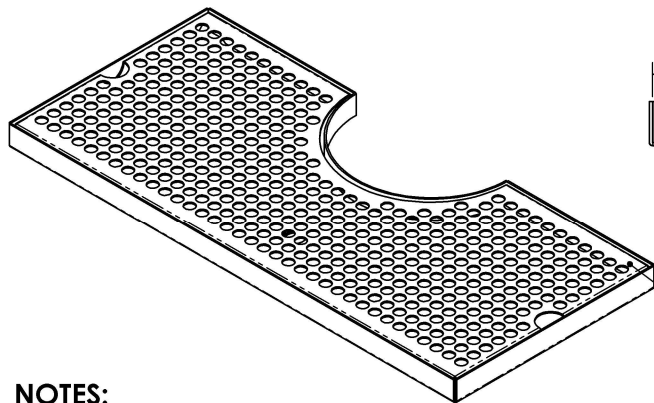
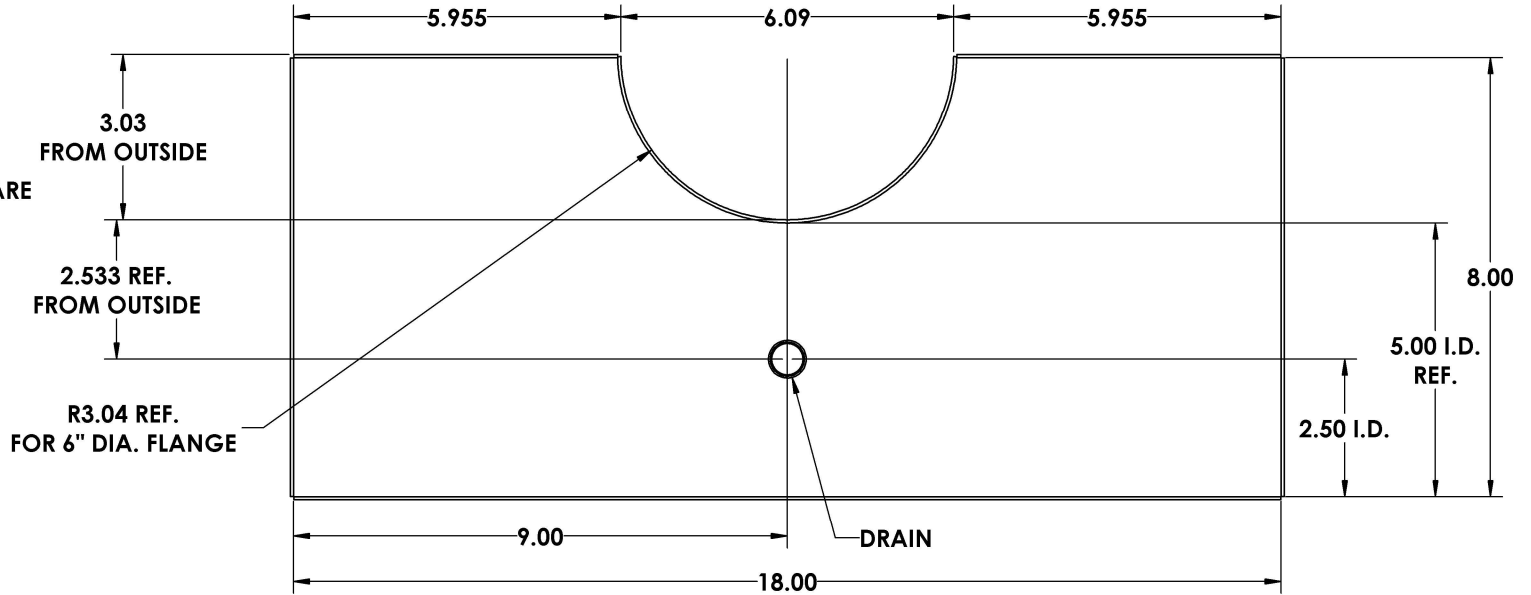

PERFORATED SCREEN
 (Ø .375 ON .50 CENTERS)
 STANDARD



5/8-18 THREADED DRAIN FITTING

NOTES:
 ALL DIMENSIONS ARE INSIDE DIMENSIONS
 (UNLESS OTHERWISE NOTED)

PART # 0170-18

PROPRIETARY AND CONFIDENTIAL
 THE INFORMATION CONTAINED IN THIS DRAWING IS THE SOLE PROPERTY OF ACU PRECISION SHEET METAL. ANY REPRODUCTION IN PART OR AS A WHOLE WITHOUT THE WRITTEN PERMISSION OF ACU PRECISION SHEET METAL IS PROHIBITED.
 ACU PRECISION SHEET METAL IS : AMERICAN COFFEE URN MANUFACTURING CO., INC

	NAME	DATE
DRAWN	L. WILLIAMS	06/21
MATERIAL	16 GA. 304 STAINLESS STEEL	
FINISH	#4 BRUSHED	

TITLE:
METRO SM-D
8" x 18" SURFACE MOUNT W/ DRAIN & CUT OUT FOR 6" FLANGE
AMERICAN COFFEE URN