

**CHANGE DIMENSIONS AS NEEDED FOR CUSTOM T-TOWERS**

REV. NO.		REVISIONS	DATE	APPROVED

**Precision Sheet Metal**  
 Design ♦ Engineering ♦ Fabrication  
 www.acumetalfab.com

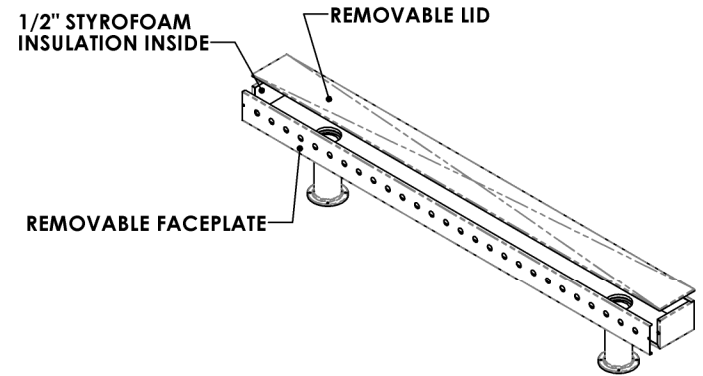
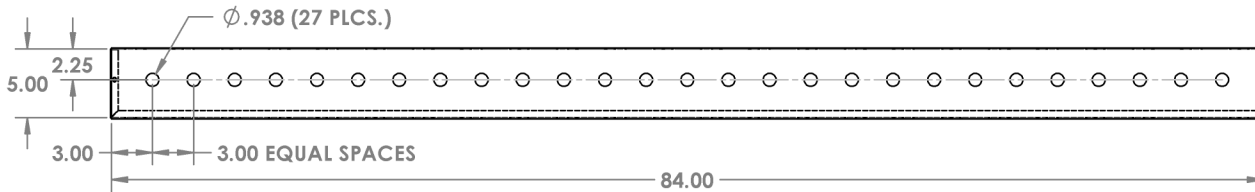
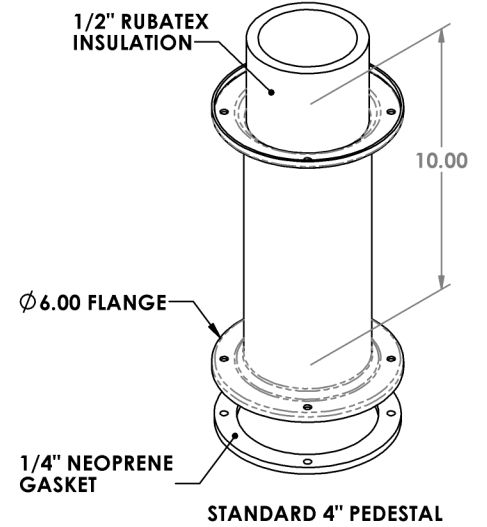
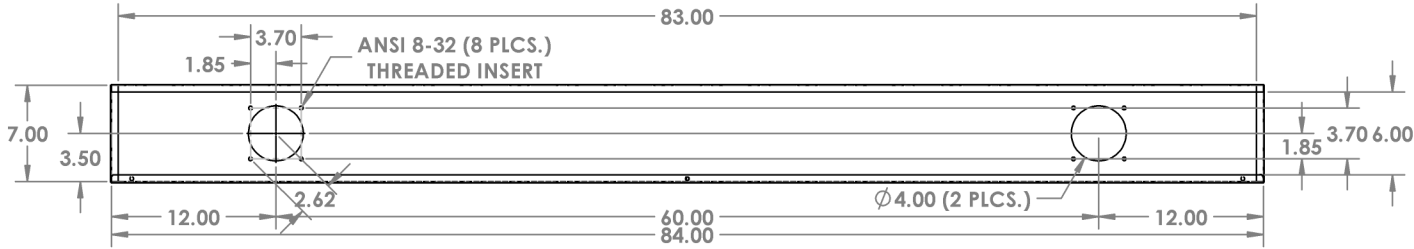

**NOTES:**

**ALL DIMENSIONS ARE INSIDE DIMENSIONS (UNLESS OTHERWISE NOTED)**

**\*FAUCET HARDWARE NOT INCLUDED**

**PROPRIETARY AND CONFIDENTIAL**

THE INFORMATION CONTAINED IN THIS DRAWING IS THE SOLE PROPERTY OF ACU PRECISION SHEET METAL. ANY REPRODUCTION IN PART OR AS A WHOLE WITHOUT THE WRITTEN PERMISSION OF ACU PRECISION SHEET METAL IS PROHIBITED.

ACU PRECISION SHEET METAL IS : AMERICAN COFFEE URN MANUFACTURING CO., INC

	NAME	DATE
<b>DRAWN</b>	L. WILLIAMS	08/16
<b>MATERIAL</b>	18 GA. 304 STAINLESS STEEL	
<b>FINISH</b>	#8 POLISHED	

DO NOT SCALE DRAWING

**TITLE:**  
**4" T-TOWER**  
**84" T-TOWER BOX\***  
**W/ 27 HOLE FACEPLATE**  
**DOUBLE PEDESTAL**  
**AMERICAN COFFEE URN**

**PART # 1022-84-27Hole-SS8**