

CHANGE DIMENSIONS AS NEEDED FOR CUSTOM T-TOWERS

REV. NO.		REVISIONS	DATE	APPROVED
ZONE	REV.	DESCRIPTION		

Precision Sheet Metal
 Design ♦ Engineering ♦ Fabrication
 www.acumetalfab.com

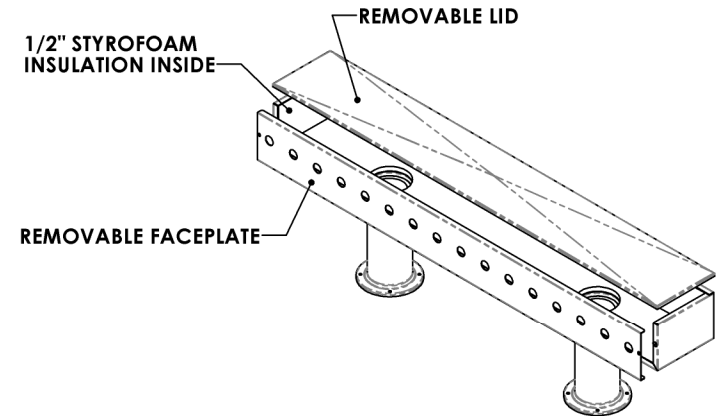
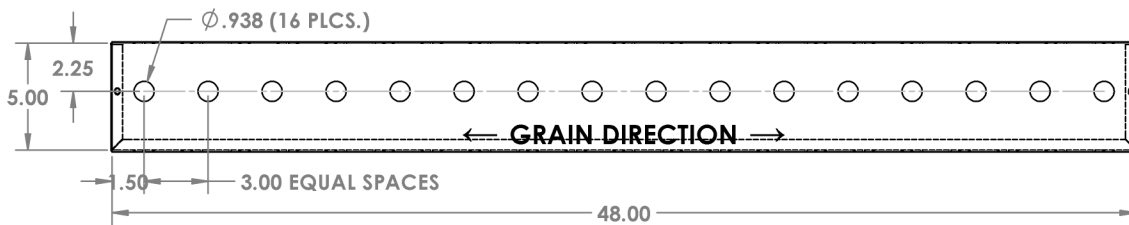
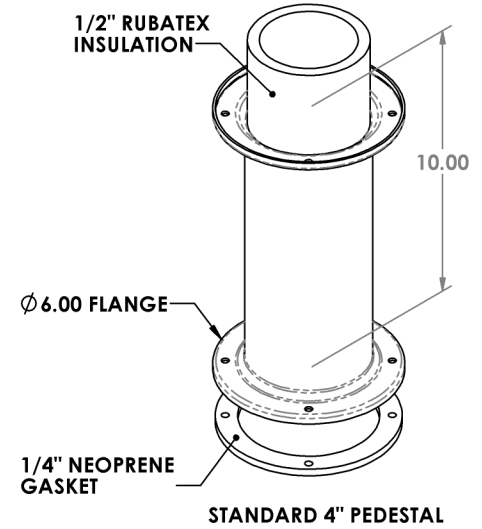
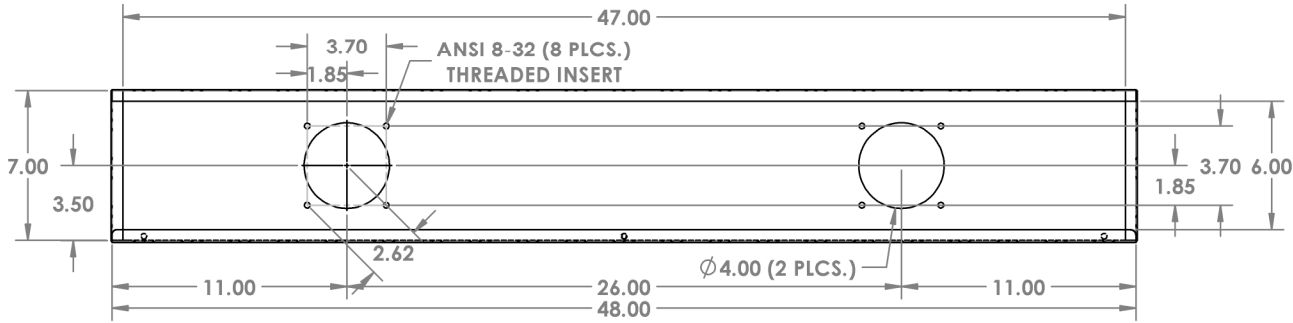

NOTES:

ALL DIMENSIONS ARE INSIDE DIMENSIONS (UNLESS OTHERWISE NOTED)

***FAUCET HARDWARE NOT INCLUDED**

PROPRIETARY AND CONFIDENTIAL
 THE INFORMATION CONTAINED IN THIS DRAWING IS THE SOLE PROPERTY OF ACU PRECISION SHEET METAL. ANY REPRODUCTION IN PART OR AS A WHOLE WITHOUT THE WRITTEN PERMISSION OF ACU PRECISION SHEET METAL IS PROHIBITED.
 ACU PRECISION SHEET METAL IS :
 AMERICAN COFFEE URN MANUFACTURING CO., INC

	NAME	DATE
DRAWN	L. WILLIAMS	08/16
MATERIAL	18 GA. 304 STAINLESS STEEL	
FINISH	#4 BRUSHED	

TITLE:
4" T-TOWER 48" T-TOWER BOX* W/ 16 HOLE FACEPLATE DOUBLE PEDESTAL AMERICAN COFFEE URN