

**CHANGE DIMENSIONS AS NEEDED FOR CUSTOM T-TOWERS**

REV. NO.		REVISIONS	DATE	APPROVED
ZONE	REV.	DESCRIPTION		

**Precision Sheet Metal**  
 Design ♦ Engineering ♦ Fabrication  
 www.acumetalfab.com

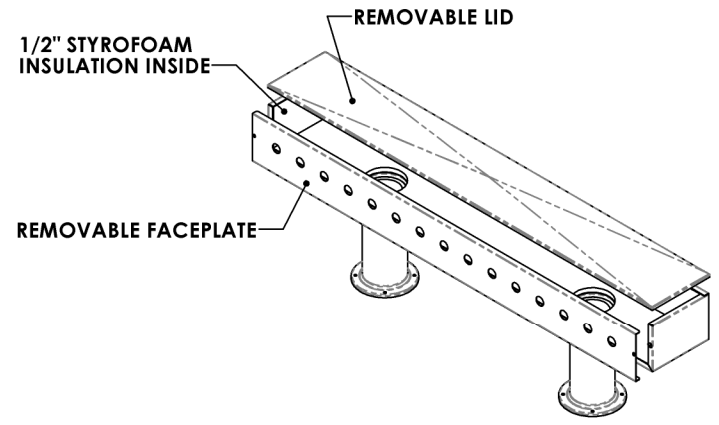
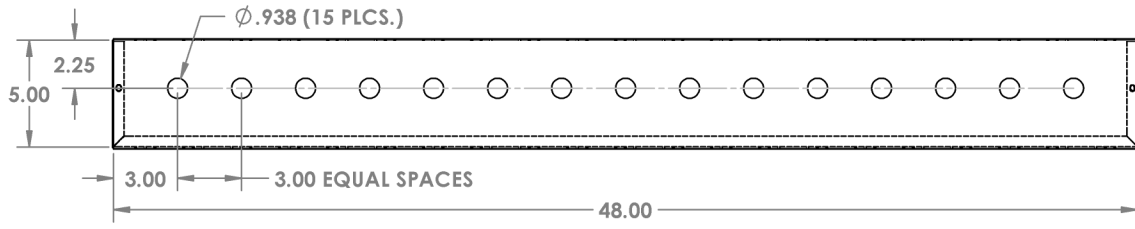
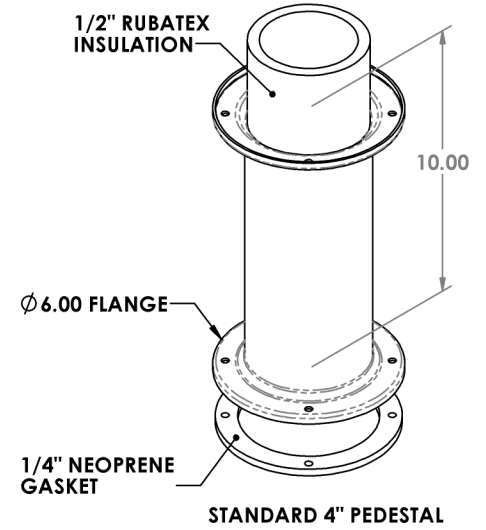
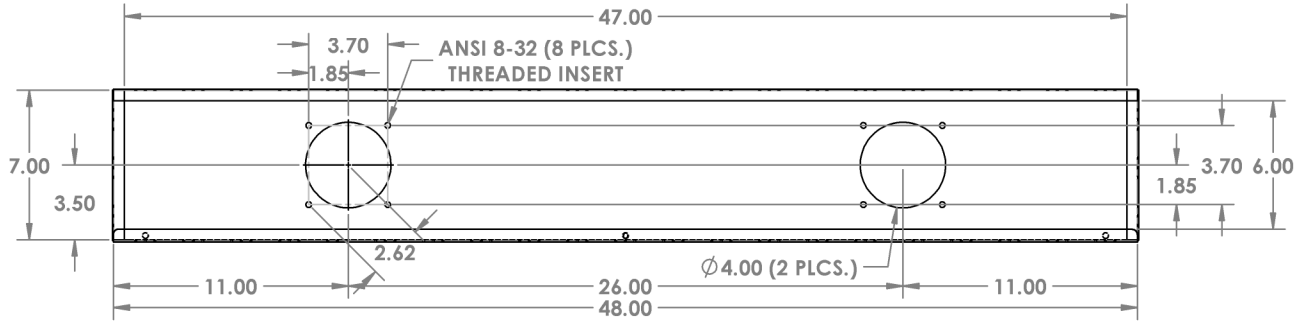

**NOTES:**

**ALL DIMENSIONS ARE INSIDE DIMENSIONS (UNLESS OTHERWISE NOTED)**

**\*FAUCET HARDWARE NOT INCLUDED**

**PART # 1013-48-15Hole-B**

PROPRIETARY AND CONFIDENTIAL  
 THE INFORMATION CONTAINED IN THIS DRAWING IS THE SOLE PROPERTY OF ACU PRECISION SHEET METAL. ANY REPRODUCTION IN PART OR AS A WHOLE WITHOUT THE WRITTEN PERMISSION OF ACU PRECISION SHEET METAL IS PROHIBITED.  
 ACU PRECISION SHEET METAL IS :  
 AMERICAN COFFEE URN MANUFACTURING CO., INC

	NAME	DATE
DRAWN	L. WILLIAMS	08/16
MATERIAL	16 GA. BRASS	
FINISH	#8 POLISHED	

TITLE:
<b>4" T-TOWER 48" T-TOWER BOX* W/ 15 HOLE FACEPLATE DOUBLE PEDESTAL AMERICAN COFFEE URN</b>